

Integrated Community Food Production

A Compendium of Climate-resilient Agriculture Options

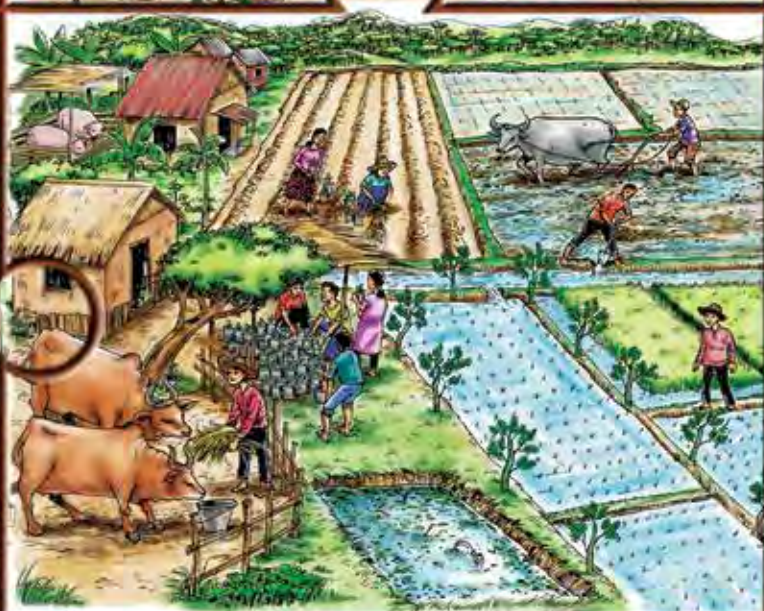
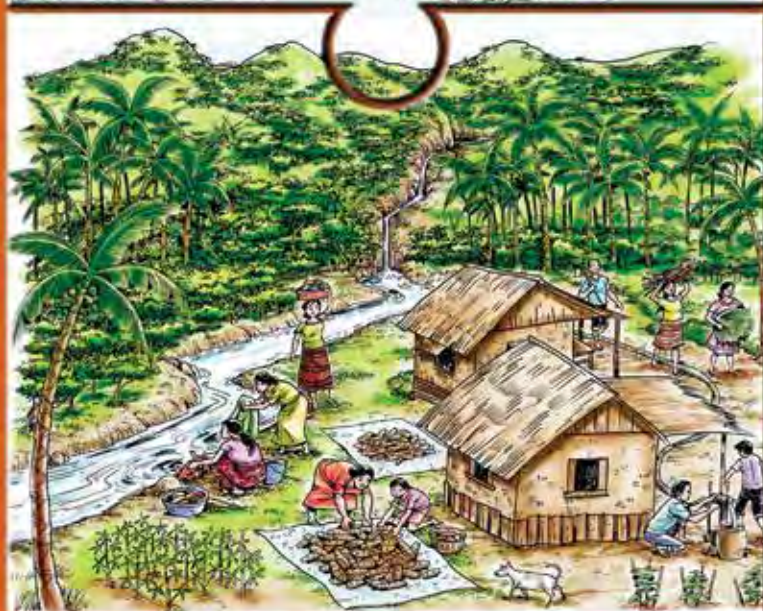
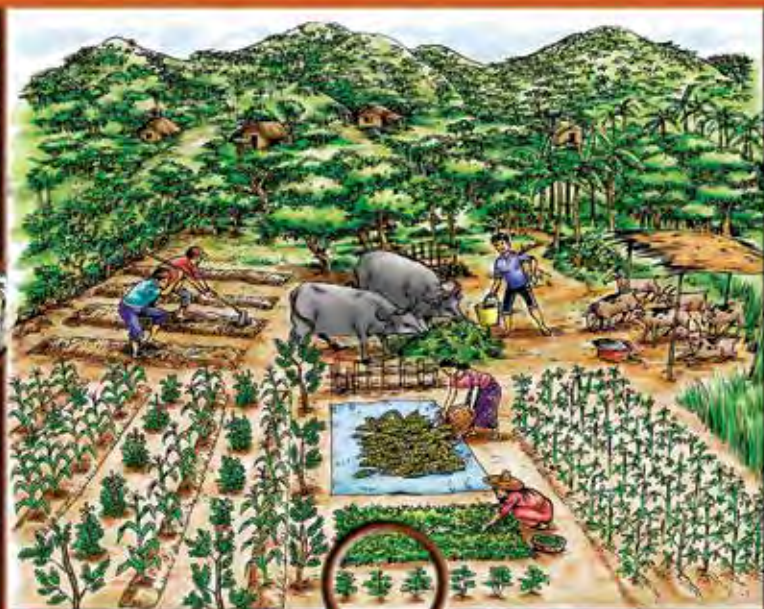
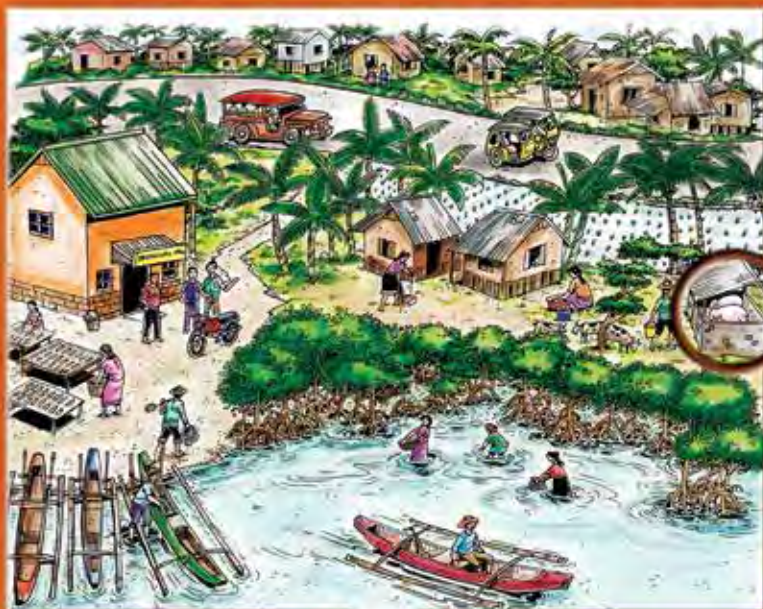

Integrated Community Food Production

A Compendium of Climate-resilient Agriculture Options



INTERNATIONAL INSTITUTE OF RURAL RECONSTRUCTION

Published in the Philippines in 2016 by the National Anti-Poverty Commission (NAPC)
and the International Institute of Rural Reconstruction (IIRR)

ISBN 1-930261-42-X

This publication has no copyright. NAPC and IIRR encourage use, translation, adaptation and copying of materials.
However, acknowledgements and citation will be highly appreciated.

Correct citation: 2016. IIRR and NAPC. Integrated Community Food Production. A Compendium of Climate-resilient Agriculture Options

For further information, please contact:

National Anti-Poverty Commission (NAPC)

Office of the President of the Philippines

LWUA Water Supply Training Center, LWUA-MWSS Complex

Katipunan Avenue, Quezon City 1101

info@napc.gov.ph

www.napc.gov.ph

International Institute of Rural Reconstruction (IIRR)

Km. 39 Aguinaldo Highway

IIRR Y. C. James Yen Center, Biga 2,

Silang, Cavite 4118 Philippines

philippines@iirr.org

www.iirr.org

Message

My warmest greetings!

If we go hungry, we have to plant. When we plant, we'll have something to harvest afterwards, barring the harmful effects of climate change on agriculture, of course.

This is the reason why the National Anti-Poverty Commission pushed for the inclusion of the Integrated Community Food Production in the roster of projects it oversees. ICFP, also referred to as “Pagkain ni Boss” is a strategy in addressing hunger that directly involves communities in sustainable farming practices. It has become a staple menu under the Bottom-up Budgeting for 2015, 2016 and 2017 of the Aquino Administration. A total 309 cities and municipalities decided to implement ICFP this 2016.

My reckoning is that if more than 500 LGUs would be implementing a targeted ICFP in the country, hunger will be greatly lessened, alongside malnutrition that goes hand in hand with it. The Local Affairs Coordinating and Monitoring Service (LACMS), the unit that manages and ensures that the implementation of ICFP at the local level is in conjunction with approved guidelines, has been witness to the many triumphs of many LGUs in ICFP implementation, including San Felipe, Zambales, under the leadership of Mayor Carolyn Fariñas; and Peñaranda, Nueva Ecija, under the leadership of Mayor Ferdinand Abesamis, among others.

NAPC is very happy to come out with a resource book about the Integrated Community Food Production. This resource book will provide the LGUs with practical tips on how to do backyard gardening using organic fertilizer and how to propagate seeds and seedlings that are of the openly pollinated variety in community gardens. The municipal and city agriculturists and other personnel at the LGU level will be able to use the resource book to train the members of the ICFP teams, including household participants, about ICFP technologies. This document will likewise be useful to other institutions for it incorporates strategies in addressing hunger that brings down anti-hunger and anti-poverty tools directly to farmer-households.

NAPC is truly grateful to the International Institute of Rural Reconstruction (IIRR) for writing and putting together the contents of this resource book, taking into account NAPC's current experiences. With this resource book comes the challenge to everyone to ensure the continued expansion of ICFP as a program geared toward combating hunger and malnutrition. We, in the government and the civil society should continue firming up techniques and technologies that incorporate meaningful community participation and available community resources to finally end hunger in the Philippines.

Thank you very much.



JOSE ELISEO M. ROCAMORA

Secretary



Message



Approaches to addressing poverty in the Philippines are multi-faceted and multi-dimensional. Since hunger is often associated with poverty, food security remains a major dimension of poverty alleviation strategies in the country. Access to sufficient, safe and nutritious food by poor and hungry families is an imperative to attain food security. Any action by the Philippine government to eradicate poverty must ensure that there is enough food for everyone since public and private investments toward socio-economic development will only be rendered useless: a weak, frail and sickly population equates to reduced economic productivity and social interaction.

Ensuring food security, however, doesn't mean periodic food distribution to the poor and the hungry. Current experience of the National Anti-Poverty Commission shows that an anti-hunger program that is fundamentally geared toward providing and creating opportunities among the poor to grow and harvest their own food, even within a limited space, results to an increased access to food, reduction of malnutrition among children, and gaining additional income by participating families. When there is enough food for family members, household expenditures for food, particularly for vegetables and protein, substantially decline.

In a span of two years (2015-2016) and from a few participating pilot sites in disaster-prone areas in the Philippines, the number of participating communities and local government units has greatly increased. This 2016 alone, 309 municipalities and cities all over the country have taken part in this program, which NAPC now officially calls as the Integrated Community Food Production (ICFP) Program. Now on its second year of implementation under the Bottom-up Budgeting Program (BuB) menu, ICFP is poised to gain more traction as a staple LGU program to mitigate hunger among poor families in the Philippines. With this, we are looking forward to having more households and LGUs to join us in this endeavor.

Having a resource book on the basic techniques and approaches to implementing ICFP at the household level ensures that the LGUs that will implement it in the future are armed with the correct and appropriate tools and information about backyard gardening, organic seed and seedlings propagation, livestock raising and even organic fertilizer production. This joint endeavor by the NAPC and the International Institute of Rural Reconstruction (IIRR) to come up with this document is indicative of the growing coordination and collaboration between and among national government agencies, the civil society and other international organizations to facilitate the movement against hunger in the Philippines.

My warmest felicitations to everyone who made the development and production of this resource book a reality. Let us continue the quest to realize food security among poor households in the country.

Thank you very much and mabuhay!

FLORENCIA CASANOVA DOROTAN

Undersecretary and Deputy Director General

Message



Greetings of peace!

The National Anti-Poverty Commission (NAPC) is pleased to present this compendium of the different techniques and technologies used in the Integrated Community Food Production (ICFP). NAPC's Local Affairs Coordinating and Monitoring Services (LACMS) has been tasked to manage and oversee the national implementation of this program. This 2016, 309 cities and municipalities are implementing ICFP as part of their fund allocation in the Bottom-up Budgeting (BuB). This is a 336% increase in the total number of municipalities that enrolled ICFP in the 2015 Local Poverty Reduction Action Plans.

Many anti-hunger approaches, strategies and interventions have already been implemented by both government and non-government organizations in the past either as a direct or a supplemental response to mitigate hunger. What is interesting about the ICFP as a strategy in addressing hunger approach is that it attempts to target food poverty at the household level where it matters. In fact, ICFP is an approach that ultimately empowers the food poor because through the backyard farm produce, they take a decisive role in producing a portion of their food requirements; through this, they may even earn from the excess of their production.

ICFP responds to peculiar conditions of localities experiencing hunger and malnutrition. For example, backyard gardening could be done using cans and containers in urban and resettlement sites, and a small area of lot in the barangays could be used as community or communal gardens to be used in the propagation of open pollinated variety (OPV) seeds and seedlings. A provision for small household fish ponds can be allowed in bigger communities with water.

This compendium presents tried and tested, and appropriate methods of providing nutritious food on the table of the poor. Understanding these so-called foolproof household farming techniques and approaches, we are in the hope that this resource book on ICFP will teach our local officials, citizen groups and other concerned institutions to combat hunger by making the poor active partners. In the process, we in NAPC value this as our significant contribution in the roster of interventions of the Philippine government to live up to its rights-bearer role in the Filipinos' quest for food security.

We thank the International Institute of Rural Reconstruction (IIRR) for putting together these techniques and technologies. Our warmest gratitude also goes to all our partners who have made the piloting of ICFP possible up to its successful inclusion in the Bottom-Up Budgeting program menu of the government and eventual implementation in many municipalities nationwide.

Kayang kaya nating tugunan ang kagutuman sa pamamagitan ng pagtatanim at paglikha ng sarili nating pagkain.

A handwritten signature in black ink, appearing to read "Jesusa I. Rebete".

JESUSA I. REBETE

Director III, LACMS

Local Affairs Coordinating and Monitoring Service

Jesusa I. Rebete

Director III

Monitoring Division

Perigine M. Cayadong, *Division Chief*
Dulcie Rivera, *BuB/GRM Focal Person*
Marlon Fulo, *Data Management Officer*
Maureen B. Balaba, *CLMP Program Officer*
Christine Sacote, *Finance Staff*
Blanca Bancosta, *Administrative Staff*

Local Convergence Division

Alfredo M. Antonio, *Division Chief*
Jocelyn M. Apag, *ICFP Program Officer*
Renato Nicanor, *PDTF Focal Staff*
Annabelle Batingan, *Finance Staff*
Romnier San Jose, *Administrative Staff*
Jose O. Lastimoso, *Secretariat Support Assistant*

Luzon Island Team

Amillany Miranda, *CAR*
Bernardita Dabasel, *NCR*
Ericson Nilo, *Region 1*
Ma. Monina Hazel B. Garcia, *Region 2*
Anselmo M. Garcia, *Region 3, Team Leader*
Catherina B. Saguirre, *Region 4-A*
Elizabeth Tolentino, *Luzon Technical Assistant*

Visayas-Luzon (Vizon) Island Team

Mary Catherine Garcia, *Region 4-B*
Soraya Deri, *Region 5*
Ricafin San Esteban, *Region 6*
Bryan Villasana, *Region 7*
Lani Arda, *Region 8, Team Leader*

Mindanao Island Team

Ferdinand Ranada, *Region 9*
John Rey R. Roque, *Region 10*
Rheelen Soco, *Region 11*
Cathy C. Ocampo, *Region 12*
Rechie Tugawin, *Region 13*
Noemi Y. Pimentel, *ARMM, Team Leader*
Venus T. Oyao, *Mindanao Technical Assistant*



Editorial Board

Editor-in-Chief

Jesusa I. Rebeta

Concept and Technical Coordination

Dr. Julian Gonsalves

Members

Dr. Julian Gonsalves
Emilita Monville-Oro
Alfredo M. Antonio
Perigine M. Cayadong
Jocelyn M. Apag
Ma. Monina Hazel B. Garcia
John Rey R. Roque
Rheelen S. Soco
Rechie J. Tugawin
Bryan Edward G. Villasana
Jonna Ellaine A. Jordan
Irish B. Baguilat
Rene R. Vidallo

Design & Layout

Ronald Salvador
Orange & Yellow Design & Print Shop
Ariel Lucerna (cover artwork)

Acknowledgments

We would like to express our deepest appreciation and recognition for the participation and assistance of various people for the completion of this Integrated Community Food Production (ICFP) resource material. Their contributions are gratefully acknowledged. Sincere gratitude is hereby extended to the following who never ceased in helping until this resource material is completed.

To the International Institute of Rural Reconstruction (IIRR) team led by Ms. Emilita Monville-Oro, IIRR country director, and Dr. Julian Gonsalves, IIRR senior advisor for Asia. We are extremely thankful and indebted for their proficiency and valuable contributions for the completion and attainment of this material.

To the ICFP consultants namely, Dr. Ponciano A. Batugal of the Farmers Community Development Foundation (FCDF), Dr. Jose Pepito Cunanan of the *Bahay Kubo* Global Systems, Inc., Ms. Carmen B. Cabling of the Quezon Participatory Guarantee System, Mr. Xyrus Godfrey Capiña also of FCDF, and Mr. Perfecto Rom, Jr. of the Urban Container Gardening Agricultural Consultancy Services, who generously shared their technical expertise and knowledge. The skills that they imparted became the building blocks of the ICFP program implementation.

To all participating local government units, especially the City/Municipal Agriculture Officers as well as the civil society organization partners for the active participation and meaningful collaboration.

To all Local Affairs Coordinating and Monitoring Service island teams led by Mr. Anselmo Garcia, Ms. Lani Arda, and Ms. Noemi Pimentel for taking the lead to efficiently monitor and implement the ICFP Program.

And to anyone who in one way or another has contributed in making this compendium of ICFP technologies possible, thank you!

Preface

Known to be an agricultural country, the Philippines accounts significant contribution of agriculture to its gross domestic product. This is particularly exemplified through the utilization of nearly half of its 30 million hectares land area in agricultural activities. These rich land resources and agricultural niche provide food production opportunities for the rural poor, and ensure food security of the country. For example, data from Department of Agriculture show that the Philippines has reached 100% and 96% self-sufficiency in corn and rice production in 2014, respectively.

Despite such opportunity, poverty and food subsistence incidence remains to be a challenge. According to the Philippine Statistics Authority, the per capita poverty incidence was recorded at 26.3% in the first semester of 2015. A more telling part of this data shows that 12.1% of Filipinos earned below the food threshold in the same period. As the Philippines is projected to have more than 100 million population in 2015, the statistics implies that over 12.1 million Filipinos are food poor and living at subsistence level. Furthermore, food producers such as farmers and fisherfolks are among the poorest sectors with 2012 poverty incidence of 38.3% and 39.2%, respectively.

It is in this ironic situation that targeted strategies to address hunger are highly warranted. Initial programs had been focused on increasing farm productivity. However, ensuring industrial agricultural production by making more food using same input is rather vain to address hunger. As the United Nations Conference on Trade and Food (UNCTAD) report put it, “hunger and malnutrition are related to lack of purchasing power and/or inability of rural poor to be self-sufficient.” As a result, the body endorses the shift to small scale organic farming as a counter strategy.

Household organic farming such as *bahay kubo* style of food production, merged with small livestock including chicken and goat (as sources of protein) as well as root crops (as alternative sources of carbohydrates) enables availability of nutritious food on every table. The Integrated Community Food Production (ICFP) Program subscribes to this framework. The National Anti-Poverty Commission (NAPC) believes that the paradigm shift to small scale organic farming is the best strategy to address hunger among poor Filipinos.

The fruitful implementation of the ICFP depends greatly on the appreciation of the local government units (LGUs) and civil society organizations (CSOs) who work directly with the communities. Through this ICFP resource book, the NAPC intends to raise the interest and capacity of these key partners in the ICFP implementation.

Written by the International Institute of Rural Reconstruction (IIRR), this resource book presents a compendium of pertinent topics on establishing ICFP as a program to address hunger at the household level. Topics in this book include overview on ICFP and food security, intensive organic gardening, family farming, and small livestock and fish production. Having a proven track record on farming technologies and rural reconstruction for over nine decades, the IIRR helped consolidate ICFP practices and necessary technologies into a succinct but substantial resource material for LGUs and CSOs. Readers are encouraged to utilize this compendium for personal appreciation of ICFP, and more importantly as a reference material for capacity building activities and project implementation.

Finally, we hope that this compendium of ICFP resources will raise not only the capacity, but also the commitment of our partners in empowering the people to have freedom from hunger and extreme poverty. We intend that this material enable communities and families to adopt small scale organic farming, and make food readily available on the tables of those who need it the most.

Contents

Messages	v	Crop Planning	47
Local Affairs and Coordinating Council	viii	Shade Tolerant Vegetables	49
Editorial Board	ix	Drought-resistant Vegetables	50
Acknowledgments	x	Common Garden Tool	51
Preface	xi	Nursery Techniques for Seedlings	52
		Nutrient Composition of Various Organic Materials	56
		Organic Fertilizer Sources: Basket Composting	58
		Pot Garden Technologies	61
		Seed Harvesting and Seed Extraction	62
		Seed Production	64
		Seed Drying	65
		Seed Storage	67
		Testing Seed Quality	69
		Saving Seeds through Gardener Curators	72
		Some Common Garden Pests	76
		Mulching	81
		Fish Emulsion as Plant Food for Bio-intensive Garden	83
		Gardening in Dry Environments	84
		Growing Vegetables in Saline Areas	85
		Water Saving Ideas for Gardens During Dry Season	87
		Why Producing Your Own Vegetable Seeds is Important	88
		Vitamin A Content of Some Local Foods in Serving Portions Compared with Recommended Dietary Allowances in Various Age Groups	89
		Vegetables that can be Harvested in Less than a Month	90
OVERVIEW			
<hr/>			
ICFP Program: Addressing Hunger in Philippines through Organic Household Farming	3		
ICFP Guidelines	4		
INTENSIVE ORGANIC GARDENING			
<hr/>			
Definitions of Homegarden	27		
Why Household Food Security through Gardens Makes Sense?	29		
Characteristics of the Bio-intensive Approach to Small-scale Household Food Production	30		
Bio-intensive Garden	35		
Integrated Alley Cropping – Bio-intensive Gardening	40		
Raised-bed Garden Technologies	42		
Using The Fenceline for Planting Annual and Perennial Crops	43		
Companion Plant Guide Chart	45		

Contents

Alternative Pest Management	91	Small Water Impounding Technologies	143
Encouraging Predators	93	Small Ponds for Water Conservation	148
Lead in Urban Gardens	95	Use of Scarce Water Resources in Drylands through Pitcher Irrigation	150
FAMILY FARMING		The Role of Organic Mulches	153
<hr/>		Traditional or Indigenous Seeds	155
The Household as a Production and Consumption Unit	99	Tree Pruning and Care	156
Some Characteristics of a Regenerative Agriculture System	100	Optimum Use of Marginal Land with Agroforestry System	160
Farm Management Practices that Reinforce Soil and Water Conservation	103	Upland Rice Cultivation with Agroforestry (AGF) Integrated Nutrient Management on Rice-based System	163 166
Increasing Organic Matter in the Soil	105	Green Leaf Manuring in Lowland Rice	172
Family Food and Income from Root Crops	107	Pot/Bottle Gourd Irrigation for Fruit Tree Saplings	174
Integrated Nutrient Cycling in Lowland Rice Production: An Ecosystem Approach	109	The System of Rice Intensification (SRI): A Climate-smart Rice Production System of Rice Intensification (SRI) Method of Rice Cultivation	175 177
Organic Fertilizer Source: Fertilizer From Livestock and Farm Wastes	112	Circle Nurseries	179
Composting Methods	114	Improving Vegetative Cover on Dryland Farms	180
Organic Fertilizer Source: Liquid Fertilizer from Leguminous Trees	121	Protective Measures for Non-arable Lands Legume Crop Rotation with Rice	184 186
Organic Fertilizer Sources: Use of Green Manures	122	Liquid Fertilizer	188
Kakawate (Madre De Cacao): A Multipurpose Crop	125	Vegetable with Multiple Edible Parts	189
Outplanting Seedlings	128	Vegetable Containing Iodine	191
Selection of Cover Crops	131	Iron Content of Some Local Foods in Serving Portions Compared with Recommended Dietary Allowances (RDA) for Various Age Groups	193
Site Selection and Timing of Seed Production	134		
Water Harvesting: Improved	139		

Contents

Planning for Aberrant Weather	194	Backyard Integrated Pig-fish Culture	258
Layout for an Intensively Cultivated Woodlot for Fuelwood or Poles and Stakes	199	in the Philippines	
Biological Pest Control	200	Plant-based Animal Health Care	261
Botanical Pest Control	202	Plant-based Medicine for Livestock (Water Buffalo/Carabao)	265
SMALL LIVESTOCK AND FISH PRODUCTION		Plant-based Livestock Medication	269
<hr/>			
Backyard Piggery Project	209	Vegetable-duck-fish Culture	273
Native Pig Production	211	Family Backyard Poultry Project	275
Housing and Feeding for Pigs	214	Improving the Native Chicken	278
Housing	219	ANNEXES (NAPC)	280
Breeding and Care of New Born Pigs	225		
Pig Feed Garden	230		
Low-cost Hog Feed	234		
Low-cost Hog Feeds Additional Options	235		
Low-cost Goat Housing	237		
Intensive Feed Garden	239		
On Farm Fodder Sources in Agroforestry (Trees and Grasses)	242		
The Large Leafed Mulberry: A Promising Nutritive Fodder for Scarcity Period	244		
Backyard Poultry Project Using Compost Litter System	245		
How to Raise Ducks	247		
Backyard Duck Raising for Meat and Eggs	249		
Care and Management of Mini-ponds	252		
Mini Pond for Water Limited Areas	255		

Overview

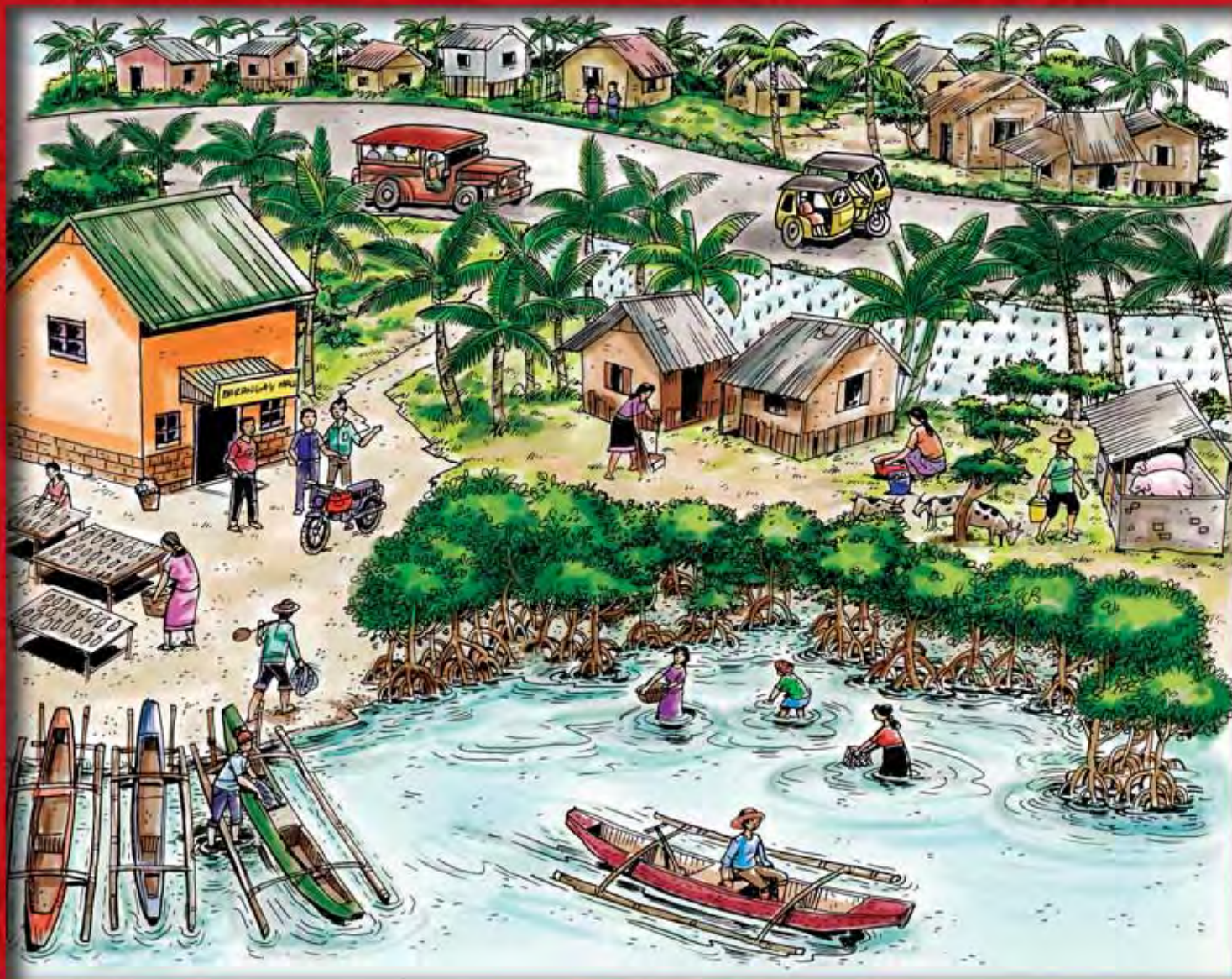

Integrated Community Food Production

A Compendium of Climate-resilient Agriculture Options

Integrated Community Food Production Program: Addressing Hunger in Philippines through Organic Household Farming

“Sa Pagkain ni Boss o Integrated Community Food Production (ICFP) Program, hindi na kami gumagastos pambili ng aming pagkain dahil may nakukuha na kami sa gilid ng aming bahay,” shared Maricel Bayloses. “Bumigat na rin ang timbang ng mga anak ko dahil sa itlog na napapakain ko sa kanila galing sa native chicken na inaalaan namin.”

Maricel Bayloses, a household farmer from Negros Oriental, is one of hundreds of family partners of the National Anti-Poverty Commission (NAPC) who benefits from the ICFP Program. A long-term government intervention to address hunger in the country, ICFP Program is our response to the call of the United Nations to return to or develop a more sustainable and natural organic system to feed the world. ICFP Program empowers the people to produce their food requirements around their home through fruit, vegetable and root crop gardening, small poultry and livestock raising, and small fish culture.

ICFP Program originated from the program *Sapat at Masustansyang Pagkain sa Bawat Tahanan*, an earlier joint undertaking between NAPC and the Farmers Community Development Foundation (FCDF) Inc. In 2013, ICFP Program was included in the Bottom-up Budgeting (BuB) menu of anti-poverty programs for Fiscal Year 2015. On its pilot run, 92 Local Government Units (LGUs) implemented the ICFP Program with a budget of more than PhP 163 million. Currently, the number of LGUs proposing and implementing this program continues to grow.

The ICFP Program facilitates the establishment of household and community gardens using organic fertilizer that has been proven by specialists to be more effective than chemical. It also assists family partners in raising poultry and livestock, and in small fish production.

With the availability of food on every table, the ICFP Program in effect addresses the issue of food security by promoting a sustainable food production and consumption system. This program focuses on producing nutritious alternative food sources that can readily be made available to poor families even in times of disasters or natural calamities. Surplus goods or harvest can be sold by the family partners to form part of their additional income.

Family partners of NAPC in this program, whether farmers or not, are trained on natural or organic farming and on poultry and livestock raising. With support from the ICFP Team led by the local chief executive and city/municipal agriculture officer and the co-chairperson of the Local Poverty Reduction Action Team (LPRAT), family partners are fully capacitated on how to implement the program from the process of planning to post-harvest, marketing and in sustaining the program even after its one year implementation.

The ICFP program paves the way for the commencement of community and social enterprises, where family partners are required to adhere to a payback mechanism that teaches them how to think of this program, not only as a dole-out to address their nutritional concerns, but as a tool to replicate and expand the ICFP program to cover more indigent families.

“Simple lang ang konsepto ng programang ICFP, pero ito ay may napakalaking tulong sa amin,” added Bayloses. “Hindi lang na-solve ang aming problema sa pagkagutom, nagkaroon pa kami ng dagdag na kita dahil naibenta namin ang sobrang na-harvest namin.”

Hunger is a major setback in our country. NAPC endeavors to strengthen the capacity of the stakeholders and empower them to ensure that the Program is fully implemented. With the cooperation of LGUs, civil society organizations, family partners and other stakeholders, the ICFP program will change the landscape of people in communities suffering from severe hunger and malnutrition.

“Pagkain ni Boss”

Amended Implementing Rules and Guidelines of the Integrated Community Food Production (ICFP) Program under the Bottom-Up Budgeting (BuB) for Fiscal Year 2016 and Thereafter

General Provision

Pursuant to the general provisions stated in the DBM-DILG-DSWD-NAPC Joint Memorandum Circulars No.5 and No.7 dated October 1, 2014 and November 3, 2015, respectively, on the policy guidelines and procedures in the implementation of the Bottom-up Budgeting (BuB) Program for Fiscal Year 2016 and thereafter, the National Anti-Poverty Commission hereby provides the rules and guidelines in implementing the Integrated Community Food Production (ICFP) Program for BuB 2016 and Beyond.

WHEREAS, the Integrated Community Food Production (ICFP) Program or “Pagkain ni Boss” is listed in the menu of programs under the Bottom-up Budgeting (BuB) process;

WHEREAS, ICFP Program is a hunger mitigation and elimination program of the National Anti-Poverty Commission (NAPC);

WHEREAS, hunger mitigation is among the national budget priority areas along with Basic Education, Public Health, Social Protection and Disaster Risk Reduction and Management, and Job Generation and Livelihood;

WHEREAS, ICFP Program is considered as one of the viable responses of the Philippine Government to the problem of hunger and malnutrition in the country as per food poor data survey of the Philippine Statistics Authority (PSA) in 2014;

WHEREFORE, NAPC as the lead agency for Poverty Reduction takes the stride in implementing the Integrated Community Food Production (ICFP) as a Strategic and Sustainable Hunger Mitigation Program.

PART I Preliminary Provisions

Section 1 Title

- 1.1 This hunger mitigation program under the Bottom-up Budgeting (BuB) process shall be known as the Integrated Community Food Production (ICFP) Program or “Pagkain ni Boss”.

Section 2 Program Outcome Indicators

- 2.1 The program aims to concretize the following indicators:
 - 2.1.1 Mitigated and/or eliminated hunger among the classified poor families in the participating Local Government Units (LGUs); and
 - 2.1.2 Reduced incidence of malnutrition especially among children, women and senior citizens of identified poor families in the participating LGUs.

Section 3 Program Goals

- 3.1 The program aims to achieve the following goals:
 - 3.1.1 To make nutritious food readily available among the participating poor families, even in times of disasters and calamities; and
 - 3.1.2 To provide the participating poor families with the opportunity to increase their income through engaging in social enterprise on seed production and marketing of surplus vegetables, poultry, livestock and fish.

Section 4 Program Description

- 4.1 The ICFP Program focuses primarily on establishment of household or backyard and community gardens, fruit trees and other home-based food production units.
- 4.2 It shall be composed of a combination of at least three (3) but not limited to the following food sources: vegetables, cereals, root crops, poultry and livestock, fruit trees, and fish, among others to provide complete food for the participating poor families.

- 4.3 Vegetables and other alternative sources of carbohydrates or any rice substitutes must be an integral part of each project with options to have native chicken, ducks, and other livestock such as goats.
- 4.4 Production of household or community level organic fertilizer (e.g. Vermicast composting, etc.) is a must.
- 4.5 It shall promote organic food-growing and gardening, using indigenous species.
- 4.6 Establishment of community gardens and seed banks in every community or barangay is also required.
- 4.7 A Payback Mechanism through a minimum of one is to one (1:1) recovery scheme of availed seeds, seedlings and livestock shall be established as a sustainability and multiplier mechanism.
 - 4.7.1 ICFP Team must agree on the payback mechanism as part of the sustainability and multiplier component of this program.
- 4.8 LGUs with ICFP requested budget of more than PhP5Million may opt for a communal dairy goat or cattle dairy production for household-level consumption.
 - 4.8.1 This intends to provide milk as an additional support for dietary or nutritional needs of the participating poor families, and complement other food production activities.
 - 4.8.2 Dairy production shall be tied up with local dairy cooperatives and other producers. LGUs that will opt for a dairy production should be in the list of LGUs with strong dairy cooperatives. [Refer to Annex A for the list of LGUs with operational dairy cooperatives.]
 - 4.8.3 LGUs that will opt for this food supplementary idea shall work closely with the National Dairy Authority (NDA) for technical and other forms of assistance.

Section 5 Scope

- 5.1 The ICFP shall be implemented in all cities and municipalities with proposed Integrated Community Food Production (ICFP) Program that is included in their Local Poverty Reduction Action Plans (LPRAPs) as part of the BuB process.

PART II Program Components

Section 6 Provision of Technical Assistance

- 6.1 The National Anti-Poverty Commission (NAPC) shall provide technical assistance such as coaching and mentoring to participating LGUs specifically to the ICFP Teams and identified household beneficiaries on the aspect of proposal making, implementation, and monitoring and evaluation.
- 6.2 Technical Assistance shall be done by the NAPC Technical Consultants, Service Providers, Regional and Provincial Focal Persons, and/or other members of Local Affairs Coordinating and Monitoring Service (LACMS) Unit.

Section 7 Orientation and Capacity Building

- 7.1 NAPC shall conduct the orientation and capacity building or training of trainers for the key persons of the ICFP Team, including but not limited to the Mayor, City/Municipal Agriculture Officer, CSO LPRAT Co-Chair, Technical Assistant to the C/MAO, and City/Municipal Nutrition Action Officer (C/MNAO).
- 7.2 NAPC Consultants, Service Providers, Regional and Provincial Focal Persons, and other members of the LACMS Unit shall serve as the primary resource speakers to the local level Project Management and Planning Workshops, and training of ICFP Team members.
- 7.3 NAPC Consultants, Service Providers, Regional and Provincial Focal Persons, and other members of the LACMS Unit may be tapped as resource speakers to the LGU-level orientation and capacity building for local government officials, other ICFP Team members, household beneficiaries and other concerned stakeholders.

Section 8 Implementation Mechanism

- 8.1 Pre-Implementation Phase
 - 8.1.1 The Local Chief Executive (LCE) or Mayor, in coordination with the City/Municipal Agriculture Officer (C/MAO), shall spearhead the organizing of the ICFP Team in their city or municipality, through the creation of an Executive Order. [Refer to Annex B for the Executive Order Template]
 - 8.1.1.1 The names of all the members of the ICFP Team shall be included in the project proposal, subject to the approval of NAPC.
 - 8.1.1.2 The ICFP Team shall supervise the implementation, and monitoring and evaluation of the ICFP Program at the LGU-level.

- 8.1.2 The identification of beneficiaries shall be done by the ICFP Team, in accordance with their submitted LPRAPs.
- 8.1.2.1 If beneficiaries were not classified in the approved LPRAPs, priority should be given to those barangays with high incidence of poverty and/or malnutrition using relevant government data on poverty and health.
- 8.1.2.2 Reference for the identification of household beneficiaries may include but not limited to the following: National Household Targeting System for Poverty Reduction (NHTS-PR), Community-Based Monitoring System (CBMS), Operation Timbang (OPT), Field Health Service Information System (FHSIS) of the Department of Health, among others.
- 8.1.3 The LGU and the ICFP Team shall ensure that there are available land and water sources for the household and community gardening, food production, livestock production and organic fertilizer production.
- 8.1.4 Participating LGUs must submit their Project Proposal, subject to the approval of NAPC. [Refer to Annex C for the Project Proposal Template]
- 8.1.4.1 The submitted project proposal must conform to the standard template of NAPC and should be in compliance with this Implementing Rules and Guidelines.
- 8.1.4.2 It must be printed in four (4) copies and signed by the specified signatories in every page. It will be distributed as follows: 2 original copies for LGU, 1 original copy for the Local Poverty Reduction Action Team (LPRAT), and 1 original copy for NAPC.
- 8.1.4.3 The approved project proposal must include the following attachments:
- Work and Financial Plan (WFP) [Refer to Annex D for the WFP Template]
 - Executive Order creating the ICFP Team
 - Certificate of Land and Water Availability [Refer to Annex E for the Certificate Template]
- 8.1.5 Changes in the project proposal must undergo again the similar process of review and validation, subject to approval of NAPC.
- 8.1.5.1 Changes in the project proposal shall not be inconsistent with the approved LPRAP of the LGU.
- 8.1.5.2 Changes shall be agreed upon by the entire ICFP Team.
- 8.1.6 ICFP Team Orientation and Planning Workshop shall be done at the LGU level to layout the specific plan of actions on how the home, community gardens and food production shall be implemented. [Refer to Annex F for the Project Implementation Plan Template]
- 8.1.6.1 The ICFP Implementation Plan that will run for two (2) years shall include specific guidelines on sustainability, marketing, replication and expansion.

8.1.6.2 The ICFP Implementation Plan must be applicable to all household beneficiaries.

8.1.7 The ICFP Team shall conduct the Food and Nutrition Survey (Baseline Survey) to household beneficiaries using the NAPC Prescribed Tool. [Refer to Annex G for the Baseline Survey Tool]

8.1.7.1 The survey shall be used as the primary basis in qualifying the effect of the ICFP Program to household beneficiaries. It may be used as reference for other hunger mitigation and/or poverty reduction programs.

8.1.7.2 The survey shall be spearheaded by the City/Municipal Nutrition Action Officer (C/MNAO) of the LGU. They may seek the assistance of hired enumerators provided that it is included in their project proposal.

8.1.7.3 Summary of the Baseline Survey must be included as an attachment to the Midterm Report of the LGU.

8.2 Project Implementation Phase

8.2.1 The ICFP Team, in coordination with the NAPC Provincial Focal Person, shall conduct Orientation and Capacity Building for ICFP Team members, Household Beneficiaries and other concerned individuals on the following topics:

8.2.1.1 ICFP Program /Gardening &Fruit trees Production

8.2.1.2 Vermi-composting / Organic Fertilizer Production

8.2.1.3 Seeds Collection and Plant Propagation Techniques

8.2.1.4 Poultry and Livestock Production and Maintenance

8.2.1.5 Exposure and Cross-Site Visit to successful local food production sites

8.2.2 Household and Community Gardening and/or Food Production Planning of Household Beneficiaries shall be convened and facilitated by the ICFP Team and shall be the basis for home and community garden implementation.

8.2.3 Seeds, seedlings, production inputs, garden tools, and other actual implements including but not limited to organic fertilizer, poultry and/or livestock shall be procured by the LGU and shall immediately be distributed to household beneficiaries.

8.2.3.1 Prior to procurement, Civil Society Organization (CSO) Representatives in the ICFP Team shall sit as observers in the Bids and Awards Committee (BAC) of the LGU on ICFP-related bidding activities.

- 8.2.3.2 CSO Representatives sitting as observers in the BAC may send observation reports to NAPC Provincial Focal Persons and/or any member of the NAPCLACMS Unit, who will serve as a Quick Response Team on any issues that may arise in this program.
- 8.2.4 Office equipment such as Camera, Laptop computer, Pocket Wifi or Internet Connection and/or LCD projector may also be procured by the LGU using the agency requested budget subject to government rules on procurement.
- 8.2.5 The purchase of the above-mentioned equipment shall also be subject to the following guidelines:
 - 8.2.5.1 Camera may only be purchased if the agency requested budget is PhP1Million, and the price allotted for the camera shall not be more than PhP5,000.
 - 8.2.5.2 Laptop may only be purchased if the agency requested budget is PhP1Million, and the price allotted for the laptop shall not be more than PhP20,000.
 - 8.2.5.3 Pocket Wifi or Internet Connection may only be purchased if the agency requested budget is PhP1Million, and the price allotted for the Pocket Wifi shall not be more than PhP2,000.
 - 8.2.5.4 LCD Projector may only be purchased if the agency requested budget is PhP2Million, and the price allotted for LCD Projector shall not be more than PhP30,000.
- 8.2.6 The above-mentioned equipment shall be taken care of and shall be under the custodial property of the Office of the City/ Municipal Agriculture.
- 8.2.7 The above-mentioned equipment shall only be procured once.
- 8.2.8 The above-mentioned equipment shall only be used on all ICFP-related activities or tasks.
- 8.2.9 Actual gardening and food production activities shall ensue after all the above processes have been completed.
- 8.2.10 A clear cut policy on the distribution of ICFP inputs and materials shall be crafted by the ICFP Team to ensure fair distribution among the beneficiaries.
 - 8.2.10.1 The ICFP Team shall ensure that all beneficiaries will receive fair number of production inputs and materials.
 - 8.2.10.2 LGU employees shall be barred from receiving ICFP inputs, unless they belong to the participating poor families and are included in the list of beneficiaries identified in priority barangays by the ICFP Team.

8.2.10.3 Seeds that shall be distributed to beneficiaries must be placed in good packaging.

8.2.10.4 The ICFP Team shall ensure that all actual inputs are of good quality.

8.2.11 The ICFP Team shall hold regular meetings and shall conduct regular project monitoring. They shall be granted with allowable transportation and meal allowances during community meetings and monitoring visits.

8.2.12 The ICFP Team shall facilitate the selection of ICFP Community Coordinators (ICCs) from among the household beneficiaries.

8.2.12.1 The selected ICCs shall be trained by members of the ICFP Team.

8.2.12.2 An ICFP City/Municipal Coordinator may be hired by the ICFP Team to lead the ICCs in the conduct of their responsibilities with respect to beneficiaries in household and community gardening, and other food production activities.

8.2.12.3 The ICCs shall assist the City/Municipal Agriculture Officer (C/MAO) in providing technical assistance to household beneficiaries.

8.2.12.4 The ICFP coordinators may be granted transportation and meal allowances from the project fund as determined by the ICFP Team.

8.2.13 The ICCs shall convene and facilitate the regular meetings of household beneficiaries on a monthly basis to facilitate updating of project status and to respond to issues and concerns encountered during the project implementation.

8.2.13.1 The ICCs shall produce a monthly monitoring report that they shall submit to the C/MAO for consolidation and submission to NAPC. [Refer to Annex H for the Monthly Monitoring Report Template]

8.2.13.2 The monthly monitoring report shall contain the progress and status of the home and community gardens, poultry and livestock production, and other components of the ICFP Program, including the family consumption of their produce.

8.3 Post-Implementation Phase

8.3.1 The ICFP Team shall once conduct the Food and Nutrition Survey (Endline Survey) to compare results of the baseline survey. [Refer to Annex I for the Endline Survey Tool]

8.3.1.1 The survey shall again be spearheaded by the City/Municipal Nutrition Action Officer (C/MNAO) of the LGU, and they may seek again the assistance of their hired enumerators.

8.3.1.2 Summary of the Endline Survey must be included as an attachment to the Terminal Report of the LGU.

8.3.2 The ICFP Team shall conduct and facilitate a beneficiary assessment workshop.

8.3.2.1 This shall be done at the end of the project term.

8.3.2.2 Report on the assessment workshops shall also be submitted to NAPC.

Section 9 Monitoring and Evaluation

9.1 The ICFP Team shall consolidate the monthly monitoring report of the ICFP City/Municipal Coordinator and ICFP Community Coordinators.

9.1.1 The consolidated monthly monitoring report shall be used as the basis for the Midterm and Terminal Reports of participating LGUs.

9.1.2 The Midterm and Terminal Reports shall be submitted by participating LGUs to NAPC through the ICFP Online Monitoring Platform.

9.2 The NAPC - LACMS Unit through its ICFP Program Manager, Regional and Provincial Focal Persons, and Technical Consultants shall conduct on a periodic basis the Monitoring and Evaluation of the ICFP Program implementation to validate the reports of participating LGUs.

Section 10 Summing-Up Conference

10.1 NAPC shall convene and facilitate the ICFP Summing-Up Conference to have an annual assessment of the program implementation.

Section 11 Documentation of Good Practices and challenges

11.1 NAPC shall commission a team of documenters to document the whole process of ICFP program and generate information of good practices and lessons learned during its implementation.

11.2 Results of this documentation shall be presented to the Regional Poverty Reduction Action Team (RPRAT), National Poverty Reduction Action Team (NPRAT), BUB Executive Committee, Human Development and Poverty Reduction Cabinet Cluster and other relevant government agencies.

PART III Composition of the ICFP Team

Section 12 Composition of the ICFP Team

12.1 The ICFP Team shall be composed of the following:

12.1.1 Mayor (As Chairperson)

12.1.2 City/Municipal Agriculture Officer or designated Agricultural Technicians (As Lead Convenor)

12.1.3 Technical Assistant to the City/Municipal Agriculturist (As ICFP Focal Person)

12.1.4 LPRAT Co-Chairperson (As ICFP Co-chairperson or ICFP Municipal Coordinator)

12.1.5 City / Municipal Nutrition Action Officer (C/MNAO)

12.1.6 ICFP Community Coordinators (ICC)

12.1.7 Selected CSO LPRAT Members (to ensure the 50% CSO, 50% LGU composition of ICFP Team)

12.2 The ICFP Team shall be composed of at least 40% women to ensure the participation and decision-making of women in all ICFP-related activities.

12.3 The Roles and Functions of the ICFP Team members shall be the following:

ICFP TEAM MEMBERS	ROLES AND FUNCTIONS
Mayor	<ul style="list-style-type: none"> ■ Act as the Chairperson of the ICFP Team ■ Ensure that ICFP Program at the local level is moving smoothly, similar to other BUB Projects
City/Municipal Agriculture Officer or Designated Agricultural Technician	<ul style="list-style-type: none"> ■ Act as the Lead Convenor of the ICFP Team ■ Oversee the over-all implementation of the ICFP Program at the local level ■ Supervise the day-to-day operation covering the three (3) phases of the ICFP Program implementation ■ Check the compliance of the requirements for the release of funds in coordination with the LPRAT ■ Spearhead the selection of the household beneficiaries, the ICFP Community Coordinators (ICC) and other ICFP Team members ■ Submit midterm and terminal reports to NAPC
Technical Assistant to the C/MAO	<ul style="list-style-type: none"> ■ Assist the C/MAO and the ICFP Team in the Implementation of ICFP including but not limited to the following tasks: documentation, proposal making, submission of manual and online reports, monitoring and others
LPRAT Co-Chairperson	<ul style="list-style-type: none"> ■ Act as the Co-Chairperson of the ICFP Team. ■ May take the role of the City/Municipal Coordinator or assign anyone as his designate ■ Ensure the proper listing and genuine participation of all the targeted household beneficiaries ■ Sit as CSO Observer in the Bids and Awards Committee (BAC) where deliberation of project procurement procedure related to ICFP is done

ICFP TEAM MEMBERS	ROLES AND FUNCTIONS
ICFP Community Coordinators (ICC)	<ul style="list-style-type: none"> ■ Act as the leader or coordinator of household clusters of beneficiaries ■ Provide technical assistance to household beneficiaries in coordination with the City/ Municipal Agriculture Office and the NAPC Technical Consultants and/or Service Providers ■ Supervise and monitor the established household and community gardens, organic fertilizer production and other cluster-level food production plans, as specified in the participating LGU's project proposal ■ Attend capacity building and other meetings ■ Submit monthly monitoring reports to C/MAO
City /Municipal Nutrition Action Officer (MNAO)	<ul style="list-style-type: none"> ■ Lead the conduct of the baseline and endline survey in coordination with the ICFP Team ■ Provide significant local data on food and nutrition
Household Beneficiaries	<ul style="list-style-type: none"> ■ Establish own home gardens and produce food ■ Attend ICFP Program orientation, capacity building activities and other meetings ■ Consume their own food produced in their homes or community to ensure mitigation and/or elimination of hunger and malnutrition within the family circle ■ Participate in establishing community gardens ■ Abide by the rules and regulations established by the ICFP Team for the smooth implementation of the program ■ Continue planting vegetables even after the project cycle
Other CSO Members	<ul style="list-style-type: none"> ■ Assist in the timely implementation of ICFP Program ■ Assist in monitoring the smooth implementation of the ICFP Program ■ Assist in reviewing and evaluating the day-to-day implementation of the ICFP program

12.4 The ICFP Team Structure

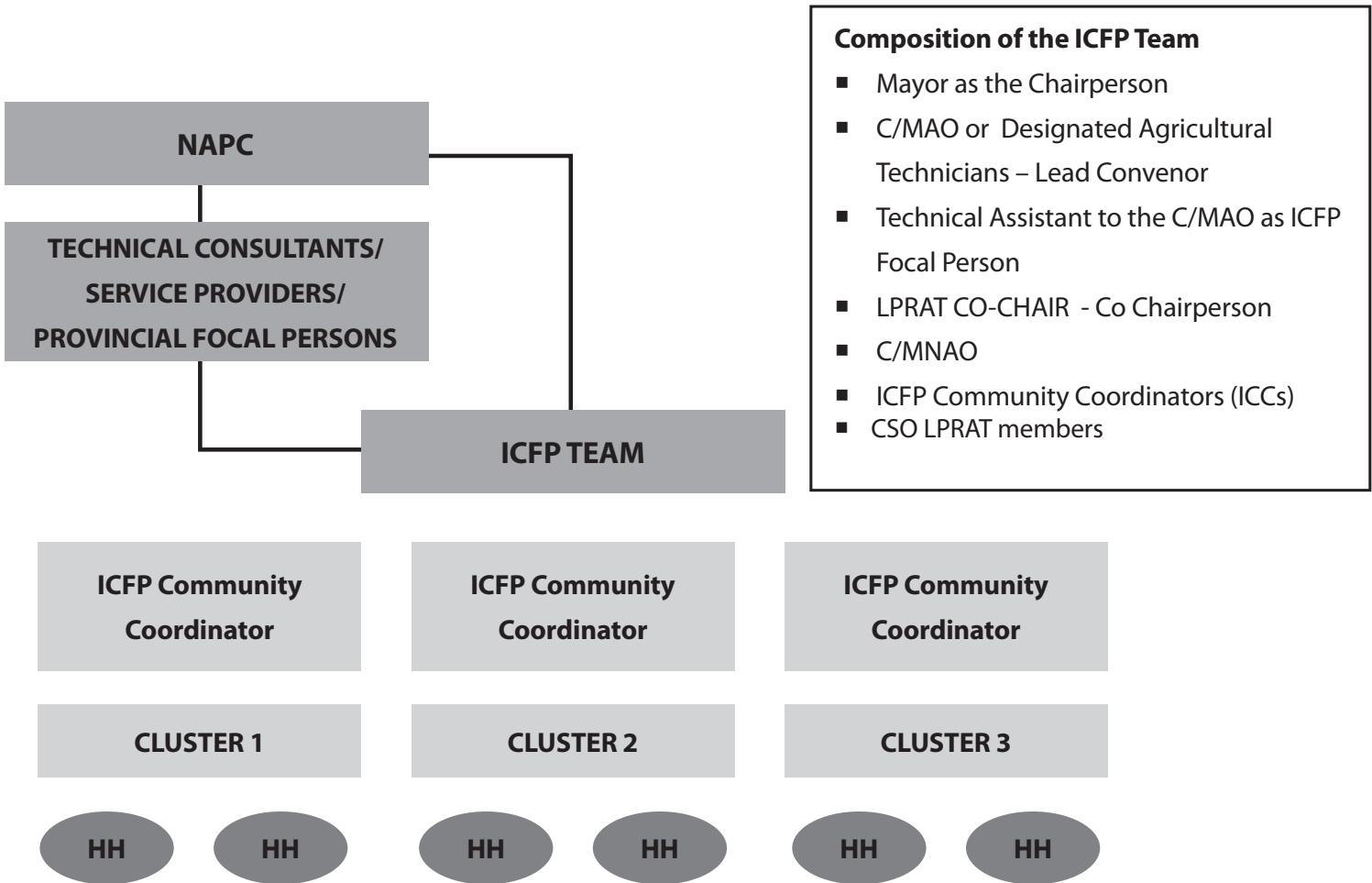

12.5 Honorarium and Allowances

- 12.5.1 Honorarium may be given to some members of the ICFP Team, provided that they are not regular employees or elected officials of the LGU.
- 12.5.2 Members of the ICFP Team who shall be granted with an honorarium include but are not limited to the following: ICFP Municipal Coordinator or CSO LPRAT Co-Chairperson, ICFP Technical Assistants, and ICFP Community Coordinators.
- 12.5.3 Double payment of honorarium for ICFP Team Members shall not be allowed for LGUs with overlapping ICFP projects funded under the BuB.
- 12.5.4 The ICFP Team shall determine the amount of honorarium to be given to some members of the ICFP Team, provided that the allotted budget will not exceed the budget cap specified hereunder for the honorarium.
- 12.5.5 Transportation and Meal Allowances may be given to all members of the ICFP Team, provided that the allotted budget will not exceed the budget cap specified hereunder for the honorarium.
- 12.5.6 Honorarium for the Resource Speakers, and/or Accommodation, Transportation and Meal Allowances may be given to NAPC Technical Consultants and Service Providers, provided that the allotted budget will not exceed the budget cap specified hereunder for the honorarium.
- 12.5.7 All honorarium and allowances shall be subject to government rules and regulations.

PART IV Sustainability Mechanism

Section 13 Sustainability Mechanism

- 13.1 To sustain the ICFP Program in the city/municipality, a production recovery scheme shall be deployed by the ICFP Team.
- 13.2 The minimum recovery conditions are as follows:
 - 13.2.1 Seeds / Seedlings Recovery (1:1)
 - 13.2.2 Poultry / Livestock Recovery (1:1)
- 13.3 LGUs may opt to increase the repayment rates.
- 13.4 The ICFP Team shall identify areas for storage of collected produce.

- 13.5 The ICFP Team shall designate the ICCs as collectors of repaid seeds, seedlings and livestock.
- 13.6 Collection shall be done every after cycle of the project or around 4-6 months after the distribution of the actual inputs.
- 13.7 They shall identify beneficiaries for expansion based on the malnutrition and poverty data available in the municipality/city.

Section 14 Marketing Support

- 14.1 The LGU shall institutionalize the marketing support for household beneficiaries.
- 14.2 The LGU shall assist the household beneficiaries in marketing the surplus of their produce for additional income.
- 14.3 Examples of marketing assistance that may be given by the LGU include but not limited to the following:
 - 14.3.1 Provision of free market spaces for ICFP household beneficiaries.
 - 14.3.2 Declaration of a market day where household beneficiaries can display and sell all surplus of their produce
 - 14.3.3 Organizing of an event to showcase the surplus produce of household beneficiaries for local and foreign tourists
- 14.4 The ICFP Team shall support the seeds and seedlings production activities of household beneficiaries to commence the social entrepreneurship initiatives.
- 14.5 Marketing scheme / activities shall be integrated in the work and financial plan of the ICFP Team.
- 14.6 All marketing activities related to ICFP shall be included in the midterm and terminal reports of the ICFP Team to NAPC.

Section 15 Replication and Expansion

- 15.1 Replication and expansion of the ICFP project shall be done to cover all of the barangays within the city/municipality.
- 15.2 Priority for replication and expansion shall always be given to areas with high incidence of poverty and malnutrition.
- 15.3 The ICFP Team shall determine the organizational policies on replication and expansion purposes.

PART V Potential Areas for Inter-Agency Hunger Project Complementation and Supplementation

Section 16 Inter-Agency Work Complementation and Supplementation

16.1 LGU may complement their ICFP Program with other hunger mitigation programs of the government.

16.2 LGU may work in coordination with the following agencies:

16.2.1 Department of Social Welfare and Development (DSWD)

16.2.2 Department of Education (DepEd)

16.2.3 National Nutrition Council (NNC)

16.2.4 Department of Agriculture (DA)

16.2.5 Bureau of Plant and Industry (BPI)

16.2.6 Philippine Coconut Authority (PCA)

16.2.7 National Dairy Authority (NDA)

16.3 The following specifies the potential areas of convergence where the above-mentioned agencies may complement and supplement with ICFP through their agency-specific hunger-mitigation programs:

Agency	Specific Hunger Mitigation Programs	Areas of Complementation and Supplementation
DWSD	Supplementary Feeding Program	<ul style="list-style-type: none"> ▪ Serve as additional market of surplus produce vegetables and poultry and livestock in their hot meals for children
	Sustainable Livelihood Program (SLP)	<ul style="list-style-type: none"> ▪ Provide funds to support the marketing activities of surplus produce
	Early Warning System on Food Insecurity	<ul style="list-style-type: none"> ▪ Share results of benchmarking of food-poor constituents at the local level
	Pantawid Pamilyang Pilipino Program (4Ps)	<ul style="list-style-type: none"> ▪ Ensure nutrition module in the Family Development Sessions
NNC	Radio Programs for advocacy and education: Nutriskwela Community Radios	<ul style="list-style-type: none"> ▪ Advocate and integrate ICFP Program in their Radio Program “Nutriskwela”
		<ul style="list-style-type: none"> ▪ Provide results of Baseline Survey using OPT data, etc.
DepEd	Gulayan sa Paaralan	<ul style="list-style-type: none"> ▪ Assist in providing available lots for community gardens or nurseries for seeds and seedlings hub ▪ Maximize technical assistance from agriculture teachers for training and research on community nutrition data, etc. ▪ Policy support
	School-based feeding program	<ul style="list-style-type: none"> ▪ Provide market for surplus produce specially for poultry and livestock

Agency	Specific Hunger Mitigation Programs	Areas of Complementation and Supplementation
PCA	KAANIB Enterprise Development Project (KEDP)	<ul style="list-style-type: none"> ▪ Provide technical assistance for the inter-cropping and poultry & livestock raising (especially in the 20 priority provinces)
BPI	Technical assistance and material assistance on urban gardening etc.	<ul style="list-style-type: none"> ▪ Provision of certified and open-pollinated seeds ▪ Technical assistance in seed banking ▪ Technology on Urban Gardening
NDA	Dairy Production	<ul style="list-style-type: none"> ▪ Provide list of Dairy Cooperatives ▪ Provide Technical Assistance to household beneficiaries for Dairy Goat or Cattle Dairy Production ▪ Link the household beneficiaries to existing Dairy Cooperatives in their area

16.4 The ICFP Team is encouraged to actively coordinate with the above-mentioned agencies for convergence at the LGU level.

PART VI Funding

Section 17 Approval of Project Proposal

17.1 The LGU shall submit their respective project proposal to NAPC.

17.2 NAPC shall review and validate the Project Proposals and WFPs submitted by LGUs.

17.3 NAPC shall approve the Project Proposal upon completion of all necessary documents as specified in Section 8.1.4.3.

17.4 LGUs shall only be able to implement the ICFP Program once they have received the Notice of Approval signed by the NAPC Local Affairs Director, along with their copies of the signed Project Proposal.

Section 18 Nature of the Requested Fund

- 18.1 The fund that will be used for the ICFP Program shall be sourced from the Local Government Support Fund (LGSF).
- 18.2 The fund shall directly be downloaded from the Bureau of Treasury (BTr) to participating LGUs upon compliance with the governance conditions set in accordance with the pertinent special and general provisions of the General Appropriations Act (GAA and the DBM-DILG-DSWD-NAPC Joint Memorandum Circular No. 7 on BuB Implementation).

Section 19 Breakdown of the Requested Fund

- 19.1 The requested fund for the ICFP Program may be distributed in accordance with the following program components:

Components	Percentage
1. Capacity Building; Community Assemblies and Meetings; and Honorarium of ICFP Team Members	30%
2. Garden/Farm Tools and Other Implements	
3. Actual Inputs a. Procurement of seeds, seedlings, poultry and livestock b. Establishment of household and community gardens and food production infrastructure c. Organic fertilizer production; Vermicast; Composting d. Procurement of Poultry and Livestock, and other farm inputs	55%
4. Monitoring and Evaluation, including monitoring visits, meetings, transportation and allowances	5%

- 19.2 The ICFP Team may add more components whenever applicable to further enhance the implementation of their program.

Section 20 Disbursements and Monitoring of ICFP Funds

- 20.1 Disbursements of the ICFP Funds shall be subject to government accounting and auditing rules and regulations.
- 20.2 NAPC shall assess the expenditures of the ICFP Fund if there are validated reports of gross misuse of the ICFP Fund both on the part of the LGUs and the CSOs.

Section 21 Utilization of the Management Fund

- 21.1 NAPC shall utilize the three percent (3%) management fund as stipulated in the provisions of the General Appropriations Act and Joint Memorandum Circular No. 7 on Integrated Community Food Production Program for technical assistance, capacity building, monitoring and evaluation, and other expenses for efficient and effective implementation of the program.

Section 22 Repealing and Effectivity Clause

- 22.1 All provisions stated in the previous ICFP guidelines that are inconsistent with this Amended Implementing Rules and Guidelines are hereby repealed, amended or modified accordingly.
- 22.2 This Order shall take effect immediately and remain valid until revoked or cancelled.

01 February 2016



SECRETARY JOSE ELISEO M. ROCAMORA
Lead Convenor

Intensive Organic Gardening



Integrated Community Food Production

A Compendium of Climate-resilient Agriculture Options

Definitions of Homegarden

1. Homegarden is an area of land, individual wined, surrounding a house and usually planted with a mixture of perennials and annuals. (TERRA, 1954)
2. A plot of land that has a residence on it, fixed boundaries and a functional relationship with its occupants. (Second Homegarden, Seminar Indonesia, 1978)
3. A subsystem within larger food procurement systems which aims to produce household consumption items, either not obtainable through permanent shifting agriculture, hunting, gathering, fishing, livestock, husbandry or wage earners. (Anonymous)
4. A garden is defined as a supplementary food production system that is under the management and control of household members. A household garden can be consumption or market-oriented, but at least some of the produce will be consumed by the household. As a supplementary production system, the household garden is secondary to both the primary source of household food, whether from field production or purchase and to household income, whether from sales of field produce, wage labor or other sources. (Soleri, D., Cleveland, D. A. and Frankenberger, T. R., 1991)
5. Homegarden covers the production of vegetable for family use. It is an important but inexperienced way of providing a continuous supply of fresh vegetables for family table. Yields from the homegarden contribute to the family nutrition and may even provide additional income. (Soriano, J.M. and R.L. Villareal, 1969)
6. Homegarden is a land use with definite boundaries and a house, which is usually (but not always) a mixture of annual, perennial plants and animals and serves as variety of



biophysical, economics and sociocultural functions for the owner. (Soemarwoto and Soemarwoto, 1985)

7. A small area where vegetable-growing is being done. In this type of garden, planting is done regularly. Its primary purpose is to provide a continuous supply of nutritious but cheap good quality vegetables for home use. In certain cases, it also provides an extra income when excess vegetables are sold. (Aycardo, H. B. and C. R. Creencia, 1981)
8. Refers to garden within the household perimeter, including the garden located out in the field, the produce of which is normally intended for household consumption. (Eusebio, J. S., 1988)
9. An area within the home lot or elsewhere cultivated for home consumption. (Torres, E. B., 1988)
10. A piece of ground usually adjoining a dwelling where vegetables, fruits and ornamentals are cultivated. (Javier. F.B., 1988)

Source: International Institute of Rural Reconstruction (IIRR). Silang, Cavite, Philippines.

Why Household Food Security Through Gardens Makes Sense?

- Rural people in many parts of the world have always used their house-yard space to grow food, but modern agriculturists have generally not recognized this.
- Degradation of the agricultural and natural resource base requires the use of intensive small-scale biological approaches to vegetable production.
- Garden produce is usually raised with the use of ash, compost, waste water and mulch. This provides an opportunity to recycle household waste and maintain sanitation.
- Pesticide residues on vegetables have reached alarming proportions. Growing ones own is one way of ensuring pesticide-free and safe vegetables.
- Food grown around homes and without the use of external inputs is usually consumed by the family. Fresh and higher quality vegetables with better nutritional values are harvested.

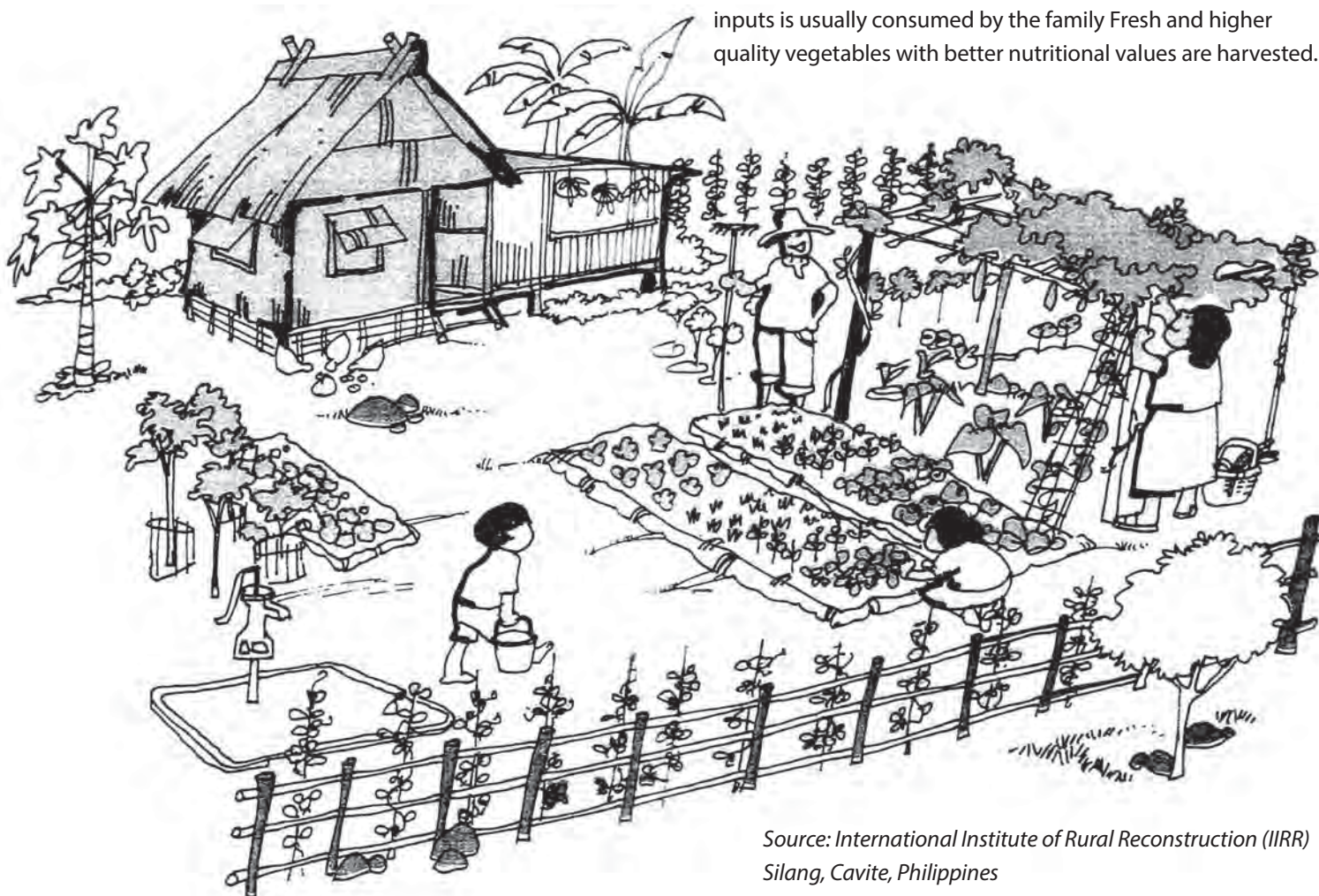

Source: International Institute of Rural Reconstruction (IIRR)
Silang, Cavite, Philippines

Characteristics of the Bio-intensive Approach to Small-scale Household Food Production

The bio-intensive approach to small-scale household level food production differs considerably from the conventional gardening systems because of its stress on deep bed preparation, nutrient recycling, building up of the soil's biological base, diversified cropping, use of indigenous cultivars or locally adapted varieties and its emphasis on a balanced and integrated ecosystem. Here are some of the characteristics the approach as developed and/or promoted by the author.

Sustainability

The bio-intensive approach, as the name suggests, is a **biological** (as opposed to chemical) form of agriculture in which a small area of land is **intensively** cultivated, using nature's own ingredients to rebuild and then maintain the soil's productivity. At the heart of the approach is the effort to improve the soils capability to nurture and sustain plant life. What bio-intensive gardener tries to do on his/her small plot is to simulate/replicate a natural forest the constant recycling of nutrients and maintenance of soil, moisture and microbial conditions. Many countries of the world (and China is particularly notable) have farmed biologically for thousands of years and have been able to sustain output levels over these years. In sharp contrast, the "efficient" but short-sighted approaches being used in many Western and third world countries have often been disruptive of the natural resource base. Farmers in many parts of the world experiencing that they are having to use steadily increasing quantities of fertilizers and pesticides to sustain previous yield levels.

In the bio-intensive approach being recommended here for small-scale plots, the soil is gradually improved and the composition of

beneficial microbial life actually improves from season to season. The soil structure and humus content also greatly benefits. The nutrient content of the soil is built up after each crop rather than being depleted. A healthy soil means a healthy stand of plants, and that means fewer insects and less disease. In the bio-intensive approach, yields continue to rise for the first few years and then tend to stabilize (at an overall higher yield). Such systems and the outputs (i.e., yields) are easily sustained at that level for many years with unchanging or even reduced levels of material and labor inputs.

Recycling of Plant and Animal Wastes and Residues

Every bio-intensive gardener attempts maximize the use of plant and animal residues and wastes. In an attempt to return to the much of what come out from it, material recycled back to the soil. Typically, such material is transported away from the site where it came from in the first place and/or dumped in the garbage or burned. Organic matter must be returned to the soil that helped build it.

A bio-intensive gardener usually composts such plant and animal wastes before returning it to the soil. In addition, other materials also produced at the soil's "cost" are added, such as ash, bone meal, etc. This replenishes the soil with what was taken from it. Soil requires food just as humans and animals do. Once again, the example of a natural forest and how it regenerates itself through continuous recycling (dead trees, fallen leaves decompose on the forest floor with help from forest animals and microbial life) is

helpful in understanding the need for recycling nutrients in the backyard garden.

Today, soils in conventional farming are being literally mined with little or no recycling of organic matter. In the past, various approaches to permit regeneration such as leaving lands to fallow or the abandonment of swidden plots (slash and burn) for periods of 3-10 years were used to permit the regeneration of plant and animal life and rebuild the organic matter status. In other parts of the world (in recent years particularly in India), available chemical inputs were combined with animal manure which served to partially return the organic matter to the soil. In the bio-intensive approach, organic matter is returned to the soils in the form of compost after each crop.

The cultivation of a range of crops (each of different rooting lengths) tends to retain organic residues in the soil at different depths (when plants are pulled out, rootlets and root hairs invariably remain in the soil). Organic matter builds and sustains soil life. No amount of chemicals can do that job. Such organic manure helps “break up” sticky and hardened clays and hold together separate soil particles of sandy soil. Organic matter acts like a sponge that soaks up moisture and retains it for future plant use at a level in the soil where it is readily accessible to the plant.

The organic matter can contribute to the build-up of the soil’s population of earthworms, which in turn improves the aeration and nutrient status of the soil. John Jeavons of Ecology Action indicates that earthworm castings are five times richer in nitrogen, seven times richer in phosphorus and 11 times richer in potassium than the soil they inhabit. When you consider that earthworms produce twice their weight in castings every day, that’s a lot of nutrients added to the soil! The cultivation of a range of different crops having different rooting depot serves to tap different layers of the soil profile thus, reducing soil exhaustion. In fact, different crops require different quantities of soil nutrients, e.g., leafy crops are heavy on nitrogen, root crops are heavy on phosphorus, fruit crops are heavy on potash and legumes in fact add nitrogen. Hence, crop rotation helps build a sustainable and stable soil.

Self-reliance in Production Inputs

As mentioned earlier, the bio-intensive approach is characterized by a greatly reduced dependence on the expensive inputs that are generally used in conventional food production approaches. Many of these non-renewable inputs, such as chemical fertilizers and pesticides, are produced at high energy costs (usually petroleum-based). Instead of such energy-intensive chemical inputs, plants and animal wastes and natural mineral substitutes are used. In the methods being advocated here, the inputs required are bones, wood ash, eggshells, mudpress (by-product of sugar mills) or compost, ipil-ipil (*Leucaena*) leaf meal or fish meal (only in places where they are readily available). Liquid manures or manure teas (fresh manure fermented in water) are used as “top-dressing” every 2-3 weeks during the first two months of a plant’s life.

Locally available seed material is advocated rather than the purchase of hybrids and other 100% imported substitutes. Experience suggests that it is feasible to achieve a 100% self-reliance in recurring input needs. Other than hand tools, all material inputs are usually available locally or are within easy access. This reduces significantly or eliminates the need for cash outlays. It also provides and produces a sense of being able to control the required production resources. Finally, by emphasizing the use of local and biological resources rather than energy-intensive fossil-fuel based chemical imports, a small step is being made in the direction of conserving the world’s non-renewable resources.

Space-intensive

Given the use of bio-intensive techniques, between 60-150 sq m of land area (depending on how much land is available) is all that is needed to meet the vegetable needs of a family. This makes the approach highly relevant to areas where there is a high population pressure on land resources or if people are landless. Landless

people often have access to at least some backyard space. Also, organizations can often arrange for small community lots where each family can be allocated 60-90 sq m of intensive gardening.

In many parts of the world, particularly in the continent of Africa, while land might not be a limiting factor, other inputs such as water and fertilizers are usually severely restricted. Since bio-intensive gardens almost always produce higher yields per unit area compared to conventional approaches, such intensive plots may be relevant even in areas where land per se is not limiting. The bio-intensive plot is intensively used throughout the year. Plant spacings (i.e., very close) are such that, when plants are fully grown, their leaves barely overlap. Maximum use of space is achieved through companion cropping, succession cropping and multistoried cropping.

Labor-intensive rather than Capital-intensive

The bio-intensive approach is labor-intensive initially and, therefore, is best suited to small-scale, family-centered food production. It is also particularly relevant to the poorest section of society who generally lack the capital but often have underutilized family labor potential. Typically, each of the two beds (30 sq m each) recommended for a family takes 4-8 hours to prepare if the double digging option is chosen. If the other options to prepare raised beds are used, 50% less time is required. However, if the double digging option is chosen (in humid tropics such as the Philippines), a single one-time bed preparation is all that is required. No subsequent digging will be necessary (assuming the beds are always covered with some plants and/or mulch). Whatever the option, the amount of labor required declines from season to season.

Water Conservation

The bio-intensive approach described in this kit uses significantly less water than conventional garden plots. The method of deep

bed preparation and the fact that the soil in the bed remains loose (only the soil in the path between beds is subject to compaction) permits the absorption of most of the water which is applied or falls (in case of natural rainfall) on the bed itself. Once in the soil, the judicious quantity of compost which was added to the soil serves to retain moisture within the rooting zone. The closer spacing of plants recommended in the bio-intensive approach reduces the evaporation of water from the soil surface as a result of the sun's action on the soil. Mulching (a layer of grass or straw applied onto the soil and between plants) serves to keep the moisture loss to the minimum. The close spacing of plants reduces further the loss of moisture as a result of the wind's action on the soil and plants.

Conservation of Plant Genetic Resources

The bio-intensive approach, as developed by the author, puts strong emphasis on the use of indigenous vegetable varieties. Ideally, a homegarden should aim at 100% dependency on, such selected traditional seed varieties. The strategy which emphasizes indigenous cultivars not only provides a significant insurance against pests due to the diversity, inherent hardiness and pest tolerance (through years of evolution) but also serves to ensure that this valuable heritage of humankind is conserved for future generations. The best conservators and curators may not always be the seed banks but the farmers and gardeners themselves. Another aspect stressed by the author is the inclusion of indigenous plants which have insect.

Repellant properties as well as applications in the preparation of home remedies for minor ailments. By encouraging the use of traditional medicinal plants with proven values, such plants (and knowledge) are "conserved" for future generations. Indigenous vegetable varieties are not readily available in stores; a bio-intensive gardener must attempt to retrieve such varieties. Remote and neglected provinces and villagers are good places to begin the search for these vanishing resources. Many indigenous

varieties have special features which make them invaluable to the gardener (e.g., hairy stems and leaves which reduce insect problems, staggered ripening of produce, tolerance to partial shade, longer storage quality, etc.)

Pest Control

In the bio-intensive approach, the soil and not the insects is considered the primary source of the pest problem. The wide diversity of vegetables within a single bed tends to reduce insect infestation. In addition, specific plants are raised because their odor helps repel insects from plants surrounding them. The use of indigenous and resistant varieties of vegetables also further reduces pest problems (the very fact that these indigenous varieties have been around for generations says something about their resistance to pests). Finally, various organic (usually botanical) formulations can be prepared at home for use on small patches of crops. These formulations are generally prepared from locally available material and have no adverse effects on the environment and pose no health hazard to the gardener or the consumer of the sprayed vegetables.

Elimination of Pesticide-related Health Hazards

Every year, hundreds of thousands of people are killed due to accidental poisoning by agricultural chemicals. However, what is equally concerning is the cumulative deposits of chemicals in the human body (chronic toxicity) which do not result in immediate deaths but may have long-term effects, the origins and causes of which are usually difficult to trace. The lack of “controls” in developing countries often account for the importation of banned chemicals or the use of chemicals without required safety precautions. Pesticide residues in vegetables in markets of the developing world are frighteningly high. Adequate documentation is already available to suggest that the health hazards at the family level, both in the developed and developing

world, are serious. Bio-intensive gardeners may not be able to solve all the chemical hazard problems, but they can ensure that all their own vegetable harvests can be totally free from such hazards. Thus, the produce harvested from such a garden is worth far more than its market value in money.

Improved Family Nutrition

One of the most important reasons for raising one’s own vegetables using organic methods is the high nutritional quality of the produce. The nutritional value of a vegetable is greatly affected by the condition of the soil. The carbohydrate, vitamin, protein and mineral content are linked to the soil’s mineral and trace-element content. One needs a healthy soil in order to produce a healthy and nutrient-laden vegetable crop.

The emphasis on techniques that do not involve costly inputs tends to provide a greater assurance that vegetables produced this way will be consumed (at the minimum, one knows that the vegetables are not being sold in order to recover the capital invested – no small concern of the poor). The emphasis on a diversity of vegetables improves the range of sources of food typically available. By growing a diverse selection of vegetables (as opposed to monocropping), the availability of nutrient-rich vegetables is spread more widely throughout the season. Also, since only small quantities of many different kinds of vegetables are being produced, the incentive to sell such produce is reduced (relative to the situation when only 1 or 2 crops are raised resulting in peak harvests of quantities that are far greater than the consumption needs of the family). Special emphasis is given to the nutritional aspect of vegetable gardening and preparation of produce with special emphasis on leafy vegetables (e.g., amaranth) and grain legumes (including winged bean) besides the crops more commonly grown. The emphasis on traditional varieties means that more than one plant part is usually edible (e.g., roots, leaves, flowers, pods, etc.). Certain plants are usually good contributors of energy (e.g., lima bean, pigeon pea, rice bean, hyacinth bean all consist of approximately 50% energy and 20% protein).

The dependence on home-grown vegetables usually results in a significant saving of cash resources. This can be used for nonfood needs of the family. However, the bio-intensive approach can also be used as an income-generating project, through the production of vegetables for sale to nearby markets. Such ventures must be preceded by a well-designed educational campaign to ensure that at least a certain percentage of the harvest is utilized at home.

The cultivation of a wide variety of crops tends to insulate cultivators against the risk of (i) devastation of monocrops by pests and (ii) risk of price slumps resulting from over-production of a particular crop. If the bio-intensive approach is to be used as an income-generation project, the number of beds needs to be increased from two (each 30 sq m) to at least ten or twelve. If these are prepared during the slack period (e.g., after harvest), the bed preparation can usually be accomplished over a period of time and with no cash outlay: family labor or through mutual help in a village community. Since small quantities of a large number of vegetables are raised, the producer can market them locally or/ and directly thus, ensuring higher cash returns.

Risk-free

The use of readily available, natural resources and the total reliance on family labor in the bio-intensive approach reduce any financial risks to the family. The use of organic nutrient sources, the continuous improvement of and the growing of a highly diverse selection of vegetables (usually 8-10 in two beds) tend to reduce very significantly, pest problems. If pests do cause damage, only a portion of the crop is lost because of the diversity of crops grown (the risks of monocropping are eliminated here). If a complete shift can be brought about to the use of traditional varieties (those that have been around for generations), the pest problems and therefore, the risks are negligible.

Ecologically Sound

The bio-intensive approach suggests human beings must work with nature rather than attempt to dominate and control it. Renewable sources of energy are used in this system. Every attempt is made to maintain an environmental balance. The non-use of increasing quantities of chemical-based inputs reduces the contamination of the environment with chemicals that tend to persist in the soil for many years after use (i.e., they are not biodegradable). The use of animal manures (in countries where they are not already being used, as in parts of the Philippines and Africa) can reduce environment sanitation problems and related health problems in rural areas. The bio-intensive approach at the homegarden level can set people thinking about the "larger" environmental issues. It can get people to question what they may hitherto have accepted as an inevitable consequence of modernization and development.

Source: Gonsalves, J. F. Paper presented at the Asian Vegetable Research and Development Centre, Taiwan. VIP Gardening Workshop. April 25, 1985

Bio-intensive Garden

A Climate & Nutrition Smart Agriculture Approach

- Why are Bio-intensive Gardens climate and water smart?
- How can we make them more adaptive to climate change?
- How can we conserve genetic diversity of nutritional importance?
- Bio-intensive Garden (BIG) is an agro ecological approach to gardening which makes the best use of available natural resources and does not rely on any chemical inputs.
- A bio-intensive garden has a low carbon footprint because very few external resources are used.
- BIG relies on locally produced seeds, locally produced fertilizers and it does not use any chemical pesticides. Thus, the carbon footprints of food produced using this approach is small. Moreover, the food products are safe and free of pesticide residues.

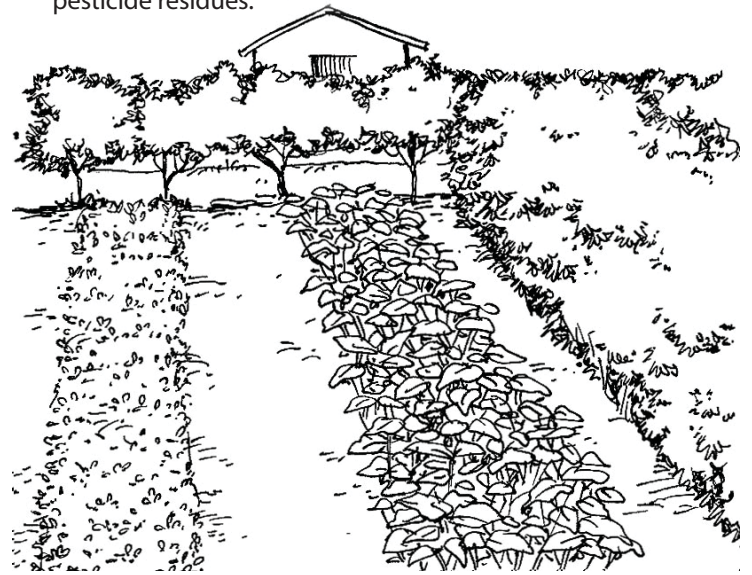
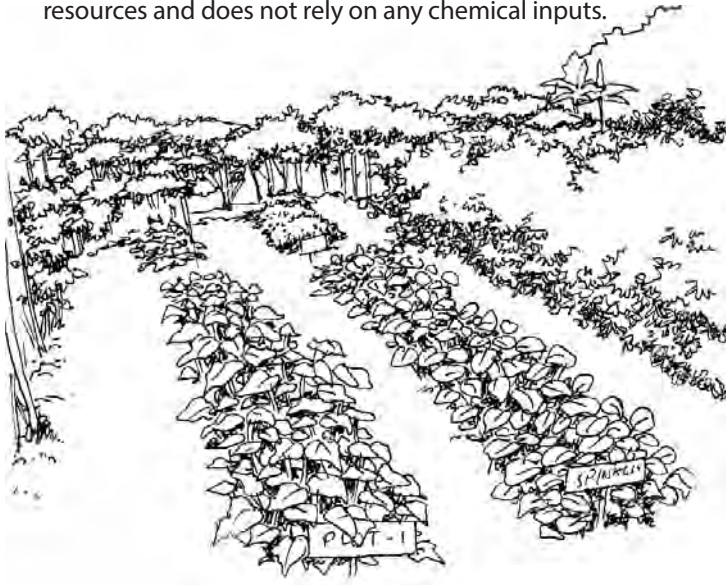

- A deep dug bed is essential when there are frequent droughts or flooding (12 inches deep or more is essential if you want to trap water in the soil).
- A deep dug bed conserves rainwater and in times of floods, water is drawn down to the lower part of the soil, within reach of the plant roots.

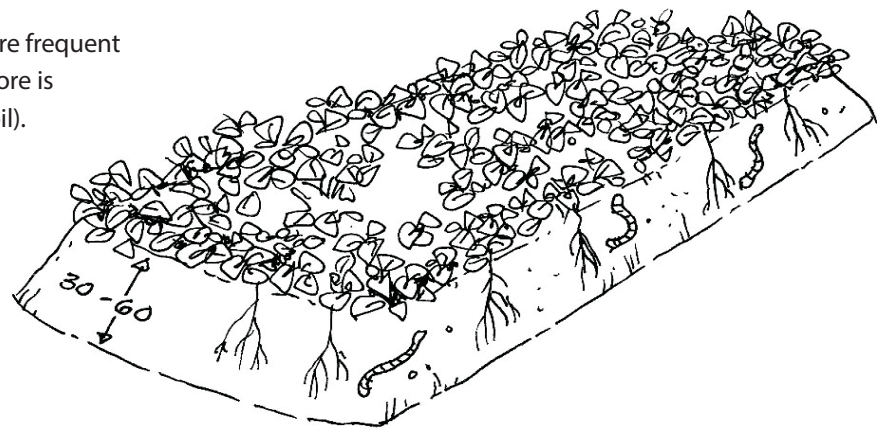

- The beds are narrow making it possible to work from the sides to prevent compaction. This leaves the soil always loose.
- The slightest rain is absorbed and stored in the soil. BIG beds harvest rainwater better and store moisture longer.

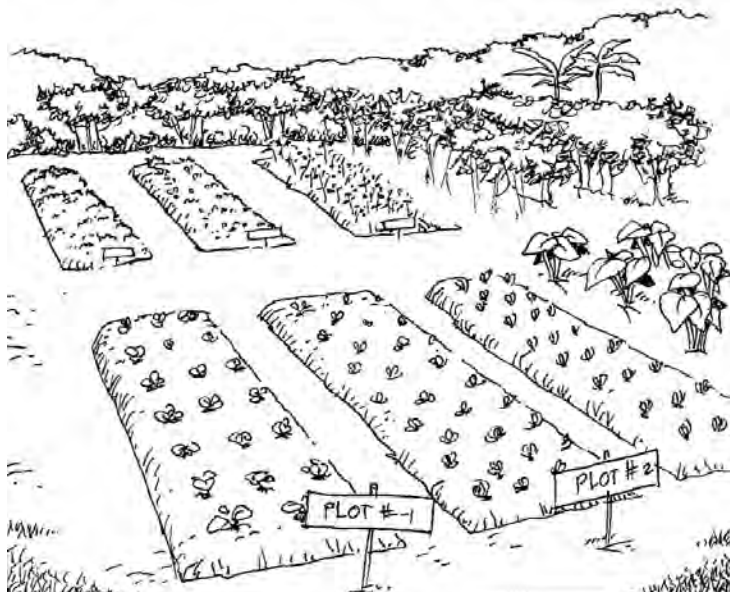

- In summer when your gardens are generally not actively maintained, the entire garden should go into a cover crop of legumes (cowpea, rice bean, etc). This keeps the microbes alive and reduces weed growth and most important of all keeps the soil temperature low.



- Deep dug beds with loose soil and lots of organic matter help to store water, encourage earthworms and beneficial bacteria. This is a LIVING soil and gets better every year (PROVIDED you don't let it dry up and compact again in summer).

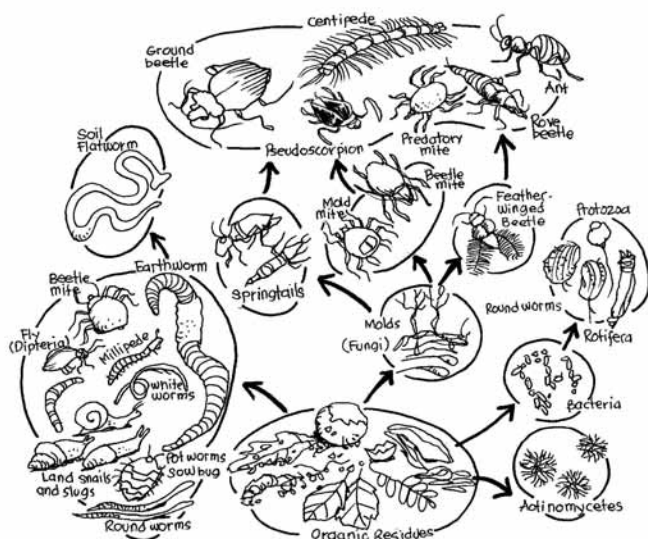

- The planting of trees around the periphery of the garden (Kakawate or *Gliricidia sepium* or *Cassia siamea*) is an absolutely essential element. Leaves of these nitrogen-fixing trees serve as source of green fertilizer. If trees are not planted on all four sides of the plot, then we don't get the advantage of the cooling effects of trees. If you don't have trees, the wind tends to dry the soil. Moreover, trees can serve as barriers against strong winds.

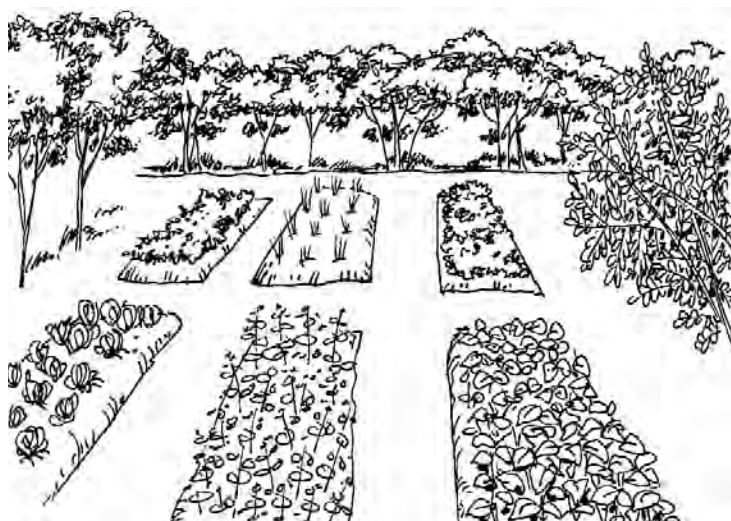

- Green-leaf manure trees are also grown between every two sets of plots to provide green-leaf fertilizer.

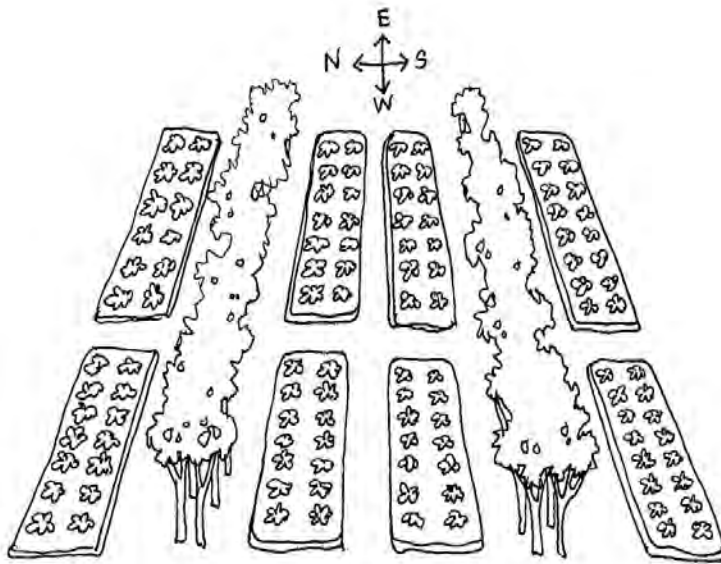

- The advantage of using green leaves as fertilizer is that it is a way of storing carbon in the soil. Unlike when one uses chemicals where we contribute to the greenhouse gases (trees absorb carbon).

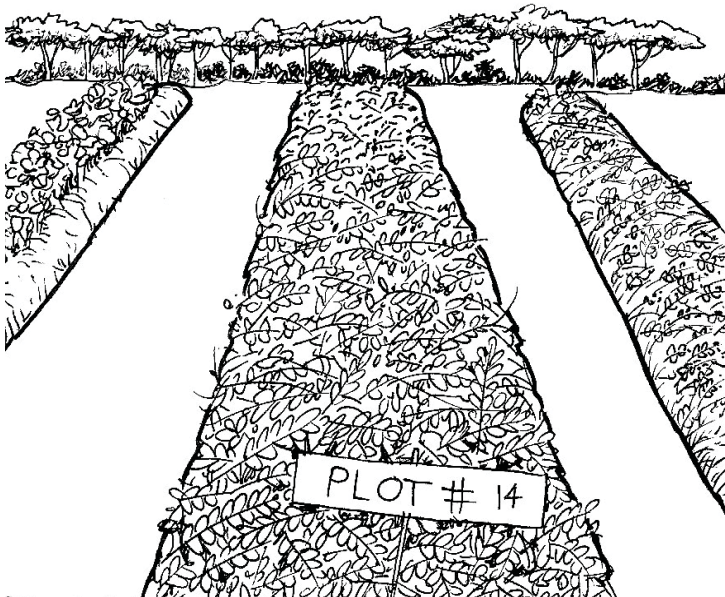

- Another feature of BIG is that it uses mostly indigenous plant species. These are usually hardy and climate resilient. Climate resilient varieties are being lost because they are not popular amongst market-farmers.
- These indigenous heritage varieties are still around and passed down from one generation to another. They must be saved because they are hardy and tolerate long dry weather (eg., Patane or Lima bean; Batao or Hyacinth bean or Kadios or Pigeon pea).

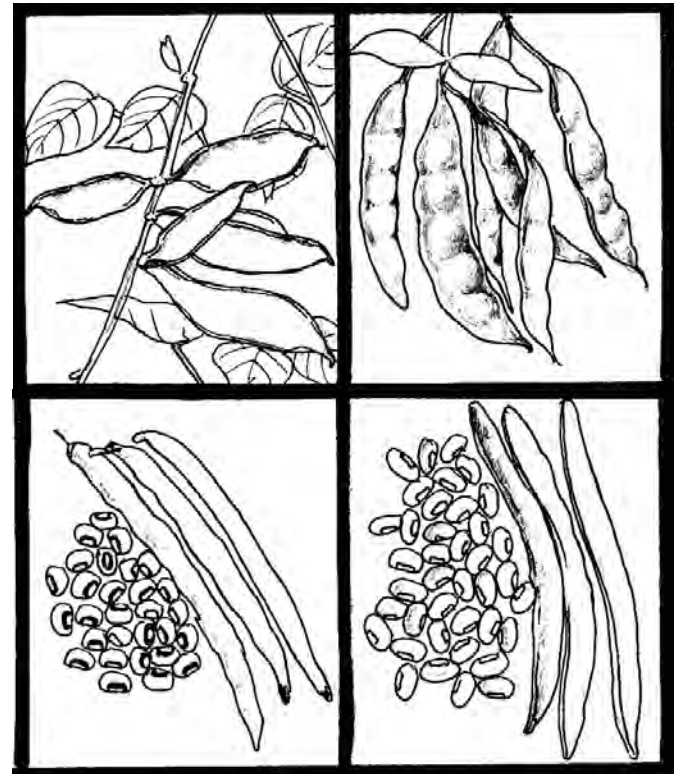

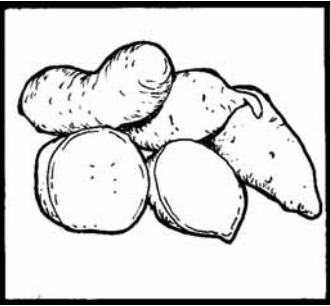

- With rising temperatures we can expect more pests and diseases. That is a reality. This is the reason for increasing the intraspecies diversity to reduce risks from crop failure (eg., different kinds of sweet potato).

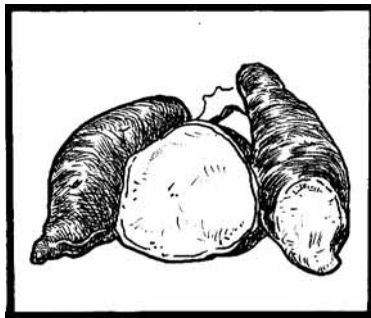
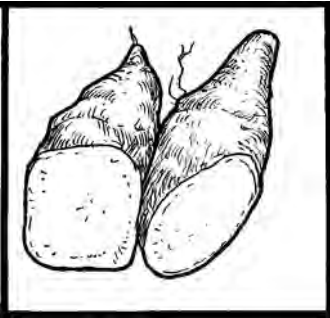

... the interspecies diversity is also important. Diverse gardens ensure dietary diversity.

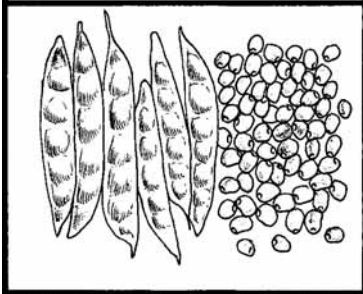
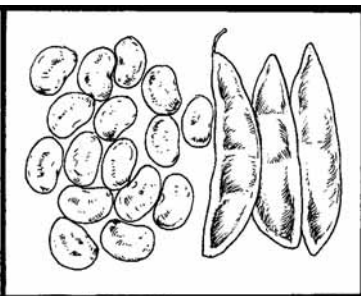
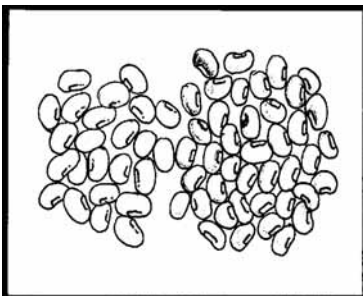

- In BIG we practice minimum tillage. After the first digging and especially in the drier months we avoid subsequent unnecessary digging. The next crop is planted in the residue of the previous crop. This is a way of conserving soil moisture.



- Green or blue net tunnels help reduce temperature and protect the crop from rain and insects.

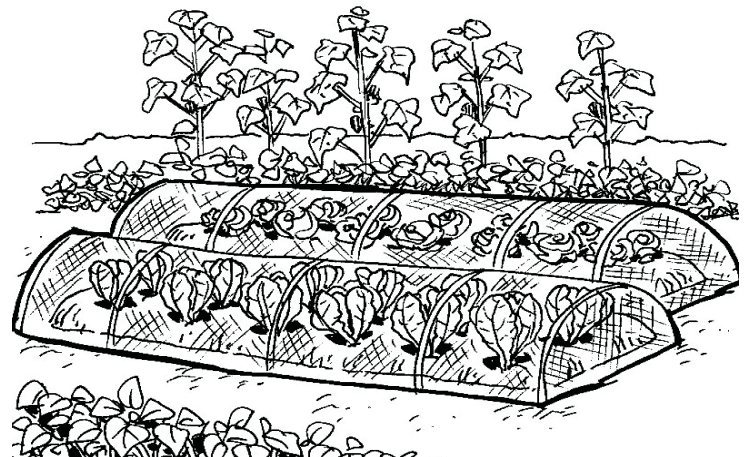

- Another way of conserving moisture and lowering soil temperatures is to place mulch on the top of the bed and in between plants within the bed.

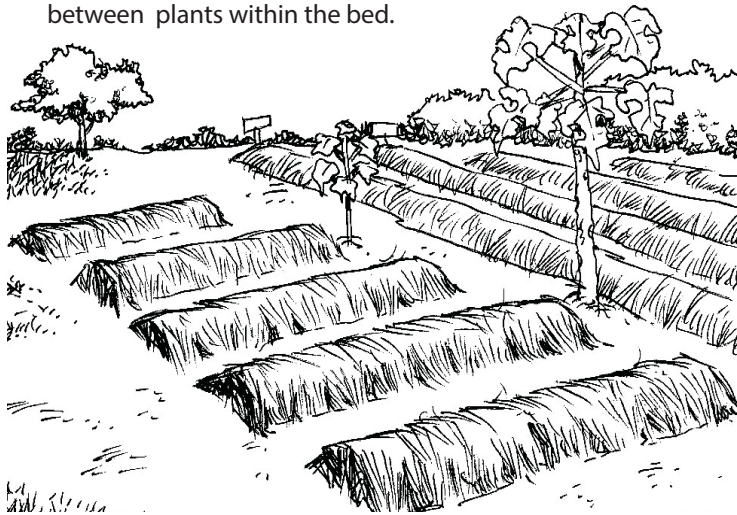

- In a BIG, the plants do the digging themselves. When you practice crop rotation you take advantage of the fact that different crops have different rooting depths. So crops are always rotated and never planted in the same area in the same year.

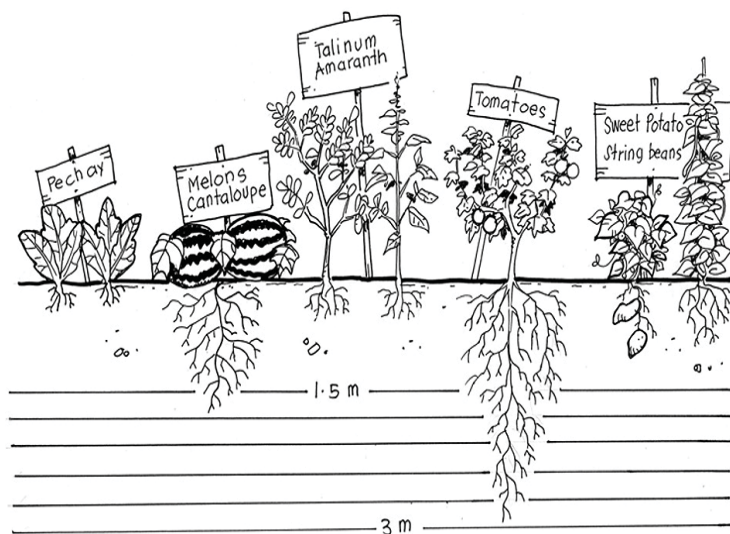

- BIG is an excellent example of climate smart agriculture.
- Try it out and see for yourself. Enjoy nature and live a healthy lifestyle with chemical free, fibre dense and micro-nutrient rich foods.
- Enjoy dietary diversity by maintaining garden diversity.

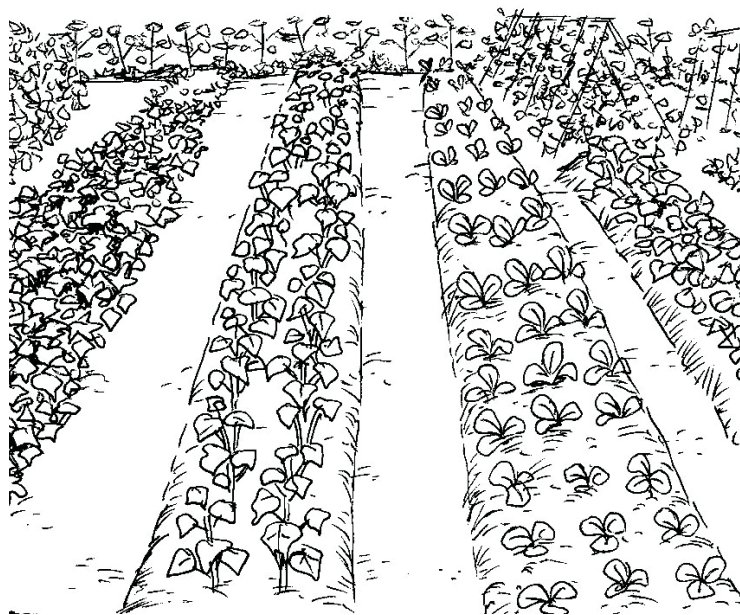

Source: IIRR & CCAFS. 2015. *Bio Intensive Garden Primer*. IIRR, Silang, Cavite, Philippines

Integrated Alley Cropping Bio-intensive Garden*

Uthaitanee Adaptation

Integrated alley cropping is a form of intercropping vegetable plots between rows of fast-growing trees or shrubs. It is applicable in areas where animal manure/compost is not available. Its main purpose is to provide a steady and reliable source of organic material to crops. Since these hedgerows are legumes which fix atmospheric nitrogen, they add a continuous supply of this element as well as valuable organic matter.

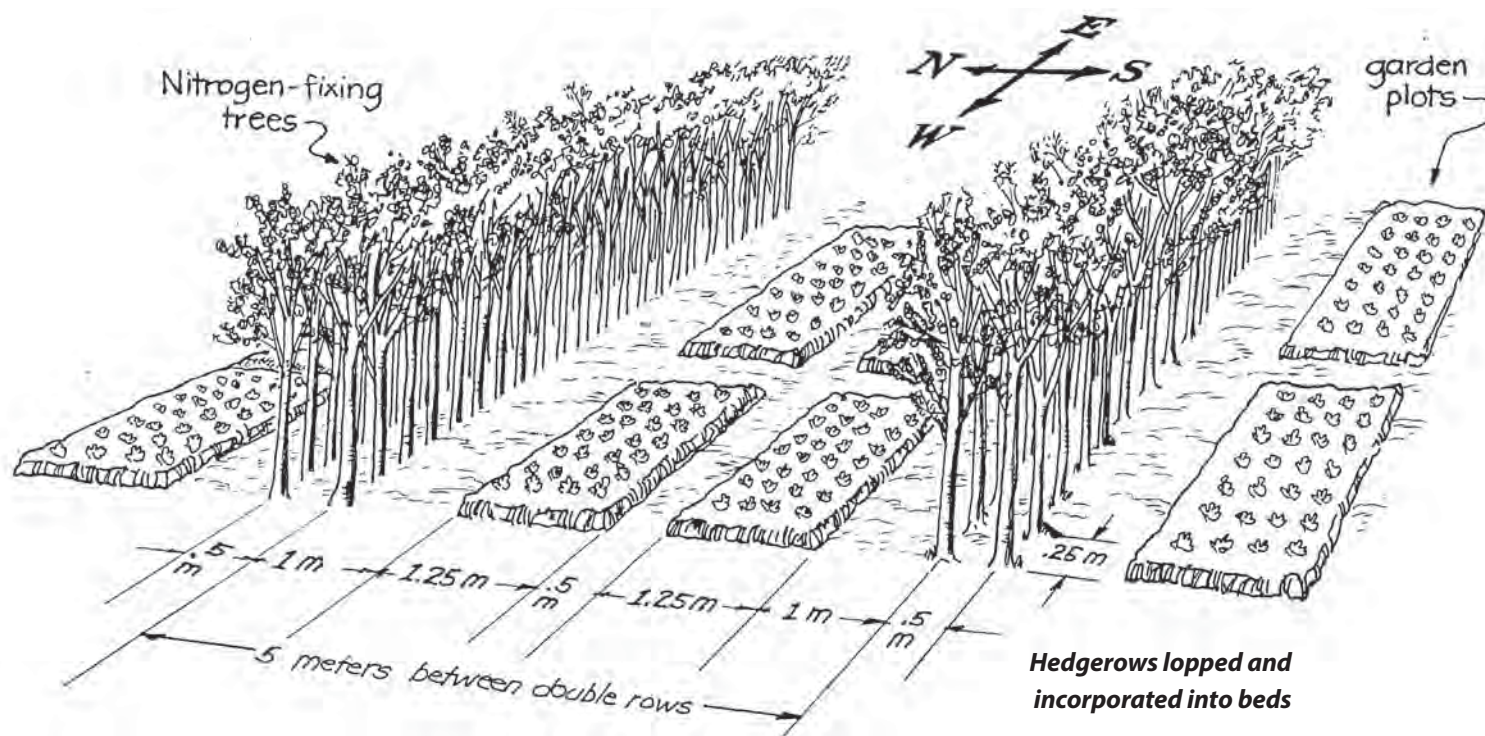

Important Considerations

1. Select fast-growing and nitrogen-fixing trees/shrubs that can withstand frequent pruning.
2. Some potential alley-cropping tree hedgerow species:
Gliricidia sepium *Calliandra calothyrsus*
Flemingia macrophylla *Cassia siamea*
3. Orient the rows in an east-west direction to avoid shading of the crops by the hedgerows.
4. Rows of trees/shrubs should have a minimum space of 5m to allow more space for vegetable crops.
5. Soil should be dug and loosened to a minimum depth of 30cm.
6. Plant tree/shrub seeds and vegetables crops at the same time.
7. Pruning is first done after the trees are 9-12 months old. Trees are cut 0.5m above ground level.

*For areas where animal manure/compost is not available.

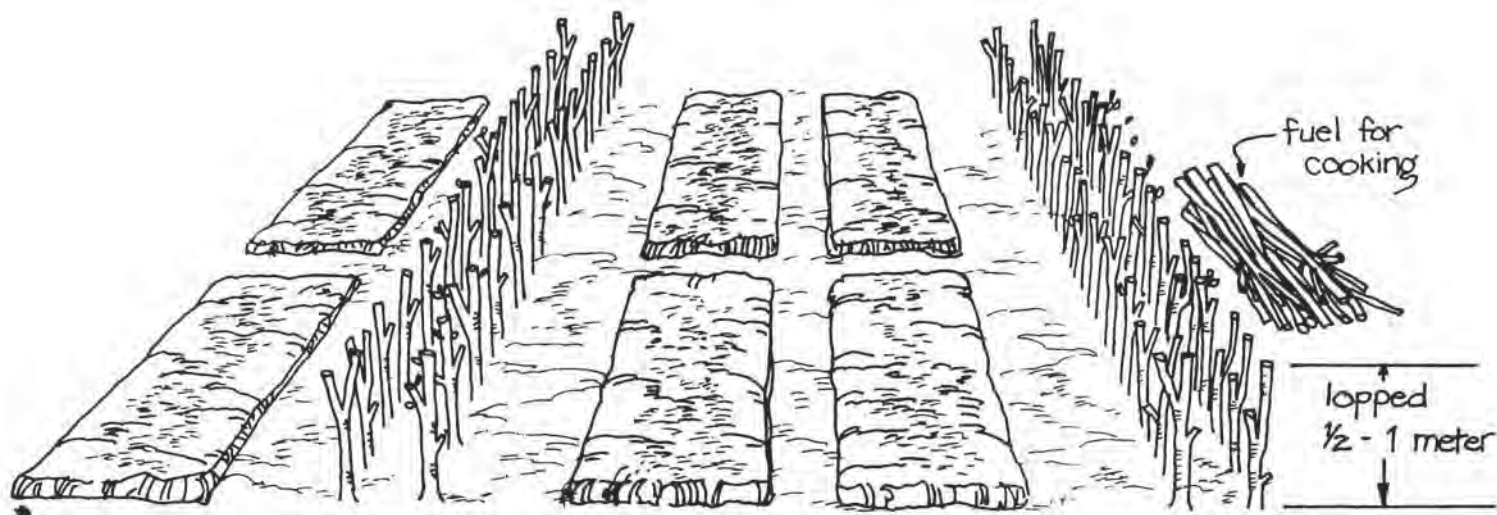

Procedure

1. Cut the trees when they are about three meters in height or the stem diameter is more than one centimeter. Subsequent cuttings are done whenever leaves are needed or the trees begin to shade the garden plots. Leave one branch/tree longer to ensure regrowth in the event of very dry weather.
2. Place cut branches of tree hedgerows (within leaves) over the entire bed.
3. Leave them in place for two days. This will allow the leaves to wilt and hasten defoliation.
4. Shake branches or use hand to remove remaining leaves. There should at least be a 8cm layer of leaves over the entire bed. The branches can be used as fuel for cooking.
5. Incorporate leaves into the soil to a depth of 15cm.
6. Allow leaves to decompose for 10-14 days. If possible, re-dig the bed once or twice to turn over the incorporated materials.
7. After another 10-14 days, apply necessary soil supplements like 1kg of wood ash, 1kg of eggshells and 1kg of crushed bones (where these are available; rates mentioned are for a 9sqm bed area).
8. Shape the bed and plant.

Source: *Regenerative Agriculture Technologies (RAT) Kit*. IIRR UNICEF for Philippine Department of Agriculture. 1989.

Raised-bed Garden Technologies

1. Measure about 1 m by 6 m bed area (length can be altered depending on the availability of land). Divide the bed temporarily into sections, 75 cm wide using wooden stakes as guide.
2. Spread evenly a 8 cm thick layer of compost over the bed.
3. Dig a trench 30 cm deep and 75 cm wide at one end of the bed. Place the soil from this trench on one end of the bed.
4. Dig a second trench adjacent to the first one. Cover the first trench with the soil coming from this trench.
5. The process is repeated until it reaches the other end of the bed. Fill the open trench at the other side of the bed with the soil previously dug out from the first trench (see step 3).
6. Apply the following into the bed: 2.5 kgs compost or decomposed manure or mud press, 1 kg wood ash, 1 kg bone meal, 0.5-1.5 kg fish meal or dried leaves of leguminous trees 30 cm and 1 kg lbs of any of the following: crushed egg shells, snail shells, etc.
7. Mix these plant foods thoroughly into the top 15 cm layer of the soil. Level the bed. It is then ready for planting.

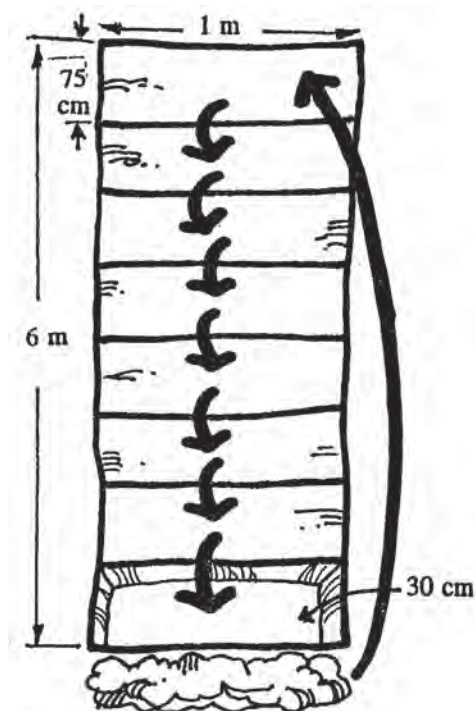

Note: The same natural amendments are added to all the other options of bed preparation.

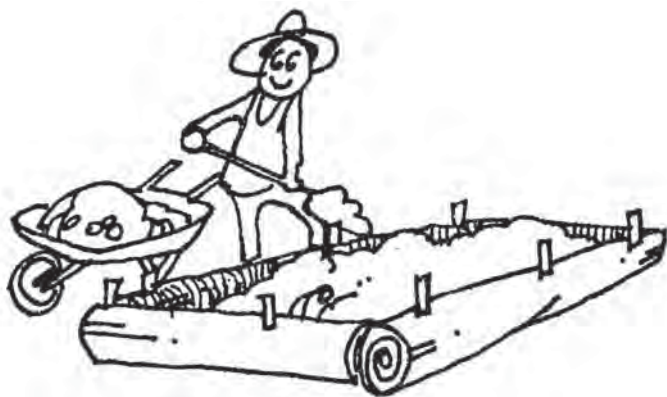

For rocky and waterlogged areas, soil can be taken from other sources and formed into a bed using artificial sidings like banana trunks, coconut trunks, wood planks, etc.



For very hard soils, initial digging of 15 cm can be made. Then beds can be raised further by getting soil from the sides of the bed.



Double digging is one way of upgrading the soil structure by improving soil aeration and water-holding capacity at the lower depths of the soil. Instead of 30 cm, the soil is dug 60 cm deep.

Source: *Regenerative Agriculture Technologies (RAT) Kit*. IIRR UNICEF for Philippine Department of Agriculture. 1989.

Using the Fenceline for Planting Annual and Perennial Crops

Trees, shrubs and other crops must be planted in such a way that a multistoried cropping pattern is achieved. This way, various crops can be grown in a limited space without competing with each other. Weed growth is also controlled through shading by the upper canopy level and by crawling vines.

Upper canopy species (A) - form a protective canopy against tropical sun and torrential rains.

Middle canopy species (B) - feature staple and fruit production including trailing plants which can be allowed to climb the trees.

Lower canopy species (C) - bush-level growth which can be grown to form a double layer of protection against stray animals.

Understory crops and creepers (D) - shade-tolerant crops and crawling vines can be planted to further cover the soil.

How to Make a Fenceline

1. Dig a trench 1 1/2 ft wide and 1 1/2 ft deep along the fence
2. Mix the dug out soil with wood ash and compost and return the mixture into the trench.
3. Plant the seeds or cuttings.

Purpose of Live Fence

1. protection against stray animals
2. windbreak
3. green manure
4. food
5. fuelwood
6. fodder

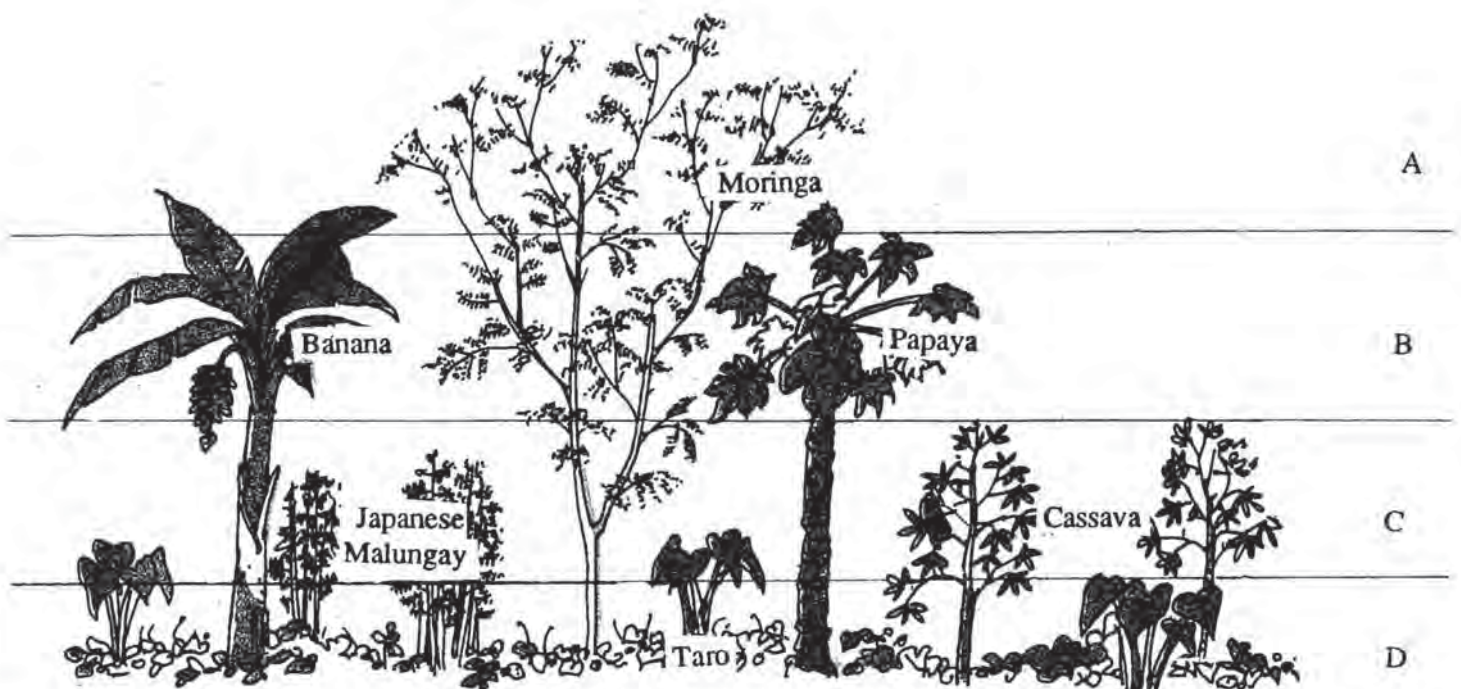

Examples of Plants that Can be Used in a Fence:

A. Upper Canopy Species

Moringa oleifera (horseradish tree)
Sesbania grandiflora (katuray)
Gliricidia sepium (kakawate)
Averrhoa bilimbi (kamyas)
Psidium guajava (guava)
Persia americana (avocado)
Artocarpus altilis (breadfruit)
Artocarpus heterophyllus (jackfruit)
Annona muricata (soursop)
Annona squamosa (sugar apple)
Calliandra calothyrsus (calliandra)

B. Middle Canopy Species

Carica papaya (papaya)
Musa spp. (banana)
Citrus mitis (calamansi)
Flemingia macrophylla (flemingia)
Desmodium rensonii (rensonii)

Climbers

Psophocarpus tetragonolobus (winged bean)
Dioscorea alata (greater yam)
Dioscorea esculenta (lesser yam)
Pachyrrhizus erosus (yam bean)

C. Lower Canopy Species

Sauropus androgynus (Japanese malunggay)
Corchorus olitorius (jute)
Capsicum frutescens (chili)
Manihot esculenta (cassava)
Cajanus cajan (pigeon pea)
Zea mays (corn)
Pandanus odoratissimus (pandan)
Maranta arundinacea (arrowroot)

D. Understory Crops and Creepers

Ananas comosus (pineapple)
Zingiber officinale (ginger)
Colocasia esculenta (taro)
Adropogon citratus (lemon grass)
Sesamum orientale (sesame)
Foeniculum vulgare (fennel)
Ipomoea batatas (sweet potato)
Ipomoea aquatica (swamp cabbage)
Basella alba (basella)

Source: International Institute of Rural Reconstruction (IIRR). Silang, Cavite, Philippines.

Companion Plant Guide Chart

“Companion” plants have complementary physical and chemical demands. They will grow well together. “Antagonistic” plants have a negative effect on one another. Avoid planting them close to each other.

VEGETABLE	COMPANION	ANTAGONIST
<i>Abelmoschus esculentus</i> (ladyfinger)	sweet potato, swamp cabbage, squash, radish, pechay (<i>Brassica chinensis</i>)	
<i>Allium cepa</i> (onion)	lettuce, beets, tomato	peas, bean
<i>Allium sativum</i> (garlic)	carrot, lettuce, beets, tomato	peas, bean
<i>Apium graveolens</i> (celery)	cabbage family, tomato, bush bean	
<i>Asparagus officinale</i> (asparagus)	tomato	
<i>Beta vulgaris</i> (beets)	onion, garlic	pole beans
Brassicas (cabbage family)	potato, celery, beet, onion, garlic	pole beans
<i>Colocasia esculenta</i> (taro)	sweet potato, swamp cabbage	
<i>Cucumis sativus</i> (cucumber)	corn, pole beans, ladyfinger, cowpea, radish, eggplant	potatoes
<i>Cucurbita maxima</i> (squash)	bottle gourd, sponge gourd, bitter gourd, cucumber	
<i>Ipomoea aquatica</i> (swamp cabbage)	taro, sweet potato, cassava (<i>Manihot esculenta</i>), tomato, ladyfinger, corn, eggplant, amaranth (<i>Amaranthus gracilis</i>)	
<i>Ipomoea batatas</i> (sweet potato)	corn, cassava, ladyfinger, eggplant, pigeon pea (<i>Cajanus cajan</i>)	
<i>Lactuca saliva</i> (lettuce)	carrots, radish, cucumber	
<i>Lagenaria siceraria</i> (bottle gourd)	sponge gourd, bitter gourd, cucumber	
<i>Luffa cylindrica</i> (sponge gourd)	bottle gourd, bitter gourd, cucumber	

VEGETABLE	COMPANION	ANTAGONIST
<i>Lycopersicon lycopersicum</i> (tomato)	onion, lettuce, sweet potato, radish, swamp cabbage, squash, pechay, garlic, asparagus, carrots	potato, cabbage
<i>Momordica charantia</i> (bitter gourd)	lima bean (<i>Phaseolus lunatus</i>), hyacinth bean (<i>Dolichos lablab</i>), winged bean (<i>Psophocarpus tetragonolobus</i>), pole bean	
<i>Phaseolus aureus</i> (mungbean)	corn, sorghum (<i>Andropogon sorghum</i>)	
<i>Phaseolus vulgaris</i> (snap bean)	corn, carrot, cucumber, potato, cabbage family	onion, garlic
<i>Raphanus sativus</i> (radish)	beans, cucumber, lettuce	
<i>Solanum melongena</i> (eggplant)	beans, lettuce, sweet potato, swamp cabbage, squash, pechay, radish, pepper (<i>Capsicum annuum</i>)	
<i>Solanum tuberosum</i> (potato)	garlic, beans, corn, cabbage	cucumber, tomato
<i>Vigna sesquipedalis</i> (pole bean)	corn	onion, beet
<i>Vigna sinensis</i> (bush bean)	potato, cucumber, corn, celery	onion

Source: IIRR. International Institute of Rural Reconstruction. Silang, Cavite, Philippines

Crop Planning

Crop planning considers what, when, where and which plants to grow in relation to their requirements for space, sunshine, water, maturation, season of planting and tolerance for each other.

For a garden to give the maximum yield for the family, it should be kept planted all the time. Good planning is necessary.

Important Considerations in Crop Planning

1. Diversification

Grow different kinds of vegetables, trees and other plants in one area. Each plot must contain at least one of each of the following crop categories: leafy, legume, tuberous and fruit-



bearing vegetables. In this way, the nutritional needs of the family are being met. By growing a diversity of vegetables of different durations, the family is assured of the availability of vegetables throughout the year. This practice is also one way of checking pest outbreaks and certain intercrops serve the additional purpose of being insect repellents.

Rotation of each crop within each bed

Bed Subdivision	Planting Season			
	1st	2nd	3rd	4th
1	Leaf	Fruit	Root	Legume
2	Fruit	Leaf	Legume	Root
3	Root	Legume	Leaf	Fruit
4	Legume	Root	Fruit	Leaf

2. Crop Rotation

Different plants have varying rooting depths and so extract nutrients and moisture from different points of the soil profile. The cultivation of different plants in the same part of the bed from season to season does not overburden the soil. Also, each kind of plant takes away something from the soil, but also gives something back. By rotating the plants from one part of the bed to another, the land is allowed to rest from one kind of plant and the soil gets richer from the other plant that was put in its place. Crop rotation enables the land to “rest” without keeping it idle. Follow heavy feeders with heavy givers and then light feeders.

3. Intensive Planting

Use every bit of the area as many months of the year as possible. Close spacing is recommended to prevent the growth of weeds

and reduce the direct exposure of the soil to sunlight, thereby reducing moisture evaporation as the plant canopy serves as “living mulch.” Space plants closely, seeing to it that each plant has enough sunshine and space to grow. Plants are correctly spaced when the leaves of the fully grown plants barely overlap with the adjacent ones. This achieves maximum use of space and

higher yields per unit area, when compared with conventional gardening (plant in a triangular fashion). The seeds or seedlings are planted at each end of an imaginary triangle, with the sides of the triangle being equal to the recommended spacing. This portion allows more plants to be grown within a small area than the usual method of square or row planting.

Two Methods of Planting

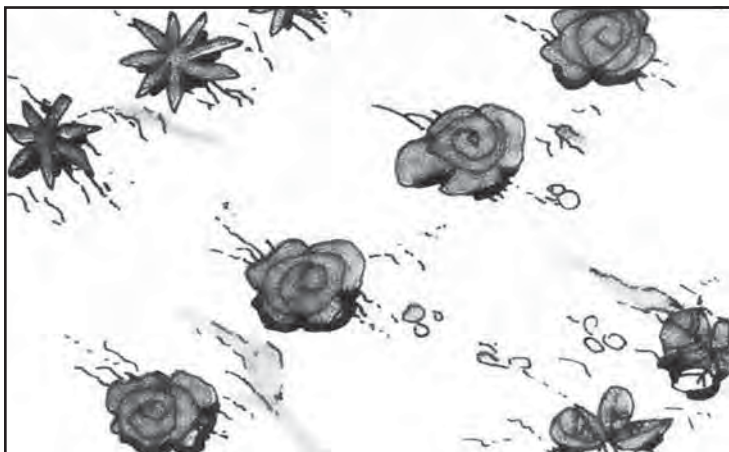

Row planting has more soil space exposed to sunlight which leads to rapid evaporation of soil moisture.

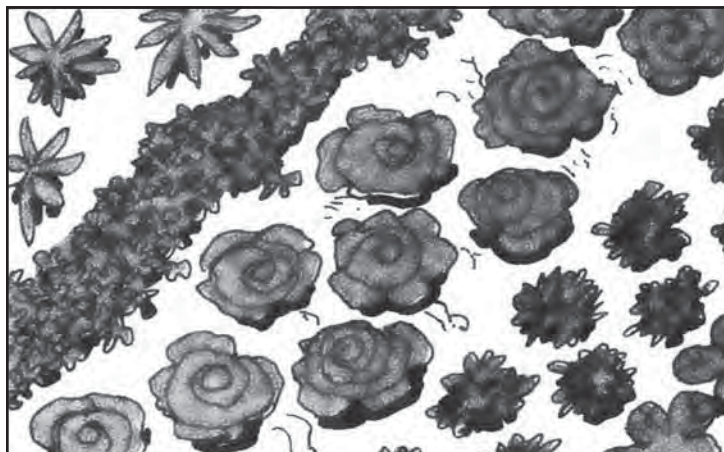

Thick canopy of plants reduces moisture evaporation and prevents weed growth.

Square planting

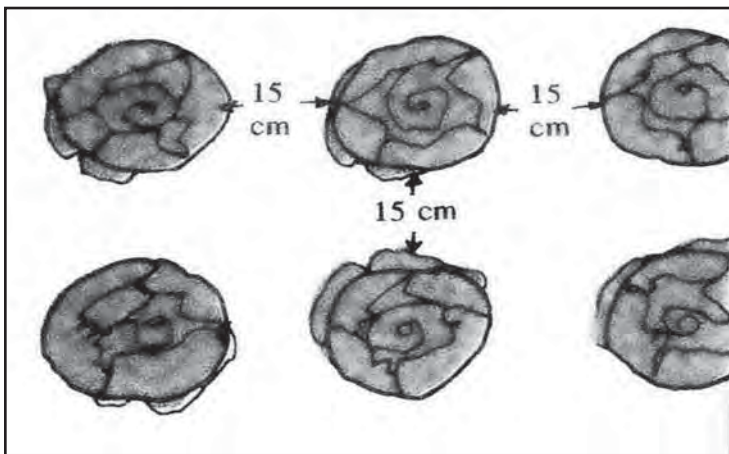

Triangular planting

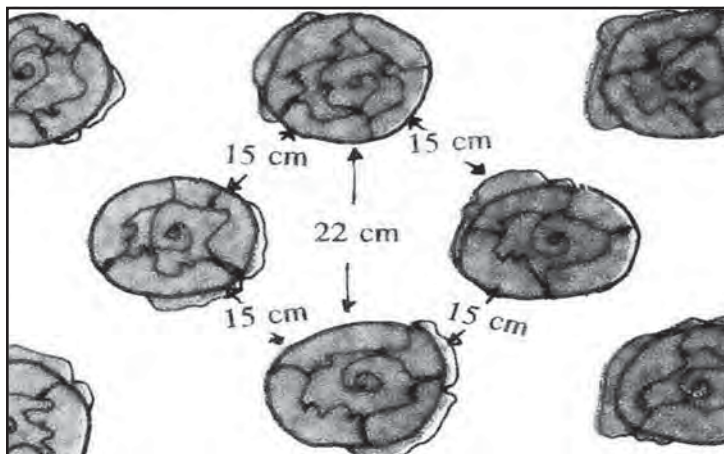

Triangular method of planting gives more plants per unit area.

Source: IIRR. International Institute of Rural Reconstruction. Silang, Cavite, Philippines

Shade-tolerant Vegetables

As plants are fitted together according to their various above-ground growth patterns, one should be aware of the plants' light and shade requirements so that they can benefit from the shade-light patterns and grow with minimum competition for light. Vegetables that grow best in the shade should be planted underneath larger ones.

SCIENTIFIC NAME	COMMON NAME	LIGHT REQUIREMENTS
<i>Zingiber officinale</i>	ginger	requires about 50% shade
<i>Colocasia esculenta</i>	taro	tolerates up to 50% shade
<i>Basella alba</i>	basella	requires partial shade
<i>Apium graveolens</i>	celery	requires partial shade
<i>Cucumis sativus</i>	cucumber	requires partial shade
<i>Lactuca sativa</i>	lettuce	requires light shade
<i>Brassica oleracea var. capitata</i>	cabbage	requires light shade
<i>Talinum triangulare</i>	Philippine spinach	tolerates light shade
<i>Daucus carota</i>	carrot	tolerates light shade
<i>Solanum tuberosum</i>	Irish potato	tolerates light shade



Source: International Institute of Rural Reconstruction (IIRR). Silang, Cavite, Philippines.

Drought-resistant Vegetables

SCIENTIFIC NAME	COMMON NAME	DEGREE OF RESISTANCE
<i>Voandzeia subterranea</i>	Bambara groundnut	highly drought-resistant
<i>Tylosema esculentum</i>	Manama bean	highly drought-resistant
<i>Arachis hypogaea</i>	peanut	highly drought-resistant
<i>Vigna sesquipedalis</i>	yardlong bean	highly drought-resistant
<i>Cajanus cajan</i>	pigeon pea	highly drought and heat-resistant once established
<i>Abelmoschus esculentus</i>	ladyfinger	fairly drought-resistant
<i>Vigna aconitifolia</i>	moth bean	most drought-tolerant crop grown in India
<i>Sorghum bicolor</i>	sorghum	highly drought-resistant
<i>Vigna sinensis</i>	cowpea	drought and heat-tolerant
<i>Solanun melongena</i>	eggplant	drought-tolerant
<i>Manihot esculenra</i>	cassava	drought-tolerant once established
<i>Dolichos lablab</i>	lablab bean	drought-tolerant once established
<i>Phaseolus lunatus</i>	lima bean	drought-tolerant once established
<i>Ipomoea batatas</i>	sweet potato	fairly drought-tolerant
<i>Amaranthus gracilis</i>	amaranth	fairly drought-tolerant
<i>Phaseolus aureus</i>	mung bean	fairly drought-tolerant

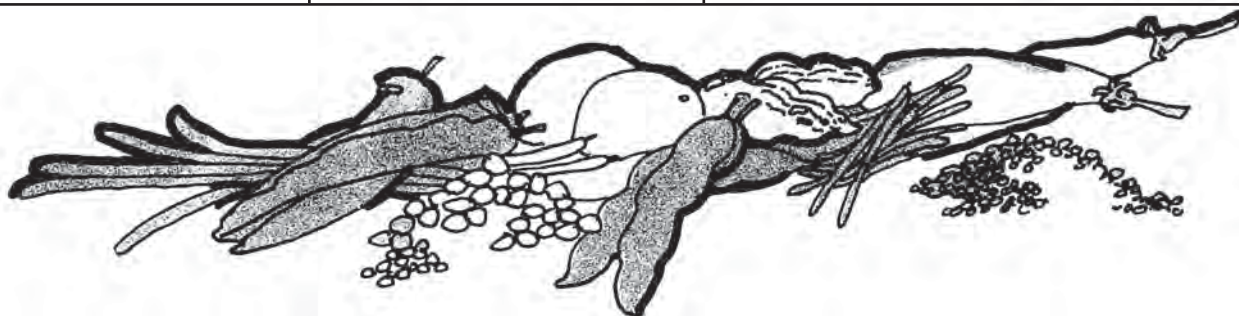

Source: International Institute of Rural Reconstruction (IIRR). Silang, Cavite, Philippines.

Common Garden Tools

The ease of gardening depends largely on the use of right tool in the right way. The proper tools will also make the work more productive.

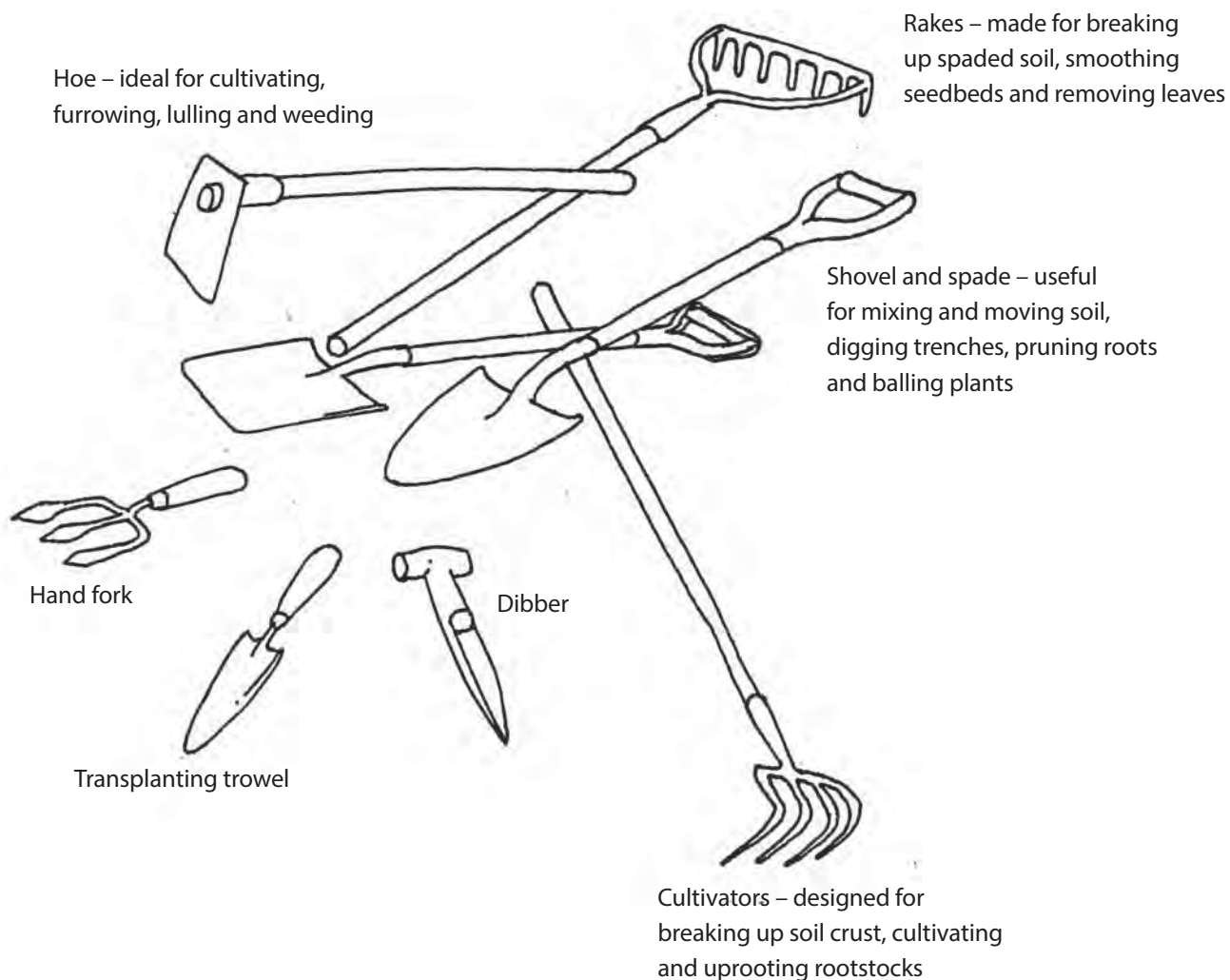

Source: *Regenerative Agriculture Technologies (RAT) Kit*. IIRR UNICEF for Philippine Department of Agriculture. 1989.

Nursery Techniques for Seedlings

Direct seeding is the most common method of sowing vegetable seeds. However, some vegetable seeds perform better if they are sown in containers or seedbeds initially and are later transplanted. Here are some basic steps in starting plants by this method:

1. **Select suitable container.** Planting in a seedbed is cheaper than using a container. However, using a container allows the gardener to choose the right medium for growing the seedlings. Any container deep enough to allow seedlings to root and wide enough to prevent their becoming cramped will do. Containers may be:

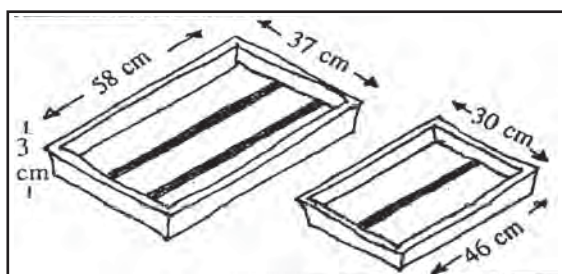

Seed Flats

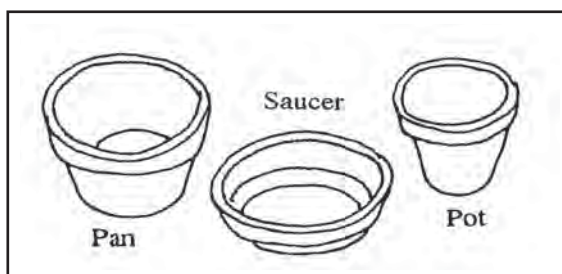

Clay seed-pans

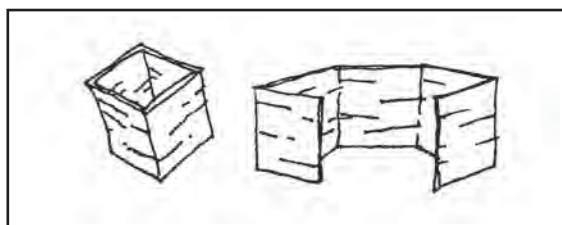

Plant bands/paper box

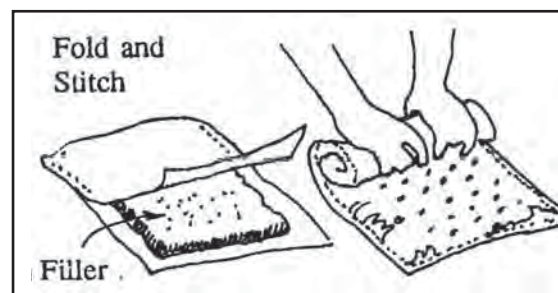

Rag doll

2. **Prepare container for planting.** Containers should be cleaned properly to ensure they harbor no fungus spores or insect pests. Adequate drainage should also be provided to avoid damping-off (soil-borne disease that destroys seedlings).

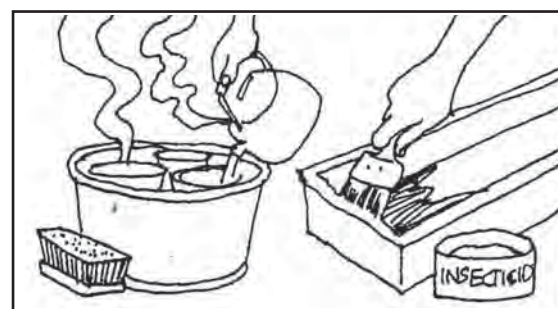

Cleaning containers

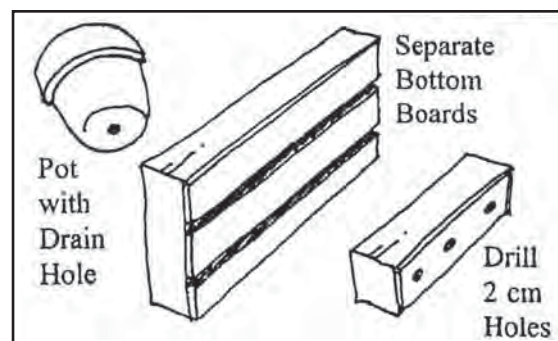

Providing drainage

3. **Prepare the soil medium.** The soil medium should be free of weed seeds, fungus spores and garden pests. It should be sufficiently porous to allow the delicate rootlets to penetrate and to admit air and moisture. Usually, a mixture of equal parts of sand, soil and compost is recommended, though a modified mixture can be made to produce a soil mixture that is more favorable for the growth of seedlings.

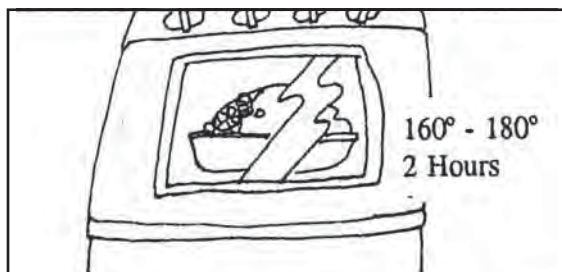

Sterilizing soil



Filling flat or pan

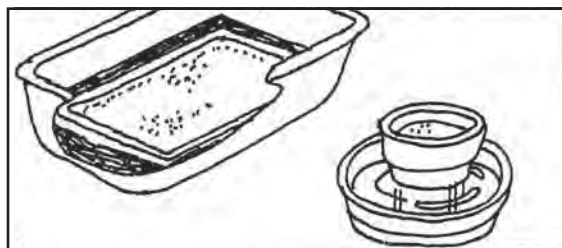

Watering

4. **Sow the seeds.** The manner in which seeds are placed in the soil depends largely on their size.

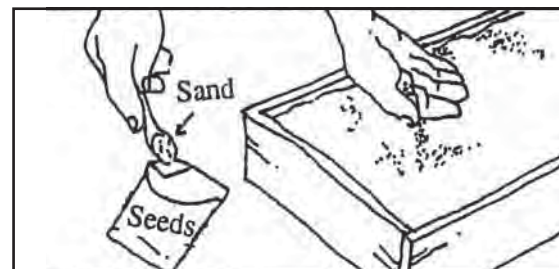

Fine seeds are usually broadcast together with sand.

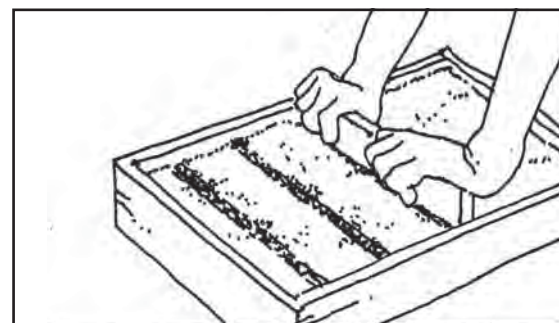

Medium-sized seeds are often sown in drills.

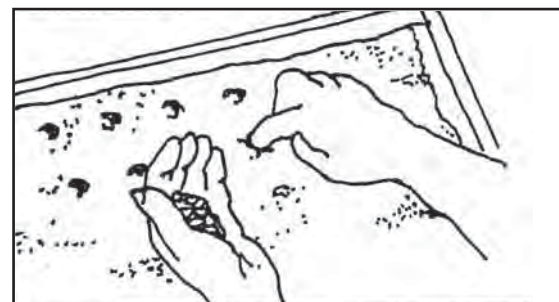

Large seeds can be poked in slightly with a finger.

5. **Cover the seeds.** Cover the seeds by sifting soil medium through a fine sieve held above the seed bed. Large seeds are covered to a depth equal to twice their width. Fine seeds are not covered but are merely pressed gently into the soil with a flat, level piece of wood.

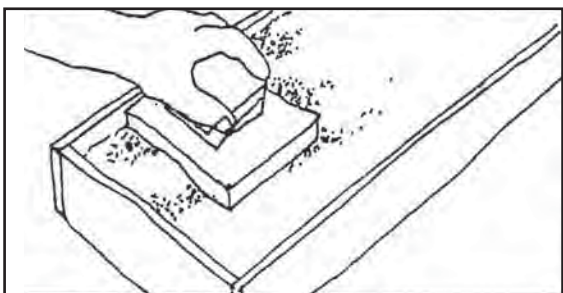
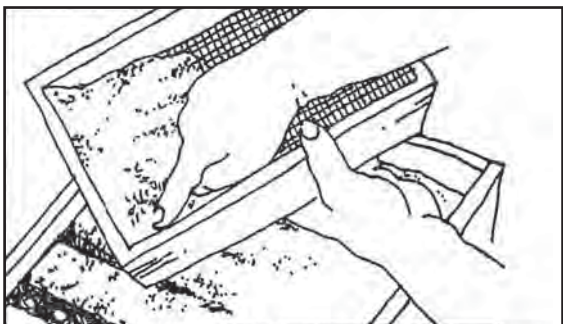

6. **Care for Germinating Seeds.** Seedlings should be protected from temperature fluctuations. Enough moisture and air circulation must be provided.

Dry soil can stop germination, but overwatering can encourage damping off. When watering is necessary, soak by immersion if possible.

It is advisable to set the seedbox in the open. If it is covered or is indoors, the seedlings may suffer from lack of moving air. The seedlings should continue to get some protection until the first true leaves emerge. When one or two sets

of true leaves become visible, the seedlings are ready for transplanting.

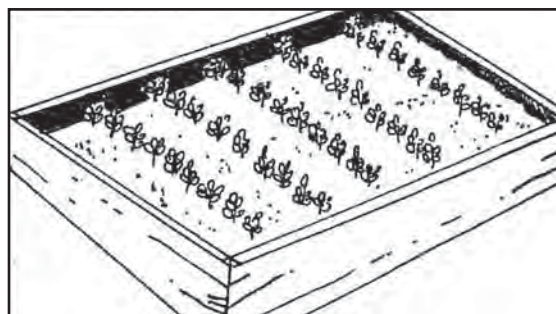

7. **Pricking/thinning** is the process of transplanting seedlings from the seedbox to another seedbox. This step gives the seedlings a chance to start development of root and leaf systems before the plants are left to fend for themselves in the garden. Seedlings should be pricked out as soon as they have two sets of leaves.

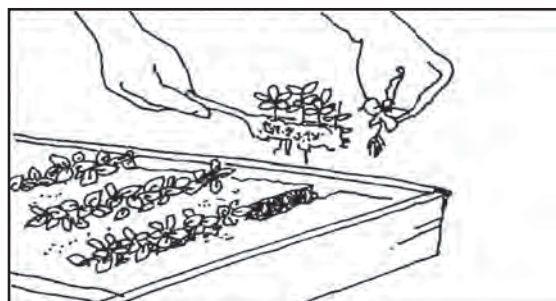

Use a sharp tool to help remove the plants so as not to injure them.

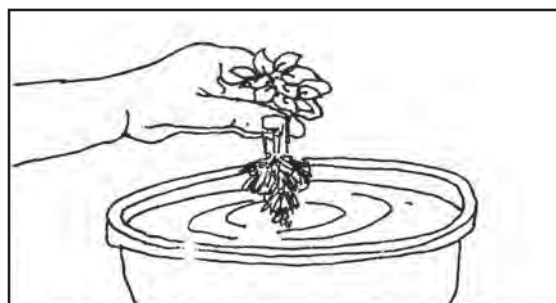

If seedlings conic up with their roots entangled, they can be separated by soaking the root ball in water.

Transplant the Seedlings. Punch holes in the seedbed with a dibble at two inches apart. Working quickly, insert the roots of the individual seedlings in the holes and firm them in with either the dibble or with forefinger and middle finger.

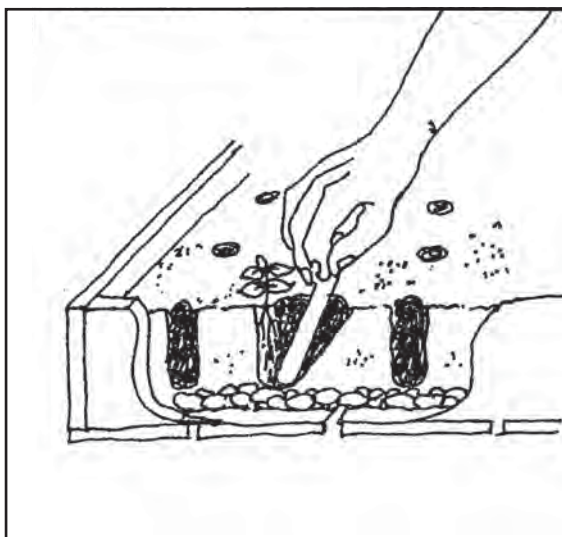

When the seedbox is filled, it should be watered with a fine spray from a hand syringe to settle the soil around the roots and to freshen wilted stems and leaves.

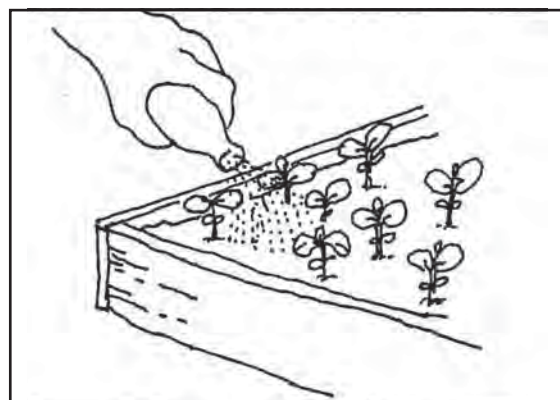

If plants are particularly soft and subject to wilting, cover the box with a sheet of newspaper or another box turned upside down.

If roots of a seedling are lengthy, they should be cut with shears or sharp knife. When the seedbox is filled, it should be

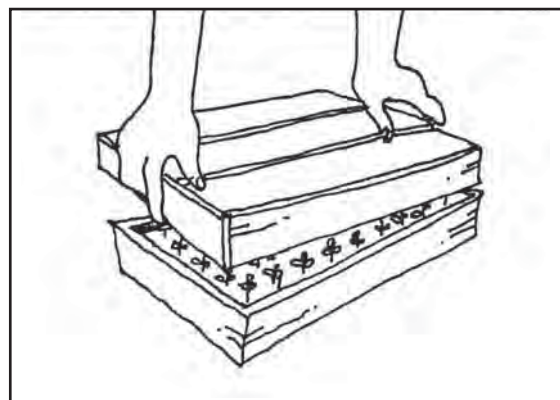
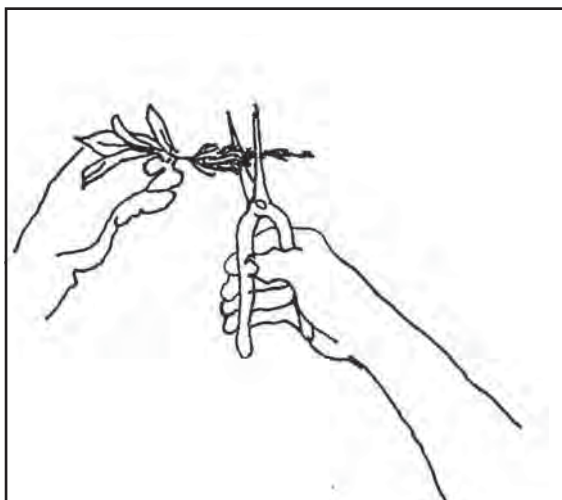

In about four or five weeks, the young plants will be ready to go out into the open ground. A week before transplanting, the plants should be hardened by gradually increasing exposure to sun and air. Before finally setting in the garden, the plants should be given several days of full sunlight; and if they are going into a sunny position, watering is also held back gradually before transplanting.

Nutrient Composition of Various Organic Materials

ORGANIC MATTER	% Nutrient Content		
	N	P	K
Animal Wastes			
Cattle	1.50	1.00	0.94
Water buffalo	1.09	0.82	0.70
Horse	1.59	1.65	0.65
Sheep	2.02	1.75	1.94
Pig	2.81	1.61	1.52
Rabbit	2.40	1.40	0.60
Chicken	4.00	1.98	2.32
Duck	2.15	1.13	1.15
Bat	1.00 -12.00	2.25-16.00	
Crop Residues			
Tobacco stein	3.70	0.65	4.50
Tomato stein	0.35	0.10	0.50
Wheat straw	0.49	0.11	1.06
Rice straw	0.58	0.10	1.38
Corn stover	0.59	0.31	1.31
Cotton stalks & leaves	0.88	0.15	1.45
Peanut roots	1.18	0.07	1.28
hulls	1.75	0.20	1.24
Cowpea stems	1.07	1.14	2.54
roots	1.06	0.12	1.50
Sugarcane trash	0.35	0.04	0.50
Banana skin (ash)	-	3.25	41.76
Banana stalk	-	2.34	49.40
N-fixing Trees (Leaves)			
<i>Leucaena leucocephala</i>	4.29	0.19	1.37
<i>Acacia ferruginea</i>	2.96	0.13	0.88

ORGANIC MATTER	% Nutrient Content		
	N	P	K
<i>Acacia arabica</i>	2.61	0.17	1.20
<i>Gliricidia sepium</i>	1.81	1.80	21.85
Green Manures			
<i>Sesbania acullata</i>	2.18	-	-
<i>Sesbania speciosa</i>	2.51	-	-
<i>Crotolaria juncea</i>	1.95	-	-
<i>Crotolaria usarmoensis</i>	5.30	-	-
<i>Vigna sinensis</i> (cowpea)	3.09	-	-
<i>Melilotus indica</i>	3.36	0.22	1.27
<i>Pisum sativum</i> (pea)	1.97	-	-
<i>Desmodium trifolium</i>	2.93	0.14	1.30
<i>Calopogonium mucunoides</i>	3.02	-	-
Water hyacinth	2.04	0.37	3.40
<i>Azolla sp</i>	3.68	0.20	0.15
Algae	2.47	0.12	0.37
Other Composting Materials			
Ground bone (burned)	-	34.70	-
Eggshell	-	0.43	0.29
Feathers	-	15.30	-
Molasses	0.70	-	4.50
Wood ashes	-	1.00 -1.50	1.00-3.00
Compost			
Municipal*	0.40-1.60	0.10 - 0.40	0.20 - 0.60
Garbage**	0.40-4.00	0.20 - 1.30	0.20 - 2.10
Garden	1.40-3.50	0.30 - 1.00	0.40 - 2.00

* Includes garbage, paper, household and yard trash

** Food wastes

Source: Regenerative Agriculture Technologies (RAT) Kit.
IIRR UNICEF for Philippine Department of Agriculture. 1989.



Organic Fertilizer Sources:

Basket Composting

Introduction

One of the first efforts of the Mindanao Baptist Rural life Center (MBRLC) in Bansalan, Davao del Sur, was to develop a gardening system which would provide vegetables throughout the year. It is called Food Always In The Home (FAITH) gardening. The FAITH Garden basically consists of three sections planted to:

- short-term vegetables (two to four months), e.g., tomato, sweet pepper, pechay, etc.
- medium-term vegetables (six to nine months), e.g., eggplant, winged beans, etc.
- long-term vegetables (throughout the year), e.g., kangkong, alugbati, etc.

The central feature of the garden is a series of raised garden beds in which bamboo baskets are set for the production of the so-called “basket compost”.

Basket Composting

Basket composting has been practiced at the MBRLC for many years and is proven to give the following benefits:

- You can directly use plant nutrients derived from rotting materials without waiting for the usual three to four-month period in the traditional method of composting.
- Your basket compost holds the composting materials in place; therefore, it will minimize nutrient depletion by runoff.
- Stray animals (like goats and pigs) and fowls (such as chickens and ducks) are prevented from scattering the compost materials.
- Your home and its surroundings will become cleaner because

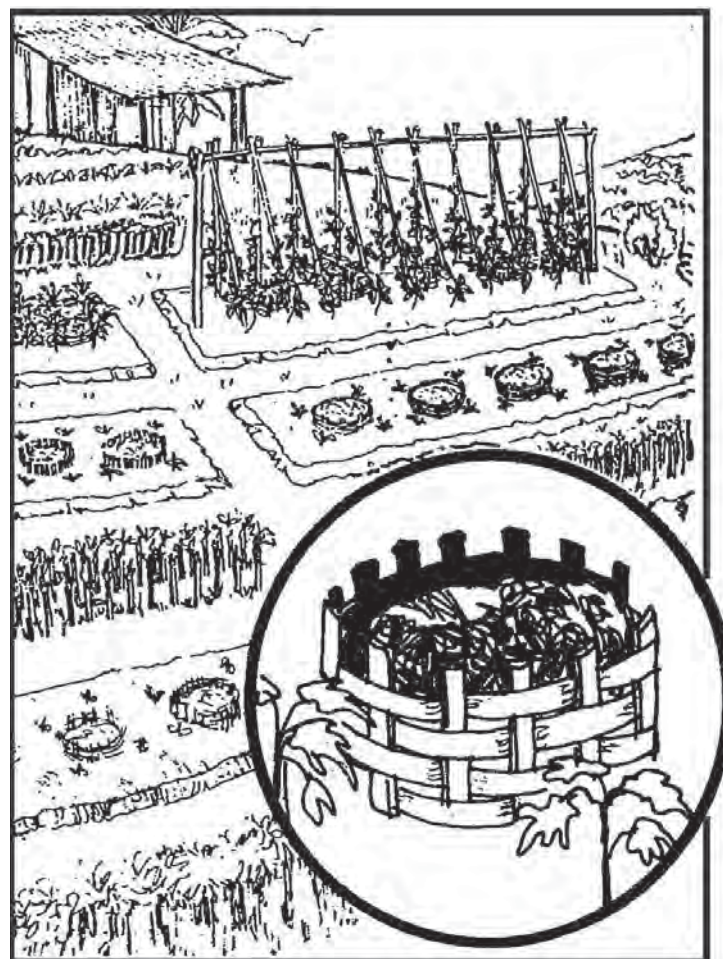

garbage and wastes are collected and are put inside the basket composts.

- It serves as reservoir and collector of the much needed moisture and nutrients for your plants.
- The organic matter in the compost strengthens the soil aggregate, making it resistant to heavy rainfall, thus lessening erosion.
- You can produce more nutritious vegetables at less cost.

1. Prepare the materials.

- Long bamboo strips (two to three m width)
- Bamboo stakes (at least 30m length)
- Home organic garbage, farm and garden wastes, leaves of ipil-ipil, kakawate, rensoni and/or *Flemingia* (if available)
- Dried manure (goat, duck, chicken, horse, and/or carabao)

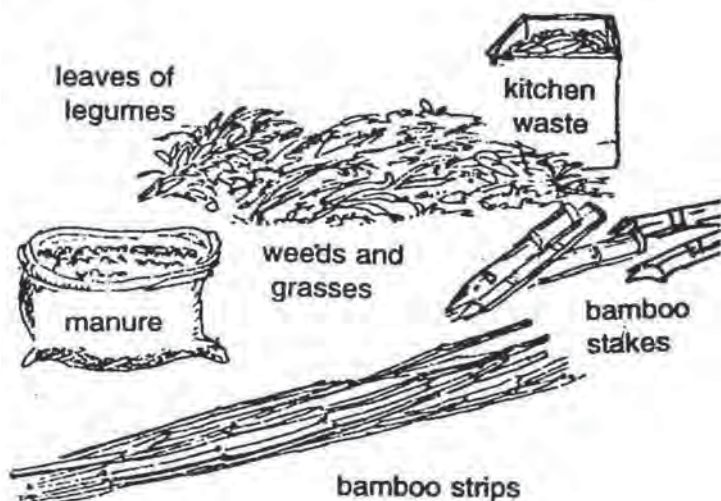

2. Prepare Garden Plots.

- Clean garden site.
- Save weeds and grasses for composting materials
- Prepare garden plot thoroughly.



3. Make Holes.

- Dig holes along the center of the plots at least 12 m in depth and 30 m diameter.
- Space holes 1 m apart.

4. Make the Baskets.

- Drive seven stakes around the holes; uneven number of stakes makes perfect brace for weaving.
- Weave the long strips of bamboo around the stakes to form a basket. Without bamboo strips, closely space the stakes (about 1 cm apart).
- Half-bury the baskets in the holes. The basket serves as erosion control and as container that prevents the chicken and other fowls from scattering the compost.

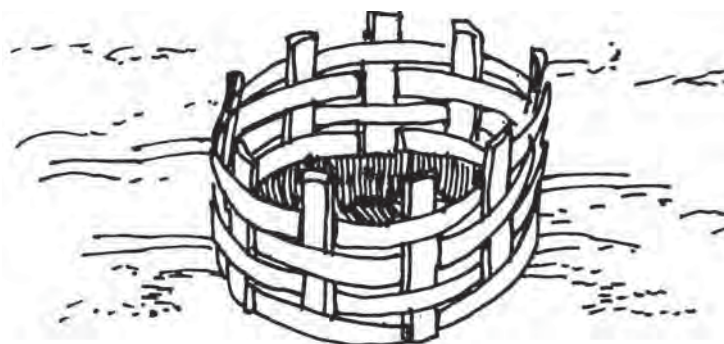

5. Put Organic Wastes.

- Place the rotting garbage and manure into the basket first.
- Fill to the brim with other organic wastes. Fresh manure can be used.
- Place the undecomposed materials like ipil-ipil leaves or any recommended leguminous leaves, grasses and weeds next, cover the organic wastes with a thin layer of soil.

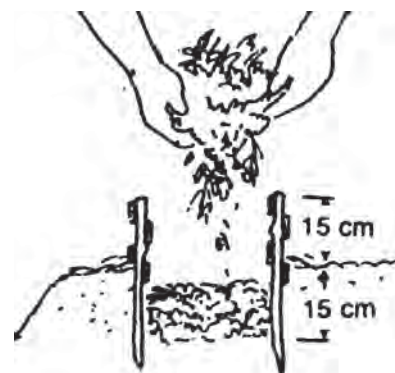

6. Plant Seeds or Seedlings.

- If the materials placed at the bottom part of the basket are almost decomposed (within 2-3 days), you can start planting seeds or seedlings. Plant them six to eight inches around the basket.
- If the composting materials placed in the baskets are green leaves (called “green manure”), plant the seeds or seedlings two to three weeks later. This will give enough time to start decomposing. If green leaves of ipil-ipil are used, put five kilograms of the leaves to the basket at the start. Add two kilos of leaves every two weeks.

7. Water the Seedlings.

- Water the newly transplanted seedlings. Later on, when they can grow on their own, just water the basket.
- Water only at the center of the basket, instead of watering the plants. The lower part of the basket is cool, moist and has abundant nutrients for crops. Later on, the roots will grow into the basket.

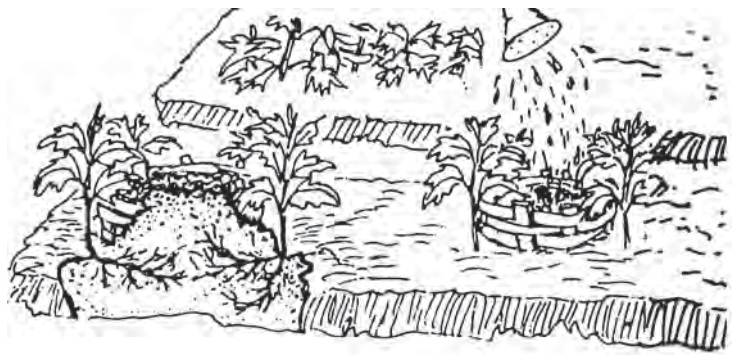

8. Incorporate Decomposed Materials.

- After harvesting your vegetables and your compost are used up, remove the decomposed materials and incorporate them into the soil while cultivating.
- Add new composting materials to the basket for the next plants. Avoid using diseased plants for composting. Use the basket while still intact.



Note: Basket composting is compatible with and can be integrated with the bio-intensive gardening technology.

Pot-garden Technologies

Containerized gardening is very appropriate in areas where space is limited. It is one of the important features in urban gardening. A lot of vegetable crops can be grown with their roots contained. They can perform as well as when they are in the ground.

A general potting mixture for most plants 1 part garden soil, 1 part coarse sand and 1 part compost. Whatever container is used, it is important that it drains freely – it should have hole(s). Enough coarse gravel should be placed in the bottom of the container so that the dirt will neither sift through the holes nor clog them.

Herbs and some leafy vegetables (shrubs) are best grown in pots:

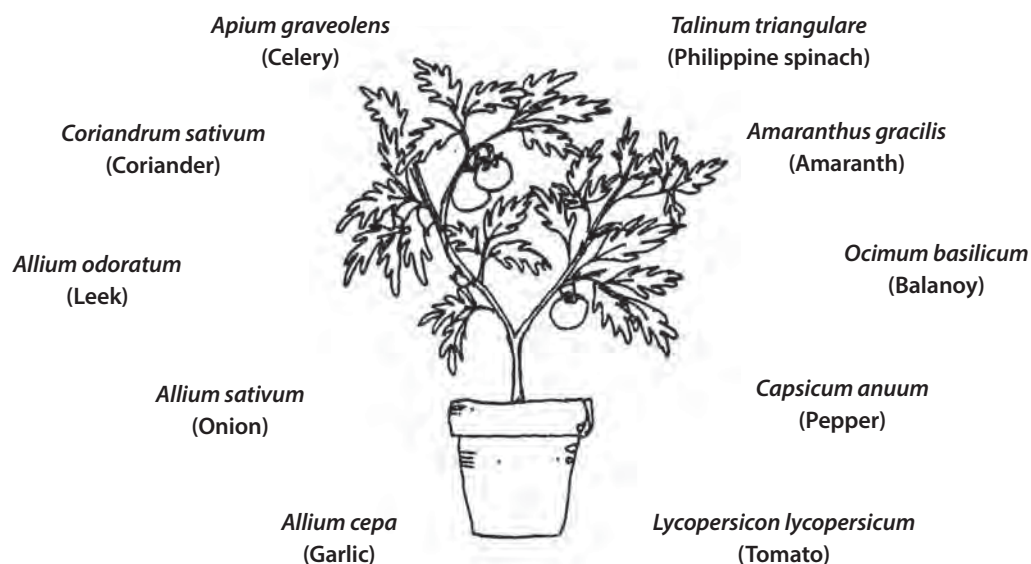

Productive vine crops can be grown in hanging baskets.

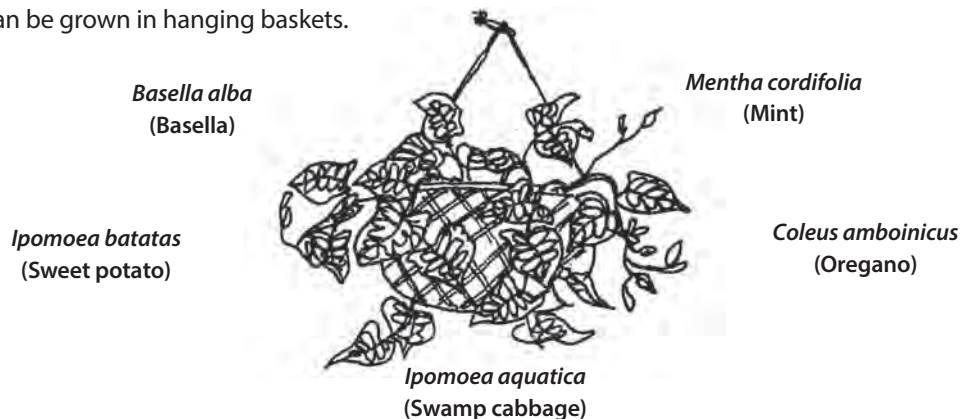

Source: *Regenerative Agriculture Technologies (RAT) Kit*. IIRR UNICEF for Philippine Department of Agriculture. 1989.

Seed Harvesting and Seed Extraction

Seeds should be carefully harvested to ensure high quality. The seeds should possess the qualities of the variety that was planted. For example, if a long, purple eggplant was planted, the harvested fruit should possess these qualities. Seeds from more plants should be harvested when the plant is cross-pollinated.

Seeds should also be harvested when they are already mature. Seeds that are overmature are not recommended since they might have already been infected with pests and diseases. Secondly, they are already weak because they are old. Seeds that are undermature will not produce good seedlings and usually do not germinate. Usually, for fruits that have lots of seeds (example: bottle gourd, sponge gourd, bitter melon, eggplant), the seeds that will be used for planting are collected or extracted from the middle portion of the fruit, where the maturity of the seeds is just right and the seeds are the same age. If earliness or lateness of fruiting is not one of your selection criteria, it is recommended to get fruits that ripen in the middle of the fruiting season.

To allow for losses during storage, germination and early growth, about 50% more seeds than needed for planting should be harvested. It is very important that the seeds are labelled after harvesting to avoid mixing up the seeds.

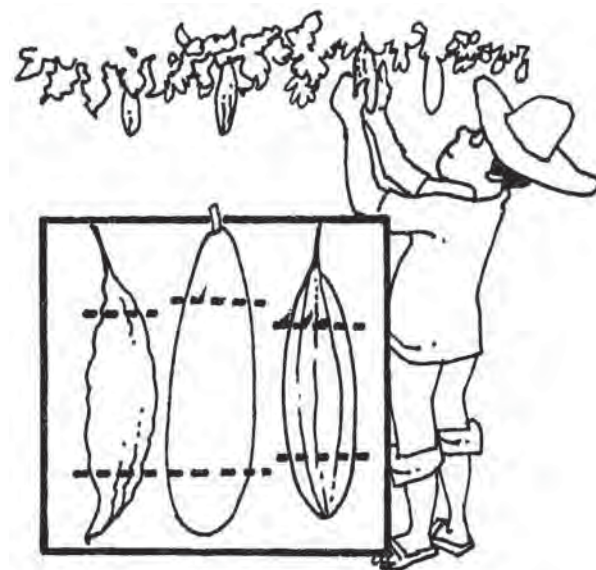

How to Determine if the Seeds are Already Mature

1. The fruit has a hollow sound.
Example: squash, watermelon, melon
2. Color, size and shape of the fruit
Example: tomato and chili (red); cowpea and other legumes (yellow to brown); eggplant (yellow)
3. Shattering of pods
Example: legumes
4. Fruit is disconnected from the branch.
Example: squash, watermelon, melon
5. Number of days – this depends familiarity of the farmer for the type of plant.

After-ripening

Some seeds improve their germination if they are allowed to stay inside the fruit for several weeks.

Example: squash, bottle gourd, sponge gourd



Seed Extraction/Cleaning

The extraction of seeds from the fruit depends on the condition of the fruit and seeds that will be harvested:

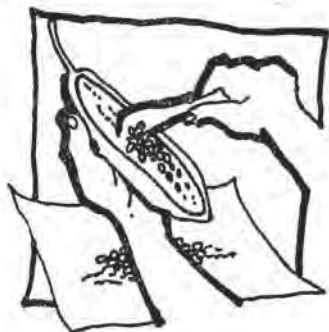

1. **Wet seeds from fleshy fruits** – The fruit and the seeds are both wet. Usually, the flesh is attached firmly to the seeds. Seeds are extracted using the hands or a knife. The fermentation process is sometimes done to remove the seeds. Soak the fruit in water for one to two days. After soaking, separate the seeds from the flesh, and throw away the flesh together with the seeds that float (except when the seeds naturally float). Sunken seeds are then washed and dried.

Example: eggplant, cucumber, tomato, bitter gourd, squash, sponge gourd, bottle gourd

2. **Dry seeds** – These are obtained or extracted from a dried fruit or pod. These are extracted by hand or pounded collectively while inside a sack or net bag. Pounding the seeds inside the bag is necessary to prevent them from scattering.

Example: cabbage, cauliflower, mustard, pechay, lettuce, pea, lima bean, cowpea, hyacinth bean, yardlong bean, pigeon pea, mung bean, onion.

If possible, do not harvest these seeds when it is raining or in early morning when there is still dew. Also, do not harvest at midday since the pods will break or shatter, allowing the seeds to come in contact with the soil and with microorganisms that lower seed quality.

3. **Dry seeds from fleshy fruits** – The ripe fruit is dried before extracting the seeds.

Example: chili, ladyfinger

For all kinds of seeds, winnowing or removal of contaminants after drying and before storage is recommended to maintain good quality. Contaminants include weed seeds, seeds of other crops or of different variety of the crop, chaff, dust and other inert materials like rocks, dirt, twigs and leaves.

Seed Production

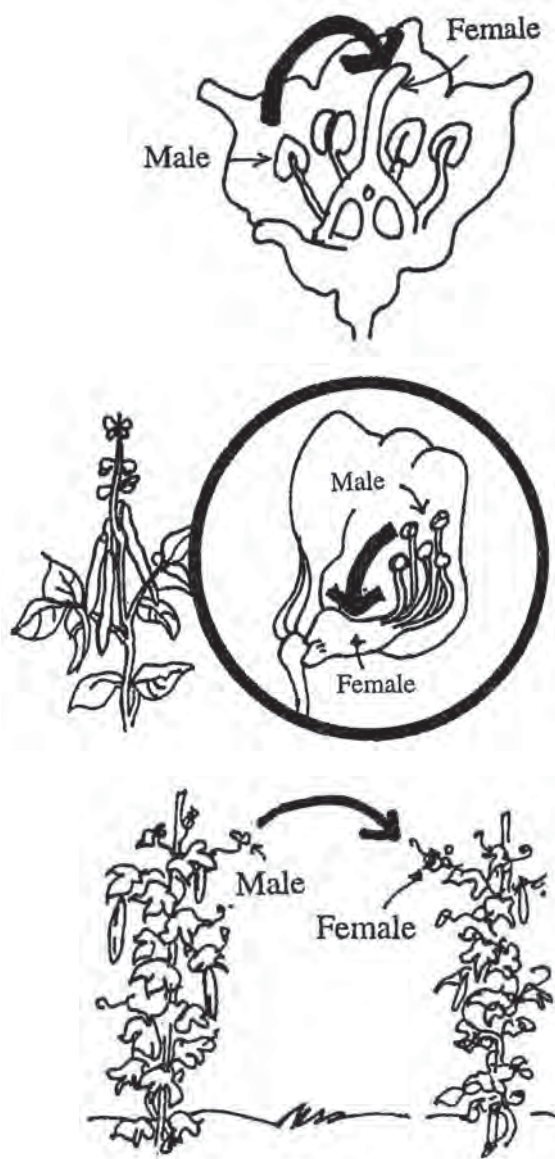

Seeds come from flowers. Plants have to be pollinated in order to produce seeds. The pollen, the fertilizing powder which comes from the male part of the flower or anther, is brought to the female part of the flower – the stigma or pistil.

Plants may either be self-pollinated or cross-pollinated. In self-pollination, the plant can produce seeds without another plant. The pollen comes from the same flower or from another flower from the same plant. Examples of self-pollinated plants are tomato, hyacinth bean, soybean, lima bean, mungbean, Baguio bean, pea, winged bean, yardlong bean, cowpea, water hyacinth and lettuce.

In cross-pollination, the pollen that will fertilize the plant will come from another plant. The plant cannot produce seeds if only one plant is planted because there will be no source of pollen. Examples of cross-pollinated plants are watermelon, melon, cucumber, squash, bottle gourd, sponge gourd, bitter melon, pechay, mustard, radish, onion and carrot.

Sometimes mixed-pollination occurs. A single plant may either self-pollinate or cross-pollinate, depending on the environmental conditions. Examples of mixed-pollinated plants are eggplant, bell pepper, chili, pigeon pea, cauliflower, amaranth and ladyfinger.

Source: *Regenerative Agriculture Technologies (RAT) Kit*. IIRR UNICEF for Philippine Department of Agriculture. 1989.

Seed Drying

It is necessary to dry moist seeds before processing and storing. Seeds with high moisture content are more susceptible to physical damage during processing. This reduces viability and encourages the formation of molds.

In addition, the germination of moist seeds that are stored can be severely reduced. In this condition, the respiration of the seeds and of the microorganisms present in and on the seeds may produce enough heat to kill the seed. Excess moisture favors infestation of insect pests. It also increases the respiration of the seeds, consuming the stored food of the seeds and resulting in weak seedlings. Seeds which are not well-dried have high respiration rates, causing them to rot. Usually, the moisture content of seeds after harvesting is high, especially when they are cleaned by washing.

If the air is humid, dry seeds absorb the water from air. If the air is dry, it absorbs water from wet seeds. This is why air-drying can dry wet seeds. This is also the reason seeds are stored in air-tight containers after they have been properly dried.

Things to Remember in Drying Seeds

1. Do not allow the seeds to come in contact with the soil or ground. This will prevent the seeds from getting in contact with soil microorganisms that will lower the quality of the seeds. Use a wedge so that the seeds can be dried above the ground.
2. Use a drying material with holes (example: sack, winnowing basket, mat) to allow air to pass through, giving fast, even drying.

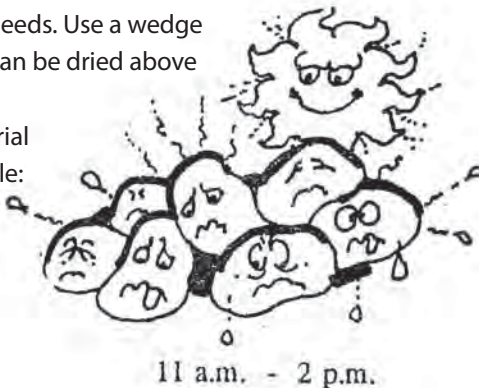

3. Do not dry the seeds rapidly because it will lower seed germination. Rapid drying can also harden the seed coat, making the seed impermeable to water when planted. If the initial moisture content of the seeds is high, air-dry the seeds in a shady area for one to two days before sun-drying. Do not dry seeds under the sun from 11:00 a.m. to 2 p.m. when the heat of the sun is intense because it will kill the seeds.
4. Spread the seeds thinly and stir and turn them occasionally (at least 4 to 5 times a day) to make drying fast and even.
5. Before it rains or gets dark, cover the seeds and take them indoors to prevent their moisture content from increasing.

How to Determine if Seeds are Well-dried

1. Seeds that were harvested dry have enough moisture content when they are dried under the sun for 2-3 days. If seeds were harvested wet or were washed before drying, 3-5 days sun-drying is enough after they have been air-dried for 1-2 days.

2. Seeds have distinct sounds when their moisture content is already low enough for storage.

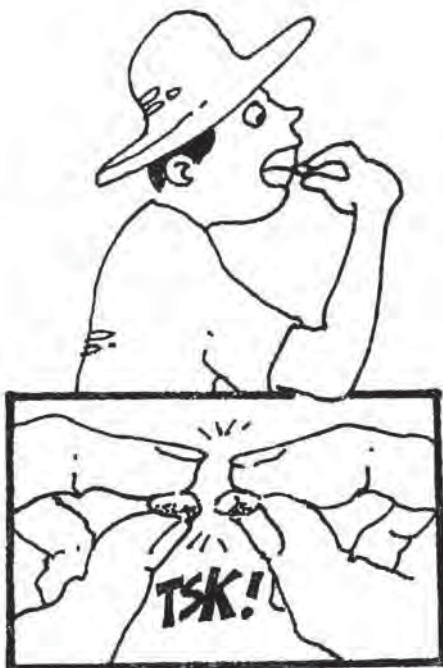

- a. Large, thin seeds will break with a “snapping” sound when twisted between the fingers.

Example: squash, bottle gourd

- b. Large, thick seeds will break with a “cracking” sound when bitten between the front teeth. Do not do this for very hard seeds because it might damage your teeth. Also, avoid

this if the source of the seeds is unknown since they might have been applied with chemicals.

Example: ladyfinger, cowpea

- c. Small seeds will break with a “cracking” sound when squeezed between the fingernails.

Example: mustard, pechay, amaranth

3. Seeds have a distinct tinkle when they are well-dried.

4. If possible, use an oven which can reach a temperature of 100°C or higher. Weigh the seed sample before placing it inside the oven. Weigh the seeds again after drying for 17-20 hours inside the oven. The lost weight indicates how much water was lost after the seeds have been dried. From these, the percent moisture content of the seeds can be computed. The seeds are dried enough for storage when they reach a moisture content of or less than 10%.

Example: Before oven drying - weight of seeds is 10 grams

After oven drying - weight of seeds is 9 grams

Lost water 1 gram

$$\% \text{ Moisture Content of the Seeds} = \frac{1}{10} \times 100 = 10\%$$

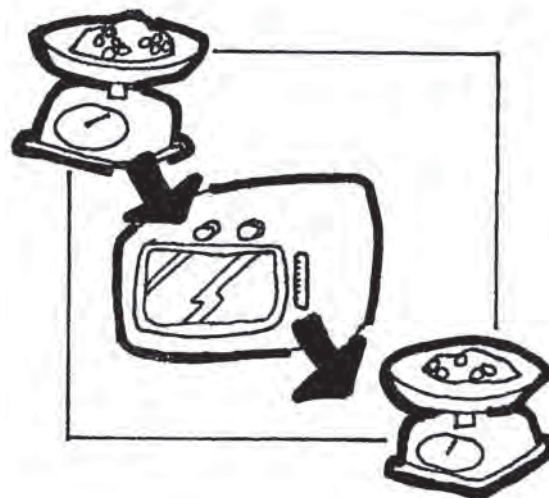

However, it is not easy to obtain an oven to determine the moisture content of the seeds so the practical methods above are recommended.

Seed Storage

The length of time that seeds can be stored depends on: (1) the seed type; (2) its quality; and, (3) the storage conditions.

Factors that Affect the Longevity of Seeds During Storage:

- 1. Moisture Content of the Seed** – Even if seeds are thoroughly dried, improper storage can still enable them to absorb water. To avoid damage caused by excessive moisture content, (1) store seeds in air-tight containers (bottle with tightly closed metal cover, tin can, sealed thick plastic); (2) keep seeds dry by including desiccants or materials that absorb moisture (example: dry charcoal, dry ash, toasted white rice, lime, silica gel) inside the storage container; and, (3) replace desiccants, such as dry charcoal, dry ash and toasted white rice, each time the container is opened. The moisture content of the seeds can also be kept low if the seeds are sun-dried from time to time.
- 2. Temperature** – The life of vegetable seeds during storage is prolonged when the storage temperature is low or cold (but not freezing). If a refrigerator or airconditioner is not available, choose a cold place (example: near the river, under trees, underground, inside a clay jar). Ensure that the seeds will not get wet.

As a general rule:

The life of seeds doubles when the moisture content is lowered by 1% or when the storage temperature is lowered by 5°C.

Example:

If the storage life of a seed with 14% moisture content is two years, its storage life can be prolonged to four years if the moisture content of the seed is lowered to 13%.

If the expected life of a seed is three years in a storage room with a temperature of 15°C, its life can be prolonged to six years if the storage temperature is lowered to 10°C.

- If both the moisture content of the seed and storage temperature are lowered, the increase in the life of the seed is greater.

Condition		Result	
Moisture Content	Temperature	Storage Life	% Germination
13%	30°C	1/2 year	50%
12%	30°C	1 year	50%
13%	25°C	1 year	50%
12%	25°C	2 years	50%
11%	25°C	4 years	50%
10%	30°C	4 years	50%

- 3. Pests** – Storage weevils, fungi and bacteria shorten the life of seeds during storage. Storage weevils begin to multiply when the moisture content is 10%. Fungi infestation becomes a problem when the moisture content is 13%. Bacteria become a problem when the moisture content is above 20%. To prevent pest infestation, choose only pest-free seeds during storage. Pest problems can also be prevented if the seeds are maintained dry. Materials that prevent or stop the growth and multiplication of pests can also be used. These are:
 - a. Dry ash and charcoal** – They absorb water inside the storage container. Ash prevents the growth and increase of weevils. Use one-half kilo of ash for every one kilo of seed. Use ash which has been cooled for at least 12 hours to prevent the seeds from burning.

- b. **Sand** – Mix the sand with the seeds and make sure that the storage container is full so that the weevils cannot move around.
- c. **Cooking Oil** – Some seeds can be mixed with cooking oil to prevent increase of weevil. The recommended rate is one teaspoon oil for every one kilo of seeds.
- d. **Lime** – In addition to absorbing moisture, lime can also prevent an increase in the number of weevils. Mix 15 teaspoons (about 50 grams) of lime for every kilo of seeds.
- e. **Dried and powdered leaves or seeds of different aromatic plants** – Weevils are sensitive to odorous plants which prevent their multiplication and cause their death. The effect of the plants depends on their preparation, the amount applied and the type of seed and weevils. Some of these plants can affect the seed so it is important to test what is appropriate for a certain kind of seed. Also, make sure that the right amount is applied.

- **Black pepper** – Mix 6 teaspoons (30 grams) of powdered black pepper (double the amount if powdered leaves are used) for every kilo of seeds.

Other plants which can be tried:

- **Powdered rhizome of turmeric** – Mix 4 teaspoons (20 grams) for every kilo of seeds.
 - **Powdered leaves of mint** – Mix 1-4 teaspoons (5-20 grams) for every kilo of seeds.
 - **Powdered seeds of yambean** – Mix 1-2 teaspoons (5-10 grams) for every kilo of seeds.
 - **Powdered leaves of lagundi, mango and tobacco** – Mix 1-4 teaspoons (5-20 grams) for every kilo of seeds.
4. **Other factors** – The storage life of seeds can become shorter if the seeds are overmature, if they came from plants that have been attacked by pests and diseases or if the seeds were damaged during seed processing.

Examples of Aromatic Plants

- **Neem** – Dry the leaves or seeds under the sun and grind them to a powder. Mix 3-4 teaspoons (15-20 grams) of powdered seeds (double the amount if powdered leaves are used) for every one kilo of seeds.
- **Hot pepper or chili** – Dried and powdered fruits are better than dried whole fruits. Mix 4-6 teaspoons (20-30 grams) of dried and powdered chili for every one kilo of seeds.

Labeling

Place labels inside and outside the storage container, especially when lots of different types of seeds will be stored. The following should be included in the label: (1) name of seed; (2) date harvested; (3) date stored; (4) date germination test was conducted; and, (5) percentage germination. If necessary, the characteristics of the plant and the seed should also be included.



Source: IIRR. 1993. *The Bio intensive approach to small scale household food production, Silang, Cavite, Philippines.*

Testing Seed Quality

Seed quality should be determined when buying seeds, selling seeds, giving or sharing seeds, storing seeds and sowing or planting seeds.

A. Seed Vigor

The strength or vigor of seeds, especially after exposing these to conditions of the storage room and planting area, needs to be determined. Weak seeds planted in poor field conditions will die, or the resulting plants will be susceptible to pests and diseases. Yields will, therefore, be low. Weak seeds will also not survive long during storage. In addition, even if a number of seeds have germinated, their rate or timing of germination and growth will be slow and not uniform. Determine seed vigor at the same time as measuring the percentage germination, in which seed vigor is the speed and uniformity of germination of the seeds. Compare the number, speed and uniformity of germination of the seeds being tested to those of good quality seeds. Seed vigor can also be determined by soaking the seeds in water. Usually, the seeds which float are weak.

B. Seed Health

Healthy seeds are free of pests and diseases which can kill or damage. They will not infect other plants and spread a disease. If a microscope is not available, examine the seeds carefully. Look for blemishes or stains in the seedcoat, molds, holes caused by insects or eggs of insects. These seeds might cause an epidemic or will introduce a new pest or disease and are, therefore, unfit for planting. Clean the seeds and remove diseased or infected seeds. Sometimes, a disease can be seen only after the seeds have been planted. Check if germinating seeds have fungi or bacteria (symptoms of infection: seeds are watery, shiny and have bad smell). It will also be helpful to know the place and the plant where the seeds were collected, especially for purposes of determining seed-borne diseases.

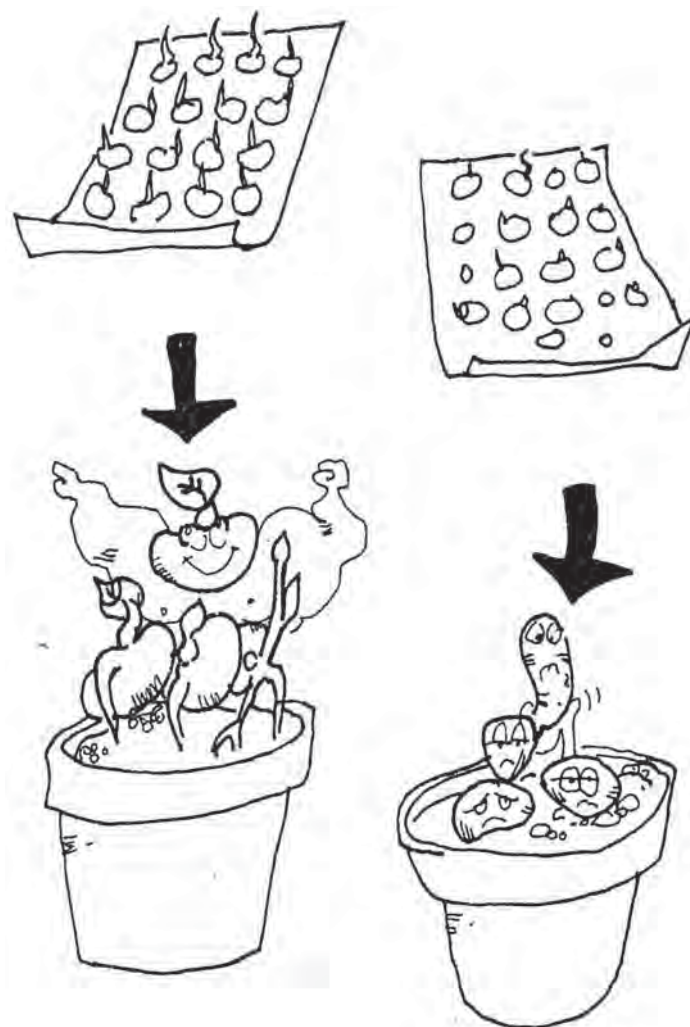

Many fungi and bacteria which can be killed by soaking the seeds in hot water (50°C) for 30 minutes. However, some pests and diseases cannot be killed by this method. Some tests on seed health are better conducted in the laboratory. If you think that your seeds have pests and diseases, have them tested in appropriate offices or agencies (example: Bureau of Plant Industry).



OR

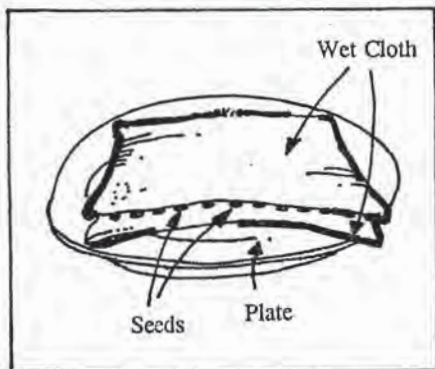

C. Seed Purity

Make sure the seeds you procure are the right ones or the ones as stated in the label. This can only be determined by knowing the characteristics of the seeds well. Also, determine whether there are contaminants in the seeds, such as dirt, stones, leaves or seeds of other plants, broken seeds and pests and diseases. The contaminants lower seed quality. If possible clean the seeds before storing or giving to others.

D. Moisture Content of the Seeds

The standard moisture content is 14% for seeds that are not oily (like ladyfinger and pechay) and 12% for seeds that are oily (like soybean, peanut, yardlong bean and mung bean). High moisture content decreases the viability of seeds.

E. Percentage Germination

Obtaining percentage germination gives an idea on whether the seeds should still be stored, planted or thrown away. This will also indicate the number of seeds to be planted to get the desired number of plants. You need a material which can absorb water. For large seeds, use river sand or clean soil (usually boiling water is poured on the soil before using to kill germs) as a germination medium. For small seeds, paper (example: filter paper, tissue paper) or cloth (example: cheese cloth) can be used as a germination medium. Arrange the seeds (not close together) in the germination medium and roll the medium like a mat, or cover with another layer of the medium. Water the seeds, but do not flood them. Place the medium with the seeds in a box or plastic bag which allows air to penetrate, or stand it in a container with enough water to be absorbed upwards. Do not place the medium in the sun or where it can be reached by rats or ants. After several days, count the number of normal seedlings (the ones which have the ability to continue growing normally and those which have normal leaves and roots). Calculate the percentage germination.

$$\% \text{ germination} = \frac{\text{number of normal seedlings}}{\text{total number of seed germinated}} \times 100$$

Example:

$$\% \text{ germination} = \frac{80 \text{ (number of normal seedlings)}}{100 \text{ (total number of seeds germinated)}} \times 100 = 80\%$$

The more seeds tested for percentage germination, the more accurate the percentage germination will be. If possible, replicate testing and use 50 or more seeds. You can then find the number of seeds to plant:

$$\text{number of seeds to be planted} = \frac{\text{desired number of plants}}{\% \text{ germination}}$$

Example:

$$\text{number of seeds to be planted} = \frac{160 \text{ (desired number of plants)}}{80\% \text{ (percentage germination)}} = 200$$

Do not store or plant seeds if their percentage germination is lower than 50%. These seeds will usually produce weak seedlings and will deteriorate rapidly, if stored.

There are instances when seeds do not germinate at once, not because they are dead, but because they are dormant or fail to absorb water (example: mung bean, winged bean). In addition, some temperate seeds (example: pechay, carrot, cabbage) absorb water but do not readily germinate, especially when they are new or fresh. Hard-coated seeds need methods that will open the seedcoat (example: rubbing in sandpaper, use of nailcutter or chipping with a knife). Take extra care in preventing embryo damage. You can also soak the seeds in hot water for 3-10 minutes (1 part seed for every 10 parts water) or in boiling water for 1-10 seconds. The duration of soaking depends on the type of seed and the age of the seed. Seeds which are old, hard and easily absorb water should be soaked for a shorter length of time compared to seeds which are young, soft and do not easily absorb water. Seeds usually grown in cold areas can be placed in the cold for several days while in the germination medium before transferring them to a planting area.

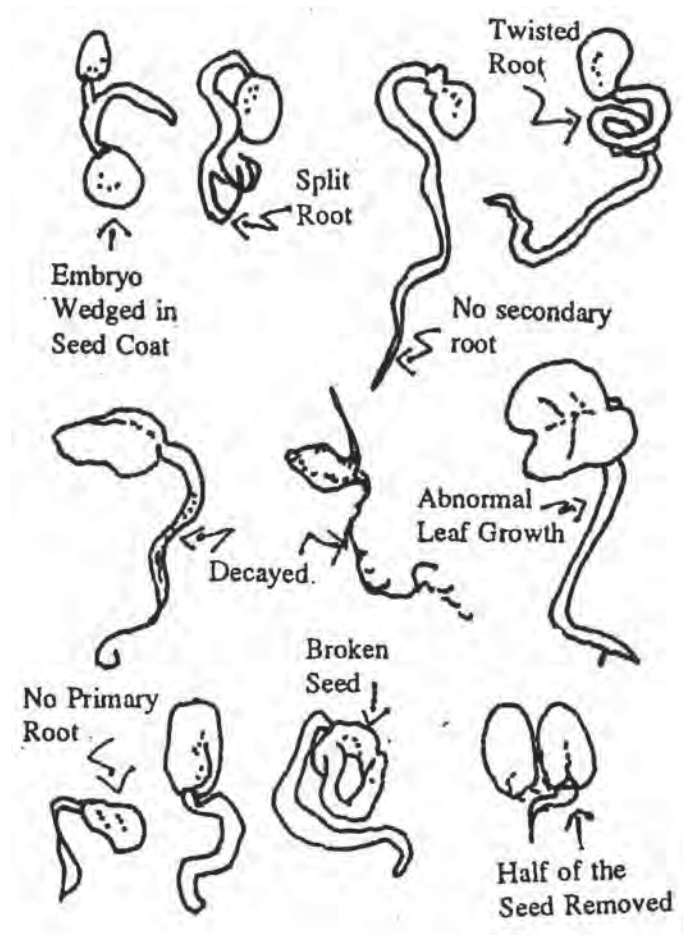

Saving Seeds through Gardener Curators

The consciousness today about genetic resources and their importance to humankind is at an all-time high. Discussion has focused specially on the loss of traditional varieties, or “genetic erosion” and the control of germplasm by vested groups or companies. Varieties are being lost as they cease to be cultivated. There is a call to search out and retrieve these vanishing resources if not for any other reason than for preservation, the same way a curator in the museum preserves heirloom cutlery. Finally, traditional varieties are sources of useful genes concerning special qualities such as resistance to diseases or drought. Such genes are invaluable in breeding new cultivars.

Tomorrow is Late

Unfortunately, conferences and workshops, do not save seeds. Despite the many meetings and papers on the topic of genetic erosion, action efforts to save seeds are sadly lacking in quality and impact. Historically, the best conservers of seeds have been small farmers and backyard gardeners, but programs to conserve seeds at their level are sadly lacking. Meanwhile, every day, the seed heritage slowly but steadily diminishes.

The Gardener or Small Farmer as Curator

Non-government organizations and others interested in saving seeds in situ (as opposed to storing them in laboratories) need to address this issue with a sense of urgency and through field-level and farmer or gardener-involved interventions.

The concept of a farmer/gardener curator is valid because the seeds used by the majority of today’s farmers in developing countries have been handed down by generation of farmers. When planted out every year, these varieties continue to evolve and adapt to the changing environment. These same seeds,

stored in conventional low-temperature seed storage facilities, just remain dormant, and their characteristics remain unchanged they do not evolve any further. In fact, varieties stored this way, if planted many years later in the field, may not be able to withstand the changed environment in the place they were originally collected.

Many traditional varieties do not meet the criteria and standards of today’s consumers and so are not planted commercially even if they have superior nutritional, taste or storage qualities. One example is the bitter gourd. A favorite of Filipinos, improved varieties of this crop are superior in production and of larger individual size but are dependent on chemicals. Other varieties do not have synchronous harvests and so are getting lost. An example is the araw-araw (“daily”) eggplant, so called because it provides a few eggplants every day compared with the improved varieties that come to harvest at a peak time and so are preferred for marketing.

Many traditional vegetable cultivars have multiple uses. A good example is the winged bean which produces a tasty and nutritious pod and has edible flowers and tubers. Unfortunately, many of the tuber-producing cultivars are rare and can only be found in remote areas such as Papua New Guinea.

The potato yam is another crop which is steadily getting lost. Even though it produces both aerial and ground tubers on the same plant, this is not enough to ensure its survival for the next generation of farmers.

The list of cultivars that have special qualities is long: cherry-sized tomatoes which can be grown in the rainy season with no fungal problems (as many as 1000 fruits can be harvested in the life of this cultivar), the mung bean with hairy leaf surfaces that keep most insects away and the deep-rooted leafy amaranths that can go for as long as six weeks in summer with no water and no wilt symptoms.

These qualities do not often make a difference to the consumers of marketed vegetables, who look for good size more than anything else. The bigger the better is the norm! In fact, most farm produce in exhibitions and competitions use size as a major criterion in crop judging. Is it not ironic when miniature vegetables in the West fetch the highest prices, but developing countries prefer the longest, heaviest, largest products? Why this obsession, when we know that eventually these are going to get cut down into small pieces to be eaten?

The emphasis on producing seedless products is another example of how preferences have changed over the years. The seedless grape and the papaya with just a few seeds in each fruit are examples.

But, finally, the most important factor is how our technicians and extension workers perceive the growers of such indigenous cultivars. If they treat farmers as primitive or outdated in their thinking and choice of varieties, then the farmers will have a poor self-perception and image. Unless an effort is made to give these traditional cultivars a new image, they will gradually be neglected by the farmers themselves. When that happens, all is lost for the cause of seed conservation.

The greatest opportunity for conserving such varieties is by reintroducing them for use in gardening programs -- in backyards of farm households, in urban gardens or in school areas. These gardens are raised primarily for family use and nutrition for school children. The special qualities of traditional cultivars, their hardy nature, prolific seed production, high nutritional value, well-distributed fruiting periods (as opposed to peak production), shade tolerance, etc., all make them especially useful for these programs. What is also important to realize is that their yields do not have to be low because, if combined with improved crop husbandry techniques such as the bio-intensive technologies, their output per unit area could compare favorably with the output, using conventional technologies and chemicals. Such gardens can consist of a great diversity of crops: a typical bio-intensive garden area of 200 sq m can contain as many as 30 selections. Isn't that biodiversity also? While biodiversity often

refers to natural forest ecosystem, we can create this in garden spaces and backyards as a conservation strategy. Of course, they will not have the looks of a neat garden with distinct rows and clean space between rows.

How Does One Get Started if There Are No Traditional Varieties in the Area?

Most developing countries still have a vast selection of materials to collect, if one knows where to look for them and what to look for. Where modern agriculture has been aggressively promoted, these genetic resources will still be around but often growing only in remote areas in backyards or in intercropping systems, or often as weeds. However, the way to ensure success is to focus the seed retrieval and collection missions in areas away from the beaten tracks and asphalt roads. It is less likely that seed merchants will have reached these places. Ethnic groups in most countries are especially important communities from whom to collect seeds. Often, these groups continue to grow old cultivars because they have not been exposed to extension agents or for cultural reasons (in defense of their cultures) have been resistant to change. The most diverse collection of planting materials can be found in the remotest areas.

One has to time one's visit to ensure that seeds are ready for collection. Usually, the three to four months immediately preceding the summer season are ideal times for legumes and other vegetables. The end of summer is the best time to select drought-tolerant vegetables: just look for unirrigated areas where the crops have survived through the summer season. Market days are excellent opportunities for seed collection, especially in those parts of the world where small quantities of seeds are traditionally sold by farmers in the weekly market. If seeds are not available, these market days are good for acquiring produce from which seeds can be extracted. In the case of legumes, these can be bought from traders dealing with dried legumes--though germination is inevitably a problem with this method of acquiring seeds.

One of the most efficient ways to collect the greatest diversity of seeds is to get in touch with local schools in remote areas and through the authorities, launch an effort for seed retrieval through children. Finally, a consortia of NGOs in a country can be used for seed retrieval and subsequent exchange. NGOs working with fanner organizations can use their infrastructure to collect planting materials and seeds.

Common Problems Faced by Seed Collectors

The amateur seed conservationist will find the seed-saving idea a lot more complicated than when he or she anticipates. The problems of categorization, outplanting, characterization, storage and quality control are all essential to a systematic effort; yet, they are time-consuming and, unfortunately, require financial resources.

The NGO or amateur conservationist will first have to limit the collection based on priorities, e.g., vegetables, cover crops, trees, fruits or rice. It is a common mistake to try to collect everything because it soon becomes overwhelming, difficult to manage and expensive. With cooperation, it is conceivable that each NGO could focus on one crop and then exchange the collected and tested materials with other partner NGOs.

The planting-out of collected seeds is another important step -- probably the most expensive. Human labor is needed for this, as long as the crops are in the field. Seeds must be planted and observed for two to three seasons to ensure that the characteristics (e.g., planting season, flowering habits, pest susceptibility, etc.) can be recorded. Here we are not talking of sophisticated data but very simple but essential information without which the gardener or farmer receiving the seeds could get the wrong conclusion, i.e., indigenous varieties are not good. Many traditional varieties are season-bound and, if planted in the wrong season, give very poor results. Others do badly if fertilized and do well only under low fertility conditions.

The collection of seeds is labor-intensive and time-consuming. The next step, that of drying and then depodding or cleaning, is also labor-intensive. However, all activities mentioned so far can be easily learned and require systematic effort rather than expertise.

The storage of seeds and maintenance of viability is probably where the most problems will occur and where guidance from a seed technologist in the design of a technical strategy is important. Seeds can be dried too much or not enough. They can get infested with fungus while in storage, affecting their viability, or the seedlings can be damaged soon after germination. The seed moisture content in storage is the single most important factor. But the storage temperature and humidity often critical determinants of how successful the seed production effort has been.

The importance of labeling seed packets with information on the place of origin, local name and the date of collection cannot be over emphasized. Any observations from the gardener or farmer will be very helpful in future characterization of accessions, e.g., some cultivars store better than others, an important characteristic of old cultivars of beans and a trait lost in the new varieties. If this information is not recorded one might not know it by observing plants in the field. Another attribute of traditional legumes that farmers know well and use to describe their collections is the versatility, for instance, some legumes can be sold as green vegetables but are also equally good as dried legumes. This knowledge is best collected from the original growers themselves.

An institutional effort to conduct seed collection missions is justified (as opposed to farmers collecting the seeds from their own area for in situ conservation) if seeds are rare and must be brought from other parts of the country and exchanged in order to reinstate the original diversity and variability. But such efforts are only useful and relevant if the seeds collected, tested and multiplied are returned to the communities for them to plant, try out and conserve. The sooner the materials are moved out, the better. The ideal approach is to give farmers a diversity from within each crop, e.g., six kinds of mungbeans, so they can choose from

a range. Some retain what others will not. So somewhere in every village the materials will get preserved.

Unless the program is backed up with an elaborate conscientization strategy, one should not expect farmers to understand the philosophical or aesthetic dimensions of genetic resources conservation program. Their agenda may be different from that of the organization: they conserve the varieties for a host of reasons, the last of which may be conservation for conservation's sake. So, the idea of getting growers to continue to raise seeds only for purpose of saving them, as is being done in some Western countries, is a bit unrealistic. There is need to focus on seed accessions whose attributes will in themselves result in their being conserved. The genetic resources agenda then become a hidden one and need to be integrated with other activities, such as family food production through improved agricultural technologies for farms and gardens, or health and nutrition interventions.

It seems clear that conservation will not result from workshops on the topic of genetic erosion, even as we admit these are important at certain stages of the campaign. Nor will it result only from storing seeds in national or international germplasm banks, because of the need for these plants to continue their process of evolution and adaptation. Seed conservation is everybody's concern and not an activity limited to geneticists and breeders.

We still have time to do something about this--only if we start today.

Some Common Garden Pests

1. Aphids



Sucking insects attacking the leaves and stems. When attacked, the leaves and stems of the plants begin to look pale and spindly. Aphids can change color to match plant parts and metamorphose from nymphs to adult, both with and without wings. When the aphids in one plant get overcrowded, they develop wings and fly to another plant host of the same plant family. Aphids mature in 12 days.

2. Borers



Boring insects attacking the flowers, pods, stems and roots. Borers hatch, eat and grow inside plant part as caterpillars. The presence of borers is indicated by the sudden wilting of plant tops

3. Bugs

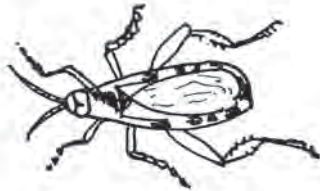

Sucking insects that attach to plant parts and drain plant juices. In case of mealybug, eggs are laid in white, cottony masses. Young are crawlers like scale insects. Bugs excrete large amounts of honeydew that attract ants and encourage black mold fungus.

4 Beetles



Chewing insects which feed on leaves, flowers, stems and even roots. They feed on most vegetables. Severe infestation can defoliate plant.

5. Caterpillars/Worms



Chewing insects usually developing from patches of eggs on the underside of leaves. The larval stage of moths and butterflies, caterpillars feed on foliage and tender stems.

6. Flies



Some are tiny sucking insects that hatch and live mostly on underside of leaves. In case of white flies, stationary scale-like nymphs do most of damage, sucking juices and excreting honeydew, thereby attracting ants and encouraging fungus growth.

7. Hoppers/Katydid



Feed on foliage of many plants. Grasshoppers are most often found in late summer when fields next to gardens become dry. In severe infestations, large plants may be defoliated. The tender bark may be stripped from trees and shrubs.

8. Scale Insects



Small insects, covered by protective shells, that attach themselves to stems and under surfaces of leaves and suck out plant juice. Generally, they are able to move about in younger stages, but become stationary or nearly so in adulthood.

9. Slugs and Snails



Slimy trails and tattered foliage indicate snail and slug invasion. In daytime, they can be found under rocks, leaves, densely foliated plants, boards or any object that rests on the ground. At night, they can be found busily feeding on plant parts.

10. Root-Knot Nematodes



Microscopic worms that either stick their heads on a plant to suck the sap or actually spend their lives inside the plant. They attack roots of various plants and form galls or root knots. Infested plants wilt or die due to the inability of the damaged root systems to supply enough water to their tops.

Name of Pest	Target Vegetables
Aphids <i>Myzus persicae</i> (Green peach aphid)	celery, crucifers, cucurbits, potato
<i>Aphis gossypii</i> (Melon aphid)	cucurbits, sweet potato, taro
<i>Aphis craccivora</i> (Bean aphid)	beans, cucurbits, peanuts
<i>Toxoptera auratii</i> (Citrus aphid)	cucurbits, citrus
Borers <i>Maruca festualis</i> (Bean pyralid)	beans
<i>Estiella zinkenella</i> (Bean pod borer)	beans
<i>Apomecyna historian</i> (Vine borer)	cucurbits
<i>Manilaboris cucurbitae</i> (Cucurbit boring borid)	cucurbits
<i>Mimegralla coeruleifrons</i> (Ginger root borer)	ginger
<i>Zeuzera coffeae</i> (Coffee carpenter moth)	ladyfinger, coffee
<i>Phthorimaea operculella</i> (Potato tuber moth)	potato
Bugs <i>Ferrisia virgata</i> (Gray mealybug)	cassava, sweet potato
<i>Phenacoccus hirsutus</i> (Pineapple mealybug)	cassava
<i>Physomerus grossipes</i> (Sweet potato bug)	pineapple, corn, taro
<i>Cyclopelta obscura</i> (Dapdap bug)	cucurbits, sweet potato
<i>Nezara viridula</i> (Green soldier bug)	cucurbits
<i>Acanthocoris scabrator</i> (Coreid bug)	solanaceous crops, sweet potato

Name of Pest	Target Vegetables
<i>Malcus flavidipes</i> (Lygaed bug)	sweet potato
<i>Planococcus lilacinus</i> (Cottony sushion mealybug)	ladyfinger, taro
Beetles <i>Leucopholis irrorata</i> (June beetles)	corn, peanut,
<i>Monolepta bifasciata</i> (Corn silk beetle)	corn, ladyfinger, taro, yam
<i>Sylepta derogata</i> (Leaf-eating caterpillar)	ladyfinger
<i>Hyposidra talaca</i> (Measuring caterpillar)	ladyfinger
<i>Epilachna philippinensis</i> (Tomato lady beetle)	tomato, cucurbits
<i>Aulacophora cottigarencis</i> (Squash beetle)	cucurbits
<i>Lasioderma serricorne</i> (Cigarette beetle)	garlic and onion
<i>Nisotra gemella</i> (Flea beetle)	ladyfinger
<i>Phytorus spp.</i> (Chrysomelid beetles)	sweet potato
<i>Aspidomorpha fusconotata</i> (Tortoise shell beetle)	sweet potato
Caterpillars/worms <i>Homona coffearia</i> (Leaf folder)	beans, garlic and onion, jute, peanut
<i>Spodoptera litura</i> (Common cutworms)	celery, crucifers, garlic and onion, peanut, potato, sweet potato, taro
<i>Pseudalitia separata</i> (True armyworms)	corn, cucurbits, sweet potato
<i>Agrotis ipsilon</i> (Spotted cutworm)	corn, cucurbits, garlic and onion, potato
<i>Helicoverpa armigera</i> (Corn earworm)	corn, crucifers, cucurbits, garlic and onion, peanuts, solanaceous crops

Name of Pest	Target Vegetables
<i>Chrysodeixis chalcites</i> (Corn semi-looper)	corn, jute, peanut
<i>Crocidolonia binotalis</i> (Cabbage worm)	crucifers, cucurbits
<i>Plutella xylostella</i> (Diamond-back moth)	crucifers
<i>Pieris canidia</i> (Cabbage butterfly)	crucifers
<i>Anadenida peporis</i> (Squash semi-looper)	cucurbits
<i>Diaphania indica</i> (Leaf folder)	cucurbits
<i>Dasychira mendosa</i> (Tiger moth caterpillar)	cucurbits, peanut
<i>Sitotroga cerealella</i> (Angoumois grain moth)	garlic and onion
<i>Ephestia elutella</i> (Cacao moth or Tobacco moth)	garlic and onion
<i>Anomis sabulifera</i> (Cutworm)	jute, ladyfinger
<i>Xanthodes transversa</i> (Cutworm)	ladyfinger
<i>Oxya chinensis</i> (Short-horned grasshopper)	sweet potato
<i>Terophagus proserpina</i> (Gabi planthopper)	taro
<i>Suaria concolor</i> (Tussock moth caterpillar)	ladyfinger
<i>Hippotion celerio</i> (Sphinx moth)	peanuts, taro
<i>Lamprosema indicata</i> (Bean leaf roller)	beans, peanut
<i>Stomopteryx subsecivella</i> (Leafminer)	peanut
<i>Eumeta fuscescens</i> (Pepper bagworm)	solanaceous crops
<i>Aciptilia viveodactyla</i> (Sweet potato plumme moth)	sweet potato

Name of Pest	Target Vegetables
<i>Rhyncolaba acteus</i> (Green sphinx moth)	taro
<i>Agrius convolvuli</i> (Sweet potato hornworm)	sweet potato, taro
Flies <i>Ophiomyia phaseoli</i> (Bean fly)	bean
<i>Bemisia tabaci</i> (White fly)	cassava, garlic and onion, sweet potato
<i>Pieris canidia</i> (Cabbage butterfly)	crucifers
<i>Dacus cucurbitae</i> (Fruit flies)	cucurbits
Hoppers/Katydid <i>Phaneroptera furcifera</i> (Long-horned grasshopper)	corn, cucurbits, peanut, sweet potato
<i>Mecopoda elongata</i> (Katydid)	cucurbits
<i>Empoasca bigutulla</i> (Cotton leafhopper)	peanut, solanaceous crops
<i>Atractomorpha psittacina</i> (Slant-faced grasshopper)	peanut, sweet potato
<i>Empoasca fabae</i> (Potato leafhopper)	potato
<i>Leplocentrus manilensis</i> (Tree hopper)	solanaceous crops
<i>Locusta migratoria manilensis</i> (Oriental migratory locust)	sweet potato
Mites <i>Tetranychus telarius</i> (Spider mite)	cassava, potato, winged bean
<i>Tetranychus truncatus</i> (Common mite)	cucurbits, sweet potato
<i>Aceria tulipae</i> (Mite)	garlic and onion
<i>Dolichotetranychus floridanus</i> (Tenuipalpid mite)	pineapple

Name of Pest	Target Vegetables
Scale Insects <i>Chrysomphalus ficus</i> (Florida red scale)	cassava
<i>Saissaetia nigra</i> (Soft scale)	cassava, ladyfinger
<i>Saissaetia coffeae</i> (Hemispherical scale)	cucurbits
<i>Aspidiella hartii</i> (Ubi scale)	ginger, yam
<i>Aspidiella zingiberi</i> (Luya scale)	ginger
<i>Aspidiotus destructor</i> (Coconut scale)	ladyfinger, pineapple, taro, yam
<i>Pinnaspis aspidistrae</i> (Fern scale)	ladyfinger, pineapple
<i>Lepidosaphes rubrovittatus</i> (Tampoi scale)	ladyfinger
<i>Abnidiella aurantii</i> (California red scale)	pineapple
Other insect pests <i>Macrotermus gilvus</i> (Mound building termite)	cassava
<i>Thrips tabaci</i> (Tobacco thrips)	cucurbits, garlic and onion, potato
<i>Leucopholis irrorata</i> (Root grubs)	pineapple, corn
<i>Anomala sp.</i> (Root grubs)	corn, sweet potato
<i>Gryllus bimaculatus</i> (Black cricket)	corn
<i>Gryllotalpa africana</i> (Male cricket)	potato
<i>Dysdercus cingulatus</i> (Cotton stainer)	ladyfinger

Name of Pest	Target Vegetables
<i>Catochrysops cnejus</i> (Bean lycaenid)	peanuts
<i>Cylas formicarius</i> (Sweet potato weevil)	sweet potato
<i>Tagiades japetus titus</i> (Gabi skipper)	taro

Source: International Institute of Rural Reconstruction (IIRR), Silang, Cavite, Philippines

Mulching

Mulch is loose organic materials, such as straw, cut grass, leaves and the like used to cover the soil around the plants or between the rows for protection or improvement of the area covered. A mulch aids in maintaining a favorable condition of the soil underneath. The increased plant growth is due primarily to conditions resulting from the use of a given material rather than any growth promoting substances present in the mulch itself.

Since organic mulches are derived from plant materials, decomposition will occur and this has several positive effects on both the soil and the plants.

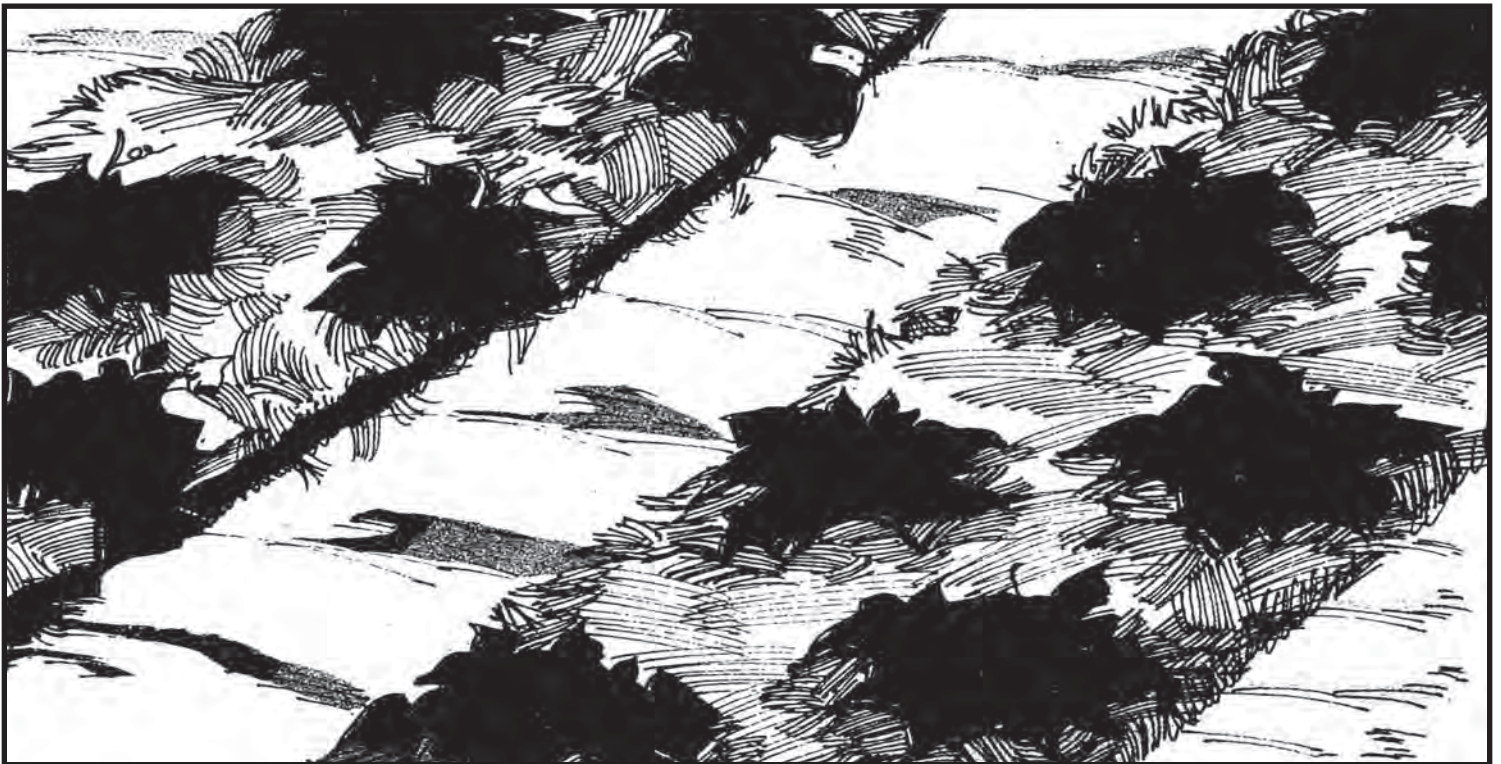

Physical Effects

1. If mixed in the upper soil layer, the material dilutes the soil and usually increases root growth. Aeration and water-holding capacity are increased on clay and sandy soils, respectively.
2. During the decomposition of the organic material, soil microorganisms secrete a sticky material which promotes the granulation or clinging together of the soil.
3. Mulch improves and stabilizes soil structure or the arrangement of soil particles. It serves as a cushion, reducing soil compaction caused by pelting rain, coarse streams or drops of water from irrigation devices.

Chemical Effects

1. Most organic materials will raise the soil pH slightly, making it more alkaline. This can be remedied by mixing acid-forming or organic matter like sawdust and moss peat with the soil.
2. In two or three months, mulch rots and small amounts of fertilizer become available to the plants.
3. Nitrogen deficiency may become apparent with mulched plants because an appreciable amount of nitrogen is taken from the soil by the microorganisms decomposing the organic mulch. To avoid this, liquid fertilizer must be applied to the plant as nitrogen-supplement.



Without mulch, weeds are growing in between plants.

Biological Effects

1. Organic mulch serves as food for many microorganisms found in the soil. It also helps keep the temperature more constant so microorganisms activity can proceed at a uniform rate.
2. Sometimes undesirable organisms like disease-causing fungi, bacteria and nematodes may be added to the soil with the application of organic plant materials. Stirring the mulch occasionally eliminates the mold. During rainy season, mulch should be applied only when the plants are at least a month old to deter pest attack.
3. Weed seeds may be introduced into the garden with hay or straw. This can be avoided by using only the middle portion of the plant as mulching material. The flowers and the roots must first be composted.



Mulch prevents the growth of weed.



Mulching prevents soil compaction.

Source: *International Institute of Rural Reconstruction (IIRR), Silang, Cavite, Philippines.*

Fish Emulsion as Plant food for Bio-intensive Garden

Made from a blend of saltwater fish wastes, fish emulsion is a thick, gooey concentrate with about five percent nitrogen and small but significant amounts of trace minerals. It also contains a lot of fish oil. Most of the nitrogen in fish emulsion is present as amino acids from the breakdown of protein or as ammonia and nitrate. These amino acids can easily be absorbed by the leaves or roots. Diluted in water, fish emulsion can be either sprayed on leaves or poured around the base of plants.

Significant Findings from Research

1. Fish emulsion applied once a week to greenhouse soil stimulated vegetative growth and delayed flowering and fruit ripening in tomatoes by over a week. (*Virginia Polytechnic Institute of State University in Blacksburg, Virginia*)
2. Fish emulsion fertilizer added to the soil reduced nematode population. (*Biological Testing and Research Laboratory, California*)

Preparation

1. Put any kind of scrap fish or unused fish-parts in a glass jar or plastic container. Fill with water.
2. Cover the top with a cloth, securing firmly to keep out insects and animals.
3. Place the container in a storage bin and let it ferment for two to three months.



4. After this period, a layer of mineral-rich oil will float on top, water underneath and the bones and scales on the bottom. Skim off the oil and store in a container.
5. When ready to use, dilute one cup of oil with five gallons of water. The remaining sludge may be sun-dried and then mixed with the soil.

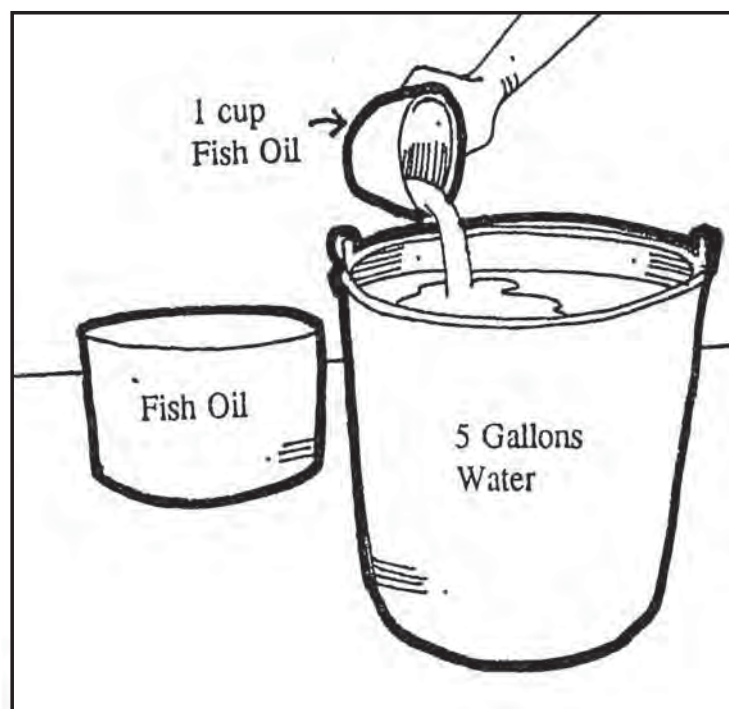

Source: *International Institute of Rural Reconstruction (IIRR), Silang, Cavite, Philippines*

Gardening in Dry Environments

Some of the problems associated with dry-land gardening are light saturation and excessive evaporation, which can lead to more serious problems like nutrient deficiency and soil alkalinity. These problems can greatly affect the growth and development of plants. But, gardening is still possible under such conditions if a special environment is created

1. **Deep digging.** This improves soil structure, making it more porous. With more spaces in the soil, greater amounts of water can be stored for the use of the plants.
2. **Addition of large amounts of organic matter into the soil.** While nutrients can be present in dryland soils, they are usually chemically unavailable due to high soil pH. Organic matter is essential to create humus, which can make the elements become available to the plants. It also acts like a sponge, absorbing water so that less evaporates.
3. **Close spacing of plants.** With all available spaces filled up with plants, there is less exposure of soil to direct sunlight; hence, less evaporation. Shading of the soil also keeps down weeds, another competitor for water.
4. **Provision of windbreaks.** Growing trees around the garden helps to lower the temperature in the immediate vicinity of the garden and deflects dry winds. It, therefore, decreases water loss from the plant surfaces.
5. **Clay pot technique.** Water in a clay pot buried in the soil will diffuse slowly from the pot to the plants:
 - a. Sink unglazed, porous clay pots into the beds (with the opening just above the bed surface) one meter apart. Fill with water and cover to reduce direct evaporation.
 - b. Add a thin layer (0.5 cm) of straw or grass clippings as mulch.
 - c. When the plants are about three weeks old, add more mulch (5-8cm).

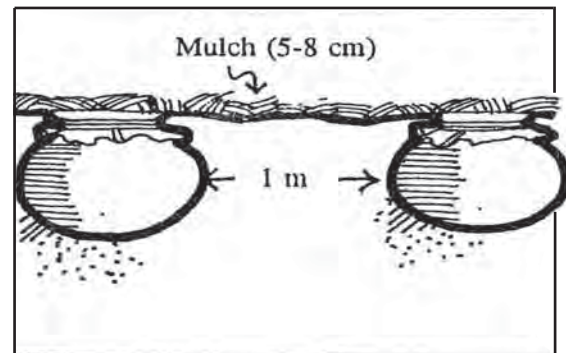
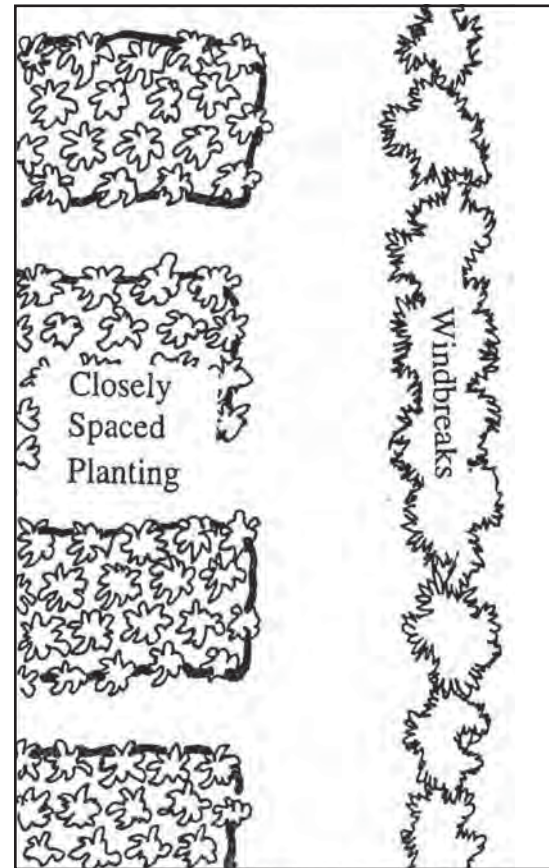

Source: *Regenerative Agriculture Technologies (RAT) Kit*. IIRR UNICEF for Philippine Department of Agriculture. 1989.

Growing Vegetables in Saline Areas

Saline soils are soils that have been harmed by excessive amounts of soluble salts—mainly sodium, calcium, magnesium, chloride and sulfate, as well as potassium, bicarbonate, carbonate, nitrate and boron. The abnormally high salt concentration of saline soils reduces the rate at which plants absorb water, consequently growth is retarded. Aside from growth retardation of plants, certain salt constituents, like boron, are specifically toxic to some crops.

What Causes Soil Salinity?

1. **Lack of water.** Salt-affected soils are common in arid or semiarid regions because there is less rainfall available to leach and transport the salts and because the high evaporation and plant transpiration rates in arid climates tend to further concentrate the salts in soils and surface waters.

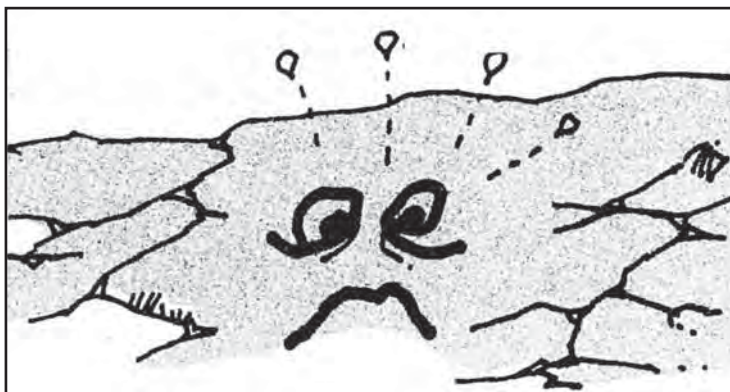

2. **Poor drainage.** When water table rises to within 1.5 or 2m of the surface, groundwater containing dissolved salt moves upward into the root zone and to the soil surface. Groundwater then causes the soil to become saline.

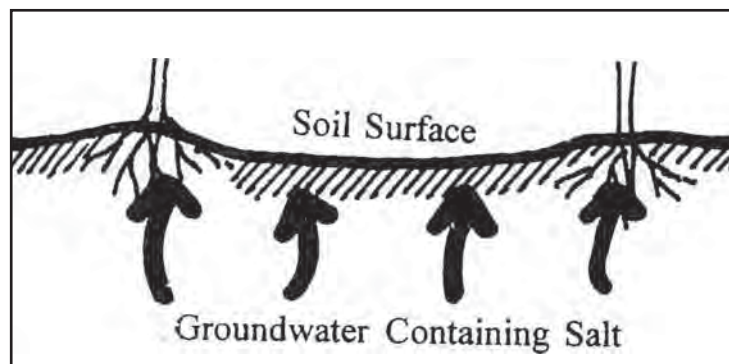

3. **Excessive irrigation.** Irrigation waters may contain large amount of salt. Considerable quantities of soluble salts may be added to irrigated soils in a short time.

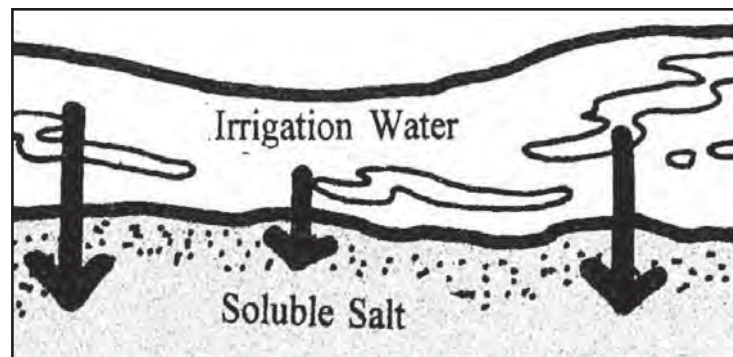

How to Tell if Your Soil is Affected by Salinity

The salinity status of soils is appraised by measuring electrical conductivity of the solution extracted from saturated soil paste. The yields of very salt-sensitive crops may be restricted at readings as low as 2, moderately salt-tolerant crops grow satisfactorily below readings of 8; only salt-tolerant crops grow satisfactorily when readings range between 8 and 16.

Management Practices for the Control of Salinity

1. Select crops or crop cultivars that can grow successfully under saline conditions. Among the highly tolerant vegetables are beets, kale, asparagus, spinach and tomato.
2. Use land preparation and tillage methods that aid in the control of salinity. Careful leveling of land makes possible a more uniform application of water and better salinity control.
3. Modify watering practices and bed shape to alter the tendency of salts to accumulate near the seed. Pre-emergence watering in special furrows placed close to the seed often is done to reduce the soluble salt concentration around the seeds and thus permit germination. After the seedlings are established, the special furrows may be abandoned and new furrows made between the rows.
4. Use special planting procedures that minimize salt accumulation around the seed. The tendency of salts to accumulate near the seed during irrigation is greatest in single-row, flat-topped beds. With double-row beds, most of the salt is carried into the center of the bed, leaving the shoulders relatively free of salt and satisfactory for planting.
5. Water properly, so as to maintain a relatively high soil moisture level and, at the same time, allow for periodic leaching of the soil and reduce salinity problems. The method and frequency of watering and the amount of water applied are of prime importance in the control of salinity. The amount of water applied should be sufficient to supply the crop and satisfy the leaching requirement but not enough to overload the system.
6. "Pond" water over the entire soil surface to make leaching efficient. Soils can be leached by applying water to the surface and allowing it to pass downward through the root zone.
7. Apply special treatments, such as, adding organic matters and growing sod crops to improve soil structure. Low permeability of the soil causes poor drainage by impeding the downward movement of water. The impedance may be the result of an unfavorable increase in groundwater level, which then causes the soil to become saline.

Standard Vegetable Beds for Saline Soils

For peppers, chile, ladyfinger, sweet potatoes, cowpeas and sweet corn

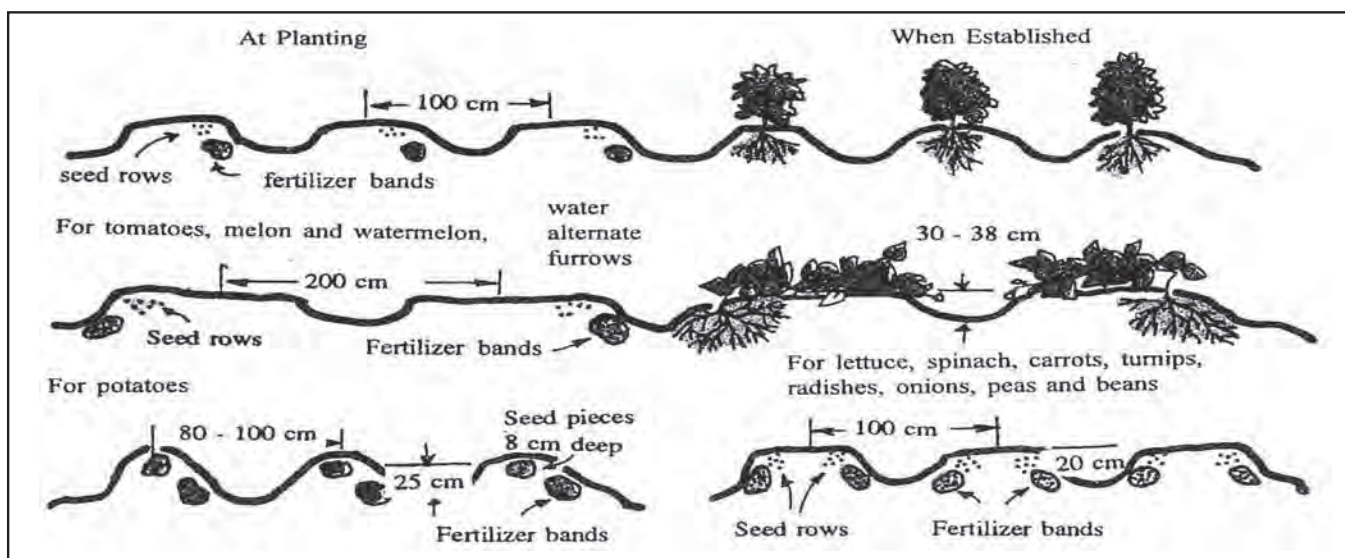

Reference: Bower, C. A. and M. Fireman. 1957. *Saline and Alkali Soils*. Yearbook of Agriculture by USDA, Washington, D. C.

Source: IIRR. International Institute of Rural Reconstruction. Silang, Cavite, Philippines

Water-saving Ideas for Gardens During Dry Season

Conserving water is especially important during dry months when water is limited. However, water conservation does not necessarily mean cutting down on water, rather, it means making the most of available water.

1. **Water early in the morning.** Watering in the morning allows greater absorption of water by the soil. Later in the day, the air is hot and dry and water evaporates from the soil surface faster.
2. **Water placement.** The best method of watering is by trickle or drip irrigation with a perforated plastic hose placed adjacent to each crop row. This puts the water exactly where it is needed.
3. **Mulch.** Mulch helps retain moisture by reducing surface evaporation. It also prevents weed growth and builds up humus, improving the water-holding capacity of the soil.
4. **Weed regularly.** Undesirable plants should not be allowed to have a share of any available water.
5. **Select adapted plants.** Use plants with a low water need, a deep root system and which tolerate heat and drought. Cucurbits, beans and some grains are good examples of plants that can be grown with little water.
6. **Recycle water.** Any water from household uses (must be low in detergents and grease) can be saved and used in the garden.

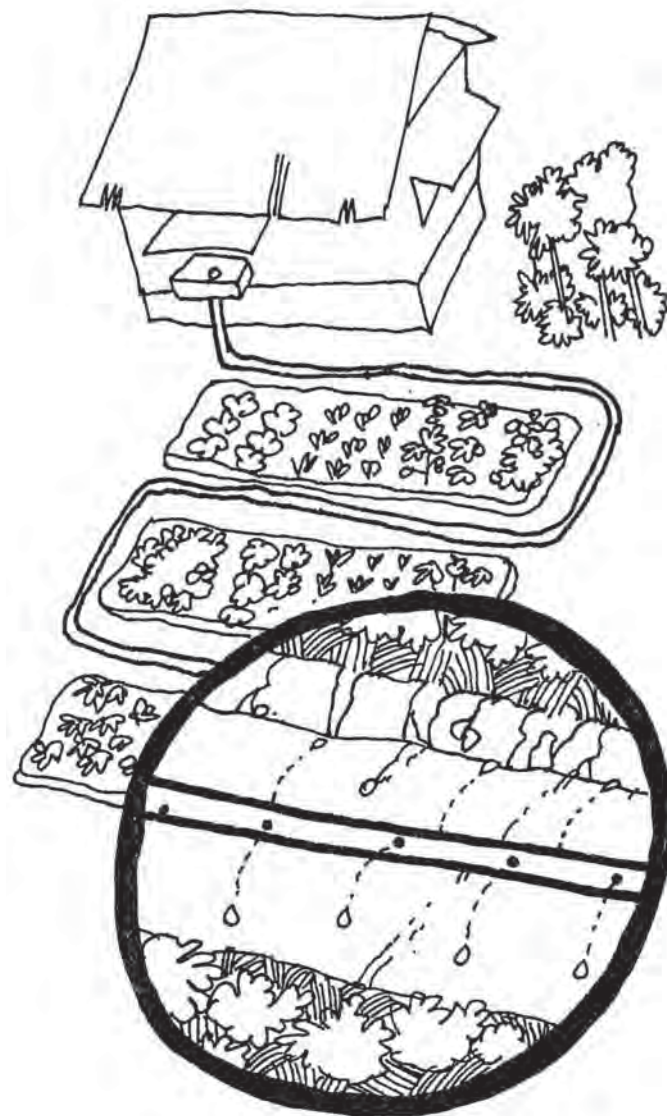

Source: Regenerative Agriculture Technologies (RAT) Kit. IIRR UNICEF for Philippine Department of Agriculture. 1989.

Why Producing Your Own Vegetable Seed is Important

1. High-quality seeds can be easily produced and at a low cost, thus, reducing the costs of gardening.
2. When the seeds you want are not available in the market, you can produce your own seeds.
3. When you produce your own seeds, you can sell them for income and/or share them with neighbors and friends.
4. By producing your own seeds, you can select seeds suited to your environment. If you want fruits that are big and are not attacked by pests in your garden, you can choose seeds of the plants that are grown in your garden with these specific traits.
5. Saving your own seeds is fun. It is also challenging to save seeds since you can experiment with different seed-saving techniques.
6. Seed self-reliance can be achieved by producing your own seeds.
7. Valuable traditional or indigenous seed varieties of vegetables can be preserved for future generations.

Definition of a Seed

A seed is an undeveloped and dormant plant, usually with a reserve food supply and protected by a seedcoat. It is also defined as a miniature plant in an arrested state of development. Botanically, the seed is a mature ovule enclosed within the ovary or fruit. Seeds of different species vary greatly in appearance, shape, location and structure of the embryo and the presence of storage tissues. A seed has three basic parts: (1) embryo; (2) food storage tissues or endosperm; and, (3) seed covering or seedcoat.

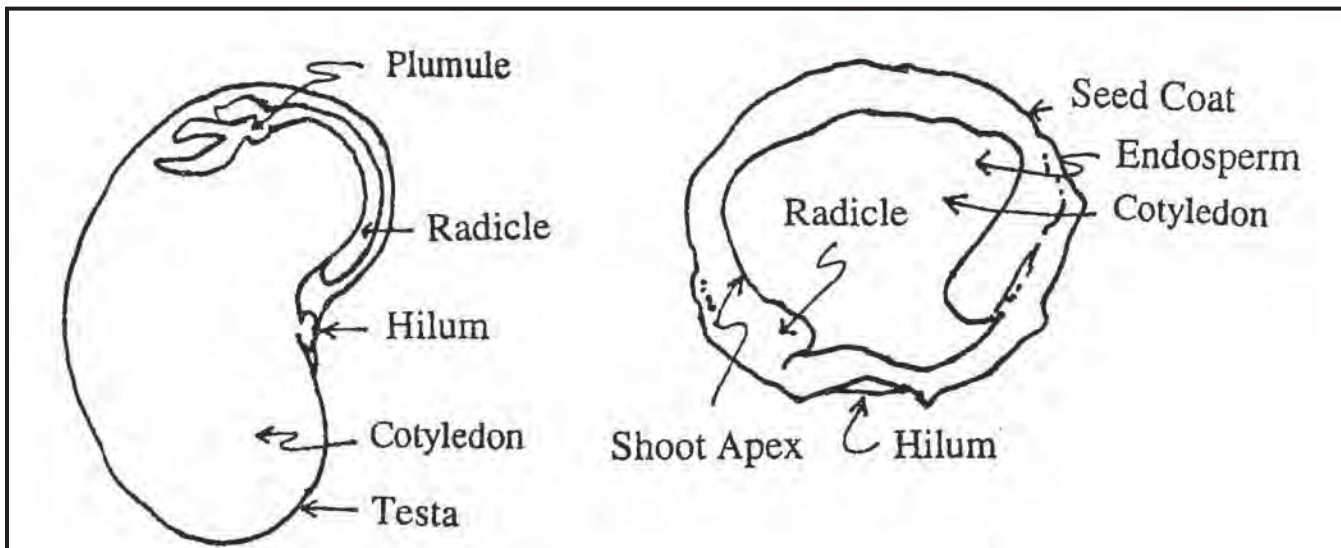

Source: *International Institute of Rural Reconstruction (IIRR), Silang, Cavite*

Vitamin A Content of Some Local Foods in Serving Portions Compared with Recommended Dietary Allowances for Various Age Groups

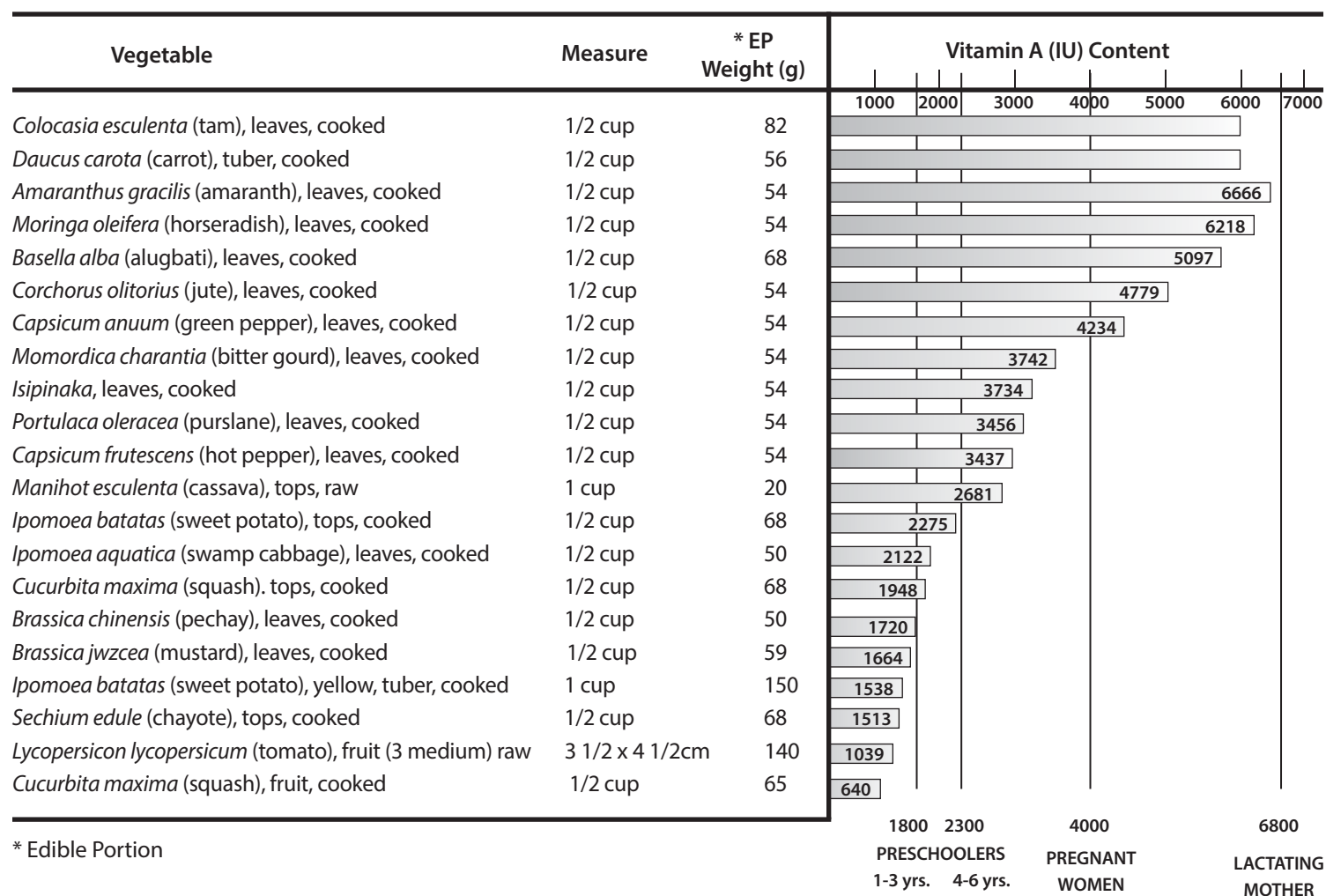

Source: Regenerate Agriculture Technologies (RAT) Kit. IIRR Unicef for Philippines Department of Agriculture. 1989

Vegetables that can be Harvested in Less Than a Month

SCIENTIFIC NAME	COMMON NAME	NO. OF DAYS FROM PLANTING TO HARVESTING
<i>Brassica juncea</i>	mustard	25
<i>Brassica chinensis</i>	pechay	25
<i>Raphanus sativus</i>	radish	20-25
<i>Basella alba</i>	basella	25
<i>Amaranthus gracilis</i>	amaranth	25-30
<i>Ipomoea batatas</i>	sweet potato	20
<i>Ipomoea aquatica</i>	swamp cabbage	20
<i>Coriandrum sativum</i>	coriander	15
<i>Cucumis sativus</i>	cucumber	30
<i>Lactuca sativa</i>	leaf lettuce	25
<i>Portulaca oleracea</i>	purslane	25
<i>Talinum triangulare</i>	Philippine spinach	25



Source: IIRR. International Institute of Rural Reconstruction. Silang, Cavite, Philippines

Alternative Pest Management

This is an approach that utilizes different techniques other than the use of chemical pesticides to control pests. It involves natural pest population-control methods, including cultural and biological controls and the use of botanical pesticides as needed.

Cultural Method of Pest Control

These methods are aimed either at reducing the sources of inoculum or at reducing the exposure of plants to infection. Its primary objective is the prevention of pest damage and not the destruction of an existing and damaging pest population.

1. Good soil preparation

This is the first important element in pest control strategy. A healthy soil means healthy plants which are relatively more resistant to pests. A soil rich in humus hosts a wide variety of beneficial microflora that trap nematodes and destroy or keep in dormancy disease organisms, thereby encouraging beneficial insects.

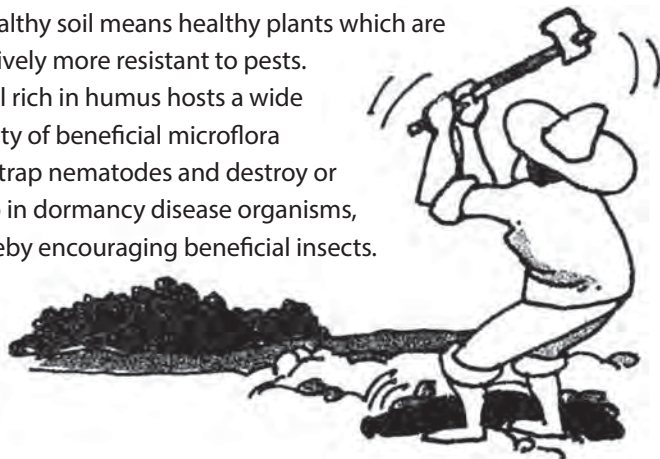

2. Use of indigenous varieties

Traditional varieties are hardier and relatively more resistant to pests. They can withstand harsh environmental conditions better than modern hybrids.



3. **Pest control through the use of mesh screen** (nylon nets)
Younger plants are usually preferred by insects and they suffer significantly from such attacks when compared to older plants. Therefore, a single netting over the plants during the first 30–45 days of their growth can reduce pest damage. Also, the net helps diffuse sunlight thereby improving the quality of some vegetables. Finally, the net breaks the impact of raindrops thus (i) reducing physical damage to the plant and (ii) reducing soil erosion from the beds.

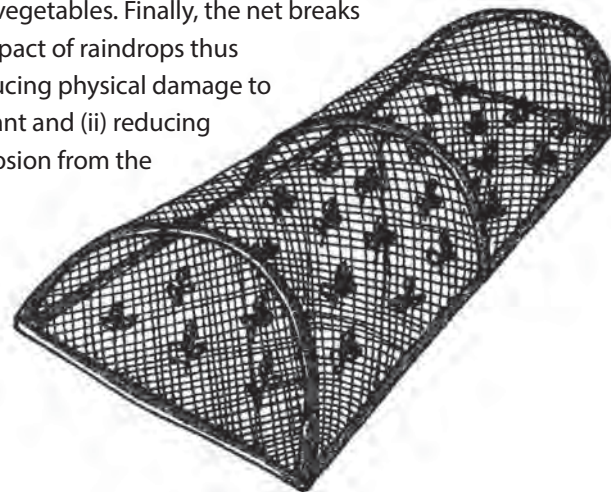

4. **Roguing or Pruning**
Removal of diseased plants or plant parts prevents the spread of microorganisms to uninfected areas.



5. Intercropping with aromatic herbs

Several types of odorous plants can be grown together with the main crop to repel insects. The following are some examples:

Allium cepa (onion)
Allium odorum (leek)
Allium sativum (garlic)
Artemisia vulgaris (mugwort, worm wood)
Coleus amboinicus (oregano)

Hyptis suaveolens (bush-tea bush)
Mentha cordifolia (mint)
Ocimum basilicum (sweet basil)
Ocimum sanctum (sacred basil)
Tagetes spp. (marigold)

6. Encouraging insect predators

Pests can be controlled by their natural enemies. By growing a variety of flowering plants, specifically those belonging to Umbelliferae family, such as, fennel (*Foeniculum vulgare*) and celery (*Apium graveolens*), insect predators will be attracted to stay in the garden. These beneficial insects feed on pests, keeping the pest population below economic injury level.



7. Multiple cropping

This provides genetic diversity to minimize pest increase. Variation in susceptibility among species or varieties to a particular disease is great. Given abundant hosts of a single species or variety, a pest could easily be spread from host to host. When the number of hosts declines, the pest incidence will also decrease for lack of necessary food for the organism.



8. Crop rotation

This is a practice of following a crop susceptible to a pest by a resistant crop. There is no build-up of the organism to a high level since the growth cycle of the organism has been broken.



Source: International Institute of Rural Reconstruction (IIRR). Silang, Cavite, Philippines.

Encouraging Predators

In nature, pests are usually controlled by the presence of insect predators and parasites which keep the populations of the harmful insects in control. Most of the insects in nature are either beneficial or at least harmless. There are many ways to encourage insect predators in one's garden.



1. **Create a Suitable Habitat for Insect Predators** – flowering shrubs and trees throughout the garden will attract many beneficial insects, including parasitic wasps which require pollen and nectar for their growth and maturity. Plants belonging to Umbelliferae family are particularly effective in attracting natural enemies of pests.
2. **Provide Alternate Hosts for Pests** – To ensure availability of food for the beneficial organisms, grow alternate host plants along fence lines and in between cultivated crops. The natural enemy populations on these alternate host plants will control pests attacking the cultivated crop.

3. **Create Nesting Sites for Frogs, Reptiles and Birds** – Logs of dead trees, irregularly shaped rocks with crevices and cavities and plenty of mulch can be a good nesting sites for snakes, lizards, frogs, rove beetles and carabid beetles, which feed on insects.
4. **Increase Humidity by Providing Water Holes** – Humidity is much needed for the survival of natural enemies. It serves as a source of drinking water for reptiles, birds and frogs. Many predatory insects live in, on and near water. Well-vegetated small dams, little water pools and swales scattered throughout the garden will create conditions for the build-up of natural enemies.
5. **Practice Mixed Cultivation** – Growing mixed crops and harvesting them in strips help maintain natural enemies and confuses pests. For fungal pathogens, the practice of mixed cropping is desirable as the root exudates of another crop can be toxic to the pathogen. Mixed cropping also encourages soil microbes which, in turn, act as barriers to the fungal pathogen.
6. **Reduce Dust Build up in Crop Plants** – Dust inhibits the functioning of natural enemies. Growing well-designed windbreaks and ground cover crops like centrosema and lablab bean will reduce dust. Use of overhead sprinklers will also help periodically in washing off the dust.
7. **Avoid Spraying Chemical Pesticides** – Chemical pesticides eliminate beneficial insects. If pest infestation reaches economic threshold levels and spraying cannot be avoided, use selective chemicals, such as:
 - a. soil incorporated granular systemic insecticides for sucking insects;
 - b. stomach poisons; avoid broad-spectrum contact poisons; and,
 - c. insecticides with short-term residual action rather than persistent action.

Improved application method should be developed and minimum doses should be applied.

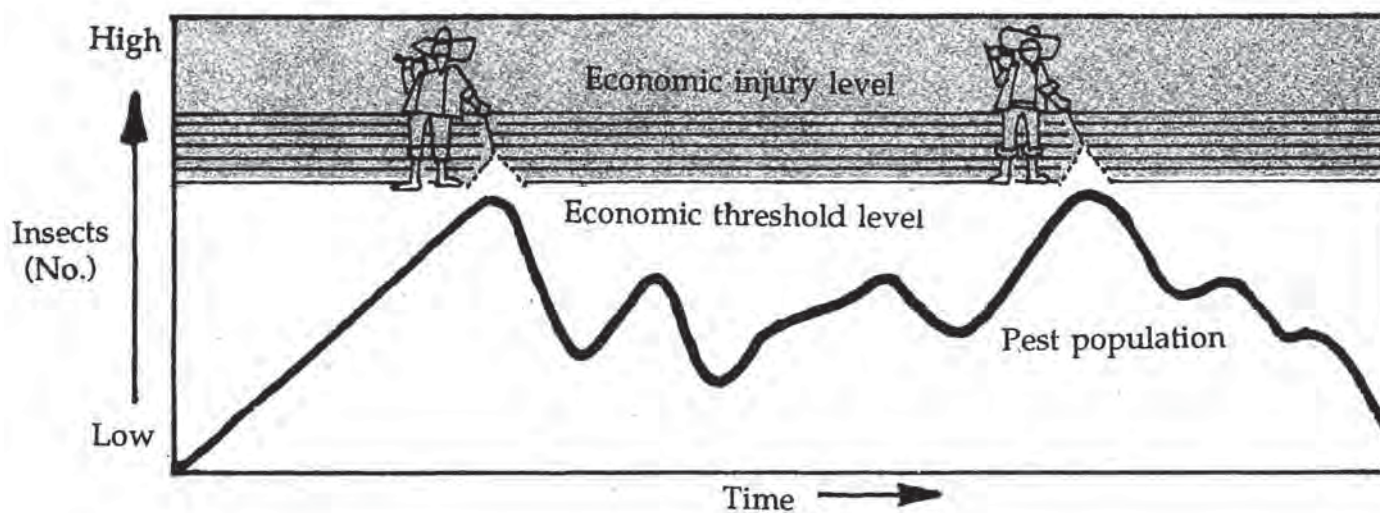

Source: International Institute of Rural Reconstruction (IIRR). Silang, Cavite, Philippines.

Lead in Urban Gardens

Urban gardens are often affected by the presence of metal pollutants in the air and on the soil. Air pollution can cause health problems for humans and can retard plant growth.

Of the metal pollutants, lead is a major concern. At least two sources of lead affect city grown produce: gasoline emissions and lead-based paint. Lead can be deposited directly on the plant leaves or on the soil. Lead in the soil is usually not taken up by plant roots unless it is present in large quantities. Soil-borne lead is rarely found in the fruiting parts of the plants. It is found mostly in the roots and leaves.

A number of factors affect the amount of soil-borne lead found in plants. Plants growing in soils with high organic matter content take up small amounts of lead. Decomposed organic matter and well-rotted manure tend to bind the lead and makes it insoluble to plant roots. If the soil pH is kept between 6.5 and 7.0, lead uptake can be reduced. Soil pH levels above 6.5 also reduce the absorption of metallic cadmium, another dangerous pollutant. Applying 8 - 10 cm of well-decomposed compost to each bed and incorporate it in the soil helps reduce lead uptake.

A bigger concern in lead-contaminated gardens comes from the exposure of children to the soil. Young children playing in the garden may put soil in their mouths, ingesting the lead. This method of lead poisoning is more common than through consuming lead-polluted vegetables. Avoid taking young children into urban gardens to reduce their direct exposure to surface soil lead.

Fortunately, lead deposits on leaves can easily be washed off. Water alone is not sufficient. Wash with diluted vinegar (1% or one spoonful of vinegar in 100 spoons of water) or diluted dish washing liquid (0.5% or half a spoonful for every 100 spoons of water) is preferred. Root crops should be peeled to ensure that lead adhering to the skin is removed. Since green leafy vegetables are most affected by lead deposits, they should be planted as far away as possible from roads with heavy traffic.

Vegetables such as tomatoes, eggplants, beans, squash and peppers should be planted closer to the roads since they show lower concentrations of the metals. However, at least 10 meters should separate any garden from the street. Barrier crops such as a hedge planted at the side of the garden facing the road can effectively reduce the deposit of-lead and other metals on garden produce and on the soil itself.

The problem of lead pollution in urban gardens can be addressed by the following measures:

- Apply high quantities of organic matter to the soil.
- Cultivate root and fruiting vegetables.
- If you grow leafy vegetables, plant them away from the source of lead emissions.
- Wash vegetables with diluted soap or vinegar.
- Keep very young children away from lead-polluted gardens.

Family Farming



Integrated Community Food Production

A Compendium of Climate-resilient Agriculture Options

The Household as a Production and Consumption Unit

The household, seen as a production and consumption unit, has three subsystems:

- A. **The Household Subsystem:** This is the socioeconomic unit concerned with the household structure and its composition: husband and children, grandparents and often other family relatives. Different responsibilities (some culturally defined) are to be found with regard to food production and utilization and related decision-making. The access to, and control of, productive resources may differ from household to household.
- B. **The Production Subsystem:** This refers more to the physical unit with an emphasis on homestead-level production (*halaman sa bakuran*) and, to a lesser degree, on field production (*pulo* or *bukid*). This subsystem is affected by the access to productive resources mainly land area, capital and other inputs. This includes production from backyard activities, such as small livestock, home gardens (including traditional sources such as the mixed backyard garden) and, sometimes, fish ponds. If the production from the main field is even partly consumed at home, that physical unit must also be considered (e.g., cereals or large animals).
- C. **The Consumption Subsystem:** This is the biological unit and refers to the actual utilization

of the food produced at the household level. Consumption is affected by factors such as: the total quantity of food produced; the numbers of consumers involved; the pressure to market the food (e.g., to repay capital costs); cultural values and attitudes to the kinds of food produced and not produced locally; patterns of distribution of food within the household system; and, food preparation and preservation practices (to prevent waste during peak production months).

Food consumption includes items that were not specially grown by the consuming unit or purchased but were either bartered, or scavenged (*mamumulot*), collected from other sources (e.g., fish, backyard trees or *halaman sa bakuran*) or procured as part of some culturally accepted norms (*hunusan* or share of harvests given to laborers assisting in the harvest).

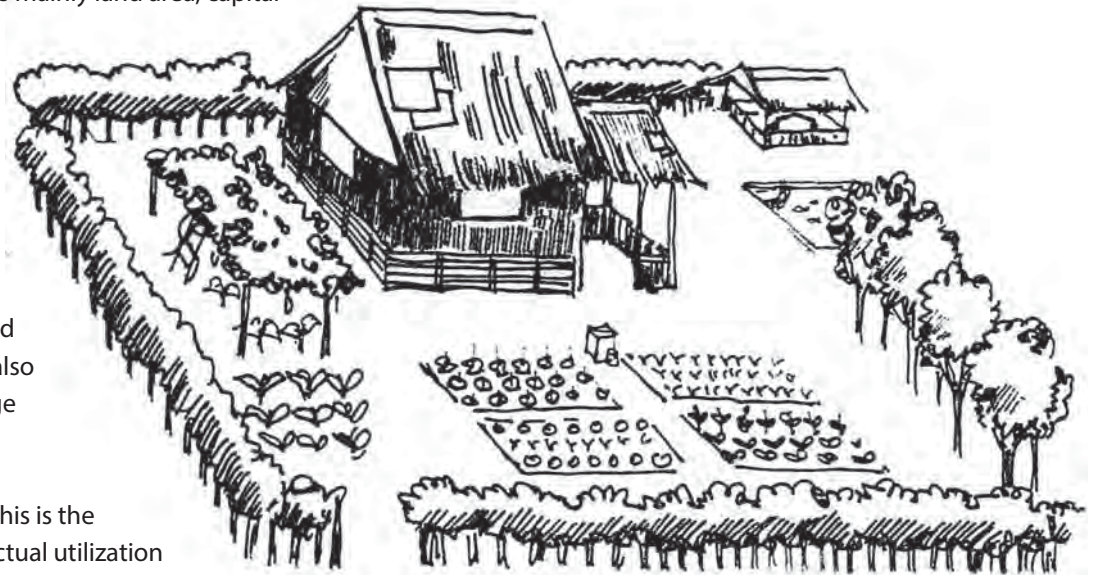

Source: International Institute of Rural Reconstruction (IIRR). Silang, Cavite, Philippines.

Some Characteristics of a Regenerative Agriculture System

Regenerative agriculture system, food and energy security at the household level, income enhancement and ecological soundness are all equally important goals. In the interest of equity and social justice, the small and marginal farmers are the priority audience.

1. **A regenerative or sustainable farming system relies more on the internal resources of the farm than on external resources.**

- Seeds are saved on a year-by-year basis.
- Household / family labor use is maximized.
- Rainwater is harvested and soil moisture conserved within the farm.
- Nutrients are provided from crop residues and other organic sources, such as animal manure and biofertilizers.
- Fodder, timber fuel and food are farm grown.

2. **A diversity of farm enterprises or activities (as opposed to single enterprises/monocrops) is emphasized.**

- Diversified farms offer a range of products or sale rather than large quantities of a single product. Marketing can be done locally. This reduces transportation costs and eliminates or reduces the number of middlemen. This means higher returns for the farmer.
- Most of the labor is provided by the farm family. The labor demand is evenly spread in a diversified farm as opposed to single-enterprise farms where labor-demand peaks are a phenomenon to contend with.
- Genetic diversity within crops is encouraged. Two or more varieties of each crop are grown rather than just one variety. Similarly, mixed tree planting is preferred over single-species planting.

3. **It minimizes the use of chemical inputs, such as fertilizers** (the transition to reduced levels of use is gradual, not abrupt).



- Atmospheric nitrogen (as much as 78% of the air is nitrogen) is tapped by introducing leguminous crops into the annual cropping cycle, e.g., bean rotations following rice or corn, leguminous trees within the crop area.

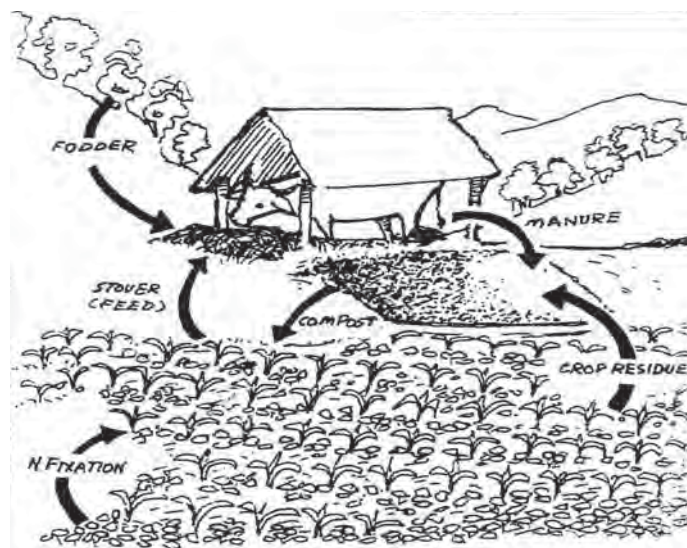

- Biofertilizers, green leaf manure and green manures are emphasized. As much as a 30-50% reduction of the recommended chemical nitrogen can be achieved.
- Intercropping and rotation systems based on cereal-legume combinations are encouraged.
- Plant wastes (e.g., straw, stubble) are recycled by composting, feeding livestock or merely incorporating into the soil.
- If chemicals such as pesticides are used, every attempt is made to ensure their safe, efficient and effective use.

4. **Long-term security and stability are often influenced by the choice of crop/tree seeds and species.**

- If high-yielding modern varieties (HYVs) are used, open-pollinated, high-yielding or composite varieties of crops are preferred rather than hybrids. Farmers can retain such seeds for several crop seasons.
- Multi-purpose trees which are available locally are usually preferred over exotics.
- Heirloom or traditional vegetable varieties are raised in backyard family food gardens. This conserves these varieties for future generations.

5. **Water harvesting and conservation**

- The presence of trees on the farm encourages deeper penetration of rain water into the soil surface.
- Terraces, contour builds structures and vegetative barriers reduce run-off from the farm.
- Crop residues and mulch reduce runoff water and soil moisture evaporation.
- Minimum tillage is practiced as a way of conserving sub-soil moisture reserves. Sowing legumes directly into the stubble or residues of the previous crop (without ploughing the land) is one such example.
- Where feasible, small farm ponds based run-off water are constructed for future recycling.

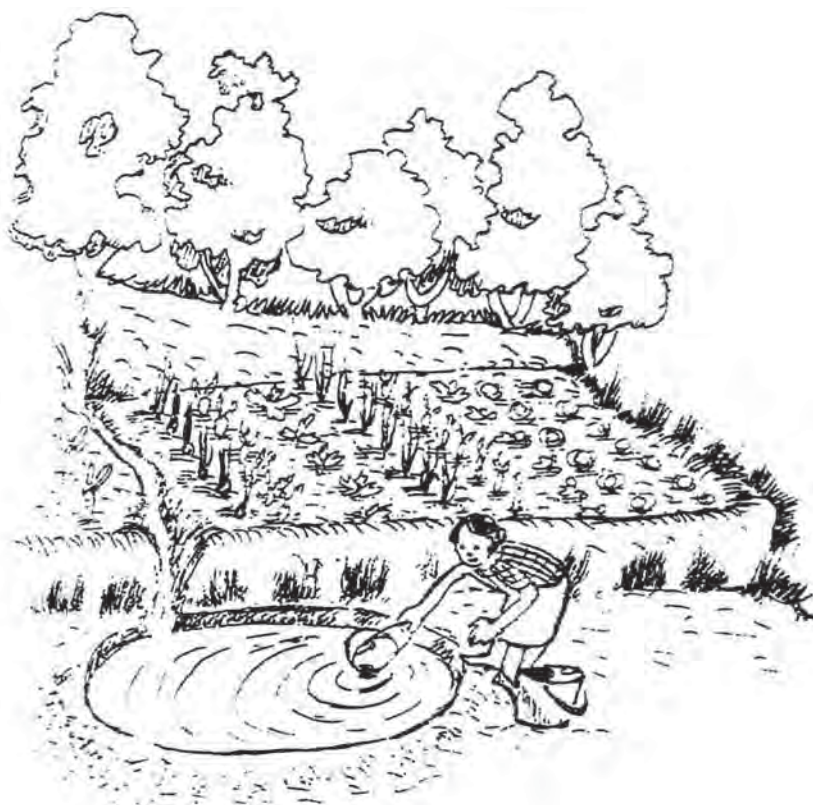

6. **Household /farm level energy security and efficiency**

- Energy needs (for heating and cooking provided by farm-grown fuelwood).
- Tillage, transportation and processing based on renewable energy resources, including animal power and human labor.
- The increased reliance on organic manures reduces the need for fertilizers manufactured with fossil fuel.

7. **Trees play a special role in the restoration and regeneration of small farms.**

- The area under annual crops is adjusted devoting more space to perennial crops. The reduced area under annual crops is then intensively cultivated.
- Perennial crops are, in the long run, more reliable sources of income, are less susceptible to drought and diseases and require less overall labor.

- Growing mixed tree species of different heights serves to maximize the use of above-ground vertical space, thus using solar energy more efficiently, e.g., multistoried tree-cropping or mixed-species fence lines.
- Fast-growing trees are raised in the slopy, elevated or marginal portions of the farm to exploit the income-generating potential of trees for housing materials, fuel, etc.



8. **Integration is a key characteristic.**

- Livestock are a critical component within an integrated operation. They provide an opportunity for recycling crop-wastes and provide manure for soil fertility enhancement.
- Livestock and trees can be integrated with fish culture or cereal crops to reduce production-input costs. Livestock enterprises must rely primarily on internal resources of the farm (*Azolla*, fodder trees, ricebran, etc.) and less on external resources. Trees and grasses for feeding livestock are raised in degraded or underutilized parts of the farm, such as fences and terrace risers.

Some forms of aquaculture are practiced on the farm, especially within the rice paddies or in small-farm ponds fed by run-off water. Often, aquaculture efforts are linked with livestock enterprises and, in turn, pond sediment is used to fertilize vegetables grown on the pond-bank.

9. **Economic viability and income enhancement.** Some of the ways this is done are the following: the intensification of outputs per land unit area through crop rotation, multistoried cropping, intensive market gardening, processing of farm outputs, integration of enterprises, the reduction of external input costs, direct marketing of produce and product diversification.
10. **Partial or total pest control** is achieved through a healthy and balanced farm ecosystem by the creation of a healthy soil, mixed or diverse cropping, conservation of predators and other natural enemies, reduced crop stress and the-growing of resistant varieties. If insects are still a problem, need-based (rather than calendar-based) chemical sprays are used.
11. **Cultural heritage.** The diversity of cultures, folklore and indigenous knowledge is viewed as a rich repository of ideas and a knowledge resource, to guide attempts toward sustainable development. Key informants and experienced traditional practitioners in such communities can serve as indigenous specialists and complement very effectively the work of the outside agent.
12. **Working with nature.** A practitioner of sustainable agriculture sees the need for restoring and regenerating the natural resource base upon which everything (including human life) depends. One works with nature's forces to nurture its own capacity to contribute to the regeneration process. To this extent, external inputs are brought in, but only after a critical assessment of their potential contributions to the long-term sustainability of the farm.

Source: *Regenerative Agriculture Technologies (RAT) Kit*. IIRR UNICEF for Philippine Department of Agriculture. 1989.

Farm Management Practices which Reinforce Soil and Water Conservation

1. Crop rotation



Use good crop rotation practices; alternate grain crops with legumes whenever possible.

2. Relay planting

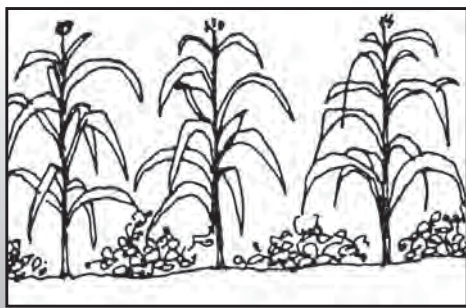

Practice relay planting of the second season crop. Sowing the second crop while the first is still growing helps reduce demand for soil cultivation. Relay planting also serves as an effective soil cover following the first harvest.

3. Contour cultivating and planting



Always cultivate and plant crops along the contour. This impedes water flow between more solid structures, like rock walls or living hedgerow barriers.

4. Use of organic matter



Incorporate all available organic matter (crop residues, animal manure, etc.) into the soil. This helps improve soil structure, fertility, moisture-holding capacity. Do not burn crop residues.

5. Laying crop residues along contour



Lay additional crop residues, twigs and other materials in contour lines across the slope, to further impede water flow. These lines can be placed at the base of contour hedgerows or rock walls.

6. Diversification of farm enterprises including tree crops

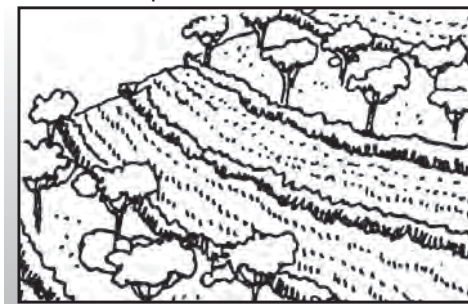

Diversify farm enterprises to include more tree crops. Fruit or estate crops can be planted in small orchards or interspersed

with food crops. Tree crops are particularly suitable on severely sloping land.

7. Maintenance or establishment of forest at the upper end of the slope



Maintain forested areas at the upper end of sloping farmlands. These forested plots or woodlots should serve both a protective or conservation function as well as provide a steady source of fuelwood, food, income and other useful products.

8. Protection of the land with cover crops during fallow periods

Protect the land during fallow periods Use effective mulches on cover crops to protect the soil surface from intense sunlight, wind erosion and the occasional unseasonal rains.



9. Animal confinement

Stall-feed or tether all animals. Free-grazing animals which roam farmland during off-seasons can be one of the major causes of erosion in hilly areas. Stall-feeding also enables collection of manure for soil fertility management.

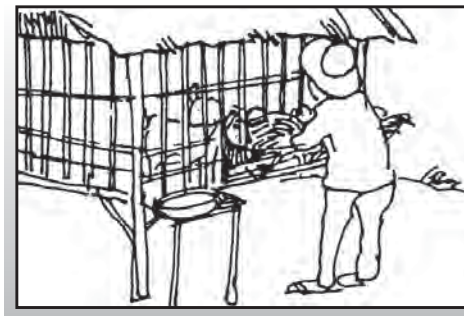

Increasing Organic Matter in the Soil

In general, organic matter (OM) and soil fertility are linked. If soil has a large amount of OM, it is also high in fertility. Increasing the supply of one will ultimately increase the other. There are two basic steps in increasing soil OM content: (1) increase biomass production; and (2) return biomass produced to the soil.

Production of Biomass

Increasing biomass production is the first step in attaining higher OM content in the soil. The amount of biomass produced is in turn increased by increasing soil fertility and by improving the efficiency of water use.

Increasing Soil Fertility:

One of the quickest ways of increasing soil fertility is fertilizers - though it is the most expensive. However, the value of these chemicals lies in their use as catalysts - when they are used in very small amounts to supply any nutrient which is lacking in the soil (and which is very difficult to make available in any other form). Biofertilizers such as green manures, *Azolla*, and micro-organisms which can 'fix' nutrients in forms that can be used by plants are more practical for the small farmer with little capital.

Crops or trees which produce food for humans, feed for livestock, or other useful items and at the same time increase soil fertility can also be grown. These are usually legumes. The application of animal manure and other farm by-products which would otherwise be thrown away can also significantly increase the soil's fertility.

Improving Water Use Efficiency:

Water is essential for plant growth. Making the best use of it will increase total biomass production.

When water is in excess (during the rainy season), plants that are able to use a lot of water and grow very fast, should be grown. Excess water can also be stored on the surface: in ponds, in underground reservoirs, or in the soil's surface layers for use by crops.

Preventing the stored water from evaporating is important. If possible, water stored in ponds should be shaded and windbreaks planted around it. The ground should be mulched if the water is stored in the ground for the use of crops.

When water is scarce, plant crops which need very little water for good growth and production (like sorghum and forage legumes), or deep rooted plants which can tap soil reserves (trees), should be sown.

Effects of Organic Matter on Soils and Crops

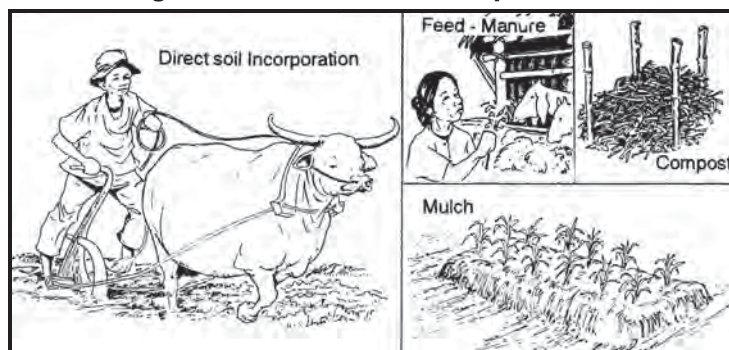

Returning Biomass to the Soil

The biomass produced must be returned to the soil in some form - either through direct incorporation, by using as mulch, by passing through livestock as feed, or by composting. The choice of method will be determined by any number of factors, but one of the most important to consider is: how can the biomass be used to meet as many needs as possible in the most efficient way before ultimately serving as OM in the soil?

Effects of Organic Matter on Soils and Crops

Conserves Water

OM increases the size of macropores in the soil. This allows for more water absorption and retention. Consequently, the greater rate of absorption reduces runoff during heavy rains, decreasing erosion. Water-holding capacity is improved in sandy soils and water is made more easily available in clay soils. Soil temperature is also cooler, reducing evaporation.

Improves Soil Structure

OM reduces bulk density, allowing deeper root penetration. This increases the surface area available for extraction of water and nutrients. Drought tolerance and crop growth are improved. Increased OM makes tillage easier and faster. It allows for reduced tillage without reduction in yield. Soils can be more quickly worked after a rain which enables farmers to better control weeds in the rainy season. OM improves seed germination rates and reduces soil cracking, thus minimizing root and soil exposure to drying winds.

Increases Fertility

OM acts as a buffer on soil pH. It increase pH of acidic soils and decreases pH in alkaline soils. The change can be as much as one unit on the pH scale. OM provides N and K directly to the soil and improves the efficiency of any chemical fertilizer applied. It favours the growth of N-fixing bacteria and algae residing in the soil; encourages micro-organisms that 'fix' P, making it more available to plants; and supplies micro-nutrients and improves overall soil health. In fact, yield increases are greater with OM application than with direct application of micro-nutrients. OM also reduces nutrient leaching.

Minimizes Pests

OM favours the development of micro-organisms which compete with insect pests and disease-causing organisms (pathogens), reducing insect and disease damage. Gases released during OM decomposition are toxic to several pathogens. Balanced plant growth improves resistance to pests.

Effect of Weather on Mulched Soil

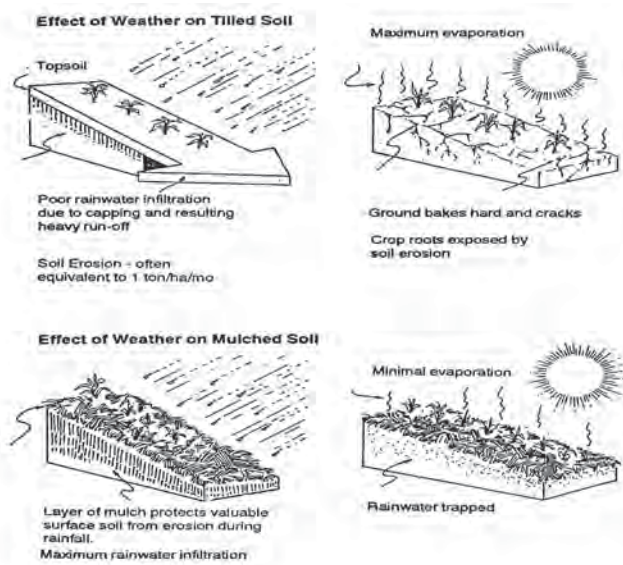

Source: *Resource Book on Sustainable Agriculture for the Lowlands. Southeast Asia Sustainable Agriculture Network (SEASAN). 1992*

Family Food and Income from Root Crops

Root crops have been labeled as a poor man's crop or a survival crop. But for the past few years, they have been proving their worth, both as a survival crop and for income-generation as well.

■ Why root crops:

First, root crops can grow under a wide range of soil and climatic conditions. Second, the introduction of higher yielding varieties (esp. cassava and sweet potato) gives better promise for utilizing the crop both for family consumption and for income-generation. And third, the promotion of root crop processing technologies will not only increase the crop value but will also lessen the risk of dealing with crop perishability.

■ Nourishment from root crops:

Root crops are basically energy-rich foods. Aside from the tubers, the leaves (particularly of sweet potato, cassava and gabi) may also be eaten. Root crops in general also contain vitamins A, B and C, plus some other minerals essential for body growth. The Food and Nutrition Research Institute recommends that Filipinos should be having in their diets a daily intake of a small piece of root crop tuber (about 170g) equivalent to about one cup of rice. Some root crops (cassava and gabi) however, have to be prepared in certain ways

because a number of varieties contain certain levels of harmful substances like hydrocyanic acid and calcium oxalate raphides which can cause goiter and throat itchiness, respectively.

■ Some suggested root crop varieties:

Sweet potato: UPL Sp 1, 2 and 3; VSP 1, 2, 3, 4 and 5
Cassava: Lakan, Datu, Java Brown

■ Basic steps involved in some root crops processing activities:

- a. Flour: cleaning/washing, peeling, chipping, drying, grinding, sifting, and packaging and storing
- b. Starch: cleaning/washing, peeling, grating, starch extraction (squeezing the juice off the crop, allowing to settle and throwing away the liquid part), drying, and packaging
- c. Animal Feeds: washing/cleaning, chipping, drying, grinding/milling, mixing with other feed ingredients, and packaging

Note: The lead agency in root crops research and development is the Philippine Root Crops Research and Training Center in VISCA, Baybay, Leyte.

Utilization of root crop flour as wheat flour substitute:

Food Product	Acceptable Substitution Level
1. Paborita	50% C
2. Cheese	50% C
3. Coconut Cookies	50% C
4. Doughnut	50% C
5. Cinamon Roll	50% C
6. Soy Sauce	100% C/SP

Food Product	Acceptable Substitution Level
7. Polvoron	100% C
8. Butter Cake	100% C
9. Pan de sal	20% C/SP
10. Muffins	50% SP
11. Noodles	50-100% C/SP
12. Ca-charon	100% C

Root Crops Flow Chart

Major Steps in Root Crops Processing:

chipping
and grating

sundrying

grinding

starch
extraction

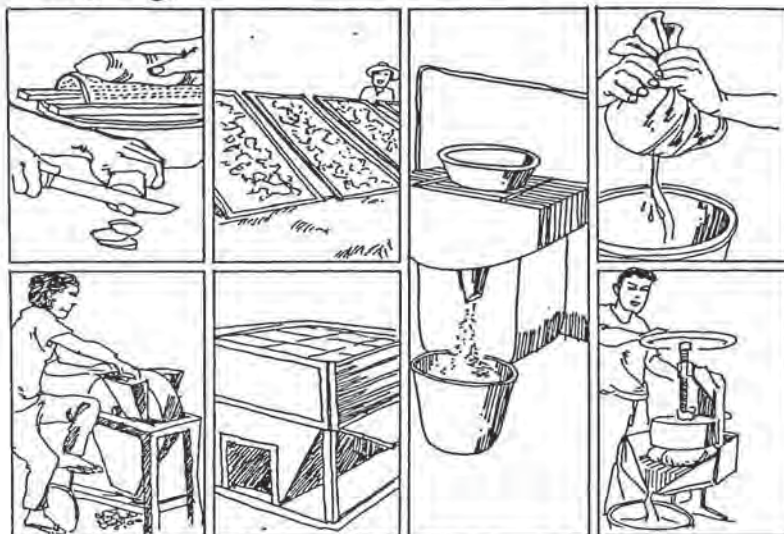
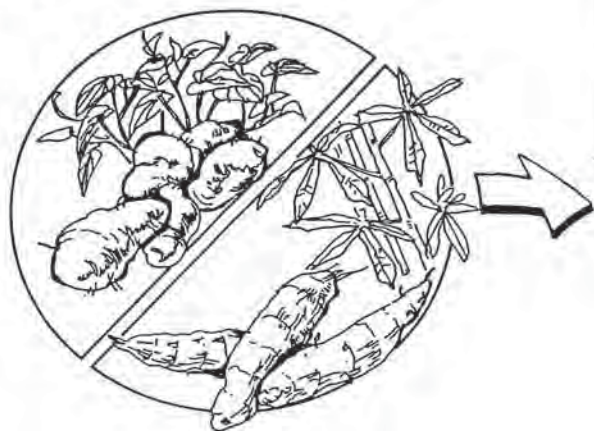

food for
the family



stores/bakeries



livestock raisers

Integrated Nutrient Cycling in Lowland Rice Production: An Ecosystem Approach

Basic Features:

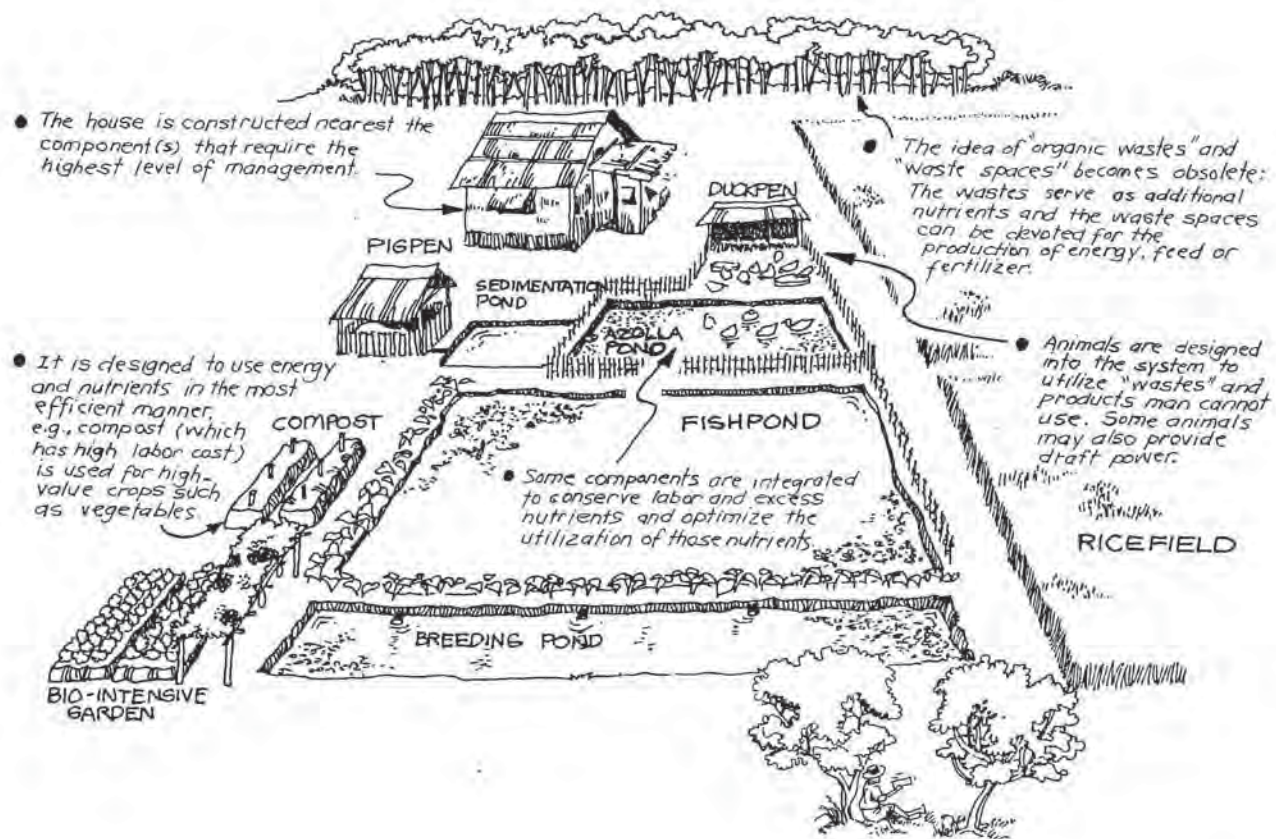

Other Features:

- Each component introduced into the system should contribute toward the goals of regenerating the land and sustaining the farming system.
- The system exhibits redundancy: each function meets more than one need, each need is met by more than one function.
- It starts simply and through careful observation and analysis of the area's resources, it evolves into a more complex, stable system.

Technical Profile:

As an example, a small area of marginal land near a water source (irrigation canal, creek or spring) can be used for the components below:

- Pig pen (2m x 4m) – Good for 2-3 heads of upgraded breed. Use local materials like bamboo for pen enclosure, cogon or nipa for roofing. Cement the flooring.
- Sedimentation pond (2m x 4m) – One meter deep. Install spill pipe in the dike 30 cm above pond floor for excess water going to the *Azolla* pond.
- *Azolla* pond (3m x 4m) – Maintain 30-40 cm water depth. Install another spill pipe in the dike for excess water going to the fish pond and to control water depth in the *Azolla* pond to 40 cm above floor level.
- Duck pen (1.5m x 3m) – Constructed near the *Azolla* pond for 1 male and 8-10 female ducks.
- Fish pond (10m x 3m) - Maintain 100 cm water depth for 600 *Tilapia nilotica* or other fish species fingerlings.
- Fish breeding pond (2m x 10m) – Maintain 65-70cm water depth for 8-10 female and 2 male *Tilapia* or other fish species breeders.
- B.I.G. plots (1.5m x 3m) - For production of various indigenous vegetables.

Potential Production:

- Pig pen – Gross sales in the amount of P6,000.00 for 3 upgraded (75%) pigs in 6-7 months using low-cost feed combinations.
- Sedimentation pond – Ready source of sludge for the garden and material for composting.
- *Azolla* – Provides fresh or cooked feed for swine, ducks and fish or can be used as green manure or composting material.
- Ducks - Regular source of meat and eggs for the family after 6 months.
- Fish pond – 50–55 kg of *Tilapia* can be harvested within 6 months.

- Garden – 1-1/2 kg of various vegetables can be produced daily throughout the year.
- Compost – 1.5-2.5 tons of compost can be produced annually.
- Woodlot – Fast-growing shrubs or trees can provide the fuel needs of the household. When planted along the paddy dikes and other waste spaces, the woodlot can also be a good source of wood for fence posts, trellises, etc.

Exercise to Increase Farmer Awareness of Integrated Nutrient Cycling:

While rice-based lowland farm systems are principally devoted to rice production, they also can involve a variety of production components and complex integrated systems. Small farmers have traditionally managed these complex farming systems and have an acute awareness of the cycles and flows of nutrients which occur on their farm within a cropping season or throughout the year.

However, resources can oftentimes be more intensely optimized by allowing farmers to critically analyze their farm nutrient flows in a systematic manner. This process can be implemented using a simple exercise with farmers. This exercise also helps field workers improve their skill in eliciting indigenous knowledge from farmers through the use of farmer's diagrams.

1. Explain the entire process to the farmers or ask them to help you (the technician) understand their systems – an important reversal for those who are usually telling farmers what to do.
2. Farmers are asked to list the individual components which make up their farm, i.e., paddy, fishpond, carabao, etc.
3. Farmers discuss the concept of nutrient flows within the farm. Linkages between the different components should be emphasized. The technician or farmer-leader can facilitate the discussion with leading questions.
4. Farmers are shown a design of the nutrient flows of an actual

farm and asked if they could produce a similar design for the conditions found on their farm. Many may answer negatively, stating that they cannot draw such a “professional” design (“I can’t draw like that”).

5. The farmer-leader or technician should then begin drawing a design using newsprint and pens.
6. The farmers are then provided with sheets of newsprint and pens and are asked to attempt to diagram the components of their farm and the nutrient flows which integrate those components. Exhaust all enterprises for possible inputs and outputs. Include all plots and land types that farmers have access to, even community resources.
7. The farmer-leader or technician should then assist the farmers and guide them in mapping out their individual farm design. All attempts at drawing should be validated -- anyone can draw to some extent.
8. Upon completion, the farmers are asked to present their designs for peer review and discussion by their farmer colleagues.
9. Finally, if desired, an artist can draw the design, based on the farmer-drawn diagram, to give the reproductions a “professional” touch.

This exercise provides a valuable methodology for farmer interaction. It is a learning process for farmers showing alternative uses of farm wastes and by-products being used by other farmers. The visual presentation reinforces what a farmer learns long after the exercise is completed. It is a learning process for technicians and field workers who learn about traditional knowledge. It helps to build a more equal relationship between farmers, extensionists and researchers. It helps to build self-reliance and confidence among farmers to make changes and adaptations of their farming systems, as well as validating farmer knowledge among farmers.

The following pages present artist reproductions of rice-based farming systems. The first design depicts a “typical” rice farm with little integration, under-utilized resources and costly off-farm resources. The other four are actual farmer designs of rice-based farming systems from the Philippines. All of these designs were developed using the exercise outlined above and have helped farmers to increase their own awareness of nutrient flows within their farm.

Fertilizer from Livestock and Farm Wastes

Materials

Dried rice straw/rice stubbles, grass clippings, coffee hulls, sawdust, etc.--these materials help prevent nutrient loss. They contain residual plant food of their own, adding to the overall nutrient value of the compost.

Bedding Method

1. Chop or shred the materials (except coffee hulls and sawdust) to make them easier to spread and later on easier to decompose.
2. Spread a six-inch layer of litter bedding over the floor space. Allow manure and urine to accumulate.



3. Three to four days after the bedding materials are fully soaked with urine, mix them so as to incorporate the manure. Remove the bedding and store it in a pit or a pile fully covered to conserve the nutrients. Collected bedding material can also be used in preparing liquid fertilizer. The compost is ready for use in one and a half months or earlier.

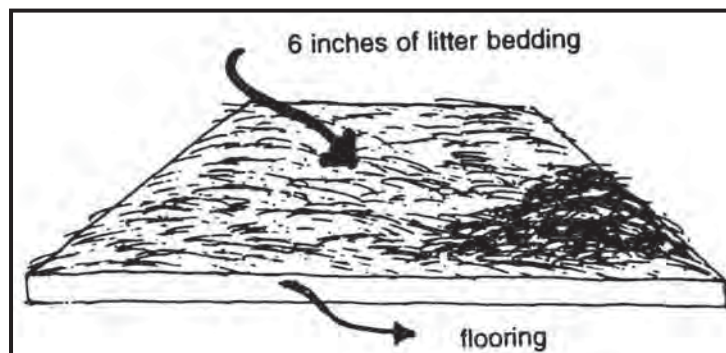

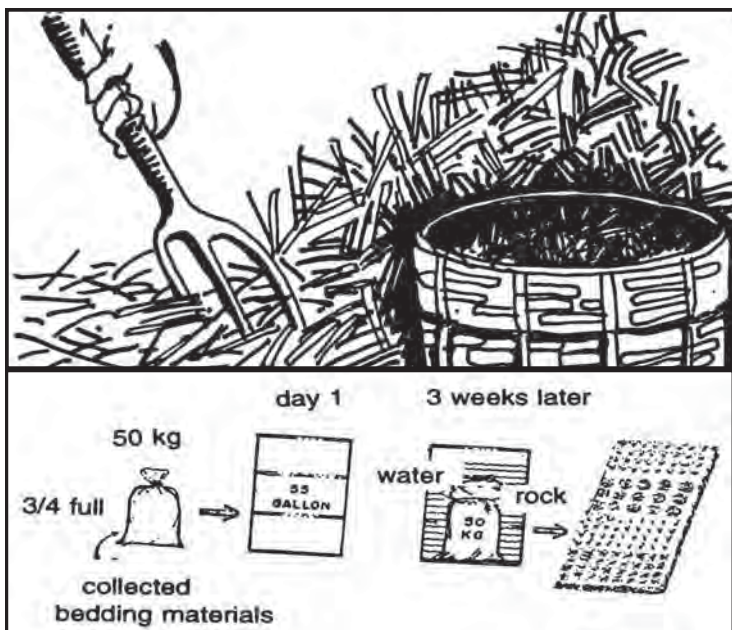

4. Provide fresh bedding materials as in #2

Technological Profile

- A feedlot cattle with an initial weight of about 150 kg would produce a total of 2.23 tons of fresh manure over a fattening period of 180 days.
- On the average, a cattle or a carabao excretes fresh manure equivalent to about 7.5 percent of its body weight.
- Manure — By wise management, animal manure can return to the soil 70 percent of N, 75 percent of P and 80 percent of K.
- Urine — Excess nitrogen from the digested protein is excreted in the urine as urea in cattle and goats.
 - Fifty percent of the value of the waste is contained in the urine.
 - Urine contains 2/3 of the N and 4/5 of the K discharged by an animal.
 - Elements in urine are more quickly available because they are in solution.

Source: IIRR and DENR. 1989. *Agro Forestry Technology Information Kit*, IIRR, Silang, Cavite, Philippines

- Urine is also an especially good activator for converting crop residues to humus.

Note: The amounts of fresh excrement produced by farm animals are subject to wide variations, being governed by the kind of animal, its age, the amounts of food it eats, its activity and other factors. The amount produced annually per 1,000 pounds of live weight is given in the following table:

On the average, a ton of cow manure has NPK values equivalent to 100 pounds of 2-12-3-9 chemical fertilizer. Similarly, horse manure averages 14-5-11, sheep and goat manure 19-7-20, hog manure 10-7-8 and chicken manure about 20-16-9. In addition, this manure will supply organic matter and trace elements.

Amount of excrement produced by farm animals.

Source	Fresh excrement	Liquid %
Cattle	12.6	85
Horse	5.8	66
Poultry	5.6	62
Sheep	5.9	66
Swine	13.2	85

Pounds of Nitrogen, Phosphate and Potash per ton of animal manure

Source	Nitrogen	Phosphate	Potash
Cattle	10.6	2.7	7.5
Horse	14.9	4.5	13.2
Poultry	29.9	14.3	7.0
Sheep	23.0	7.0	21.7
Swine	12.9	7.1	10.9

Source:

P.S. Faylon and M.R. Deriquito. Livestock Manure as Fertilizer: Waste Not, Want Not. J.F. Rodale. The Complete Book of Compost. The Encyclopedia of Organic Gardening. pp. 714-716. Nyle C. Brady. The Nature and Properties of Soils. 8th Edition (New York: MacMillan Publishing Co. 1974).

Composting Methods

Conventional Method of Compost Preparation

1. Choose a spot that is at least partially protected from rain.
2. Gather the crop residues, animal manures and other wastes and bring them to the preparation site.
3. Pile the crop and other plant residues (15 cm thick) first. For the next layer, spread the animal manure to a thickness of about 8 cm, followed by about 3 cm of good soil. Pile another layer of the materials in the same sequence and repeat until a height of about 1.5 meters of the compost pile is attained.
4. Water the pile until it is sufficiently moist. Water regularly.
5. Turn over or mix the pile with spading fork after 3 weeks, then again after five weeks.
6. Harvest the compost in three to four months.

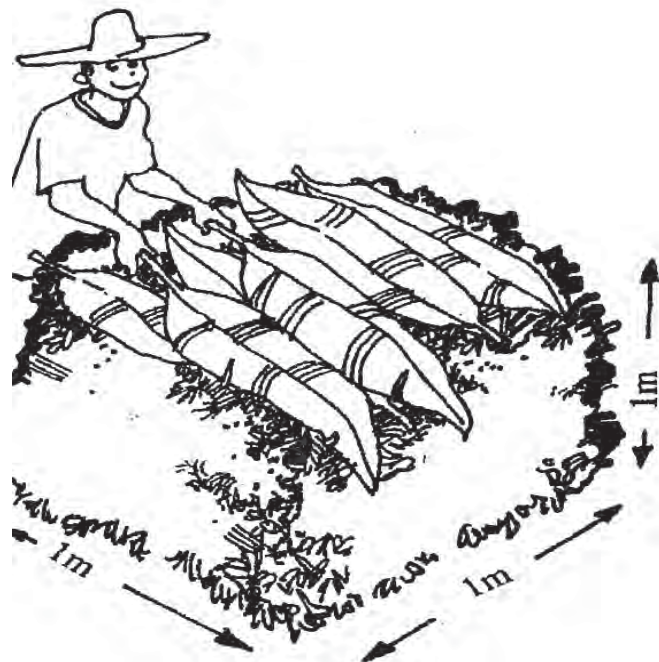
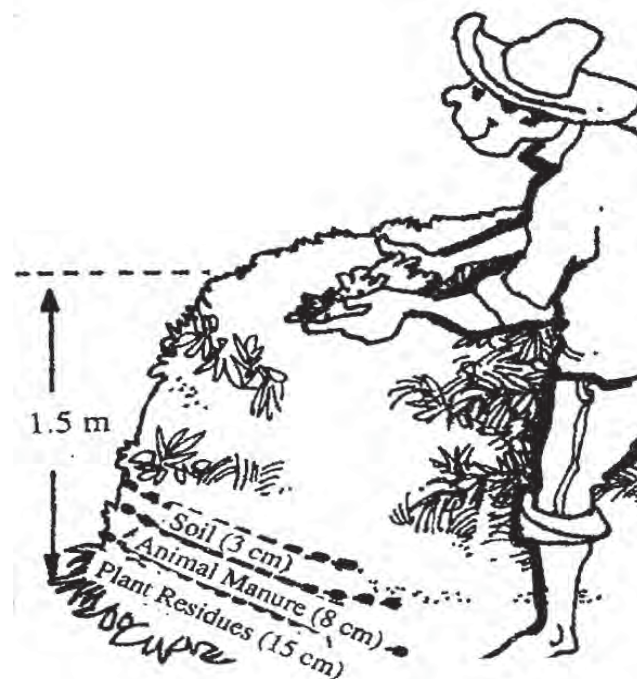

The 14-day Method of Composting

1. Chop the vegetative materials/plant wastes (dry or green or both).
2. Thoroughly mix these with an equal amount of fresh manure.
3. Pile the mixture into a heap measuring at least 1m x 1m x 1m. (However, 1m is the maximum height.)
4. Cover the heap with banana leaves or damaged burlap sacks.
5. By the third or fourth day, the inside of the heap should be heated up. If not, mix more manure into it.
6. On the same day (3rd or 4th), turn the heap inside out so that the materials from the center will appear outside and vice versa.
7. Turn the heap every two days thereafter.
8. In 14 - 18 days, the compost should be ready for use.

Composting in Triple-compost Bin

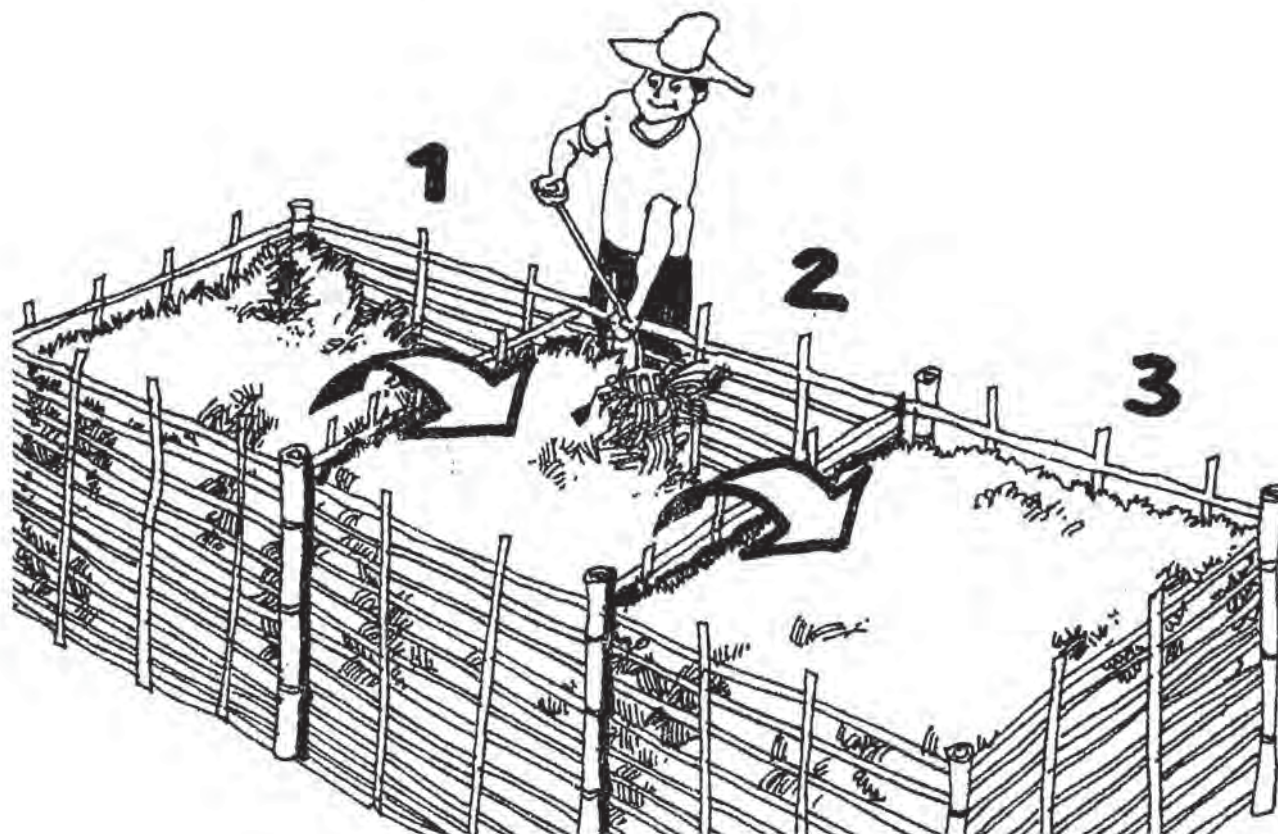

Making three compartments permits us to keep adding to our compost pile. The compartment at left is ready for the fields while the others are still rotting.

1. Fill compartment one with composting materials.
2. Add a small amount of soil or animal manure.
3. Continue in this way till the compartment is full.
4. After a month, empty the contents of compartment one into compartment two, mixing, watering and breaking up the compost in the process.
5. Cover the second compartment with a layer of soil, which has to be kept humid and loose.
6. Once compartment one is empty, the process of filling it should begin again as before.
7. After another month, fill compartment three with the contents of compartment two, airing the contents well without turning over.
8. Cover the third compartment with a layer of soil.
9. Fill compartment two with the contents of compartment one and cover with soil.
10. Fill compartment one with refuse and the cycle goes on.

Basket Composting

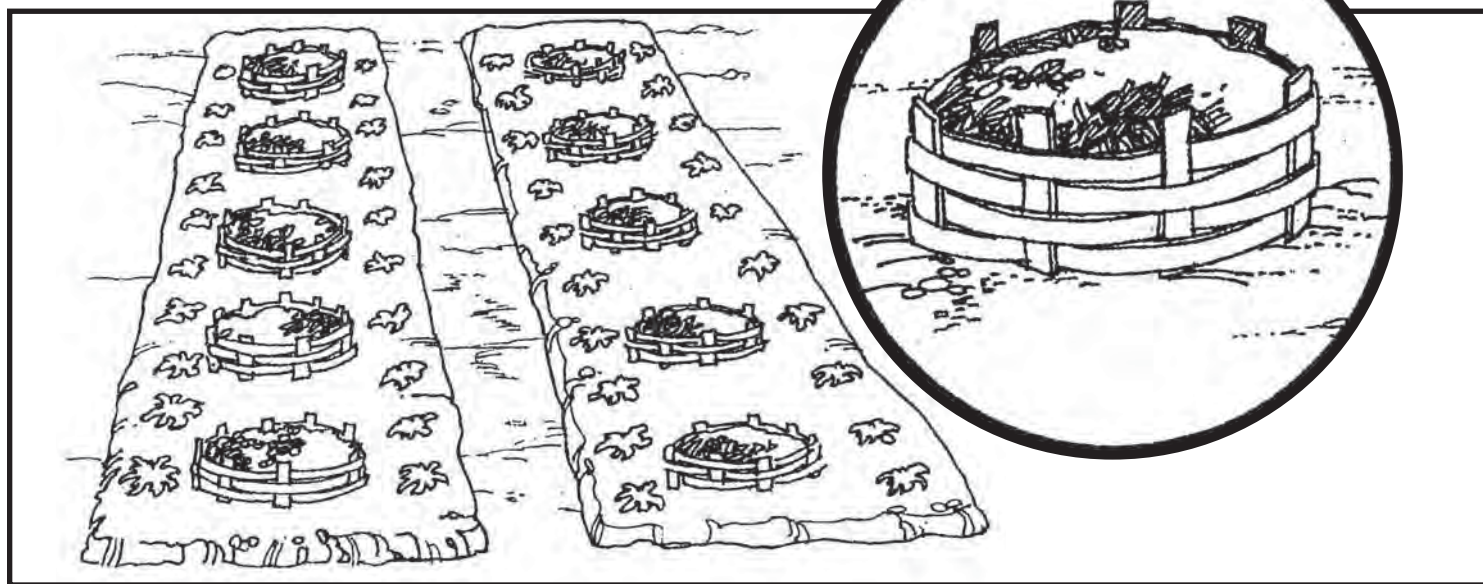

Basket composting is the process by which decomposable home garbage, garden and farm waste and leguminous leaves are allowed to rot in baskets half-buried in garden plots as a method of producing organic fertilizer.

Benefits

1. Basket compost can be used immediately without waiting for the usual 3-4 month period as is necessary in other methods of composting.
2. Baskets hold the composting materials in place, hence minimizing nutrient depletion by runoff.
3. Stray animals and fowls are prevented from scattering the compost materials.
4. Since garbage and wastes are collected and utilized, home and surroundings will become cleaner.
5. It serves as reservoir and collector of the moisture and nutrients.
6. More nutritious vegetables can be produced at less cost.

Preparation of Materials:

- Long bamboo strips, 2-3 cm in width
- Bamboo stakes at least 30 cm in length
- Home organic garbage, farm and garden wastes, leguminous leaves
- Manure

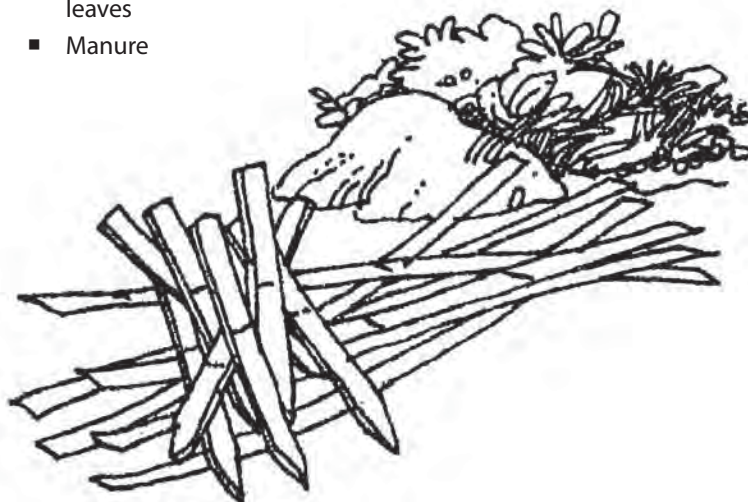

Preparation of Garden Plots

- Clean garden site, save weeds and grasses for composting.
- Dig at least 30 cm deep and raise the bed,
- Dig holes along the center of the plots at least 15 cm in depth and 30 cm in diameter.
- Space them 1m apart.

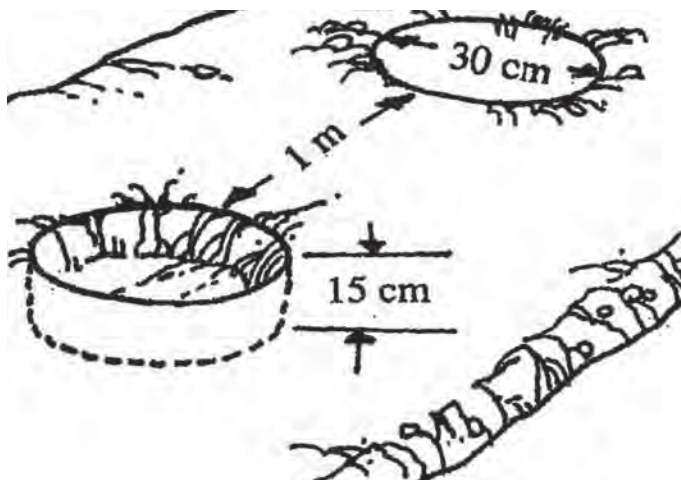

Construction of Baskets

- Drive 7 stakes around the holes; uneven number of stakes (5,7 or 9) makes perfect brace for weaving.
- Weave the long strips of bamboo around the stakes to form a basket. Without bamboo strips, closely space the stakes (about 1 cm apart).

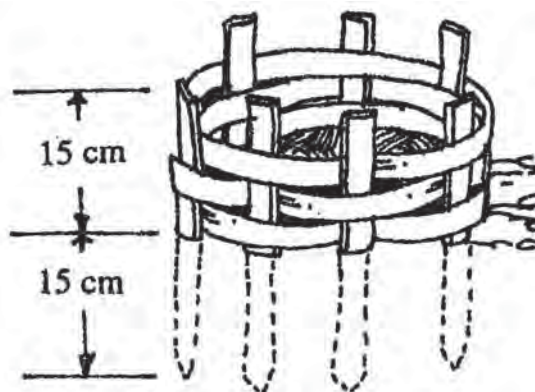

Addition of Organic Wastes

- Place the most decomposed garbage and manure into the basket first.
- Place the undecomposed materials like leguminous leaves, grasses and weeds next.
- Fill to the brim with other organic wastes.
- Earthworms maybe added to speed up decomposition.



Planting and Care and Maintenance

- Plant seeds or transplant seedlings around the basket. The distance from the basket should be 15 - 20 cm to prevent the decomposing materials from "burning" the plants.
- Water the seedlings while young. Eventually just water the basket. The plant roots will later move toward it.

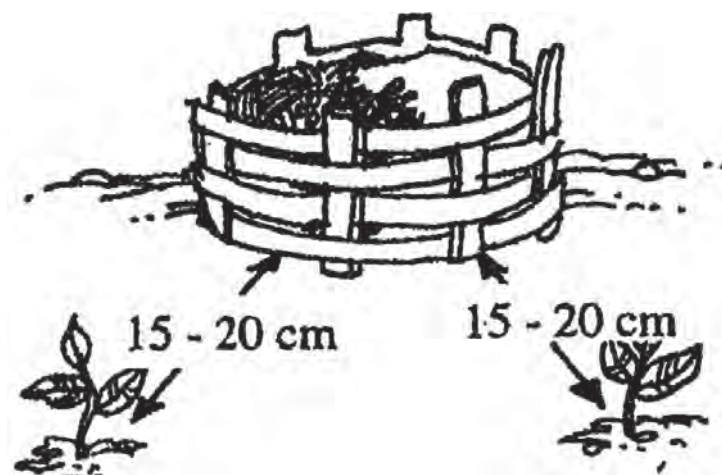

Incorporation of Decomposed Materials into the Soil After Harvesting, Composts are Already

- After harvesting, composts are already used up. Remove the decomposed materials from the basket and incorporate them into the soil while cultivating.
- Add new composting materials to the basket for the next plants.



Deep Bed Composting

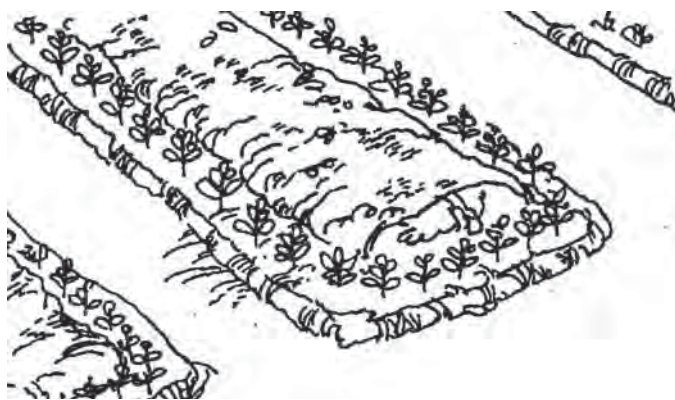

Garden Layout

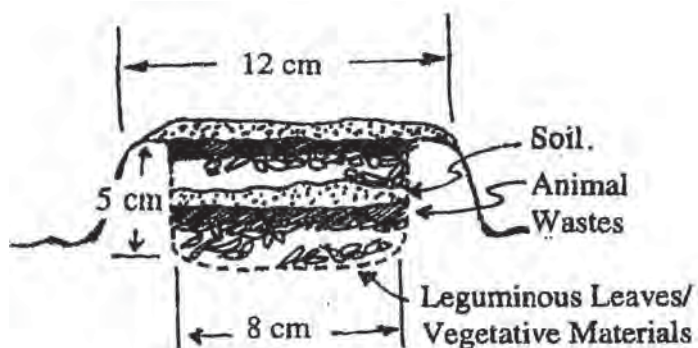

Cross-section of Composting Bed

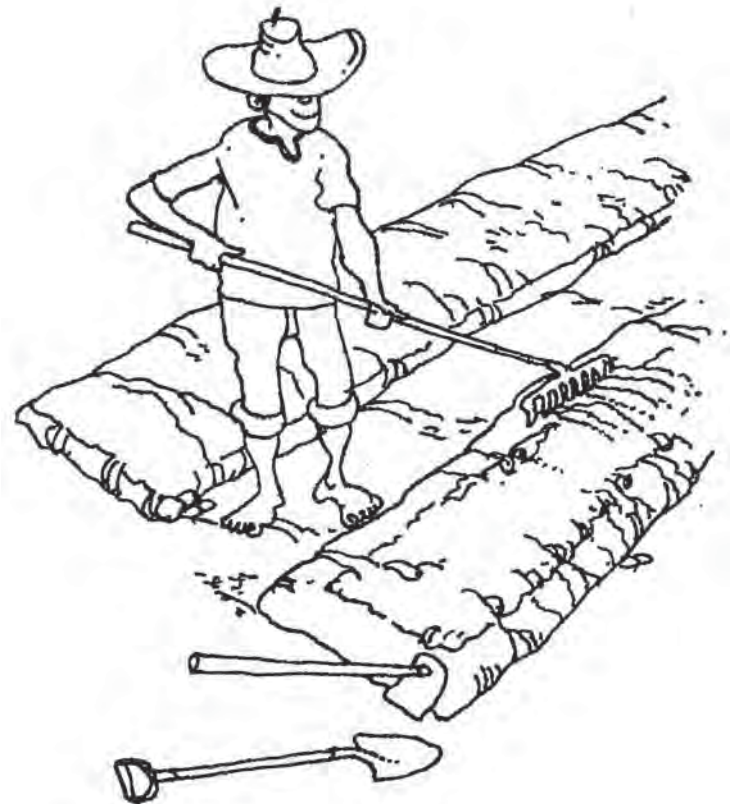

Bed Construction

- Layout garden beds at least 12cm wide.
- Dig trench 8cm wide and 5cm deep along center line of bed. Place spoil (dirt from trench) on both sides of trench.

Addition of Organic Materials

- Place 15 - 30 cm layer of leguminous leaves and other vegetative materials.
- Spread layer of animal wastes over vegetative materials.
- Cover with layer of soil. Use 1/2 of spoil pile along side of trench.
- Pile another layer of the materials in the same sequence, returning all of spoils in or on trench.
- Shape bed by raking.

Planting

- Soak bed thoroughly with water.
- Plant seeds or transplant seedlings around the trench.
- After harvesting, remove the contents of the trench and work the compost into the soil around the trench. Place new compost materials in the trench for the next crop.

Semi-sunken Composting

1. Clean the area selected for building the compost pile. Dig a hole one-half meter deep



2. Cut composting materials into small pieces. Mix them with manure at 5:1 ratio.



3. Place the mixture in the hole until it reaches one to two meters above the ground. Use a shovel or your hands to keep the edges square.



- Cover the pile with straw or smear it with mud to protect it. Add a layer of soil on top of the pile and make a series of holes on top of the finished pile. The compost should be ready in 1 to 2 months.

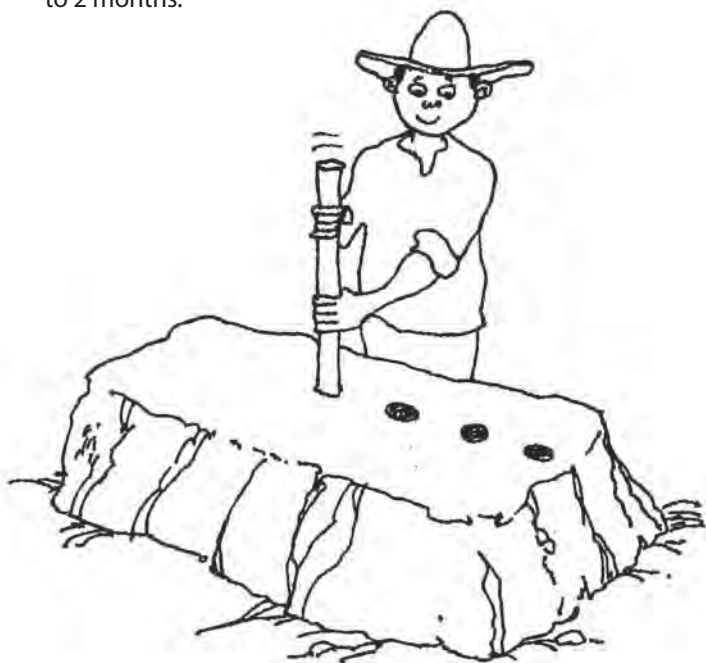

Organic Fertilizer Sources:

Liquid Fertilizer from Leguminous Trees

Liquid fertilizer supplements can be made from leaves of leguminous trees and water (traditionally, only fresh manure has been used.) Liquid fertilizers are used in small gardens to boost up the growth of young seedlings or as a remedy for plants suffering from nutrient deficiencies.

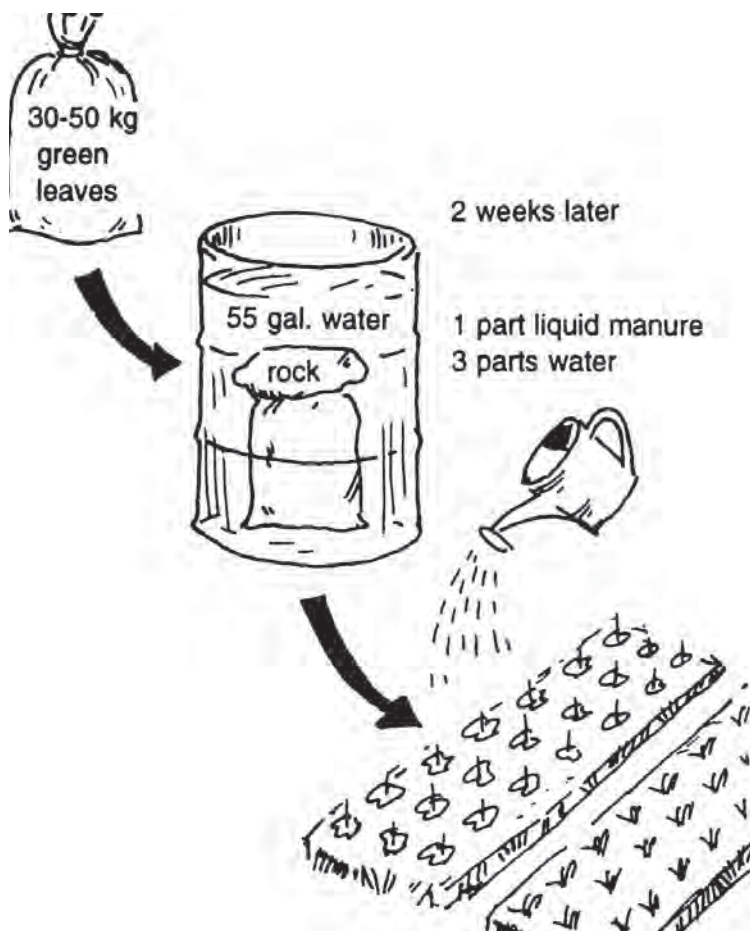

Nutrient content of liquid fertilizer

Tree Species	NH ₄ -N ppm	Organic N ppm	Total N ppm	ppm P	ppm K
1. <i>Gliricidia sepium</i>	169.0	12.0	181.0	1.8	218.5
2. <i>Leucaena leucocephala</i> (ipil-ipil)	97.5	35.5	133.0	11.1	234.0
Compared with: Cow manure	26.7	4.9	31.6	2.6	158.5

Note: Very significant readings for iron, calcium, magnesium and zinc were also noticed.

- You may test leaves of other leguminous trees in your area. If leguminous leaves are not available, any green plant material may be used (e.g., *Cassia siamea*, *Cassia spectabilis*).
- Keep the drum always covered. If a drum is not available, then a pit lined with clay or plastic sheeting or even a large earthen pot may be used.
- Replace the leaves with fresh ones when the liquid fertilizer has been exhausted.
- It is possible to raise a reasonable vegetable plot in well-dug soil (12" - 18" deep at least), using liquid fertilizer alone.
- Liquid fertilizer is a critical component of a bio-intensive garden in the tropics, especially in the rainy season when leaching is common.

Organic Fertilizer Sources: Use of Green Manure

The term *Green manure* generally refers to the use of fresh organic materials such as leaves, twigs and small stems which are used as a soil enrichment material. The green material does not only provide the soil with needed macro elements (such as Nitrogen, Phosphorous and Potassium), but trace elements as well (such as magnesium, manganese, cobalt, and iron). In addition, the green manure: (1) provides organic matter which helps improve soil structure, increases the soil's water holding capacity; (2) provides a replacement for commercial fertilizers; and, (3) helps shade weeds. Some green manures can also be grown with food crops to save area and labor.

Materials for Green Manure

Many plants which belong to the Legume Family are commonly used as green manures. These include cover crops such as Kudzu (*Pueraria phaseoloides*), "Hetero", (*Desmodium heterophyllum*), Centrosema (*Centrosema pubescens*), Siratro (*Macroptilium atropurpureum*); upright legumes such as: Ipil-ipil (*Leucaena diversifolia*), Rensoni (*Desmodium rensonii*), Flemingia (*Flemingia macrophylla*), Madre de cacao (*Gliricidia sepium*), Rostrata (*Sesbania rostrata*) and Rice bean (*Vigna umbellata*). Non-legumes include grasses such as Napier (*Pennisetum purpureum*) and Guinea grass (*Panicum maximum*). Essentially, any material may be used as long as it is fresh and not very woody in form.

Methods of Using Green Manure

There are two standard methods in using green manure. These are (1) growing the green manure crop in the crop field; and, (2) importing the green manure in fresh or processed form to the crop field.

1. Growing the Green Manure Crop in the Field.

This method involves growing a cover crop, usually a legume such as spineless mimosa (*Mimosa invisa*) or Hetero (*Desmodium heterophyllum*), in a field and then plowing the plant in the soil after a few months' growth. The cover crop is planted for one season, plowed under and allowed to decompose. The next crop is usually a main food crop, such as corn. The green manures should be allowed to rot three to four weeks before planting the following food crop.

A second method involves planting food crops that have a short growing season and leaves which do not shade the ground too much with the green manure crop. Corn and peanuts are good examples. Since the green manure crop needs some light, the food crops should be spaced further apart but seeds should be planted closer together in a row.

A third method involves the planting of hedgerows of upright legumes such as Rensoni (*Desmodium rensonii*), Flemingia (*Flemingia congesta*) and Madre de cacao (*Gliricidia sepium*) in the field along the contour (e.g., SALT, alley cropping). These plants are periodically harvested and the leaves and small branches placed on the soil surface between the hedgerows as a mulch. The leaves are allowed to decompose. Crops may or may not already be planted in the field. In some cases, the farmer may physically incorporate the green leaves into the soil by using a hoe. If this is done, there should be a waiting period of about one month before the field crop is planted in the field.

It is highly recommended that two different species (one with big leaves and another with small leaves, e.g., *Flemingia*

and Rensoni) should be planted in the same hedgerow along contours. *Flemingia* has leaves which decompose slowly while the Rensoni leaves which decompose slowly while the Rensoni leaves are soft and decompose quickly.

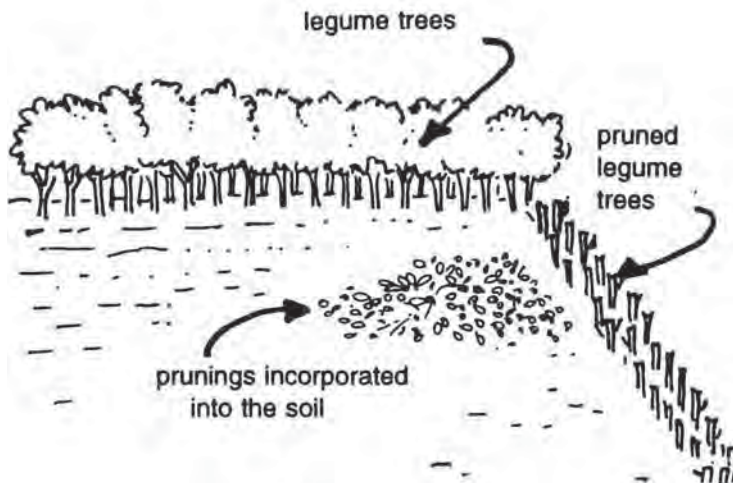

2. Green Manures Imported in the Field.

Green manures need not be grown right in the crop field. Farmers can plant them around their field as fences or in vacant areas. The branches are pruned two to three times a year and the prunings are carried to the field where they are either incorporated into the soil or used as a mulch.



3. Special Methods of Using Green Manure:

- Green manure tea. This method is described in detail as a separate topic in another section. In general, it involves taking legume or other fresh leaves and placing them in a jute sack or the like. The sack is soaked in water for 10 days. The tea is used to water high-value crops (like sweet potato, eggplant, cabbage) while the partially decomposed leaves from the tea bag can be used as a mulch or compost material.
- Compost. This method involves using green legume leaves to activate a compost pile since the fresh green leaves have a supply of nitrogen. When the composting process is finished, the material is used as a fertilizer by placing it in a hole and covering it with soil. A seedling is planted on top. This method is generally used for high-valued crops such as vegetables.

Considerations:

1. Non-legumes such as wild sunflowers are used as a green manure either by incorporating the leaves and stems directly in the soil or allowing them to partially dry before incorporation. Wild sunflower is also a phosphorous trap, as it accumulates the element as it grows.
2. Cogon and other grasses or weeds can be cut before the flowering stage and placed in crop fields as mulch.
3. Green manures can be applied to furrows or between the crop rows rather than as a blanket covering. This method concentrates the nutrients and the roots of the row crop, such as corn, will pick up the slow released nutrients from the furrow. The weed growth in the furrow or inter-row area will also be reduced. For minimum tillage systems, placing the green manure in furrows in between rows allows easier access to the crop rows for planting and weeding.
4. Farmers frequently air-dry green leaves before using them as a crop fertilizer. This is frequently done with leaves such as ipil-ipil. The drying process releases Nitrogen from the leaves but other nutrient elements such as phosphorous, potassium and

trace elements remain in the dry leaf. This process prevents accidental fertilizer burn from fresh leaves.

- 5 Experience has shown there are several kinds of leaves which are not good for green manuring because they contain substances which are detrimental to the plants and the soil. These are Pine needles, *Eucalyptus* sp. leaves and *Gmelina arborea* leaves.

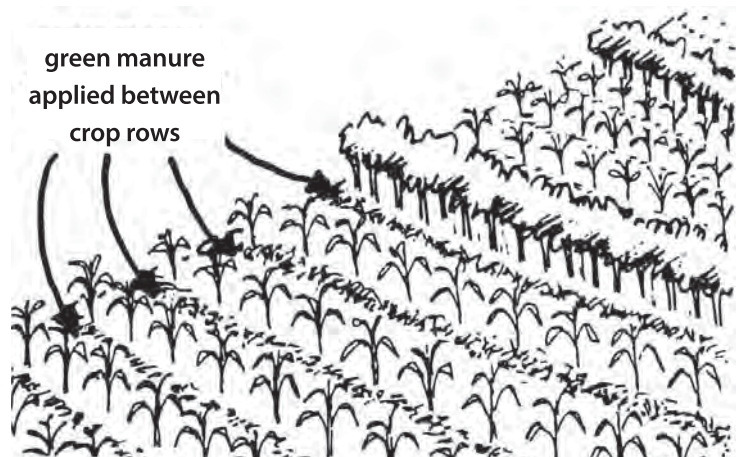

Kakawate or Madre de Cacao: A Multipurpose Crop

Kakawate (or *Gliricidia* or Madre de Cacao) is a multipurpose tree that every farmer should grow in order to beat the impacts of climate change on agriculture.



- Provides green manure which can fully sustain the nutrient needs of crops. It also provides fuel wood, poles and fodder.
- Green Leaf Fertilizer from 600 trees grown around a plot can provide needed nutrients for one hectare of paddy rice
- (B. Rao et al, 1996)

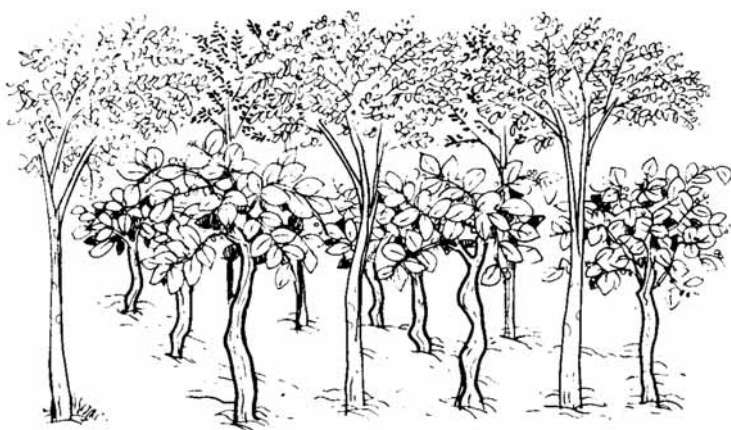

- Kakawate can be used shade and mulch and fertilizer crop for coffee and cacao and tubers such as Gabi and for Ginger
- Kakawate can be used as support for black pepper

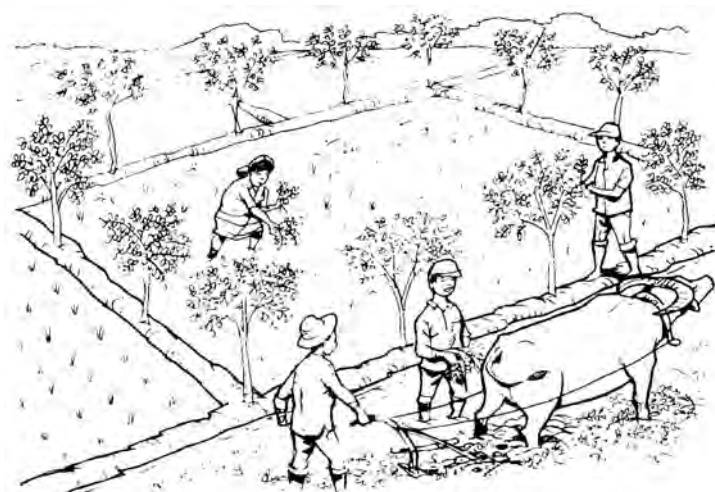

- Kakawate can be used on farm boundaries for preventing wind action.
- 2m long stakes (15-20cm in diameter) are planted 1 meter apart.



- Kakawate is an excellent liquid fertilizer. A bag of green leaves is soaked in a drum of water and the resulting extract is diluted 1:3 with water and used

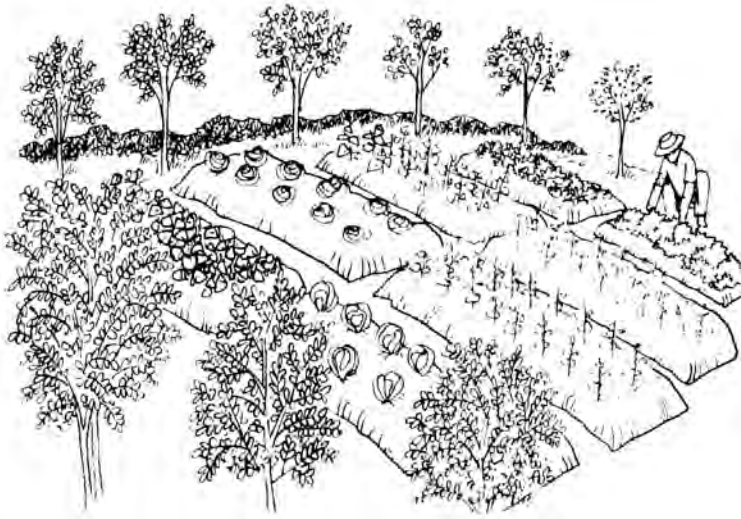

- Kakawate can meet all the fertiliser needs of a vegetable market garden while lowering temperatures.
- It also provides protection from typhoons.

For maximum effects, kakawate should be grown all around the farm and in between crops/trees. Trees should be cut 1 meter above ground level at least two times a year and leaves should be applied around plants.



- Kakawate is high protein can be fodder which mixed with rice straw and fed to livestock (up to 20 percent only). To improve palatability, the leaves should be allowed to wilt for 18-24 hrs



- Kakawate seeds can be ground as used to kill rats. Kakawate leaves are also an excellent botanical pesticide.
- Its leaves can be used to control skin disease in animals.

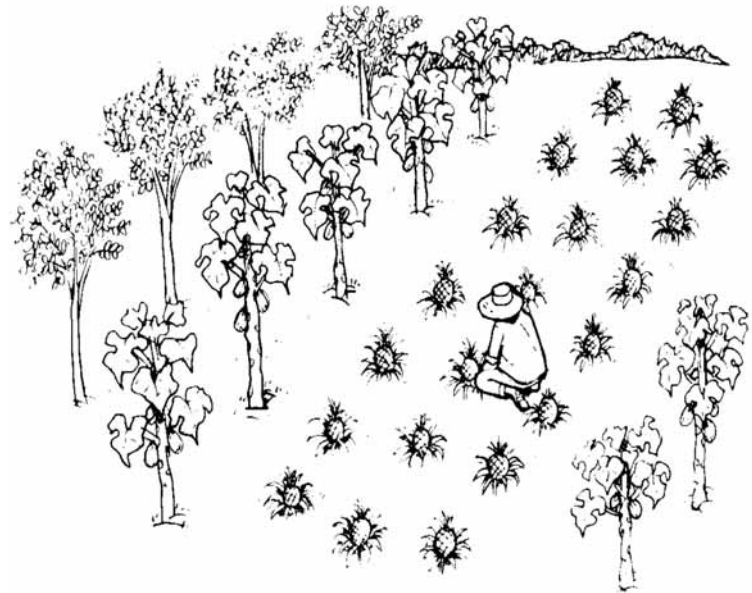

- Farms which use kakawate are cooler, they are rich in organic matter and allow a farmer to go organic

Botanical Pesticide Formulation

A. Materials needed

Madre de Cacao 1/2 kilo of leaves	20 liters of water	Pail
Grinder or mortar and pestle	Strainer	

B. Procedure:

Pound and pour the Madre de Cacao leaves
Soak overnight in 20 liters of water in a pail.
With the use of a strainer, strained the solution.

Source:

Alfredo Rabena

University of Northern Philippines

Vigan Philippines

Outplanting Seedlings

Many seedlings from the wilds die when planted out in the field. High seedling mortality is often caused by careless handling and planting. While proper species choice is of primary importance, a farmer should be able to greatly increase his success in raising trees by following these guidelines.

Prepare the Seedlings

Use only good seedlings. This means seedlings that have been properly hardened off, with a woody stem 30-50cm tall. Discard all damaged, deformed or diseased ones. Taller seedlings may be used in cogonal areas so they will soon overtop the grass. For dry and harsh environments, older seedlings with a more developed root system and thicker stem (more sugar reserves in the stem) will survive better.

Potted seedlings will survive better in harsher sites than bare-root seedlings because they have a more complete roots system which will not be disturbed.

- Make sure potted seedlings have a well-developed rootball. Do not water them on the day they are outplanted because this will soften the soil and cause it to compact when planted. Seedlings brought from a distant nursery should be brought to the planting site and allowed to recover from the transportation shock for 2-4 weeks before outplanting. Fruit tree seedlings purchased from a commercial or government nursery usually need to be hardened off at the planting site before outplanting as this is not done at the nursery.
- Gently lift bare-root seedlings from the seedbed with a spade or shovel. Trim the tap root to about 20cm for easier planting. Also, trim the crown to reduce water loss through transpiration and bring it into balance with the root system. Cut back any soft green shoots, leaving at least 30cm of woody stem.

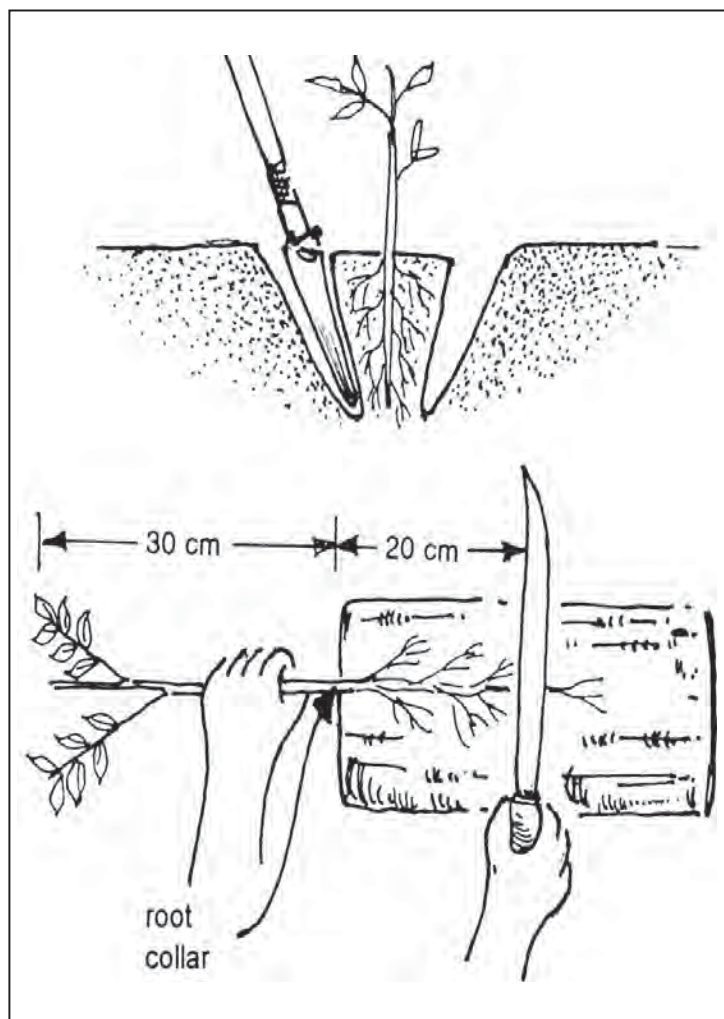

Mud-pack bare-root seedlings when they are to be transported. Dig a hole and mix in pure clay soil and water to make a slurry. Rinse off the seedling roots and dip them in, coating them well. Wrap them in folded banana stem sections or sacks and keep them in the shade. Roots and stems are easily killed when exposed to heat or direct sunlight. If the trip is long, remoisten the containers.

Outplanting

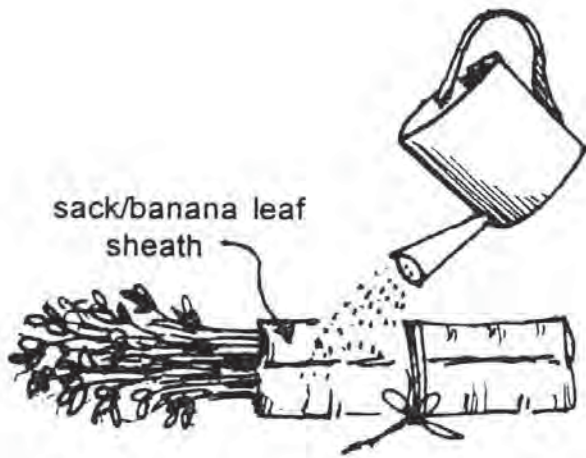
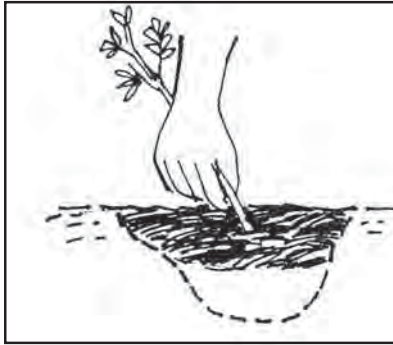

- Some trees, such as *Gmelina arborea*, can be planted by stumps. Prepare as for bare-root seedlings but cut back the stem to only 1cm. Ideally, stumps should be 1cm across. This is one way of handling overgrown seedlings. They are also easier to transport to the field.

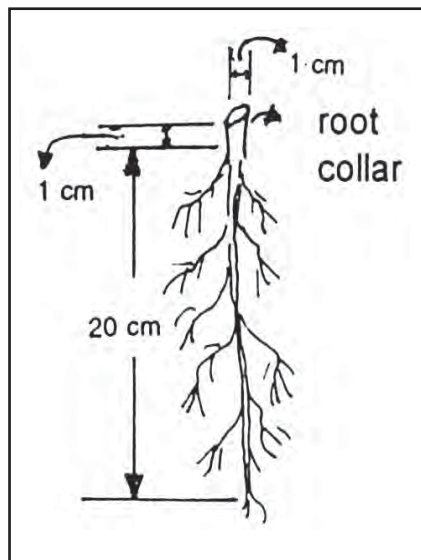

- Timing of outplanting is crucial. Plant at the beginning of the rainy season but only after the soil has become fully moistened. In areas with a severe dry season, make sure trees are in the ground early enough to develop a deep root system before the dry season hits. Cuttings, such as kakawate, may be planted late in the dry season so the cut end or wound dries out before the soil becomes wet.
- When outplanting potted fruit trees, slice off the bottom 1 cm off the plastic bag. This will eliminate any bend that has begun to form in the taproot. Slice the rest of the bag down the side and remove before planting.

In poor soils, plant in a hole much larger than the root ball. If manure is to be added and has not yet been allowed to decompose, put it in the bottom of the hole and cover it with 10cm of soil. If chemical fertilizers are to be used, mix them in with the soil to be used in filling up the hole. Scrape topsoil from the area around the hole and use it to fill it up after planting the seedling. Gently step on the soil around the seedling to tamp it down firmly.

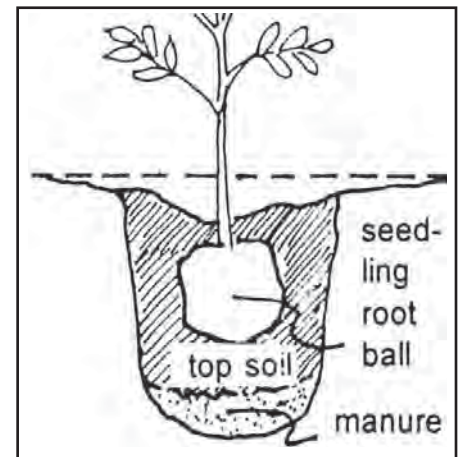
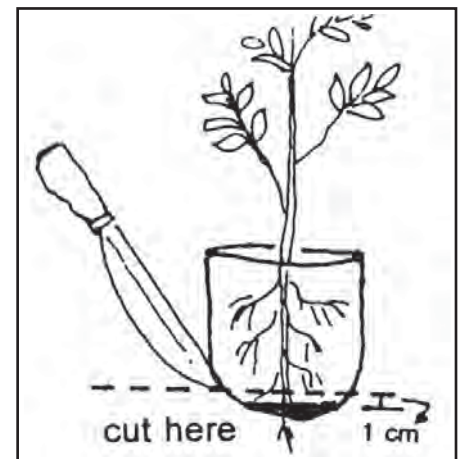

In drier sites, recess the seedling slightly into the ground to form a small catchment to trap moisture.

- Bare-root seedling outplanting is easiest with two people, one to hold the seedling upright in the hole and one to fill the hole in and tamp the soil down. Be careful not to bend the taproot.

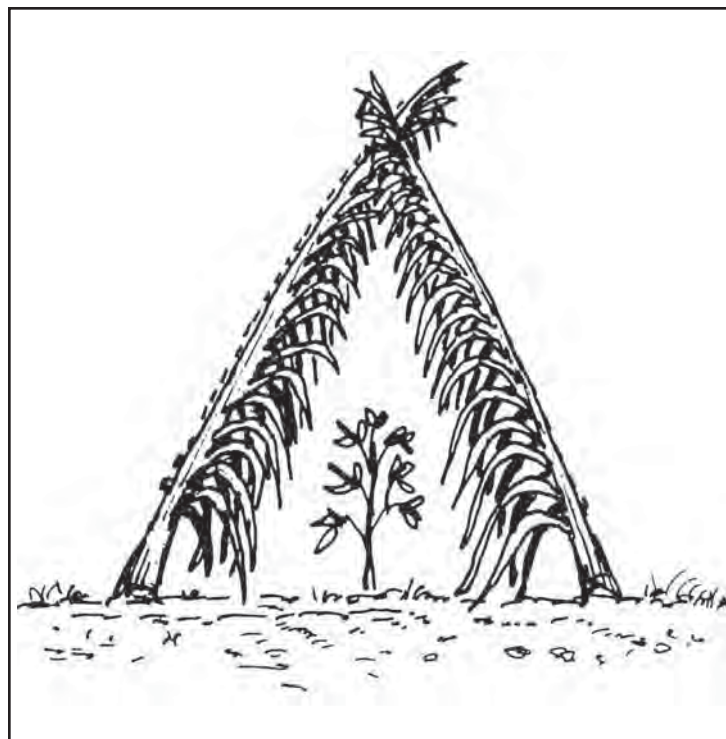
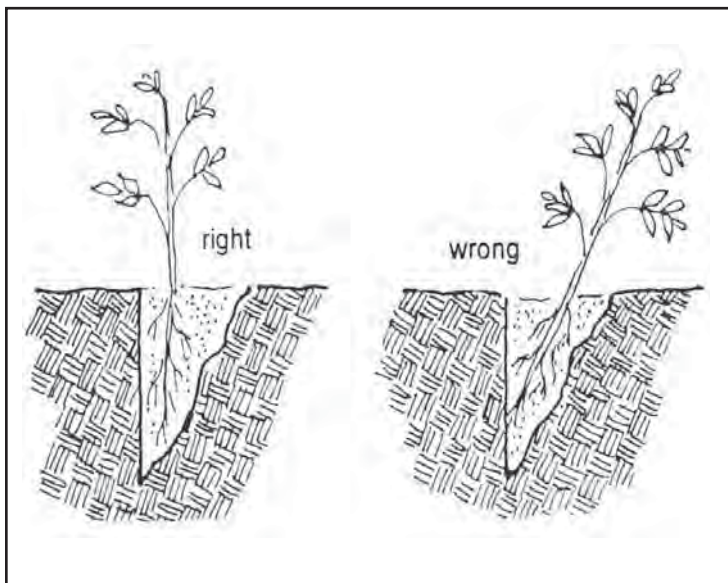

- Mulch newly planted seedlings to conserve moisture and keep soil surface temperatures cool. Apply a 10cm thick layer of mulch in a ring 10cm away from the stem. This can be renewed every two weeks.
- In areas where livestock are allowed to wander loose, fence newly planted seedlings off from grazing areas.
- Erect a temporary shade for especially valuable seedlings or seedlings that have not hardened off enough. This can be as simple as two coconut leaves leaned against each other or it can be made of cogon grass.

Source: IIRR and DENR. 1989. *Agro forestry technology information kit*. IIRR, Silang, Cavite, Philippines

Selection of Cover Crops

Cover crops are plants which are grown to cover and protect the soil. They help add fertility, improve soil structure and water retention and have a lot of practical benefits such as animal fodder, food and added farm income.

Cover crops can be used in a variety of ways in agricultural systems:

1. Interplanted or relay-planted with maize or other grain crops



3. Planted under trees in orchards or plantations

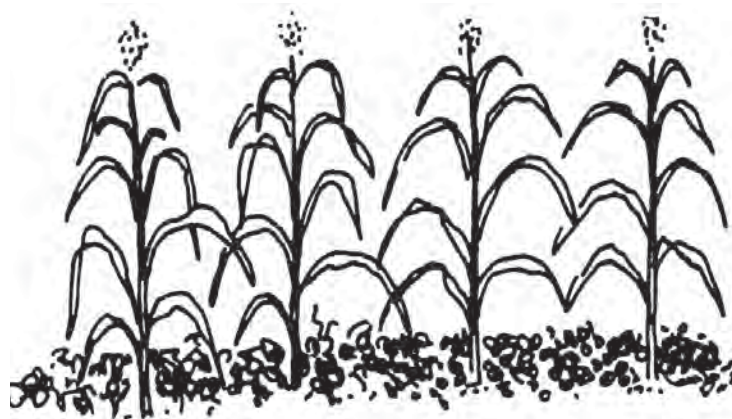

2. Planted alone in the cropping cycle



4. Planted as a fallow crop when the land is being rested

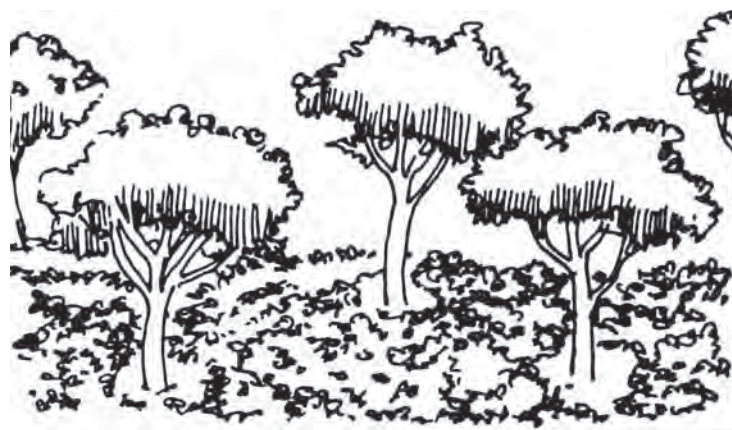

Note: For suggested species suitable to the above systems (1-4), please refer to accompanying table under systems applicable.

Cover Crops Offer Farmers the Following Benefits:

1. Improved soil fertility through the addition of significant amounts of nutrients (more than 200kg N/ha).
2. Suppressed weed growth.
3. Reduced labor demands in soil preparation and in weeding
4. Reduced cost of inputs such as fertilizers, herbicides and hired labor.
5. Improved soil structure: cover crops can provide up to 30 tons of organic matter per hectare. Improved soil structure means a better medium for plant growth; in addition, it improves the soil's ability to retain moisture during dry periods.
6. Soil and water conservation: cover crops help reduce erosion by protecting the soil surface for extended periods of time.
7. Rehabilitation of degraded marginal lands.
8. Additional benefits: human food, animal forage, fuelwood and an added source of income.

There are many plants which can be used for cover crops, depending on local conditions (rainfall, soils, local farming practices) and the objectives of farmers. However, most of the cover crops belong to the family of plants known as Leguminosae (beans).

The following general characteristics are considered important in selecting plants for use as effective cover crops:

1. Rapid, prolific growth habit
2. Ability to fix significant amounts of nitrogen
3. Tolerance to a wide range of soil conditions (poor fertility, texture or structural qualities, extremes in pH, etc.)
4. Good drought tolerance. This is an especially important factor since most of the green manures are grown during the dry season.

5. Seed availability or the ability of the plant to produce its own seed locally
6. Shade resistance, since cover crops are frequently interplanted or grown in relay with taller grain crops or trees
7. Proven pest resistance
8. Easy to control. Cover crops must be readily removed from the farm when the time comes for land clearing.

Potential Problems with Cover Crops:

1. Cover crops can be difficult to establish and farmers often perceive them to require extra work. Some farmers have been concerned that cover crops might compete with their staple crops.
2. Some cover crop species can be very aggressive and may be difficult to eliminate from the farm.
3. Cover crops can become an alternate host to pests which attack food crops.
4. Rats and snakes may hide in the dense foliage of cover crops.

In general, the most popular cover crops are indeterminate (continuously produce flowers and pods), single-season legume species. However, perennial species can be of great value under certain circumstances; determinate bean species and even tuber crops such as camote can be used as effective cover crops. Some of the cover crops which have been used successfully by farmers are shown in Table 9.

There are many other species of plants which have been used traditionally by farmers to serve the same purpose as the above-mentioned cover crops. Many of them are as yet undocumented. Additionally, there are other plants which could also be used. Cover crops are gaining attention from farmers and agricultural scientists and they deserve much more field trials and research.

Table 9. Selected cover crops.

Scientific name	Common name	Remarks	System Appli- Cable
<i>Mucuna pruriens</i>	Kokoa Velvet bean	Very vigorous growth - excellent fallow species; drought-tolerant; pods edible	1,2,3,4
<i>Dolichos lablab</i>	Batao Lablab bean Habas	Drought-tolerant; pods edible	1,2,3
<i>Canavalia ensiformis</i>	Jack bean	Drought-tolerant	1,2,4
<i>Canavalia gladiata</i>	Sword bean	Drought-tolerant	1,2,4
<i>Cajanus cajan</i>	Kadios Pigeon pea	Excellent drought-tolerant; provides food	2,4
<i>Crotolaria sp.</i>	Sun hemp	Determinant growth habit	1,2,4
<i>Vigna umbelata</i>	Tahori rice bean	Food and green manure	
<i>Vigna unguiculata</i>	Paayap black bean	Food and green manure	1,3
<i>Psophocarpus tetragonolobus</i>	Sigarillas	Food and green manure	1,3,4
<i>Psophocarpus palustris</i>	Winged bean	Non-edible species	3,4
<i>Pueraria phaseoloides</i>	Tropical kudzu	Good under tree crops or as extended fallow	3,4
<i>Desmodium heterophylla</i>		Excellent under plantation crops	3,4
<i>Tephrosia candida</i>		Used under plantation crops	3,4
<i>Dioscorea alata</i>	Ubi	Excellent for food or income	3,4
<i>Ipomoea batatas</i>	Camote	Good food and extended cover	3
	Sayote		3
	Squash		2,3,4
	Yam bean		2,4

Source: IIRR and DENR. 1989. Agroforestry Technology Information Kit, IIRR, Silang, Cavite, Philippines

Site Selection and Timing of Seed Production

Seed comes from the flower. The flowering and seeding are affected by the health of the plant and its surroundings or environment. Seed quality is also affected by the parent plant.

I. Environmental Factors that Affect Seed Production

A. Photoperiodism

Photoperiodism refers to the flowering response of a plant to the length of day, or more precisely, the length of the light and dark periods.

1. **Short-day plants** flower and bear fruit during the months where the nights are long and the days are short. In the Philippines, short-day periods occur during the months of September to February.

Example: most soybean varieties, winged bean, hyacinth bean, lima bean, pigeon pea

2. **Long-day plants** flower and bear fruit during the months wherein the nights are short and the days are long. In the Philippines, long-day periods occur during the months of March to August.

Example: onion, sunflower

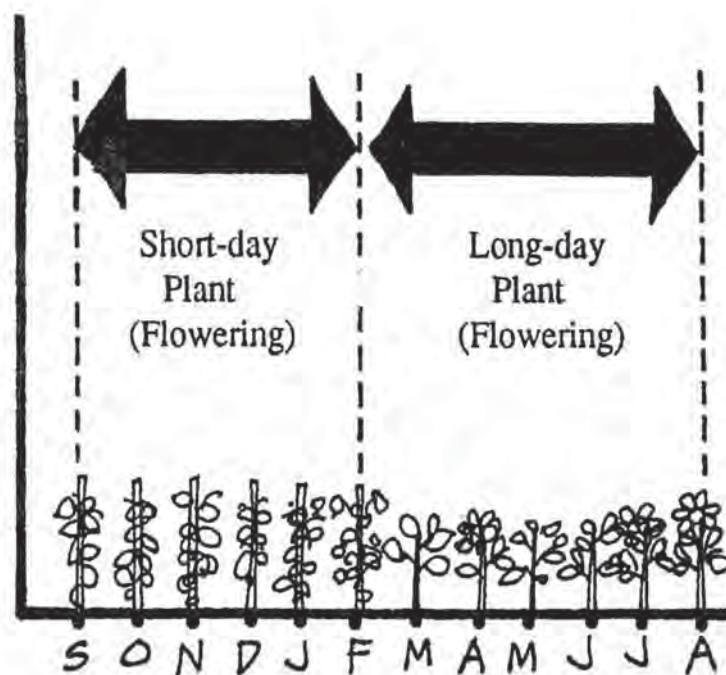

3. **Day-neutral plants** flower and bear fruit all year round.

Example: yardlong bean, ladyfinger, cowpea

Depending on the variety, some plants, like soybean, can either be short-day, long-day or day-neutral.

B. Temperature

Temperature has a direct effect on flowering and seed production.

1. **Tropical plants** – These are plants that flower and produce seeds in hot or tropical areas. Most of these plants flower and produce seeds in the Philippines.

Example: tomato, pepper, cowpea, ladyfinger

2. **Temperate plants** – These are plants that flower and produce seeds in cold or temperate areas. Most of these plants flower and produce seeds in cold areas in the Philippines, like Baguio and Tagaytay.

Example: pea, cabbage, pechay, radish, onion, carrot, cauliflower

EXAMPLE:

	No. of days inside the refrigerator
onion bulb	30 - 90
onion seed	15
garlic bulb	40 - 50
tuber of carrot	14 - 56
radish seed	5 - 7
pechay seed	4 - 8
cabbage seed	5 - 7
mustard seed	5 - 7

In areas where the temperature is not cold, temperate plants can be induced to flower and produce seeds if they are placed in cool conditions before planting. This method is called vernalization.

Vernalization is done by soaking the seeds in water and placing them (after the radicle or rudimentary root has protruded) or their plant parts (example: onion bulb, tuber of carrot) in a cold (but not freezing) place like a refrigerator.



C. Water/Rain

The right amount of water is needed for the growth of the plant. Hard and continuous rain is not good for seed production since:

1. pollen is not transferred;
2. seeds do not develop from flowers;
3. the vegetative stage of the plant or the maturity of the fruit/seed is prolonged;
4. seeds germinate even if it is still not harvested from the plant;
5. harvesting becomes more laborious;
6. pests attack or infest the plants; and,
7. seed yield decreases.

To prevent seed production during the rainy periods, plants can be spaced at wider or longer distances so that all the plants can have enough sunlight.

On the other hand, lack of rain or water is not good for the plant since it will prevent the normal growth of the plant and the plant may not produce flowers and seeds. Even if flowering occurs, the quality of the seeds is not good and the the seed yield is low.

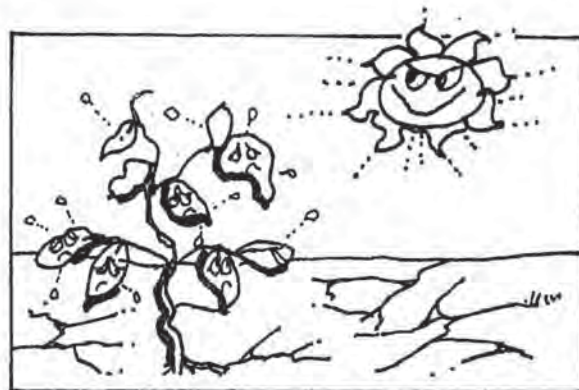

D. Wind

The strength and direction of the wind affect the pollination of flowers.

E. Soil

To produce good seeds, the soil must be healthy and fertile. The right pH (acidity of the soil) for a specific plant should also be obtained.



II. Cultural Practices

A. Timing of Planting

Plant seeds when the weather is good. Usually, seeds are planted during the rainy season in order to have continuous amount of water. It is good to transplant early in the morning or late in the afternoon.

B. Planting Distance and Rate of Planting

The distance between plants used for seed production is wider compared to that of plants used for other purposes (example: vegetable production, fodder production). More seeds need to be planted if the broadcast or sowing method is done. The distance of planting is also wider if the soil is not fertile and in the rainy season. Widening the distance will enable plants to receive enough sunlight.

C. Hastening Seed Germination

1. **Seed Cleaning or Seed Washing** – Soak the seeds in a container of water and remove the seeds that float. Seeds which float have poor quality.
2. **Use of Inoculants** – Some microorganisms help in good growth of seeds. *Rhizobium* (a kind of bacteria) gets nitrogen from air and gives the nitrogen to the plant and soil. This is usually used for legumes. *Mychorrhiza* (a kind of fungus) helps the root absorb elements like phosphorus from parts of the soil that cannot be reached by the root. This has been found effective in corn and different vegetables. The two inoculants can be used to minimize the use of fertilizer.
3. **Seed Scarification** – This method is appropriate to seeds (example: winged bean, bitter gourd, sponge gourd) that are hard and difficult for water and air to penetrate. This is done by (1) nicking off the seed coat with a knife or nailcutter; (2) puncturing the seed coat with a needle; and, (3) rubbing the seeds in sandpaper, file or any rough material. Care should be done so as not to injure the internal portion of the seeds, especially the radicle.
4. **Hot Water Treatment** – Pour hot water (boiled and then cooled for about 10 - 15 minutes) into a container with seed (10 parts water to 1 part seed). Let stand for 3 - 10 minutes or until water cools off. Seeds may be left soaking overnight. Old seeds are soaked for a shorter time than new seeds.
5. **Soaking Seeds in Ordinary Water Overnight** – Soak seeds in tap water for 12- 48 hours (depending on the species). This method is not recommended for all seeds, especially seeds that quickly absorb water like most legumes.

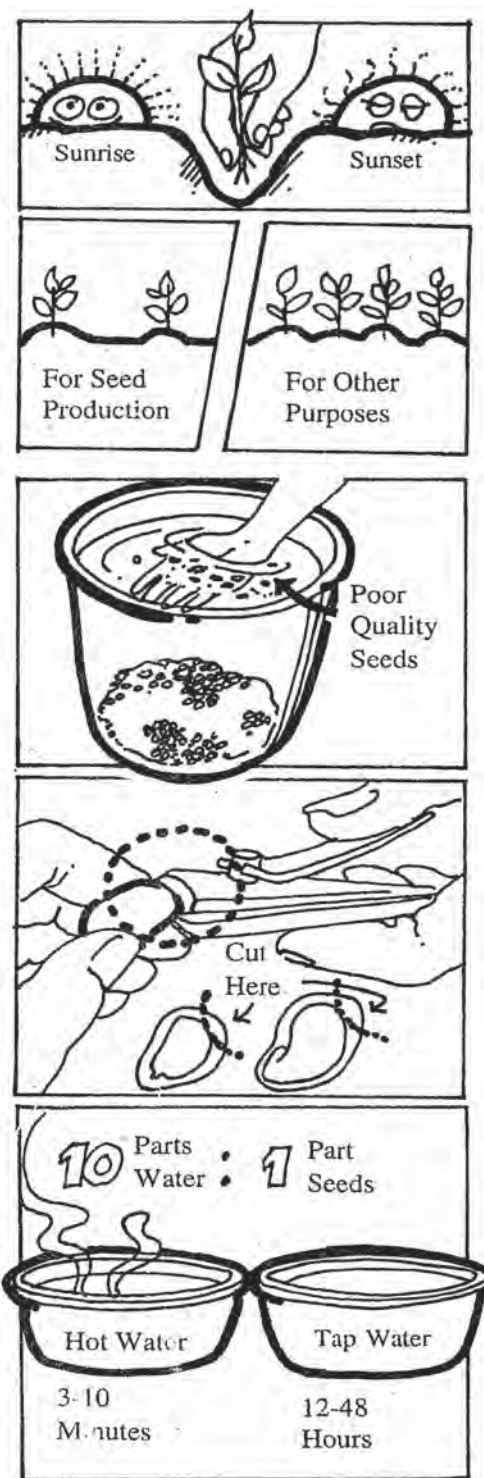

D. Maintaining Seed Purity

The following methods are important to prevent contaminating other plant varieties from the variety that is being grown.

1. **Planting distance** – The plant being grown should be kept at a distance from other varieties and also from plants that are of the same family. Varieties of cross-pollinated plants should be planted at greater distances from each other than self-pollinated plants. For self-pollinated plants, the planting distance should not be less than 10 meters. For cross-pollinated plants, the planting distance should not be less than 100 meters.
2. **Planting timing** – Avoid planting at the same time plants from the same family or of different varieties of the same species. This ensures that they will not flower at the same time.
3. **Use of Windbreaks** – Choose an area where there are tall plants in between plants of the same family or species.
4. **Border Rows** – Rows of plants of the same variety as the plants being used for seed production, planted on the edges of the plot. Seeds from the plants in the border rows are not used for planting.
5. **Roguing** – Roguing is done by pulling out plants that are: (1) off-types (plants with different color, shape, etc.); (2) diseased or insect-damaged; and, (3) of different varieties. Failure to remove off-types results in poor quality seeds since off-types might cross-pollinate with good plants.
6. **Bagging and Caging** – This prevents pollination of plants that are of different species and variety.

E. Nutrition

Proper care and the right nutrition should be given to the plant to have good and high seed-yield. Organic fertilizers are recommended.

F. Irrigation/Watering

The amount and frequency of watering should be adjusted for good seed-yield. Plants need less water after flowering than during the vegetative stage.

G. Pest and Disease Management

Pests and diseases affect the quality and quantity of seed yield. To prevent infestation of pests and diseases, cultural practices like intercropping, mixed or multiple cropping and crop rotation are recommended.

Botanical pesticides can also be used to prevent infestation of pests and diseases. If some plants already have disease, pull them out and burn or bury them underground to prevent contaminating other plants.

Use of good quality seeds (seeds with good germination percentage and without seedborne pests and diseases) can also prevent pest and disease infestation. Another way of controlling pest and disease infestation is to use traditional seeds.

Source: *Regenerative Agriculture Technologies (RAT) Kit. IIRR UNICEF for Philippine Department of Agriculture. 1989.*

Water Harvesting: Improved

Conservation of rainwater so it stays in the soil profile for a longer period and is released slowly through the drainage line in that area becomes an important constituent of improved dryland farming. The average size of a land holding in India is only 2ha ranging from 0.5ha in Kerala to 4.7ha in Rajasthan. In Tamil Nadu, it is about 1 ha and the holdings are fragmented. While 87.7% of the farmers are small and marginal, they hold only about 48.7% of the area under cultivation. These farmers are poor and come under the category of “weaker sections”. This situation leads to complications in tackling dryland agriculture in the country (*An economic appraisal, Tamil Nadu, 1989*).

In the last two or three decades, considerable attention focused on improving rainfed agriculture. This has led to individual farmers to adopt moisture conservation measures, encouraging contour bunds and constructing check dams. The expenditure incurred was recovered from the farmers after deducting 25% to 33% as subsidy. Because the work was not done on a watershed basis, whatever improvements made were often nullified because runoff was not controlled in the upper areas. In the past, it was not realized that all development in drylands had to be tackled on a watershed basis. This has changed since and now the efforts are taken up on a watershed basis.

The following are some of the water harvesting practices to be undertaken in the watershed to conserve soil moisture and rainwater and utilize the excess water for increasing agricultural production. The treatment may be different in red and black soils and light and heavy rainfall areas. Based on soil type and rainfall, the watershed plan can be prepared and implemented with involvement of the farmers in the watershed.

- **In-situ moisture conservation practices**
- **Soil conservation techniques** — viz, contour bunding in low and medium rainfall areas; graded bunding in high rainfall

areas in red soils; and broad-based structures or ridges with grass or vegetative barriers in black soils.

- Construction of check dams and gully control structures
- Establishing farm ponds in individual farmer’s fields
- Construction of percolation ponds
- Construction of irrigation tanks
- Conjunctive use of groundwater to supplement rainfall

Improved water harvesting practices

Many of these practices have evolved from indigenous practices. The indigenous practices are, by and large, simple, and easily constructed with locally available tools and materials. Improvements to such practices became necessary, to make them more effective and durable, and so their maintenance would be relatively easy.

Appropriate *In-situ* Moisture Conservation Methods in Various Rainfed Areas and Soil Types

Type of soil	Rainfall	Water harvesting <i>in-situ</i> moisture conservation practices.
Red soils	Low	Dead furrows at 3-6m intervals
	Medium	Sowing in rows and ridging later
	High	Graded border strips
Black soils	Low	Contour cultivation
	Medium	Dead furrow at 3-6m intervals
	High	Graded open furrows at 10m intervals across the slope

***In-situ* moisture conservation practices**

- Contour cultivation
- Formation of basins, furrows, random tie ridges, broad based ridges and furrows
- Cross ploughing in both red and black soils when rainfall is less than 750mm
- Formation of drainage channel in black soil areas

in-situ moisture conservation is best adopted after the watershed is completely treated with soil conservation measures.

Moisture Conservation Measures

Contour Trenches

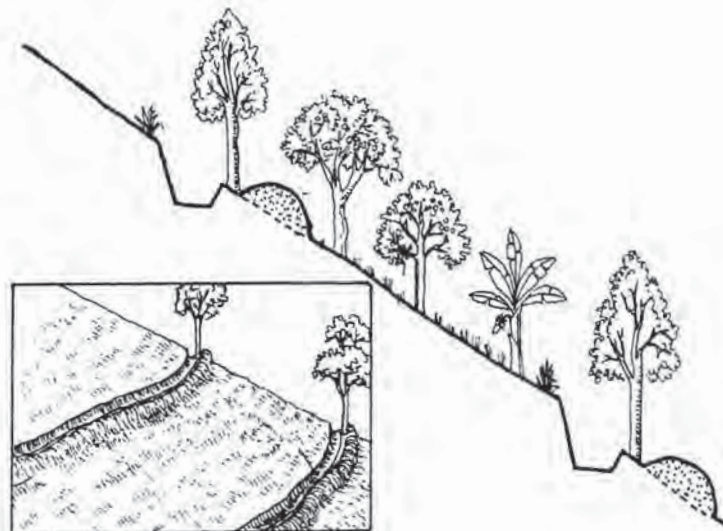

Conditions where contour trenches may be used:

- slopes of more than 33.3%; and
- any badly-eroded slope.

Uses

- for planting tea, coffee and other plantation crops; and
- to intercept runoff water from field sections between trenches for safe disposal.

Conjunctive Use of Groundwater to Supplement Rainfall

By implementing the water harvesting programme as described above, there is a good possibility of increasing the groundwater potential in the watershed. To prevent groundwater flow outside the area in the watershed, small sub-surface dams can be constructed in water-scarce areas.

In red soils, both biological and mechanical measures may often be required, in black soils, soil moisture can be augmented to a considerable extent by biological measures. No perfect erosion control structure has been evolved to conserve soil and water in black soil areas.

Examples of check dams

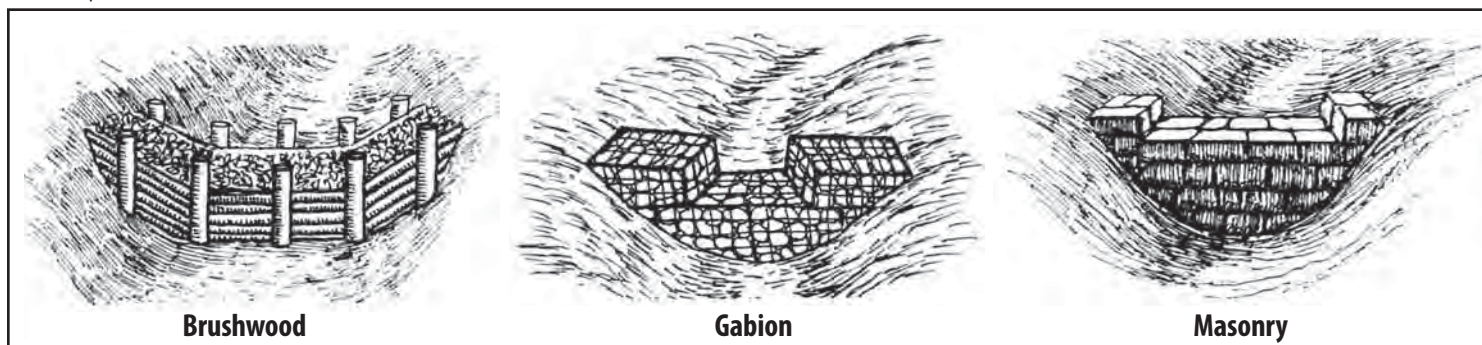

Contour Stone Walls

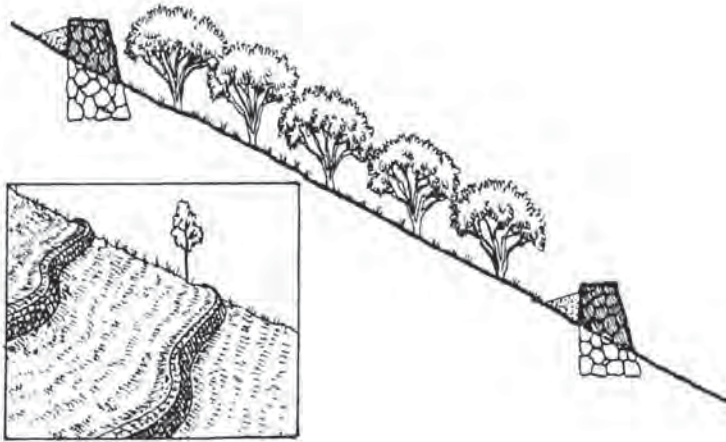

Condition where contour stone walls may be used:

- on any slope where stones and rocks are plentifully available.

Uses

- as an initial treatment for bench terraces; and
- to slow run-off and control erosion in plantation areas.

Bench Terraces

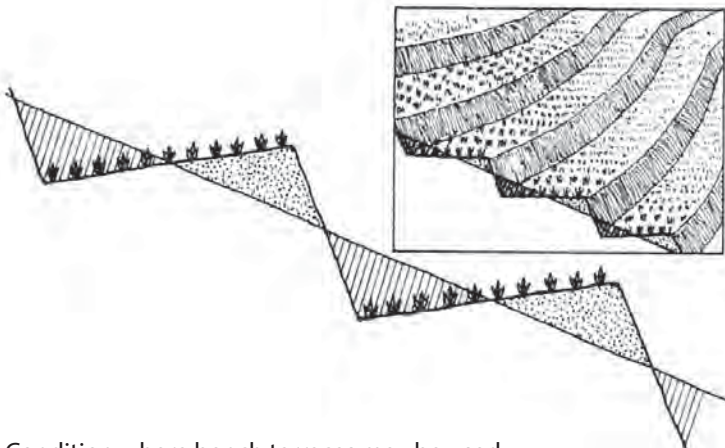

Condition where bench terraces may be used:

- slopes between 16.7 and 33.3% and in areas having soil depth of more than 75cm

Use

- agricultural lands put to annual crops which permit soil erosion.

Graded Trenches

Condition where graded trenches may be used:

- soil slopes ranging from 10 to 30% where soil depth is less than 75cm and in areas with rainfall above 1000mm.

Uses

- agricultural lands planted to annual crops that permit soil erosion; and
- as a waterway outlet to convey run-off to a point where it will be discharged without erosion damage.
- conditions where contour bunds may be used

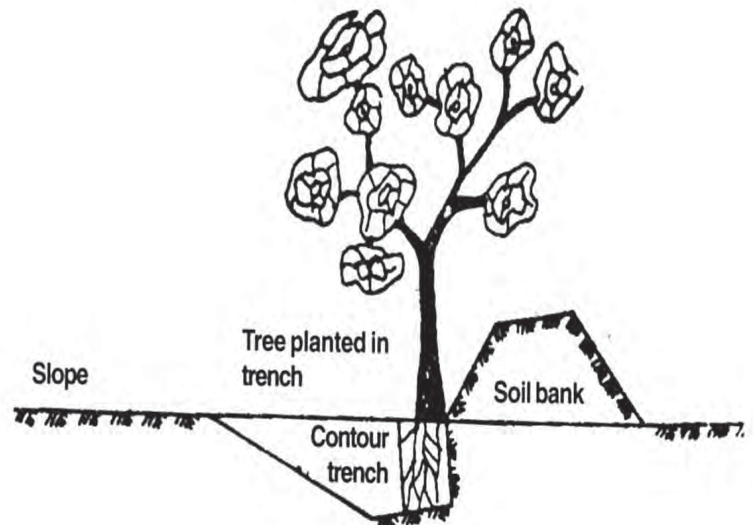

Adapted from Gurmel Singh, et al, 1990

Contour Bunds (Level Terraces)

Conditions where contour bunds may be used:

- soil slopes of between 1 and 10%; and
- areas of low rainfall (1000mm or below).

Uses

- generally used in areas of suitable soils where outlets are a problem and run-off from the area must be kept to a minimum or entirely eliminated; and

- contour bunds with burrow pit could be used to retain water between the terraces. On steeper slopes burrow pits can also be used to decrease average slope of farmed areas, thus making land more farmable.

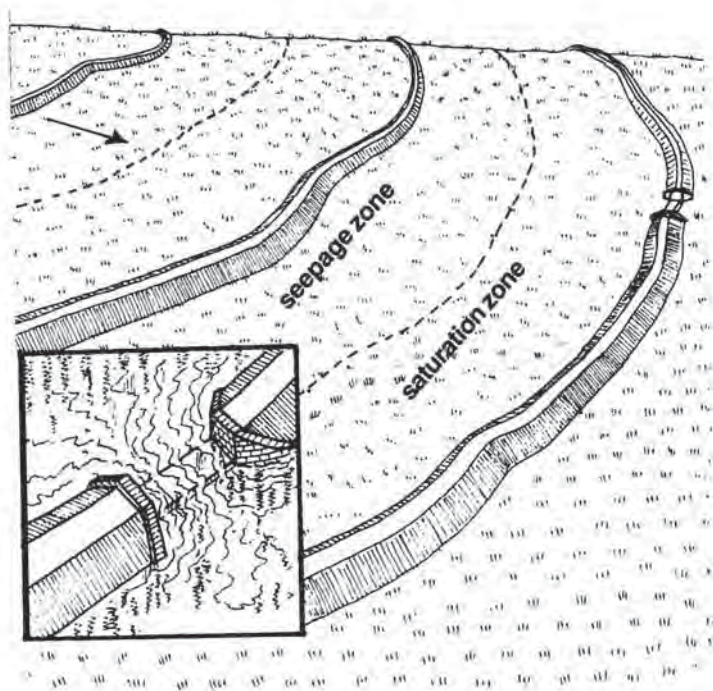
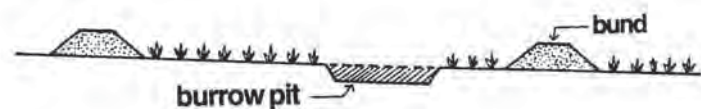

Graded Bunds (Graded Terraces)

Conditions where graded bunds may be used:

- suitable for soil slopes of between 1 and 10%;
- particularly adapted to area of high rainfall (more than 1000mm).

Use

- to store water temporarily and discharge through terrace outlets.

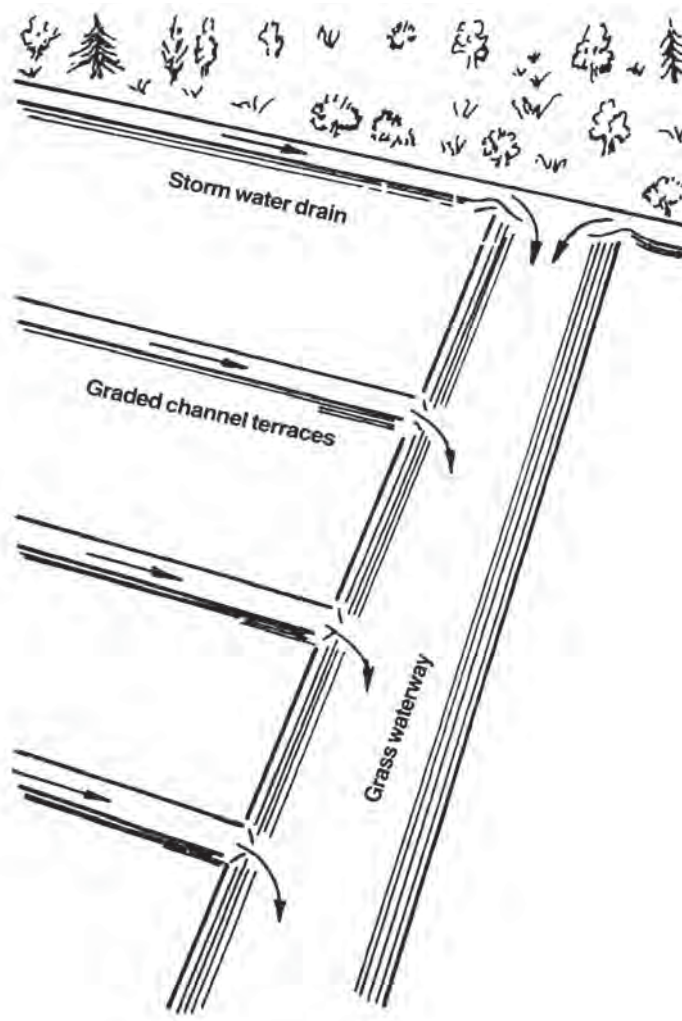

Source: MYRADA and IIRR. 1997. *Resource Management in the Rainfed Drylands*. MYRADA, Bangalore, India and International Institute of Rural Reconstruction, Silang, Cavite, Philippines. pp 75-78, Contributor: C. R. Shanugham

Small Water-impounding Technologies

Small water-impounding refers to structures using readily available materials for the storage and/or diversion of surface water (running water from springs, creeks, streams or rivers) either for the purpose of irrigation or for domestic use. These structures are generally characterized as simple, easy-to-build and maintain, inexpensive and using readily available materials. However, they are less efficient and need to be maintained frequently compared to more permanent structures.

Structures for Diverting Surface Water for Irrigation Purposes

1. Tambak I

Is a series of interconnected tripod structures, usually made up of wooden poles or piles and/or bamboos arranged in a slightly diagonal position across a stream or river with moderately running surface water. It usually covers 3/4 of the width of a stream or river with the main function of raising the water level and directing

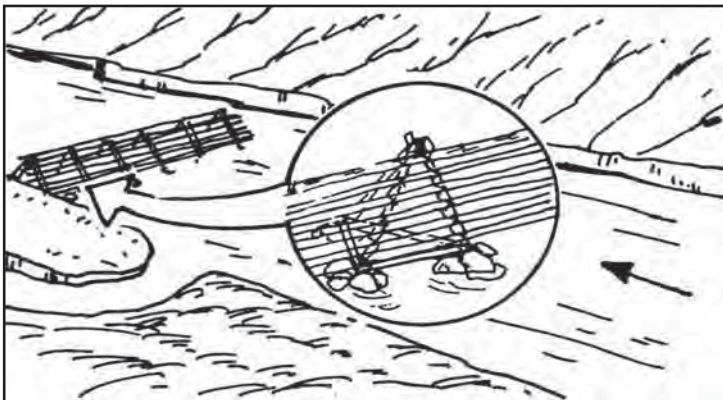

it into a drainage canal located immediately upstream of the structure.

Procedures

(a) Site Selection.

Select a portion of a stream or river that is higher in elevation than the area to be irrigated. The site should have a moderately running surface water, with normal water level of from knee up to waist deep and with more or less even stream or river bed and the area is free of flash flood. It is also necessary that the selected site can be connected by a diversion canal to the proposed area to be irrigated.

(b) Preparation of Materials.

Materials needed for the structure are: for each tripod structure, three pcs of 1.5-2 meter wooden poles or piles or bamboo, three pcs of 1 meter bamboo poles; for connecting the tripod structures, bamboo poles sufficient to cover 3/4 of the width of the stream or river; sufficient quantity of split bamboos with one inch width; and tying materials.

(c) Construction of Tambak I.

Mark the location of the tripod at approximately two-meter interval, slightly diagonal across the stream or river and covering 3/4 of its width. On these sites, construct the tripod structure with two legs in the upstream and the other in the downstream at approximately one meter distance. Bury the legs at 0.25 meter in the river bed, strengthen the legs of the tripod by forming a small triangle using bamboo poles at the base of the tripod at 0.25 meter from the bed. Add rocks and boulders at the legs and at the small triangle to weigh down

and strengthen the tripod structure. Interconnect the top of the tripods with bamboo poles and with the use of bamboo splits line the upstream portion of the tripod with one inch interspaces from the base up to the top of the tripod.

(d) Construction of the Diversion Canal.

Immediately upstream of the tripod structure, construct a diversion canal with at least 0.25 meter width and depth and connect it to the area to be irrigated.

(e) Operation and Maintenance.

Cover the interspaces between the bamboo splits with leaves, sacks and other materials starting from the bottom up to the top, to raise the water level to reach the level of the diversion canal. When not in use, remove the leaves and other materials to allow free flow of water between the interspaces. All large debris, such as logs and drift wood, should be guided to pass through the opening of the structure to minimize damage to it. Regularly check and repair the structure and the diversion canal.

2. Tambak II

Is a heap structure, composed of rocks boulders and river sands covering the entire width of the stream or river with a height of up to 0.5 meter. Its function is to store water, slightly raise the water level and divert it to a diversion canal located at its side.

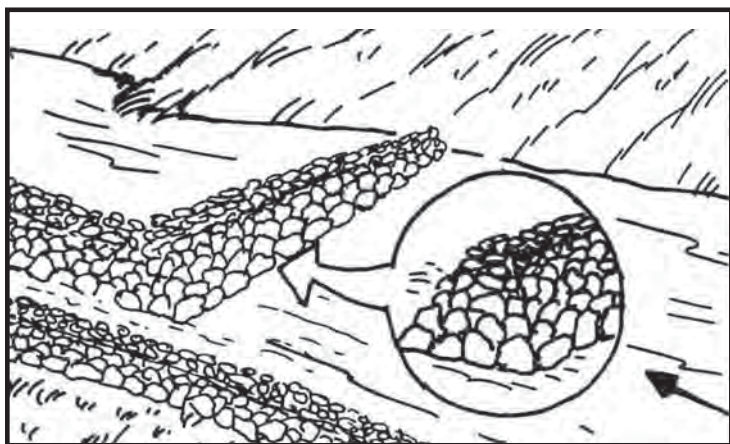

Procedures

(a) Site Selection.

Select a portion of a stream or river that is higher in elevation than the area to be irrigated. The site should have slow to moderately running surface water with normal water level up to knee deep and preferably with even river or stream bed. It should also be free from flash flood. It is necessary that the selected site can be connected by a diversion canal to the proposed area to be irrigated.

(b) Preparation of Materials. Materials needed for the construction are those available in the site, such as boulders, rocks and river sands. The amount of materials depends on the width of the stream or river and the height of the heap to be constructed.

(c) Construction of Tambak II.

With the use of bare hands, shovel and crowbar, construct the heap in a linear fashion at least half a meter wide and up to half a meter high. Rocks and boulders should be placed at the core with river sands used to cover and fill up interspaces between them as well as the outside cover of the heap. Diversion canal should also be constructed at the side of the heap.

(d) Operation and Maintenance. Unlike Tambak I, the structure will automatically raise the water level, store and divert it to the diversion canal. Leakages can be minimized by additional boulders, rocks and sands. Constantly check and repair the structures for leakages. When not to be used, allow a portion of the heap to open or close the diversion canal and allow the water to overflow the heap structure.

Structures for Storing Surface Water, for Watering and Other Similar Uses

Earth or Mixed-Material Dam - a structure composed of readily available materials (such as rocks, boulders, and earth) and is used to store water for watering and other similar purposes. The structure is usually applied in live or intermittent creeks or streams with up to three meters width and not prone to flash flooding.

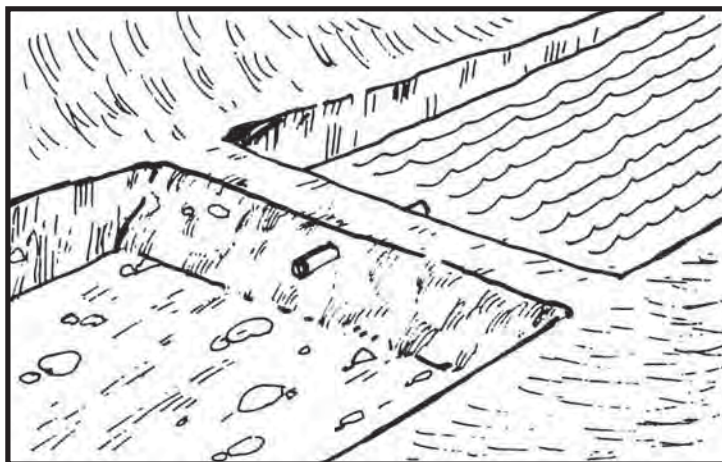

1. Earth Dam - a structure composed mainly of compacted soil with a base of at least one meter thickness arranged in a pyramidal fashion. It usually has an opening near the base (through a bamboo tube) and at the top (small opening lower in height than the dam) to control the water flow. To make reservoir area more impermeable to minimize seepage of water, the following should be conducted: a) scrape the bed of rocks until reaching the clay surface; b) line the bed with at least 20cm thick of fresh leaves, grasses and fine organic matters; c) cover the organic materials with soil of at least 20 cm thick and compact it eliminating air spaces; and, d) allow the organic matter to rot, thus forming a sticky and impermeable layer.

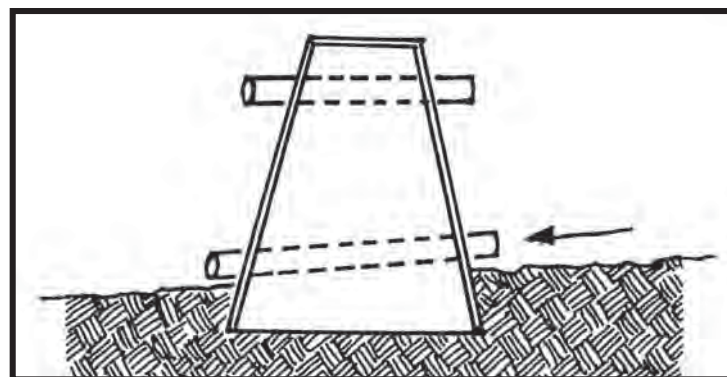

2. Earth and Stone Dam - a structure composed of compacted earth (soil) and a core of boulders and rocks. The dimension is more or less similar with the earth dam.

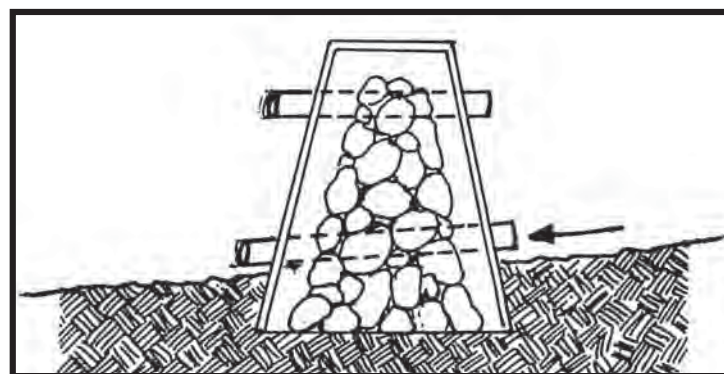

- 3. Earth, Rock and Log Dam** - a structure composed of compacted soil rocks and log (wooden) materials. The core is mainly composed of boulders and rocks with interspaces filled up with clay materials. Compacted earth materials cover the core and the logs are arranged either in horizontal or vertical fashion with clay materials as the outer covering.
- 4. Bamboo and Earth Dam** - a structure mainly composed of bamboo poles and crushed bamboo and earth materials. Two lines of bamboo poles and crushed bamboo culms are constructed at 0.25m distance between lines. The distance between bamboo poles in a line is approximately one

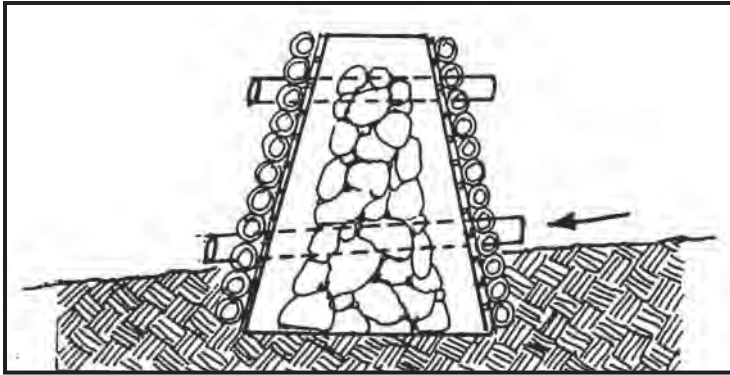

meter. The interspaces between the lines are filled up with rocks mixed with clay. The outer covering is composed of compacted earth.

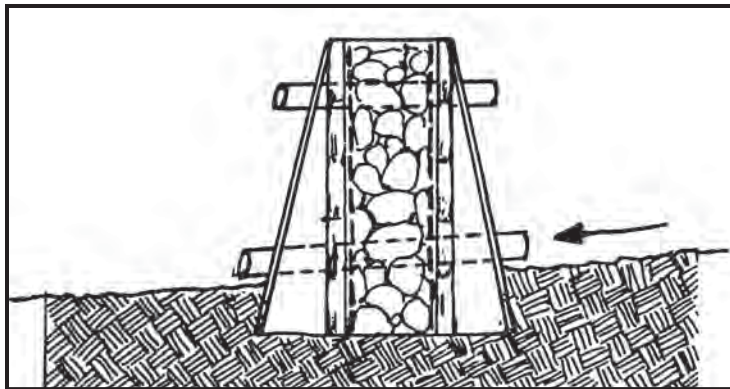

For further storage efficiency of the above mentioned dams, the surface of the structure should be lined with two inches of clay materials. Planting of grasses, such as bermuda grass, can also be done to strengthen the outer surface of the dam.

Structure for Storing Surface Water, for Drinking and Domestic-consumption Purposes

Box Spring – a structure that encloses a live spring for storing water and or storing and diverting water through a pipe for drinking and other domestic consumption purposes. The structure can be made up of rocks and mud lined with clean river sand or hollow blocks and cement, covered by wooden planks.

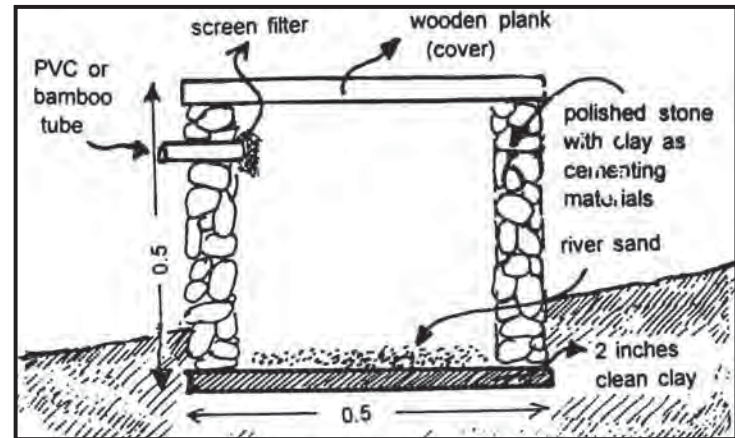

Procedures

1. Site Selection.

Locate a live spring which is accessible and preferably 50 meters from the residence. A live spring located higher in elevation than the site of the residence can be tapped through a series of pipes (PVC or bamboo poles) while those located at the same level or lower than the house can be tapped by using water pails or other containers.

2. Preparation of Materials.

Prepare sufficient amount of clean river sands, clean clay, polished stones/ rocks and wooden planks or sufficient amount of hollow blocks, cement and sands. Piping materials

should also be prepared whenever necessary either of bamboo poles or PVC.

3. Construction of Box Spring.

Clean the area around the spring at least with a dimension of 0.5m x 0.5m. Provide a temporary outlet for the water to pass through while the box spring is still under construction. Line the area with clean clay with at least two inches thickness and enclosed it with stones/rocks mixed with clay forming a box structure with a dimension of at least 0.5m x 0.5m x 0.5m. Line the base of the box with clean river sand and cover the top of the structure with wooden planks. Allow an opening near the top for piping or to allow the flow of excess water.

4. Operation and Maintenance.

The box spring is allowed to store water a day or two after construction by plugging the temporary water outlet. Check and repair leakages. Conduct regular maintenance of the box spring by cleaning it of insects, leaves and other materials that get into the box spring.

Note: For health safety, water from this structure should be passed through a clean cloth screener and boiled before drinking. A water purifier tablet is also recommended.

Small Ponds for Water Conservation

Water is a scarce resource in hill farming systems. Therefore, farmers generally build community ponds to collect runoff water for livestock to drink and for bathing. Some farmers use these ponds for small-scale irrigation as well. These ponds generally make water available up to six months after the rainy season. Few ponds can make water available throughout the year.

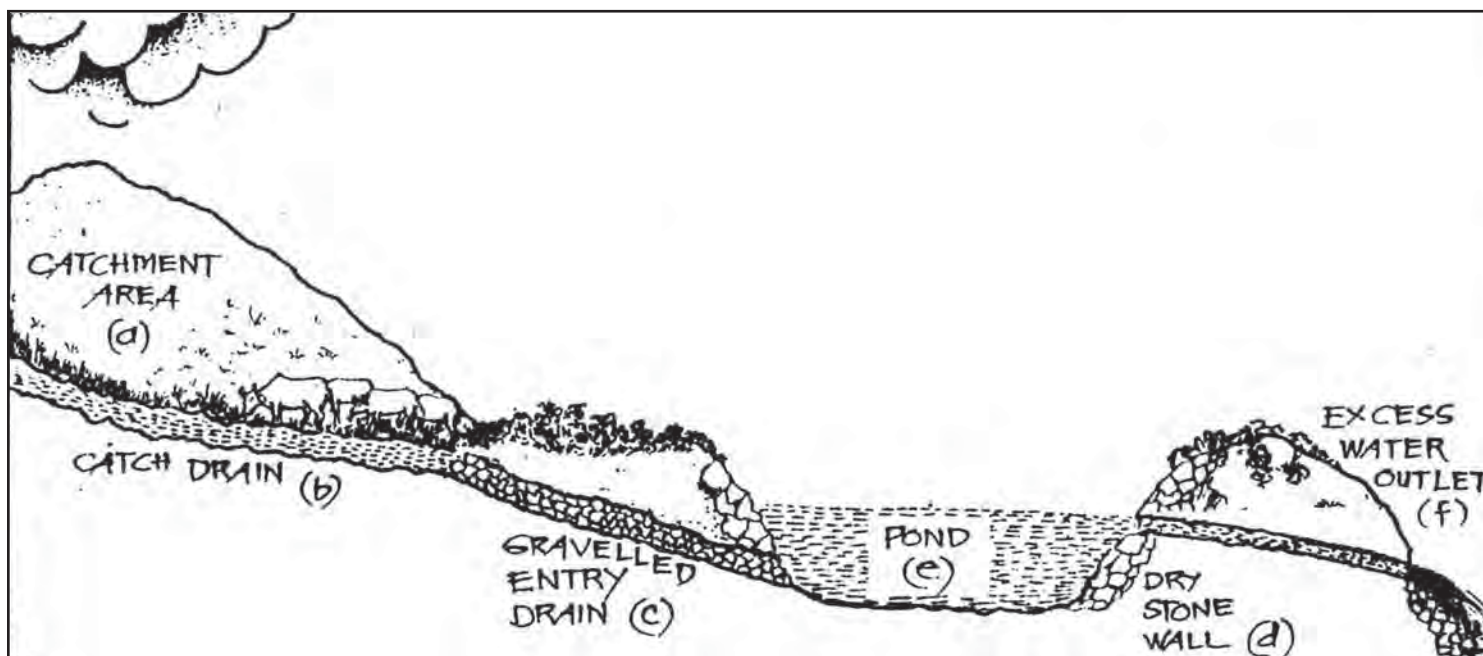

Pond Construction

1. **Catchment area.** Area from which rain water flows down to the pond. This area generally consists of the gently sloping grazing ground at slightly higher elevations. Some ponds also collect water from run-off diversion (trails) flowing from the farm household.
2. **Catch drain.** The drain guides the run-off water from the catchment area to the pond. Generally, a drain is dug at the downward contour of the elevated grazing ground or the main drain (trail) flowing from the farm households.
3. **Gravelled entry drain.** This is the entry portion of the catchment drain and is lined with gravel to prevent scouring from run-off water. Also, cattle can enter the pond to drink or bathe. This drain is about 2m long with a gentle slope towards the bottom of the pond.
4. **Dry stone wall.** A dry stone pond wall (riser) is constructed to protect the pond riser from collapsing into the pond. This wall should not be vertical, but should slope slightly towards the pond.

5. **Pond.** The pond should be about 1.5m deep. Water is stored up to a depth of 1m. The main problem of constructing such a pond is the high loss of water due to porous pond bottom. This can be avoided either by packing a 6" layer of fine clay or clayey soil onto the bottom. Take care not to disturb the original sealing while digging.

As some ponds get older, their water storing capacity can improve. The fine soil particles from the run-off water enter the pond and settle on the bottom making it more impervious to water. Ponds can also be built with cement,

plaster and impervious bottom soling but are very costly. The size of the pond depends upon the size of the site and the catchment area. It is advisable to plant shrubs around the pond to conserve the soil.

6. **Excess water outlet.** This outlet is placed one-half meter above the ground level to maintain the water level and prevent overflow. The excess water is drained to a safe drainage area. The drain is made of either gravelled channel or a pipe.

Use of Scarce Water Resources in Drylands through Pitcher Irrigation

Good quality ground water is very scarce in arid areas. Even where canal water has been introduced, proper methods of irrigation have not been used resulting in problems of soil salinity and waterlogging. So, in arid and semi-arid regions, every drop of water should be utilized in the best possible way. In the recent past, new methods like sprinkler and drip irrigation have been used successfully. But these methods involve heavy investments on installation and maintenance. Work done at research centers and universities in arid areas have shown that pitcher irrigation is effective in growing spreading type crops and saplings. It serves as the “poor man’s drip irrigation system.”

Installation of the pitcher

1. Dig a small pit with a spade or a hand-hoe; the depth of the pit should be the same as the height of the pitcher.
2. Place the pitcher in the pit.
3. Put powdered soil around the pitcher and press the soil so that it is in close contact with the outer wall of the pitcher.
4. Keep the neck of the pitcher above the soil surface.
5. Pour water into the pitcher and cover its mouth with a lid.
6. Sow seeds close to the outer wall of the pitcher when the area around it gets moistened in a day or two.
7. Refill the pitcher when three quarters of the water is used up.
8. Place a lid on the pitcher and close it firmly to reduce evaporation and prevent breeding of mosquitoes. This can be done by any indigenous method suitable to the local region.

Environment-friendly Method

- It does not require any electric or other form of energy. Once the pitcher is filled, it carries on irrigation work 24 hours a day.
- It minimizes usage of fertilizers.

Pitcher

The pitcher is a round, baked earthen container which is open at the top. This indigenous container is used by village women to fetch and store water. Water stored in pitchers maintains a cool temperature in summer as water evaporates from the outer surface of the pitcher. The same mechanism is applied for pitcher irrigation. Pitchers can be of different sizes ranging from 10 to 20 liters capacity. One pitcher is sufficient to irrigate spreading type vegetables like gourd, pumpkin, melon, etc. These crops need very few pitchers per unit area.

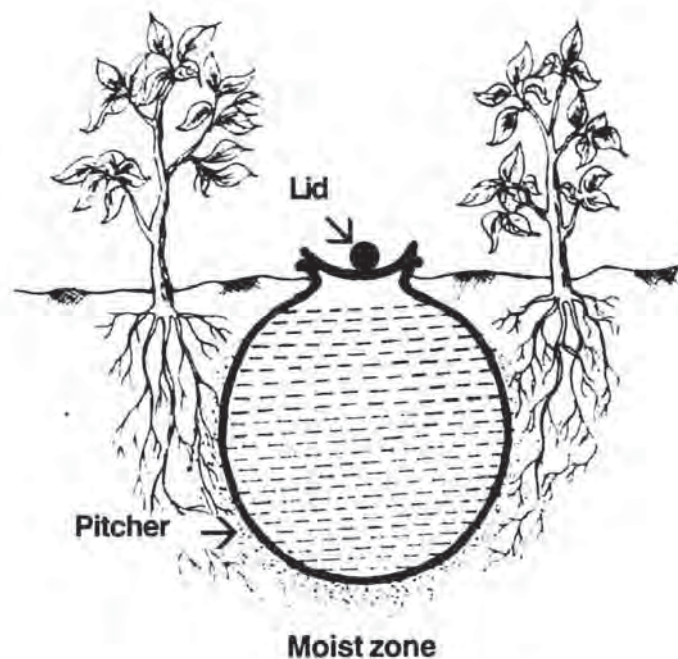

Benefits of Pitcher Irrigation Over Other Methods

- It saves water because there is minimal loss from seepage and evaporation.
- It reduces maintenance costs.
- It cuts down on weeding.
- It checks waterlogging.
- It minimizes salt deposit accumulation in the soil.
- It enables application of soluble fertilizers in small quantities.
- It ensures optimum utilization of water and fertilizers.
- It facilitates early growth of trees. In the case of the **Khejri** (*Prosopis cineraria*) from Rajasthan, the initial growth was faster, which otherwise is much slower.



Social Benefits

- Encourages a cottage industry by providing work to the potters who prepare these pitchers.
- Promotes the use of locally available materials.
- Provides more employment opportunities to landless laborers as the pitchers have to be repeatedly refilled.
- Allows easy handling by all family members.
- Poses no environmental hazard.

Note

- The soil around the pitcher should be powdered finely to ensure total moistening of the soil
- Seedlings and tree saplings should be planted in the moistened area only
- If salinity in the water is high, the site of the pitchers can be changed every three years to increase efficiency of the method.

Economics of Pitcher Irrigation

- Each pitcher costs Rs 10-15 for a 10-15 liter capacity pitcher. The cost of installation of 1000 pitchers is around Rs 17,000 - which is less than the installation cost of drip or sprinkler irrigation.
 - There are practically no maintenance costs.
 - In dry areas, pitchers last for more than 3 years. In the case of trees, pitchers can be removed after one or two years. Even in sandy dunes, the soil layers at a depth of one meter are moist. Once the roots move to deeper layers, the pitchers can be removed and re-utilized elsewhere. The cost of growing crops and trees will be reduced considerably.

Pitcher Irrigation as Practiced in Karnataka

Pitcher irrigation is a popular practice in the semi-arid and undulating areas of Karnataka. The method varies slightly from the one detailed earlier.

The steps are as follows:

1. Use a pitcher with an approximate capacity of 12 liters.
2. Make a small hole at the base of the pitcher.
3. Place a cotton wick in the hole.
4. Bury the pitcher in the soil close to the root of the plant ensuring that its neck is above the ground as shown in the illustration.
5. Pour water in the pitcher and keep it covered with a lid to prevent evaporation.

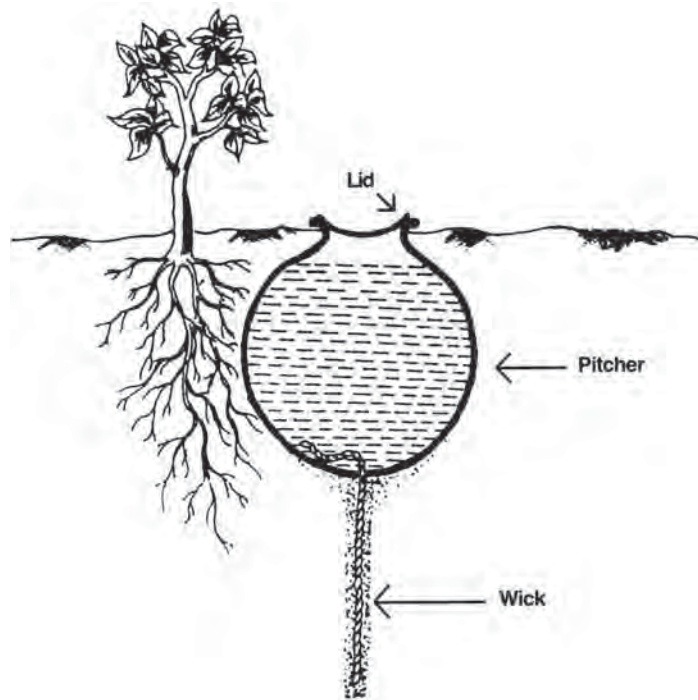

Note

- Ensure that the wick is firmly fixed to prevent the plant roots from entering the pitcher.
- Position the pitcher in a way that no run off rainwater can enter because silt can block the pores of the pitcher.
- Instruct potter to pierce a hole in the pitcher before baking.
- Avoid placing pitcher on the downhill side of the plant as the force of gravity will take the water away from the root zone.

Courtesy: Mr. S.N. Donl and Mr. Ramachandrappa based on MYRADA's Kamasamudram Project. Contributor: K.K. Mehta

The Role of Organic Mulches

Mulches have many beneficial effects upon the soil, plants and area surrounding the plants.

1. They conserve soil moisture by reducing evaporation of water from the soil.
2. They prevent crusting of the soil surface, thus improving absorption and percolation of water to the soil areas where the roots are growing.
3. They maintain a more uniform soil temperature by acting as

an insulator that keeps the soil warm during cool spells and cooler during the warm months of the year.

4. They prevent fruits and plants from becoming mud splashed and reduce losses from soil-borne diseases.
5. They reduce weed problems when the mulch material itself is weed-free and is applied deep enough (at least 2.5cm thick) to prevent weed seed germination or smother existing smaller weeds. Time and labor of weeding is reduced considerably when mulches are used properly.

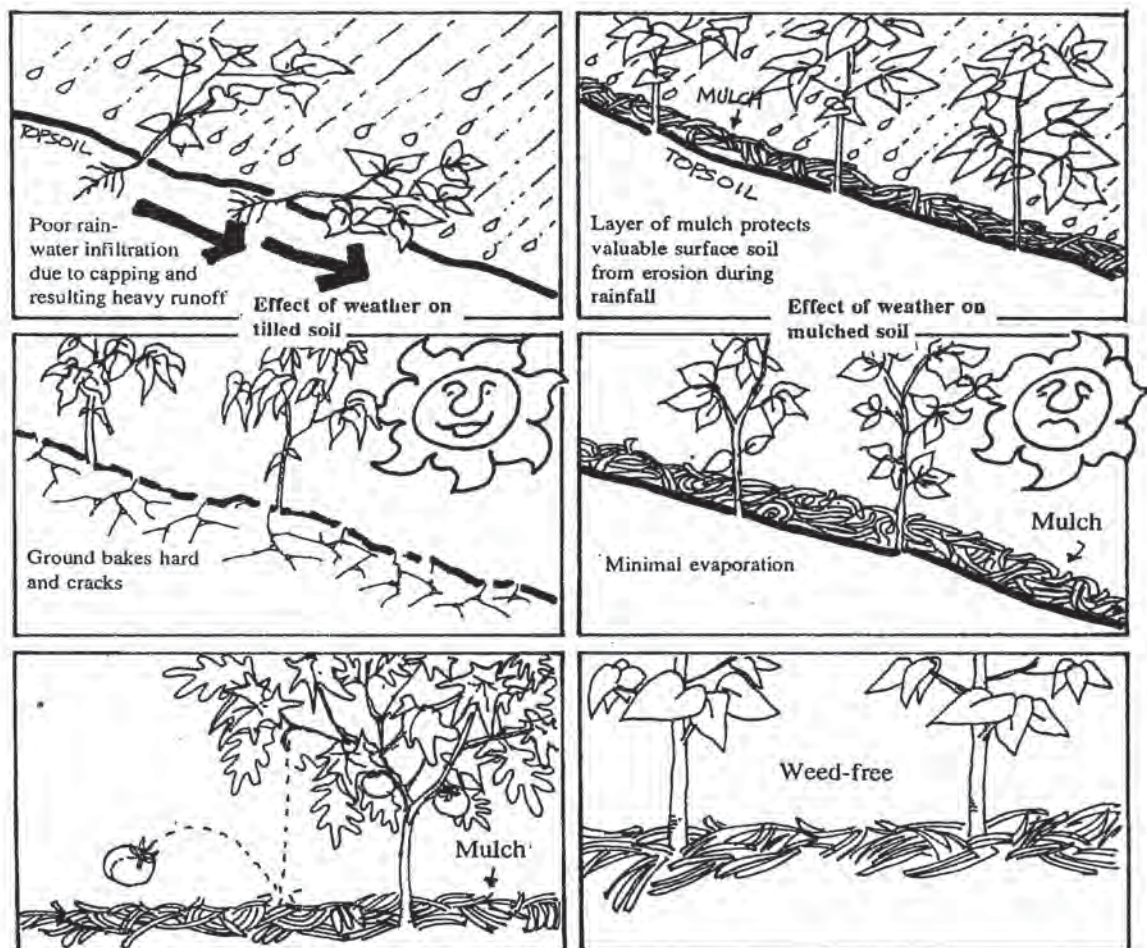

Some Tropical Materials for Use as Mulch

	Nitrogen	Phosporus	Potash
Corn cobs	x	x	xxx
Corn silage	x	x	x
Corn stalks	x	x	x
Rice straw	xx	x	x
Rice bran	xx	x	x
Wheat straw	xx	x	x
Wheat bran	xx	x	x
Peanut shells	x	x	x
Egg shells	x	x	x
Feathers	xxx	x	x
Sugar by-products	x	xxx	x
Coffee grounds	x	x	x
Tea grounds	xx	x	x
Seaweed	xx	x	x
Fish bones	xx	xx	xx
Banana stalk	x	xx	xxx
Banana skins	x	xx	xxx
Banana leaves	x	xx	xxx
Tobacco leaves	xx	x	xx
Tobacco stalk	xx	x	xx

xxx — Good source xx — Fair source x — Poor source

References: Brooks, W. M., J.D. Utzinger and H. R. Tayama. (Undated). Mulches for the Home Grounds. Ohio State University.

Source: International Institute of Rural Reconstruction (IIRR). Silang, Cavite, Philippines.

Traditional or Indigenous Seeds

Traditional or indigenous seeds are those produced, growing or living naturally in a particular country or climate. They are seeds that have been selected and managed by local people in the local growing environment.



Characteristics of Traditional Seeds

1. Adapted to the conditions of the area where they are grown.
2. Multiple uses (examples: food, medicine, fuel, fiber, fertilizer, craft materials, feed for animals, religious artifacts).
3. Most are resistant to pests, diseases and environmental conditions, such as drought.

4. High nutritional value.
5. They do not have a peak season harvest. The fruits do not mature at the same time, so harvesting is staggered. Hence, they can provide a daily source of food for the family.
6. They provide plant breeders with valuable traits needed for crop improvement.

Choosing Good Plants for Seeds (Plant Selection)

The selection criteria for seeds depend on the selector's needs or use (example: food, fodder). Below is a list of characteristics which can help the selector find good plants for seeds:

1. Vigor and health of the plant
2. Resistance to pests and diseases
3. Resistance to adverse environmental conditions, like drought, heat, flood
4. Time of fruit bearing
5. Yield
6. Characteristics of fruit and seed like color, size, shape, texture, etc.
7. Cooking and eating quality (if the fruit or seed is meant for eating)
8. Storage life of fruit and seed
9. Other characteristics depending on the use (example: medicine, crafts, religious artifacts).

Based on the above criteria, select the plant to be used for seeds. Put a tag or mark the plant so that it is not harvested by accident and so that special care can be given to it.

Source: *Regenerative Agriculture Technologies (RAT) Kit. IIRR UNICEF for Philippine Department of Agriculture. 1989.*

Tree Pruning and Care

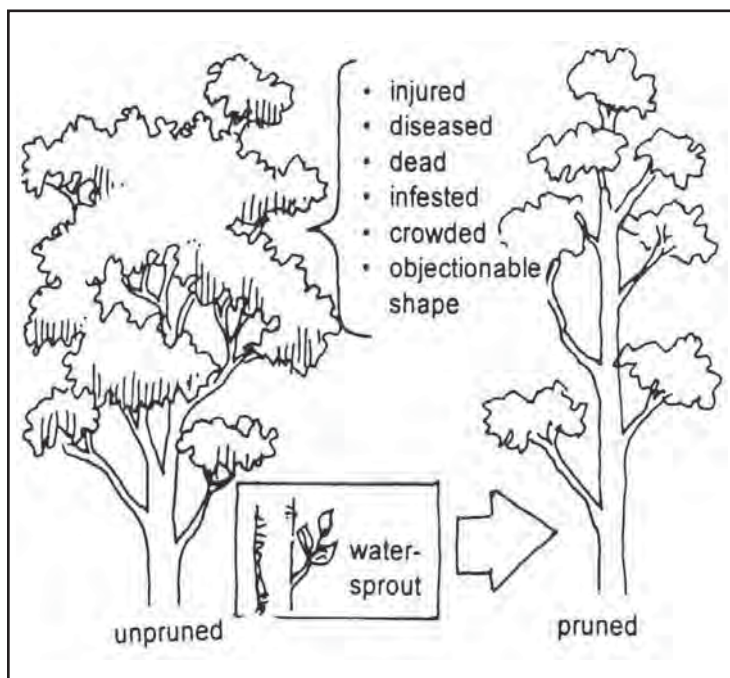

Tree pruning is the art of cutting or removing unwanted plant growth to make the plant grow or behave the way we want it to.

Objectives of Tree Pruning

1. Removal of diseased or broken branches;
2. Removal of tree parts which will inhibit the proper growth of tree such as when one limb rubs on another limb;
3. Removal of branches to allow adequate light, to promote better fruit production and to allow wind to pass through the tree canopy;
4. Trim trees to prevent interference with electric or telephone lines (or cable TV);
5. Encourage/increase flowering and fruit production; decrease the number of fruit so larger fruits are produced;

6. Rejuvenate old plants (or trees with good coppicing ability); and,
7. Create special effects and shapes; enhance the natural lines of a tree or shape a plant to accommodate space.

Tree pruning, if done correctly, will enhance the beauty and production of a tree without causing damage and infection to the tree. Frequently, people prune a tree by cutting branches with a bolo without thought to what will happen to the cut portion of the tree. If the branch stump is not properly pruned, there is a good chance of infection to set in. Once the infection starts in the tree, it can travel to the trunk and eventually kill the tree. The damage will generally not be seen from the outside of the tree.



Growth of infection in improperly pruned tree

The Ideal Time for Pruning

Growth of infection in improperly pruned tree

1. After the harvest season for fruit bearing trees
2. Before the rainy season for light pruning or trimming
3. Two to three months before the rainy season for rejuvenation
4. When infection, infestation, objectionable branches and damages are noted.

Proper Tools for Tree Pruning

There are a number of tools which are used to prune trees. These range in size from a small hand-held pruning shears to large pole cutters and chain saws. The size of the branch, the height above the ground and the reason for pruning will determine which tool to use.

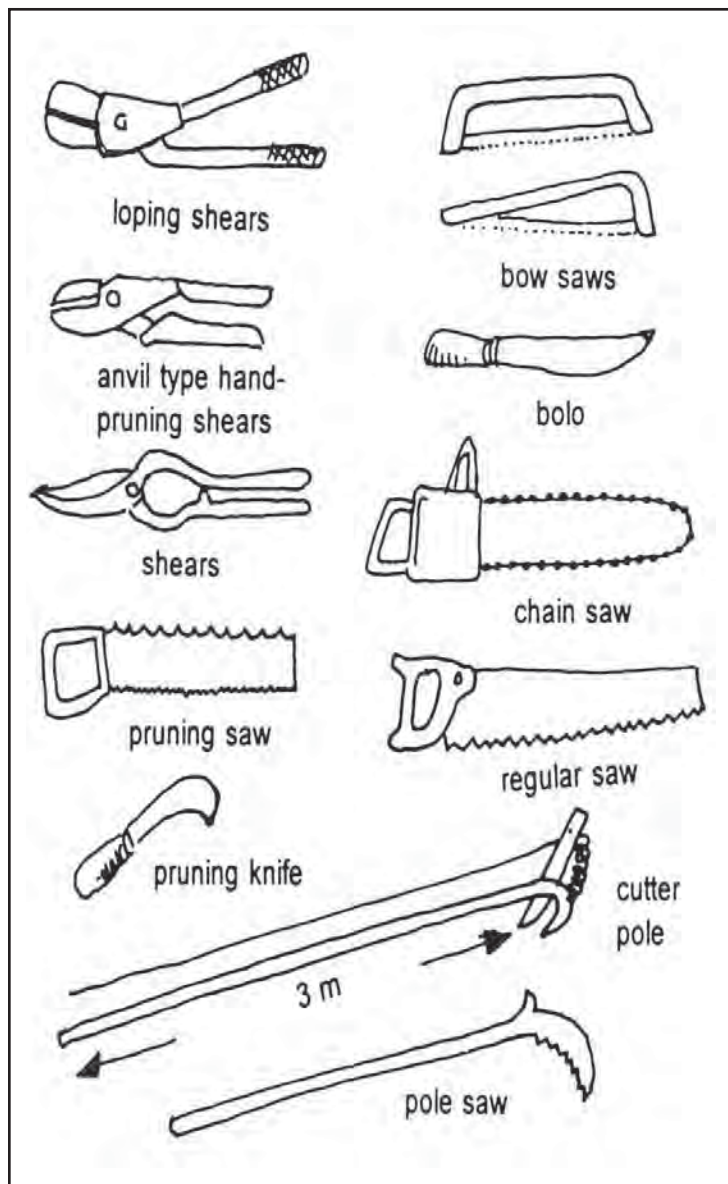

Branch Removal

1. Small branches

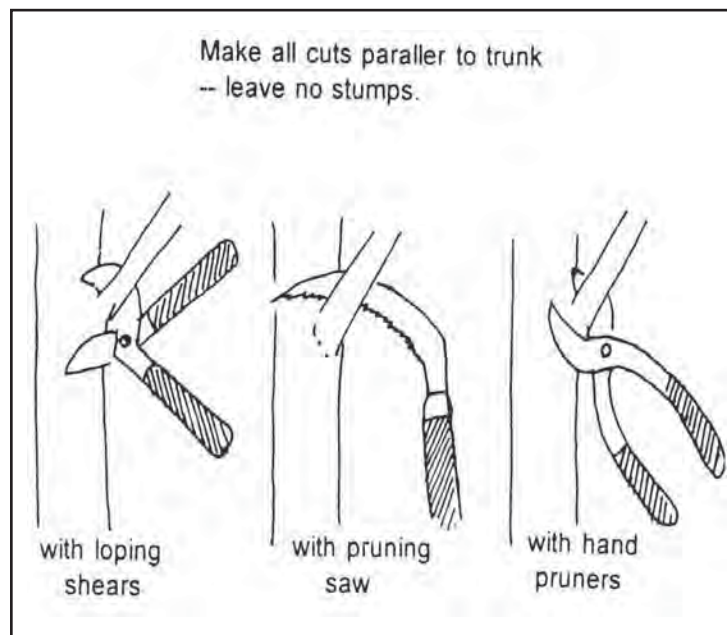

2. Large branches

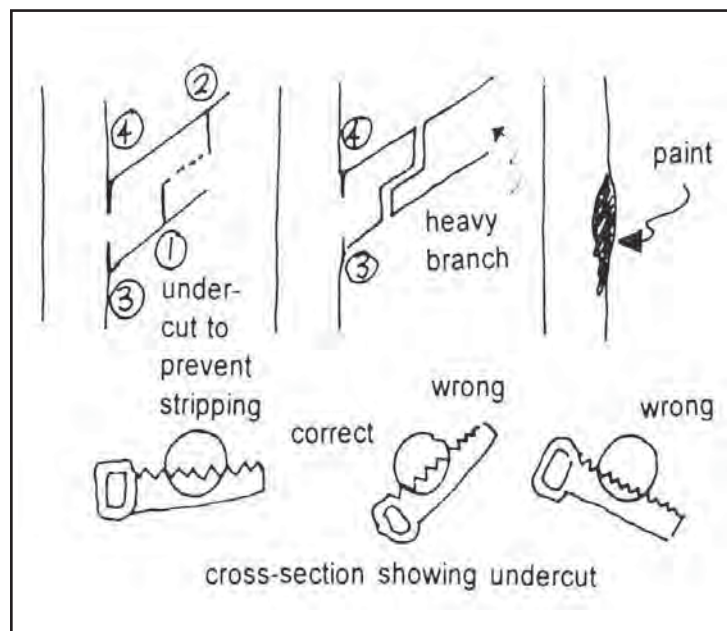

Different Types of Tree-Pruning Techniques

1. Hedges

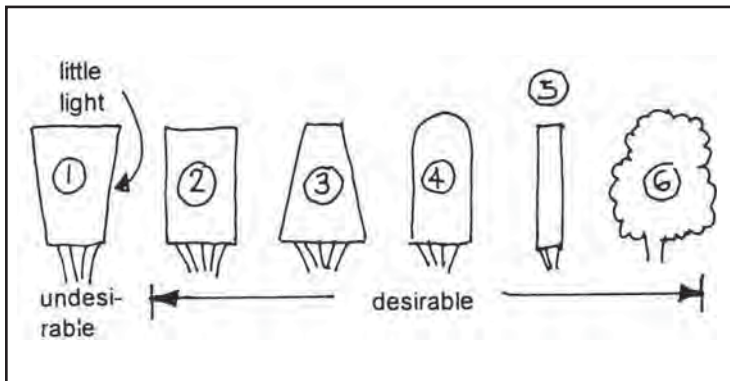

2. Branches near houses or other structures

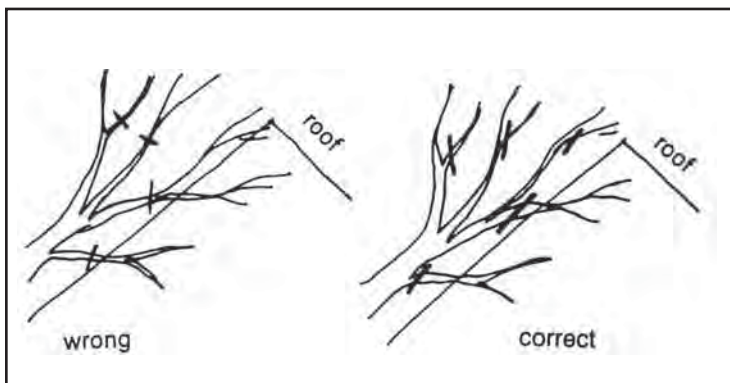

3. Telephone, electric and other lines

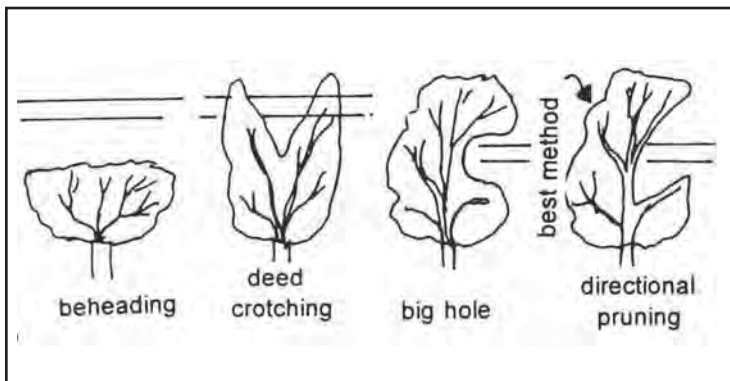

4. Opening so water flows out of the trunk

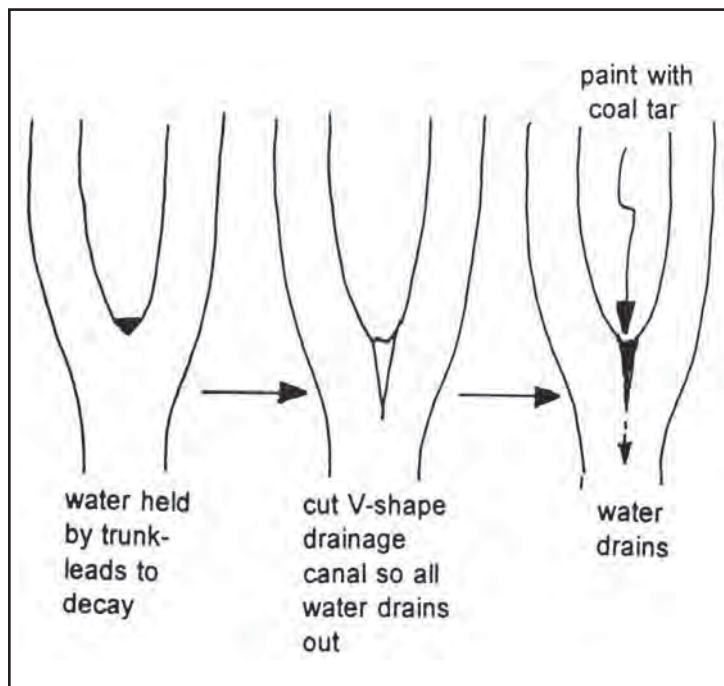

5. Cleaning all the branch stumps

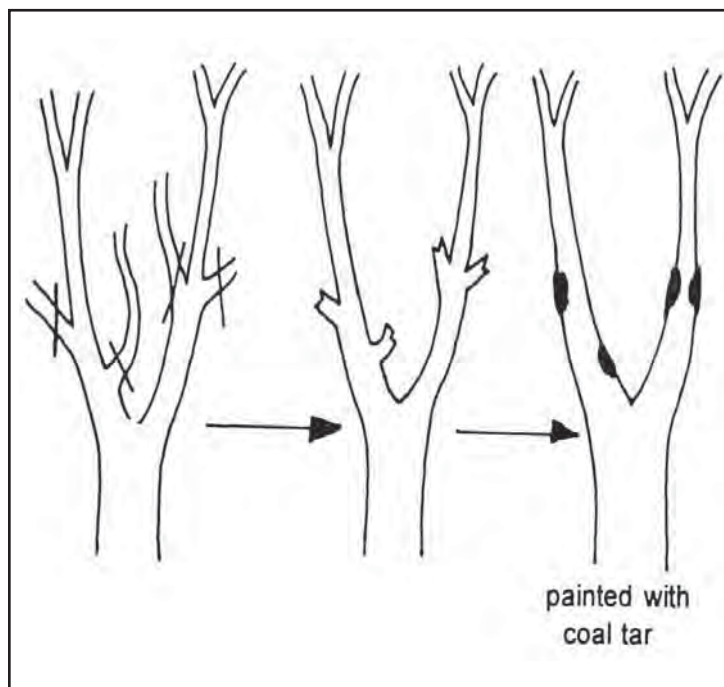

6. In reforestation projects (unnecessary branches and the double stem)

Examples:

Gmelina arborea

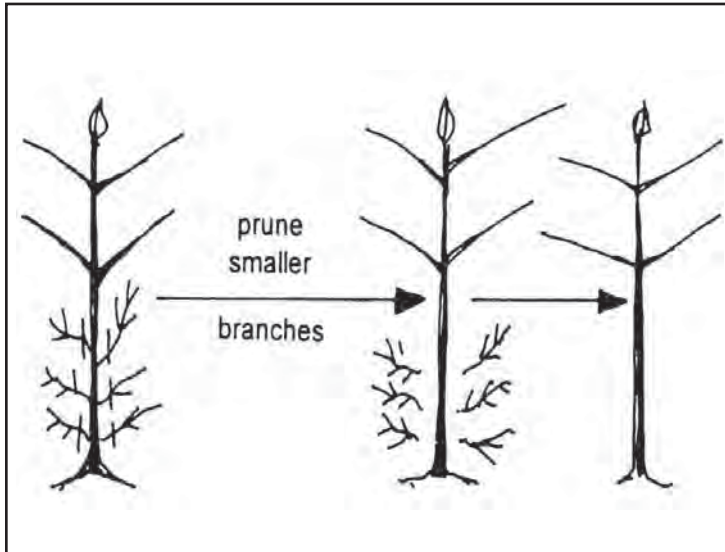

Mahogany

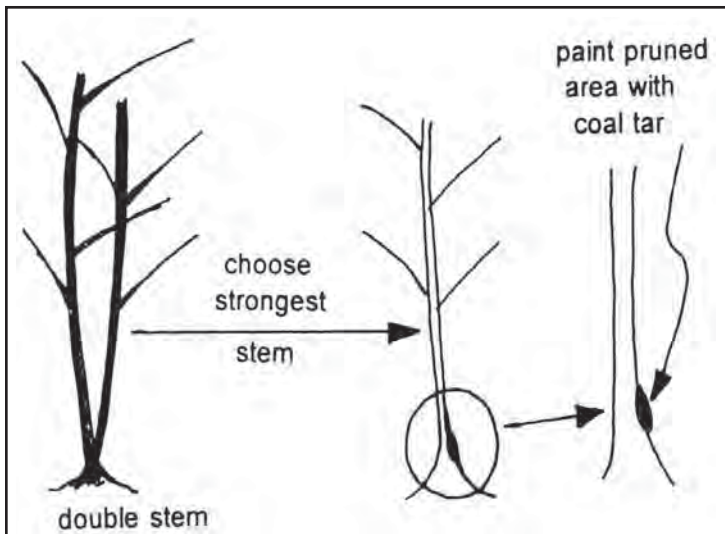

7. Pruning for rejuvenation

When pruning the main trunk for rejuvenation, make a slanting cut through the trunk so water will run off the cut. If possible, paint the cut with coal tar.

Example:

Coffee

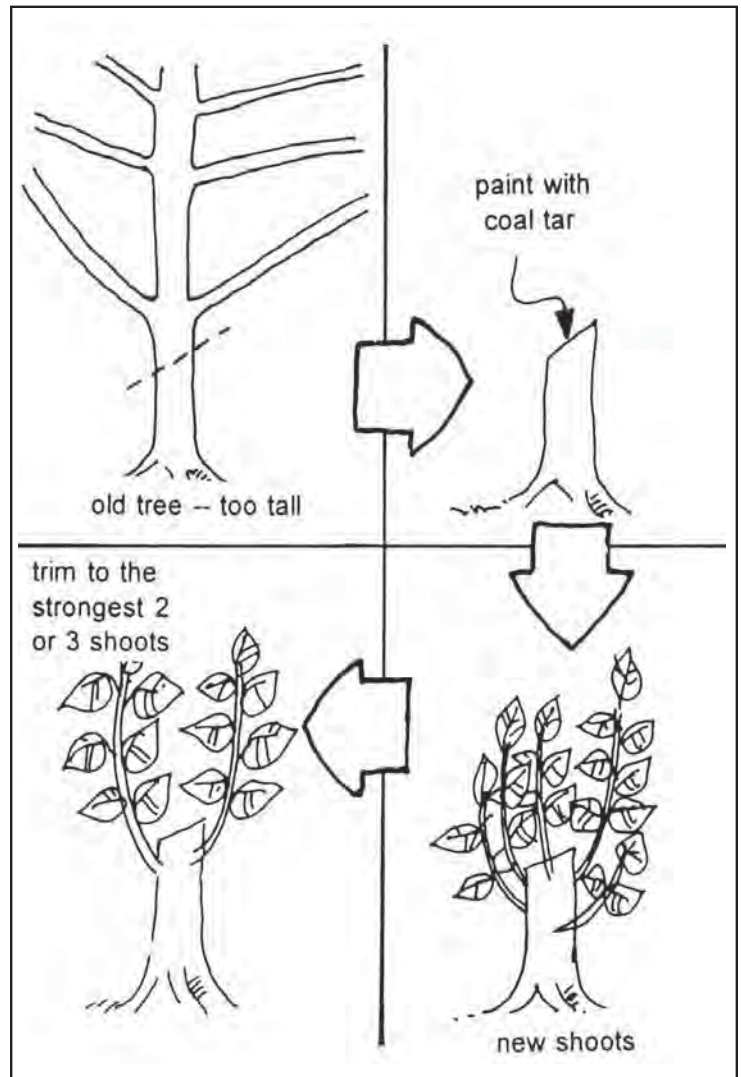

Source: IIRR and DENR. 1989. Agro forestry technology information kit. IIRR, Silang, Cavite, Philippines

Optimum Use of Marginal Land with Agroforestry System

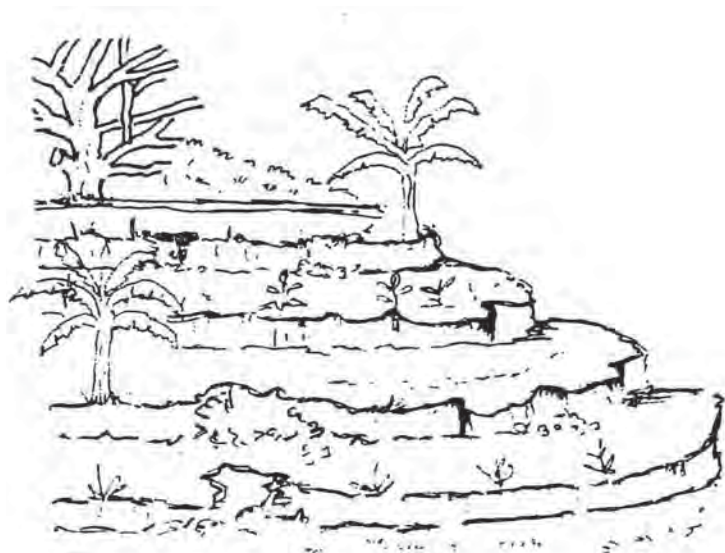

Pivate marginal lands, such as abandoned terraces, degraded and/or eroded land and often single-cropped areas, can be converted into more productive land.

While establishing the system, the emphasis must first be given to improving the soil fertility of the land. This can be done through the use of legumes (green manuring), in situ mulching and/or composting and the incorporation of any other locally available organic matters, such as agricultural by-products and other biodegradable materials.

Benefits Accruing from this System

1. Productive use of marginal land.
2. Reduction of soil erosion.
3. Early returns as fruit, fodder grass, vegetables and fuelwood can be harvested the second year.



4. Income-generating sources created.
5. Lower maintenance because perennials require less attention than annual crops.

Factors to be Considered before Establishing the Agroforestry System

1. Identify the marginal land to be converted.
2. List the locally available and suitable plant species. These will include legumes, shrubs, fruit and other multipurpose trees selected by the farmer.
3. Protect the area, if necessary, through live fencing, using plants, such as Asuro, Khirro, Taletto, Padke, Simal, Ketuki, Sajizvan, Sihundi, Nilkanda, etc. Stone-fencing can be built if sufficient stones are available.
4. Prepare a simple scheme of the major species that the farmer

wants to establish over the long term. Focus should be given to fruits and fodder.

5. In-situ composting, green manuring and green leaf manuring should be done wherever possible for improvement of soil fertility and for water conservation.

Steps to be Taken while Establishing the Agroforestry System

1. Seasonal legumes with vigorous growth, for example: cowpea, velvet bean and rice bean (masyang) should be planted in the beginning in order to have enough soil cover, thereby improving the soil condition. Planting should be dense and thick. The best time to plant these species is April-May.
2. In the first year, with the onset of the monsoon, pioneer species, such as banana (at lower elevations), pineapple and some tree species can be planted following the contour or at regular intervals. At the same time, pits can be dug for other tree species.
3. The dug soil from the pit should be mixed with a little compost and returned to the pit in order to prevent soil loss.
4. Tree seedlings can be planted in the prepared pits during July-August.
5. The base of the fruit and other tree seedlings should be mulched in order to prevent soil moisture loss and to provide nutrients from the organic matter to the seedlings.
6. Weed the base of the tree regularly.

Intervention Scheme

Year	Inputs/Activities	Output/Return
I	<ul style="list-style-type: none"> Planting grain legumes, banana, pineapple, up to 100 malt. and some tree species <i>In-situ</i> compost-making Addition of all available organic matters Mulching and weeding 	<ul style="list-style-type: none"> Seasonal legumes can be harvested Fodder grass for cattle can be harvested
II	<ul style="list-style-type: none"> Continuation of legumes and <i>in-situ</i> composting Planting fruit saplings Replacement planting, if necessary Planting of vegetables (i.e., brinjal, tomato, pumpkin, gourd, etc.) Continue mulching and weeding Addition of more tree 	<ul style="list-style-type: none"> Seasonal legumes and early maturing pineapples can be harvested Grass, fodder can be harvested
III	<ul style="list-style-type: none"> Continue activities, such as legume planting, mulching and weeding at the base of fruit trees 	

An example of using marginal land for integrated fruit farming

- Establish a diversified fruit orchard integrating mandarin orange, sweet orange, lemon, coffee, cardamom, guava, pineapple, banana, plums and pear.
- Plant ipil-ipil and *Albizia falcataria* on the bund of terrace by direct sowing. Distance between plants should be 50 cm.
- Plant *sisso*, *bakaino*, neem, bamboo, *koiralo* and other fodder species on the boundary line of the orchard with the following distance between plants:
 - *Sisso* — 2.5 m
 - *Bakaino* — 10 m
 - *Neon* — 15 m
 - Bamboo — 30 m
 - Fodder trees in between of other plants.
- Plant coffee, banana, orange and pineapple. Alternate orange and coffee in rows. Plant banana and pineapple throughout the fields between the orange and coffee.
- Intercrop various species of legumes, garlic and onion.

Source: Nalini Subba – Regenerative agriculture technologies for the hill farmers of Nepal

Upland Rice Cultivation with Agroforestry (AGF)

- Wherever possible, introduce hedgerow strips of tree legumes every 6-7m of about 1m deep to provide green-leaf fertilizer for upland rice. Suggested tree legumes are Kakawati, *Cassia spectabilis* or ipil-ipil.
- Select a rice variety with a growth season well within the rainfall duration. The variety should mature by the time rainfall recedes.
- Sow the rice seeds at the onset of the rain. A rainfall of 55-60 mm is desirable to ensure uniform and adequate plant population. Planting can be done either by broadcasting, dibbling, hilling or drilling.
 - The land is prepared moist or dry. A modified broadcasting method is done by furrowing a harrowed field with a lithao. Seeds are broadcast uniformly and then a peg-toothed harrow, kalmot is used to pass diagonally across the furrows.
 - Thorough land preparation can effectively control weed population during the rice vegetative stage. Plow the field and leave it for a week to allow weeds to germinate. Harrow the field twice. Allow weed seeds to germinate. Then harrow for the third time to incorporate the weeds into the soil.
- When hedgerows of tree legumes are tall, prune to hedges and leave the branches on the strips to allow leaves to decompose.
- Keep the field free from weeds for about 40-60 days after emergence to minimize yield losses. Competition for light, nutrients and soil moisture begins early.
 - Hand-weeding is done if seeds were broadcast. However, in modified broadcasting or row planting, mechanical weeding using a hoe can be done.



- In slopy areas where plowing is not possible, the use of crop residues as mulch can help control weed growth.
- The leaves of legumes serve as fertilizer. If there is a large amount of biomass applied into the field at pruning time, it is not necessary to put chemical fertilizers. Using a legume-cereal rotation can also help improve fertility.
- Pest control can be done as the need arises. Integrated pest management (IPM) is highly recommended.
- As soon as the grains are ripe (about 80-85 percent is mature), harvest the crop.
- Increase productivity by intercropping and crop rotation. Legumes planted with rice or planted before or after rice can substantially improve yields with reduced external inputs.

Cropping Possibilities

Option 1

■ Start of the season



Plant alternating 2-3 rows of upland rice with a row of bush-type legume (preferably a short-maturing one). About 16-20kg legume and 50kg of upland rice is needed to plant a hectare.

■ Two months after



When the rice is at its late vegetative stage, the legume is harvested. The space occupied by the legume can be planted to corn or other crops like cassava or vegetables.

■ Four to five months after

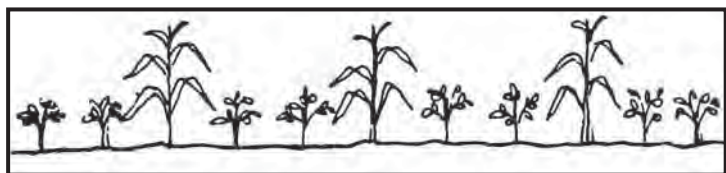

After the rice harvest, plant a short-duration legume crop where the rice was planted. If the field is free from weeds, the legume seed can be drilled or dibbled. Or, plant lablab or velvet bean following upland rice.

Towards the dry months Plant legumes that cover the soil during the dry season. Good potential cover crops include rice bean, batao and velvet bean.



Option 2

Plant rice in strips during the onset of the rainy season.



After the rice harvest, plant 1-2 rows of legumes for every 2-3 rows of corn. Peanut, mung bean or cowpea can be planted as intercrop.

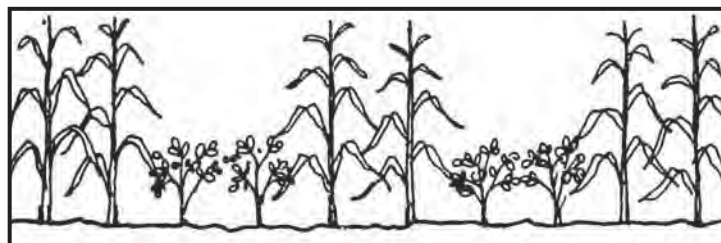

Before the crops are harvested, plant legume cover crop to protect the soil during summer.



Option 3

Plant the whole field with upland rice. It is suggested that more than one variety of rice in one field should be planted to spread the risk from calamity.



After the rice harvest, plant legumes. If the rice was planted in rows and the field is free from weeds, the succeeding crop can be relayed one week before harvesting rice. Cowpea, mung bean and peanut may be planted.



Corn can be planted just after the legumes in case there is still sufficient soil moisture.

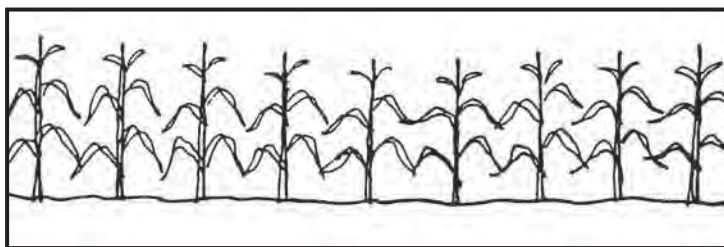

But if the soil moisture cannot support corn growth, a third crop of cover crop like rice bean or lablab is suggested.

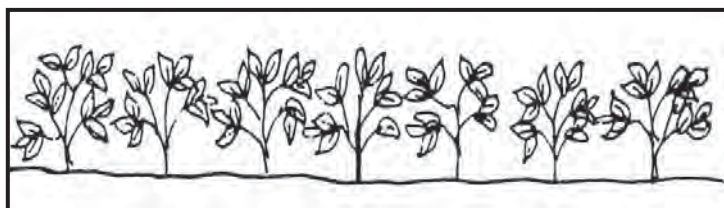

Intercropping Under Residual or Logged-over Areas

This technology involves the intercropping of coffee, betel and rattan under the residual or logged-over areas. The residual or logged-over areas are usually cleared of underbrush (vines, shrubs, climbing bamboos, etc.), leaving naturally growing trees at 14-18 meters intervals and when necessary supplemental planting of forest trees is resorted to depending on the degree of shade provided by the canopy. Coffee saplings are planted at 2-3 meter intervals under the forest trees that act as nurse trees.

The technology has been practiced by the migrant Ifugaos in Nueva Vizcaya, Quirino and parts of Isabela. The areas where this technology is being applied are usually with (1) an estimated elevation range of 400-1000 meters above sea level; (2) with rolling to hilly terrain; (3) within the second and third climatic types; and, (4) whose soil are rich in litterfall or accumulated humus.

The technology is an adaptation and/or modification of an indigenous practice of muyong or pinugo system (woodlot) of the Ifugaos. The system is characterized by the following:

- has low inputs and relatively low-to-medium yields;
- minimizes disturbance to the forest ecosystem in terms of vegetation, fauna and physical environment;
- serves as shelter for wildlife and source of animal protein in terms of trapped bats and squirrels; and
- supports the viability of irrigated rice paddies located downstream.

Integrated Nutrient Management on Rice-based System

Introduction

For developing countries like the Philippines, one of the stated limiting factors in rice production today is declining soil fertility. Consequently, farmers have resorted to the use of chemical fertilizers. However chemical fertilizers, though effective in the short run, are expensive, often unavailable to small farmers and damaging to the environment. For the majority of small farmers, the use of the 'recommended' amount of chemical fertilizer is not often possible due to lack of capital or because it does not make economic sense. For these important reasons, there has recently been a great deal of interest in nutrient cycling and in alternative sources of fertilizer.

The Low Input Rice Production Project

The negative effects of high-chemical input strategies (leading to the high cost of production) have prompted various agricultural institutions and development agencies to come up with alternative technologies. For its part, the International Institute of Rural Reconstruction (IIRR) with the financial support of the Rockefeller Brothers Fund (RBF) initiated the Low Input Rice Production Project (LIRPP). This project was started in May 1986 in

three sites in the Philippines namely: Negros (with the Philippine Rural Reconstruction Movement (PRRM)), Quirino (with the Quirino Livelihood Concept Foundation) and in Navarro, a lowland rice-growing community the province of Cavite, Philippines.

Through this project, IIRR has been able to test, adapt and then promote low-cost, ecologically sound, and sustainable rice-based production technologies. Important elements of the LIRPP are (1) reduction of chemical inputs, (2) diversification of farm enterprises, (3) integration of livestock and fish, and (4) introduction of practical approaches to the inclusion of bio-fertilizers. The objective of the project is not to establish a "model farm" but to offer a variety of technological options to interested users to adapt in whatever combinations they themselves prefer. The target beneficiaries are the small farmers who have limited financial resources. Rural development workers can also benefit from the LIRPP experience through training conducted on site and through the dissemination of an information kit on low-input technologies for rice.

The main technologies tested at the LIRPP farm at Navarro and a summary of results are represented below.

Use of bio-fertilizer: At the Navarro project site, three green manure technologies were used: *Sesbania rostrata*, *Azolla* and *Gliricidia* green leaf.

Integrated Nutrient Cycling Approaches in a Lowland Rice-based Farm: The Case of LIRPP Farm

The idea of “organic wastes” and “waste spaces” becomes obsolete: The wastes serve as additional nutrients and the waste spaces can be devoted for the production of energy, feed or fertilizer.

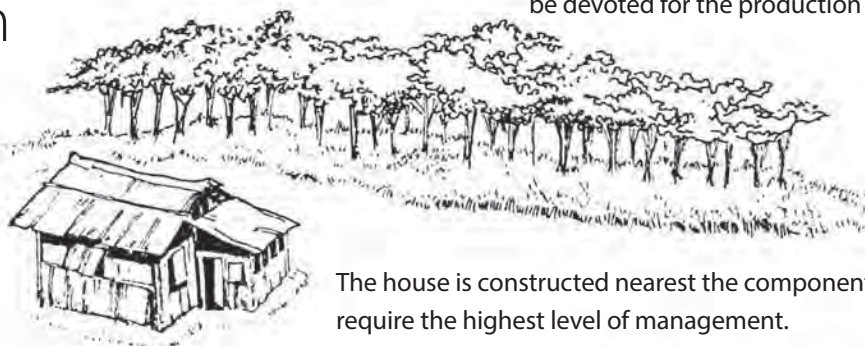

The house is constructed nearest the component(s) that require the highest level of management.

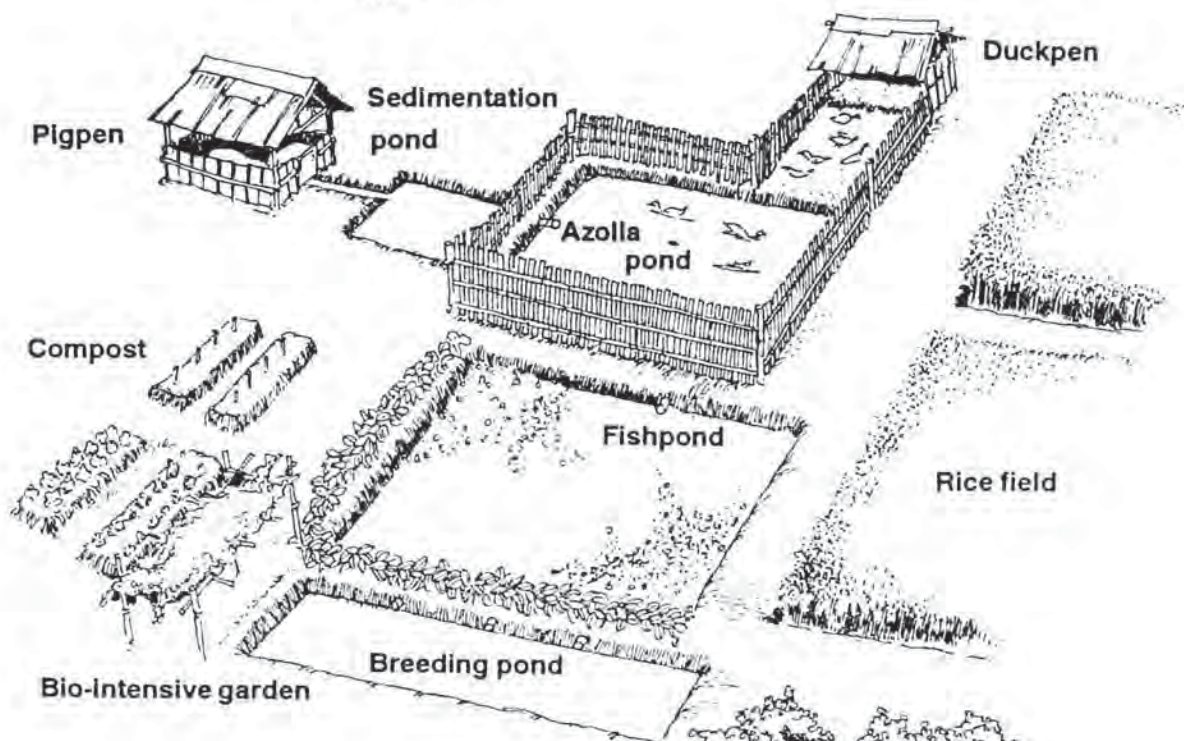

Some components are integrated to conserve labour and excess nutrients and optimize the utilization of those nutrients. It is designed to use energy and nutrients in the most efficient manner, eg.compost (which has high labour cost) is used for high value crops such as vegetables.

Animals are incorporated into the system to utilize “wastes” and products man cannot use. Some animals may also provide draft power.

manure. *Sesbania rostrata* was grown during the month of May and incorporated into the soil after 45 days of growth. A permanent *Azolla* multiplication pond (150sqm) was made to supply the inoculum for the rest of the rice paddies. In addition, seedlings of *Sesbania rostrata* were planted 30cm apart along paddy bunds (total of 40 meter-row) for seeds for the next year. The *Sesbania*-fertilized plot resulted in a rice yield of 5 tons per hectare giving a net return of more than P14,000.00/ha (Exchange rate: US\$1.00 = P20.00). Soil analysis in the trial plot showed an increase in organic matter.

Azolla-fertilized plots after the sixth cropping yielded 5 tons per hectare (with no chemical fertilizers) and a net income of more than P12,000.00, a great improvement over the net income of P7,000.00 per cropping

Planting of *Gliricidia sepium* around the Homelot and Along the Bunds

Leaves of *Gliricidia sepium* are an excellent source of nitrogen for rice but have not been used previously in lowland paddies in the Philippines. Green leaf manuring using *Gliricidia* leaves combined with inorganic fertilizer increased yield by 40-60%. The *Gliricidia* is planted on rice-paddy bunds/dikes so that the source of green-leaf manure is easily accessible. The bushes are pruned 3-4 times a year to reduce shading problems. In Navarro, the IIRR test plot fertilized with fresh leaves of *Gliricidia* (3 tons/ha) plus 20kg N/ha applied 45 days after transplanting yielded 3.7 tons/ha or a net income of more than P7,000.00/ha after the third cropping. *Gliricidia* leaves also possess insecticidal properties.

Problems of rice bugs and other insect pests can be reduced by stacking the branches and leaves in the corners of the rice field.

Rice Straw Mulching/Incorporation:

Rice straw is the cheapest source of nutrients in lowland rice. Rice straw from the dry season harvest is immediately spread/scattered back across the field and incorporated during land preparation. Some rice straw is piled (mandala system) and used to feed farm animals. Straw from the wet season harvest is piled in one section of the farm and allowed to decompose. In the farmer's field, 3 tons of rice straw could be easily harvested and this could provide at least 30kg nitrogen, 6kg phosphorous and 75kg potassium and other micro nutrients. Straw incorporation can therefore reduce the fertilizer requirements of the rice crop.

Raising of Farm Animals:

Livestock are an integral part of the nutrient cycling system of a farm. They directly or indirectly affect the following three aspects of nutrient cycling:

- Redistribution of Nutrients - Nutrients are brought in or brought up from deeper soil levels by trees whose leaves are fed to livestock.
- Increasing Nutrient Availability - Nutrients from crop residues and other feeds become more available for the plant when converted to manure.
- Increase in Nitrogen Supply - Livestock require protein and, to the extent that legumes are used in the system (either grown or brought in from the outside) to feed livestock, they cause an increase of nitrogen in the system.

The contribution of livestock to farm income/savings may be summarized as follows:

- The Navarro farm maintained carabaos (water buffalo), ducks, pigs and native chickens. Two carabaos are raised per hectare of rice land. These animals can be used as draft power for land cultivation. They are fed on rice straw and napier grass grown along the paddies. The use of carabaos instead of hiring a fuel-based hand tractor can reduce land preparation costs by 50%. About 3 tons per year of dried manure can be generated from these 2 carabaos. The manure can be used to fertilize rice/fish paddies and vegetables.

- Hog Production (2 head) - Fed on rice bran, farm-grown feeds (e.g. kangkong, gabi, *Azolla* etc). An extra income of P500 in just 5 months can be realized from 2 head of pigs. The manure generated is used to fertilize the mini-fish pond.
- Ducks (25 head) - Fed on golden snails and *Azolla*. They are used to weed the rice field and produce eggs and meat for the family.
- Native Chickens - Grazed on grass or on kitchen "left-overs." They produce meat and eggs for the family.

Potential Alternative Sources of Nitrogen Fertilizer for Lowland Rice which Could Supply the 80kg N/ha Requirement of a Rice Crop

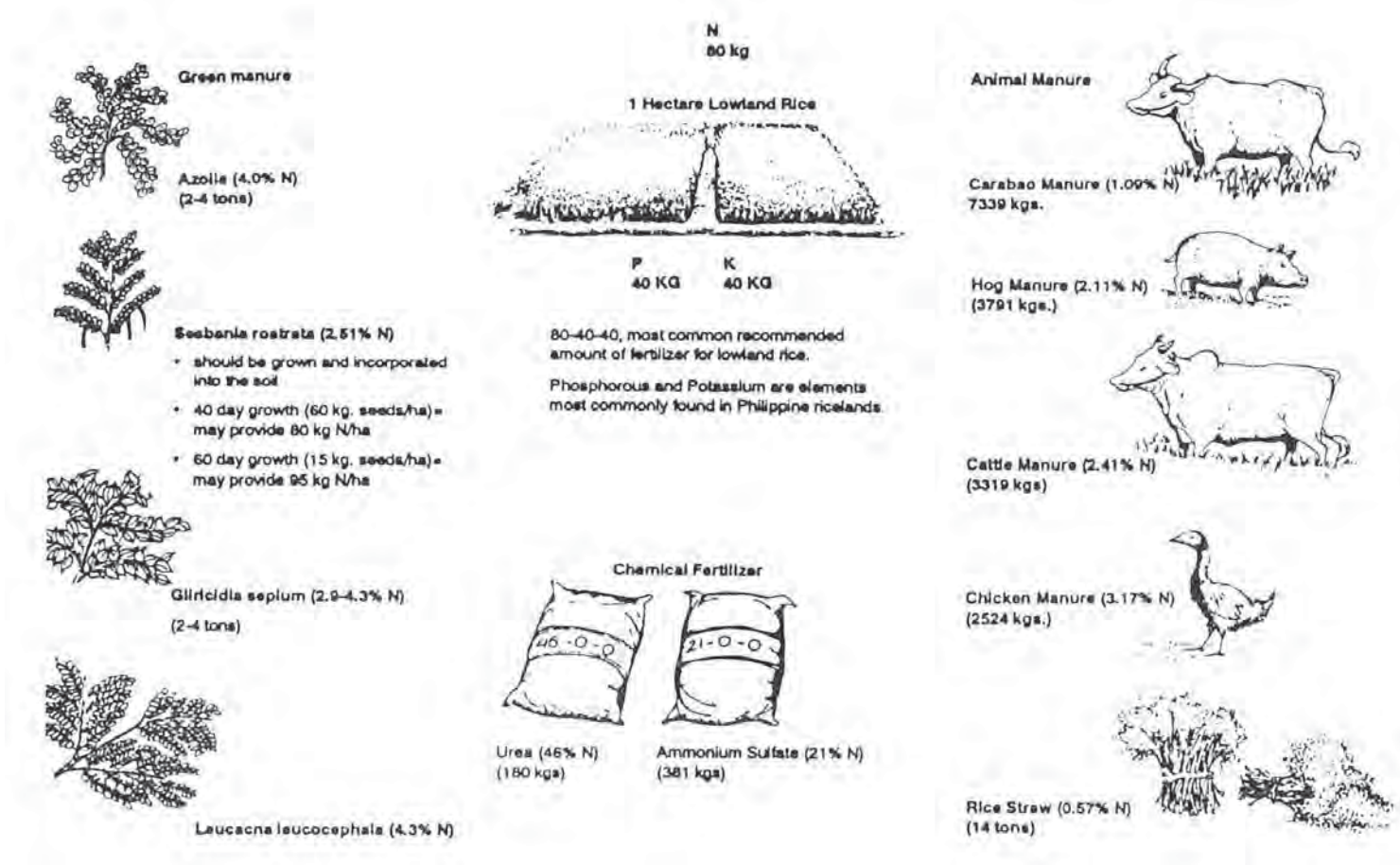

Vegetable Component (Bio-intensive Garden):

Adding a vegetable component can help ease daily household cash flow problems and improve family nutrition. While the rice is still under production a farmer can earn income in 3-4 weeks from short-duration leafy vegetables. Fertilizer for this component originates from the caribou shed .

Fodder Production:

Our work in LIRPP has focused on growing fodder on paddy dikes and sorjan beds (a series of raised beds and sinks of the same size). The objective has been to produce enough feed on one hectare of riceland to meet the feed needs of draft animals when they cannot graze in vacant fields - a period of time usually period of lasting four to five months, when all rice fields are being prepared and planted. Napier grass was planted on about 500 linear meters of paddy dikes and on Sorjan bed edges. Growth in sorjan beds has been better than on paddy dikes reaching rates as high as 11kg/5 linear meters every 20 days. Production on large paddy dikes has also been good but those dikes lower than 20cm have shown relatively poor growth in the rainy season probably due to excess moisture.

Weed Control Using a Hand-pushed Rotary Weeder:

Use of a hand-pushed rotary weeder and handweeding is an option for controlling weeds instead of using costly chemicals and hazardous herbicides. The destruction of frogs, mudfish, catfish and edible native snails is noticed on Philippine farms using herbicides. We compared two weed control technologies: the use of herbicides (Machete) and Mechanical Rotary weeders. The cost of weeding was higher by 14% on the Rotary Weeder plot than on the herbicide-treated plot due to higher labour needs. However,

the yield increase was enough to pay for the increase in the cost of weed control by using the rotary weeder. So the benefit of the Rotary Weeder will be to aid in fertility build-up by incorporating weeds and *Azolla* into the soil which then decompose and provide organic matter and help conserve aquatic life. Use of mechanized weeders instead of chemicals makes fish raising in conjunction with rice possible.

Mini-fish Pond (100sqm.):

A fish pond was constructed for 100 Tilapia nilotica fingerlings to provide fish for the family, as a drainage area for the spent water from the hog house and as a growing area for swamp cabbage. Twenty to thirty kg of tilapia could be harvested in just four months thus providing an additional income for the family. However, the greatest benefit of the mini-pond is the convenience of a fish source on the farm and the impact on family nutrition given the prevailing high costs of fish in the market.

Rice/fish Culture:

Raising fish and rice in the same paddy increases rice yield by 20 percent even though 10% of the land area is devoted to trenches (thus depriving the farmer of some space for rice production). The trials on IIRR's project sites have demonstrated that chemical use can be reduced by raising fish in paddies because of the reduced weeds and insect control resulting from the eating habits of fish. The fish eat aquatic weeds, worms and insects that destroy the rice crop. The activity of the fish in rice paddies, the recycling of nutrients and the release of fish faeces in the paddy also improve the nutrient status of rice paddies where fish are present. About 400kg of fish can be harvested per hectare in 120-150 days. The combined income from fish and rice can earn a net income as high as P22,000 per hectare per season. As with the mini-pond, rice/ fish culture is valuable not only for the added income it produces, but also for the added fish protein that becomes readily available to the family.

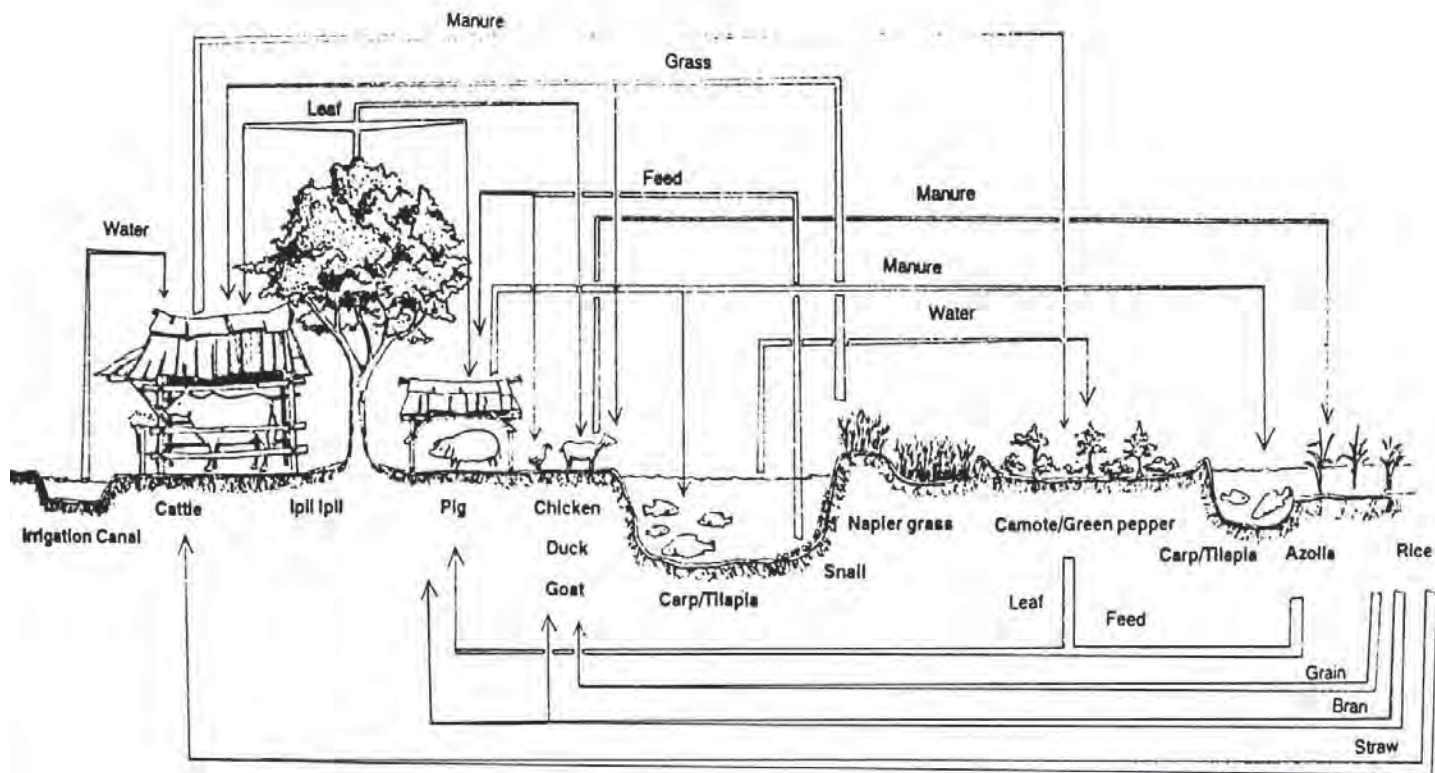

Conclusion

For a developing country like the Philippines, the maximum reutilization of organic wastes and the utilization of available resources on the farm are important to the maintenance and improvement of soil fertility and to the reduction of agricultural costs. The cultivation of green manure crops (e.g. *Azolla*, *Sesbania*, *Gliricidia*, etc) and the incorporation of rice straw are some of

the effective alternative sources of fertilizer for lowland rice. The integration of livestock, fish and vegetables in the farming system will serve as a source of food and income, and at the same time the waste materials can be used as a source of nutrients for the crops. Knowing the nutrient flows and the contribution of each component of the farm in a systematic manner will contribute towards the goals of regenerating the land and sustaining the farming system.

Green Leaf Manuring in Lowland Rice

Introduction:

Green leaf manuring (using the leaves of leguminous trees for lowland rice) has been used in South Asia for centuries with yield increases of up to 2 ton/ha compared to unfertilized rice fields. Recent work with farmers in Negros and Cavite has shown that green leaf manuring works in the Philippines as well.

Advantages of using green leaf manures (GLM) include:

- Up to 4 tons dry leaf matter (equivalent to 120kg N) can be produced from 400 trees spaced 2m apart on the bund.
- No need to replant green manure crops. The trees are perennial and provide leaves for GLM 2-3 times/year.
- Woody branches can be used for firewood.
- Easy to use. No complicated cultural practices for production or use are needed.

GLM trees can be integrated into almost any rice farm. Three options are described here based on planting systems used in Negros and Cavite with *Gliricidia sepium* (kakawate or madre de cacao).

Option No. 1

Gliricidia is planted along the paddy bunds. Spacing is 50cm-2m between plants.

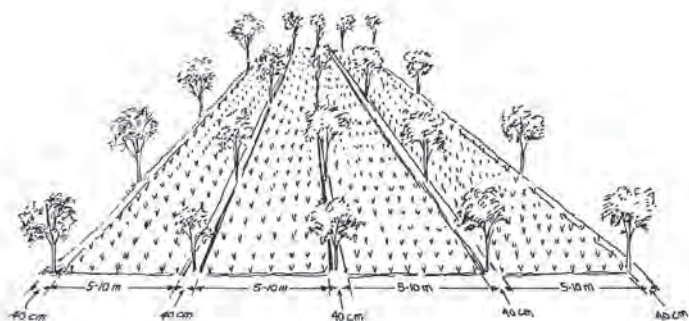

Option No. 2

Gliricidia is planted around field boundaries. Distance is 2m between plants. Dikes should be 50-75cm wide and 40-50cm high.



Option No. 3

Cut-and-carry system: *Gliricidia* is planted in areas away from the field. The major disadvantage of this system is the transport of biomass from the growing area to the field.

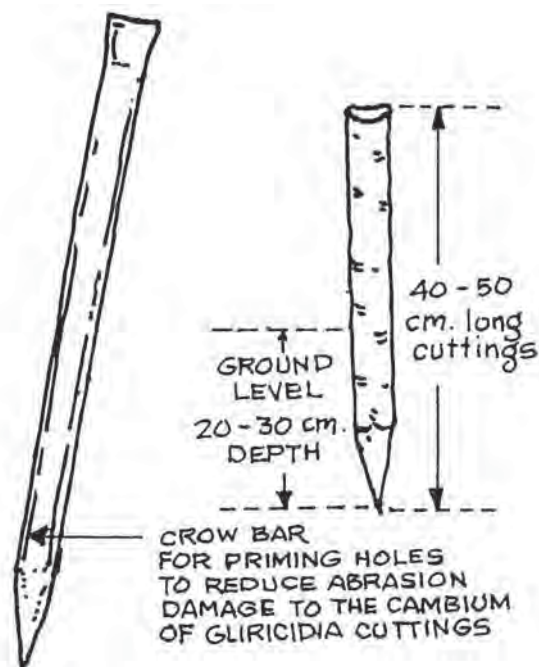

How to use Green Leaf Manure:

The practice of GLM is very simple. Any fast-growing leguminous tree species which tolerates poor drainage can be used. The leaves are lopped regularly (every 6 mos) and applied to the rice paddies during final land preparation as green leaf fertilizer. In order to reduce the labor requirements, the trees should be established at or near the rice production site.

1. One day before transplanting, cut branches of *Gliricidia* (with leaves). Chop the tender stems. The woody ones can be used as firewood.
2. Scatter the leaves evenly throughout the field. There should be no standing water in the paddy in order to fully incorporate the leaves.
3. Incorporate the leaves into the soil during the last harrowing/leveling of the field.
4. Transplant rice seedlings immediately after incorporation.

Notes on the Use of *Gliricidia*:

- Two loppings are recommended per year. If there will be no second crop to put the GLM on, the second cutting should be done 1-2 mos before the onset of the dry season. This

stimulates new growth which can survive a 6-month dry season without dropping its leaves. The loppings could be used as fodder.

- *Gliricidia* may have pesticidal properties against major pests of rice.
- *Gliricidia* can serve as living stakes for climbing plants like pole beans. It is also an excellent source of firewood, building materials for livestock pens and fence materials.

Two methods of establishing trees for GLM are used: seeds and cuttings. Recent work at IIRR has shown that the method of planting cuttings greatly affects the establishment and growth rates of trees. The recommended method of planting cuttings of *Gliricidia* is described below.

Other species recommended for glm for rice

Species	Local Names	Quantity of Leaves Recommended/ha.
1. <i>Leucaena leucocephala</i>	Ipil-ipil	1,000-8,000kg/ha (fresh cut)
2. <i>Samanea saman</i>	Acacia	-do-
3. <i>Acacia auriculiformis</i>	Japanese Acacia	
4. <i>Pithecellobium dulce</i>	Kamachile or Kamunsil	-do-
5. <i>Derris indica</i> * <i>Pongamia indica</i>	Bani or Balok-balok ponggam	-do-

Source: IIRR. 1990. *Low External Input Technology Information Kit*, IIRR, Silang Cavite, Philippines

* Please note that this is not *Derris elliptica* or Tubli. *Gliricidia sepium* (kakawate) has the same quantity of leaves recommended/ha as the GLM species given above.

Pot/Bottle Gourd Irrigation for Fruit Tree Saplings

Pot or bottle gourd irrigation is a method of providing a regular supply of water in hot/arid climate to high-value plants, such as mango, without having to visit the plants every day. When small seedlings are planted, there is a risk of them drying out. This technique supplies the right amount of water for the first 1-2 years of establishment. The principle is the same as for drip irrigation: little and often, but without having to be there all that often! Clay pots, or shell of mature bottle gourds after you have taken out the seeds, are used—one pot/gourd per site. Bottle gourds are cheaper of course.

1. Dig a hole large enough to bury a small pot or bottle gourd (about 1 ft. deep and 1 ft. diameter) about 1-1/2ft (30-40cm) from a newly planted sapling.
2. Cut the top off the gourd and make a small hole on the side towards the seedling. Bury the gourd or pot in the hole so the top is about 1" above the soil surface.
3. Fill the pot/gourd with water and cover it to prevent evaporation.

Water will seep out of the porous pot walls or through the hole in the bottom of the gourd. About 5 liters of water should last one week. If the gourd does not empty within this time, make more holes. If it empties too quickly, put cotton wool in the hole to regulate the water flow. Refill the pot/gourd whenever empty.

- This technique may only be needed in the first year of tree establishment after which time the gourd will have rotted



anyway. In a cold arid climate, the technique may be needed for two years because establishment growth is slower.

- The benefit of using the gourd is that it is free of cost. You can grow your own irrigation system!
- The same technique can be used for vegetable and other types of trees.

Source: *Regenerative Agriculture Technology (RAT) Kit. IIRR UNICEF for Philippine Department of Agriculture. 1989*

System of Rice Intensification (SRI)

Climate-smart Rice Production

SRI creates a *triple-win* situation for agriculture, climate security, and food security because it:

1. Sustainably increases rice production and farmer incomes (greater crop *productivity*)
2. Strengthens crops' resilience to climate change and variability (facilitates *adaptation*)
3. Reduces rice production's contribution to climate change (helps promote *mitigation*)

1. Productivity

Rice yields are increased by 20-50% – sometimes >100-200%
SRI methods work for hybrids, HYVs, local and indigenous varieties

- **Higher water productivity gives 'more crop per drop'**
 - **Reductions in irrigation water requirements** – by 30-50% per hectare; and
 - **Higher water productivity** – more output of grain per unit of water input – by 30-100% [1]
- **Higher nutrient-use efficiency**
 - **Less fertilizer and agrochemical inputs** needed by 30-50%, and by 100% with organic SRI when relying on organic fertilization; higher nutrient uptake by larger root systems [2]
- **Higher seed productivity and better quality**
 - **Seed multiplication rate** can be >1000 times, compared to 90x with standard methods
- **Greater factor productivity**
 - **Labor productivity** – higher rice yield per day of labor [4]
 - **Benefit-cost ratio** higher due to higher yields with similar or lower production costs [4, 7] 2.

2. Adaptation

SRI plants show improved resistance to drought, floods, storms, pests, diseases

- **Improved drought resistance**
 - SRI plants thrive with 30-50% less irrigation water per land area, due to deeper, larger, lessenscoring root systems [5,7]
 - Reduced competition among plants creates stronger plants above and below ground
 - Organic matter-enriched soils able to store more water and furnish nutrients
- **Higher pest and disease resistance [6,8]**
 - Stronger and healthier plants
 - Less humidity in the plant canopy
- **Greater resistance toward rain and wind damage from storms**
 - Thicker tillers, deeper roots, wider spacing
 - Increased uptake of silicon into leaves and tillers from soil that has aerobic conditions
 - Reduced lodging – 10% lodging vs. 55% under conventional cultivation methods [6]

3. Mitigation

SRI enhances carbon sinks and lowers emissions that contribute to GWP

- **Expansion of carbon sinks**
 - **SRI rice plants sequester more carbon** – higher grain and straw yield, and more root biomass
 - **Increased soil organic matter** through SRI practices that improve the soil with more organic matter application and increased root exudates

- **Associated agro-ecological practices sequester carbon**, such as green manure production, integration with agroforestry, surface mulch applications, etc.
- **Reduced carbon footprint** due to less use of agrochemicals (including the manufacturing, and shipping of fertilizer)
- **Reduced greenhouse gas (GHG) emissions from paddy soils**
 - **Methane (CH₄) is reduced** by between 22% and 64%, as soils are maintained under mostly aerobic conditions [10,11,3]
 - **Nitrous oxide (N₂O) is only slightly increased** or sometimes reduced as use of N fertilizers is reduced; N₂O increases do not offset CH₄ reductions, so GWP is reduced [9,10,11,12]
 - **Total global warming potential (GWP) from flooded rice paddies is reduced** 20-30% [10,12,3], even up to 73% [11]

- [4] Ly P et al. (2012). The System of Rice Intensification: Adapted practices, reported outcomes and their relevance in Cambodia. *Agricultural Systems*, 113: 16-27.
- [5] Sridevi V and V Chellamuthu (2012). Advantages of SRI cultivation in the tail end of Cauvery Delta. *Journal of Crop and Weed*, 8:40-44.
- [6] Chapagain T et al. (2011). Assessment of System of Rice Intensification (SRI) and conventional practices under organic and inorganic management in Japan. *Rice Science*, 18: 311-320.
- [7] Mishra A and VM Salokhe (2010). The effects of planting pattern and water regime on root morphology, physiology and grain yield of rice. *Journal of Agronomy and Crop Science*, 196: 368-378.
- [8] Visalakshmi V et al. (2014). Impact of paddy cultivation systems on insect pest incidence. *Journal of Crop and Weed*, 10:139-142.
- [9] Wang Y. (2006). N₂O emission from paddy field under different rice planting modes. *Wuhan University Journal of Natural Sciences*, 11: 989-996.
- [10] Gathorne-Hardy A et al. (2013). A Life Cycle Assessment (LCA) of greenhouse gas emissions from SRI and flooded rice production in SE India. *Taiwan Water Conservancy*, 61: 110-12.
- [11] Choi JD et al. (2014). Effect of SRI water management on water quality and greenhouse gas emissions in Korea; *Irrigation and Drainage*, 63: 263-270.
- [12] Jain N et al. (2013). Mitigation of greenhouse gas emissions with system of rice intensification in the Indo-Gangetic plains; *Paddy and Water Environment*, 12: 355-363.
- [13] Suryavanshi P et al. (2013). Pattern of methane emission and water productivity under different methods of rice crop establishment. *Paddy and Water Environment*, 11: 321-32.

References:

- [1] Jagannath P et al. (2013). Meta-analysis evaluating water use, water saving, and water productivity in irrigated production of rice with SRI vs. standard management methods; *Taiwan Water Conservancy*, 61: 14-49.
- [2] Toriyama K and H Ando (2011). Towards an understanding of the high productivity of rice with System of Rice Intensification (SRI) management from the perspectives of soil and plant physiological processes. *Soil Science and Plant Nutrition*, 57: 636-649.
- [3] Suryavanshi P et al. (2013). Pattern of methane emission and water productivity under different methods of rice crop establishment. *Paddy and Water Environment*, 11: 321-32.

Source: <http://sri.cals.cornell.edu>

System of Rice Intensification (SRI) Method of Rice Cultivation

How to Produce More Rice with Less Inputs

The System of Rice Intensification is a new and promising resource-saving method of growing rice under irrigated or rain-fed conditions. Studies in a number of countries have shown a significant increase in rice yield, with substantial savings of seeds (80-90%), water (25-50%), and cost (10-20%) compared to conventional methods. SRI is not a technology, but a set of simple ideas and principles that help produce more productive and robust plants. The ideas are:

- I. Transplant very young seedlings, raised in an unflooded nursery.
 - II. Transplant them carefully and shallow.
 - III. Transplant single seedlings and at wider spacing than now.
 - IV. Apply a minimum amount of water – no continuous flooding.
 - V. Control weeds with active soil aeration.
 - VI. Rely as much as possible on organic matter for soil fertilization.
- Steps 1 to 7 show SRI methods.

Step 1

Nursery preparation using available inputs and methods. Pre-soaking seeds in water for 24 hours and incubating in a rags for 24 hours before sowing in a well-drained, garden-like nursery helps seeds to germinate faster. Line or random sowing of seeds in nursery can be done.

Step 2

Seedlings at 2-3 leaf stage, ready to be transplanted. Carefully remove seedlings along with soils using a shovel to avoid trauma to roots. Use a flat item to carry the seedlings to the field. Avoid damage to tender seedlings and their roots while transporting and don't let them become dried.

Step 3

Transplant young seedlings (2-leaf stage plant has the potential to attain 84 tillers) and do this carefully and singly at shallow depth (2-3cm) in slightly slanting position without removing soil particles attached to the seedling roots into a well puddled and levelled field but not flooded. Use spacing of above 25 x 25cm between the seedlings by using a marked rope or small pole to get uniform distance. This not only saves the amount of seeds required, but also reduces the competition for nutrients, water and sunlight. This gives roots plenty

Step 4

After transplanting, leave the field moist but without flooding for at least 12-14 days. This allows seedlings to adapt to their new environment. This should be followed by alternate wetting and drying (AWD) until the flowering stage (more at Step 5). SRI fields usually appear terrible for about a month or so. But after this time, it will prosper. of space to spread out, resulting in a large number of tillers and facilitates easier weeding.

Step 5

In a flooded rice field, plant roots die due to lack of oxygen. So SRI recommends a series of wetting and drying cycles until the end of the vegetative stage. This can be done by flooding the field for 3-6 days, and then draining the field and letting it dry out for a similar number of days, or less depending on the weather condition, to the extent of surface cracking (except for clay soil, which needs to be kept at least moist). This wetting and drying process allows the plant roots to grow well by accessing both adequate water and air. This saves water as compared to the conventional method and

results in better plant and root growth. In the reproductive stage, after flowering, a water level of 3-5cm should be maintained prior to 2 weeks of harvest, although with good root growth, AWD can continue.

Step 6

Carry out the first weeding at about 12-14 days after transplanting using a rotary weeder if possible. This implement not only aerates the soil but also controls weeds by turning them into soil. Subsequent weedings should be done at intervals of about 2 weeks, until the canopy closes.

Step 7

SRI recommends use of FYM or compost made from decomposed biomass (straw, etc.). Their application not only improves soil structure but also enhances the number and diversity of useful soil organisms in the field. This method for improving soil fertility supports organic farming, combats deteriorating soil health, deals with environmental quality concerns, and counters the increasing cost of cultivation.

Larger root systems, bigger and healthier and plants, profused tillering from a single seedling, and finally a bumper harvest for the SRI farmers. Apart from these benefits, other positive aspects of SRI are: higher milling outturn (by about 15%), better grain quality, greater pest and disease resistance, more tolerance for lodging and drought, and reduced grain maturity time by 1-2 weeks. SRI techniques, although the name implies that they work for rice only, are being adapted in India to improve other crops such as wheat, finger millet, sugarcane and mustard.

There is nothing magical about SRI; nonetheless, it produces "More Output with Less Inputs." Hence, it is a resource-conserving technique of rice production that is good for farmers, consumers, and the environment.

Source: *How to Produce More Rice with Less Input. A Field Extension Manual.* Karma Lhendup, Faculty of Agriculture, College of Natural Resources.

Circle Nurseries

Description. Circle nurseries conserve water and make use of trees growing in your nursery. For fruit trees which have just been grafted and should not get wet, this is an ideal way of root watering. This method is also useful for non-grafted nurseries, and is suitable for all climates.

Method

1. Identify a tree already growing in the nursery. Mark out a circle about 1ft. (30cm) away from the stem and a second circle from 2-4ft. (60-120cm) radius around the stem of the tree.
2. Dig a shallow trench about 4-6 in (10-15cm) deep between the lines. The width of the trench should be adapted to hold the optimum number of pots. Take care not to disturb the roots of the tree. The trench should have vertical sides and the floor should be as level as possible. Place water in the trench to check if the floor is level. If some areas are visible and some are under water, level accordingly.
3. Line the base and sides of the trench with plastic or leaves. This prevents roots from growing out of the pots and protects the sides of the trench from being eroded. Old poly pots are ideal as they allow water to percolate and feed the central tree.

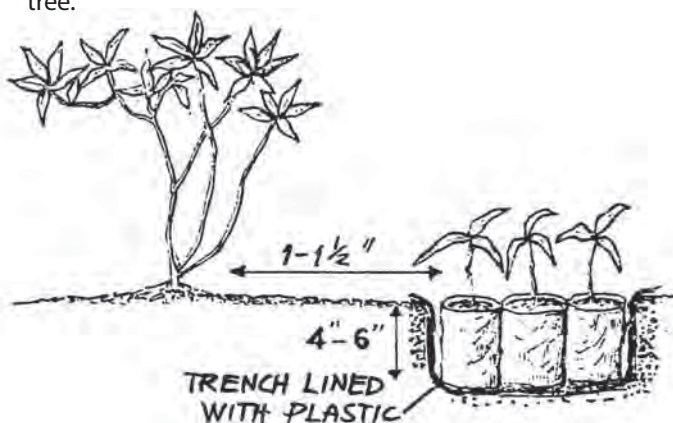

4. Place seedlings in polypots or clay pots in the trench.

To water, place a flat rock on the side of the trench and pour water onto this so that the base of the trench is filled. Water the seedlings as required.



Benefits:

1. The soil in the pots will soak up the water from below, which is better for root development.
2. The central tree will receive the excess water (and leached nutrients) from the potting mix.
3. The central tree will provide shade and hail protection to the nursery plants around it and birds perching in the tree will provide insect control and manure to the seedlings.
4. The stems of the seedlings can remain dry (this is important if they are grafted).
5. Good to put seedlings in trench in order to keep roots cool and minimize water loss. The trench helps keep seedling roots cool and minimizes water loss.

Source: *Regenerative Agriculture Technologies (RAT) Kit*. IIRR UNICEF for Philippine Department of Agriculture. 1989.

Improving Vegetative Cover on Dryland Farms

It is generally perceived that rainfall patterns alone determine the success or failure of crops. What happens to the received rain water is as important as the quantum of rainfall itself. Equally important is the pattern of utilization and influence of other natural resources and life forms such as sunshine, soil, soil microbes, type of crops, local vegetation, livestock, birds, etc.

Benefits of Vegetative Cover

Vegetative cover in the form of trees, shrubs, creepers, grasses, etc, helps intercept raindrops and retain maximum water in their canopy. Excess rainwater slowly runs down the leaves, branches and the main trunk, avoiding splash erosion and resulting in increased percolation. Vegetation also deflects wind, thereby reducing wind erosion and moisture loss. A grass cover will reduce the velocity of water flow over the ground and allow for increased percolation.

What happens to rainwater

In a typical dryland area, rainfall is the primary source of water. Without adequate vegetation a substantial proportion of this rainwater will be lost as runoff. Estimates of this wastage range from 40% to 90% depending on soil type, land slope and existing vegetation. The proportion of rain water retained in situ increases with increased vegetative cover. Promotion of vegetative cover in the form of trees, shrubs, creepers, grasses etc., is essential in improving the utilization and quality of natural dryland systems.

A vegetative cover also provides home for a variety of insects and birds. This helps increase the biodiversity and reduce the presence of pests and diseases. Droppings and decomposition of flora and fauna add nutrients and organic matter to the soil which change the structure of soil particles. These activities enhance the water holding capacity of soils which improves the survival prospects of crops during dry spells.

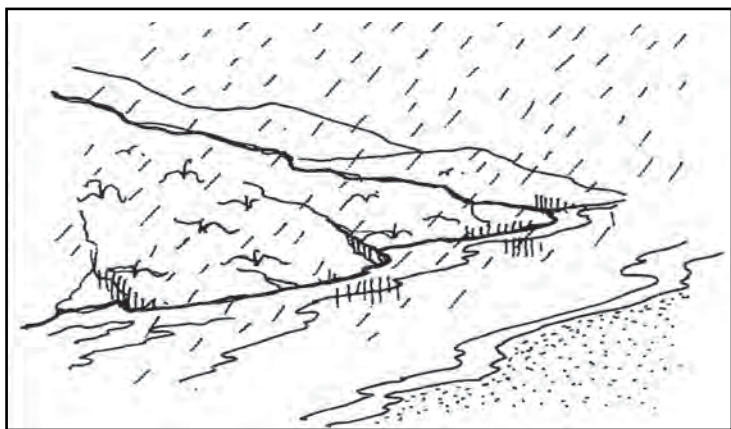

Low vegetative cover - high run-off



High vegetative cover - low run-off

In addition to enhancing the quality of natural systems, high vegetative cover also provides economic security for farmers. Trees and other plants are seen as means gain wealth for poor farmers as they provide food, fuel, fodder and building materials. They are liquid assets which can be sold in cases of crop failure as they are much less vulnerable to the vagaries of weather and markets. Increasing vegetation, therefore, provides income and reduces farmers' dependence on money lenders and unsustainable accumulation of debt.

How to Increase Vegetative Cover in Cultivated Land

Farmers' fields are normally divided into several sub-plots using bunds. A hectare of land can have 800 to 1200m of bunds including the boundaries. All these bunds can be covered with perennial fodders like *Stylo hamara* and other local grasses which will help to stabilize the bunds.

Trees with long rotation period can be planted on the boundary bunds with a planting distance of 2m. Internal bunds can be planted with trees of short rotation period and those which can produce maximum leaf biomass. The number of each species depends on the purpose of plantation, the cropping system being followed, soil characteristics and level of precipitation.

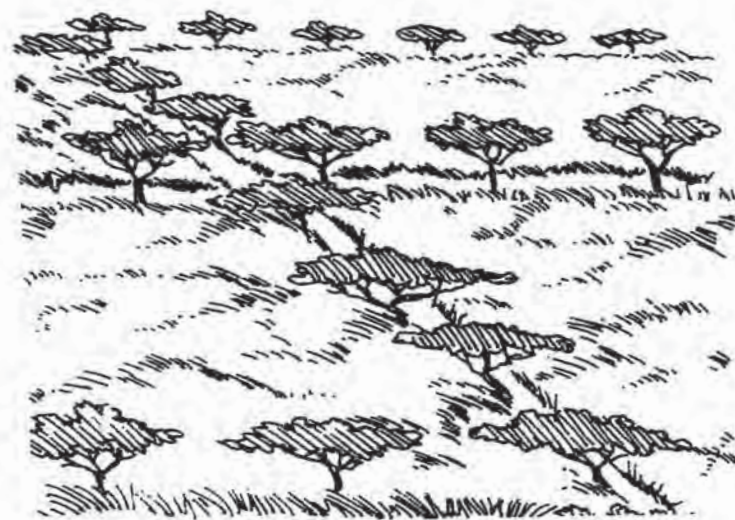

Trees for boundary bunds

Trees that can be considered for boundary bunds are:

- *Eucalyptus spp.* (Niligiri)
- *Tectonagranas*(Teak)
- *Thespestia populnea*(Huvarsi); *Albezia lebbek*(Bage)
- *Leucaena leucocephala*(Subabul)
- *Annona squamosa*(Seeta phal)

Trees for internal bunds

Tree that can be promoted on the internal bunds are:

- *Glyricidia sepium*
- *Leucaena leucocephala*
- *Cassia siamea*(Seme thangadi)
- *Sesbania sesban*(Chogache)
- *Erythrina indica*(Halvana)
- *Moringa petrikosperma*(Nugge)
- *Pongamia pinnata*(Honge)

Horticultural species to be planted in the field

In addition to planting vegetation on the bunds, horticultural species should be planted in the field itself. Some of the horticultural species that can be considered are:

- Mango, 30 to 50 plants per hectare
- Tamarind (grafted), 10 to 20 per hectare
- Papaya, 20 per hectare
- Pomegranate, 10 to 15 per hectare
- Curry leaves
- Emblica

Steps Involved in Establishing Tree Cover in Drylands

A systematic and planned approach should be adopted in establishing effective tree cover in drylands. Farmers should make a provision of three to five years to achieve the desired vegetative cover. Actions to be taken from year to year are detailed below.

Year 1

In the first year, the following activities should be done in the field where vegetative cover will be established.

Livehedge Fencing

Establishing protection from stray cattle is absolutely essential. Normally it takes about one year to establish a fence. Some species such as cactus, *Euphorbia* species, *Lantana*, *Agave* and others can be used for this purpose. The live hedge

should also be reinforced with thorny bushes for added protection. Non-browsable plants are preferable for a livehedge fence.

Bunding

Creation of internal bunds in the cultivated plots is advisable.

Cultivated plots should be divided into smaller plots by erecting bunds. These will help soil and water conservation promote better tree growth. The optimal interbund distance should be kept around 20 to 30m, depending on the slope of the land.

Excavating a Farm Pond

Excavating a small farm pond measuring 10 x 10 x 3m in a hectare of land will facilitate the collection of run-off rainwater and will help improve the microclimate.

Note:

It is essential to water the plants immediately after planting. Water the plants diligently on the first two years after planting to improve chances of survival.

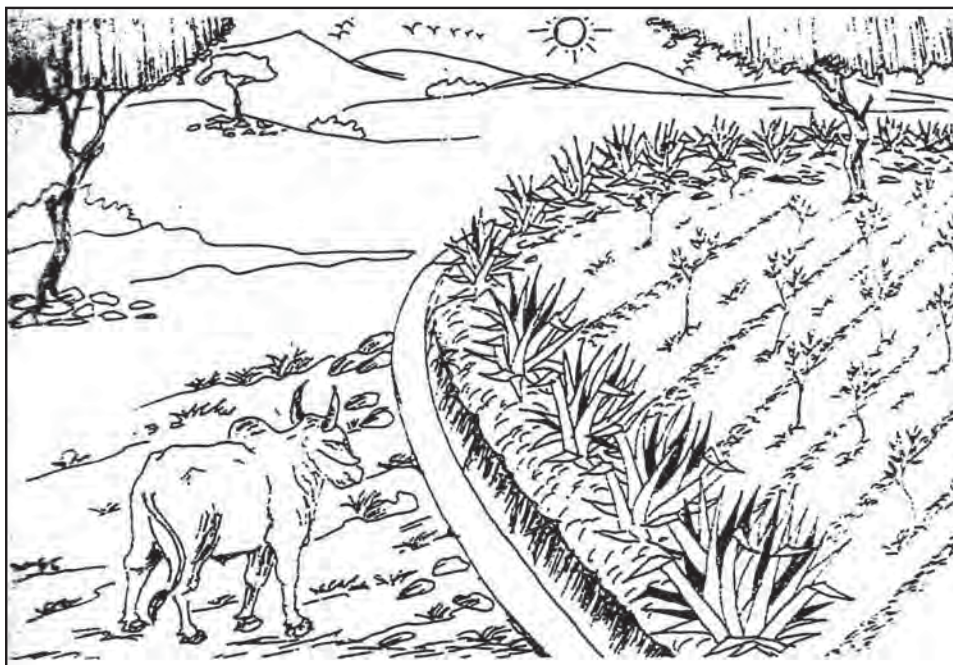

Tree management practices for an agroforestry plot

- Prune trees on internal bunds to a height of about 5ft to avoid shading of crops.
- Trees on the boundary should be allowed to grow straight by pruning the side branches only.
- Reintroduce all leaf biomass into the soil. This increases soil organic content and promotes soil humus content and growth of soil microflora and fauna.
- Maintain a trench of half a foot at a distance of half a meter from the trees to cut surface roots and keep them from spreading into the field.

Nursery

A good nursery of desired forest trees should be planned and established in the first year. Pelleting of seeds using cowdung and dry sowing of pelleted seed helps establish forestry trees at a comparatively lower cost.

Pitting

Pitting should be completed and allowed to wither before the onset of rains. The pits should be filled with organic manure, neemcake, rockphosphate and covered with top soil.

Pit Size Required for Various Tree Species

Tree species	length	Dimension (ft) width	depth
Mango	3	3	3
Tamarind	3	3	3
Other fruit species	2	2	2
Other forestry species	1	1	1

The judicious and sustainable utilization of natural resources adds to our quality of life

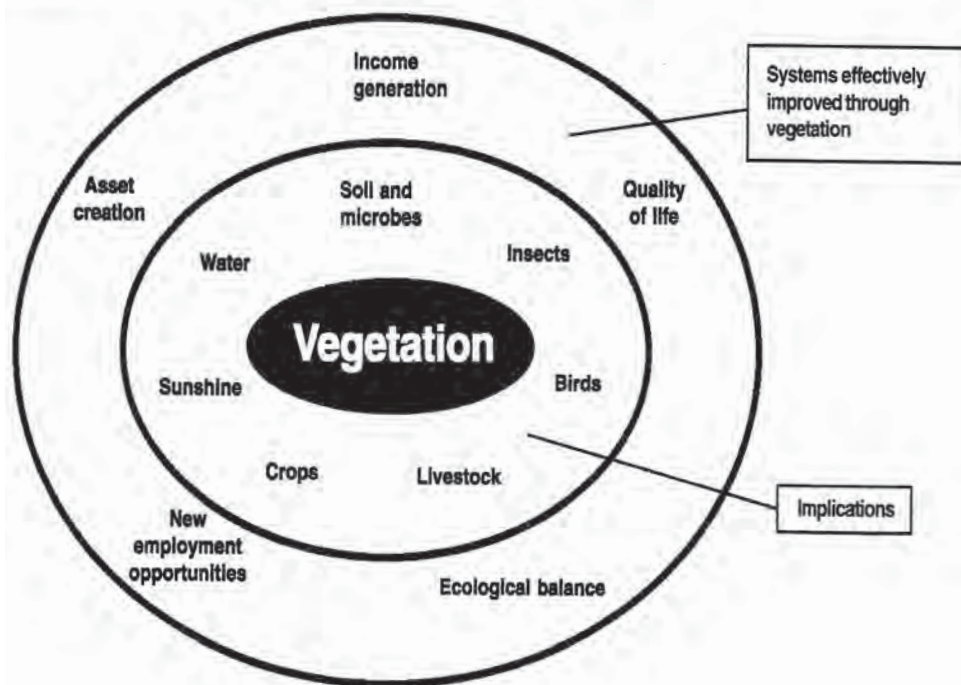

Year 2

Planting should commence with the onset of rains. Weeding, watering and basin preparation should be done at regular intervals if the rain fails.

Year 3

Gap filling, weeding, watering and basin preparation should continue. Replace weak plants with healthy seedlings. Organic manure should be applied for horticultural plants.

Years 4 and 5

Weeding, watering and basin preparation should be continued. Depending on the survival rates, thin out closely-placed plant. Pruning of the side branches of forestry species planted on the boundary should also be done.

Source: MYRADA and IIRR. 1997. *Resource Management in Rainfed Drylands*. MYRADA, Bangalore, India and International Institute of Rural Reconstruction, Silang, Cavite, Philippines

Protective Measures for Non-arable Lands

Soil degradation results in an appreciable loss of productivity and lowers the current and/or potential capacity of soil to produce goods or services. The major degradation problems in the South Asian region are erosion by water and wind, loss of fertility, chemical degradation and water logging.

Factors of Degradation

- Deforestation of lands for fuelwood and fodder—leads to increased erosion.
- Uncontrolled grazing—increases erosion by exposing the top soil.
- Hazardous mining practices—increases erosion in hilly areas causing degradation of vegetation in arable lands. This leads to siltation of tanks and reservoirs.
- Surface runoff along the slope—concentrates and increases in volume and velocity, causing erosion in the arable lands situated downstream.

This paper focuses on control of degradation occurring through surface runoff.

Protective Soil and Water Conservation Measures

Catch Pits/Dug-outs

These are large dug-out pits situated at rill points and water-ways to trap runoff. It is adoptable in rocky areas. Pits are planted with suitable trees. This is both a mechanical and vegetative measure.

Pits with Crescent

These are crescent-shaped bunds formed across the slope with a vegetative pit inside. The bunds control runoff and soil erosion and facilitate the development of vegetative cover. This is a mechanical measure.

On an average, India loses 5,333 million tonne of soil annually, equivalent to 16.5 tonne/hectare.

In non-arable lands, water is held in suitable trenches, pits or different suitable land configurations, to improve the establishment and growth of grass, trees, fruit plants, etc. Mechanical or vegetative measures are used to restore degradation. However, protective enclosures themselves can promote the regeneration of non-arable lands.

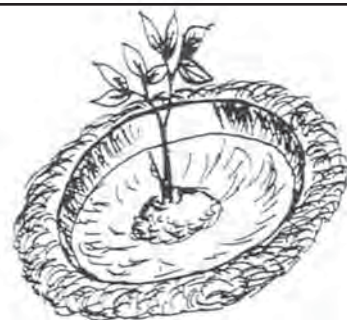

Contour Trenches/V Ditches

These are trapezoidal/v-shaped dug-out trenches made along contours to hold rainwater for conservation. The trenches have a width of 0.6 to 1 m at the top and 0.4 m at the bottom. They are 0.4 m deep. They can either be staggered or continuous at 5 to 10 m horizontal intervals. Trenches are planted with suitable trees. This is a mechanical as well as a vegetative measure.

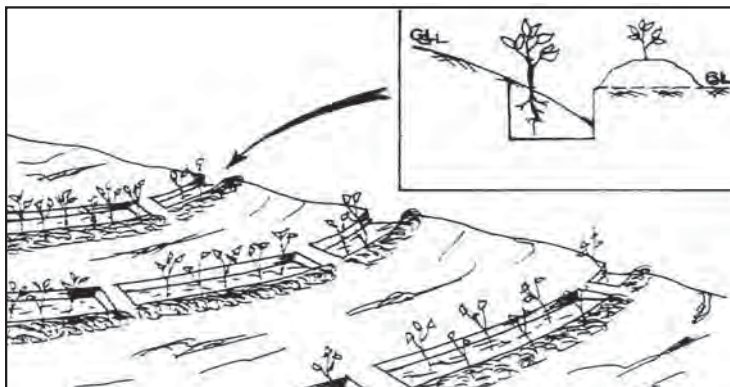

Diversion Drains

This is an individually-designed channel placed across the slope to intercept and divert surface runoff and to save arable lands from being damaged due to overflow from non-arable lands. The channel is trapezoidal in shape and grown with suitable vegetative species. These are adoptable in all areas irrespective of soil and climatic conditions. This is a mechanical measure.

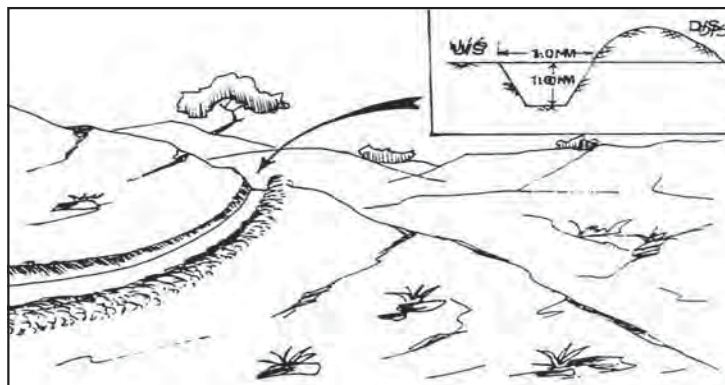

Gradonis

These are benches of small width formed on contours by disturbing soil in areas having mild to steep slopes. These are planted with bushy vegetation or trees. This is a mechanical measure.

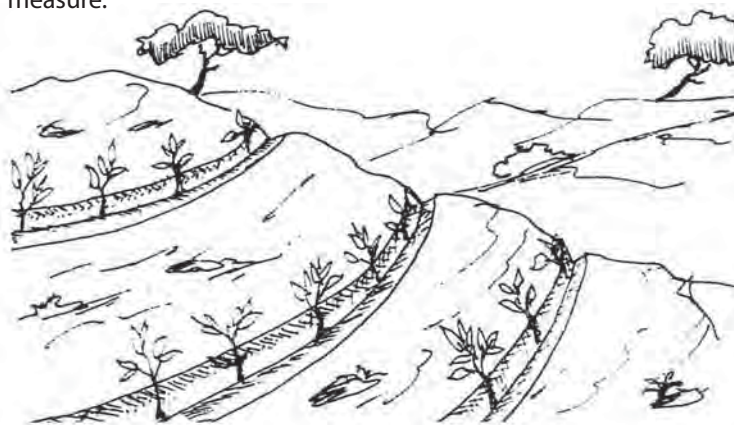

Source: MYRADA and IIRR, 1997. *Resource Management in the Rainfed Drylands*. MYRADA, Bangalore, India and International Institute of Rural Reconstruction, Silang, Cavite, Philippines.

Gabion Structures

These are dams made of wire-woven baskets filled with stones constructed across non-arable lands to control silt erosion in steep slopes. This is a mechanical measure.

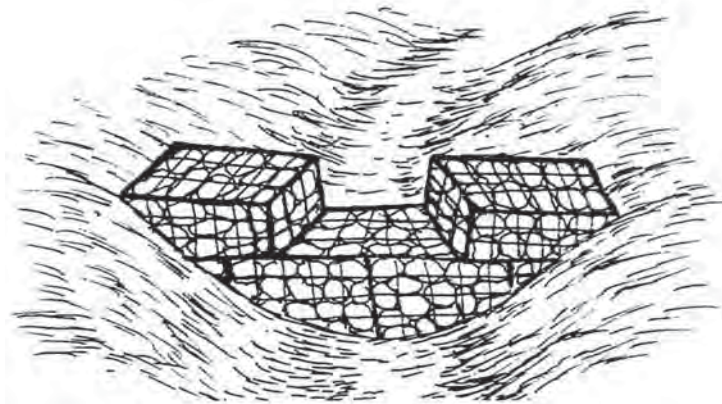

Note: Run-off from non-arable lands cannot be reduced to zero despite appropriate measures.

Legume Crop Rotation with Rice

Introduction:

In rainfed lowland areas which are traditionally planted to only one crop of rice per year, land use can be optimized by using the pre- and/or post-rice wet period to grow legume crops. Legumes are suitable rotational crops with rice because they:

- Can mature in 65-90 days.
- Can be grown as pre-rice crop when rainfall accumulation reaches 100 mm/mo or as post-rice crop using the receding rain and residual soil moisture.
- Are acceptable crops because they are easy to prepare for consumption or to sell at the market.
- Are drought-tolerant.
- Are capable of using atmospheric nitrogen and contribute nitrogen to the soil.

Importance:

1. Intensifies land use and increases crop production per area per year.
2. Provides an additional source of food and income to farmers. Legumes can also provide biomass for green manure and fodder.
3. Sustains soil productivity through nitrogen cycling with legumes.
4. Weed production is reduced by planting an otherwise fallow area.

Designing the Crop Rotation Pattern:

(Refer to the figure on theoretical rainfall occurrence and proposed legume-rice sequences)

1. Based on knowledge from past years or from rainfall data, determine the onset and the end of the rainy season.
2. Choose short-maturing varieties of both rice and legume crop to accommodate a three-crop sequence or to avoid water stress.
3. Estimate the planting and harvesting dates of each crop in the cropping sequence.
4. If, based on the rainfall occurrence and drainage system, only a two-crop sequence is possible, there is a flexibility to choose a longer duration crop variety which has other desired characteristics.

Theoretical rainfall occurrence and the proposed legume-rice sequence

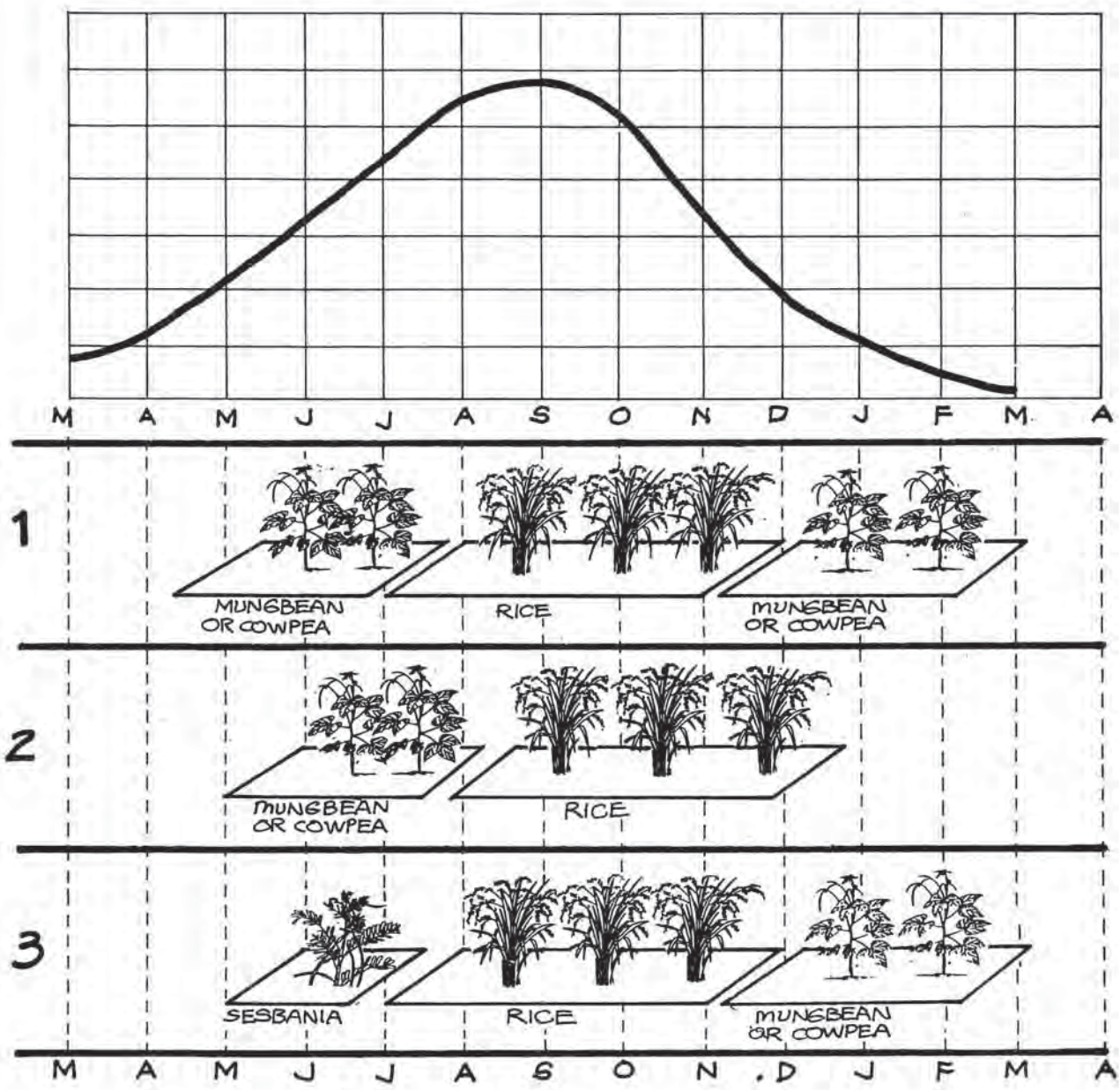

Source: Regenerative Agriculture Technologies (RAT) Kit. IIRR Unicef for Philippine Department of Agriculture. 1989

Liquid Fertilizer

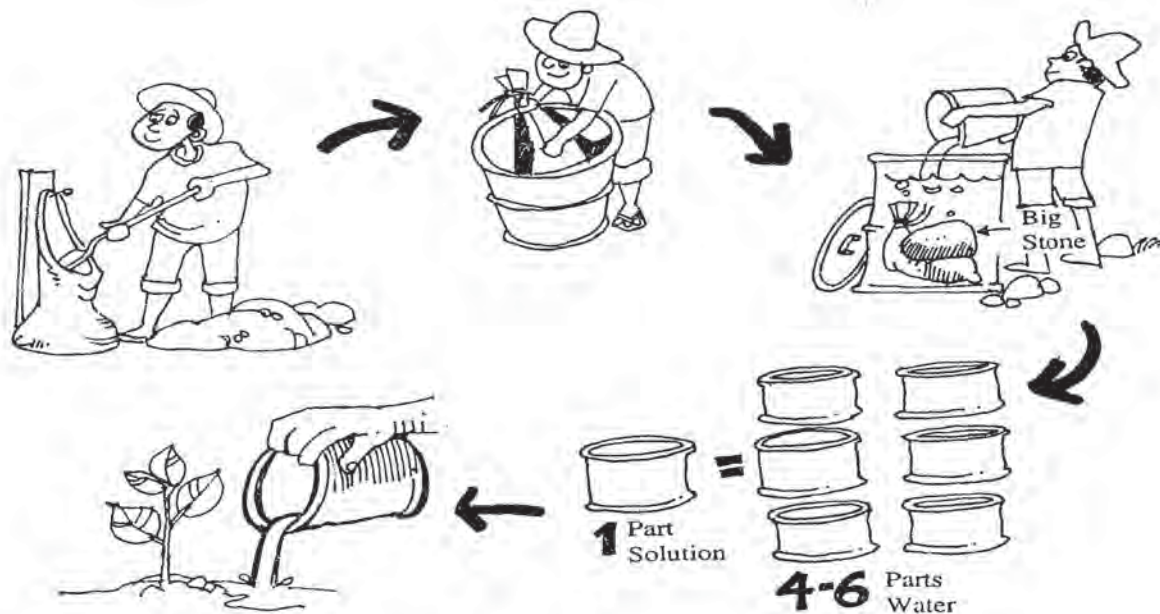

Liquid fertilizer is made by immersing a sackload of fresh animal manure in a drum of water and allowing it to ferment. When used to water the plants, the “tea” makes possible the easy nutrient extraction by the plants. Depending on the availability of materials, animal manure can be substituted with fresh leaves of nitrogen-fixing trees like *Leucaena* (ipil-ipil) and/or *Gliricidia* (kakawate) or with green grass clippings and/or fresh weeds.

Preparation

1. Fill the burlap bag 3/4 full of wet manure or fresh leaves or compost.
2. Tie the open end then place the bag into the empty drum (regular size, 55 gallon capacity).
3. Place a big stone to hold the bag down.
4. Fill the drum with water. Cover.
5. After 3 weeks, remove the bag from the drum.
6. Dilute solution at a ratio of 1 part liquid fertilizer to 4-6 parts fresh water.
7. Apply the liquid fertilizer around the base of the plant (avoid any direct contact with the plant) 2-3 weeks after germination or immediately after transplanting. Repeat after 3-4 weeks.
8. Start over again with fresh materials following steps 1-6.
9. Smaller quantities of liquid fertilizer can be produced in smaller containers (if a 55-gallon drum is not available), using the same ratios.

Source: *Regenerative Agriculture Technologies (RAT) Kit*. IIRR Unicef for Philippine Department of Agriculture. 1989

Vegetables With Multiple Edible Parts

Scientific Name	Common Name	Edible Parts
<i>Cucurbita maxima</i>	squash	fruit, seeds flower, shoots
<i>Psophocarpus tetragonolobus</i>	winged bean	Pods, shoots, flowers
<i>Moringa oleifera</i>	horseradish	Pods, flowers, leaves
<i>Colocasia esculenta</i>	taro	corm, leaves, petiole
<i>Hibiscus sabdariffa</i>	red serrel	fruits, leaves, petiole
<i>Sesbania grandiflora</i>	sesbania	fruits, flowers, leaves
<i>Ipomoea batatas</i>	sweet potato	tubers, leaves, petiole
<i>Vigna sesquipedalis</i>	string bean	pod, shoots
<i>Sechiurn edule</i>	chayote	fruits, shoots
<i>Raphanus sativus</i>	radish	roots, leaves
<i>Momordica charantia</i>	bitter gourd	fruits, shoots
<i>Capsicum anuum</i>	green pepper	fruits, leaves
<i>Allium cepa</i>	onion	bulbs, leaves
<i>Allium sativum</i>	garlic	cloves, leaves
<i>Vigna sinensis</i>	cowpea	Pods, shoots
<i>Dolichos lablab</i>	lablab bean	Pods, shoots
<i>Pachyrrhizus erosus</i>	yam bean	tubers, young pods
<i>Apium graveolens</i>	celery	leaves, stems

Scientific Name	Common Name	Edible Parts
<i>Brassica oleracea var. acephala</i>	kale	leaves, stems
<i>Petroselinum crispum</i>	parsley	leaves, stems
<i>Ipomoea aquatica</i>	swamp cabbage	leaves, petiole
<i>Citrullus vulgaris</i>	water melon	fruits, seeds
<i>Abelmoschus esculentus</i>	ladyfinger	fruits, seeds
<i>Brassica chinensis</i>	pechay	leaves, flowers
<i>Brassica juncea</i>	mustard	leaves, flowers
<i>Amaranthus gracilis</i>	amaranth	leaves, seeds

Vegetables Containing Iodine

Scientific Name	Common Name	Parts Per Billion Iodine per 100 g edible portion
<i>Sargassum siliquosum (dried)</i>	aragan	3,900,000
<i>Gracilaria compressa (dried)</i>	ceylon moss	500,000
<i>Gracilaria verrucosa (dried)</i>	gulamang dagat	3,800 - 360,160
<i>Laurencia seticulosa (dried)</i>	kulot	79,344
<i>Caulerpa racemosa</i>	lato	24,600
<i>Codium tenue</i>	pokpoklo	2,139
<i>Hydroclathrus clathratus</i>	balbalulang	1,845
<i>Colocasia esculenta (leaves and stem)</i>	taro	485
<i>Daucus carota</i>	carrot	81
<i>Apium graveolens</i>	celery	81
<i>Phaseolus vulgaris</i>	snap bean	80
<i>Cajanus cajan</i>	pigeon pea	80
<i>Sesbania grandiflora</i>	katuray	80
<i>Phaseolus aureus</i>	mungbean	80
<i>Phaseolus lunatus</i>	lima bean	80
<i>Psophocarpus tetragonolobus</i>	winged bean	80
<i>Vigna sesquipedalis</i>	string bean	80

Scientific Name	Common Name	Parts Per Billion Iodine per 100 g edible portion
<i>Pachyrrhizus erosus</i>	yam bean	80
<i>Phaseolus calcaratus</i>	rice bean	80
<i>Raphanus sativus</i>	radish	71
<i>Brassica chine nsis</i>	pechay	70
<i>Momordica charantia</i>	bitter gourd	65
<i>Cucurbita maxima</i>	squash	65
<i>Cucumis sativus</i>	cucumber	65
<i>Sechium edule</i>	chayote	65
<i>Lagenaria siceraria</i>	bottle gourd	65
<i>Brassica oleracea</i>	cabbage	60
<i>Nasturtium officinale</i>	watercress	50
<i>Lycopersicon lycopersicum</i>	tomato	47
<i>Solanum tuberosum</i>	Irish potato	47
<i>Capsicum anuum</i>	green pepper	47
<i>Solanum melongena</i>	eggplant	47
<i>Brassica juncea</i>	mustard	27

Iron Content of Some Local Foods in Serving Portions Compared with Recommended Dietary Allowances (RDA) for Various Age Groups

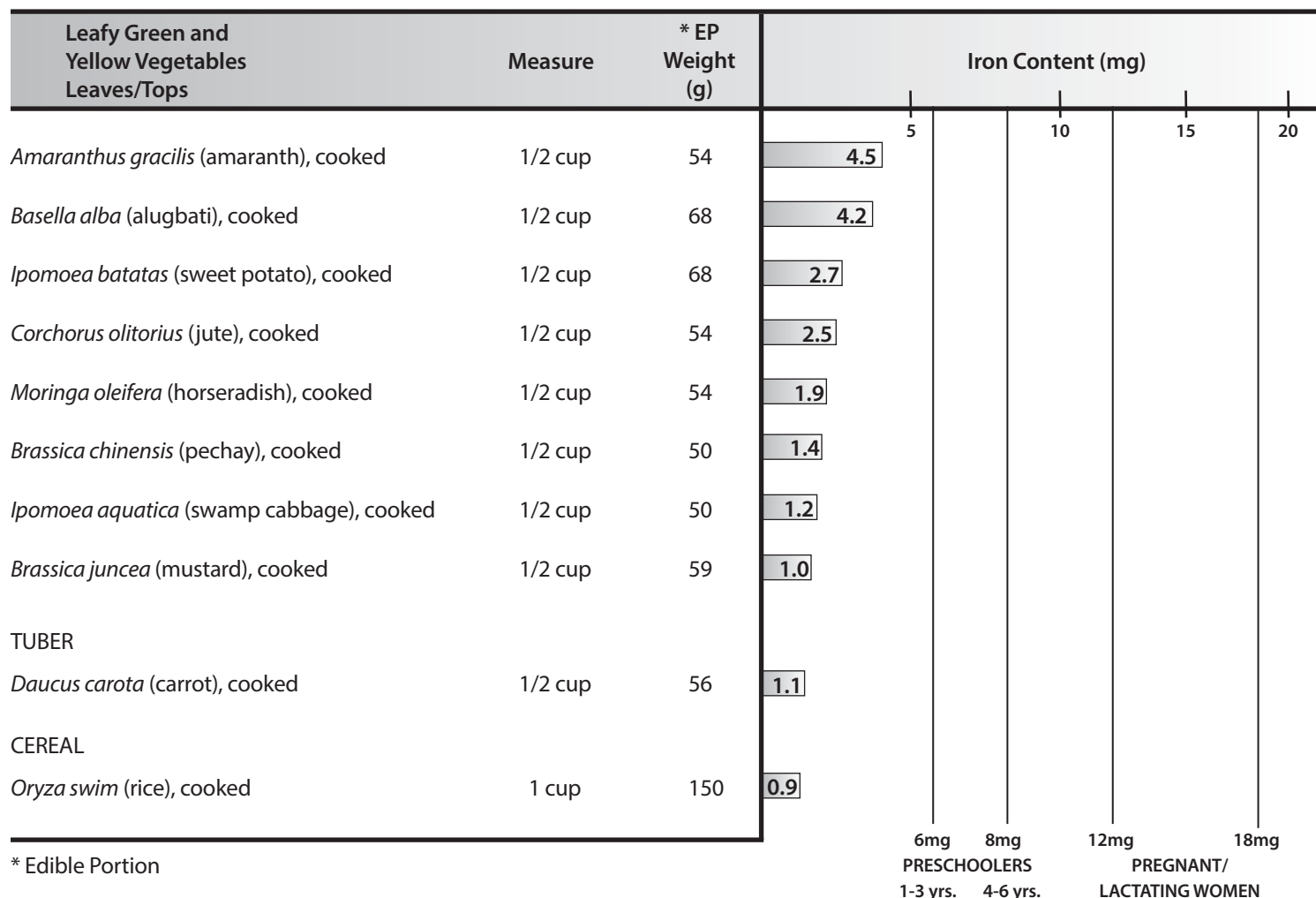

* Edible Portion

Source: IIRR and FNRI

Planning for Aberrant Weather Conditions: Production and Management Strategies

Rainfall is the main and the most variable source of water for dryland crops. Its variability (between and within a year) plays a dominant role in influencing crop growth and yield. The cropping pattern in a region is usually planned on the basis of prevailing rainfall behavior. Any significant deviation in such a behavior is termed “aberrant”. The most important aberrant weather situations in dryland regions are: low seasonal rainfall; and maldistribution of seasonal rainfall. These call for management practices to mitigate its effects. Invariably, these practices include the selection of drought-tolerant crops/varieties, combined with a choice of technologies for moisture conservation.

Production and Management Strategies for Low Rainfall Tracts

When a low rainfall season is forecasted, the contingency measures described below are helpful in conserving the meager soil moisture.

Tillage

- Till black soil deep (up to 25-30 cm) immediately after harvest of the previous season’s crop to increase the effective soil depth and control perennial weeds.
- Undertake shallow tillage (up to 10 cm depth) in red soils immediately after harvest of the previous season’s crop to improve infiltration.

Graded Furrows

- Open furrows with a grade of 0.2 to 0.4% and maintain them by deepening once or twice

Important climatological inputs in crop planning

- Seasonal rainfall totals
- Probable period of assured rainfall distribution
- Long-range forecast
- Medium-range forecast

.....

The India Meteorological Department (IMD) has successfully forecast the monsoon seasonal rainfall over India with an accuracy of more than 90% during the last decade.

Contour Cultivation

- Conduct all field activities like ploughing, tilling, seeding, etc. along the contour or across the slope. This increases the yield e.g., in *Setaria* by 35% and in sorghum by 22%.

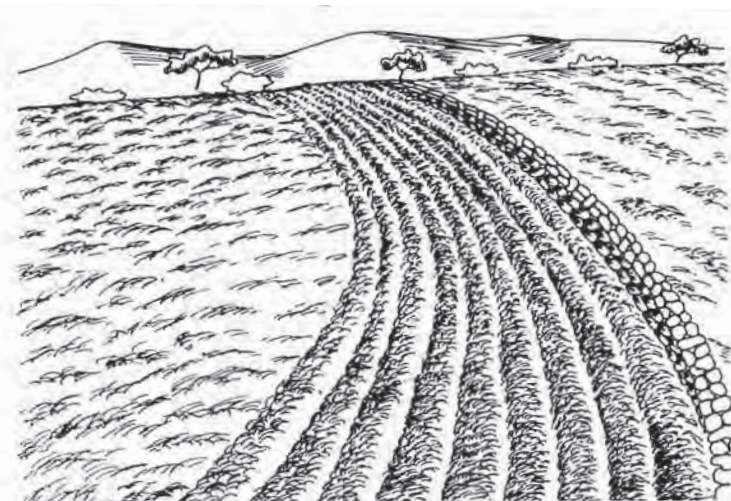

Contour cultivation

Compartmental Bunding

- Keep the lands with medium and deep black soils fallowed during the *kharif* season.
- Immediately after the rains in *kharif* complete primary tillage first, followed by two harrowings.
- Construct compartmental bunds of 4.5 x 4.5m and 3 x 3m during the second fortnight of July on lands having slopes of 2% and 3%, respectively.

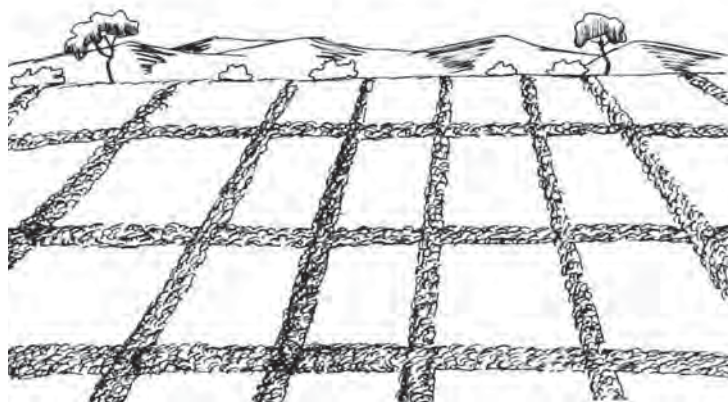

Compartmental bunding

Tied Ridges and Furrows

- Open the furrows 60 to 70cm apart across the slope in medium to deep black soils, after completion of primary tillage, during the second fortnight of July. Tie at regular intervals along their length. This technique increases sorghum yield by 50%.



Tied ridges and furrows

Broad Furrows and Ridges

- Lay out the land into broad furrows and ridges across the slope in medium to deep black soils of 2% slope to conserve rainwater effectively and increase grain yield.



Broad furrows and ridges

Scooping

- Form scoops during the second fortnight of July across the slope or along the contour to increase the infiltration rate and to reduce erosion of medium and deep black soils which have poor infiltration characteristics. It is important to revive the scoops after each rain to facilitate better infiltration.

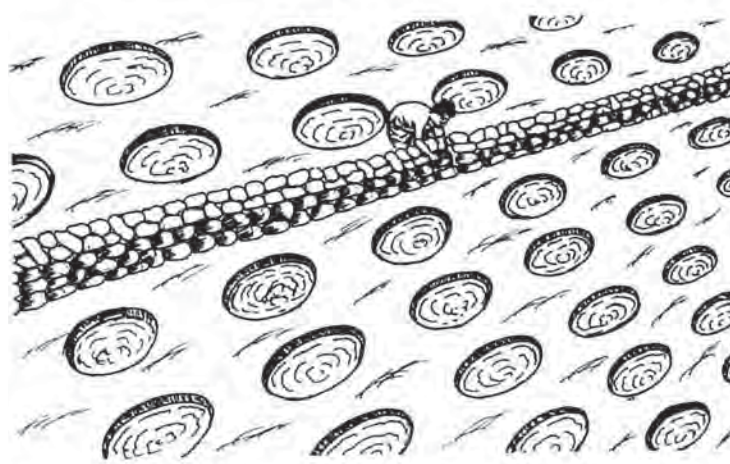

Scooping

Mulching

- **Vertical mulching:** The procedure involves opening trenches of 30cm depth and 15cm width across the slope at vertical intervals of 30cm, and stuffing *jowar* stubbles vertically in these trenches so that they protrude 10cm above ground. These vertical mulches of *jowar* act as intake points and guide runoff water to subsoil layers. Adoption of this technique in medium to deep stiff and clayey soils increases the grain yield of *jowar* by 26 to 54%.

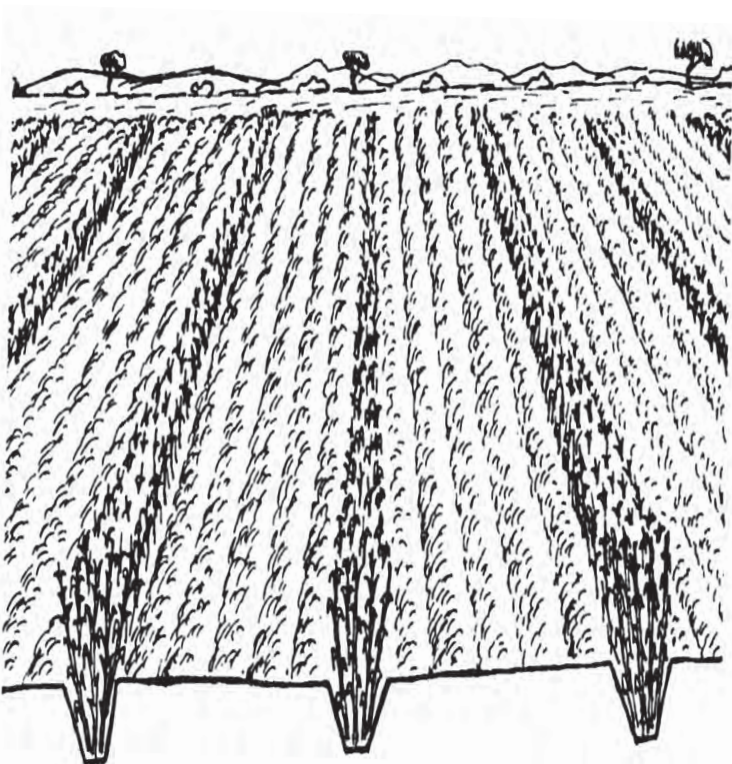

- **Surface mulching:** Open ridges and furrows, 120cm apart, 45 days prior to planting.
- Perform sowing in two lines in a furrow and break the ridges during the first interculturing, thereby creating adequate dust mulch.
- Alternatively, apply crop residues between the crop rows to reduce (soil) evaporation and improve water intake.

Wider Row Spacing, Optimum Plant Population and Seed Rate

Row spacing

<i>Rabi</i> sorghum, safflower, sunflower	60cm
Spreading groundnut and cotton	60cm
Redgram	90cm

Seed rate and plant population (per hectare)

<i>Rabi</i> sorghum (7.5kg/ha)	90,000
Safflower (7kg/ha)	56,000
Redgram (15kg/ha) and cotton (5kg/ha)	56,000
Sunflower (5kg/ha)	65,000

Figures in parentheses indicate the seed rate.

Border Planting Method

- The procedure involves skipping one row after every two rows of sowing of safflower/sunflower/redgram or three rows of bengal gram/groundnut. A furrow should be opened along the skipped row and tied after germination has taken place.

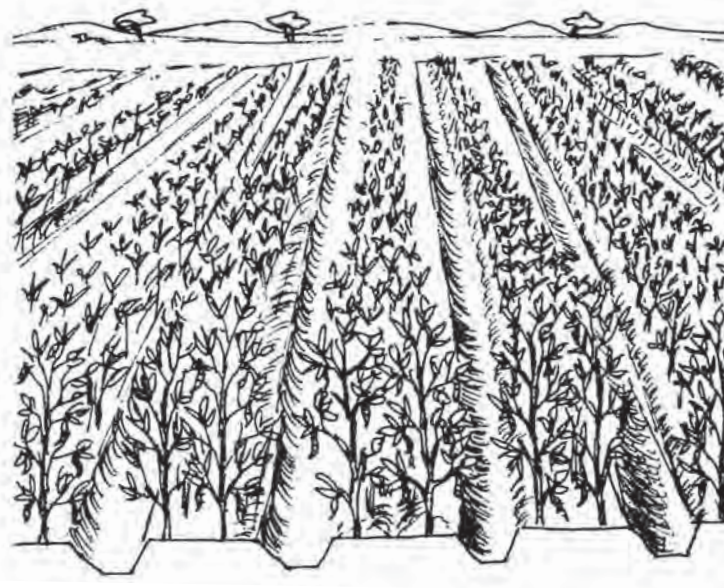

Seed hardening

Seed hardening refers to the technique of subjecting seeds to 2-3 cycles of soaking with appropriate chemical solutions and drying. This results in remobilisation of nutrients in the embryo and thickening of protoplasm within the body of the seedling, after germination, to impart drought tolerance.

Dry seeding

Dry seeding is the technique of placing the hardened seeds in a dry soil. The seeds are placed at a depth of 5 to 7.5 cm so they germinate at the onset of monsoon and not with the pre-monsoon drizzles. In the cases of red gram and castor, the seeds are placed in the centre of the furrow and covered with finely-powdered farmyard manure. In the cases of sorghum, pearl millet, bengal gram, sunflower, safflower, etc., the seeds are placed in the soil using a seed drill. Dry seeding is practiced when delayed rain is forecasted.

Frequent Deep Intercultivation

- Frequent deep intercultivation operations break the soil, help in closing the cracks, create dust mulch and control weeds.

Seed Hardening and Dry Seeding

- Treat rabi sorghum, bengal gram and safflower seeds with 0.2% calcium chloride for eight hours and subsequently shade-dry till it attains less than 10% moisture content for seed hardening. Practice dry seeding.

Management Practices for Early Season Drought

In certain years, the monsoon is forecasted to be sluggish to begin with, but improves later. If the sowing is delayed based on the forecast, it could result in reduced crop yields. For such a situation, the management practices described below are suggested.

Sluggish Period

Land configurations

- Formation of tied ridges at an amplitude of 90cm for redgram and 60cm for pearl millet, castor and sunflower during the first week of June.
- Formation of broad furrows and ridges at an amplitude of 1.2m for sesamum, 1.8m for Setaria, sunflower + sesamum and spreading groundnut during the first week of June.

Crop Management

- Practice seed hardening and dry seeding. Redgram and pearl millet respond well to these. Dry seeding practiced alone is sufficient for castor. Even a rainfall of 5mm is sufficient for germination of these crops and also for their revival when congenial moisture conditions are attained.

Active period

Black soils

- Spread groundnut to the erect type. Sow in broad furrows and ridges in such a way that four rows are accommodated in each furrow (45cm row spacing).
- Intercrop sunflower + sesamum in such a way that 4 rows of sesamum and 2 rows of sunflower are accommodated in each furrow.
- Sow sunflower in the centre of tied ridges opened at an amplitude of 60cm.

Red soils

Select recommended crops and varieties for the red soil zones.

Transplanting

- Raise community nurseries of ragi at locations where water is available during July (for long duration varieties) and August (for short duration varieties) and transplant during August (long duration varieties) and September (short duration varieties).

Resowing

- If a dry spell is forecasted after sowing operations, with the inherent possibility of poor germination, plan for resowing of crop rather than maintaining the poorly established plant stand so that higher yields are obtained.

Management of Biotic Stress

In addition to the abiotic stress caused by deficient rainfall or dry spells at unanticipated stages, aberrant weather conditions may also cause biotic stress in the form of multiplication of insect pests or development of crop diseases, which should be combated with a combination of chemical, biological and cultural measures.

Ratooning

Ratooning is a technique of rejuvenating stumps after harvesting the main crop, either for green fodder or for grain purposes

Additional management practices for mid-season droughts

Mid-season droughts are the results of breaks in the south-west monsoon. If a prolonged dry spell is forecasted or experienced during the vegetative phase of crop growth, before the reproductive stage of, say, pearl millet, undertake ratooning of the crop. In the case of kharif sorghum, ratooning may be deferred until its reproductive phase. Sometimes, it is necessary to invigorate the drought-affected plants during their revival. For this purpose, top dressing (for rag4 and foliar spray of urea at 2% (for castor and pigeonpea) are suggested.

Mid-season drought situations are critical for rabi sorghum if it coincides with the flower primordia initiation [45-50 days after sowing (DAS)] or flag leaf (65-70 DAS) stages. In such events, reduce the leaf area index by removing every alternate or third row of crop at flower primordia initiation stage, and four basal leaves at flag leaf stage. Close the soil cracks by repeated deep interculturing. This further helps in retention of moisture.

Additional management practices for late season droughts

When a crop encounters moisture stress during the reproductive stage, it may lead to forced maturity. Moisture stress during grain filling stage causes considerable yield loss in both ragi and rabisorghum. The corrective measures are supplemental irrigation and use of surface mulches of straw or farm waste wherever possible. Avoid cracks by forming thin soil mulch using a blade hoe.

Source: MYRADA and IIRR. 1997. *Resource Management in Rainfed Drylands*. MYRADA, Bangalore, India and International Institute of Rural Reconstruction, Silang, Cavite, Philippines

Layout for an Intensively Cultivated Woodlot for Fuelwood or Poles and Stakes

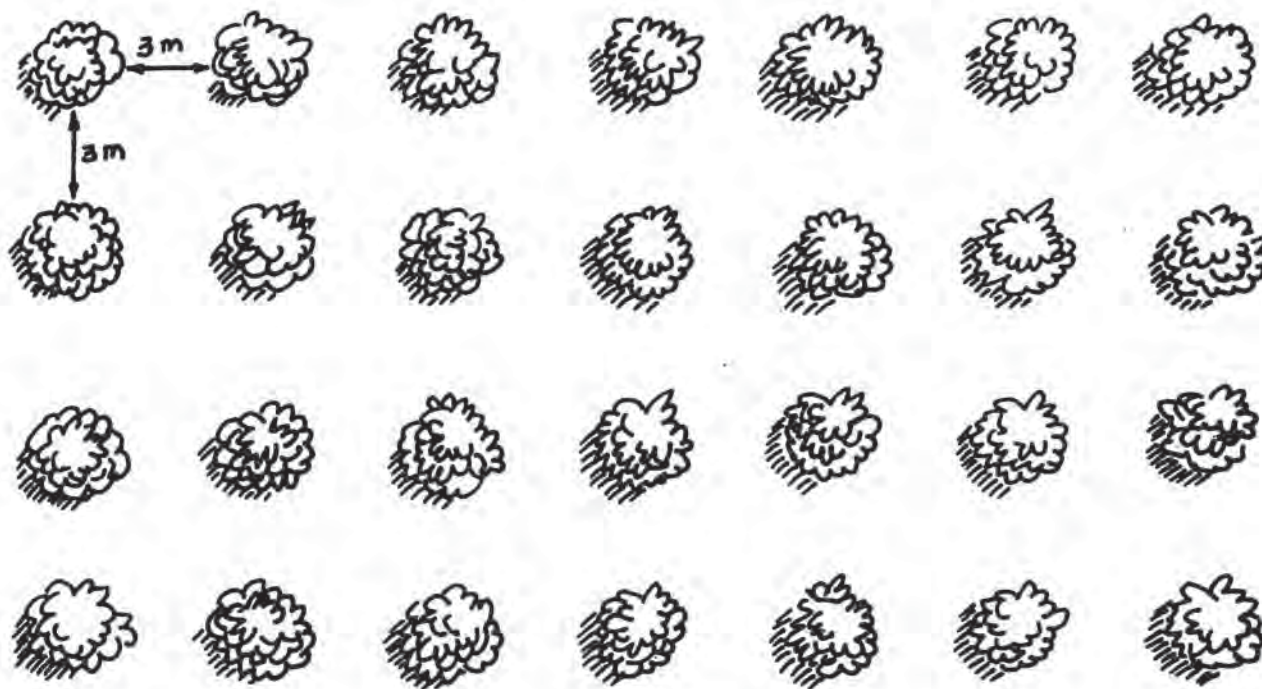

Plot size: 25m x 20m

Total number of trees: 56-333 depending on the spacing

Note:

- Fast growing species: *Casuarina equisetifolia*, *Albizzia falcataria*, *Casia siamea*, *Leucaena leucocephala*.
- Mix 2-3 species within the woodlot to reduce risks of insect infestation.
- In the first 3-6 months, weed the area around the plants to reduce shading and competition.
- Harvesting can be done at the end of the first year.
- The trees must at least be 1.5m before they are first cut.
- Do not cut the trees so short. Cutting must be done at least 0.5m above the ground level.
- Prune continuously but retain 1-2 erect shoots/tree. The prunings can be spread on the ground to serve as mulch. Some can also be fed to animals.
- Leave one row of trees at one end of seed production.
- Avoid cutting at the start of the dry season.

Source: International Institute of Rural Reconstruction (IIRR). Silang, Cavite, Philippines.

Biological Pest Control

Biological pest control is the suppression of pest populations by living organisms such as predators, parasites and pathogens. These agents are responsible for keeping pests under control most of the time. Predators are usually other insects and spiders. Both, but particularly spiders, feed on a wide range of insects. Adults and immatures are often predatory.

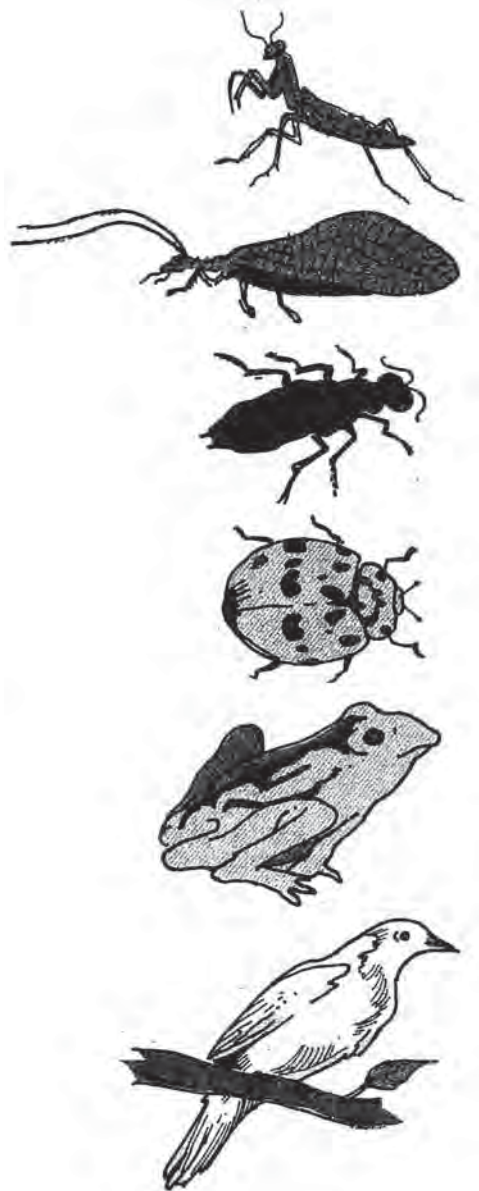

- **Praying mantis, Dragonfly, Damselfly, Assassin bugs** feed on all types of insects.
- **Lacewings, White-banded clerid, Robber flies** feed on aphids and soft-bodied insects.
- **Ground beetles, Whirligig beetles, Rave beetles, Tiger beetles, Green carabid beetles** feed on other insects.
- **Ladybird beetles** feed on scales and aphids only. They eat 40-50 insects per day. Their larva eat even more.
- **Toads, snakes and spiders** eat insects and other garden pests. Toads eat as many as 10,000 insects and other pests in three months, including cutworms, slugs, crickets, ants, caterpillars and squash bugs.
- **Birds**
Some birds are omnivorous. Some examples from the temperate zone provide a good illustration of what birds eat. A house wren feeds 500 spiders and caterpillars to her young in one afternoon; a brown thrasher consumes 6,000 insects a day; a chickadee eats 138,000 canker worm eggs in 25 days; and, a pair of flickers eats 5,000 ants as snack.

Parasitic insects are usually small flies or wasps which attack one or a few closely related pest species. They are parasitic in their larval stages but free-living as adults.

Tachinid flies, Braconid wasps

Complete their life cycle on insect pests. They usually attack the egg of the host pest or the caterpillar by laying an egg into its body. The wasp larva hatches inside the caterpillar body and feeds on it.



Trichogramma spp.

Attacks eggs of butterflies and moth. This wasp produces very few side effects on beneficial insects.



Epidinocarsis lopezi

Feeds and reproduces on mealybugs of cassava. It has the ability to establish itself in cassava fields.



Source: International Institute of Rural Reconstruction (IIRR). Silang, Cavite, Philippines.

Botanical Pest Control

Fungicidal Plants¹

Plant Name ²	Part(s) Used	Mode of Preparation and Application ³	Target Pest(s)	Diseases Controlled
<i>Allium sativum</i> (Garlic)	cloves	Chop finely, soak in 2 teaspoons of oil for one day, then mix with half a liter of soapy water and filter. Mix 1 part solution with 20 parts water, then spray.	<i>Altenaria</i> <i>Cercospora</i> <i>Colletotrichum</i> <i>Curvularia</i> <i>Diplodia</i> <i>Fusarium</i> <i>minthosporium</i> <i>Pestalotia</i>	fruit rot, early blight, purple blotch, leaf spot leaf mold, leaf spot, early blight, frog-eye leaf spot, anthracnose, fruit rot, smudge leaf spot, leaf blight fruit and stem rot damping-off, stem and root rot, early blight, wilt, curly top leaf blight leaf spot
<i>Cassia alata</i> (Acapulco)	leaves	Extract juice and spray at a rate of 1 cup juice/liter water.	<i>Altenaria</i> <i>Cercospora</i> <i>Colletotrichum</i> <i>Diplodia</i> <i>Fusarium</i> <i>minthosporium</i> <i>Pestalotia</i>	fruit rot, early blight, purple blotch, leaf spot leaf mold, leaf spot, early blight, frog-eye leaf spot, anthracnose, fruit rot, smudge fruit and stem rot damping-off, stem and root rot, early blight, wilt, curly top leaf blight leaf spot
<i>Amaranthus gracilis</i> (Amaranth)	leaves	Extract juice of 1 kg leaves, then mix juice with 3 liters of water, and spray.	<i>Altenaria</i> <i>Cercospora</i> <i>Colletotrichum</i> <i>Curvularia</i> <i>minthosporium</i> <i>Pestalotia</i>	fruit rot, early blight, purple blotch, leaf spot leaf mold, leaf spot, early blight, frog-eye leaf spot, anthracnose, fruit rot, smudge leaf spot, leaf blight leaf blight leaf spot
<i>Leucaena leucocephala</i> (Ipil-ipil)	leaves	Pound, soak in small amount of water, and use infusion as spray.	<i>Altenaria</i> <i>Cercospora</i> <i>Colletotrichum</i> <i>Curvularia</i> <i>minthosporium</i> <i>Pestalotia</i>	fruit rot, early blight, purple blotch, leaf spot leaf mold, leaf spot, early blight, frog-eye leaf spot, anthracnose, fruit rot, smudge leaf spot, leaf blight leaf blight leaf spot

Plant Name ²	Part(s) Used	Mode of Preparation and Application ³	Target Pest(s)	Diseases Controlled
<i>Allium cepa</i> (Red onion)	bulb	Chop finely, soak in two teaspoons of oil for 1 day, then mix with half a liter of soapy water and filter. Mix 1 part solution with 20 parts water, then spray.	<i>Cercospora</i> <i>Colletotrichum</i> <i>Curvularia</i> <i>Fusarium</i> <i>minthosporium</i> <i>Pestalotia</i>	leaf mold, leaf spot; early blight, frog-eye leaf spot, anthracnose, fruit rot, smudge leaf spot, leaf blight damping-off, stem and root rot, early blight; wilt, curly top leaf blight leaf spot
<i>Moringa oleifera</i> (Drumstick/ Horseradish)	leaves	Extract juice of 1 kg leaves, then mix juice with 3 liters of water, and use as spray.	<i>Altenaria</i> <i>Colletotrichum</i> <i>Diplodia</i> <i>Pestalotia</i>	fruit rot, early blight, purple blotch, leaf spot leaf spot, anthracnose, fruit rot, smudge fruit and stem rot leaf spot
<i>Impatiens balsamina</i> (Kamantigi)	leaves	Extract juice of 1 kg leaves, then mix juice with 3 liters of water, and use as spray.	<i>Altenaria</i> <i>Cercospora</i>	fruit rot, early blight, purple blotch, leaf spot leaf mold, leaf spot, early blight, frog-eye leaf blight
<i>Centella asiatica</i> (Takip-kuhol)	leaves	Extract juice of 1 kg leaves, then mix juice with 3 liters of water, and use as spray.	<i>Fusarium</i> <i>Helminthosporium</i>	damping-off, stem and root rot, early blight, wilt, curly top leaf blight
<i>Jatropha multifida</i> (Mana)	leaves	Extract juice of 1 kg leaves, then mix juice with 3 liters of water, and use as spray.	<i>Diplodia</i> <i>Fusarium</i>	fruit and stem rot damping-off, stem and root rot, early blight, wilt, curly top
<i>Gendarussa vulgaris</i> (Bunlao)	leaves	Extract juice of 1 kg leaves, then mix juice with 3 liters of water, and use as spray.	<i>Altenaria</i> <i>Colletotrichum</i>	fruit rot, early blight, purple blotch, leaf spot leaf spot, anthracnose, fruit rot
<i>Carica papaya</i> (Papaya)	leaves	Pound, soak in water, and use infusion as spray.	<i>Cercospora</i> <i>Diplodia</i>	leaf mold, leaf spot, early blight, frog-eye fruit and stem rot
<i>Mimosa pudica</i> Sensitive plant	whole plant	Pound, soak in water and use infusion as spray.	<i>Diplodia</i> <i>Pestalotia</i>	fruit and stem rot leaf spot
<i>Artemisia vulgaris</i> (Damong Maria)	leaves	Extract juice and use as spray at the rate of 2-5 tablespoons juice/liter of water.	<i>Altenaria</i>	fruit rot, early blight, purple blotch, leaf spot

Plant Name ²	Part(s) Used	Mode of Preparation and Application ³	Target Pest(s)	Diseases Controlled
<i>Zingiber officinale</i> (Ginger)	rhizome	Extract juice and use as spray.	<i>Cercospora</i>	leaf mold, leaf spot, early blight, frog-eye
<i>Gliricidia sepium</i> (Kakawate)	leaves	Extract juice of 1 kg leaves, then mix juice with 3 liters of water, and use as spray.	<i>Cercospora</i>	leaf mold, leaf spot, early blight, frog-eye
<i>Coleus scutellarioides</i> (Mayana)	leaves	Extract juice of 1 kg leaves, then mix juice with 3 liters of water, and use as spray.	<i>Cercospora</i>	leaf mold, leaf spot, early blight, frog-eye
<i>Vitex negundo</i> (Lagundi)	leaves	Extract juice of 1 kg leaves, then mix juice with 3 liters of water, and use as spray.	<i>Cercospora</i>	leaf mold, leaf spot, early blight, frog-eye
<i>Blumea balsamifera</i> (Sambong)	leaves	Extract juice and spray at a proportion of 1 part juice and 1 part water.	<i>Cercospora</i>	leaf mold, leaf spot, early blight, frog-eye

¹ Plant species showing activity against different fungal pathogens at two days incubation after seeding, based on zone of inhibition. (Data from Quebral, 1981)

² Plant names in italics are scientific names; those in parenthesis are common/local names.

³ Based on indigenous practice of farmers.

Insecticidal¹ Plants

Name of Plant ²	Part(s) Used	Mode of Preparation and Application ³	Target Pest(s)	Source ⁵
<i>Ageratum conizoides</i> (goat weed)	leaves	-	<i>diamond backmoth</i> <i>cotton stainer</i>	Alcantara, 1981
<i>Artemisia vulgaris</i> (damong maria)	leaves	Pound, extract juice and spray at a rate of 2-4 tablespoons/16 liters water	<i>corn borer</i>	Calumpang, 1983
<i>Lantana camara</i> (lantana)	flowers	Pound and spread around stored grains	corn weevil	Fuentebella & Morallo-Rejesus, 1980
<i>Derris philippinensis</i> (tubli)	roots	Extract juice and spray at a rate of 5 cups juice/5 gallons of water, or Powder, mix with detergent and spray at a rate of 120 grams powder + 250-300 grams detergent/4 gallons of water	<i>diamond backmoth</i>	Maghanoy & Morallo-Rejesus, 1975
<i>Tithonia diversifolia</i> (wild sunflower)	leaves	Pound, extract juice and use as spray at a rate of 1-2 kg fruits/liter of water	<i>cotton stainer</i> <i>black army worm</i> <i>diamond backmoth</i>	Cariño & Morallo-Rejesus, 1982
<i>Tagetes erecta</i> (marigold)	roots	Extract juice and spray at a rate of 2-4 tablespoons juice/liter of water	<i>rice green leafhopper</i> <i>brown planthopper</i> <i>diamond backmoth</i> <i>black bean aphid</i>	Morallo-Rejesus & Eroles, 1978 Morallo-Rejesus & Decena, 1982
<i>Tagetes patula</i> (French marigold)	roots	Pound, extract juice of 1 kg roots and mix with 1. liter water, then spray the solution directly into the soil	<i>green aphid</i> <i>less grain borer</i>	Morallo-Rejesus & Silva, 1979
<i>Tinospora rumphii</i> (makabuhay)	vines	Extract juice and spray at a rate of 15-20 tablespoons juice/5 gallons water	<i>diamond backmoth</i> <i>rice green leafhopper</i>	del Fierro & Morallo-Rejesus, 1976 Morallo-Rejesus & Silva 1979

Name of Plant ²	Part(s) Used	Mode of Preparation and Application ³	Target Pest(s)	Source ⁵
<i>Piper nigrum</i> (black pepper)	fruits	Pulverize seeds, mix with water and spray; powder and spread around stored grains	<i>cotton stainer</i> <i>diamond backmoth</i> <i>common cutworms</i> <i>corn weevil</i>	Javier & Morallo-Rejesus, 1982 Ponce de Leon, 1983
<i>Capsicum frutescens</i> (hot pepper)	fruits	Pound, extract juice and spray at a rate of 2-3 cups fruit/liter of water	rice moth	Ponce de Leon, 1983
<i>Annona squamosa</i> (custard apple)	seeds	Powder and disperse in water, then strain and use as spray	rice pests	Saxena & co-workers (IRRI), 1984
<i>Azadirachta indica</i> (neem)	seeds	Remove husks of 2-3 handfuls of mature seeds. Winnow or put in water to float away the husks. Grind seeds into fine particles. Soak ground seeds in 3-5 liters water for at least 12 hours. Filter the solution, then use as spray.	rice pests diamond backmoth	Saxena & co-workers (IRRI), 1984

¹ Found effective, based on crude assay but further studies are needed to determine safety and residual action.

² Names in italic are scientific names; names in parenthesis are common/local names.

³ Based on indigenous practice of farmers.

⁴ Mortality is 30% or more with crude extracts.

⁵ Researchers who conducted laboratory tests on particular plant.

Source: International Institute of Rural Reconstruction (IIRR). Silang, Cavite, Philippines.

Small Livestock and Fish Production



Integrated Community Food Production

A Compendium of Climate-resilient Agriculture Options

Backyard Piggery Project

In spite of the availability of various kinds of commercial feed mixtures, hog raisers should be knowledgeable in compounding feeds. This would come in handy in case of shortage of feed supplies. More importantly, mixing can also produce practical and more economical formulations that will give optimum results. Feeds constitute the largest chunk (estimated at 75-80%) of the total cost of production. It is most imperative, therefore, to reduce this cost. A simple program of feeding is recommended using feed ingredients that are inexpensive and locally available. Such feeds, however, should contain adequate quantities of the recommended nutrients necessary for the normal growth of the animals. These are protein, carbohydrates, fats, minerals and vitamins, plus water.

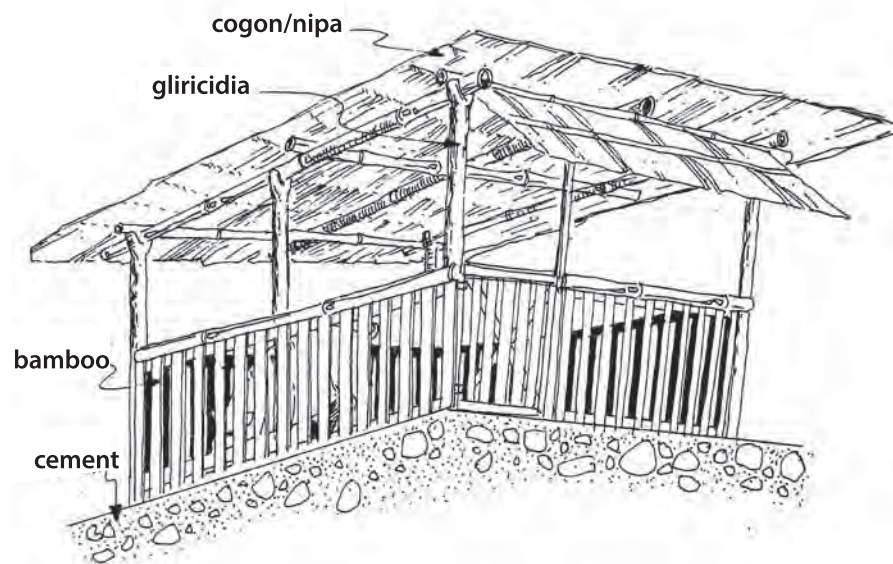

Listed below are a selection of easy to formulate rations for hog fattening:

Ration 1	Parts by Wt.
Rice bran	60kg
Yellow corn	10kg
Coconut (bagasse)	10kg
Leucaena leaf meal	5kg
Rice midlings	5kg
	<hr/> 100kg
Crude Protein	<hr/> 12.881%

Ration 2	Parts by Wt.
Rice bran	80kg
Japanese/Golden snail*	10kg
Gabi tuber/cassava*	20kg
Ground yellow corn	10kg
Leucaena leaf meal	10kg
	<hr/> 100kg
Crude Protein	<hr/> 14.9175%

*These feed ingredients should be cooked first. Corn and rice middlings should be soaked overnight or cooked to facilitate digestion.

Ration 3	Parts by Wt.
Rice bran	40kg
Kitchen left over*	50kg
Leucaena leaf meal	10kg
	<hr/>
	100kg
Crude Protein	<hr/> 14.822%

Ration 4	Parts by Wt.
Rice bran	80kg
Leucaena leaf meal	15kg
Rice middlings	5kg
	<hr/>
	100kg
Crude Protein	<hr/> 14.9175%

Ration 5	Parts by Wt.
Rice bran	60kg
Swamp cabbage leaves or vegetable leaf left over*	30kg
Yellow corn	5kg
Coconut bagasse	5kg
	<hr/>
	100kg
Crude Protein	<hr/> 9.96%

Ration 6	Parts by Wt.
Rice bran	80kg
Banana trunk (chopped finely)	30kg
Leucaena leaf meal	10kg
	<hr/>
	100kg%
Crude Protein	<hr/> 10.591%

NOTE: Add the following to the above rations:

Salt	1kg
Ground oyster shell	2kg
Well-shifted kitchen ash	.25kg
Afsillin	200g. (if available)

Other "non-conventional" feed ingredients that can be used as hog feeds.

Mollases	10 - 30%
Fish sauce	5%
Banana fruit	10 - 20%
Spoiled milk	
Papaya fruit	10 - 20%
Soybean (by-products)	10 - 30%
Shrimp heads*	5 - 10%
Camote leaves	20 - 30%
Wheat pollard	20 - 60%
Over ripe fruits in season	20 - 40%
Chicken offals*	5 - 10%

Source: IIRR. 1990 Low External Input Technology Information Kit, IIRR, Silang, Cavite, Philippines

*These feed ingredients should be cooked first. Corn and rice middlings should be soaked overnight or cooked to facilitate digestion.

Native Pig Production

Native pigs are important sources of income, food and manure on small farms. Native pigs are sold to friends and neighbors, used during special occasions or serve as a profitable part-time job for family members. These pigs are considered sturdy and are more resistant to various hog diseases. They can survive on kitchen wastes and farm-grown feeds or farm by-products.

Backyard swine raisers may prefer to raise native pigs than the imported breeds of swine mainly due to the scarcity of capital resources to purchase initial stock and to build a house/pen and to provide commercial feeds.

Comparison

	Native	Upgraded	Pure-Breed
Age (from birth to market)	7-9 months	7 months	4.5-5.5 months
Carcass weight	40 kilos	50 kilos	60-70 kilos

Low-cost Housing/Pen of Native Pigs

Considerations:

1. Site -- Elevated, near water source
2. Orientation -- East to west orientation; with this type of orientation, floor of the pen is kept dry.
3. Roofing materials -- Cogon, nipa, used G.I sheets
4. Flooring materials
 - a. Cement
 - Thickness: 3.5-4" (88.9-102mm)
 - Preparation: 1 part cement, 3 parts gravel, 2.5 parts sand, 2/3 parts water

- b. Wood slabs
 - c. Bamboo
5. Space requirement for two heads of pigs: 2sqm
 6. Sidings: bamboo

Note: *Gliricidia* and *Leucaena* are not applicable since these could be eaten up by the pigs.

Height of sidings:

36" (914 mm) for fatteners and breeders 30" (762mm) for weanlings and starters

7. Feeding and watering trough materials used:
 - a. cement
 - b. wood
 - c. bamboo
 - d. halved-tire

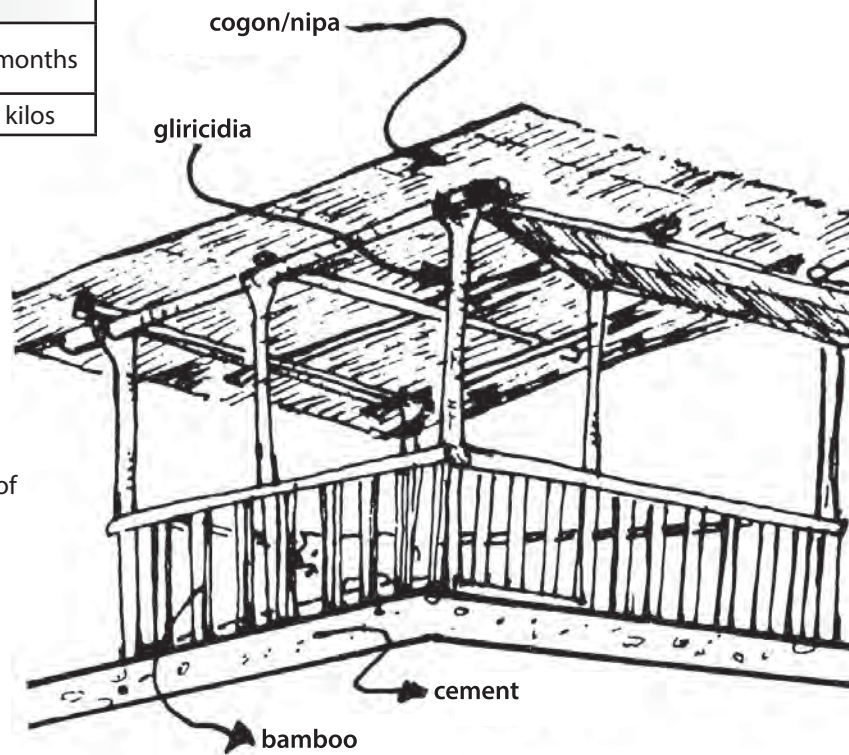

Feeds and Feeding

Common ways of Preparing Feeds

1. Grinding

This would depend on the age of the animal to be fed. Young animals do not have fully developed digestive system, hence, there is a need for grains to undergo the process.

Example: Corn

2. Cooking

Through this process, the feeding value of some feed stuff is increased. Likewise, calcium oxalate which causes itchiness is destroyed.

Examples: Beans and gabi

Feeding Management

Weight	No. of feeding time	Feeding system	Average daily intake
10 kg (12.2lbs)	4x a day	Dry feeding	1-2kg a day
45 kg (99lbs)	3x a day	Wet feeding	2.2kg a day
55 kg (121lbs)	2-3x a day	Wet feeding	2.5kg a day

Considerations:

- The number of feeding time presented would minimize feed wastage.
Note: Decrease the amount of feed given to animals with diarrhea.
- Dry feeding is recommended for starters since they still have less feed intake; that way, spoilage of feeds is minimized.

Examples of feedstuff for native pigs.

	Parts used
A. Protein sources	
1. Madre de Cacao <ul style="list-style-type: none"> ▪ <i>Gliricidia sepium</i> ▪ Kakawati 	Leaves, stems, flowers, fruits

	Parts used
2. Ipil-ipil <ul style="list-style-type: none"> ▪ <i>Leucaena leucocephala</i> 	Leaves, stems, flowers, fruits
3. Cowpea <ul style="list-style-type: none"> ▪ <i>Visna sinensis</i> ▪ Paayap 	Leaves, stems, flowers, fruits
4. Hyacinth bean <ul style="list-style-type: none"> ▪ <i>Dolichos lablab</i> ▪ Batao 	Leaves, stems, flowers, fruits
B. Energy sources	
1. Corn <ul style="list-style-type: none"> ▪ <i>Zea mays</i> ▪ Mais 	Grain
2. Cassava <ul style="list-style-type: none"> ▪ <i>Manihot esculenta</i> ▪ Kamoteng kahoy, baling 	Root
3. Sweet potato <ul style="list-style-type: none"> ▪ <i>Ipomoea batatas</i> ▪ Kamote 	Root
4. Taro <ul style="list-style-type: none"> ▪ <i>Colocasia esculenta</i> ▪ Gabi 	Root
5. Ubi <ul style="list-style-type: none"> ▪ <i>Dioscora alata</i> ▪ Ubi 	Tuber
6. Arrow root <ul style="list-style-type: none"> ▪ <i>Maranta arudinacea</i> ▪ Uraro 	Root
7. Tugui <ul style="list-style-type: none"> ▪ <i>Dioscorea esculenta</i> 	Root
C. Vitamin and mineral sources	
1. Malunggay <ul style="list-style-type: none"> ▪ <i>Moringa oleifera</i> ▪ Malunggay, kalunggay 	Leaves, stems, flowers, fruits
2. Amaranth <ul style="list-style-type: none"> ▪ <i>Amaranthus spinosus</i> ▪ Uray, kulitis 	Leaves

	Parts used
3. Sweet potato <ul style="list-style-type: none"> ▪ <i>Ipomea batatas</i> ▪ Kamote 	Leaves, vines
4. Gabi <ul style="list-style-type: none"> ▪ <i>Colocassia esculenta</i> 	Leaves, petiole
D. Water sources	
1. Sweet potato <ul style="list-style-type: none"> ▪ <i>Ipomea batatas</i> ▪ Kamote 	Leaves, stems, flowers
2. Kangkong (upland) <ul style="list-style-type: none"> ▪ <i>Ipomea aquatica</i> 	Leaves, stems

Examples of feed rations

Starter (18% CP)	Grower to fattener (14-16% CP)
1. Rice bran (D1) - 5.4kg Corn bran - 4.6kg	1. Rice bran - 7.2kg sapal - 2.8kgs
2. Midlings - 6.3kg Corn gluten - 3.6kg	2. Kamote (roots) - 5.0kg Ipil (leaves) - 5.0kgs 3. Cassava (roots) - 3.2kg Rice bran - 6.8kg 4. Corn bran - 3.0kg Mollases - 2.0kgs Tugui (roots) - 1.5kg Fish washings - 1.0kg

Housing and Feeding for Pigs

Pigs need protection from extreme cold and heat. They are housed in many different ways, depending upon the local practices.

Low-cost Housing Materials

If possible, pig pens should be built on higher ground, preferably near water sources. Orient the house in an east-west direction. This orientation keeps the floor of the pen dry by allowing the sun to dry the pen floor as the sun crosses the sky during the day.

Roofing Materials

- Bamboo
- Coconut leaves
- Wooden tiles (layered)
- Cogon (*Imperata cylindrica*) grass
- Palmyra (*Borassus flabellifer*) palm leaves
- Nipa (*Nypa fruticans*) palm leaves
- Old galvanized iron sheets
- Betel nut leaves
- Other locally available thatching materials

Sidings/wall Materials

- Bamboo
- Wood planks
- Stones

Shelter your pigs under storage sheds. This cuts construction costs and makes good use of space.



In Thailand, some farmers build open shelters with special ventilated roofs. A space separates the inner roof, which has an open peak, from the outer roof.

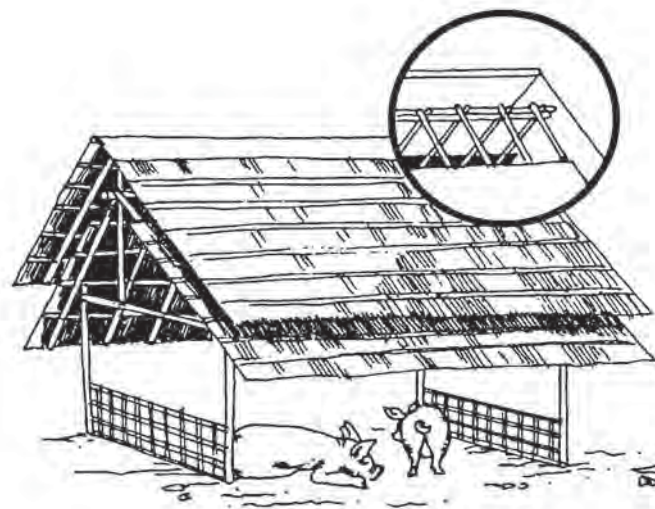

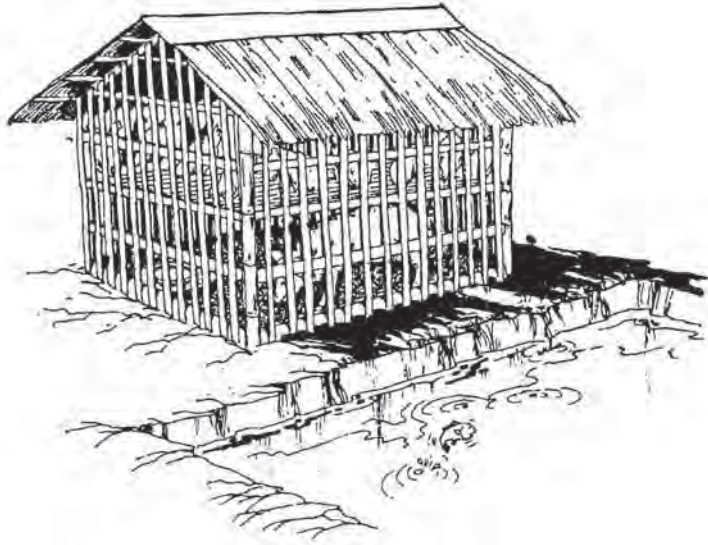

You can house pigs under your poultry. Pigs will eat chicken manure and, if you have a nearby pond, your fish will eat any nutritious runoff.



Farmers in some parts of the Philippines build open pens with thatched bamboo shades. The pigs have a cool place to rest and an open area in which to eat, defecate and roam.

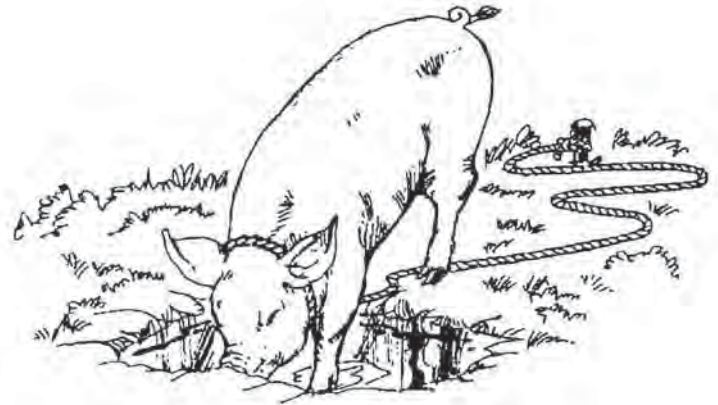

Try tethering your pigs to a stake, within reach of drinking water and a cool wallowing hole.

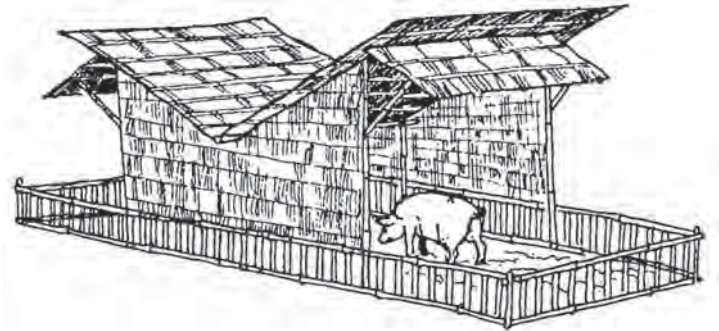

In Thailand, farmers build back-to-back shelters of thatched bamboo and fencing.

To give your pig room to roam, tether it on a wire or cord stretched between two wooden stakes. When the forage is eaten away, the stakes can be moved.

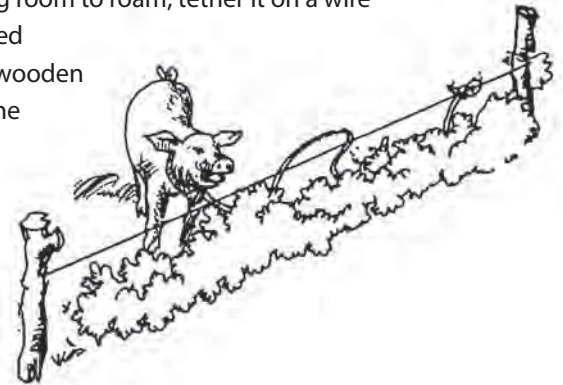

Feeding

Good feed is necessary for growth, body maintenance and the production of meat and milk.

Stores sell pre-mixed rations that have the right amounts of ingredients for pigs of various ages. However, these pre-mixed feeds can be expensive. Instead, you can use locally available feeds that are less expensive, but can be nutritionally complete when properly prepared. In fact, pigs can be fed well, using only kitchen scraps from a family's household.

The nutritional needs of pigs can be divided into six categories or classes. These are water, carbohydrates, fats, proteins, vitamins and minerals.

Water

Pigs should have free and convenient access to water. The amount required varies with age, type of feed and environmental temperature. Normally, pigs will consume 2-5kg of water per kg of dry feed. The range may be from 7 to 20 liters of water per 100kg of body weight daily.

Water Sources

- Banana trunks.
- Leaves of *Ipomoea batatas*, *Ipomoea aquatica*
- Rind of watermelon (*Citrullus lanatus*)



Low-cost, Locally Available Feeds

Protein-rich Feeds

Plant sources

- Grated coconuts
- *Leucaena leucocephala* leaves
- *Gliricidia sepium* leaves
- Beans
- *Moringa oleifera* leaves
- Pigeonpea (*Cajanus cajan*)
- Groundnut cake (left-over after oil extraction)
- Seed skins of mung bean sprouts
- Waste of soybean cake (liquid)
- Rice bran

Animal sources

- Fish rejects
- Frogs
- Shrimps
- Snails
- Earthworms.
- Maggots, grubs, other insects.
- Crabs (from the rice field)

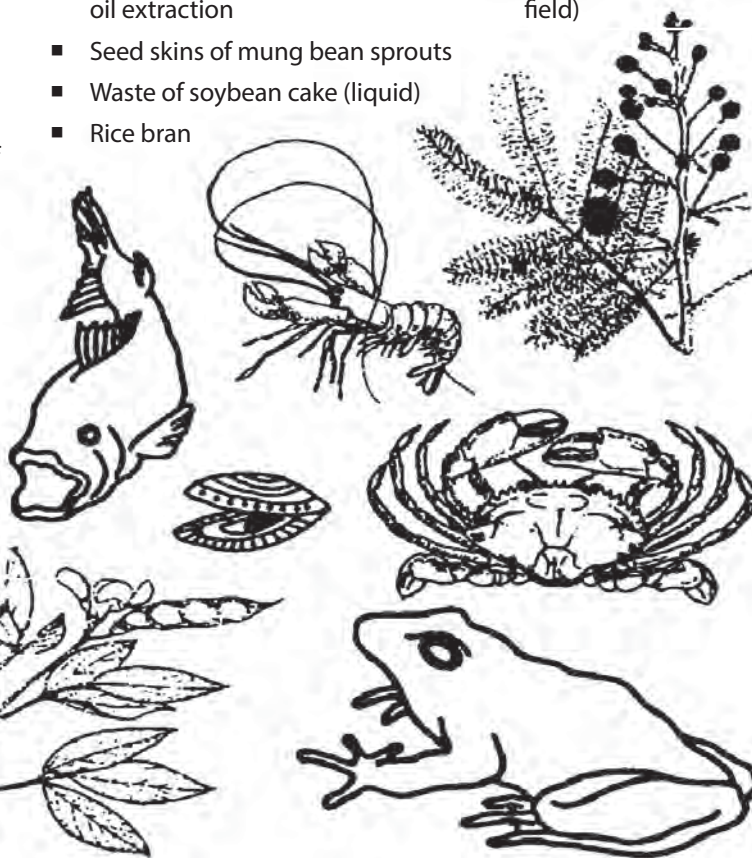

Carbohydrate Sources

Scientific name	Common name	Parts used
<i>Colocasia esculenta</i>	Taro	Corm
<i>Dioscorea alata</i>	Greater yam	Tuber
<i>Dioscorea esculenta</i>	Lesser yam	Tuber
<i>Ipomoea batatas</i>	Sweet potato	Root
<i>Manihot esculenta</i>	Cassava	Root
<i>Maranta arundinacea</i>	Arrowroot	Root
<i>Oryza sativa</i>	Rice	Bran
<i>Zea mays</i>	Maize	Grain

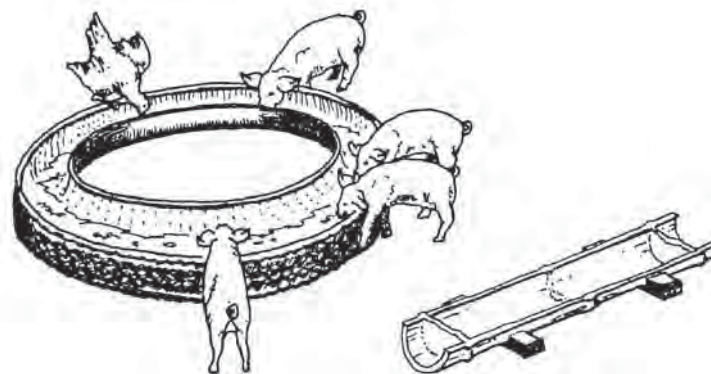

A piglet feeding trough can be made by cutting a car tire in half along its circumference.

Or, a piglet feeding trough can be made from split bamboo.

A good trough can be made by hollowing out a section of log.

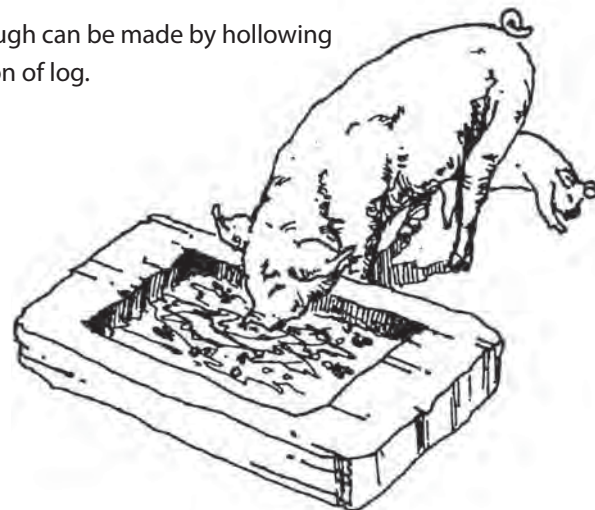

Old cooking pots make good feeding troughs.

Vitamin and Mineral Sources

- Pounded bones.
- Leaves of *Moringa Oleifera*
- Salt.
- Molasses.
- Fruit rejects/peelings.
- *Ipomoea aquatica*.
- Water hyacinth (*Eichhornia crassipes*).
- Green and leafy veg-etables.

Pigs will eat insects and kitchen waste. Some farmers in the Philippines trap termites and feed them to their pigs. A wooden

box is left on top of a termite mound. From time to time termites are shaken out of the box directly into the pig trough. A split bamboo duct can be used to send kitchen waste—first rinse only, without soap—to your pig trough.



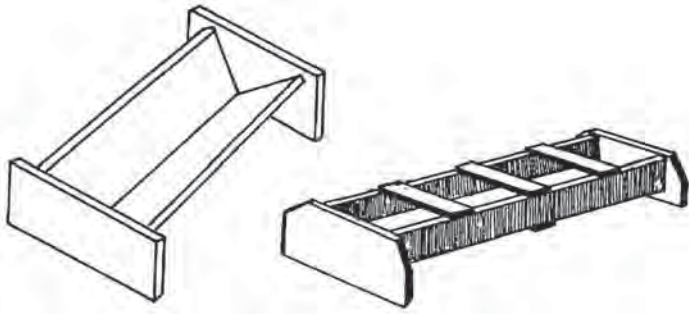

A variety of feeding troughs can of feeding through can be made easily with lumber.

Housing

Housing practices vary widely from place to place. In general, however, stock raisers do the following:

Protection

- People protect their animals from rain, sun, wind, cold, predators and thieves. For example: they may plant thorny bushes around the animal shed to keep predators and thieves away.
- They build a shed, house, barn or other structure to shelter the animals. Or sometimes, if people's homes are raised on stilts, they keep their livestock under the home.
- In many areas, farmers plant certain trees to provide shade near the livestock shed.
- They plant neem, eucalyptus or *Ocimum sanctum* around the shed to repel insects.
- They light smoky fires near or under the shed to drive away ticks, lice and insects.
- They do not plant mango, curry leaf (*Murraya koenigii*) or bamboo near the shed, as these species attract snakes and bats. For the same reason, they do not stock large amounts of firewood, hay or straw near the shed.

Space

- Farmers provide enough space for each animal to lie down and stand, turn around and defecate without the dung soiling itself or other animals.
- They avoid overcrowding.

- They provide adequate ventilation and

Feed and Water

- People provide a container with clean drinking water.
- In certain areas, farmers build a small feeding manger to hold green or dry fodder.

Hygiene

- Traditionally in many areas, farmers slope the floor of the shed so the urine and dung can flow out. This helps keep the shed clean.
- They use straw from rice, wheat and other plants for bedding. They replace this regularly with fresh straw.
- The farmers clean away dung, urine and mud each morning.
- In some countries, they apply a layer of fresh mud on the floor of the shed.
- They may regularly sprinkle dry lime (calcium hydroxide) or powdered limestone on the floor 2-3 times a week as a disinfectant and to repel flies. Once a month, they wash the walls with limestone powder mixed with water.
- In India, farmers mix a handful of dung in a bucket of water and sprinkle this mixture on the floor. Over time, this produces a hard flooring that is easy to keep clean. It also keeps the ground even, so animals will not slip.
- They isolate or quarantine sick animals from other animals.

Some Examples of Ruminant Housing

Housing types vary widely from place to place. Here are a few examples.

This shelter, built in the village near the owner's home, houses 10-20 animals. The roof is made of dried palmyra tree leaves (which are rainproof) or dried grasses. The posts are of bamboo, palmyra tree wood, teak, rose wood, or other strong wood. The floor is of mud. The animals are kept in the shed during the night and let out to graze in the forest during the day. The shed is cleaned and fresh mud is put on the floor before the animals return. The shed provides protection from the sun and rain, yet allows sufficient light and air to get in. It is very cool inside.

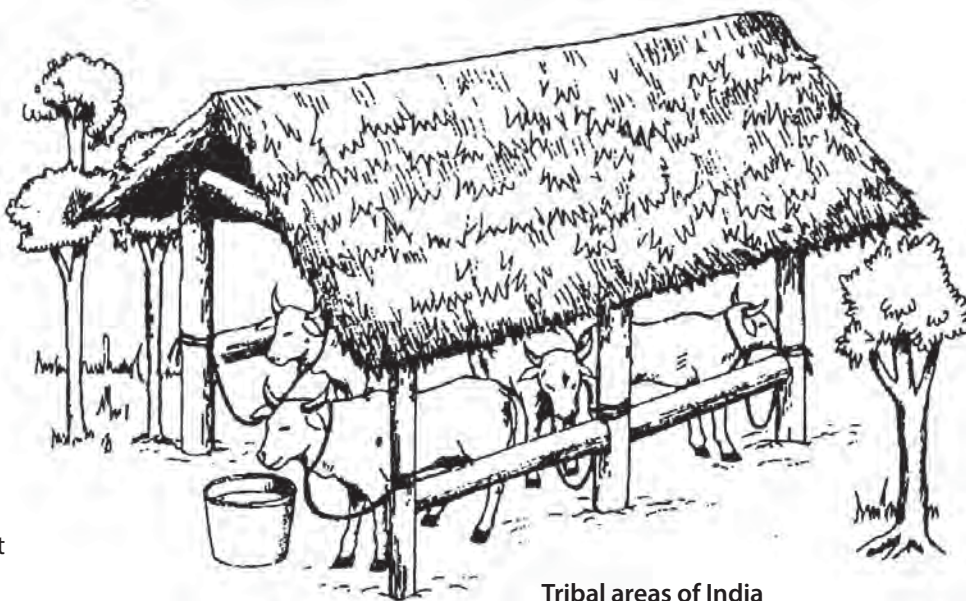

Tribal areas of India

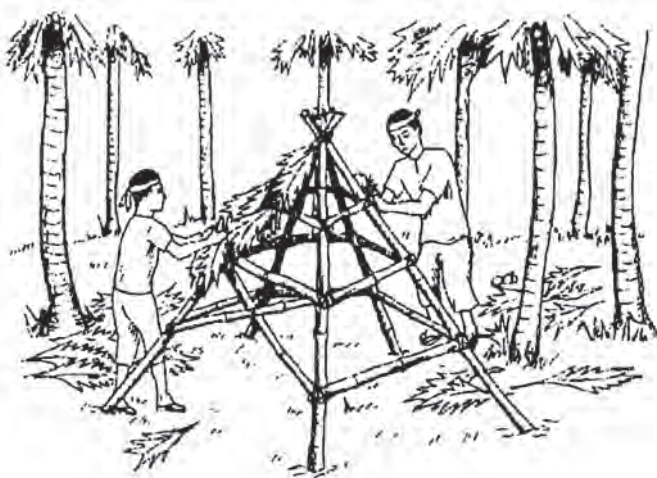

Coastal areas of Andhra Pradesh, India.

This area is prone to cyclones and has very heavy rainfall (more than 1800 mm per year). The round, conical shape provides minimum resistance to cyclones and the sloping roof reaching almost to the ground prevents the roof from blowing away. This shelter can house 2-3 animals. It is usually located in the fields. The roof is made of palmyra tree leaves and the frame of palmyra

wood. The floor is of mud. The shelter is cool in summer and warm in winter. However, it is dark inside and ventilation is sometimes inadequate. A container of water is placed inside, but there is no manger for fodder.



Deccan (India) and Sri Lanka

This shed is attached to the owner's house and is made of bricks, mud, wood or stone. It houses 1-2 animals. The roof is of dried wild hemp stalks or other grasses. The floor is of mud or brick, and it slopes so mud, dung and urine flow out. A feeding manger and a container for water are built in. The shed obviously is well-ventilated and cool.

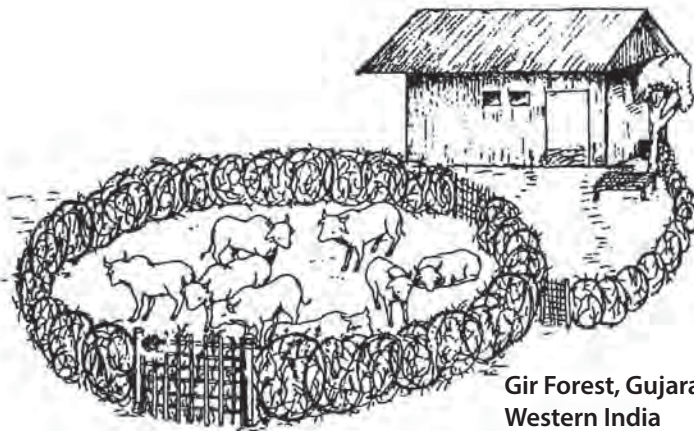

Gir Forest, Gujarat, Western India

Farmers in the Gir Forest build a circular, thorny fence of *Acacia arabica* branches. They keep their buffaloes inside during the night to protect them from lions and wolves. During the day, the buffaloes are let out to graze in the forest, where they seek shade under the trees: Farmers throughout India build a thorny fence or plant cacti around their own and their animals' housing to deter predators.



Philippines

Many farmers in the Philippines and Laos keep their animals under the house, or in a room next to their own living area. The house is made of slatted bamboo and/or wood. The roof is thatched with local grasses. The animals' body heat helps warm the house. Owners can give care to the animals very easily. However, pests and diseases such as mange, leishmaniasis and flies can spread from animals to humans. On the other hand, farmers in the Philippines say that—although the goats they keep under their houses have a strong and unpleasant odor—the smell helps keep mosquitoes away from the home.

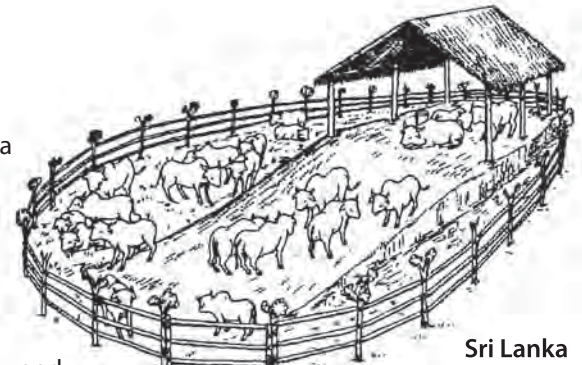

Sri Lanka

Farmers build a corral of trees, logs and wire. The animals rest inside the enclosure in a shed made of wood or bam-boo, roofed with grass or leaves. This shed is built at the top of the slope, so water and waste materials run out of it.

Sometimes, farmers tie their animals under a tree. In Thailand, they use a special bamboo spring on the tether. This prevents the rope from twisting and becoming tangled.

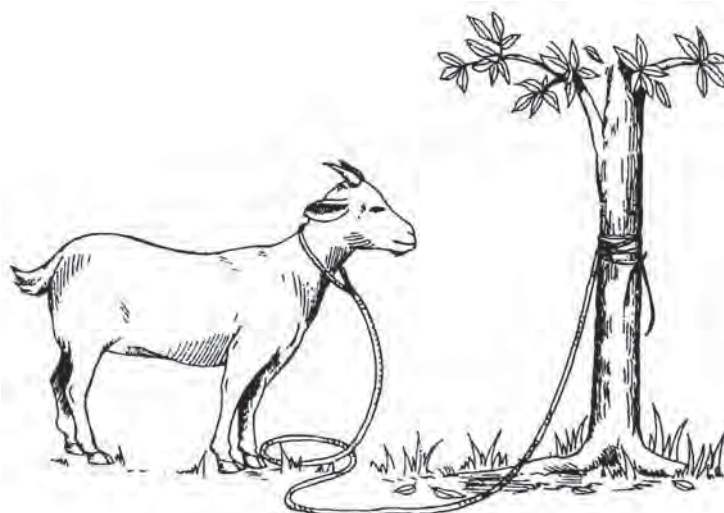
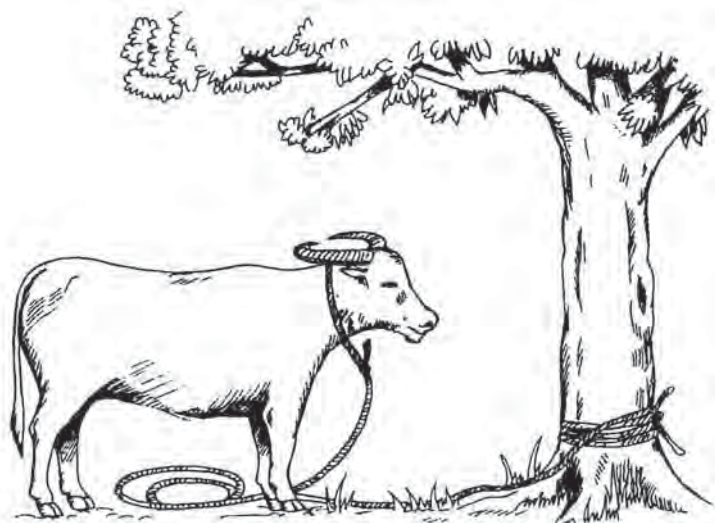

Throughout South and Southeast Asia

Sheep and goat pens are often built on stilts. The floor is made of slatted wood or bamboo, so that the droppings and urine fall through. In India and Indonesia, there is a pit below to collect these valuable organic materials. The manure can be removed easily from beneath the pen for spreading in the fields. The roof is thatched with grass. The owners or their children cut grass from roadsides and field boundaries and put it in a manger attached to the pen for the animals to eat. Surplus grass can be stored at one end of the shed. This pen protects the animals from thieves and predators. It is clean and hygienic. In Indonesia and Sri Lanka, animals of different ages and sexes may be kept separate using dividers within the house. Pregnant animals and mothers with newborns are also separated from other animals.

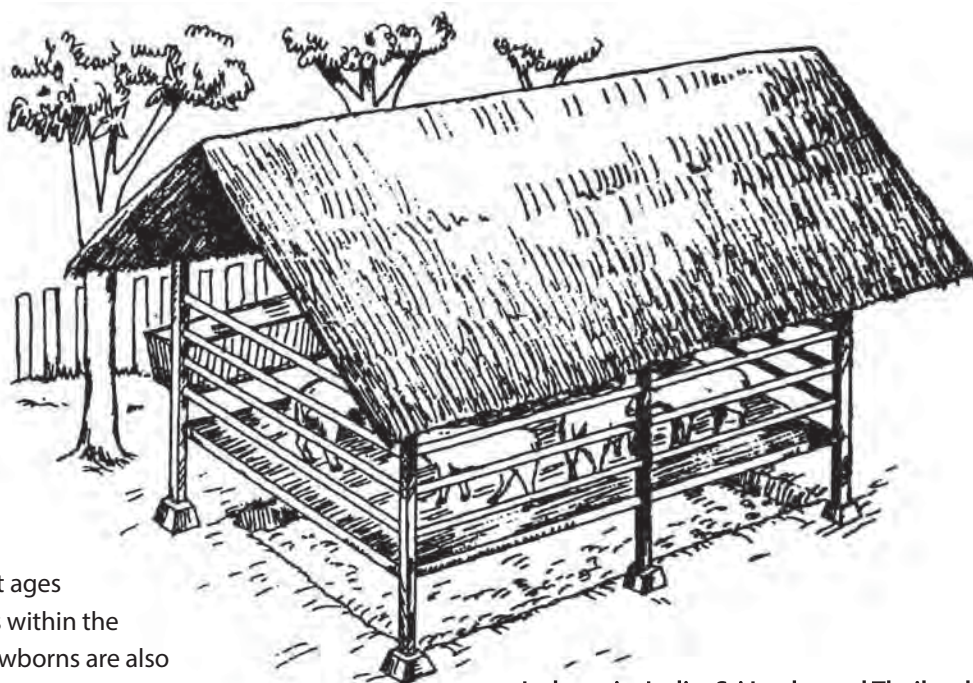

Indonesia, India, Sri Lanka and Thailand

Semi-migratory shepherds use small branches to make moveable, collapsible fences. They erect these in the field to keep their goats and sheep in at night. The shepherd sleeps in the small shed in the center of the enclosure. During the day, the animals are released from the enclosure and allowed to graze. Outside, only animals that are too young to graze are kept inside the shed during the day with a shepherd who guards and feeds them.

The shepherd moves the enclosure around the field, so that the entire field is manured at night. The farmer pays the shepherd for this manure.

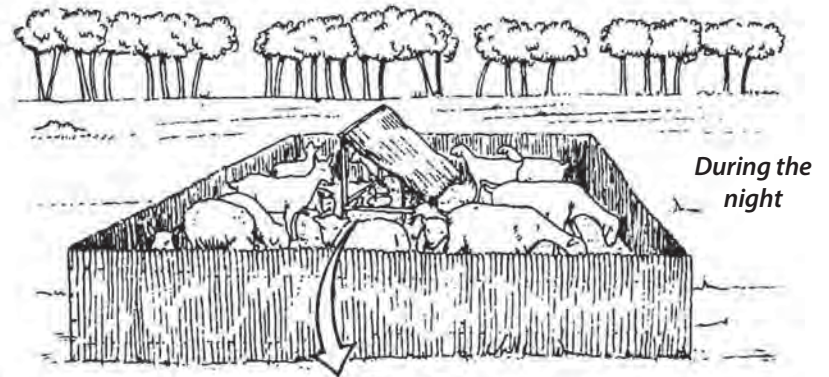

During the night

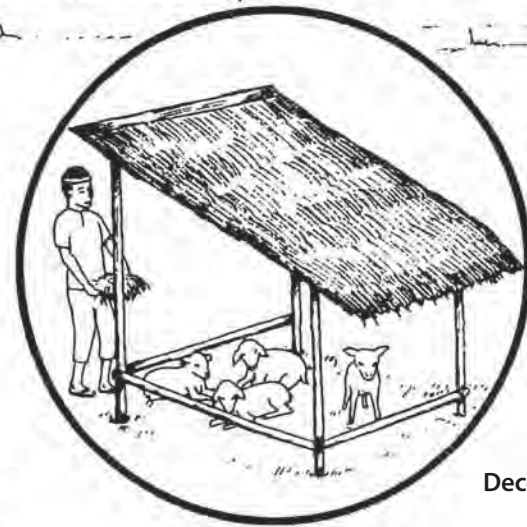

During the day

Deccan, India

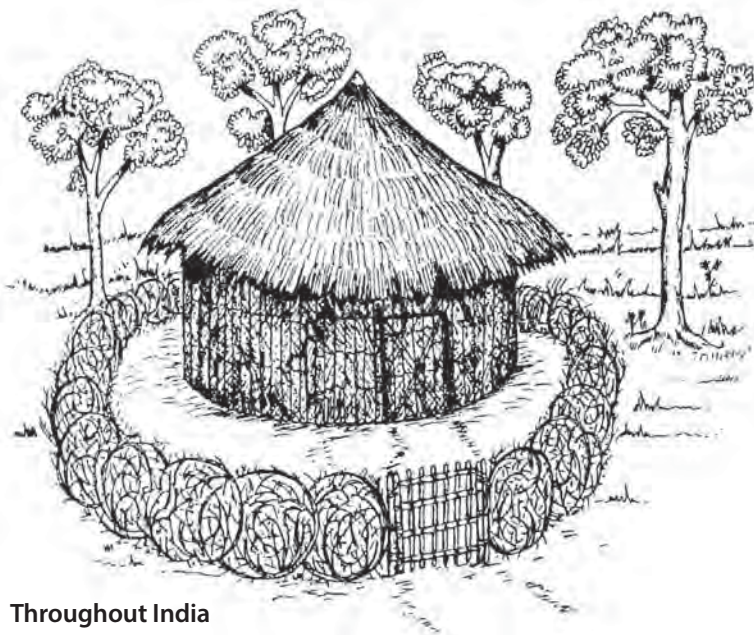

Throughout India

Farmers build a thorny fence of *Acacia arabica* or *Acacia farnesiana* around their goat houses to deter thieves and predators. The house itself is round and made of bamboo, wood and mud. The roof is thatched with palmyra leaf or grass. The floor is of mud. Animals of all ages are housed together. Some farmers clean out the dung; others use the dung as bedding.

Various Types of Roofing Materials

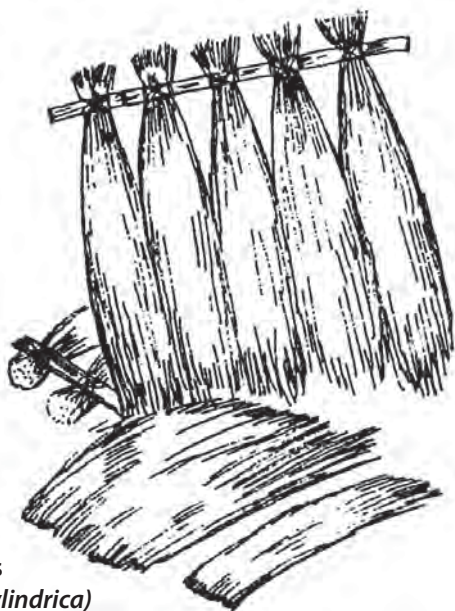

Cogon grass
(*Imperata cylindrica*)



Coconut leaves



Banana leaves

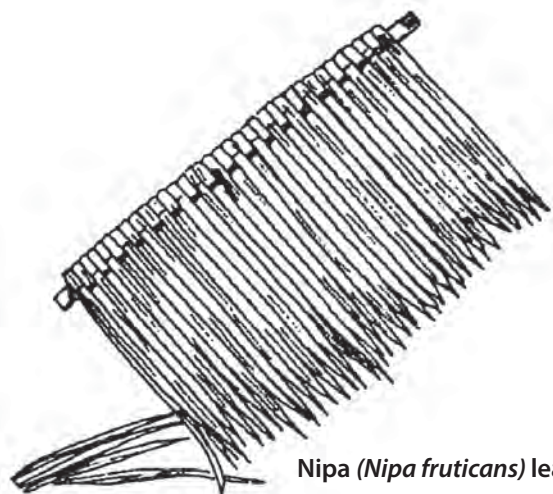

Nipa (*Nipa fruticans*) leaves

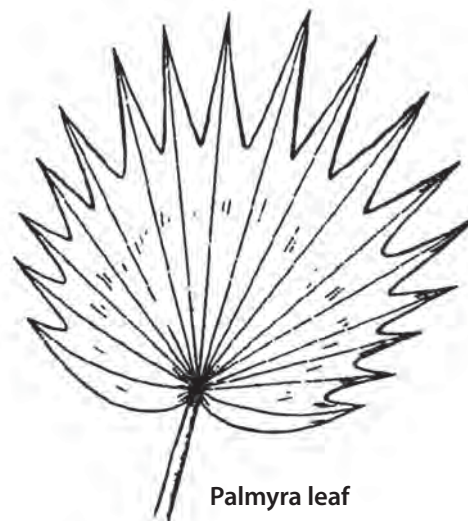

Palmyra leaf

Source: IIRR. 1994, *Ethnoveterinary Medicine in Asia: an information kit on traditional health care practices*, IIRR, Silang, Cavite, Philippines.

Breeding and Care of New Born Pigs

Heat Detection

Common Signs of Heat

- The sow's vulva is flushed (reddish) and swollen two or three days before standing heat.
- The vaginal discharge is watery.
- The sow is restless.
- As the sow comes into heat, she will mount other pigs or will allow other pigs to mount her. She will move away unless she is in full "standing heat".
- The sow stands still when she feels pressure on her back.

Heat lasts about 24 hours. After that, the sow will not stand still for the boar. Some sows bleed from their vulva following a heat period.

How to Induce Heat

After farrowing, a sow may be slow to come into heat. Here are a few methods used by farmers to induce heat. Gently stroke the sow's vagina with a freshly cut papaya stalk every morning for 3-5 days.

- Spray the sow's (or gilt's) pen with boar urine every morning for 3-5 days.
- Grind 1kg of fresh or dried lotus (*Semen nelumbinis*) seeds. Mix with 20kg of dry feed. Feed to the sow twice a day for 5-7 days.
- Bring the sow to the boar, or place the sow in a pen next to the boar.

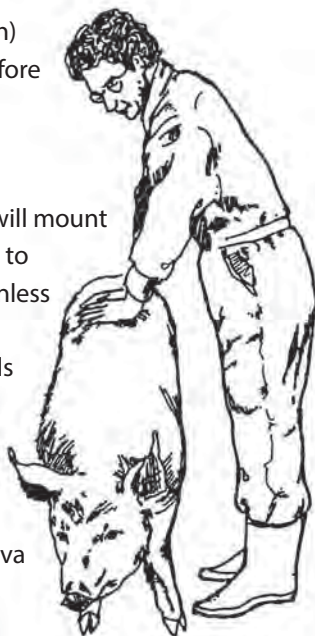

Mating

During her 24-hour heat period, a sow should be mated 2 times at approximately 12-hour intervals. Do not mate animals during the hot time of day.

Assistance

Young boars may need assistance in lining up their mate. Make sure your hands and wrists are clean and your fingernails are trimmed.

Pigs mate slowly. The boar may take a minute or more to reach the point of ejaculation.

To Improve Conception

- Crush 1kg of *Semen nelumbinis* (lotus) seed and mix with the sow's feed. Give 2 times per day for 3-5 days.
- Fat sows may have difficulty conceiving. Therefore, if a sow is too fat, reduce her feed.



Reasons for Not Conceiving

- The sow is too fat.
- It is the animal's first heat cycle.
- The boar is too young.
- The boar is overworked (used for more than five matings a week).

Pregnancy Detection

If a sow does not show signs of heat three weeks after mating, then it is very likely that she is pregnant.

Care During Pregnancy

- Separate pregnant sows from other animals.
- Protect pregnant sows from high temperatures.
- Do not transport a pregnant sow.
- Until the final stages of pregnancy, exercise is good for pregnant sows. Give the sow space to walk in.

Feed for Pregnant Sows

- Provide a good supply of clean drinking water.
- If you are feeding a concentrate ration, gradually reduce the ration one week before farrowing.
- Make green forage available to the pregnant sow.
- Throughout the pregnancy, feed pregnant sows rice water (the water left after cooking rice).
- Add *Amaranthus gracilis* and *Amaranthus spinosus* to the pregnant sow's feed. Feed a ration of 2 percent of the sow's body weight per day throughout pregnancy.
- Feed the fresh leaves and stems of water spinach or swamp cabbage (*Ipomoea aquatica*) daily to pregnant sows. (Thailand. 1, 2, 3, 4)
- Feed sows a soup made of rice and one eel once each day for 7 days before birth. This is said to make farrowing easier.
- Feed 3 to 5 lombrice (round earthworms) every day throughout pregnancy. Earthworms are a good source of protein. Some farmers also think that the earthworm's long, thin shape helps ease the birthing process.

If the sow is constipated during pregnancy, feed large amounts of rice bran or sweet potato leaves as a laxative.

Farrowing

A sow needs a special place for farrowing (birthing). One week before the animal is expected to farrow, put it in the farrowing pen so it can adjust to the area. Provide a separate farrowing pen for each animal.

A farrowing pen should be 2m by 2.5m in size. The pen should have piglet guard rails along the sides. These can be planks or poles 20 to 25cm off the floor, reaching about 30 cm from the walls. Guard rails will help prevent piglets from being crushed by the sow.

- Disinfect the farrowing pen each time before it is used. To disinfect, pour boiling water over the entire pen.
- Allow proper ventilation in the pen, but make sure there are no drafts or winds.
- Keep the birthing area clean and dry.
- Provide sufficient drinking water.
- Scrub the whole body of the sow with clean water and a clean cloth. One day before farrowing, brush the animal to remove external parasites. This will help protect the piglets from parasites.

If no special pen is provided, the sow will follow her mothering instincts and prepare her own farrowing area. She will dig a shallow pit in the ground as a farrowing place.

In tribal areas of northern Thailand, it is seen as bad luck for a sow to farrow inside the village. In such cases, the sows and piglets are killed. To avoid this, sows are encouraged to farrow in an area outside the village.

Pigs should have a place to go where they are protected from the elements. A simple open shelter can be constructed from sticks and thatch.

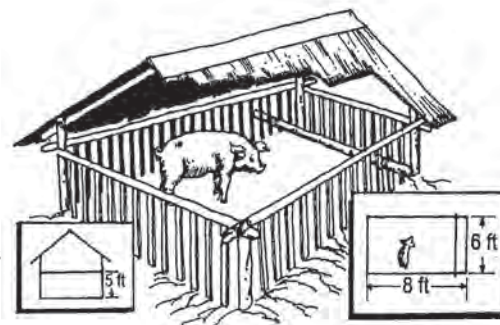

Bedding Materials Commonly Used

- Chopped hay or straw
- Coarse sawdust
- Dried banana leaves
- Jute or burlap sacks
- Newspaper

Birthing

In a normal birth, piglets begin arriving within 30 minutes of the first labor signs. Normally, they are born at intervals of 10 to 15 minutes. All piglets are usually born within 3 hours. The placenta (afterbirth) should follow within 20 to 30 minutes.

Symptoms of Birthing Difficulties

- The sow makes an effort to expel the piglets, but no piglet will come out.

Cause

- Hard stool is putting pressure on the birth canal.
- Piglet is in an abnormal position.
- Sow is too fat and has a narrow birth canal.

Prevention

Ensuring that the animal is in good condition is the best way to avoid problems at farrowing time. (see the section on *Feed for pregnant Sows*)

What to Do If a Piglet is Stuck

If a piglet is stuck in the birth canal, you will have to help. First, trim your fingernails, wash your hands and arms well with soap

and apply a lubricant of vegetable oil. Gently slide your hand into the sow's vagina and feel for the piglet.

- If it is a large piglet, pull it gently but firmly in time with the sow's pushing.
- If the piglet is stuck sideways, push it back in and try to turn it so it comes out straight (head first or hind first).
- If you cannot correct the problem, call a professional (a local expert, respected healer or veterinarian).

Retained Placenta

Sometimes, the placenta will stay inside the sow after farrowing. If this happens you can try one of the simple treatments below. See also the section on Pregnancy and birthing in Ruminants for more remedies.

- Grind together 7 dry garlic cloves, 7 dry black pepper seeds, 7 slices (5mm thick) of fresh ginger rhizome and 7 upper leaflets of 7 cotton plants. Grind the ingredients together in 1/2 cup of whisky (do not strain) and give as a drench. If 1 drench does not work, repeat the treatment. **(Northern Thailand. 1, 2, 3, 4)**
- Grind 3 leaves of betel (Piper betle) and mix with 1 cup of water. Strain and give as a drench 1 time. If 1 drench does not produce results, drench again at 2- hour intervals. **(Cambodia. 1, 2, 3, 4)**

Care of Newborn

At birth, piglets are wet and covered in a thin mucous membrane. This membrane will dry and disappear very quickly. Most piglets will not need special attention from the farmer. However, sometimes they need help.

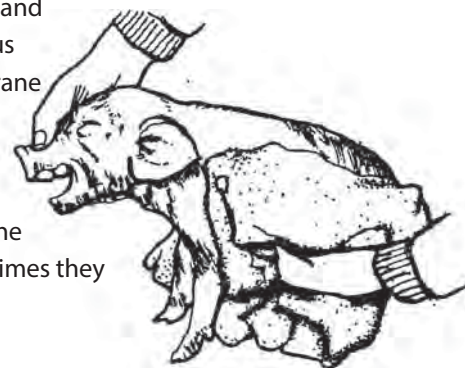

Newborn Piglets

A newborn piglet may appear lifeless. Here are some methods for reviving piglets:

- Clear the piglet's nose and mouth of mucus.
- Gently shake the piglet with head down to drain the mucus.
- Briskly rub a cloth up and down the piglet's back.
- Gently blow air into the piglet's nose; or hold the piglet on its back and gently and rhythmically pump the back legs forward and back until the piglet breathes.
- Dip the piglet into a bucket of water (this might shock it to life) and then rub it dry with a cloth.
- If a piglet is listless, cover it with a large cooking pot. This protects the piglet from drafts and helps the piglet retain its body heat.

When the piglet is born, the umbilical cord will hang from the animal. Within 2-3 days, it will dry and fall off (**Note:** it is recommended to treat the navel by applying iodine, wood ash or powdered limestone.)

Keeping Piglets Warm

It is very important to keep piglets warm. Here are some techniques for doing this:

- Rub the piglets with vegetable oil.
- Put newborn piglets in a box.
- Provide a heating lamp (if electricity is available).
- Use chopped, dry rice straw or dried banana leaves for bedding.
- Use empty jute sacks as bedding.
- Burn rice husks, straw or charcoal in a metal bucket to supply warmth.

0°Caution

- Long rice straw might tangle the piglets, causing them to fall under the sow and be crushed.
- Care must be taken to ensure that the bucket is properly placed so pigs are not burned.

Build a piglet warm-box from sheets of wood, making sure to leave an exit and a portion of the roof open. To provide warmth, hang a light bulb over the roof opening.

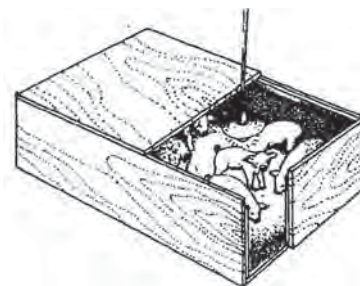

A piglet shelter can be constructed from wood and jute. Build a low, rectangular frame of wood and wrap it tight with jute.

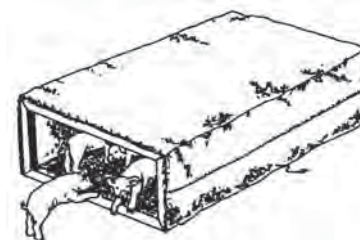

Avoiding Crushing Newborn Piglets

Newborn piglets can easily be crushed by their mother, until they learn to get out from under her when she lies down. The farrowing area should have barriers to prevent the sow from crushing the piglets. After the first two weeks, the barriers can be removed.

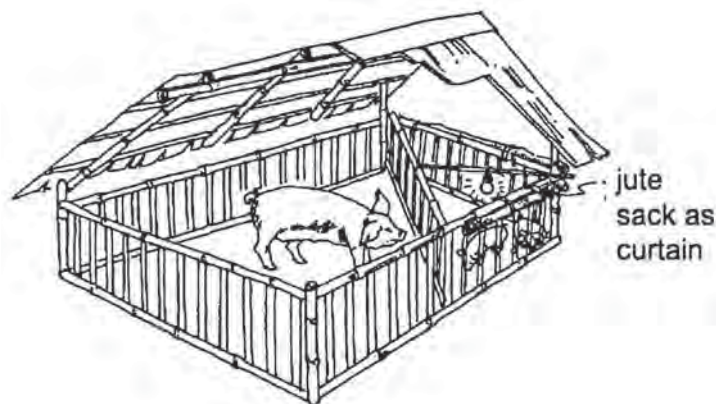

Getting Piglets to Suckle

Sows develop their own styles of nursing. Sometimes, they stand up; sometimes they lie on their side. After a day or two, each piglet will establish ownership of a teat. In a small litter, piglets

might share the extra teats. Weaker piglets get the hind teats. A sow might be able to raise more piglets than she has teats. But generally, it is better to take extra piglets away and place them with another recently farrowed sow (or raise the extra piglets on cow's milk).

Often, a sow will drive off or kill piglets that are not her own, but she can be fooled into accepting foster piglets. Rub the piglets and the nose of the foster sow with the urine of the foster sow or with vinegar. Also, keep the foster piglets in a box with the natural piglets of the sow so their smells will blend.

Reminder

Make sure the piglets get some colostrum (the first milk) from their natural mother before moving them to a foster mother.

Pig-feed Garden

Pig-feed gardening is the planting of rootcrops, vegetables, leguminous trees and non-conventional feedstuffs on a piece of land, approximately 200sqm. The garden can support 4-5 average-size pigs.

Recommended Plants for the Pig Feed Garden (PFG)

Plant	Parts used	Propagation
A. Protein sources		
Madre de cacao <i>Gliricidia sepium</i> ■ Kakawati (Tagalog)	Leaves, stems, flowers, young fruits	Seeds and cuttings
Ipil-ipil <i>Leucaena loucocephala</i>	Leaves, stems, flowers, young fruits	Seeds and cuttings
Cowpea <i>Visna sinensis</i> ■ Paayap (Tagalog)	Leaves, stems, flowers, young fruits	Seeds
Hyacinth bean <i>Dolichos lablab</i> ■ Bataw (Tagalog)	Leaves, stems, flowers, young fruits	Seeds
Cassava <i>Manihot esculenta</i> ■ Kamoteng Kahoy (Tagalog) ■ Balinghoy (Bicol)	Leaves	Cuttings
B. Energy sources		
Corn <i>Zea mays</i> ■ Mais (Tagalog)	Grain	Seeds
Cassava <i>Manihot esculenta</i> ■ Kamoteng Kahoy (Tagalog) ■ Balinghoy (Bicol)	Root	Cuttings
Sweet potato <i>Ipomea batatas</i> ■ Kamoteng	Root	Cuttings, Rootsprouts, root
Gabi <i>Colocasia esculenta</i>	Corm	Sucker, rhizomes, corms

Plant	Parts used	Propagation
Ubi (white) <i>Dioscorea alata</i> ▪ Ube (Tagalog)	Tuber	Sucker, tuber
Arrowroot <i>Maranta arudinacea</i> ▪ Oraro (Luzon, Visayas) ▪ Sago (Panay)	Root	Sucker, Rootbits
Tugui <i>Dioscorea esculenta</i> ▪ Tugui, tague (Luzon) ▪ Apali/Apari/	Tuber	Tuber
Buri <i>Coreypa alata</i>	Stem	Seed
Sorghum	Grains	Seed
C. Vitamin and mineral sources		
Malunggay <i>Moringa oleifera</i>	Leaves, stems, flowers, fruits	Seeds and cuttings
Amaranth <i>Amarantus spinosus</i> ▪ Urai (Ilokano) ▪ Kulitis (Bicol, Tagalog)	Leaves	Seeds
Sweet potato <i>Ipomoea batatas</i> ▪ Kamote	Leaves, vines	Cuttings, roots, roots prouts
Japanese malunggay <i>Sauropus androgeneru</i>	Leaves	Seeds, cutting
D. Water sources		
Sweet potato <i>Ipomoea batatas</i> ▪ Kamote	Leaves, stems, flowers	Cuttings, roots, roots prouts
Kangkong (aquatica) <i>Ipomoea aquatica</i>	Leaves, vines	Seeds and cuttings

Considerations:

1. Factors considered in the selection of plants are: availability nutritional content drought resistance disease resistance can be planted on a variety of soil perennial, annual plants
2. In areas where free water abounds, other feedstuffs like *Azolla*, Galiang (*Alocasia macrorrhiza*) and kangkong (lowland) can be planted. *Azolla* is high in protein (17-28 percent CP). Galiang is a good source of energy while kangkong is also a good source of water, vitamin and minerals.
3. Other non-conventional feedstuffs can be used as pig feed. (see table below)
 - d. Over-ripe fruits
 - e. snails (Golden kuhol)
5. Pig feed garden (PFG) provides a source of:
 - a. less expensive and locally available feed ingredients
 - b. nutritious and palatable feedstuffs
 - c. green manure
 - d. alternative medications for pigs and other animals
 - e. extra income for the farmers
 - f. nutritious food for the family
6. Management care
 - a. A fence should be provided around the garden.
 - b. Apply compost and green manure to fertilize crops.

Other Non-conventional Feedstuffs

Plant	Parts used	Propagation
Talinum <i>T. triangulare</i> ▪ Espinacas	Leaves, stems	Cuttings
Ulasiman <i>Portulaca</i>	Leaves, stems	Cuttings
Alugbati <i>Basella alba</i> ▪ Grana	Leaves, stems, flowers, fruits	Cuttings
Nami <i>Dioscorea hispida</i> ▪ Namo (Luzon) ▪ Kalut, Kurot, Kuwot (Visayas, Mindanao)	Tuber	Tuber
Pongapong <i>Amorphallus campanulatus</i> ▪ Bagong (Visayas)	Leaves, stems, corms	Cormels
Banana <i>Musa sp.</i> ▪ Saging (Tagalog) ▪ Batag (Bicol)	Stems, corms, body, leaves	Cormels

4. Kitchen left-overs can be added to improve the nutritional value of the feed. These are:
 - a. fish and rice washings
 - b. Egg shells
 - c. Fruit peelings
 - c. Provide drainage on waterlogged areas.
 - d. Plant insect-repellants.
 - e. Regularly weed and/or water the plants.
7. The PFG can start feeding pigs from 3 weeks to 3 months, depending on type of plants used.

8. Feeding value of some common feedstuffs is influenced to a certain extent by the way they are prepared for feeding.

Feed- stuff	Toxin	Preparation	Rationale
<ul style="list-style-type: none"> ▪ Cowpea ▪ Hyacinth bean 	Trypsin- inhibiting factor	Cooking	<ul style="list-style-type: none"> ▪ Nutritional availability of protein is increased.
			<ul style="list-style-type: none"> ▪ Destroys anti-enzyme that depresses growth.
<ul style="list-style-type: none"> ▪ Cassava 	Hydrocyanic acid	Washing	<ul style="list-style-type: none"> ▪ Toxic constituent is removed.
<ul style="list-style-type: none"> ▪ Gabi ▪ Tugui ▪ Ubi 	Calcium oxalate	Cooking	<ul style="list-style-type: none"> ▪ Palatability is improved because itchiness is removed.
<ul style="list-style-type: none"> ▪ Buri 		Pounding and drying of stem	<ul style="list-style-type: none"> ▪ Powder is collected.
<ul style="list-style-type: none"> ▪ Nami 	Dioscorine	Sliced, placed in sacks, soaked in free flowing water for 3 days. Once snails are seen clinging to the sack, it means toxic substance has been washed out and could then be used as feed.	<ul style="list-style-type: none"> ▪ To get rid of toxic substance
<ul style="list-style-type: none"> ▪ Snails 		Pounding	<ul style="list-style-type: none"> ▪ To improve palatability and digestibility of protein and calcium
<ul style="list-style-type: none"> ▪ Ponga 	Calcium oxalate	Cooking	<ul style="list-style-type: none"> ▪ To improve palatability

Land Preparation and Planting

Land area should be cleared of all weeds before the bed preparation and planting. The fence line can be utilized for planting annual and perennial plants like horseradish tree, hyacinth bean, cassava, *Gliricidia*, *Leucaena*, ubi and tugui. Bio-intensive gardening (BIG) can be adapted for planting the other crops for the pig-feed garden.

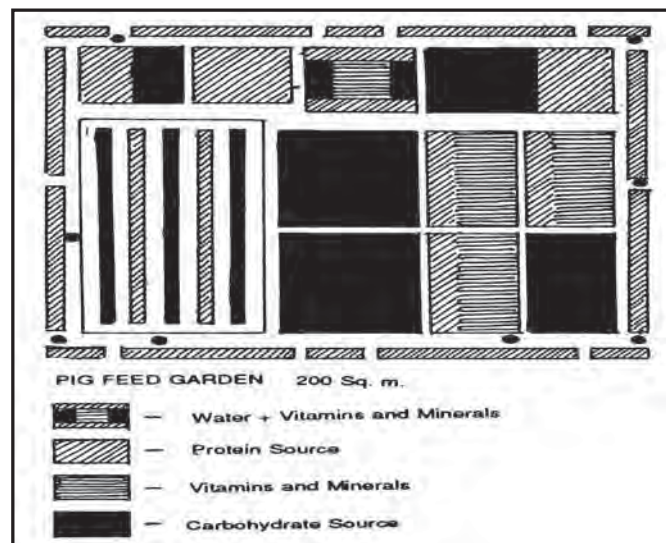

Source: IIRR and DENR. 1989. *Agro Forestry Technology Information Kit*, IIRR, Silang, Cavite, Philippines

Low-cost Hog Feed

Option 1

40 % Gabi leaves and stems and 20 % rice bran plus 10 % copra meal + 29 % Ipil-ipil mix malunggay leaves. Cooked and fed to pigs Plus Premix 0.5 percent and Salt 0.5 percent

Copra meal	10 kilos	10 kilos
Fishmeal	10 kilos	10 kilos
Soyabean or Payaap or Tapilan or mung bean	10 kilos	10 kilos
Quantity per day	1 kg	1.75 kgs PLUS
Sweet potato cooked	0.7 kilos	1.75 kilos
PLUS		
Fresh vine Sweet Potato	0.5 kilo	0.5 kilo

Option 2

5 Kilos camote roots and 5 kilos Ipil-ipil leaves
Rate 1-1.5 kilos per day : if less than 10 kilos animal weight
Rate 2 kilos per day: 20 to 40 kilos weight

If no fishmeal PREMIX mineral (3% only) and Salt 0.5 %

Option 3

Sweet potato tubers	20 percent
Gabi tubers	50 percent
Rice Bran	10 percent
Beans (patane, batao)	10 percent
Copra meal	10 percent
Premix Mineral	0.3percent
Salt	0.5 percent
Dried patane or batao or Kadios	10 percent

Option 5

Rice bran	30 kilos(20-30k pig),	28 kilos (30-60k pig)
Corn meal or Gabi dry/Chips	40 kilos	40 kilos
Cassava or Sweet Potato Meal	13 kilos	25 kilos
Soya/tapilan/payaap		
Mung	7 kilos	7 kilos
Quantity per day		
Basal feed	1-1.5 kilo	1.5 -1.8 kilo
Fresh sweet potato		
Vine cooked	1.5 kilos	2 kilos

Plus 0.3 percent Premix mineral if no Fishmeal, Soya bean etc.
Plus Salt 0.5 percent

Option 4

	Pig weight (20-30kilos)	Pig Weight (30-60kilos)
Cassava or Sweet potato (Dry chips or cooked)	40 kilos	45 kilos
Cassava leaf or ipil meal	10 kilos	10 kilos
Rice Bran	15 kilos	20 kilos

Feed twice a day. Don't overfeed. The pig must finish in 20 minutes after serving.

Copra has high fiber not good to feed too much. Cook roots and leaves before feeding.

Source: International Institute of Rural Reconstruction (IIRR). Silang, Cavite, Philippines.

Low-cost Hog Feeds

In spite of the availability of various kinds of commercial feed mixtures, hog raisers should be knowledgeable in compounding feeds. This would come in handy in case of shortage of feed supplies. More importantly, mixing can also produce practical and more economical formulations that will give optimum results.

Feeds constitute the largest chunk (estimated at 75-80%) of the total cost of production. It is most imperative, therefore, to reduce this cost—a simple program of feeding is recommended using feed ingredients that are inexpensive and locally available. Such feeds, however, should contain adequate quantities of the recommended nutrients necessary for the normal growth of the animals. These are protein, carbohydrates, fats, minerals and vitamins, plus water.



Listed below are a selection of easy to formulate rations for hog fattening:

Ration 1	Parts by Wt.
Rice bran	60kg
Yellow corn	10kg
Coconut (bagasse)	10kg
Leucaena leaf meal	5kg
Rice midlings	5kg
	<hr/>
	100kg
Crude Protein	<hr/> 12.881%

Ration 2	Parts by Wt.
Rice bran	80kg.
Japanese/Golden snail*	10kg.
Gabi tuber/cassava*	20kg.
Ground yellow corn	10kg.
Leucaena leaf meal	10kg.
	<hr/>
	100kgs.
Crude Protein	<hr/> 14.9175%

*These feed ingredients should be cooked first. Corn and rice middlings should be soaked overnight or cooked to facilitate digestion.

Ration 3	Parts by Wt.
Rice bran	40kg
Kitchen left over*	50kg
Leucaena leaf meal	10kg
	<hr/> 100kg
Crude Protein	<hr/> 14.822%

Ration 4	Parts by Wt.
Rice bran	80kg
Leucaena leaf meal	15kg
Rice middlings	5kg
	<hr/> 100kg
Crude Protein	<hr/> 14.9175%

Ration 5	Parts by Wt.
Rice bran	60kg
Swamp cabbage leaves or vegetable leaf left over*	30kg
Yellow corn	5kg
Coconut bagasse	5kg
	<hr/> 100kg
Crude Protein	<hr/> 9.96%

Ration 6	Parts by Wt.
Rice bran	80kg
Banana trunk (chopped finely)	30kg
Leucaena leaf meal	10kg
	<hr/> 100kg%
Crude Protein	<hr/> 10.591%

NOTE: Add the following to the above rations:

Salt	1kg
Ground oyster shell	2kg
Well-shifted kitchen ash	.25kg
Afsillin	200g (if available)

Other "non-conventional" feed ingredients that can be used as hog feeds.

Mollases	10 - 30%
Fish sauce	5%
Banana fruit	10 - 20%
Spoiled milk	
Papaya fruit	10 - 20%
Soybean (by-products)	10 - 30%
Shrimp heads*	5 - 10%
Camote leaves	20 - 30%
Wheat pollard	20 - 60%
Over ripe fruits in season	20 - 40%
Chicken offals*	5 - 10%

Source: Regenerative Agriculture Technologies (RAT) Kit. IIRR. Unicef for Philippine Department of Agriculture. 1989

*These feed ingredients should be cooked first. Corn and rice middlings should be soaked overnight or cooked to facilitate digestion.

Low-cost Goat Housing

Adequate housing provides conditions for good health and comfort of animals, high reproduction and more efficient management. Housing also minimizes, if not eliminates, theft problems. Good housing is ideally cheap, yet it can protect the animals from strong winds, draft, heavy rains, wet grounds and attacks by predatory animals. It must also be well-ventilated, well-drained and easy to clean.

Location

For good drainage, locate your goat house on a slight slope or on sandy soils; ideally, near the feed source. The goat house should be oriented in such a way that the greatest amount of sunshine and air enter the house.

Housing Specifications

Use indigenous materials available in the locality, such as round timber, bamboo and cogon or nipa.

1. Provide at least 15-20 sq. ft. of floor space per adult goat. A separate housing is provided for the buck.

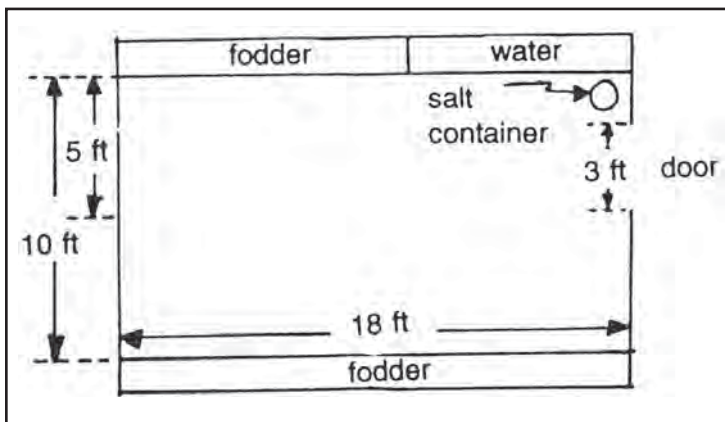

2. Raise the floor at least 3 feet above the ground to facilitate cleaning and removal of manure.
3. Do not nail the floor boards or slats closely; provide slits between the boards so that manure can fall through them. This will keep the flooring clean and dry.
4. The house should be well-ventilated. The wall around the house can be made of bamboo slats spaced 4-6 inches apart.
5. Provide a sack cover on the windside of the house. This can be rolled up when not needed.

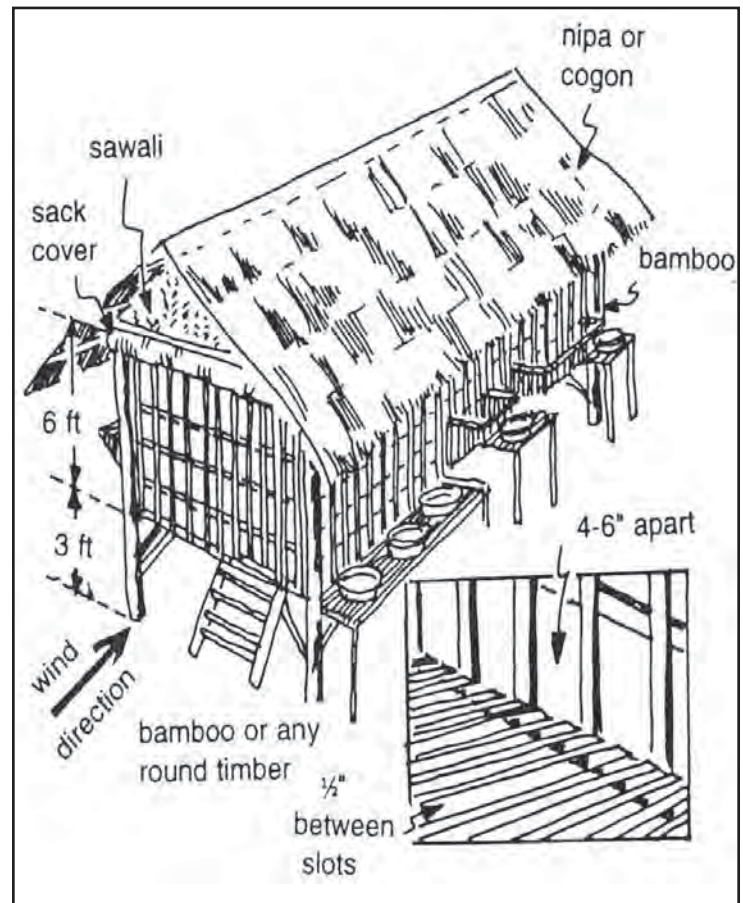

Note: For two does and one buck raised together, the size of the goat house will be 6' x 8'.

- **Ipil-ipil.** Remove bark. Soak timber in running water (river/stream) for 3 days to dissolve the carbohydrate content of the wood. Dry.
- **Bamboo.** Mix 1 part crude oil: 2 parts kerosene. Paint this mixture on the split bamboo and season (sun-dry) for 4-7 days. Bamboo is more durable when harvested at the right time (mature, light green or yellow in color). Cut before the onset of the growing season, before the young shoots appear.

Feeding Facilities

Provide the goat house with the following facilities:

1. **Fodder rack.** Elevate the feeder 1.5ft above the floor and attach it to the goat house from outside.
2. **Water container.** Plastic basins or pails can serve the purpose. Place this outside of the pen to avoid contamination with urine or manure.
3. **Salt container.** A bamboo tube with 2 or more slits at the bottom can serve as container for the ordinary table salt for the goats to lick. Hang the bamboo tube inside the house.
4. **Hay rack.** Store the fodder/forage in hay rack under a shade or shed adjacent to the goat house.

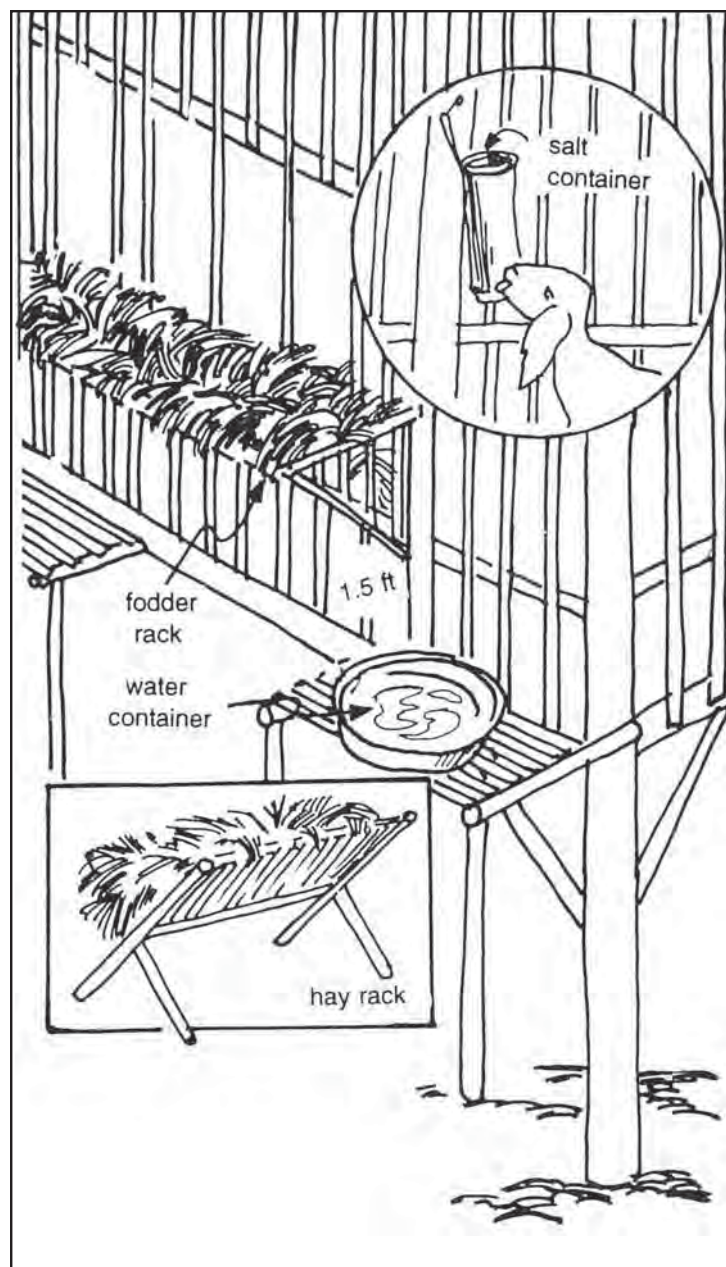

Source: IIRR and DENR. 1989. *Agroforestry technology information kit*. IIRR, Silang, Cavite, Philippines

Intensive Feed Garden

The following concept of an Intensive Feed Garden (IFG) was adapted and tested in the Philippines by the International Institute of Rural Reconstruction, based on a design originally developed by the International Livestock Centre for Africa in Ethiopia. IFG aims at maximizing the cultivation of fodder per hectare through intensive cultivation of leguminous trees/shrubs and grasses for a small area (10m x 20m). This technology is recommended in marginal areas or where there is scarcity of land, or where compound farming is practiced or where it is compulsory to confine livestock. It is appropriate where feed is scarce and not readily available on a cut-and-carry system.



Benefits from an Intensive Feed Garden

- Provides renewable and inexhaustible sources of nutritious and palatable fodder, fuel, timber and green manure.
- Curbs soil erosion, conserves soil moisture and increases soil fertility.
- Increases the productivity of a given piece of land by interplanting diverse species of fodder trees, shrubs and grasses.
- Provides a stable agricultural system for semi-arid tropics and drought-stricken areas and other adverse environment.
- Reduces danger of toxicity problems from noxious weeds and contaminated poisonous fodder.

Establishment

An intensive fodder garden is usually established on a small piece of land (10m x 20m). Larger plots may, however, be used, depending on the size of the herd in the humid tropics. One of the recommended designs of IFG (yield: 20 tons dry matter/ha) with legume trees, shrubs and grasses is illustrated below:

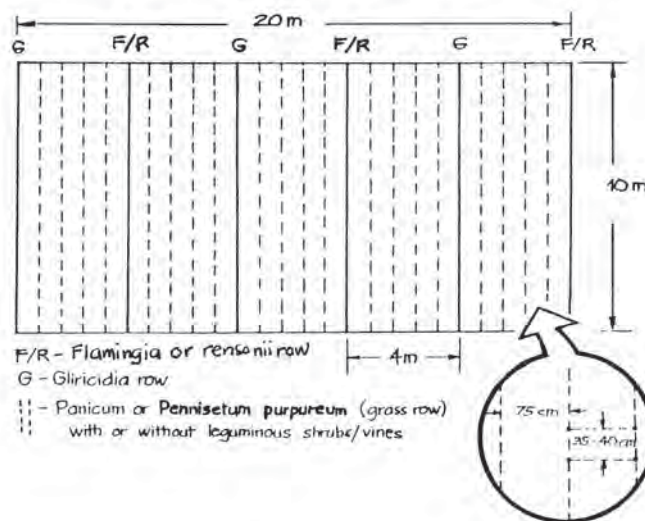

* Livestock Specialist, IIRR, Silang Cavite, Philippines

A spacing of four meters between rows of trees is maintained. The space between trees in the row is one meter. The grasses are spaced 75cm between rows and 30-40cm between hills.

This modification is established solely with legume trees to provide increased protein supplementation if the area has other available feed materials (e.g., cassava, tuber/peel). For such purposes, the legume trees may be planted at inter-row spacings of 1.0m with 25cm between stands (hills). This should be cut on a 10-12 week cycle for optimum productivity, while grasses and leguminous shrubs/vines are mature for cutting in six to eight weeks. More frequent cutting will reduce total productivity.

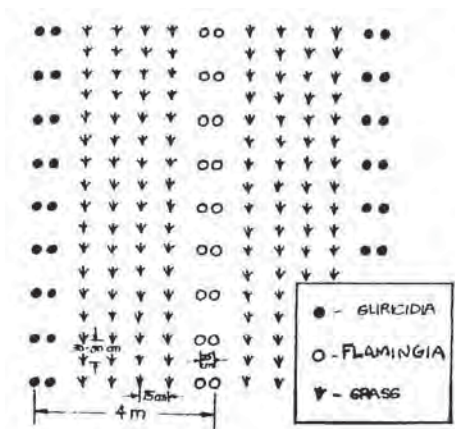

growing before planting so that they will have the ability to modulate and fix atmospheric nitrogen.

Fertilizer Requirements

On fertile land, fertilizer may not be necessary; however, on moderate to low fertility soils, decomposed animal manure could be incorporated in the soil at least two weeks before planting. If manure is not available, side dressing of 15-15-15 fertilizer (in the initial year of establishment only) at about 150 kg. per hectare (four to six weeks after planting) is done to boost initial growth of tree seedlings and forage grasses. After one to one-and-a-half year of establishment, the fertilizer requirements of the grasses can also be met by returning 50 percent to 70 percent of the cut leaves from the tree species back to the soil in the form of mulch. All the grasses and one-half to one-third of the tree leaves can then be used as animal feed. In such cases, the IFG area will have to be increased to meet the animal feed needs.

Management Suggestions

- Mulching along tree rows has been observed to be beneficial in the establishment of the fodder trees.
- Whenever possible, decomposed manure and feed refusals should be returned/applied to the garden. Cut leaves (50 percent to 70 percent of the production) can also be used to meet nutrient needs.
- In the absence of manure, fertilizer (15-15-15) should be applied at the rate 150 to 200kg/ha in two to three split applications per year in the initial first year. In the second year, tree leaves and/or manure will suffice.
- The grasses are mature for cutting in six to eight weeks, while fodder trees may require 8 to 12 weeks for the trees (depending on the season). Leave adequate leaf area to facilitate recovery. Forage trees should be cut at least one meter above the ground while grasses should be clipped close to the ground at 75cm. high to bring back the plants to a more productive stage.
- If possible, fence the forage garden so as to protect the

Land Preparation and Planting

The land should be cleared of all weeds before land preparation and planting. Since forage grass (*Panicum*) seeds are small, they require a fine seedbed. If vegetative planting materials are used, a rough seedbed is tolerated. *Flamengia*, *Renssoni* and *Gliricidia* can be planted either on a flat or ridged land and must be planted ahead of the forage grass to minimize shading for the first six to six weeks. Forage trees may be planted by direct seeding or by seedlings previously raised in a nursery. Direct seeding is easier, cheaper and feasible in areas where annual rainfall is 1,200mm or more with a minimum growing season of about 200 days. Planting by seedlings is recommended at the start of the rainy season. If irrigation is available, planting can be done anytime of the year. The ideal depth of planting should be about 2.0cm, with two to three seeds per hill, four to six weeks after planting. In drier environments, one seedling per hill is desirable. Seed covers should be scarified with hot water treatment. Seeds should be inoculated with soil from areas where the trees are already

area from stray animals that may trample on the plants or eat the young shoots.

- Feeding of the two species in roughly equal quantities in addition to any available feeds: *Leucaena* should constitute up to 40 percent without toxicity problems while *Gliricidia* and *Flamengia* can be offered up to 100 percent of total feed intake. However, if the smell of *Gliricidia* is not acceptable to the animals, allowing the leaves to dry for a couple of hours after cutting will improve palatability and increase the intake.
- Practice soilage or zero grazing, where herbage is cut and carried to the animals. The intensive feed garden could support more animals per hectare since there are no losses from fouling and trampling.
- Weed control is essential for successful crop production since weeds reduce forage production in an intensive feed garden area.
- In the first year, intensive feed garden production in a plot

measuring 200 square meters would be sufficient to supply 25 percent of the daily intake of 3.6 small ruminants (goats or sheep). Foliage yields 9.85 to 20 tons dry matter/ha with three rows, four meters apart interplanted with four rows of grass in each alley (with crude protein if 493 kg dry matter/ha). (Reynolds and Abba-Krah 1986). It is expected that in the second and following years, the IFG will be more productive. The area under the feed garden can be increased beyond the 200 square-meter area if more animals are being maintained on the farm. (To maintain a cattle fattener, there is a need to develop 400 meters of intensive feed garden area).



List of recommended fodder trees, grasses and legumes

Fodder Trees

<i>Gliricidia sepium</i>	Madre de Cacao	Seeds, Seedlings, Stem cuttings
<i>Leucaena leucocephala</i>	Ipil-ipil	Seeds, Seedlings
<i>Cajanus cajan</i>	Kadios	Seed, Seedlings
<i>Sesbania grandiflora</i>	Sesbania	Seeds
<i>Cassia siamea</i>		

Grasses

<i>Pennisetum purpureum</i>	Napier or Elephant grass	Seeds, Stem cuttings
<i>Panicum maximum</i>	Guinea grass	Seeds, Root stocks
<i>Brachiaria mutica</i>	Para grass	Seeds, Stem cuttings
<i>Cynodon plectostachyus</i>	African star grass	Seeds, Stem cuttings
<i>Digitaria decumbens</i>	Pangola grass	Seeds, Stolons
<i>Pennisetum clandestinum</i>	Kikuyu	Seeds, Rhizomes
<i>Dicanthium aristatum</i>	Alabang	Seeds, Root stocks, Stem cuttings
<i>Brachiaria decumbens</i>	Signal grass	
<i>Chloris gayana</i>	Rhodes grass	Seeds, Root stocks
		Seeds, Root stocks



Source: IIRR.1990, Resource Book on Sustainable Agriculture for the Uplands, IIRR, Silang, Cavite, Philippines

On-farm Fodder Sources in Agroforestry (Trees and Grasses)

Livestock production in most upland communities in the Philippines is concentrated in small farms. Around 90 percent of ruminants and 70 percent of non-ruminants are raised in small farms. Livestock provides draft power to different farm operations, transportation, food, additional income and manure for organic fertilizer.

Farm animals are mainly fed with the available fodder/forage within the farm. The fodder used by the farmers may be in the form of fresh or dried plant parts such as leaves and stalks/straws.

Natural Grass/weeds

One of the common sources of fodder for livestock in the uplands for cut and carry, tethering and grazing feeding systems are either natural growing or cultivated grasses.

Natural grass/weeds

Scientific name	Official common name
<i>Rottboellia exaltata</i>	Aguingay
<i>Imperata cylindrica</i>	Cogon
<i>Saccharum spontaneum</i>	Talahib
<i>Chrysopogon aciculatus</i>	Amorseko
<i>Paspalum conjugatum</i>	Kulape
<i>Panicum stagninum</i>	Bungalon
<i>Pennisetum purpureum</i>	Napier grass
<i>Panicum maximum</i>	Guinea grass
<i>Panicum purpurascens</i>	Para grass
<i>Dicanthium aristatum</i>	Atabang

Fodder Trees/shrubs

Fodder from trees and shrubs that are available in the farm provides nutritious and palatable feeds for livestock which can also supplement other forage grasses.

Fodder trees/shrubs

Scientific name	Official common name
<i>Gliricidia sepium</i>	Madre de cacao, kakawate
<i>Leucaena leucocephala</i>	Ipil-ipil
<i>Calliandra calothyrsus</i>	Calliandra
<i>Flemingia macrophylla</i>	Flemingia
<i>Desmodium rensonii</i>	Rensoni
<i>Piliostigma malabancum</i>	Alibangbang
<i>Sesbania grandiflora</i>	Katurai
<i>Cajanus cajan</i>	Kadyos

Other Fodder Sources

One of the most important feeds in small farms is the residue of various crops grown in the cropping systems. The most common residues are corn fodder/stover, rice straw, sugarcane tops and stem and leaves of leguminous crops.

Corn fodder

It is grown mainly as forage for livestock. It may be harvested after the ears have appeared, although not yet fully developed. The whole plant is fed to animals. Its palatability and nutritive value excel those of other soiling crops. The best condition for feeding is when the plant tassel and ears are in the glazing stage. Corn silage has a wide nutritive value. It should be supplemented with nitrogenous feeds to balance the ratio.

Corn stover

It is a dried roughage that can be stored for livestock fodder. It is the portion of the corn plant left after the ears have been removed at harvest. The whole plant is air-dried in the field, then the stalks are cut and stored as feed. Corn stover is rich in carbohydrates and is very useful in maintaining the condition of work animals during the dry season. Corn stover should be protected from rain; otherwise, it will be affected by mildew and will disintegrate, making it unfit for feed. To make it more palatable, sprinkle salt over it. Dry corn stover must be stored in a roofed animal shed or barn.

Sugarcane tops

Sugarcane tops can be used as fodder whether green or dried. It is relished by carabaos and cattle. It contains a large amount of digestible carbohydrates in sugar form.

Rice straw

Rice straw is eaten by carabao and cattle if other feeds are not available particularly during the dry season. To make it palatable, a small amount of salt is sprinkled over the feedstock. Dried rice straw may be stored in a cone-shaped stacked called mandala supported by a bamboo pole, firmly anchored to the ground in

an open field without the danger of deterioration. The upper layer serves to protect the lower layer from getting wet. The straw should be stored when fairly dry or else, if wet, it will generate heat that will spoil its wholesomeness as fodder. The straw stack should be located on an elevated portion of the farm near the animal shed.

Leguminous Dual-purpose Crop Residue

The leguminous residues of dual purpose crops such as cowpea, soybean, mung bean, bush sitao and batao have protein content of about 12 percent or more. The stem and leaves are good supplements to improve the feeding value of other on-farm fodder, especially during the dry season when feeds are very limited. They can also be fed to the livestock as soon as they are harvested without waiting for them to dry. Leguminous crop residues are seasonal and storage is one of the major problems. However, production in dry season makes sun-drying practical. Farmers only need to be taught to store and/or protect them from rain.

The Large Leafed Mulberry:

A Promising Nutritive Fodder For Scarcity Period

The sporadic use of the local small-leaved mulberry “kimbu” as fodder is common in the hills of Nepal. In a particular area of Dhankuta, however, farmers have adopted a large-leaved local mulberry as fodder for feeding during the period of fodder scarcity and have also begun planting many trees.

Mulberry Species

The generic name of mulberry is *Morus*. Several local species have been identified and there are also several introduced species. Local species are *Morus serrata* (illustration), *M. australis*, *M. alba* and *M. macroma*.

The local name of the large-leaved mulberry located in the Dhankuta-Kagate-Hile area is *Ilchiro*. Its botanical name has still to be determined.

Mulberry can be planted from the Terai to 7,000 feet elevation.

Advantages

Compared to the other mulberry species, the leaves of *Ilchiro* are large, averaging 6” wide and 8” long. The number of leaves per stem is high as well. Yield is estimated as being 40-50 kg/year from a well-grown tree. It comes into flush in February and can be fed from March until November as it is non-toxic during the flush period. It has a high crude protein content, ranging from 14-20%. It is highly palatable, including the bark, and can be fed to buffaloes, cattle, goats, sheep and pigs.

Traditional Local Method of Propagating *Ilchiro*

Farmers generally prefer to cut large branches, 2-3 years old at the start of the monsoon and plant them in-situ. This eliminated



the need for protection of new plantings as the upper parts are already above the reach of animals.

Branches used for cuttings can be as long as 12 feet of which at least 2 feet is inserted into the soil. This method has one drawback: it requires a lot of planting materials to obtain one plant.

Need for Planting Materials

Although other species of mulberry are widespread in the hills, this particular species is confined to a specific area. Introduction to new areas requires establishing cutting nurseries at several locations to eliminate the need for transporting large number of cuttings at some cost. To achieve this, a package of practices had been developed which includes the initial supply of potted seedlings and dissemination of knowledge and skills related to propagation from cuttings, including the stool bed technique, to ensure a continuous supply of cuttings.

Source: Regenerative Agriculture Technologies (RAT) Kit. IIRR UNICEF for Philippine Department of Agriculture. 1989.

Backyard Poultry Project Using Compost Litter System

With the high cost of producing imported breeds of birds for meat and eggs, the current trend for farm households is to revive the traditional family backyard poultry project using local and upgraded birds. These local breeds survive the adverse conditions found in the rural areas. By using improved feeds and management practices, these local and upgraded birds can provide at least 130-200 eggs and extra poultry meat throughout the year for the family. These birds can be allowed to search for feed on the range or in confinement using a low-cost poultry compost litter system, practiced by some farmers in Cavite, Philippines. This system can sustain 6 hens and 1 rooster or 3 hens, 30 chicks and 1 rooster for at least 3 - 4 months. The compost litter is then removed and used as organic fertilizer and a new batch of farmyard manure is added. Production of a small flock in the backyard can help fill the family food requirements for eggs and meat, provide extra family income and utilize the manure as an excellent organic fertilizer.

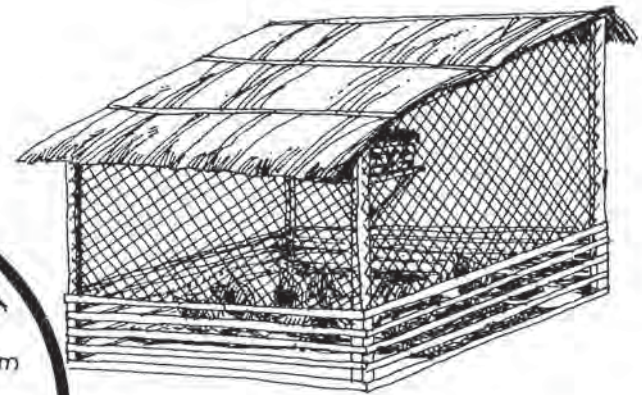
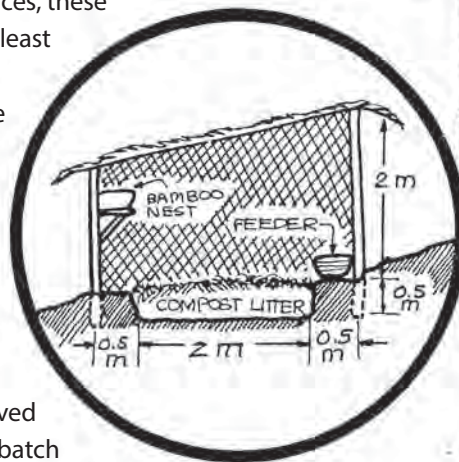

Housing Requirements:

Construct the house using local materials to minimize expenses, (cogon/nipa for roof, bamboo or used fish nets for siding and ipil-ipil/madre de cacao as posts). The house should be located in a dry, well-drained area. Perch racks, roosts, nests, feed hoppers and waterers made of low-cost materials should also be provided.

The house should not be less than 2.0m in height with a floor area of 3m x 3m. The house should be fenced; or if the hens are raised with chicks, they can be raised in a separate open house. Before constructing the house, dig a pit in the floor 1/2m deep, extending the length of the house 3m and 2m wide. Once the building is completed, the pit should be filled with fresh manure of cattle, carabao or goat. Keep the manure moist for one week (to encourage the growth of worms and maggots as feed for the chickens) and then place the upgraded/native birds in the poultry

Breeds and Breeding:

The farm family should properly select an upgraded rooster (Cantonese, New Hampshire, Plymouth Rock breeds) and hens/layers. Other poultry birds, like Muscovy duck, native or Pateros ducks, Peking duck, geese and pigeons are hardy and can also be raised under backyard conditions. They do not require elaborate housing and can subsist on inexpensive feeds.

house. While scratching the ground, the birds will be eating as well as hastening the composting process.

Feeds and Feeding:

The family should provide extra feed supplements, like kitchen refuse, fish entrails, corn/sorghum, ipil-ipil leaves and others.

Clean, potable water should be always available.

Home-made Chicken Ration

- 4 parts yellow corn, broken rice (binlid) or sorghum. Boiled gabi, fresh ubi, camote or cassava (bitter type should be boiled) can also be substituted.

- 1.5 parts rice bran (darak), dried *Azolla* or filter cake (from sugar mills) can replace rice bran.
- 1 part dried fishmeal or 2 parts fresh fish/golden snail
- 1.5 parts copra/oil meal
- 0.5 part ground sitao/mongo (mung)/patani (lima bean)/soybean/kadios (pigeon pea) seeds
- 0.5 part dried ipil-ipil leaves
- 1 tbsp salt
- 1 handful powdered oyster shell/agricultural lime

Note: Double the recommended amounts if ingredients are not in dry form.

How to Raise Ducks

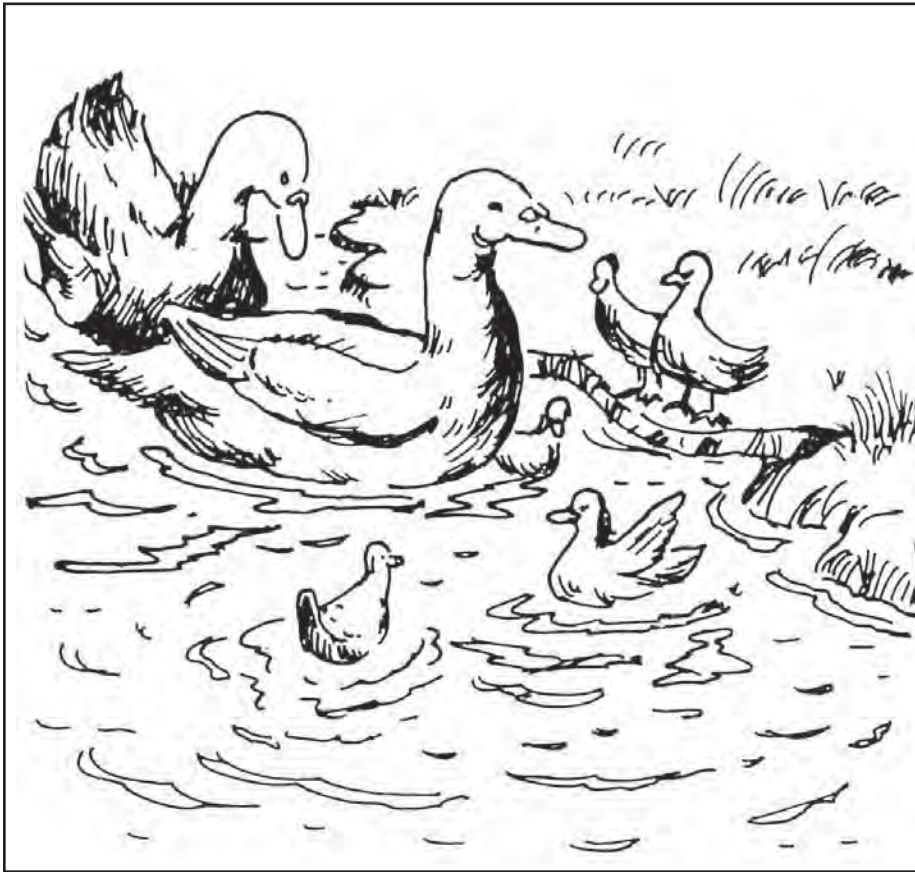

1. Buy your breeding stock from reliable duck raisers. The Pateros duck (native duck) is good for egg production and the Peking duck is good both for meat and egg purposes. You can also raise Muscovy duck or Pato. Muscovy has low egg production but is more self-sustaining than the Pateros and Peking ducks.
2. Build your duck house in a quite, cool place and near as possible to a stream or pond. Local materials like bamboo, nipa and cogon are cool and cheap.
3. Provide each duck with at least 3-4 square feet of floor space. The floor should be covered with either rice hulls, corn cobs, peanut hulls or similar materials to make it dry and clean; and to help prevent the spread of pests and diseases.
4. You can provide a swimming pond for the ducks if you wish. One of 10 feet wide and 20 feet long is adequate for 50 birds. However, a pond is not really necessary in duck raising. The ducks can lay just as many eggs without it.
5. Pateros ducks start laying when they are about 4-6 months old. Peking and Muscovy ducks start laying at about 6-7 months old. In breeding, you need male for every five female ducks. Select breeders that are healthy, vigorous and without defects.
6. Ducklings need to be brooded or warmed until they are a month old.
 - a. The temperature required for brooding is 95°F for the first week, 90°F for the second week, 85°F for the third week and 80°F for the last week.
 - b. The behavior of the ducklings is a good indicator whether brooding temperature is correct. The ducklings huddle close together toward the source of heat when temperature is low; scattered or spread evenly when the temperature is correct; but planting and moving away from the source of heat when the temperature is too hot.
 - c. A good brooding area is at least 1/2 square foot per duckling during the first week. The area should be increased by about 1/2 square foot every week until the fourth week.
 - d. When your ducklings show signs of sickness, add three tablespoons of Nexal for every gallon of water for 2-3 days.

- Skip or withdraw after 3 days. Then continue for another 3 days. Terramycin poultry formula can also be used. Follow the instructions on the package carefully.
- e. In order to prevent Avian Pest Disease, immunize your ducks with Avian Pest Vaccine which can be obtained free from the Bureau of Animal Industry (BAD).
 - f. Sex your ducklings. If you desire to fatten the extra males, then grow them separately from the females.
 - g. When ducklings are six weeks old, they can be transferred from the brooder to the growing house.
 - h. Transfer the layers to the laying house when they are four months old.
7. Feed your ducks the right kind of feed.
- a. 1-day to 6-week-old ducklings should be fed with starter mash with 10-21 percent crude protein.
 - b. 6-week-old to 4-month old ducklings should be fed with growing mash with at least 16 percent crude protein.
 - c. 4-month-old ducks and above should be fed with laying ration with at least 16 percent crude protein.
 - d. Commercial feeds are good for your ducks. However, if you want to mix your own feed, here is a formula for a practical general purpose ration:
- e. Also, feed plenty of chopped green leaves of either kangkong, comfrey, camote, ipil-ipil and legumes as additional feed. Give at least 10 grams of chopped green leaves per duck per day.
 - f. You can grow and feed fresh water snails to your ducks. Giving one gallon of fresh snails a day to 24 duck layers will help increase egg production.
 - g. Provide your ducks plenty of clean fresh water all the time.
8. If you provide a swimming pond for your ducks, limit their playing in the water to 1-2 hours a day. Too much playing in the water will tire your ducks and make them eat more feeds.
9. Do not allow your ducks to get wet under the rain because they may get sick.
10. Pateros ducks should weigh about 2.5kgs at 6 months. They should lay about 250-280 eggs in one year. On the other hand, Peking should weigh about 3.5-4kgs at 6 months old and lay about 180-200 eggs in a year.
11. You may start growing your replacement ducks when your layers are in their second year of laying. Dispose of your pool layers and retain the good ones.

Ingredients

First class rice bran (darak)	55 kilograms
Ground corn or binlid	20 kilograms
Shrimps or snails	25 kilograms
Wood ash or ground charcoal	1.5 kilograms
Ordinary table salt	250 grams
Ground limestone or shells	250 grams
Afsillin or Aurofac	250 grams

This general purpose ration may be fed to your ducks of any age.

12. Duck eggs and meat are as nutritious as chickens. Eat plenty of duck eggs and meat, they are good for you and your family.

Source: IIRR and DENR. 1989. Agroforestry technology information kit. IIRR, Silang, Cavite, Philippines

Backyard Duck Raising for Meat and Eggs

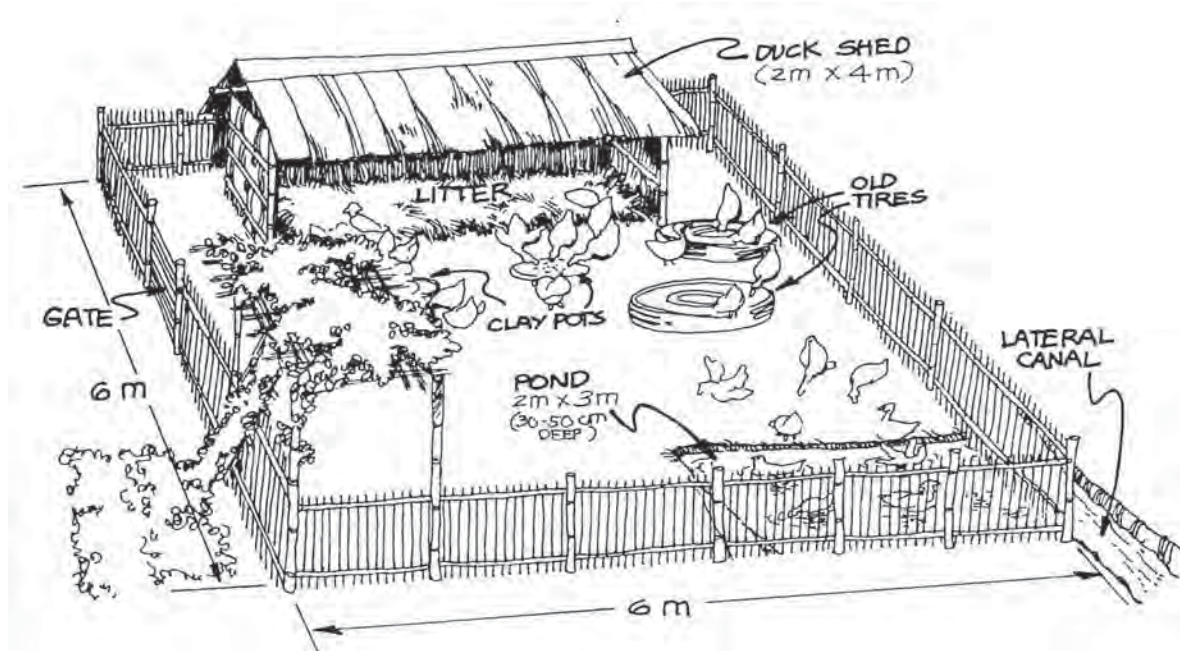

Why Raise Ducks?

- Ducks are one of the most practical, versatile and useful waterfowls to raise. Duck raising offers several benefits:
- Ducks are efficient producers of animal protein.
- Ducks provide both eggs and meat, for consumption or for sale.
- Ducks require limited space, simple shelter and minimal care.
- Ducks are resistant to diseases and thrive in harsh conditions.
- Ducks control harmful insects, unwanted aquatic weeds and golden snails.
- Duck manure is an excellent organic fertilizer.
- Ducks eat aquatic plants, grasses, vegetable trimmings, golden snails, insects and farm by-products. Thus, providing feed is not a problem.

What Breed to Raise for Meat and Eggs:

The Muscovy is a multipurpose breed for meat and eggs. The most popular Muscovy ducks raised are the white and black types. They lay from 80-120 eggs/yr and produce an excellent quality meat.

The Khaki Campbell breed is more efficient for egg production as compared to other breeds. A single duck is capable of producing 250-350 eggs/yr.

Housing Requirements:

Since ducks are small, a simple shed with one open side can provide adequate shelter. A 1 1/2m x 5m x 1m high shelter can

accommodate 40-50 adult ducks. To prevent the ducks from destroying vegetables and other crops, they should be confined in a fenced structure made from locally available materials. Farm litter (e.g., rice straw) should be placed in the shed for laying and brooding purposes.

Starting a Backyard Project:

A beginner can start with 7 ducks - one male (drake) and six female (ducklets). It is preferable to acquire ducks that are from 1-2 years of age.

Feeds and Feeding:

Muscovy ducks are voracious eaters and eat practically anything they are fed. For maximum growth, ducks should be fed with natural, local feeds such as empty grains (rice), rice and corn bran, ipil-ipil leaves, golden snails, duck weed, *Azolla*, banana trunks, worms, etc. They should be fed three times a day and provided with fresh water always. Used tires or old cookings utensils can be used for waterers and feeders. Twenty-five ducks can be raised in a 1-hectare farm using on-farm feeds without commercial feeds.

Health Management:

To prevent a disease outbreak, animals should be regularly vaccinated against common diseases (e.g., Newcastle, Fowl Pox or Fowl Cholera). Deworming and other health care practices, such as proper sanitation, correct feeding and proper care and management, must be strictly implemented to ensure a disease-free flock. New birds introduced into a flock should be quarantined to ensure that they are disease-free. Sick birds should also be isolated from healthy stock during treatment.

Other Management Practices:

Hatching

Ducks start to lay eggs after reaching 6 months of age. One medium-size duck is capable of hatching 12-15 eggs during the 30-33 day incubation period. Layers are usually productive from 12-18 months. At the end of that production period, layers should be culled and eaten or sold.

The fertility of eggs can be determined using a simple technique known as candling. Eggs should be candled (on the 15th day of incubation) in a dark room using a candle, lamp or flashlight. Fertile eggs reveal a small dark spot with a network of blood vessels branching out from it or the eggs appear dark. Infertile eggs are clear with the yolk appearing as a floating shadow. Do not throw away infertile eggs; they are delicious as well as nutritious and can be eaten or processed into salted or hard-boiled eggs to be sold for extra income.

Duckling Rearing

Young ducklings must be kept warm and dry. It is best to keep them out of water until they are 2 weeks old. However, they must have a constant supply of fresh drinking water. The ducklings should be fed fine rice bran and boiled rice. Cracked corn or rice should be fed to them after they are several weeks old. It is very important to protect the ducklings from predators such as cats, dogs, rodents, birds, etc. One method of protecting the ducklings is to confine the hen and her brood in a covered pen each night until the ducklings are 6-8 weeks old.

Marketing

Meat-type birds are ready to be slaughtered, dressed and marketed at 5-6 months of age.

Duck Management within a Rice System:

Two pen/shelter design options are presented here:

The duck pen and shelter is constructed over the irrigation canal. The floor is made of bamboo slats spaced so as to allow the droppings to fall into the water below, but not to trap and injure the ducks' feet. The floor should slope slightly to allow the eggs to collect on one side of the pen, thus facilitating daily egg collection. This design allows the duck droppings to fall directly into the water and be carried to the rice paddies through the irrigation canal. One disadvantage to this design, however, is the possible danger of housing the ducks directly over the water during colder times of the year.

The other design places the shelter near, but not over, the irrigation canal. Cover the floor with 4-6 inches of dry bedding material i.e., rice straw. Remove the old bedding materials weekly and place them in a compost pit for future incorporation into the rice paddies as fertilizer.



Ducks should be given adequate time to forage for their food. The ducks should be released from their house in the morning after they have laid their eggs (about 7:00 a.m.). The most important consideration is that the ducks be released at the same time every morning. If they are released at different times every day, the change can upset them, causing them to stop laying eggs and even begin to molt. They should be herded back to the pen about 5:30 in the afternoon. Giving them some feeds regularly at this time also trains them to return to their pen.

Ducks should be released onto the rice fields only at certain times:

- During plowing and harrowing
- After the tillering stage, but not during the flowering and heading stage of the rice crop
- After the rice has been harvested and threshed.

When it is not possible to release the ducks into the rice field, they should be taken to an area where no crops are grown. If no such area is available, the ducks can be fed in confinement.

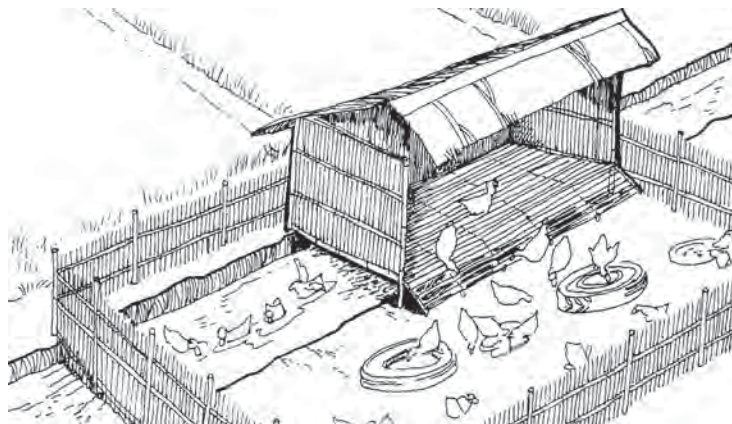

Care and Management of Mini-ponds

The secret of success in growing fish in mini-ponds is proper care of the fish and management of the pond. Good pond management and care of the fish means faster growth and more fish for the family. The major points to remember are the following:

1. Pond construction

- Establish the mini-pond near a water source such as streams, springs, irrigation canals or manually operated pumps (pitcher pump), etc., which is free from flooding and with good drainage.
- The soil at the bottom and side of the mini-pond must be well packed to minimize seepage. If the soil is sandy or porous, line it with a mixture of carabao or cow dung, clay soil and cement.
- Plant grasses on the banks to prevent soil erosion. Grasses that grow fast and spread rapidly are ideal for this purpose.
- Put screens on the inlet and overflow pipes to prevent the entrance of predators and at the same time to keep the fish from escaping.

2. Water quality, depth and temperature

- Water is of vital importance in raising fish. Always make sure that it is free from toxic substances, of the right temperature and the proper volume (depth). However, the warm-water fish do not require a constant supply of a large volume of fresh water. Most freshwater fish can be raised with water temperature ranging from 20°C - 40°C.
- The ideal water temperature ranges from 25°C - 30°C. In order to maintain the right temperature, plant leguminous trees like ipil-ipil (*Leucaena leucocephala*), katuray (*Sesbania grandiflora*), madre de cacao (*Gliricidia sepium*) and Dapdap (*Erythina*) on two sides of the mini-pond, about 1.5m - 2m from the bank. Orient the planting of trees on the east-west direction to allow enough sunlight into the pond.



The leaf litter also serves to improve aquatic life.

- Occasionally, the water in the pond becomes turbid and muddy. To check the turbidity of water. Apply lime at the rate of 1tbsp/sqm. Dissolve the lime water and sprinkle it over the pond.
- Maintain water depth at 1m so that the sun's rays can penetrate the water and induce the growth of plankton (natural fish food). Production of plankton decreases as water depth increases. In shallow water (.5m), the

water temperature easily gets high during summer. High temperature retards fish growth.

- Avoid letting the water out from the pond to prevent the fertilizers and plankton from flowing out.
- Drain the pond once a year. Keep it dry for a period of 2-3 weeks to aerate the soil.

3. Pond fertilization

- The production of algae and microorganisms in the mini-pond is the most important task for the low-cost production of fish. Fertilize the pond at least twice a month for the water to remain greenish. Green color indicates that the water has plenty of small plants and microorganisms which serve as nutritious food for the fish.
- Any kind of animal manure can be used. However, chicken manure makes a better fertilizer. Apply .5-1kg chicken manure. The manure can be placed directly in one corner of the pond or put in a burlap sack and submerged 20cm below the water surface. Never broadcast the manure on the surface as this, in turn, will reduce sunlight entry into the water, resulting in poor plankton growth.
- Dried leaves of leguminous trees can also be used to fertilize the pond. Put the leaves in porous bags and submerge in water 20cm below the surface. One to two sacks of dried leaves can help fertilize the mini-pond. Dried rice straw can also be dumped directly in one corner of the pond. Occasional broadcasting of green leaves of leguminous trees (small-leaf varieties such as *Calliandra*, *Leucaena*, etc.) is also very helpful and promotes aquatic life.



- If a combination of organic and inorganic fertilizer is desired, 500g of organic fertilizer and 10g of inorganic fertilizer (preferably urea or 16-20-0)/m water can be applied to produce good results.
- On soils or water that are acidic, lime must be added. It can be broadcast on the bottom of the pond or put in a porous bag. Tie the bag to prevent it from submerging into the bottom of the pond. If lime is not available, it can be substituted by aged wood ash (not fresh ash or ash from paper).

4. Fingerlings

- Stock only high-quality fingerlings. Secure your fingerlings from reliable hatcheries.

5. Feeds and feeding

- For faster growth, fish should be given supplemental feeds. A diet consisting of 20-30% ground ipil-ipil leaves or *Azolla* and 70-80% fine rice bran is recommended.
- When affordable, supplemental feeding of 100% fine rice bran is still the most economical (when natural food plankton in the mini-pond is abundant).
- Feed the fish twice a day, morning and afternoon.
- For a more efficient feeding, mash the feeds and place in a feeding tray made of fish net.
- The fish can also be fed with green leaves of kangkong, sweet potato, *Azolla*, kitchen left-overs, boiled sweet potato, cassava, gabi, crushed golden snails and white ants (termites).
- Surplus tilapia fingerlings (fresh) can be crushed and mixed with fine rice bran. This diet is very nutritious.
- Other cheap methods of feeding fish are:

Hanging a lighted lamp over the center of the pond. At night, insects are attracted to the light and hover around it. The insects will fall into the pond where the fish can eat them. Feeding the fish with maggots (small worms). To produce maggots, hang pieces of meat or dead animals on a pole 2-3ft above the water surface. Flies and other insects will lay their eggs

on the meat or dead animals. After 2-3 days, maggots will come out and fall into the water.

6. Control of overpopulation

Overpopulation of fish is one of the problems in raising fish (tilapia) in mini-ponds. To obtain good yields of harvestable or marketable size of fish, population control is necessary. Any of the following methods may be used:

- Scooping the fry with a fine net early in the morning and late in the afternoon. The fries swim at the edges of the pond at this time of the day.
- Introducing predators into the pond such as mudfish (dalag) and catfish (hito) at 2% of the total stocking rate. To prevent predators from preying on the original stock,

the size of the predators must be smaller than the original stock and should weigh less than one gram.

7. Harvesting

- After 4-5 months, the bigger fish can already be harvested. Catch them with a hook and line using earthworms or golden snails as bait or use a sweep net.
- Harvest only enough fish for the family to consume.
- To ensure a continuous supply of fish for the family, replace the number of fish harvested immediately by collecting fingerlings from the breeding/hatchery pond.

Mini-pond for Water-limited Areas

- Supplies fish as a cheap source of protein for the family
- Provides supplementary income, if there is a surplus of fish
- Provides opportunities for the family to raise fish food right in their backyard or in the farm
- Saves space
- Utilizes kitchen left-overs and animal manure
- Provides readily available food, free from red tide.
- Provides recreation for the family by watching while feeding and catching with hook and line

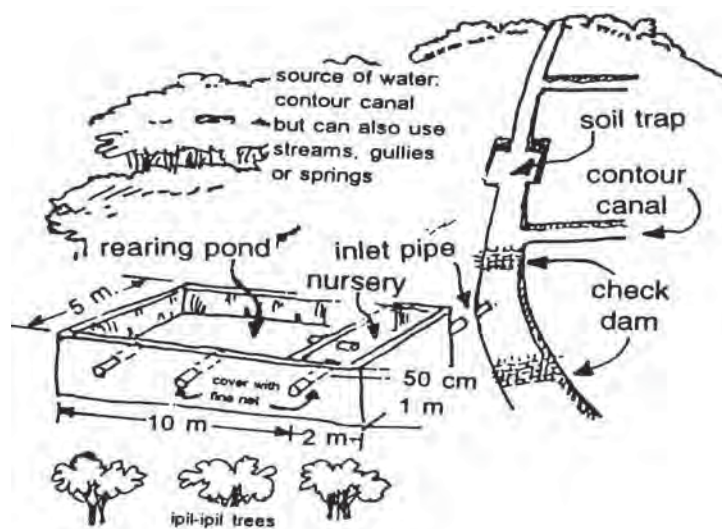

Pond Construction

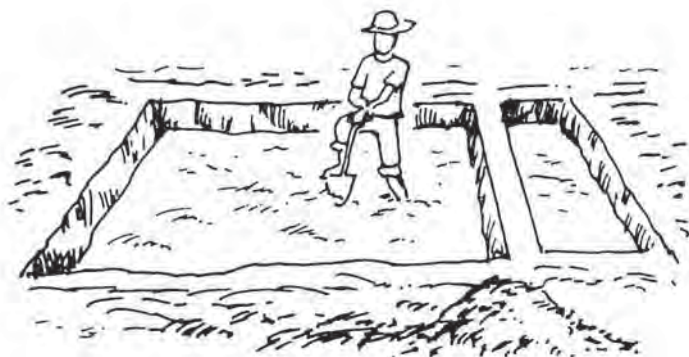

1. Mark the area. The ideal shape is rectangular (5 m x 12 m long).

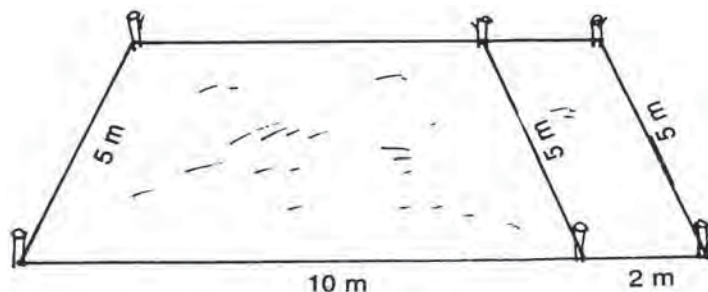

2. Dig the area to a depth of 0.5 to 1. Use the dug soil to build the high dikes.



KARPA
Cyprinus carpio



TILAPIA
Oreochromis niloticus

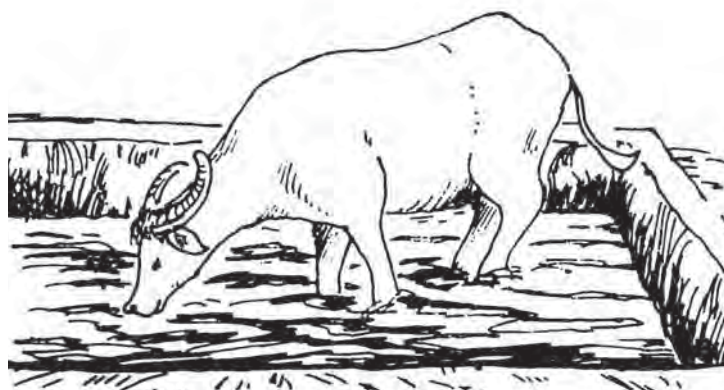

3. Compact the bottom of the pond by pounding the soil using the wood. If a carabao is available, let it roam and wallow in the mud.

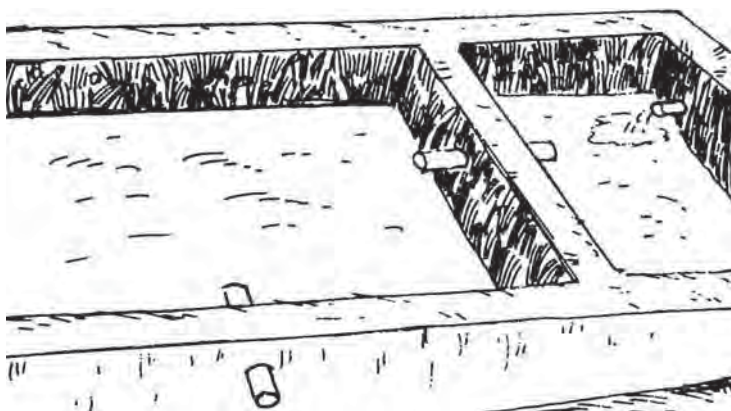

4. Install inlet/outlet/overflow pipes

Pond Fertilization for the Production of Plankton

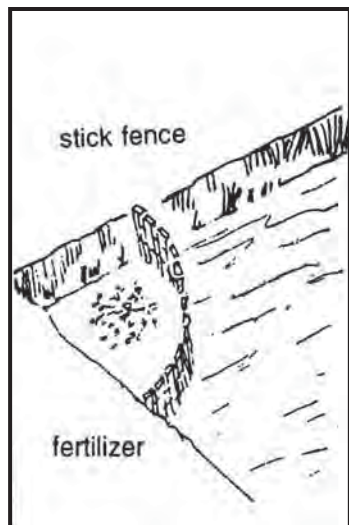

- Basal application is done before stocking the pond with fingerlings.
 1. Broadcast 1kg/sqm of chicken hog manure or compost. Carabao or cow manure can also be used at the rate of 2kg/sqm.

2. Allow the water to enter the pond and maintain depth at 25-30cm. Increase the water level at 1m slowly.
- Top dressing is done whenever the water is no longer greenish, indicating lack of plankton.
 1. Dump 1 kg cow or carabao manure and 1/2kg chicken manure in one corner of the pond.
 2. If inorganic fertilizer is to be applied, place it in a sack and submerge 15-20cm below the water surface. (Urea 16-20-0; 14-14-14; at 5-10g/sqm).

Stocking Rate

- 1 m water depth = 10 fingerlings/sqm
- 0.5 m water depth = 3-5 fingerlings/sqm
- Tilapia/carp combination = 10-15% Carp: 85-90% Tilapia

Feeding

- 3 parts boiled cassava, gabi or sweet potato peelings: 1 part ipil-ipil leaf meal
- 3 parts rice bran or corn bran: ipil-ipil leaf meal

For a more efficient feeding, mash the feeds, place in a feeding tray made of fine fish nets and submerge about 15-20cm below the water surface. Other supplementary feeds include green kangkong leaves, sweet potato, kitchen left-overs, crushed golden snails and white ants (termites).

Population Control

- From the dikes, scoop out the fries early in the morning and late in the afternoon. Fries linger in the edgewater at these times.

- Raise the collected fries in the nursery pond until they grow into fingerlings and stock for the next rainy season crop.

Harvesting

- After 3 or 4 months, harvest all the fish that weigh about 50g and over, using a sweep net.
- Harvest only the amount of fish that the family will eat for the day.

Backyard Integrated Pig-fish Culture in the Philippines

Integrated pig-fish culture is not a new concept; it has been practiced for many years in many parts of Asia. Raising pigs and fish at the same time has several advantages:

- Fish farmers can produce fish without feeding and hauling manure to fertilize the pond.
- Pig-fish culture maximizes land use by integrating two farm enterprises in the same area.
- The fishpond serves as a sanitary disposal place for animal wastes.
- Backyard integrated pig-fish culture provides additional income and a cheap source of animal protein for the family.

Establishing the System

1. Pond construction

- Establish the pond near a water source. However, the site should be free from flooding. Inlet and outlet pipes should be installed and screened.
- One pig can sufficiently fertilize a 100-150m² pond with its manure. The water depth should be maintained at 60-100cm. With this recommended pond area and water depth together with the right stocking density, problems of organic pollution are avoided.
- A diversion canal can be constructed to channel excess manure into a compost pit or when manure loading needs to be stopped.
- Nutrient-rich water from the pond can be used for vegetables grown on the pond dike or adjacent to the pond.

2. Location of the pig pen

There are two optional designs for locating the pig pen. It can be constructed on the dikes near the fishpond

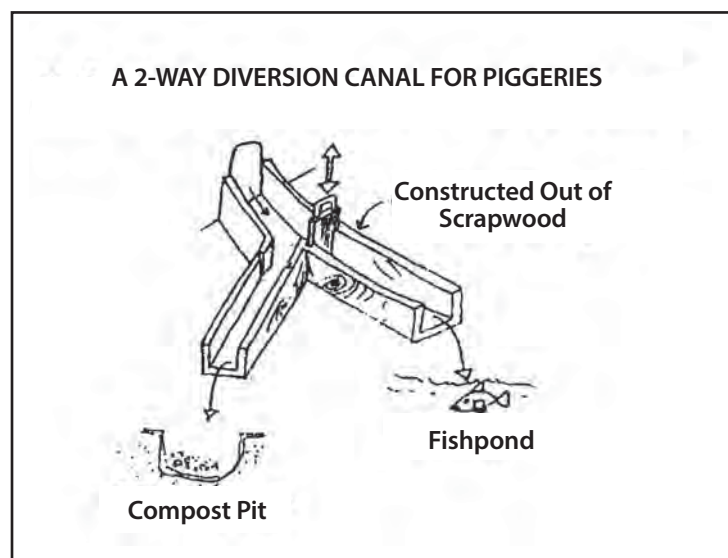
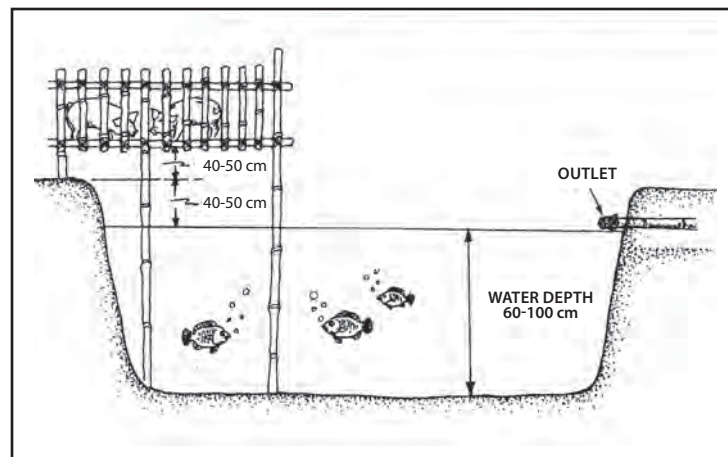

Preferably, the floor should be made of concrete (or other impermeable material to catch pig manure and urine) and should slope toward the pond. A pipe is necessary to convey the manure and urine into the pond. An alternative design

is to construct the pig pen over the pond. In this case, the floor can be made of bamboo slats spaced just enough to allow manure and urine to fall directly into the pond but not too wide for the feet of the pigs to slip into (thus, causing injuries). The pen should have a floor area of 1 m x 1.5m for each pig.

3. Stocking

- Stock the pond (approximately 100-150m²) with fingerlings (200 fish/100m²) once it is filled up with water. Three optional fish culture systems are suggested here, of which Polyculture 2 is based on experience in Vietnam and Thailand. Both polycultures contain predators to control tilapia recruits (if these are mixed-sex). The recommended stocking rates are as presented in Table 1
- Stock the pig pen with one weanling (8-10kg or 1.5 month old).
- Fish and piglets can be stocked at the same time.

4. Pig feeding

- Feed the pigs twice a day. Supplemental feeds such as kangkong (*Ipomoea aquatica*) may be given.

5. Harvesting

- Harvest the fish after 4-5 months. Collect fingerlings (if present) for the next growing season; sell the surplus. Partial harvesting for family consumption can also be done as needed.
- Sell the pig after 4-5 months.
- If possible, scrape out the organic waste or mud on the pond floor and use as fertilizer for the vegetable crop.

Limitations

- High cost of inputs for pig growing (feeds and weanlings)
- Consumers may be reluctant to eat fish produced in manure-loaded ponds, creating potential marketing problems.
- Farmers want their animals close to their homes (because of theft problems) and this may not be always possible.

Possible Solutions to Overcome Some of the Limitations

1. Raise crossbred/native pigs to reduce feed cost.
2. Occasionally, fish from ponds, which were overloaded with manure, can have a “muddy” or off-flavour taste which can be removed through the following measures:
 - Stop loading manure to the pond a few days before harvesting fish.
 - Transfer harvested fish to a net enclosure installed in a clear pond at least 4-6 hours (better several days) prior to selling or eating them.

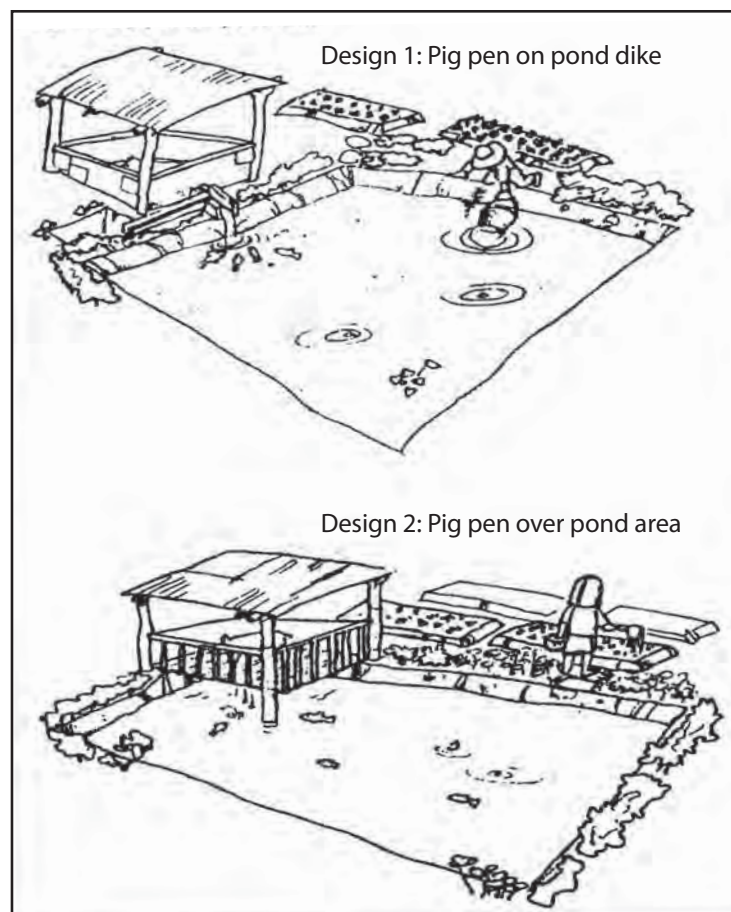

Table 1. Suggested stocking rates

Monoculture: 100% tilapia (*Oreochromis niloticus*) - 2 fish/m², 3-5g average weight

Polyculture 1:

- 85% tilapia - 170 fingerlings, 3-5g average weight
- 13% common carp (*Cyprinus carpio*) -26 fingerlings
- 2% snakeheads (*Channa striata*) and catfish (*Clarias batrachus*) -4 fingerlings, 1-2g average weight

Polyculture 2:

- 50% *Pangasius micronemus* -100 fingerlings, 10g
- 30% tilapia - 60 fingerlings, 3-5g
- 20% kissing gourami (*Helostoma temminckii*) - 40 fingerlings, 1-2g average weight

Issues for further consideration

Given the better acceptance and adoption rates of this technology in other countries in Asia, there seem to be specific constraints to this in the Philippines. Pigs are resource-intensive and need a concentrate-based diet for them to grow and produce quality wastes for fishpond fertilization. Experiments have shown that leucaena (ipil-ipil) leaves can be toxic to pigs at relatively low levels. Growing crossbred pigs and native pigs can be fed lower-quality feeds but this does not necessarily result in overall lower feed cost per unit of pig weight produced. Growth is poorer and even if feeds are not purchased, effort and other resources are needed in their use. Pig production is often affected by marketing risks and problems, which should be considered by new entrants.

The scraping out of pond mud for crop and vegetable fertilization is labor-intensive and also requires a drained pond, which is not possible in many locations where rural fishponds have been sited.

Cost and return (in Philippine peso) of the backyard integrated pig-fish culture for a 5-month period

Costs	Peso
Pig component	
Weanling	1 000.00
Commercial feeds	1 246.60
Medicines	34.00
Rice bran (P25/kg)	87.50
Labor	300.00
Pig pen maintenance	50.00
Fish component	
Pond maintenance	250.00
Fingerlings	40.00
	<u>3 008.10</u>
Income output	
Pig (1 head)	3 050.00
Fish (27.5 kg at P40/kg)	1 100.00
Fish fingerlings (1 100 at P.02/piece)	220.00
	<u>4 370.00</u>
Balance	<u>1 369.90</u>
Capital investments (fixed items)	
Pig pen (P500 at 6 years)	500.00
Pond construction (110-150 m ²)	200.00
Bucket	80.00
	<u>780.00</u>

$$\text{Rate of return on investment} = \frac{1\,369.90}{780} \times 100 = 176\%$$

Notes:

1. For P100 invested, the farmer gets P176.00
2. Entire capital cost can be recovered in one production cycle and still retain a surplus
3. 1992: US\$1 = P26

Source: IIRR & CCAFS. 2015. *Climate - Smart Agriculture: A primer for local government officials in the Philippines*, IIRR, Silang, Cavite, Philippines

Plant-based Animal Health Care

Common Name	Scientific Name	Parts Used	Method of Preparation and Administration	Approximate Dosage	Ailments
Luyang dilaw	<i>Curcuma longa</i>	Rhizomes	Decoction and given as drench or drink	1 liter/day for 1-3 days	Bloat Constipation Fever
Lagundi	<i>Vitex negundo</i>	Leaves	Decoction and given as drench	4 liters 2 times a day for 1-3 days	Fever Flu Cough
Alagaw	<i>Freana odorata</i>	Leaves Flowers	Decoction and given as drench	1 cup 3 x a day for 3 days	Fever Cold
Bayabas	<i>Psidium guajava</i>	Leaves	Decoction and given as drench Wound irrigation	1-2 glasses 2-3 x a day for 2-3 washing day	Colds Diarrhea Wounds
Malunggay	<i>Moringa oleifera</i>	Leaves	Mixed with feed.	1 kg. 3 x a day for 1-2 days	Agalactia
Sintonis	<i>Citrus nobilis</i>	Leaves	Decoction and given as drench	1 liter 3 x a day for 1 day	Running nose, Fever
Sampalok	<i>Tamarindus indica</i>	Leaves	Decoction and given as drench	1 liter 3 x a day for 1-3 days	Cough Colds
Makabuhay	<i>Tinospora rumphii</i>	Vines or body of plant.	Fresh plant/stem forced fed.	1-2 feet of vine 2 x a day for 4 days	Colds Anorexia Diarrhea Cough Dewormer
Duhat	<i>Zyzygium cumini</i>	Bark Leaves	Decoction and given as drench	4 liters 3 x a day for 3-5	Bloat Diarrhea
Kawayan tinik	<i>Bambusa spinosa</i>	Leaves Shoot	Mixed with the feeds	Ad libitum (no limit)	Diarrhea
Saging sabat	<i>Musa sapientum va. saba</i>	Leaves	Chopped and mixed with feeds.	2 kilos/day for 2-3 days	Diarrhea

Common Name	Scientific Name	Parts Used	Method of Preparation and Administration	Approximate Dosage	Ailments
Niyog/Coconut	<i>Cocos nucifera</i>	Water of young coconuts	Collect all water. Add sugar. Give as drench.	5 coconut plus ½ kilo of brown sugar, 3 x a day	Dehydration due to Fever Anorexia
		Oil/milk	Given as drench with 4 oz. kerosene	350 .1. 2 x a day for 2 days	Dewormer Bloat Constipation
		Husk/shell	Transformed into charcoal, pulverized and given as drench	Handful. Mix with 1 liter water	Diarrhea
		Oil	Cooked with ginger.	8 oz. with 1/4 kg. ginger. Paint open wound.	Treatment of the open wound,
Tuba	<i>Jatropha curcas</i>	Body of plant	Pounded and mixed with coconut oil and used as plaster	Paint the open wound	Treatment of open wound after castration.
Banaba	<i>Lagerstroemia speciosa</i>	Leaves Bark Dried fruit	Decoction and given as drench	1/2-1 liter 3 x a day for 1-3 days.	Difficulty in urinating. Stomach pain
Ginger	<i>Zingiber officinale</i>	Whole plant	Crushed and mixed with oil; used as poultice	Twice a day for 3 days	Muscular fatigue Sprains
Sampaguita	<i>Jasminum sambac</i>	Flower	Infusion as washing agent or eye drop	Washing every 2 hours for 3 days	Eye infection Sore eye
Aroma	<i>Acacia farnesiana</i>	Leaves	Fresh leaves as rubbing agent.		Skin disease caused by Mange or mite.
Pandan	<i>Pandanus tectorius</i>	Aerial roots/ prop roots Mature leaves	Decoction and given as drench	4 liters 3 x a day for 2-5 days	Difficulty of urinating
Madre de cacao/i kakawati	<i>Gliricidia sepium</i>	Leaves	Crushed fresh leaves as infusion	Poultice 2 x a day	Wounds infected with maggots.
Kantutay	<i>Paederia foetida</i>	Leaves/stem			
Lantana	<i>Lantana camara</i>	Leaves/stem			

Common Name	Scientific Name	Parts Used	Method of Preparation and Administration	Approximate Dosage	Ailments
Tublit	<i>Derris philippinensis</i>	Stem/root			
Lubigan	<i>Acorus calamus</i>	Leaves/root			
Kalabasa	<i>Cacurbita maxima</i>	Leaves/stem			
Tabakol	<i>Nicotiana tabacum</i>	Drief leaf	Single or combination of mixed with saliva.	Poultice direct to wound	Stop Hemorrhage of open wound.
Gatas-gatas	<i>Euphorbia hirra</i>	Whole plant	Crushed	Poultice applied	
Guava/Bayabas	<i>Psidium guajava</i>	Leaves		Poultice applied	
Hangod	<i>Achyranthes aspera</i>	Leaves	Decoction by boiling.	Used as aromatic bath on the udder	To reduce inflammation of udder.
Lubigan	<i>Acorus calamus</i>	Leaves/Roots			
Lukban	<i>Citrus aurantium</i>	Roots/ Leaves/ Kind of Fruit			
USED AS MIXTURE					
Buli	<i>Corypha elata</i>	Stem	Broil stem and extract juice	One stem	As antidote for Hagonoy
Coconut	<i>Cocos nuci fera</i>	Oil	Mix with oil	8 oz .	Poisoning
Duhat	<i>Syzygium cumini</i>	Leaves	Decoction and given as drench	4 liters 3-4 x a day	Diarrhea
Avocado	<i>Persea americana</i>				
Sambong	<i>Blumea balsamifra</i>	Leaves	Decoction and given as drench	1-2 gallon 2-3 x a day for 3-5 days	Common cold Cough Colds
Alagaw	<i>Premna odorata</i>				
Kalamansi	<i>Citrus macrocarpa</i>				
Makabuhay	<i>Tinosphora rumphii</i>	Vines	Decoction and given as drench	1 liter 2 x a day for 7 days	Colds
Luyang Dilaw	<i>Curcuma longa</i>	Rhizomes			

USED AS MIXTURE					
Sambong	<i>Bluema balsamifra</i>	Leaves			
Suob-kabayo	<i>Hyptis suaveolens</i>	Leaves	Fresh plants are finely chopped or crushed applied directly or rubbed on affected	Poultice 2 x a day	External parasites (mites, ticks and fleas)
Cashew	<i>Anarcadium occidentale</i>	Oil of nuts			

Direct interview with the farmers.

Source: *Regenerative Agriculture Technologies (RAT) Kit. IIRR UNICEF for Philippine Department of Agriculture. 1989.*

Plant-based Medicine for Livestock (Water Buffalo/Carabao)



The cost of livestock medication has been increasing during the past years, such that livestock raisers are demanding cheaper substitutes for imported medicines. Recently, the focus has shifted to herbal (plant) medicines which grow abundantly in the rural areas. Herbal therapy is known to be effective when the disease is still in its initial stage or recognized at the early signs of malady. Even in animal health care, farmers shared their views that they cannot afford to buy commercial medicine nor avail of veterinary services due to the remoteness of their areas. They have developed herbal medicine for animal

care guided by tradition or derived from herbalists (herbolarios) who have rich knowledge and experiences. Medicinal plants are available at no cost and can also complement some standard veterinary therapy. Definitely such an approach will cut down the cost of animal healthcare. Moreover, it will prevent unnecessary animal deaths resulting from lack of veterinary care in remote areas. This is one area of indigenous technical knowledge that needs to be pursued before valuable experiences are lost altogether. Here is a compilation of special relevance to livestock raisers:

* Livestock Specialist, IIRR, Silang, Cavite, Philippines.

Common name	Scientific Name	Parts used	Method of preparation and administration	Approximate dosage	Ailments
Luyang dilaw*	<i>Curcumalonga</i>	Rhizomes	Decoction and given as drench or drink	1 liter/day for 1-3 days	Bloat, Constipation, Fever
Lagundi	<i>Vitex negundo</i>	Leaves, Roots	Decoction and given us drench	4 liters 2 times a day for 1-3 days	Fever, Flu, Cough
Alagaw	<i>Premma odorata</i>	Leaves Flowers	Decoction and given us drench	1 cup 3 x a day for 3 days	Fever, Cold
Bayabas*	<i>Psidium guajava</i>	Leaves	Decoction and given us drench Wound irrigation	1-2 glasses 2-3x a day for 2 days 3 washing day/day	Colds, Diarrhea, Wounds
Malunggay	<i>Moringa oleifera</i>	Leaves	Mixed with feed	1kg 3x a day for 1-2 days	Agalactia
Sintones	<i>Citrus nobilis</i>	Leaves	Decoction and given us drench	1 liter 3x a day for 1 day	Runing Nose, Fever
Sampalok	<i>Tamarindus indica</i>	Leaves	Decoction and given us drench	1 liter 3x a day for 1-3 days	Cough, Colds
Makabuhay*	<i>Tinosphora rumphil</i>	Vines or body of plant	Fresh plant/stem forced-fed	1-2 feet of vine 2x a day for 4 days	Colds, Anorexia, Diarrhea, Cough, Dewormer
Duhat	<i>Zyzygium cumini</i>	Bark, leaves	Decoction and given us drench	4 liters 3x a day for 3-5 days	Bloat, Diarrhea, Stomach pain
Kawayan tinik	<i>Bambusa spinosa</i>	Leaves, shoot	Mixed with the feeds	Ad libitium (no limit)	Diarrhea
Saging saba*	<i>Musa sapientum va. saba</i>	Leaves	Chopped and mixed with feeds	2 kilos/day for 2-3 days	Diarrhea
Niyog/ Coconut*	<i>Cocos nucifera</i>	Water of young coconuts sugar. Oil/milk Husk/shell Oil	Collect all water. Add give as drench Given as drench with 4 oz. kerosene Transformed into charcoal, pulverized and given as drench Cooked with ginger	350 ml. 2 x a day for 2 days Handful. Mix with 1 liter water 8 oz. with 1/4 kg. ginger. Paint the open wound	Dewormer, Bloat, Constipation Diarrhea Treatment of open wound

* Direct interview with farmers in IIRR's social laboratory in Cavite, Philippines

Common name	Scientific Name	Parts used	Method of preparation and administration	Approximate dosage	Ailments
Tuba	<i>Jatropha curcas</i>	Body of plant	Pounded and mixed with coconut oil and used as plaster	Paint the open wound	Treatment of open wound after castration.
Banaba*	<i>Lagerstroemia speciosa</i>	Leaves, Bark, Dried fruit	Decoction given as drench	1/2-1 liter 3 x a day for 1-3 days	Difficulty in urinating, stomach pain
Ginger*	<i>Zingiber officinale</i>	Whole plant	Crushed and mixed with oil; used as poultice	Twice a day for 3 days	Muscular fatigue, sprains
Sampaguita	<i>Jasminum sambac</i>	Flower	Infusion as washing agent or eye drop	Washing every 2 hours for 3 days	Eye infection, sore eyes
Aroma	<i>Acacia farnesiana</i>	Leaves	Fresh leaves as rubbing agent		Skin disease caused by Mange or mite
Pandan*	<i>Pandanus tectorius</i>	Aerial roots/Prop roots; Mature leaves	Decoction given as drench or drink	4 liters 3 x a day for 2-5 days	Difficulty of urinating
Madre de Cacao* / Kakawati	<i>Gliricidia sepium</i>		Crushed fresh leaves as infusion	Poultice 2 x a day	Wounds infected with maggots
Used as mixtures					
Duhat*	<i>Syzygium cumini</i>	Leaves	Decoction and given as drench	4 liters 3-4 x a day	Diarrhea
Caimito*	<i>Chrysophyllum cainito</i>				
Avocado*	<i>Persea americana</i>				
Sambong*	<i>Blumea balsamifera</i>	Leaves	Decoction and given as drench	1-2 gallon 2-3 x a day for 3-5 days	Common colds, cough, colds,
Alagaw*	<i>Premna odorata</i> <i>Citrus</i>				
Kalamansi	<i>Citrus macrocarp</i>				
Makabuhay*	<i>Tinospora rumphii</i>	Vines	Decoction and given as drench	1 liter 2 x a day for 7 days	Colds
Luyang dilaw*	<i>Curcuma longa</i>	Rhizomes			

* Direct interview with farmers in IIRR's social laboratory in Cavite, Philippines

Common name	Scientific Name	Parts used	Method of preparation and administration	Approximate dosage	Ailments
Sambong	<i>Blumea balsamifera</i>	Leaves			
Suob-kabayo*	<i>Hyptis suaveolens</i>	Leaves	Fresh plants are finely or crushed and applied directly or rubbed on affected parts	Poultice 2 x a day	External parasites (mites, ticks, and fleas)
Cashew*	<i>Anarcadium occidentale</i>	Oil of nuts			
Kantutay*	<i>Paederia foetida</i>	Leaves/Stem			
Lantana*	<i>Lantana camara</i>	Leaves/Stem			
Tubli*	<i>Derris philipinensis</i>	Leaves/Root			
Lubigan*	<i>Acorus calamus</i>	Leaves/Root			
Kalabasa*	<i>Cucurbita maxima</i>	Leaves/Root			
Tabako*	<i>Nicotiana tabacum</i>	Drief leaf	Single or combination mixed with saliva	Poultice direct to wound	Stop hemorrhage of open wound
Gatas-gatas*	<i>Euphorbia hirra</i>	Whole plant	Crushed	Poultice applied	
Hangod*	<i>Achyranthes aspera</i>	Leaves	Decoction by boiling	Used as aromatic bath on udder.	To reduce inflammation of udder.
Lubigan*	<i>Acorus calamus</i>	Leaves/Roots			
Lukban	<i>Citrus aurantium</i>	Roots/Leaves Fruit			

Source: IIRR. 1990. Resource Book on Sustainable Agriculture for the Uplands, IIRR, Silang, Cavite, Philippines

* Direct interview with farmers in IIRR's social laboratory in Cavite, Philippines

Plant-based Livestock Medication

The rising cost of animal drugs is one of the (livestock) farmer's biggest problem. Compounding the situation is the remoteness of villagers to towns where they could avail of the services of animal technicians or veterinarians to provide the needed animal health care. Commercial drugs can be difficult to obtain in remote upland communities.

Medicinal plants abound throughout the country. When administered in conjunction with standard veterinary therapy, they can considerably reduce the cost of animal health care. Moreover, they can prevent unnecessary animal deaths resulting from lack of veterinary care in remote areas.

The following are some commonly used medicinal plants which are proven to be effective.

ALAGAW

Premna odorata
Abgaw (Bisaya), Adiyó,
Argaw (Tagalog)

- A decoction of 8-15 leaves and 2-3 glasses of water given as drench (1/2 to 1 cup, 3 times a day for 3 days) is effective against fever, cough and colds.
- The extract of fresh leaves is internally used against ringworm and externally against ticks, lice, fleas and to clean wounds.



AMPALAYA

Momordica charantia
Paliya (Bisaya)
Bitter Gourd (English),
Paria, Piliya (Tagalog)

- The juice extract from 1/2 to 1kg of the leaves is orally given to the animal as dewormer.
- Given to one-day-old piglets, it prevents piglet anemia.



BAYABAS

Psidium guajava
Guava (English)

- A decoction of 12 leaves and 2 glasses of water is given as drench for diarrhea (1 to 2 glasses, 3 times a day for 1 to 2 days).
- A poultice of pounded leaves is applied to skin diseases, infested wounds and castration wounds and is also used to stop bleeding.

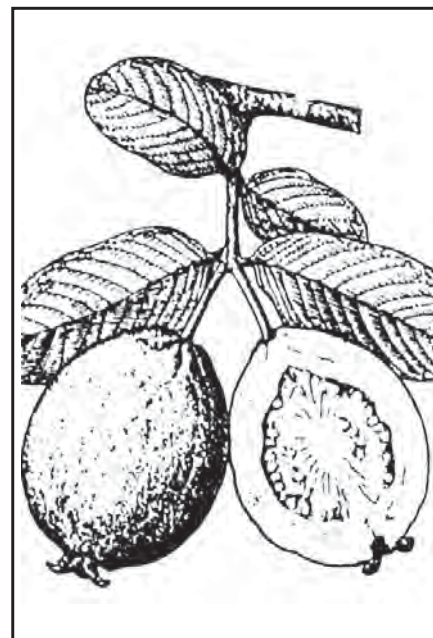

BUNGA

Areca catechu

Betelnut (English)

- Young betelnuts are used as dewormer, especially against tape-worm and roundworm. They are pounded, added with water and fed to the animal once. The dosage for chicken is a piece as big as a peanut, 1-3 nuts for goats and pigs and 8-10 nuts for cattle/carabao.

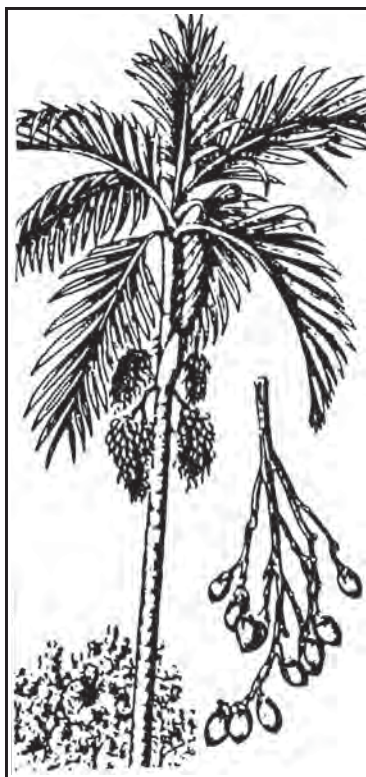

KAKAWATE

Gliricidia sepium

Madre de Kakaw (Tagalog, Bisaya)

- Leaves are pounded, the extracted juice is externally applied on the affected area to cure skin diseases, wounds and to get rid of external parasites like lice, ticks and fleas.

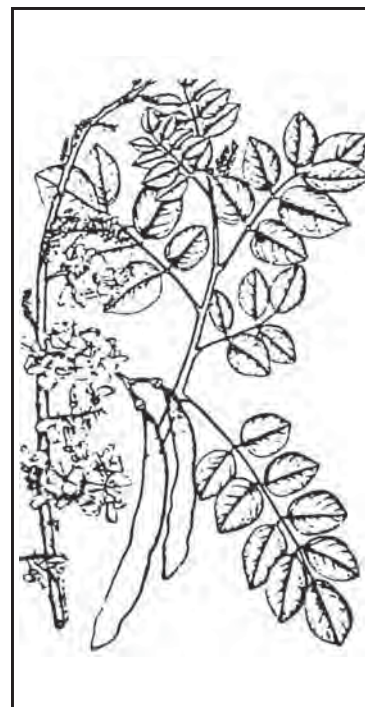

CAIMITO

Chrysophyllum cainito L.

Starapple (English)

- Decoction of 1/2kg of caimito leaves and 3 glasses of water is given as drench (1 cup, 3 times a day for 1 to 3 days) for fever and diarrhea in animals.



LAGUNDI

Vitex negundo

Five-leaves chaste tree (English)

- Decoction of 1/2kg leaves and 2 liters of water is given as drench (3 liters a day, 2 times a day for 1 to 3 days) is effective to treat fever, flu and cough.
- The juice extracted from the leaves is used as dewormer (1 to 2kgs of leaves) and to treat Newcastle Disease in poultry.



LANTANA

Lantana camara L.
Baho-baho (Bisayas),
Kantutai (Tagalog)

- A decoction of 200g leaves and flowers and 1 liter of water, given three times a day, is used to reduce fever and to cure cough and colds.
- A poultice of pounded fresh leaves is applied for sprains, fractures and rheumatism.



NIYOG

Cocos nucifera
Lubi (Bisaya),
Coconut (English)

- Water of the young coconut (3 to 5 coconuts) together with 1 cup of sugar and some salt is given to animals with diarrhea.
- For bloat, constipation and as dewormer the juice/oil from meat of the mature coconut (200 to 350ml, 2 times a day for 2 days) is mixed with the feed of the animal.



MALUNGGAY

Moringa oleifera Lam.
Horseradish tree, drumstick
tree (English)

- An orally given extract of 1/2 to 1kg leaves prevents piglet anemia if given to one-day-old piglets.
- The extracted juice is also effective externally to cure wounds and internally as dewormer.
- Young leaves fed to lactating sow or cow stimulates milk flow.

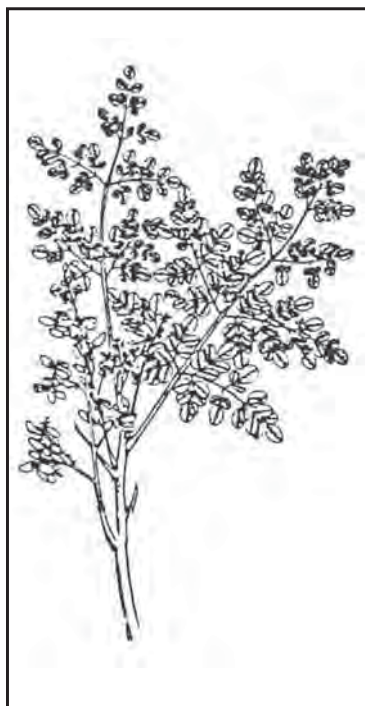

SAGING

Musa sapientum
Banana (English)

- Clean, chopped banana leaves (var. saba) are fed ad libitum to animals suffering from diarrhea.
- To treat open wounds, e.g., to stop bleeding after castration, clean steamed banana leaves (all varieties) are applied next to the lesions.



SAMBONG

Blumea balsamifera

Alibum, Ayoban, Lakad-bulan

(Bisaya),

Ngai camphor (English)

- Decoction of 10 leaves and 1 liter of water is given as drench against fever, colds, cough, running nose and diarrhea (2 times a day 1/2 to 1 liter for 1 to 3 days)



Notes:

- *If no specific animal species is mentioned, the remedy can be used for all livestock.*
- *To prepare a decoction, the plant materials are boiled in water for 15-20 minutes or until the water is reduced to half its original volume. Allow to cool and strain.*

If symptoms persist, a veterinarian should be consulted.

Source: *Regenerative Agriculture Technology Kit. IIRR & UNICEF for Philippine Department of Agriculture. 1989.*

Vegetable-duck-fish Culture

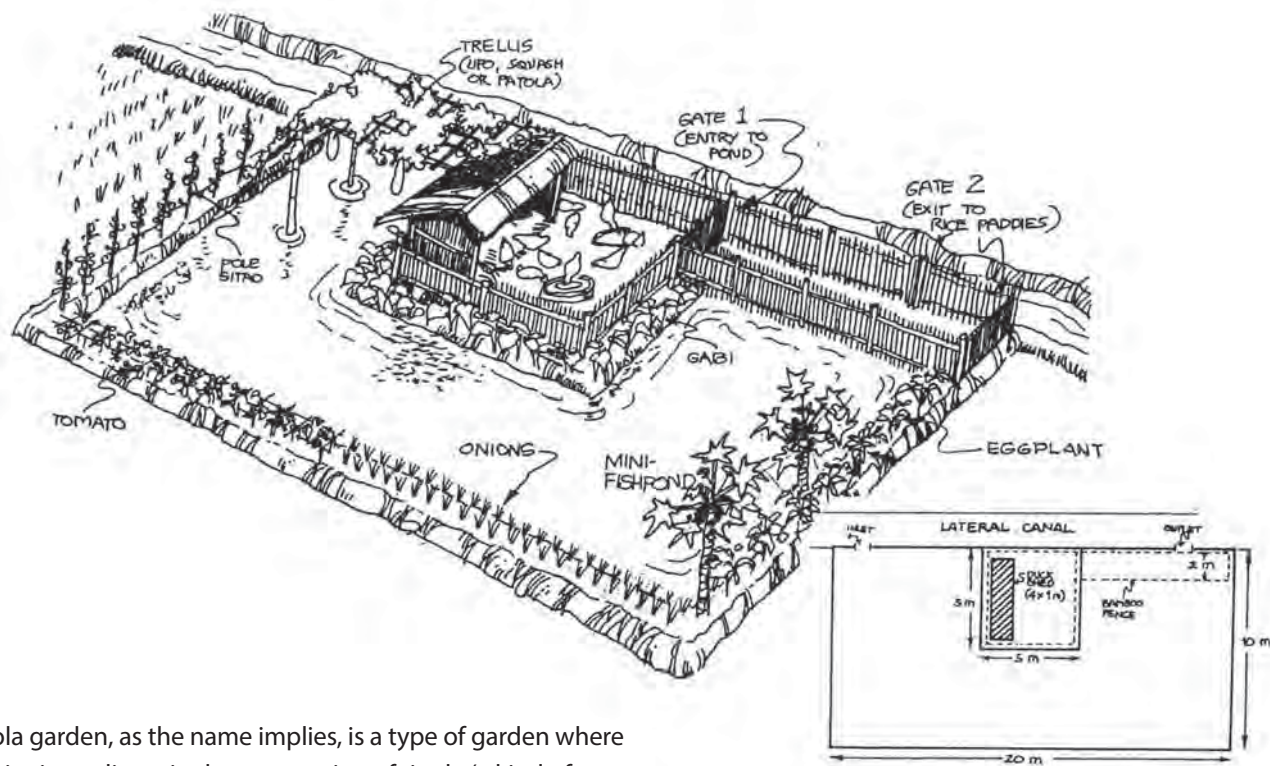

Tinola garden, as the name implies, is a type of garden where major ingredients in the preparation of tinola (a kind of poultry or fish soup with vegetables) are found in a 200sqm area.

preferences of the farmer, dikes could be planted with different vegetables and crops (e.g., leaf, fruit, root or legumes) and areas along the fence and trellis with any climbing vegetables.

Basic Components:

- Duck-raising for meat and/or eggs
- Mini-fishpond
- Vegetable growing

This vegetable-duck-fish culture is actually a modification of the original mini-fishpond operation. This technology, however, optimizes land use by planting vegetables on the dikes, fence and the construction of trellis over the mini-pond. Depending on the

Advantages:

Some of the advantages of this tinola garden are the following:

- Increase in quantity and variety of food for home consumption
- Ensures fresh supply of poultry meat and eggs, fish and vegetables
- Practical for those farmers whose land area is less than 1.0 hectare and adopting the rice-fish culture.

Notes on Individual Components:

A. Vegetables

- On the trellis and fence–squash, patola and other climbing vegetables.
- After the construction of pond dikes, the trellis could be constructed and planting of varieties of crops could immediately follow.

B. Mini-fishpond

- The dikes should be at least 1 m high, 1/2m wide on the top and 1m wide at the base.
- Water inside the pond must not be more than 1/2m (to minimize fish losses).
- Recommended fish for stocking is Tilapia (*Tilapia nilotica*) and common carp (*Cyprinus carpio*) at the rate of 3 fingerlings/sqm.
- Low-cost feeds may include rice bran, crushed snails and kitchen refuse.

Note: Refer to technology paper on Rice-Fish Culture for feeding and other management techniques.

C. Duck-raising

- Shed house (4 m x 1 m) made of low-cost and locally available materials (e.g., bamboo, ipil-ipil, madre de cacao, cogon, nipa, etc.) located in a 25sqm area in one section of the pond.
- Feeding troughs and waterers using old jeep or truck tires, clay pots or old cooking utensils.
- Stock: 8-12 heads (any species, depending on the farmer).
- Feeds may consist of rice bran, crushed banana trunk, crushed snails, kitchen refuse, kangkong, etc. Feeding is done twice a day.

Family Backyard Poultry Project

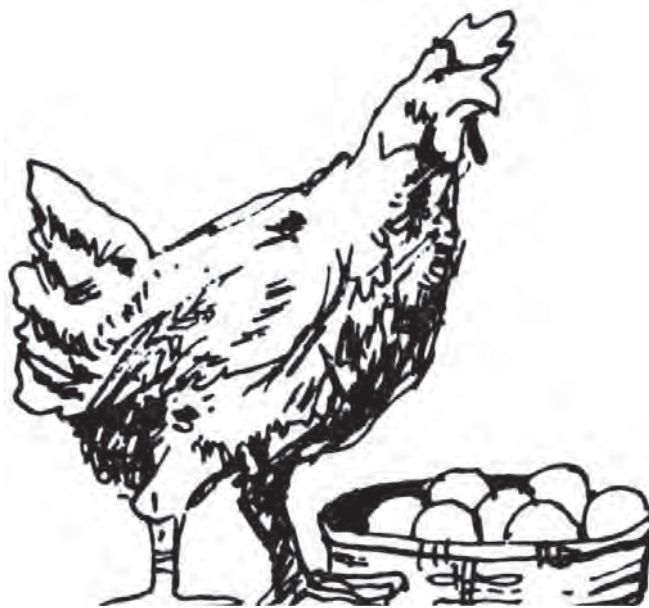

Native Chicken 30-50 eggs/year



Imported Stock 286 eggs/year

In the barangays, nearly every household keep some native chickens. Usually being left alone to fend for themselves, a hen produces 30-50 eggs per year as compared to imported stocks which can lay some 286 eggs per year. UPLB (1985) found that native birds, when given the same improved feed and management, could reach (at the first 180 days of lay) 48 percent of the egg production (or 137 eggs per year) of the commercial leghorn hybrids.

The care of a small backyard flock can help fill the family food requirements for eggs and meat. It can also be a source of additional income. A valuable by-product is the chicken manure which is a very excellent organic fertilizer for farm and home gardens.

Project Scheme

1. Each participating family will start with two properly selected upgraded roosters and ten layers (inabin; five for egg production and five layers to produce chicks for meat production).
2. A poultry house should be constructed using local materials for minimum expense. The house should have perch racks, roosts, nests, feedhoppers and waterers. The house should at least be 7 feet high, with a floor area of 10ft. x 12ft. It can also be provided with a fenced area as run and a growing house for the chicks.

- The family could buy or raise the feed supplements like co., sorghum, ipil-ipil and others.
- Recommended management practices on feeding and watering, brooding and rearing young chicks, culling and selection, record keeping, etc., should be followed.
- Regular immunization (1-2 times a year against poultry diseases like avian pest, CRD, fowl pox, etc.)

Feasibility Study

1. Expenses

10 layers x P 40/layer	P 400.00
2 roosters x P 50/rooster	100.00
Housing and fence	1,000.00
Vaccines/veterinary drugs	25.00
Feed supplement	500.00
	P 2,025.00

2. Egg production Cycle

20 eggs/layer/month x 12 months	= 240 eggs
240 eggs x 5 layers	= 1,200 eggs/year
1,200 eggs/year x P 1.50/egg	P 1,800.00

3. Meat Production Cycle

A. Growing period

Laying - 20 days	
Incubation - 21 days	
Brooding - 60 days	
One production cycle	= 101 days or 3 cycles per year

B. Production/multiplication Cycle

Survival rate of chicks/hen/cycle	= 10 chicks
10 chicks x 3 cycles/year	= 30 chicks
30 chicks x 5 hens	= 150 chicks

Gross income from 5 hens/year 150 birds x P 30/bird =P 4,500.00

4. Cost Analysis

Gross income from egg production	P1,800.00
Gross income from meat production	P4,500.00
Total income for 3 cycles (1 year)	P6,300.00
Less: Expenses	P2,025.00
Net income	P4,275.00

Note: The roosters remain. To prevent broodiness of native chickens after laying, it is advisable to dip the birds in water.

Home-made Chicken Feeds

4 cans yellow corn or broken rice (binlid)
 1 1/2 cans rice bran (darak)
 1 can dry fish meal or 2 parts fresh fish or ground snails
 1 112 can copra oil meal
 1/2 can copra oil meal
 1/2 can ground mongo, sitao, patani or soy bean seeds
 1/2 can dry ipil-ipil leaf meal
 1 tablespoon salt 1 handful powdered shell/agricultural lime (apog)

Notes:

Use boiled gabi, ubi, cassava or camote as substitute for corn meal. Double the recommended amounts if ingredients are not in dry form.

Use dried *Azolla* or dried filter cake to replace part of the rice bran.

A. Other Low-cost Poultry Feeds

- bananas
- fly maggots
- fingerlings
- azolla
- snails
- filter cake (dried and good)
- termites
- earthworms

Filter cake is the dark brown-black sediment after clarification and filtration during the manufacture of sugar.

B. Anti-nutrients in Some Feeds

Kind	Anti- nutrient	Remedial measures
Sorghum	Tannin	Milling, use only the recommended amount
Legume	Protease inhibitors lectin	Boiling and toasting
Seed/beans Cassava	Cyanogen	Boiling, roasting, soaking
Ipi-ipil	Mimosine	Use recommended amount

C. Recommended Schedule of Vaccination (BAI)

Kind	Anti- nutrient
Avian Pest Vaccine (Intranasal method)	1 day to 1-week old
Pigeon Pox Vaccine	One-month old

Kind	Anti- nutrient
Roup Vaccine	Two-months old
Avian Pest Vaccine (Prick method)	Three-months old
Fowl Pox Vaccine	Four-months old
Fowl Cholera	Five-months old
Avian Pest Vaccine	Repeat after one year of laying

Muscovy ducks (bibe), pigeons and geese are hardy and could be raised in the backyard under adverse conditions. They do not require elaborate housing and can subsist on inexpensive feeds.

Improving Native Chicken



Majority of small and marginal farmers raise native chicken in their backyards. The native chicken are nondescript, mongrel birds that have evolved from jungle fowls interbred with domesticated ones brought into the country by early Chinese, Spanish and Dutch traders and settlers. The native chicken have adapted themselves to adverse conditions in small farms - poor and scanty feeds, inadequate shelter, sudden changes of weather and rampant diseases. The birds are generally left to fend for themselves. As a result, they have acquired unusual hardiness. These native birds supply the family with a few eggs and, occasionally, meat for home

consumption, for barter or for sale. Their meat and eggs are claimed to be tastier and more savory than those of purebreds. Thus, inspite of their slow growth and small size, they are more costly. It takes them a year to obtain full size (1-1.5 kilograms). Under farm conditions, the hens give from 30-50 eggs in 34 cycles a year. The eggs are small and brown. The hens become broody for a long period after laying a clunch of 10-12 eggs (farmers control the broodiness of native hens by soaking them in cold water, removing the laid eggs from their nests, or even placing some slat or powdered pepper on their cloaca and also by providing better feeds).

Some Strategies in Upgrading the Native Chicken

The government and agricultural universities as well as some private individuals have embarked on some strategies to improve the native chicken. In a majority of the villages where these programs have reached, the graded chicken have thrived and performed well by crossing the local chicken with purebreds and general purpose breeds like Rhode Island, Plymouth Rock, New Hampshire Australorp and Cantonese using the following strategies:

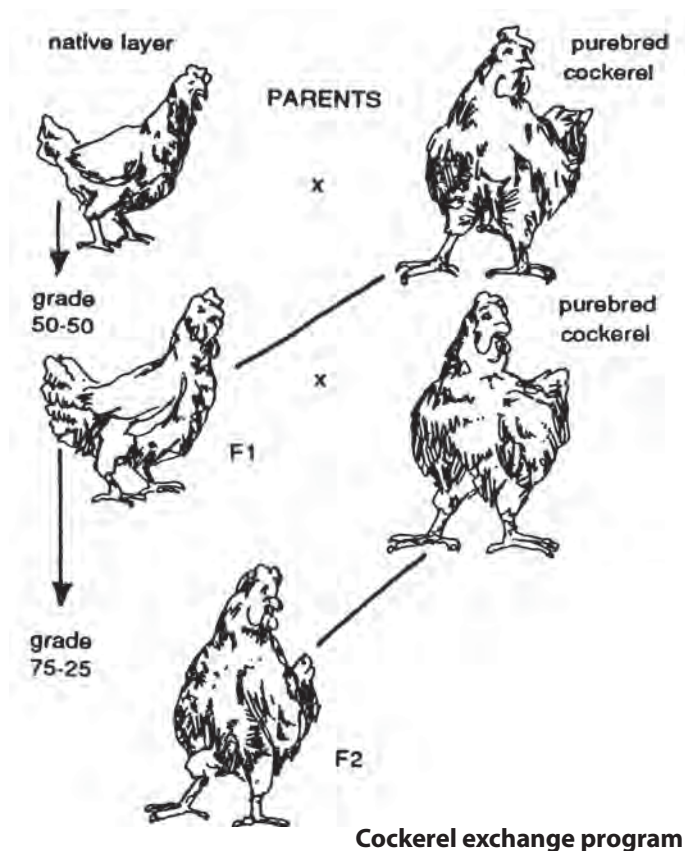

1. Introduction of purebred hatching eggs. Once the native bird starts to be broody after laying a clutch of 10-12 eggs, all its eggs are replaced with purebred hatching eggs. The purebred chicks will then be raised by the native hen.
2. Introduction of purebred chicks. Day-old purebred chicks are placed in the evenings with the broody native hen, which is also rearing day-old native chicks. Rubbing all the chicks (native and purebred alike) with some coconut oil prevents the mother hen from recognizing her "real" chicks from the others.
3. Cockerel exchange program. The Bureau of Animal Industry (BAI) introduced this method as a means to upgrade local chicken by exchanging a local cockerel with a purebred one. Thus, all native cockerels in the flock are eliminated.
4. Local farmers buying male purebred broiler from small broiler raisers. These are then raised to become the breeders of the native chicken. Somehow, the farmers must eliminate also the native cockerels from his flock.

Coupled with these methods of upgrading, the farmer should also put up a poultry house of local materials as these purebred would not be able to roost on higher branches of trees. They also need protection during inclement weather.

The offsprings of these are called mestizos or grades, whose size and egg production almost equal those of the purebred parents. Further mating of the graded females to purebred males produce birds that could be mistaken for purebreds.

White leghorn males are mated with native hens to produce grades for better egg production. The offsprings may give more eggs at the start, but they are not so hardy enough to sustain this under farm conditions. The same case goes for the White Leghorn males' performance. Given this limitation, providing proper feed, proper care and management can do a lot to augment the situation.

ANNEXES

(NAPC)

Annex A

List of Dairy Organizations in the Philippines

Region	Province	Name of Cooperative	Address	Contact Person	Phone No.
RFU I	Pangasinan	5th District of Pangasinan Dairy MPC (Cong. Cojuangco)	Maraboc, Laoac, Pangasinan	c/o North Luzon Field Office	02-9260733 Loc 202
RFU I	Pangasinan	Tulong MPC	Tulong, Urdaneta City, Pangasinan	c/o North Luzon Field Office	02-9260733 Loc 202
RFU II	Cagayan	PCC-Piat	Piat, Cagayan	c/o North Luzon Field Office	02-9260733 Loc 202
RFU II	Isabela	San Pablo, Isabela	San Pablo, Isabela	c/o North Luzon Field Office	02-9260733 Loc 202
RFU II	Isabela	SADIRI-A1 MPC (Isabela)	Concepcion, Luna, Isabela	c/o North Luzon Field Office	02-9260733 Loc 202
RFU III	Tarlac	TARLAC	San Rafael, Tarlac City	c/o North Luzon Field Office	02-9260733 Loc 202
RFU III	Bataan	Cong. Payumo & Atty Ding Pascual	Dinalupihan, Bataan	c/o North Luzon Field Office	02-9260733 Loc 202
RFU III	Zambales	Calabungan MPC	Lucapon Norte, Sta. Cruz, Zambales	c/o North Luzon Field Office	02-9260733 Loc 202
RFU III	Zambales	Tribu Zambaleño	Candelaria, Zambales	c/o North Luzon Field Office	02-9260733 Loc 202
RFU III	Zambales	Nagbayan Multipurpose Coop	Nagbayan, Castillejos, Zambales	c/o North Luzon Field Office	02-9260733 Loc 202
RFU III	Zambales	Tribu Zambaleño	Candelaria, Zambales	c/o North Luzon Field Office	02-9260733 Loc 202
RFU III	Zambales	Nagbayan Multipurpose Coop	Nagbayan, Castillejos, Zambales	c/o North Luzon Field Office	02-9260733 Loc 202
RFU III	Pampanga	DEALCO	San Ildefonso, Magalang, Pampanga	c/o North Luzon Field Office	02-9260733 Loc 202
RFU III	Bulacan	Salikneta Farm	Upper Ciudad Real, City of SJDM, Bulacan	c/o North Luzon Field Office	02-9260733 Loc 202
RFU III	Bulacan	Sta. Maria Dairy Farmers MPC	Paso, Bagbaguin, Sta. Maria, Bulacan	Mylene Gimeno	0916-5566987
RFU III	Bulacan	Cowland	Catmon, Sta. Maria, Bulacan	c/o North Luzon Field Office	02-9260733 Loc 202

Region	Province	Name of Cooperative	Address	Contact Person	Phone No.
RFU III	Bulacan	KABAKA (formerly Cruzada Farmers MPC)	95 Salapungan, San Rafael, Bulacan	c/o North Luzon Field Office	02-9260733 Loc 202
RFU III	Bulacan	Siling Matanda Multi-purpose Coop (Pandi)	Siling Matanda, Pandi, Bulacan	c/o North Luzon Field Office	02-9260733 Loc 202
RFU III	Bulacan	Diliman	Diliman, San Rafael, Bulacan	c/o North Luzon Field Office	02-9260733 Loc 202
RFU III	Bulacan	Mayor Marcos	Capihan, San Rafael, Bulacan	c/o North Luzon Field Office	02-9260733 Loc 202
RFU III	Bulacan	Marilao Dairy Cooperative	Sta. Rosa II, Marilao, Bulacan	c/o North Luzon Field Office	02-9260733 Loc 202
RFU III	Bulacan	Upig Multipurpose Coop., Inc.	Upig, San Ildefonso, Bulacan	c/o North Luzon Field Office	02-9260733 Loc 202
RFU III	Bulacan	Maronquillo Dairy Farmers MPC	Maronquillo, San Rafael, Bulacan	c/o North Luzon Field Office	02-9260733 Loc 202
RFU III	Bulacan	Odelon San Juan	Sto. Niño, Paombong, Bulacan	c/o North Luzon Field Office	02-9260733 Loc 202
RFU III	Bulacan	KABAKA (formerly Cruzada Farmers MPC)	95 Salapungan, San Rafael, Bulacan	c/o North Luzon Field Office	02-9260733 Loc 202
RFU III	Aurora	Self Employment Assistance-Kababaihan	San Luis, Aurora Philippines	c/o North Luzon Field Office	02-9260733 Loc 202
RFU III	Aurora	CATMON Keso	Sta. Maria, Bulacan	c/o North Luzon Field Office	02-9260733 Loc 202
RFU III	Nueva Ecija	Impact Zone - (NEFEDCO)	San Ricardo, Talavera, Nueva Ecija	c/o North Luzon Field Office	02-9260733 Loc 202
RFU III	Nueva Ecija	PCC - CLSU	Munoz, Nueva Ecija	c/o North Luzon Field Office	02-9260733 Loc 202
RFU III	Nueva Ecija	PCC- Gene Pool	Munoz, Nueva Ecija	c/o North Luzon Field Office	02-9260733 Loc 202
RFU III	Nueva Ecija	Las Piñas Aggregates Primary MPC (Penaranda)	Las Pinas, Penaranda, Nueva Ecija	c/o North Luzon Field Office	02-9260733 Loc 202
RFU III	Nueva Ecija	Impact Zone - (NEFEDCO)	San Ricardo, Talavera, Nueva Ecija	c/o North Luzon Field Office	02-9260733 Loc 202
RFU III	Nueva Ecija	PCC- Gene Pool	Munoz, Nueva Ecija	c/o North Luzon Field Office	02-9260733 Loc 202
RFU III	Cavite	3-Heifer Family Module	Cavite	c/o South Luzon Field Office	02-9260733 Loc 202
RFU IVA	Quezon	Brucal, Francisco	Sariaya, Quezon	c/o South Luzon Field Office	02-9260733 Loc 202
RFU IVA	Quezon	Progressive Entrepreneur of Agri - Related Livelihood Services (Pearls) MPC	Calmar Subd., Lucban, Quezon	c/o South Luzon Field Office	02-9260733 Loc 202

Region	Province	Name of Cooperative	Address	Contact Person	Phone No.
RFU IVA	Quezon	Dalwampo, Olimpio	Sariaya, Quezon	c/o South Luzon Field Office	02-9260733 Loc 202
RFU IVA	Quezon	CCF Macalelon	Macalelon, Quezon	c/o South Luzon Field Office	02-9260733 Loc 202
RFU IVA	Quezon	Ayusan 1 Farm	Tiaong, Quezon	c/o South Luzon Field Office	02-9260733 Loc 202
RFU IVA	Quezon	Berino, Manalo	Sariaya, Quezon	c/o South Luzon Field Office	02-9260733 Loc 202
FU IVA	Quezon	PRIVATE TUMBAGA 1	Tumbaga 1, Sariaya, Quezon	c/o South Luzon Field Office	02-9260733 Loc 202
RFU IVA	Quezon	Magnaye, Mario	Sariaya, Quezon	c/o South Luzon Field Office	02-9260733 Loc 202
RFU IVA	Quezon	Arce, Eliza (PALCON)	Tiaong, Quezon	c/o South Luzon Field Office	02-9260733 Loc 202
RFU IVA	Quezon	Birhen Milagrosa PA(Himalaya)	Mayao Parada, Lucena City, Quezon Philippines	c/o South Luzon Field Office	02-9260733 Loc 202
RFU IVA	Quezon	Manalo, Semion	Sariaya, Quezon	c/o South Luzon Field Office	02-9260733 Loc 202
RFU IVA	Quezon	Anchor Farm	Tiaong, Quezon	c/o South Luzon Field Office	02-9260733 Loc 202
RFU IVA	Quezon	Vandervilt Gaditano	Malabanban Sur, Candelaria, Quezon	c/o South Luzon Field Office	02-9260733 Loc 202
RFU IVA	Quezon	CCF Macalelon	Macalelon, Quezon	c/o South Luzon Field Office	02-9260733 Loc 202
RFU IVA	Quezon	De Chavez, Paulito	Sariaya, Quezon	c/o South Luzon Field Office	02-9260733 Loc 202
RFU IVA	Quezon	Dalwampo, Leonardo	Concepcion I, Sariaya, Quezon	c/o South Luzon Field Office	02-9260733 Loc 202
RFU IVA	Quezon	Magnaye, Mario	Sariaya, Quezon	c/o South Luzon Field Office	02-9260733 Loc 202
RFU IVA	Quezon	Alay Kapwa Rural Women Consumer	Sampaloc 2, Sariaya, Quezon	c/o South Luzon Field Office	02-9260733 Loc 202
RFU IVA	Quezon	Vandervilt Gaditano	Malabanban Sur, Candelaria, Quezon	c/o South Luzon Field Office	02-9260733 Loc 202
RFU IVA	Quezon	Tayabas - LGU	Masin, Tayabas, Quezon	c/o South Luzon Field Office	02-9260733 Loc 202
RFU IVA	Laguna	Phil. Carabao Center - UPLB	UPLB, Laguna	c/o South Luzon Field Office	02-9260733 Loc 202
RFU IVA	Laguna	New Pagsanta Dairy Coop	Binan, Pagsanjan, Laguna	Baltazar Montiel	(049) 536-35-48

Region	Province	Name of Cooperative	Address	Contact Person	Phone No.
RFU IVA	Laguna	Hacienda Macalauan	Calauan, Laguna	c/o South Luzon Field Office	02-9260733 Loc 202
RFU IVA	Laguna	Greggorio Sandoval	Brgy. Gatid, Sta. Cruz, Laguna	c/o South Luzon Field Office	02-9260733 Loc 202
RFU IVA	Laguna	Castasus Farm	San Vicente, San pedro, Laguna	c/o South Luzon Field Office	02-9260733 Loc 202
RFU IVA	Laguna	Dairy Training & Research Institute	University of the Philippines Los Baños College Laguna	c/o South Luzon Field Office	02-9260733 Loc 202
RFU IVA	Laguna	Dairy Training & Research Institute	University of the Philippines Los Baños College Laguna	c/o South Luzon Field Office	02-9260733 Loc 202
RFU IVA	Laguna	Sofio Kamatoy	Sta. Cruz, Laguna	c/o South Luzon Field Office	02-9260733 Loc 202
RFU IVA	Laguna	Hacienda Macalauan	Calauan, Laguna	c/o South Luzon Field Office	02-9260733 Loc 202
RFU IVA	Laguna	REAL FRESH DAIRY FARMS, INC.	Calauan, Laguna	c/o South Luzon Field Office	02-9260733 Loc 202
RFU IVA	Laguna	Phil. Carabao Center - UPLB	UPLB, Laguna	c/o South Luzon Field Office	02-9260733 Loc 202
RFU IVA	Laguna	Milk Star	Maharlika Highway, Alaminos, Laguna	c/o South Luzon Field Office	02-9260733 Loc 202
RFU IVA	Laguna	Center for Rural Tech. and Dev't.	San Isidro, Calauan, Laguna	c/o South Luzon Field Office	02-9260733 Loc 202
RFU IVA	Laguna	SALBA Dairy Coop	Brgy. San Antonio II, SPC, Laguna	Baltazar Montiel	(049) 536-35-48
RFU IVA	Laguna	Malinao Marketing MPC	Brgy. San Lucas 2, SPC, Laguna	Baltazar Montiel	(049) 536-35-48
RFU IVA	Laguna	FROILAN GUILATCO FARM	Villa Antonio, San Gabriel, San Pablo City, Philippines	c/o South Luzon Field Office	02-9260733 Loc 202
RFU IVA	Laguna	FROILAN GUILATCO FARM	Villa Antonio, San Gabriel, San Pablo City, Philippines	c/o South Luzon Field Office	02-9260733 Loc 202
RFU IVA	Laguna	Malinao Marketing MPC	Brgy. San Lucas 2, SPC, Laguna	Baltazar Montiel	(049) 536-35-48
RFU IVA	Batangas	PADRE GARCIA	Banaba, Padre Garcia, Batangas	c/o South Luzon Field Office	02-9260733 Loc 202
RFU IVA	Batangas	TARNATE FARM	Lipa City, Batangas	c/o South Luzon Field Office	02-9260733 Loc 202
RFU IVA	Batangas	ST. ELMON'S FARM	Calo, Nasugbu, Batangas	c/o South Luzon Field Office	02-9260733 Loc 202
RFU IVA	Batangas	Rotary Club - Tanuan (RCT)	Brgy Janopol, Tanauan, Batangas	c/o South Luzon Field Office	02-9260733 Loc 202

Region	Province	Name of Cooperative	Address	Contact Person	Phone No.
RFU IVA	Batangas	BADACO MULTIPLIER FARM	Inosluban, Lipa City	c/o South Luzon Field Office	02-9260733 Loc 202
RFU IVA	Batangas	TANAUAN - LGU	Tanauan, Batangas	c/o South Luzon Field Office	02-9260733 Loc 202
RFU IVA	Batangas	PABAKA MP Coop	Brgy. Sinala, Bauan, Batangas	c/o South Luzon Field Office	02-9260733 Loc 202
RFU IVA	Batangas	St. Francis Coconut Farmers MPC	San Francisco, Sto. Tomas, Batangas	c/o South Luzon Field Office	02-9260733 Loc 202
RFU IVA	Batangas	PABAKA MP Coop	Brgy. Sinala, Bauan, Batangas	c/o South Luzon Field Office	02-9260733 Loc 202
RFU IVA	Batangas	KIWI FARM	Calamias, Ibaan, Batangas	c/o South Luzon Field Office	02-9260733 Loc 202
RFU IVA	Batangas	St. Francis Coconut Farmers MPC	San Francisco, Sto. Tomas, Batangas	c/o South Luzon Field Office	02-9260733 Loc 202
RFU IVA	Batangas	BADACO MULTIPLIER FARM	Inosluban, Lipa City	c/o South Luzon Field Office	02-9260733 Loc 202
RFU IVA	Batangas	Batangas Dairy Coop	Inosluban, Lipa City	c/o South Luzon Field Office	02-9260733 Loc 202
RFU IVA	Batangas	TANAUAN - LGU	Tanauan, Batangas	c/o South Luzon Field Office	02-9260733 Loc 202
RFU IVA	Rizal	GABRIEL BAUTISTA FARM (Arflo Livestock & Breeding Farms)	Sitio Bathala, Brgy. Plaza Aldea, Tanay , Rizal Philippines	c/o South Luzon Field Office	02-9260733 Loc 202
RFU IVA	Rizal	PAMANA / KANLUNGAN (Dra. Azansa)	Sampaloc, Tanay, Rizal	c/o South Luzon Field Office	02-9260733 Loc 202
RFU IVA	Cavite	UNIFEM PROJECT	Cavite	c/o South Luzon Field Office	02-9260733 Loc 202
RFU IVA	Cavite	Naic Primary Dairy Coop	Sabang, Naic, Cavite	c/o South Luzon Field Office	02-9260733 Loc 202
RFU IVA	Cavite	D. Mores (Tanza Dairy Coop)	Tanza, Cavite	c/o South Luzon Field Office	02-9260733 Loc 202
RFU IVA	Cavite	General Trias Dairy Raisers MPC	Cavite	c/o South Luzon Field Office	02-9260733 Loc 202
RFU IVA	Cavite	Agrarian Reform Cooperative	Naic, Cavite	c/o South Luzon Field Office	02-9260733 Loc 202
RFU IVA	Cavite	Imus Marketing Dairy Coop	Malagasang I, Imus Cavite	c/o South Luzon Field Office	02-9260733 Loc 202
RFU IVA	Cavite	I. Tengco	Naic, Cavite	c/o South Luzon Field Office	02-9260733 Loc 202
RFU IVA	Cavite	Naic Primary Dairy Coop	Sabang, Naic, Cavite	c/o South Luzon Field Office	02-9260733 Loc 202

Region	Province	Name of Cooperative	Address	Contact Person	Phone No.
RFU IVA	Cavite	E. Valencia	Navarro, Gen. Trias, Cavite	c/o South Luzon Field Office	02-9260733 Loc 202
RFU IVA	Cavite	C. Dela Cruz	Naic, Cavite	c/o South Luzon Field Office	02-9260733 Loc 202
RFU IVA	Cavite	Leoncio Jarin	Cavite	c/o South Luzon Field Office	02-9260733 Loc 202
RFU IVA	Cavite	Victoria's Farm (Mr. Lee)	Bucal, Silang Cavite	c/o South Luzon Field Office	02-9260733 Loc 202
RFU IVA	Cavite	Naic Primary Dairy Coop	Sabang, Naic, Cavite	c/o South Luzon Field Office	02-9260733 Loc 202
RFU IVA	Cavite	C. Dela Cruz	Naic, Cavite	c/o South Luzon Field Office	02-9260733 Loc 202
RFU IVA	Cavite	Agrarian Reform Cooperative	Naic, Cavite	c/o South Luzon Field Office	02-9260733 Loc 202
RFU IVA	Cavite	E. Valencia	Navarro, Gen. Trias, Cavite	c/o South Luzon Field Office	02-9260733 Loc 202
RFU IVA	Cavite	Leoncio Jarin	Cavite	c/o South Luzon Field Office	02-9260733 Loc 202
RFU IVA	Cavite	Langkaan I, Dasma, Cavite	Cavite	c/o South Luzon Field Office	02-9260733 Loc 202
RFU IVA	Cavite	J. Masikap (TANZA DAIRY COOP.)	Tanza, Cavite	c/o South Luzon Field Office	02-9260733 Loc 202
RFU IVA	Cavite	Bayani Tapawan	Langkaan I, Dasmaringas, Cavite	c/o South Luzon Field Office	02-9260733 Loc 202
RFU IVA	Cavite	Tirzo Dela Cruz	Naic, Cavite	c/o South Luzon Field Office	02-9260733 Loc 202
RFU IVA	Cavite	H. Estanque	Naic, Cavite	c/o South Luzon Field Office	02-9260733 Loc 202
RFU IVA	Cavite	D. Mores (Tanza Dairy Coop)	Tanza, Cavite	c/o South Luzon Field Office	02-9260733 Loc 202
RFU IVA		Fernando Mendoza	San Francisco, Gen. Trias Cavite	c/o South Luzon Field Office	02-9260733 Loc 202
RFU IVB	Oriental Mindoro	Pinamalayan	Sta. Isabel, Pinamalayan, Oriental Mindoro	c/o South Luzon Field Office	02-9260733 Loc 202
RFU IVB	Palawan	DA-RFU-IV Palawan Research Outreach Station (DPDP)	Irawan, Puerto Princesa, Palawan	c/o South Luzon Field Office	02-9260733 Loc 202
RFU IVB	Palawan	San Vicente - LGU	Kemdeng, San Vicente, Palawan	c/o South Luzon Field Office	02-9260733 Loc 202
RFU IVB	Palawan	Luzviminda Dairy Coop	Luzviminda, Puerto Princesa City Palawan	c/o South Luzon Field Office	02-9260733 Loc 202

Region	Province	Name of Cooperative	Address	Contact Person	Phone No.
RFU V	Albay	Canaway Farm (CONG. EDCEL LAGMAN) - ANTON BURSE	CANAWAY, MALILIPOT, ALBAY	c/o South Luzon Field Office	02-9260733 Loc 202
RFU V	Albay	Albay Dairy Farmers MPC	c/o Albay Dairy Plant, Brgy. Cabangán, Camalig, Albay	c/o South Luzon Field Office	02-9260733 Loc 202
RFU V	Albay	Bicol Univ. - College of Agric'l. Forestry	BUCAF, Guinobatan, Albay Philippines	c/o South Luzon Field Office	02-9260733 Loc 202
RFU V	Albay	Albay Breeding Station	Brgy. Cabangán, Camalig, Albay	c/o South Luzon Field Office	02-9260733 Loc 202
RFU V	Camarines Norte	Cahabaan Multi-purpose Coop.	Brgy. Cahabaan, Talisay, Camarines Norte	c/o South Luzon Field Office	02-9260733 Loc 202
RFU V	Camarines Norte	Provincial Government of Camarines Norte	Basud, Camarines Norte	c/o South Luzon Field Office	02-9260733 Loc 202
RFU V	Camarines Sur	GUINABAN MULTI-PURPOSE COOP. (GMPC)	Guinabaan, Ocampo, Camarines Sur Philippines	c/o South Luzon Field Office	02-9260733 Loc 202
RFU V	Camarines Sur	Camarines Sur Dairy Zone MPC	San Jose, Pili, Camarines Sur	c/o South Luzon Field Office	02-9260733 Loc 202
RFU V	Camarines Sur	Pili Dairy Development Cooperative (PDDC)	Zone 2 Caroyroyan, Pili, Camarines Sur Philippines	c/o South Luzon Field Office	02-9260733 Loc 202
RFU V	Camarines Sur	Sagnay Dairy Development Cooperative -SDDC (Formerly MCF& LRB MPC)	Minadongjol, Sagnay, Camarines Sur Philippines	c/o South Luzon Field Office	02-9260733 Loc 202
RFU V	Camarines Sur	Goa Dairy MPC	Brgy. Abucayan, Goa, Camarines Sur Philippines	c/o South Luzon Field Office	02-9260733 Loc 202
RFU V	Camarines Sur	Mayor Marcel S. Pan (GOA)	Brgy. Abucayan, Goa, Camarines Sur Philippines	c/o South Luzon Field Office	02-9260733 Loc 202
RFU V	Camarines Sur	PAMANA ng KABACAS MPC	Manguiring, Calabanga, Camarines Sur Philippines	c/o South Luzon Field Office	02-9260733 Loc 202
RFU V	Camarines Sur	SAN ISIDRO DEVT. COOP. (SIDE CO)	San Isidro, Naga City, Camarines Sur	c/o South Luzon Field Office	02-9260733 Loc 202
RFU V	Camarines Sur	Goa Dairy MPC	Brgy. Abucayan, Goa, Camarines Sur Philippines	c/o South Luzon Field Office	02-9260733 Loc 202
RFU V	Masbate	FAZENDA	BRGY BANGAD, MILAGROS, MASBATE	c/o South Luzon Field Office	02-9260733 Loc 202
RFU V	Sorsogon	Sorsogon Dairy Farm	SDF, Brgy. Cabid-an, Sorsogon, Sorsogon	Ellen Escurel	(056) 211-36-44
RFU V	Sorsogon	SILMUDECO (formerly SOLIFATEC)	c/o SDF, Brgy. Cabid-an, Sorsogon, Sorsogon	c/o South Luzon Field Office	02-9260733 Loc 202
RFU VI	Aklan	Florencio Miraflores	Ibajay, Aklan	c/o Visayas Field Office	(032)345-3612
RFU VI	Antique	Belison Multipurpose Coop	Poblacion, Belison, Antique	c/o Visayas Field Office	(032)345-3612
RFU VI	Capiz	Capiz State University	Bailan, Pontevedra Capiz	c/o Visayas Field Office	(032)345-3612

Region	Province	Name of Cooperative	Address	Contact Person	Phone No.
RFU VI	Iloilo	Pandan, Anonang, Agboy, Buenavista, Omambong & Talacuan (PAABOT) Dairy Development Cooperative	Anonang, Leon, Iloilo	Angel Tidula	0906-1992299; 0908-4076435
RFU VI	Iloilo	Alimodian Dairy Multipurpose Cooperative	Binalud, Alimodian, Iloilo	Angel Tidula	0906-1992299; 0908-4076435
RFU VI	Iloilo	Tigbauan Fisheries and Farmers Multi-purpose Coop.	Boyuan, Tigbauan, Iloilo	Angel Tidula	0906-1992299; 0908-4076435
RFU VI	Iloilo	Alimodian Dairy Multipurpose Cooperative	Binalud, Alimodian, Iloilo	Angel Tidula	0906-1992299; 0908-4076435
RFU VI	Iloilo	Tigbauan Fisheries and Farmers Multi-purpose Coop.	Boyuan, Tigbauan, Iloilo	Angel Tidula	0906-1992299; 0908-4076435
RFU VI	Iloilo	Cordova Norte Multi-Purpose Cooperative	Cordova Norte, Tigbauan, Iloilo City	Angel Tidula	0906-1992299; 0908-4076435
RFU VI	Iloilo	Cabatuan Dairy Farmers Dev't. Cooperative	Tigbauan Road, Cabatuan, Iloilo	Angel Tidula	0906-1992299; 0908-4076435
RFU VI	Iloilo	Vatabaca Dairy Dev't Coop. (formerly Miag-ao Dairy Prod. Association)	Valencia, Miag-ao, Iloilo	Angel Tidula	0906-1992299; 0908-4076435
RFU VI	Iloilo	Lambunao Breeding Station	Lambunao, Iloilo	c/o Visayas Field Office	(032)345-3612
RFU VI	Iloilo	JOCA Dairy Dev't Coop (formerly Igbaras Dairy Farmers Association)	Jovellar, Igbaras, Iloilo	Angel Tidula	0906-1992299; 0908-4076435
RFU VI	Iloilo	Philippine Carabao Center - Iloilo	Calinog, Iloilo	c/o Visayas Field Office	(032)345-3612
RFU VI	Iloilo	SIGPA Dairy Farmers Development Cooperative	Oluangan, Leon, Iloilo	Angel Tidula	0906-1992299; 0908-4076435
RFU VI	Iloilo	Guimbal Development Cooperative	Camangahan, Guimbal, Iloilo	Angel Tidula	0906-1992299; 0908-4076435
RFU VI	Iloilo	Ajuy & Barotac Viejo	Iloilo City	c/o Visayas Field Office	(032)345-3612
RFU VI	Negros Occidental	San Isidro Agrarian Reform Beneficiaries MPC	San Isidro, Pontevedra Negros Occidental	Rosendo R. Ocido	0907-2873120
RFU VI	Negros Occidental	San Isidro Multi-Purpose Cooperative	San Isidro, Pontevedra Negros Occidental	Rosendo R. Ocido	0907-2873120
RFU VI	Negros Occidental	PCC - Negros Occ.	La Granja, La Carlota City, Negros Occidental	c/o Visayas Field Office	(032)345-3612
RFU VI	Negros Occidental	Guinpanaan Community Credit Cooperative	Guinpanaan, Moises Padilla Negros Occidental	Rosendo R. Ocido	0907-2873120

Region	Province	Name of Cooperative	Address	Contact Person	Phone No.
RFU VI	Negros Occidental	Provincial Livestock Breeding Center and Dairy Farm (La Granja)	La Granja, La Carlota City, Negros Occidental	c/o Visayas Field Office	(032)345-3612
RFU VI	Negros Occidental	San Enrique MPC	Batuan, San Enrique, Negros Occidental	Rosendo R. Ocido	0907-2873120
RFU VI	Negros Occidental	Sipalay Breeding Center	Sipalay, Negros Occidental	c/o Visayas Field Office	(032)345-3612
RFU VI	Negros Occidental	Cod-cod Agrarian Reform Community Cooperative	Cod-cod, San Carlos City	c/o Visayas Field Office	(032)345-3612
RFU VI	Negros Occidental	Barangay Odiong Farmers Association, Inc.	Odiong, Moises Padilla Negros Occidental	Rosendo R. Ocido	0907-2873120
RFU VI	Negros Occidental	Cod-cod Multi-purpose Cooperative	Cod-cod, San Carlos City	Rosendo R. Ocido	0907-2873120
RFU VI	Negros Occidental	Bayabas Multipurpose Cooperative	Bayabas, Valladolid, Negros Occidental	c/o Visayas Field Office	(032)345-3612
RFU VI	Negros Occidental	Sibucan Multi-purpose Cooperative	Sibucan, San Enrique Negros Occidental	Rosendo R. Ocido	0907-2873120
RFU VI	Negros Occidental	Hacienda Vizcaya Multi-Purpose Cooperative	Gomez, Pontevedra Negros Occidental	Rosendo R. Ocido	0907-2873120
RFU VI	Negros Occidental	Hacienda Layagon Multi-Purpose Cooperative	Lalagsan, La Castellana Negros Occidental	Rosendo R. Ocido	0907-2873120
RFU VI	Negros Occidental	Recreo Multi-Purpose Cooperative	Recreo, Pontevedra Negros Occidental	Rosendo R. Ocido	0907-2873120
RFU VI	Negros Occidental	Mansalayao Small Farmers Association	Nato, La Castellana Negros Occidental	Rosendo R. Ocido	0907-2873120
RFU VI	Negros Occidental	La Granja Farmers Multi-purpose Cooperative	La Granja, La Carlota City, Negros Occidental	Rosendo R. Ocido	0907-2873120
RFU VI	Negros Occidental	Maquiling Buffalo Project Group	Maquiling, Sagay City, Negros Occidental	c/o Visayas Field Office	(032)345-3612
RFU VI	Negros Occidental	Sagay City Breeding Farm	Sagay City, Negros Occidental	c/o Visayas Field Office	(032)345-3612
RFU VI	Negros Occidental	ECJ Farmworkers Agrarian Reform MPC	Baliwagan, San Enrique Negros Occidental	Rosendo R. Ocido	0907-2873120
RFU VI	Negros Occidental	Animal Breeding & Genetic Improvement Center (ABGIC)	Camingawan, Kabankalan City, Negros Occidental	c/o Visayas Field Office	(032)345-3612
RFU VI	Negros Occidental	Makabayan Multi-purpose Cooperative	Poblacion, Pontevedra, Negros Occidental	Rosendo R. Ocido	0907-2873120
RFU VI	Negros Occidental	ECJ Dairy Farm	Negros Occidental	c/o Visayas Field Office	(032)345-3612

Region	Province	Name of Cooperative	Address	Contact Person	Phone No.
RFU VI	Negros Occidental	Talaptap Irrigators Association	Talaptap, La Castellana Negros Occidental	Rosendo R. Ocido	0907-2873120
RFU VI	Negros Occidental	Pontevedra Breeding Center	San Isidro, Pontevedra Negros Occidental	c/o Visayas Field Office	(032)345-3612
RFU VI	Negros Occidental	LGM Agro Farm	Pontevedra, Negros Occidental	c/o Visayas Field Office	(032)345-3612
RFU VII	Negros Occidental	Engr. Alfonso Teves Farm / Metro Dumaguete	Camanhac, Dumaguete City, Negros Oriental	c/o Visayas Field Office	(032)345-3612
RFU VII	Bohol	PCC-Ubay	Ubay, Bohol	c/o Visayas Field Office	(032)345-3612
RFU VII	Bohol	Ubay Mutiplier Farm	Calanggaman, Ubay, Bohol	c/o Visayas Field Office	(032)345-3612
RFU VII	Bohol	Ubay Stock Farm	Lumangog, Ubay Bohol	c/o Visayas Field Office	(032)345-3612
RFU VII	Bohol	Cantubod Association for the Rehabilitation of Environment (CARE)	Danao, Bohol	c/o Visayas Field Office	(032)345-3612
RFU VII	Siquijor	Kababayan-an Alang sa Pagpalambo sa Nasudnong Industriya sa Gatas (KAPANIG) MPC (merger of TRIC, BARUG & WONDER)	Cangmunag, San Juan, Siquijor	Gloria Ontoy	(035) 481-5017
RFU VII	Cebu	Barangay Unity Key to Integrated Development (BUKID) MPC	Magsaysay, Balamban, Cebu	Mr. Bienvenido Rodriguez	(032) 564-2598
RFU VII	Cebu	Awihaw - Sagay MPC	Sagay, Toledo City Cebu	Mr. Bienvenido Rodriguez	(032) 564-2598
RFU VII	Cebu	AMLAN DAIRY FARMERS ASS.	Poblacion, Amlan, Negros Oriental	Joselito A. Sapuan	(035)422-3436; 0906-23972345; 0939-6028133
RFU VII	Cebu	Tabok MP Dev't. Coop (TAMDECO)	Tabok, Danao City Cebu	Mr. Bienvenido Rodriguez	(032) 564-2598
RFU VII	Cebu	Lupa, Compostela, Cebu	Lupa, Compostela, Cebu	c/o Visayas Field Office	(032)345-3612
RFU VII	Cebu	Dalaguete - LGU	Dugyan, Dalaguete Cebu	c/o Visayas Field Office	(032)345-3612
RFU VII	Cebu	Panas Consumers Coop	Panas, Consolacion Cebu	Mr. Bienvenido Rodriguez	(032) 564-2598
RFU VII	Cebu	Argao Dairy MPC	CSCST-Argao Campus, Argao, Cebu	Mr. Bienvenido Rodriguez	(032) 564-2598
RFU VII	Cebu	Tayud Dairy Producers Coop	Tayud, Liloan, Cebu	Mr. Bienvenido Rodriguez	(032) 564-2598
RFU VII	Cebu	Garing Dairy Producers Coop	Garing, Consolacion, Cebu	Mr. Bienvenido Rodriguez	(032) 564-2598
RFU VII	Cebu	Lusaran MPC (formerly Alayon Farmers Association)	Lusaran, Cebu City	Mr. Bienvenido Rodriguez	(032) 564-2598
RFU VII	Cebu	COBCAWA Consumers Coop	Cobcawa, Adlawon, Cebu City	Mr. Bienvenido Rodriguez	(032) 564-2598
RFU VII	Cebu	San Vicente Dairy Producers Coop	San Vicente, Liloan, Cebu	Mr. Bienvenido Rodriguez	(032) 564-2598

Region	Province	Name of Cooperative	Address	Contact Person	Phone No.
RFU VII	Cebu	Sirao Farmers MPC	Sirao, Cebu City	Mr. Bienvenido Rodriguez	(032) 564-2598
RFU VII	Cebu	Unchuan Farm	Cabcaban, Barili, Cebu	c/o Visayas Field Office	(032)345-3612
RFU VII	Cebu	Lamac Multi-purpose Cooperative	Lamac, Pinamungahan, Cebu	Mr. Bienvenido Rodriguez	(032) 564-2598
RFU VII	Cebu	Bairan Multipurpose Cooperative	Bairan, Naga Cebu	c/o Visayas Field Office	(032)345-3612
RFU VII	Cebu	Consolacion Teachers Multi-purpose Coop	Poblacion, Consolacion Cebu	Mr. Bienvenido Rodriguez	(032) 564-2598
RFU VII	Cebu	Basak Farmers Multi-purpose Cooperative	Basak, Compostela Cebu	Mr. Bienvenido Rodriguez	(032) 564-2598
RFU VII	Cebu	Tag-ubi Dairy Farmers Multi-Purpose Cooperative	Tag-ubi, Compostela, Cebu	Mr. Bienvenido Rodriguez	(032) 564-2598
RFU VII	Cebu	GUBA Farmers MPC	Guba, Cebu City	Mr. Bienvenido Rodriguez	(032) 564-2598
RFU VII	Cebu	Tagbao Farmers Association	Tagbao, Cebu City	Mr. Bienvenido Rodriguez	(032) 564-2598
RFU VII	Cebu	Cabcaban Farmers MPC	Cabcaban, Barili Cebu	Mr. Bienvenido Rodriguez	(032) 564-2598
RFU VII	Cebu	Binaliw Farmers Producers Cooperative	Binaliw, Danao City Cebu	Mr. Bienvenido Rodriguez	(032) 564-2598
RFU VII	Negros Oriental	Foundation University Amlan Farm	Amlan, Negros Oriental	c/o Visayas Field Office	(032)345-3612
RFU VII	Negros Oriental	Siliman University	Bantayan, Dumaguete City	c/o Visayas Field Office	(032)345-3612
RFU VII	Negros Oriental	Sta. Catalina Dairy Farmers Association	Negros Oriental	c/o Visayas Field Office	(032)345-3612
RFU VII	Negros Oriental	San Antonio Community-Agriculture Farmers MPC	San Antonio, Sibulan, Negros Oriental	Joselito A. Sapuan	(035)422-3436; 0906-23972345; 0939-6028133
RFU VII	Negros Oriental	Pamplona - LGU / Libertad	Poblacion, Pamplona, Negros Oriental Philippines	c/o Visayas Field Office	(032)345-3612
RFU VII	Negros Oriental	PAMPLONA DAIRY FARMERS ASS.	Balayong, Negros Oriental	Joselito A. Sapuan	(035)422-3436; 0906-23972345; 0939-6028133
RFU VII	Negros Oriental	Valencia - LGU	Poblacion, Valencia, Negros Oriental Philippines	c/o Visayas Field Office	(032)345-3612
RFU VII	Negros Oriental	Canlaon City Dairy Farmers Association	Canlaon City	Joselito A. Sapuan	(035)422-3436; 0906-23972345; 0939-6028133

Region	Province	Name of Cooperative	Address	Contact Person	Phone No.
RFU VII	Negros Oriental	Valencia Dairy Producers Association	North Poblacion, Valencia, Negros Oriental Philippines	Joselito A. Sapuan	(035)422-3436; 0906-23972345; 0939-6028133
RFU VII	Negros Oriental	DAUIN DAIRY FARMERS ASS.	Masaplod Sur, Negros Oriental	Joselito A. Sapuan	(035)422-3436; 0906-23972345; 0939-6028133
RFU VII	Negros Oriental	BAIS Breeding Farm	City Agriculture Office, Bais City, Negros Oriental	c/o Visayas Field Office	(032)345-3612
RFU VII	Negros Oriental	Dairy Farmers Association of Dumaguete City	Bajumpandan, Dumaguete City	Joselito A. Sapuan	(035)422-3436; 0906-23972345; 0939-6028133
RFU VII	Negros Oriental	Bayawan City Dairy Farmers Association	City Vet Office, Villareal, Bayawan City Negros Oriental	Joselito A. Sapuan	(035)422-3436; 0906-23972345; 0939-6028133
RFU VII		Bacong Dairy Farmers Ass. (BADAFA)	Poblacion, Bacong, Negros Oriental	Joselito A. Sapuan	(035)422-3436; 0906-23972345; 0939-6028133
RFU VIII	Biliran	Barangay Calumpang Milkers Association	Calumpang, Naval, Biliran	c/o Visayas Field Office	(032)345-3612
RFU VIII	Biliran	Biliran	Biliran, Biliran	c/o Visayas Field Office	(032)345-3612
RFU VIII	Leyte	BIMCUSA (Boroc, Maticaa, Curva, UFBA)	Cogon, Ormoc City, Leyte	c/o Visayas Field Office	(032)345-3612
RFU VIII	Leyte	Camalig Agricultural MPC	Lonoy, Kananga, Leyte	c/o Visayas Field Office	(032)345-3612
RFU VIII	Leyte	Holy Infant Dairy Cooperative (HIDCO)	Merida, Leyte	c/o Visayas Field Office	(032)345-3612
RFU VIII	Leyte	Melchor Larrazabal Farm	Tongonan, Ormoc City	c/o Visayas Field Office	(032)345-3612
RFU VIII	Leyte	Manlilinao Agricultural MPC	Manlilinao, Ormoc City, Leyte	c/o Visayas Field Office	(032)345-3612
RFU VIII	Leyte	Occidental Leyte Dairy Primary MPC	Bayong St., Cogon, Ormoc City, Leyte	c/o Visayas Field Office	(032)345-3612
RFU VIII	Leyte	Philippine Carabao Center (PCC - LSU)	LSU, Baybay, Leyte	c/o Visayas Field Office	(032)345-3612
RFU VIII	Southern Leyte	Sogod- LGU	Cahupian, Sogod, Southern Leyte	c/o Visayas Field Office	(032)345-3612
RFU VIII	Southern Leyte	Floredeliz Farmers Multipurpose Coop. (MACROHON)	Flordeliz, Macrohon	c/o Visayas Field Office	(032)345-3612

Region	Province	Name of Cooperative	Address	Contact Person	Phone No.
RFU IX	Zamboanga del Norte	D' Village Multi-Purpose Coop.	Dohinob, Roxas, Zamboanga del Norte	Marife M. Olib	0921-6175214
RFU IX	Zamboanga del Norte	Camul Tampilisan Agrarian Reform Beneficiary MPC	Tampilisan, Zamboanga del Norte	c/o Mindanao Field Office	(088)233-3998
RFU IX	Zamboanga del Norte	Phil. Carabao Center (PCC-Kalawit)	Poblacion Kalawit, Zamboanga del Norte	c/o Mindanao Field Office	(088)233-3998
RFU IX	Zamboanga del Sur	Danluga Multi-Purpose Coop.	Danluga, Pagadian City, Zamboanga del Sur	c/o Mindanao Field Office	(088)233-3998
RFU IX	Zamboanga Sibugay	Minsulao Farmers MPC	Minsulao, Siay, Zamboanga Sibugay	c/o Mindanao Field Office	(088)233-3998
RFU IX	Zamboanga City	NJB FARMS	Ayala, Zamboanga City	c/o Mindanao Field Office	(088)233-3998
RFU X	Bukidnon	Maluko Multi-purpose Dairy Coop	Maluko, Manolo Fortich, Bukidnon	Ms. Wilma Buray	(08822) 75-52-35
RFU X	Bukidnon	Allied Neighborhood Multi-purpose Coop. (Alnempco)	New Sankan, Manolo Fortich, Bukidnon	c/o Mindanao Field Office	(088)233-3998
RFU X	Bukidnon	Borja Dairy Farm (Mannix animals)	Kawayan, Lantapan, Bukidnon	c/o Mindanao Field Office	(088)233-3998
RFU X	Bukidnon	ROY DAL FARM	Kisolon, Sumilao, Bukidnon	c/o Mindanao Field Office	(088)233-3998
RFU X	Bukidnon	Dalwangan Multi-purpose Dairy Coop.	Dalwangan, Malaybalay, Bukidnon		(08822) 75-52-35
RFU X	Bukidnon	People of the Living God (PLG)	Malitbog, Bukidnon	c/o Mindanao Field Office	(088)233-3998
RFU X	Bukidnon	Baungon Integrated Dairy Coop. (BIDACO)	Imbatug, Baungon, Bukidnon	Marlene Bautista	926-9011783
RFU X	Bukidnon	Kisolon-Impasug-ong Multi-purpose Coop	Impasug-ong, Bukidnon	Ms. Wilma Buray	(08822) 75-52-35
RFU X	Bukidnon	CMU	Musuan, Maramag, Bukidnon	c/o Mindanao Field Office	(088)233-3998
RFU X	Bukidnon	Compact Farm (Owned by NMFDC)	Kinawe, Libona, Bukidnon	c/o Mindanao Field Office	(088)233-3998
RFU X	Bukidnon	Phil. Carabao Center (PCC-Bukidnon)	Musuan, Maramag, Bukidnon	c/o Mindanao Field Office	(088)233-3998
RFU X	Bukidnon	NABC	Dalwangan, Malaybalay, Bukidnon	c/o Mindanao Field Office	(088)233-3998
RFU X	Bukidnon	DAR-MINSSAD	DAR-MARO, Poblacion, Pangantucan, Bukidnon	c/o Mindanao Field Office	(088)233-3998
RFU X	Bukidnon	Manolo Fortich Dairy Coop	Manolo Fortich, Bukidnon	Ms. Wilma Buray	(08822) 75-52-35
RFU X	Bukidnon	Del Monte Phils., Inc.	Kawayan, Manolo Fortich, Bukidnon	c/o Mindanao Field Office	(088)233-3998
RFU X	Lanao del Norte	Lanao del Norte Foundation, Inc.	Bauyan, Sultan Naga Dimaporo, Lanao del Norte	c/o Mindanao Field Office	(088)233-3998
RFU X	Lanao del Norte	ILIGAN - LGU	Tangub City, Lanao del Norte	c/o Mindanao Field Office	(088)233-3998

Region	Province	Name of Cooperative	Address	Contact Person	Phone No.
RFU X	Lanao del Norte	Mahayahay Farmers Integrated Cooperative (MAFICO)	Kapatagan, Lanao del Norte	c/o Mindanao Field Office	(088)233-3998
RFU X	Misamis Occidental	LORENZO TAN COOP	Lorenzo Tan, Tangub City, Misamis Occidental	c/o Mindanao Field Office	(088)233-3998
RFU X	Misamis Occidental	Walter Lao	Viray, Molikay, Ozamis City, Misamis Occidental	c/o Mindanao Field Office	(088)233-3998
RFU X	Misamis Oriental	Claveria Livestock Raisers	Patroceno, Claveria, Misamis Oriental	Ms. Wilma Buray	(08822) 75-52-35
RFU X	Misamis Oriental	Villanueva Dairy Raisers MPC	Kalingagan, Villanueva, Misamis Oriental	Ms. Wilma Buray	(08822) 75-52-35
RFU X	Misamis Oriental	Jimenez - LGU	Matugas Alto, Jimenez, Misamis Occidental	c/o Mindanao Field Office	(088)233-3998
RFU X	Misamis Oriental	PASTOR NIETES GOAT FARM	Naawan, Misamis Oriental	c/o Mindanao Field Office	(088)233-3998
RFU X	Misamis Oriental	Naawan-LGU	Agri Dev't, Poblacion, Naawan, Misamis Oriental	c/o Mindanao Field Office	(088)233-3998
RFU X	Misamis Oriental	CHONA'S GOAT FARM	Awang, Opol, Misamis Oriental	c/o Mindanao Field Office	(088)233-3998
RFU X	Misamis Oriental	Cagayan de Oro., Opol, El Salvador MPC	33 J Serina St. Carmen	Ms. Wilma Buray	(08822) 75-52-35
RFU X	Misamis Oriental	KHLEAS GOAT FARM	Amoros, El Salvador, Misamis Oriental	c/o Mindanao Field Office	(088)233-3998
RFU X	Misamis Oriental	BALAY MINDANAW FOUNDATION	Kalawitan, Claveria, Misamis Oriental	c/o Mindanao Field Office	(088)233-3998
RFU X	Misamis Oriental	TACBO-COCO DAIRY MPC, INC.	Bolisong, El Salvador, Misamis Oriental	c/o Mindanao Field Office	(088)233-3998
RFU X	Misamis Oriental	Opol Dairy Multi-purpose Coop (ODAMCO) formerly OPWATRANSCO	Opol, Misamis Oriental	Ms. Wilma Buray	(08822) 75-52-35
RFU X	Misamis Oriental	LGU-GINGOOG CITY (Cong. Peter Unabia)	Misamis Oriental	c/o Mindanao Field Office	(088)233-3998
RFU X	Misamis Oriental	Lumbia Farmer's Coop.	Lumbia, CDO, Misamis Oriental	Ms. Wilma Buray	(08822) 75-52-35
RFU X	Misamis Oriental	XAVIER University College of Agriculture	Cagayan de Oro City	c/o Mindanao Field Office	(088)233-3998
RFU X	Misamis Oriental	LGU-TALISAYAN (Cong. Peter Unabia)	Misamis Oriental	c/o Mindanao Field Office	(088)233-3998
RFU X	Misamis Oriental	CAMARUC GOAT FARM	Camaroc, Opol, Misamis Oriental	c/o Mindanao Field Office	(088)233-3998

Region	Province	Name of Cooperative	Address	Contact Person	Phone No.
RFU X	Misamis Oriental	4HL Farm	Purok 6 Don Pedro, Naawan, Misamis Oriental	c/o Mindanao Field Office	(088)233-3998
RFU X	Misamis Oriental	CAULAYANAN DAIRY & LIVESTOCK COOP.	Caulayanan, Sugbongcogon, Misamis Oriental	c/o Mindanao Field Office	(088)233-3998
RFU XI	Davao del Norte	NEST FARM	Panabo, Davao del Norte	c/o Mindanao Field Office	(088)233-3998
RFU XI	Davao del Norte	SAN ISIDRO DAIRY FARMERS MULTI-PURPOSE COOP (SDFMPC) formerly SIARBCO	San Isidro, Island Garden City of Samal, Davao Del Norte	c/o Mindanao Field Office	(088)233-3998
RFU XI	Davao del Sur	Missionary Baptist Rural Livelihood Center (MBRLC)	Kinuskusan, Bansalan, Davao del Sur	c/o Mindanao Field Office	(088)233-3998
RFU XI	Davao del Sur	Matanao Bansalan Magsaysay Dairy Farmers Coop (MBM-DFC)	Bansalan, Davao del Sur	c/o Mindanao Field Office	(088)233-3998
RFU XI	Davao del Sur	ST. BENEDICTINE FARM	Cogon, Digos City, Davao del Sur	c/o Mindanao Field Office	(088)233-3998
RFU XI	Davao City	Calinan Dairy Farmers Coop (CDFC)	Poblacion Calinan , Dvo. City	Raylyn Sanchez	(082) 3010517
RFU XI	Davao City	Lizada Dairy Farmers Coop (LDFC)	Lizada, Toril District, Dvo. City	Raylyn Sanchez	(082) 3010517
RFU XI	Davao City	Wangan National Agricultural School/TESDA	Wangan, Calinan, Davao City	c/o Mindanao Field Office	(088)233-3998
RFU XI	Davao City	AJML Farm	San Isidro, Bunawan District, Davao City	c/o Mindanao Field Office	(088)233-3998
RFU XI	Davao City	San Isidro Livestock Raisers Association (SILRA)	San Isidro, Bunawan, Davao City	c/o Mindanao Field Office	(088)233-3998
RFU XI	Davao City	Biao Joaquin Dairy Farmers Coop (BJDAFCO)	Biao Joaquin, Calinan District, Davao City	c/o Mindanao Field Office	(088)233-3998
RFU XI	Davao City	Puentespina Farm	Malagos, Baguio District, Davao City	c/o Mindanao Field Office	(088)233-3998
RFU XI	Davao City	Cadalian Dairy Farmers Coop (CADAFCO)	Cadalian Baguio District, Davao City	c/o Mindanao Field Office	(088)233-3998
RFU XI	Davao City	Dacudao Dairy Farmers Coop (DDFC)	Dacudao, Calinan District, Dvo. City	Raylyn Sanchez	(082) 3010517
RFU XI	Davao City	KIM'S Milk	Cadalian, Baguio District, Davao City	c/o Mindanao Field Office	(088)233-3998
RFU XI	Davao City	Tacunan Dairy Farmers Coop (TADAFCO)	Takunan, Marilog District, Davao City	c/o Mindanao Field Office	(088)233-3998
RFU XI	Davao City	Calinan 4-H Dairy Coop (C4HDC)	Calinan District, Davao City	Raylyn Sanchez	(082) 3010517
RFU XI	Davao City	Aklat Dairy Cooperative (ADC)	Aklat, Tamugan, Marilog District Davao City	Raylyn Sanchez	(082) 3010517
RFU XI	Davao City	Cogon NRDP DIAF Dairy Coop (CONDDACO)	Sirawan, Toril District, Dvo. City	Raylyn Sanchez	(082) 3010517

Region	Province	Name of Cooperative	Address	Contact Person	Phone No.
RFU XI	Davao City	Riverside Dairy Farmers Coop (RDFC)	Riverside, Calinan District, Dvo. City	Raylyn Sanchez	(082) 3010517
RFU XI	Davao City	Wangan Dairy Coop (WDC)	Wangan, Calinan District, Davao City	Raylyn Sanchez	(082) 3010517
RFU XI	Davao City	Malagos Dairy Coop (MDC)	Malagos, Baguio District, Davao City	Raylyn Sanchez	(082) 3010517
RFU XII	North Cotabato	KIDAPAWAN Stock Farm	Kidapawan, North Cotabato	c/o Mindanao Field Office	(088)233-3998
RFU XII	North Cotabato	Don Bosco Diocessan Youth Center	Batasan Hills, Makilala, North Cotabato	c/o Mindanao Field Office	(088)233-3998
RFU XII	North Cotabato	Phil. Carabao Center (PCC-USM)	Kabacan, North Cotabato	c/o Mindanao Field Office	(088)233-3998
RFU XII	North Cotabato	Sakdalan Dairy Farm	Alamad, Midsayap, North Cotabato	c/o Mindanao Field Office	(088)233-3998
CAR (Cordillera Administrative Region)	Benguet	Rey Pidazo Group (Baguio City)	Sto. Tomas Road, Barangay Dontogan, Baguio City	c/o North Luzon Field Office	02-9260733 Loc 202
CAR (Cordillera Administrative Region)	Benguet	Tino	Sto. Tomas Road, Barangay Dontogan, Baguio City	c/o North Luzon Field Office	02-9260733 Loc 202
CAR (Cordillera Administrative Region)	Benguet	Erwin San Luis	Sto. Tomas Road, Barangay Dontogan, Baguio City	c/o North Luzon Field Office	02-9260733 Loc 202
CAR (Cordillera Administrative Region)	Benguet	M. High Livestock Cooperative	BDF, Sto. Tomas Road, Barangay Dontogan, Baguio City		02-9260733 Loc 202
CAR (Cordillera Administrative Region)	Benguet	Johnny Adjaro	Sto. Tomas Road, Barangay Dontogan, Baguio City	c/o North Luzon Field Office	02-9260733 Loc 202
Cebu		CSCST-AIFC Countryside Credit Coop	Poblacion, Argao Cebu	Mr. Bienvenido Rodriguez	(032) 564-2598
		Naga School Teachers' Multipurpose Coop	Poblacion, Naga Cebu	Mr. Bienvenido Rodriguez	(032) 564-2598

National Dairy Authority, 2015

Annex B

Republic of the Philippines
Province of _____
City/Municipality of _____

Office of the City / Municipal Mayor

EXECUTIVE ORDER No. 01-2016

AN ORDER CREATING THE INTEGRATED COMMUNITY FOOD PRODUCTION (ICFP) TEAM IN THE CITY / MUNICIPALITY OF _____ FOR THE PURPOSE OF IMPLEMENTING THE ICFP AS A HUNGER MITIGATION PROGRAM UNDER THE BOTTOM-UP BUDGETING FOR 2015 AND 2016

WHEREAS, Pursuant to the general provisions stated in the DBM-DILG-DSWD-NAPC Joint Memorandum Circulars No. 5 and No. 7 dated October 1, 2014 and November 3, 2015, respectively, on the policy guidelines and procedures in the implementation of the Bottom-up Budgeting (BuB) Program for Fiscal Year 2016 and thereafter, the National Anti-Poverty Commission (NAPC) provides the rules and guidelines in implementing the Integrated Community Food Production (ICFP) Program for BuB 2016 and Beyond;

WHEREAS, in conjunction with such provisions above, the Local Government Unit (LGU) of _____ included in their Local Poverty Reduction Action Plan (LPRAP) a proposal on ICFP;

WHEREAS, in order to smoothly implement the project, the Local Government Unit of _____ hereby creates the ICFP Team, which major function is to implement the ICFP based on the approved guidelines of the National Anti-Poverty Commission (NAPC);

WHEREAS, the members of the ICFP Team are the following:

Positions	Name
Local Chief Executive (Mayor)	
LPRAT Co-Chairperson	
City/Municipal Agriculture Office (C/MAO)	
City/Municipal Nutrition Action Officer (C/MNAO)	
ICFP Community Coordinator 1	
ICFP Community Coordinator 2	
ICFP Community Coordinator 3	
ICFP Technical Consultant (ICFP Focal Person)	
CSO LPRAT Member 1	

Positions	Name
CSO LPRAT Member 2	
CSO LPRAT Member 3	
CSO LPRAT Member 4	

NOW, THEREFORE, I, (NAME OF MAYOR), Local Chief Executive of the Local Government Unit of _____, by virtue of powers vested in me by law, do hereby create the ICFP TEAM for this city/municipality to carry on the tasks as provided for in the DILG-NAPC-DSWD-DBM Joint Memorandum Circulars for the implementation of BUB 2016 and Beyond.

This Executive Order shall take effect immediately upon signing

SO ORDERED.

Signed this ____ day of January 2016

Mayor

Annex C

INTEGRATED COMMUNITY FOOD PRODUCTION

Municipality of _____

Province of _____

PROJECT PROPOSAL

I. Project Summary

Project Title	Integrated Community Food Production
Project Proponent	Local Government Unit of _____
Project Location	Barangay _____
Type of Project	Hunger Mitigation Program
Total Number of Beneficiaries	____ households, Male____ Female____
Project Duration	January to December 2016
Contact Person/s	Name: _____ Designation: _____ Contact Number: _____ Email address: _____
Total Project Cost	PHP _____
Budget Requested	PHP _____
LGU Counterpart	PHP _____

II. Project Rationale and Background

Up to this date, many residents of various cities and municipalities in the Philippines can still be classified as food-, nutrition- and income-deficient. This condition is periodically aggravated by climate change, which results to unpredictable weather, increase in planet temperature, decrease in yields, and more natural calamities such as typhoons, floods and drought that continuously affect the country.

(Provide Specific Data on Local Poverty, Hunger, Food and Malnutrition)

Since 2015, the National Anti-Poverty Commission (NAPC) is implementing the Integrated Community Food Production (ICFP) Program under the Bottom-up Budgeting (BuB) process to address the issue on hunger and malnutrition and provide additional source of income for identified poor households.

It aims to expand the food base and promote a sustainable food production and consumption system in food- and nutrition-deficient households or communities. The ICFP program will enable poor people, whether farmers or not, to produce carbohydrate-, vitamin-, mineral-, fiber- and protein-rich foods around their homes.

ICFP Program will provide initial nutritious food to beneficiaries in a period of 2-3 months and a sustainable food supply in a period of one year. The participants will also be trained on how to sustain the project even after termination of the requested program funding. The program will be a “no-regrets” intervention, which has been found to be beneficial in times of calamities as well as under normal times.

The proposed project will not only help poor people, but it will also address the following Millennium Development Goals at the community level: 1) reduce poverty by generating sustainable food for the poor; 2) address the gender concerns as since women will play an active role in producing food and providing income for their families; 3) promote education through massive training and capacity building to expand the food and income base of the needy; and 4) protect the environment through planting of fruit trees which will serve as carbon sink, and through the use of organic fertilizers to reduce the use of polluting chemical fertilizers.

III. Project Goals and Objectives

1. To make nutritious food readily available among ____ poor households, even in times of disasters or abnormal times.
2. To provide poor families opportunity to increase their income by ____% through marketing of surplus vegetables, fruits and poultry/livestock in a period of ____ years.

IV. Desired Impact and Outcome of the Project

1. Mitigated and/or eliminated hunger among ____ participating poor families.
2. Reduced incidence of malnutrition by ____%, especially among children of participating poor families.

V. Program Components, Activities and Plans

Project Phase	Brief Description of the Activity	Persons Involved	Time Frame	Expected output
A. Pre-Implementation Phase				
1) Organization of ICFP Management Team	The ICFP team will be created through an executive order (EO). The team will be composed of the Mayor, City/Municipal Agriculturist and/or designated agriculture technician, LPRAT Co-chair, C/MNAO, ICFP Community Coordinators, and CSO LPRAT members.	<ul style="list-style-type: none"> ■ Mayor ■ City/Municipal Agriculturist ■ LPRAT Co-Chair 	January 2016	<ul style="list-style-type: none"> ■ Local ICFP Team organized ■ Executive Order (EO) creating the ICFP Team
2) Identification of beneficiaries	(GIVE DETAILS ON BENEFICIARY) Priority barangays are those with high incidence of poverty and malnutrition as sourced from NHTS-PR, CBMS, OPT, FHSIS, among others.	<ul style="list-style-type: none"> ■ ICFP Team 	January 2016	<ul style="list-style-type: none"> ■ List of priority project beneficiaries

Project Phase	Brief Description of the Activity	Persons Involved	Time Frame	Expected output
4) Establishment of fruit tree/orchard in every home	Only the best varieties and suitable planting materials the area will be used to promote the development of a competitive tropical fruit industry for each barangay. (INDICATE PRIORITY FRUIT TYPE FOR DISTRIBUTION, NUMBER OF SEEDLING PER HOUSEHOLD, SOURCE OF PLANTING MATERIALS)	<ul style="list-style-type: none"> ■ ICFP Team ■ Project Beneficiaries 	February to April 2016	<ul style="list-style-type: none"> ■ fruit seeds and seedlings distributed ■ trees planted ■ other seeds/seedlings variety planted
5) Production and use of organic fertilizer in every home	Production and use of organic fertilizer in every home to produce high yields of healthy food crops and to protect the environment. (INDICATE POSSIBLE ORGANIC FERTILIZER TECHNOLOGY TO BE ADOPTED LIKE VERMICOMPOSTING, NATURAL FARMING INPUTS LIKE FPJ, IMO, FAA ETC.; TRAININGS REQUIRED & WHO WILL FACILITATE; & INPUTS TO BE PROVIDED LIKE 1 KG ANC)	<ul style="list-style-type: none"> ■ ICFP Team ■ Project Beneficiaries ■ Service Providers 	March to June 2016	<ul style="list-style-type: none"> ■ household organic fertilizer factories established ■ organic fertilizer production technology used
6) Establishment of community gardens	To be situated in the identified barangay / community	<ul style="list-style-type: none"> ■ ICFP Team ■ Project Beneficiaries ■ Service Providers 	April to June 2016	<ul style="list-style-type: none"> ■ community gardens established
7) Project Advocacy and Promotion / Nutrition Fair	Project promotion in coordination with other government agencies i. Nutritional Assessment ii. Competitions iii. Nutritional program	<ul style="list-style-type: none"> ■ ICFP Team ■ Project Beneficiaries 	March to April 2016	<ul style="list-style-type: none"> ■ project advocacy and promotion activities held
8) Conduct of regular meetings, mentoring and values formation activities, monitoring visits	NAPC and LGU level meetings, monitoring, mentoring	<ul style="list-style-type: none"> ■ ICFP Team ■ Project Beneficiaries ■ ICFP Coordinators 	January to December 2016	<ul style="list-style-type: none"> ■ meetings conducted ■ monitoring visits conducted
9) Regular reporting	Midterm reporting will be done after distribution of procured seeds, seedlings, poultry and livestock, organic fertilizers and other inputs	<ul style="list-style-type: none"> ■ ICFP Team ■ Project Beneficiaries ■ ICFP Coordinators 	March to June 2016	<ul style="list-style-type: none"> ■ Midterm Progress Report submitted

Project Phase	Brief Description of the Activity	Persons Involved	Time Frame	Expected output
10) Poultry and livestock production	Raising of native chicken and/or ducks, and/or goats in every home as protein source. (GIVE THE NUMBER OF LIVESTOCK TO BE PROVIDED PER HOUSEHOLD, PREFERABLY TO BE IMPLEMENTED AFTER VEGETABLE PRODUCTION AND ORGANIC FERTILIZER IS IN PLACE)	<ul style="list-style-type: none"> ▪ ICFP Team ▪ Project Beneficiaries 	March to May 2016	<ul style="list-style-type: none"> ▪ poultry and livestock distributed
C. Post Implementation Phase				
1) Conduct of Food and Nutrition Survey	This will be done at the end of program cycle to serve as endline data. (DESCRIBE HOW THE SURVEY WILL BE CONDUCTED)	<ul style="list-style-type: none"> ▪ C/MNAO ▪ ICFP Team ▪ Enumerators ▪ Project Beneficiaries 	November to December 2016	<ul style="list-style-type: none"> ▪ Result of endline survey
2) Conduct of community assessments and workshop	Assessment and workshop will be conducted in every cluster or community	<ul style="list-style-type: none"> ▪ ICFP Team ▪ Project Beneficiaries 	June 2016 & December 2016	<ul style="list-style-type: none"> ▪ community assessments and workshops conducted
3) Regular Reporting	Terminal reporting will be done after harvest of one planting / cropping cycle.	<ul style="list-style-type: none"> ▪ ICFP Team ▪ Project Beneficiaries ▪ ICFP Coordinators 	December 2016	<ul style="list-style-type: none"> ▪ Terminal Report

IMPORTANT NOTES: Activities stated herewith are based on the approved guidelines, and are required during the program implementation. You may include other activities that you think can be undertaken during the pre-implementation, implementation and post-implementation phase to further improve the process.

VI. Project Organization and Staffing

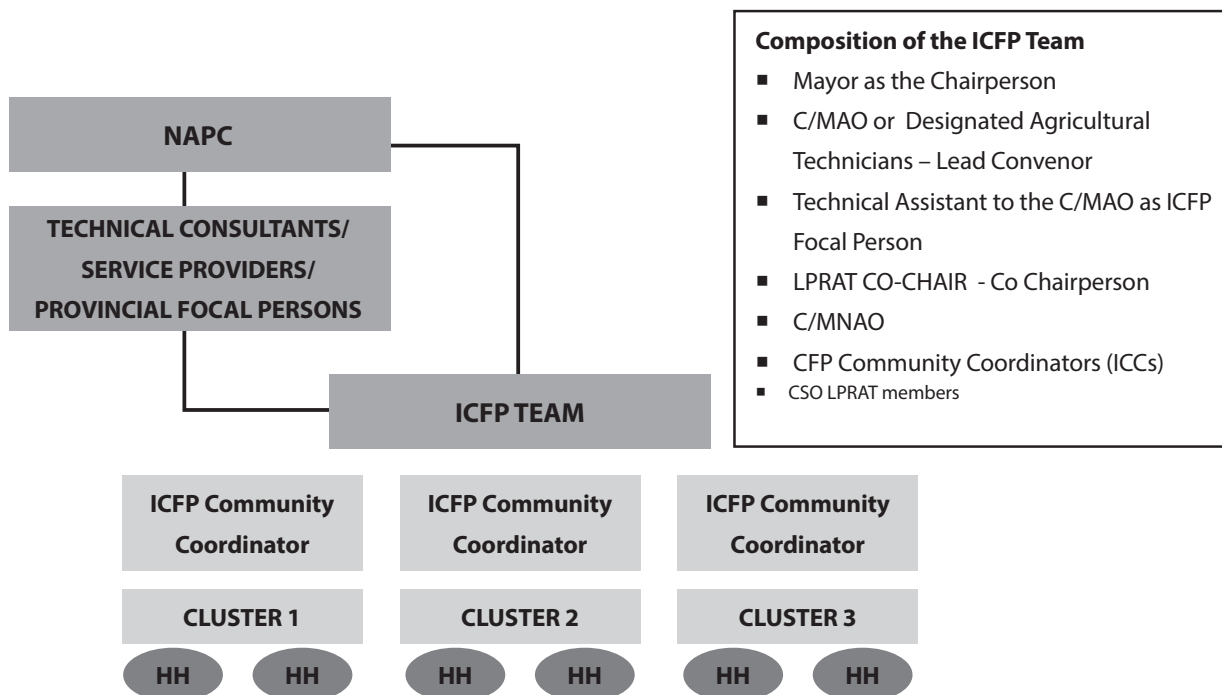

VII. Management Processes and Structure

ICFP TEAM MEMBERS	NAME	ROLES AND FUNCTIONS
Mayor		<ul style="list-style-type: none"> ▪ Act as the Chairperson of the ICFP Team ▪ Ensure that ICFP Program at the local level is moving smoothly, similar to other BUB Projects
City/Municipal Agriculture Officer or Designated Agricultural Technician		<ul style="list-style-type: none"> ▪ Act as the Lead Convenor of the ICFP Team ▪ Oversee the over-all implementation of the ICFP Program at the local level ▪ Supervise the day-to-day operation covering the three (3) phases of the ICFP Program implementation ▪ Check the compliance of the requirements for the release of funds in coordination with the LPRAT ▪ Spearhead the selection of the household beneficiaries, the ICFP Community Coordinators (ICC) and other ICFP Team members ▪ Submit midterm and terminal reports to NAPC

ICFP TEAM MEMBERS	NAME	ROLES AND FUNCTIONS
Technical Assistant to the C/MAO		<ul style="list-style-type: none"> ▪ Assist the C/MAO and the ICFP Team in the Implementation of ICFP including but not limited to the following tasks: documentation, proposal making, submission of manual and online reports, monitoring and others
LPRAT Co-Chairperson		<ul style="list-style-type: none"> ▪ Act as the Co-Chairperson of the ICFP Team. ▪ May take the role of the City/Municipal Coordinator or assign anyone as his designate ▪ Ensure the proper listing and genuine participation of all the targeted household beneficiaries ▪ Sit as CSO Observer in the Bids and Awards Committee (BAC) where deliberation of project procurement procedure related to ICFP is done
ICFP Community Coordinators(ICC)		<ul style="list-style-type: none"> ▪ Act as the leader or coordinator of household clusters of beneficiaries ▪ Provide technical assistance to household beneficiaries in coordination with the City/Municipal Agriculture Office and the NAPC Technical Consultants and/or Service Providers ▪ Supervise and monitor the established household and community gardens, organic fertilizer production and other cluster-level food production plans, as specified in the participating LGU's project proposal ▪ Attend capacity building and other meetings ▪ Submit monthly monitoring reports to C/MAO
City /Municipal Nutrition Action Officer (MNAO)		<ul style="list-style-type: none"> ▪ Lead the conduct of the baseline and endline survey in coordination with the ICFP Team ▪ Provide significant local data on food and nutrition

ICFP TEAM MEMBERS	NAME	ROLES AND FUNCTIONS
Household Beneficiaries		<ul style="list-style-type: none"> ▪ Establish own home gardens and produce food ▪ Attend ICFP Program orientation, capacity building activities and other meetings ▪ Consume their own food produced in their homes or community to ensure mitigation and/or elimination of hunger and malnutrition within the family circle ▪ Participate in establishing community gardens ▪ • Abide by the rules and regulations established by the ICFP Team for the smooth implementation of the program ▪ Continue planting vegetables even after the project cycle
Other CSO Members		<ul style="list-style-type: none"> ▪ Assist in the timely implementation of ICFP Program ▪ Assist in monitoring the smooth implementation of the ICFP Program ▪ Assist in reviewing and evaluating the day-to-day implementation of the ICFP program

(State ICFP implementation processes in your locality)

VIII. Sustainability Plan

To make the above interventions sustainable, the following shall be undertaken/ established:

- a) Massive training and capacity building of the project participants. Technical skills on production of vegetables, fruits, root and tuber crops; poultry and livestock production; and organic fertilizer, and management skills, human values formation.
(INDICATE WHO WILL FACILITATE OR THE POSSIBLE RESOURCE SPEAKER)
- b) A Food Security Garden in every community to conserve important food crops and seed multiplication, and provide sustainable sources of planting materials.
(YOU MAY TAP POs OR EXISTING FARMER GROUPS TO BECOME SEED PRODUCER, BUDGET PERMITTING PROCUREMENT OF MOBILE/PORTABLE SEED STORAGE)
- c) A fruit seedling propagation nursery in every community to produce affordable planting materials.
(UPGRADING OF THE CITY/MUNICIPAL NURSERY TO SERVE AS EX SITU GENE BANK AND MASSIVE PROPAGATION OF PLANTING MATERIALS FOR FUTURE DISPERSAL)

- d) An organic fertilizer factory in every community to supply the fertilizer needs of home gardens.
(PRODUCTION AND MULTIPLICATION OF VERMIN WORMS FOR DISTRIBUTION TO HOUSEHOLDS, INDICATE WHO WILL MAINTAIN AND MANAGE EX. PO, FARMERS GROUP, SELECTED PARTICIPANTS, LGU OR OTHERS)
- e) A 50-100 head native poultry and livestock for multiplication and/or distribution facility in every community.
(INDICATE HERE YOUR PREFERRED POULTRY OR LIVESTOCK AND THE NUMBER OF ANIMAL; INDICATE PREFERRED BREED, POSSIBLE SOURCE, AND WHO WILL MAINTAIN AND MANAGE)
- f) An innovative microcredit and planting material and poultry/livestock recovery program. All planting materials will be provided in kind and paid in kind through the ICFP team agreed payback mechanism.
(INDICATE YOUR AGREED REPAYMENT SCHEME)
- g) Formation of a Project Food Association, registration with DOLE or CDA and training of officers. Officers will be trained to manage the program right from the beginning.
(CITE POSSIBLE LINKAGES WITH EXISTING POs, OR FORMATION OF NEW ASSOCIATION)
- h) Incorporation of project into the Municipal Development Plan
(DESCRIBE THE PROCESS FOR INCORPORATION)
- i) Public awareness: field days, farmers field schools, multi-media campaign
(DESCRIBE THE IMPLEMENTATION PROCESS)

IX. Reportorial Requirements

- Midterm Report with the following attachments:
 - Results of Baseline Survey
 - Summary of 1st HH Monitoring Report
- Terminal Report with the following attachments:
 - Results of Endline Survey
 - Summary of Project Report

X. Work and Financial Plan

Refer to the attached work and financial Plan

XI. Accountability of ICFP Stakeholders and Signatories

- Ensure that the project is implemented in accordance with the ICFP Implementing Rules and Guidelines as set by the National Anti-Poverty Commission (NAPC), as well as in the conditions set in this approved proposal.
- Adhere to the principles of Good Governance, Transparency and Accountability
- Adhere to the principles of the DBM-DILG-DSWD-NAPC Joint Memorandum Circular No. 7 on the Policy Guidelines and Procedures in the Implementation of the Bottom-up Budgeting (BuB) Program for Fiscal Year 2016 and Thereafter

XII. Attachments

- Work and Financial Plan
- Certificate of Land and Water Availability
- Executive Order of the Mayor creating the ICFP Team

Prepared by:

Municipal Agricultural Officer

Conforme:

CSO LPRAT Member

Recommending Approval:

Mayor

LPRAT Co-Chairperson

Approved:

JESUSA I. REBETE
Director III
NAPC, LACMS

Annex D

INTEGRATED COMMUNITY FOOD PRODUCTION

Proposed Project Budget for the Municipality of _____

Total Project Cost : _____

Budget Requested from NGA: _____

LGU Counterpart: _____

BUDGET LINE ITEM	PARTICULAR				REQUESTED AMOUNT	LGU COUNTERPART	TOTAL
	Indicators / Description	Quantity	Duration (No. Of Days / Months)	Unit Price			
I. Capability Building, Community Assemblies, Honorarium, Travel Allowance							
a. Capability Building							
1. Orientation and Planning Workshop for ICFP Team and Household Beneficiaries					0	0	0
1.1 Meal and Snacks	ICFP Team Members and Household Beneficiaries Oriented on ICFP						
1.2 Supplies and Materials							
1.3 Honorarium for Resource Persons							
1.4 Board and Lodging of Consultant							
2. Vegetable, Fruit and Rootcrop Production					0	0	0
2.1 Meal and Snacks	ICFP Team Members and Household Beneficiaries Trained on Production of Vegetables, Fruits and Rootcrops						
2.2 Supplies and Materials							
2.3 Honorarium for Resource Persons							
2.4 Board and Lodging of Consultant							
3. Organic Fertilizer Production					0	0	0
3.1 Meal and Snacks	ICFP Team Members and Household Beneficiaries Trained on Organic Fertilizer Production						
3.2 Supplies and Materials							
3.3 Honorarium for Resource Persons							
3.4 Board and Lodging of Consultant							

BUDGET LINE ITEM	PARTICULAR				REQUESTED AMOUNT	LGU COUNTERPART	TOTAL
	Indicators / Description	Quantity	Duration (No. Of Days / Months)	Unit Price			
4. Livestock and Poultry Production					0	0	0
4.1 Meal and Snacks	ICFP Team Members and Household Beneficiaries Trained on Livestock and Poultry Production						
4.2 Supplies and Materials							
4.3 Honorarium for Resource Persons							
4.4 Board and Lodging of Consultant							
5. Management Skills and Value Formation (Food Production & Budgeting)					0	0	0
5.1 Meal and Snacks	Establishment of an innovative microcredit and planting materials and livestock and poultry loan recovery program						
5.2 Supplies and Materials							
5.3 Honorarium for Resource Persons							
5.4 Board and Lodging of Consultant							
b. Public Awareness					0	0	0
1. Field Day	Activity Cost						
2. Best Communal Garden	Award / Prize						
3. Best Household Garden	Award / Prize						
4. IEC Material Production	Supplies and Materials						
c. Nutrition Promotion					0	0	0
1. Quantification of Nutrition Benefits	In coordination with NNC						
2. Recipe Contest	Award / Prize						
d. Community Assemblies					0	0	0
1. ICFP Management Team Meeting	Meals and Snacks						
2. Household Beneficiaries Meeting	Meals and Snacks						
e. Honorarium					0	0	0
1. ICFP City / Municipal Coordinator	Project Staff						
2. ICFP Community Coordinators	Project Staff						
3. ICFP Technical Consultants	Project Staff						
f. Travel Allowance					0	0	0
1. ICFP Team Members							
2. ICFP Community Coordinators							

BUDGET LINE ITEM	PARTICULAR				REQUESTED AMOUNT	LGU COUNTERPART	TOTAL
	Indicators / Description	Quantity	Duration (No. Of Days / Months)	Unit Price			
g. Supplies and Materials					0	0	0
1. Office Supplies and Materials							
Sub-Total					0	0	0
II. Garden Tools							
a. Seedling Tray (104 Holes)							
b. Sprinkler							
c. Pick Mattock							
d. Rake							
e. Hoe							
f. Plastic Drums							
g. Garden Hose							
h. Others							
Sub-Total					0		0
III. Actual Gardening Implements							
a. Home Gardens							
1. Vegetable Seeds					0		0
1.1 Pechay							
1.2 Mustard							
1.3 Eggplant							
1.4 Bitter Gourd							
1.5 Okra							
1.6 String Bean							
1.7 Cow Pea							
1.8 Tomato							
1.9 Squash							
1.10 Ridge Gourd (Patola)							
1.11 Bottle Gourd (Upo)							
1.12 Kangkong							
1.13 Winged Bean (Sigarillas)							
1.14 Green or Sweet Pepper							
1.15 Malungay							
1.16 Cucumber							
1.17 Others (please specify)							
2. Carbohydrate-rich crops					0		0
2.1 Corn							
2.2 Sweet Potato							
2.3 Cassava							

BUDGET LINE ITEM	PARTICULAR				REQUESTED AMOUNT	LGU COUNTERPART	TOTAL
	Indicators / Description	Quantity	Duration (No. Of Days / Months)	Unit Price			
2.4 Gabi							
2.5 Saba (Cooking Banana)							
2.6 Bread Fruit (Rimas)							
2.7 Others (please specify)							
3. Fruit Seedlings					0		0
3.1 Cacao							
3.2 Chico							
3.3 Pummelo							
3.4 Mango							
3.5 Jackfruit							
3.6 Rambutan							
3.7 Lanzones							
3.8 Sweet Tamarind							
3.9 Mandarin Orange							
3.10 Guava							
3.11 Mangosteen							
3.12 Durian							
3.13 Dragon Fruit							
3.14 Calamansi							
3.15 Others (please specify)							
4. Poultry and Livestock					0		0
4.1 Hen (Female Chicken)							
4.2 Rooster (Male Chicken)							
4.3 Male Duck							
4.4 Female Duck							
4.5 Buck (Male Goat)							
4.6 Doe (Female Goat)							
5. Biologics					0		0
5.1 Vaccines							
5.2 Dewormer							
5.3 Vitamins							
6. Organic Fertilizer Production					0		0
6.1 Super Grain Bag							
6.2 African Night Crawler							
6.3 Vermicomposting Bin with Shed							
6.4 Others (please specify)							

BUDGET LINE ITEM	PARTICULAR				REQUESTED AMOUNT	LGU COUNTERPART	TOTAL
	Indicators / Description	Quantity	Duration (No. Of Days / Months)	Unit Price			
7. Organic Fertilizer	For initial use				0		0
7.1 Chicken Dung							
7.2 Animal Manure							
7.3 Other Alternative Organic Fertilizer							
b. Communal Garden							
1. Initial Assistance					0		0
1.1 Land Preparation	Plowing; Harrowing; Bed Raising						
1.2 Fencing Materials	Supplies and Materials						
1.3 Materials for Vermi Pond / Bin							
1.4 African Night Crawler							
1.5 Vegetable Seeds	Assorted						
c. Fruit Seedling Propagation in Every Community					0		0
1. Seed Storage	Supplies and Materials						
2. Seedlings	Assorted						
Sub-Total					0	0	0
IV. Monitoring and Evaluation							
a. Food and Nutrition Baseline Survey	Enumerator				0		0
b. Food and Nutrition Endline Survey	Enumerator				0		0
c. Analysis of Surveys	Analyst / Writer				0		0
d. Monitoring Expense	Activity Cost				0		0
e. Assessment and Workshop	Activity Cost				0		0
Sub-Total					0	0	0
Grand Total					0	0	0

Prepared by:

Conforme:

City / Municipal Agriculturist

CSO LPRAT Member

RECOMMENDING APPROVAL _____

Local Chief Executive
LPRAT Co-Chairperson

APPROVED:

JESUSA I. REBETE

Director III

NAPC Local Affairs Coordinating and Monitoring Services (LACMS) Unit

Prepared by:

Conforme:

Municipal Agricultural Officer

CSO LPRAT Member

Prepared by:

Conforme:

City / Municipal Agriculturist

CSO LPRAT Member

Recommending Approval

Local Chief Executive

LPRAT Co-Chairperson

Approved:

JESUSA I. REBETE

Director III

NAPC Local Affairs Coordinating and Monitoring Services (LACMS) Unit

Annex E

Republic of the Philippines
Province of _____
City/Municipality of _____

CERTIFICATION

This is to certify that the area of _____, identified as the target location in the implementation of the Integrated Community Food Production (ICFP) Program has available land and water sources fit to cover the household and community gardens of ICFP beneficiaries.

This certification is hereby issued on ____ day of January, 2016 as part of the necessary documents for the approval of our ICFP Project Proposal.

Local Chief Executive or
Barangay Captain or
City/Municipal Agriculturist

Annex F

INTEGRATED COMMUNITY FOOD PRODUCTION PROGRAM
CITY/MUNICIPALITY OF _____, _____ (PROVINCE)
PROJECT IMPLEMENTATION PLAN

TARGET OUTPUTS: 1 _____
 : 2 _____
 : 3 _____

	EXPECTED OUTPUT	MONTHS												BUDGET	IN-CHARGED
		J	F	M	A	M	J	J	A	S	O	N	D		
A. PRE-IMPLEMENTATION															
1. Please see approved proposal															
B. IMPLEMENTATION															
1. Establish Home Vegetable Gardens	Please put details based on your proposal														
2. Establish Food Security Gardens															
3. Poultry/Livestock Raising															
4. Production of Vermicast															
5. Planting of Medium Term and Long-Term Crops															
6. Marketing of Garden / Farm Produce															
C. POST IMPLEMENTATION															
1.															
2.															

Prepared By:

ICFP TEAM

Sketch Drawing Of Proposed Home Garden



Annex G

INTEGRATED COMMUNITY FOOD PRODUCTION BASELINE SURVEY QUESTIONNAIRE

Brgy: _____ **City/Municipality:** _____ **Province:** _____

Basic Information

- 1 Name (head of family): _____
2 Age: _____ 3. Sex: ___M ___F
4 Educational Attainment: _____
5 Main Occupations: _____
6 Other Sources of Income: _____
7 Estimated Monthly Income: _____
8 Spouse: _____ 9 Age: _____
10 Occupation of Spouse: _____
11 Educational Attainment: _____
12 # of dependent children: _____
13 # of other dependent family members: _____
14 Household Size: _____

Food Security Inquiry

(Check the blank before your answer.)

*Agree on measurement equivalent. Ex: Rice
Local Unit: 1 leche Equivalent SI Unit: ¼ kg*

15. The food served every meal is enough for the family.
___ Always ___ Sometimes ___ Never
16. If the food is not enough, the family adjusts by:
___ A family member reduces meal size
___ A family member skips a meal
___ Family consumes alternative food
___ Others (specify): _____
17. Who is the family member that often gives way?
___ Husband ___ Wife ___ Children

18. Who is given the priority in the family to eat more?
___ Husband ___ Wife ___ Children

19. The food served is at the household table is balanced (includes carbohydrates, proteins, vitamins, minerals).
___ Always ___ Sometimes ___ Never

20. Do you eat rice during breakfast?
___ Yes ___ No

If yes, how often do you eat it?

___ Always ___ Sometimes ___ Never

If yes, how much rice do you cook for the family?

If you do not eat rice for breakfast, what do you usually cook and eat as substitute?

Why were these foods chosen as alternative?

22. Do you eat rice during dinner?
___ Yes ___ No

If yes, how often do you eat it?

___ Always ___ Sometimes ___ Never

If yes, how much rice do you cook for the family?

If you do not eat rice for dinner, what do you usually cook and eat as substitute?

Why were these foods chosen as alternative?

23. Are you willing to substitute (replace) rice with root crops if there is need and if given the opportunity?

___Yes ___No

If yes, why? _____

If no, why? _____

If no, are you willing to lessen your intake of rice and eat root crops instead?

___Yes ___No

If yes, by how much

___Quarter ___Half ___More than Half

24. Are you willing to substitute (replace) rice with other grain crops (e. g. corn) if there is need and if given the opportunity?

___Yes ___No

If yes, why? _____

If no, why? _____

If no, are you willing to lessen your intake of rice and eat other grain root crops instead?

___Yes ___No

If yes, by how much

___Quarter ___Half ___More than Half

25. Which among the meals do you prefer to lessen your rice consumption?

___Breakfast ___Lunch ___Dinner

26. Do you produce the vegetable you eat?

___Yes ___No

If yes, is your produce enough for family?

___Yes ___No

If no, do you buy additional vegetables to eat?

___Yes ___No

If no, why do you not buy? _____

27. Is there anyone in the family who does not eat vegetables?

___Yes ___No

If yes, who in the family is it? _____

28. How do you usually cook the vegetables?

___Law-uy ___Ginisa ___Adobo

___Pinakbet Others: _____

29. What vegetables do you usually eat? When do you eat them? What is the source? And when are these available?

Vegetables	Quantity eaten per meal	When eaten			Source			When is it available
		B	L	D	P	Bo	WG	
	<i>Use local measurement if necessary</i>							<i>YR for year round or month when abundant</i>
1								
2								
3								
4								
5								
6								
7								
8								
9								
10								

Legend:

B-breakfast; L-lunch; D-dinner

P-produced; Bo-bought; WG-wildly grown

30. What types of vegetables/fruits are you growing in your garden?

Vegetable/ Fruits/Root crops	Number (number of plants or land area)
1.	
2.	
3.	
4.	
5.	
6.	
7.	
8.	
9.	
10.	
11.	
12.	
13.	
14.	
15.	

31. Are there advantages in growing your own fruits/vegetables?

Yes No

If yes, what are these advantages?

32. Quantity eaten, frequency of eating, and buying the following food

	Quantity eaten (estimate in g/kg)	Frequency of eating (in a day, week, month, others)	Bought/ Raised/ Caught
Chicken			
Pork			
Beef			
Egg			
Fish			

33. Do you eat chicken, pork, beef, or fish alone as separate viand?

Yes No

If no, specify the food you eat and mix them with.

34. Of the total food quantity eaten, how much of this do you buy?

Percentage				
	1-25	26-50	51-75	76-100
Chicken				
Pork				
Beef				
Egg				
Fish				

35. Do you have extra produce for sale or for giving?

Yes No

If yes, what is your extra produce? Fill up table

Product (vegetables, meat, fish, etc.)	Quantity sold	Quantity given

36. How do you usually spend your idle time?

Salamat po!

Name of Enumerator: _____

Date accomplished: _____

Annex H

INTEGRATED COMMUNITY FOOD PRODUCTION PROGRAM Household Monitoring Sheet

Brgy: _____ City/Municipality: _____ Province: _____

Prepared by:

ICFP Community Coordinator

Name of Beneficiary	Cluster / Barangay	Date Monitored	Vegetables									Seeds			Fruits	
			Type of Seeds Received	No. of Plants	Mortality	Added Seeds	Stage of Devt*	Quantity Harvested	Consumed	Given	Sold	Produced	Given/ Paid	Planted	Type Receive	Remarks

Annex I

INTEGRATED COMMUNITY FOOD PRODUCTION ENDLINE SURVEY QUESTIONNAIRE

Brgy: _____ **City/Municipality:** _____ **Province:** _____

Basic Information

- 1 Name (head of family): _____
2 Age: _____ 3. Sex: ___M ___F
4 Educational Attainment: _____
5 Main Occupations: _____
6 Other Sources of Income: _____
7 Estimated Monthly Income: _____
8 Spouse: _____ 9 Age: _____
10 Occupation of Spouse: _____
11 Educational Attainment: _____
12 # of dependent children: _____
13 # of other dependent family members: _____
14 Household Size: _____

Food Security Inquiry

(Check the blank before your answer.)

Agree on measurement equivalent. Ex: Rice

Local Unit: 1 leche Equivalent SI Unit: ¼ kg

15. The food served every meal is enough for the family.
___ Always ___ Sometimes ___ Never

16. If the food is not enough, the family adjusts by:

- ___ A family member reduces meal size
___ A family member skips a meal
___ Family consumes alternative food
___ Others (specify): _____

17. Who is the family member that often gives way?

- ___ Husband ___ Wife ___ Children

18. Who is given the priority in the family to eat more?

- ___ Husband ___ Wife ___ Children

19. The food served is at the household table is balanced (includes carbohydrates, proteins, vitamins, minerals).

- ___ Always ___ Sometimes ___ Never

20. Do you eat rice during breakfast?

- ___ Yes ___ No

If yes, how often do you eat it?

- ___ Always ___ Sometimes ___ Never

If yes, how much rice do you cook for the family?

If you do not eat rice for breakfast, what do you usually cook and eat as substitute?

Why were these foods chosen as alternative?

22. Do you eat rice during dinner?

- ___ Yes ___ No

If yes, how often do you eat it?

- ___ Always ___ Sometimes ___ Never

If yes, how much rice do you cook for the family?

If you do not eat rice for dinner, what do you usually cook and eat as substitute?

Why were these foods chosen as alternative?

23. Are you willing to substitute (replace) rice with root crops if there is need and if given the opportunity?

Yes No

If yes, why? _____

If no, why? _____

If no, are you willing to lessen your intake of rice and eat root crops instead?

Yes No

If yes, by how much

Quarter Half More than Half

24. Are you willing to substitute (replace) rice with other grain crops (e. g. corn) if there is need and if given the opportunity?

Yes No

If yes, why? _____

If no, why? _____

If no, are you willing to lessen your intake of rice and eat other grain root crops instead?

Yes No

If yes, by how much

Quarter Half More than Half

25. Which among the meals do you prefer to lessen your rice consumption?

Breakfast Lunch Dinner

26 Do you produce the vegetable you eat?

Yes No

If yes, is your produce enough for family?

Yes No

If no, do you buy additional vegetables to eat?

Yes No

If no, why do you not buy? _____

27. Is there anyone in the family who does not eat vegetables?

Yes No

If yes, who in the family is it? _____

28. How do you usually cook the vegetables?

Law-uy Ginisa Adobo

Pinakbet Others: _____

29. What vegetables do you usually eat? When do you eat them? What is the source? And when are these available?

Vegetables	Quantity eaten per meal	When eaten			Source			When is it available
		B	L	D	P	Bo	WG	
	<i>Use local measurement if necessary</i>							<i>YR for year round or month when abundant</i>
1								
2								
3								
4								
5								
6								
7								
8								
9								
10								

Legend:

B-breakfast; L-lunch; D-dinner

P-produced; Bo-bought; WG-wildly grown

30. What types of vegetables/fruits are you growing in your garden?

Vegetable/ Fruits/Root crops	Number (number of plants or land area)
1.	
2.	
3.	
4.	
5.	
6.	
7.	
8.	
9.	
10.	
11.	
12.	
13.	
14.	
15.	

31. Are there advantages in growing your own fruits/vegetables?

Yes No

If yes, what are these advantages?

32. Quantity eaten, frequency of eating, and buying the following food

	Quantity eaten (estimate in g/kg)	Frequency of eating (in a day, week, month, others)	Bought/ Raised/ Caught
Chicken			
Pork			
Beef			
Egg			
Fish			

33. Do you eat chicken, pork, beef, or fish alone as separate viand?

Yes No

If no, specify the food you eat and mix them with.

34. Of the total food quantity eaten, how much of this do you buy?

Percentage				
	1-25	26-50	51-75	76-100
Chicken				
Pork				
Beef				
Egg				
Fish				

35. Do you have extra produce for sale or for giving?

Yes No

If yes, what is your extra produce? Fill up table

Product (vegetables, meat, fish, etc.)	Quantity sold	Quantity given

36. How do you usually spend your idle time?

37. On average, how much time do you spend in vegetable gardening?

38. What were the problems you encountered as a participant to the ICFP project?

39. Do you think you benefited from participating in the ICFP project?

Yes No

If yes, what are these benefits?

39. Do you think you benefited from participating in the ICFP project?

Yes No

If yes, what are these benefits?

40. Did the ICFP project help you after the calamity? Yes No

Why? _____

41. Do you think the project would have been helpful even without the calamity? Yes No

Why? _____

42. Are you planning to continue planting vegetables even after the end of the project? Yes No

Why? _____

43. Are there any activities related to vegetable/fruit production which you will or wish to try after the ICFP? Yes No

If yes, what are these activities? _____

44. How will you rate the impact of the ICFP project in your family?

Excellent Very Good Good No impact

Why? _____

45. What do you think are the contributions of NAPC, LGU and CSO in the project?

46. Any comments and/or suggestions on improving the project and its management and operation?

Salamat po!

Name of Enumerator: _____

Date accomplished: _____



The International Institute of Rural Reconstruction (IIRR) is a multi-awarded international development organization that has been working in the Philippines since the 1960s. Its primary mandate is to help address poverty, hunger and related issues of community development and local governance. IIRR achieves these outcomes by testing, developing and promoting participatory approaches such as farmer-led extension and participatory action research, community-based development and scaling up methodologies.

In support and partnership with the National Anti-Poverty Commission (NAPC) through the Integrated Community Food Production Program (ICFP), IIRR cultivates possible pathways to meet the special needs of the poorest of the poor in an incremental fashion. A compendium was put together that provides a wide range of pathway options for the poorest in our communities.

IIRR has drawn a hundred of its best ideas from over three decades of regenerative agriculture work and made these available in this single compendium. A special effort was made to use climate resilience and nutrition sensitivity as the basis for identifying pathway options included in this compendium, hence, the term *climate-smart and nutrition-smart* is being used to characterize this collection. The ultimate goal is to ensure that our family farms and gardens are not only resilient to climate change but can deliver on the food security, nutrition and livelihood goals of poor households so that no one is left behind.