

PICTORIAL PROOF  
OF PROGRESS

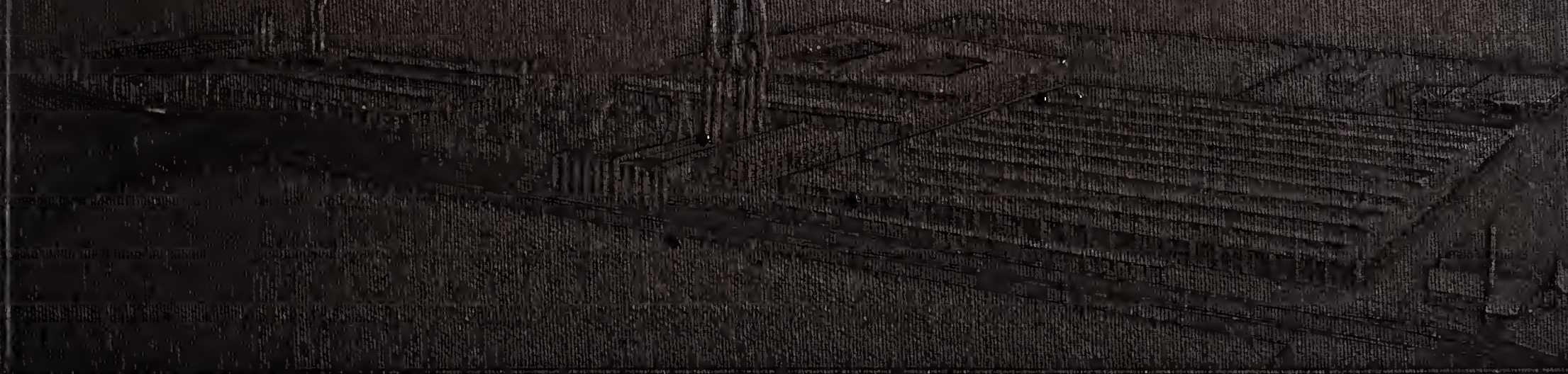

00020072854  
LIBRARY OF CONGRESS





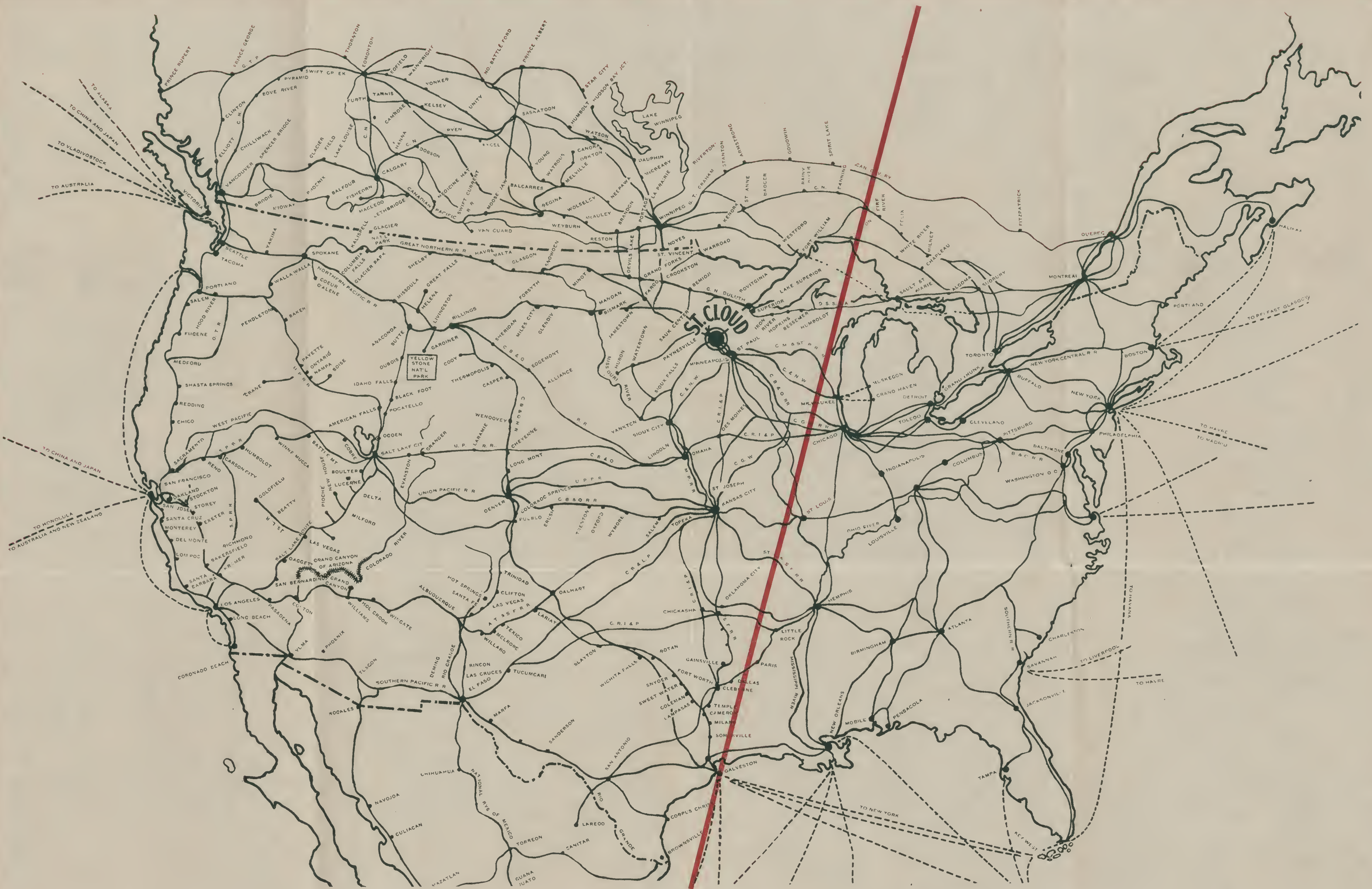

### Saint Cloud is Located Advantageously

THE purpose of this map is to show the excellent location of Saint Cloud with reference to rail and water transportation, putting it in easy and direct touch with all parts of the country, and to call special attention to the vast territory west of the red line which divides the country mid-way between Saint Cloud and Detroit, disclosing the interesting fact that practically two-thirds of the area of the United States is nearer and more accessible to Saint Cloud and the Pan Motor Company than to any automobile manufacturing center in the East. Figures carefully compiled show that the plant of the Pan Motor Company is located in the heart of the greatest automobile consuming district in the nation, there being more cars to the population in Minnesota and the states nearby than in any other section of the United States. In the territory west of the red line there are 5½ automobiles to every 100 people, while in that east of the red line there are only 3½ to every 100 people. There are about 21,000 more miles of national, state and county roads

west of the red line than there are east of it. The per capita wealth west of the red line is \$2,476.00 as against \$1,542.00 east of it. The average farm west of the red line is about three times as large as the average farm east of it. The value of crops west of the red line in 1917 was \$6,346,123,000.00 while that of live stock for the same year was \$3,937,000,000.00. In other words, the country west of the red line is the biggest, best and richest automobile, truck and tractor territory in the world at the present time and is getting better faster than any other similar district on the globe. Pan is at the door—on the very threshold—of this great and growing, progressive and wealthy West—the choicest market in the world, now and for years to come. The West, already the best, is improving faster than the rest, so far as the automobile industry is concerned and Pan will be in capacity production when the business reaches its highest level. The location and the situation could not well be more fortunate.



## MINNESOTA—RICH IN RESOURCES

**T**HE above topographical map graphically emphasizes the location of the Pan Motor Company and its proximity to some of the state's important sources of power, material and supplies; and the railroad and waterway transportation facilities available. Reference to the key numbers and letters on the sketch and their explanation below will furnish several of the reasons why Saint Cloud, Minnesota, was chosen as the location for the giant industrial undertaking launched by the Pan Motor Company.

Arrows numbered 1 to 6 inclusive, indicate respectively: Great Lakes Route to Atlantic Seaboard and inland cities of the East; railroads to East and southeast territory; railroad and Mississippi river routes to the South and Gulf; railroads to the great Southwest; transcontinental routes to the Pacific Coast and the great Northwest; routes into the virgin Canadian territory. It will be noted that rail and waterways radiate to practically every point of the compass and that Saint Cloud is either in direct connection or within easy distance of direct connection with the markets of the world.

A—The big plant of the Minnesota Steel Company at Duluth, a subsidiary of the United States Steel Corporation, and said to have cost over \$25,000,000.00, is less than 150 miles northeast of Saint Cloud.

B—The Virginia and Rainy Lake Company plant at Virginia is the largest white pine lumber plant in the world. The pine forests of the northern part of the state and Canada supply this mill. Some of the finest hardwood timber in the country is supplied from the Minnesota belt.

C—The Vermillion Range, the northernmost ore district of the state, and one of its oldest.

D—The Missabe Range where at Hibbing is located the biggest open pit iron ore mine in the world, the Shenango.

E—The Cuyuna Range is the latest of the ore bodies to be developed and millions of tons of the best grade of manganese ore are available here. It is within 60 miles of Saint Cloud.

F—A great amount of water power is available along the Mississippi within short distance of the City and at Saint Cloud itself.

G—The greatest wheat raising district in the country—the Red River Valley.

H—The Head of Navigation on the Mississippi River is at Minneapolis within 65 miles of Saint Cloud.

# Perspective and Ground Plan of Experimental, Production and Power Group

Drawn by Works Engineering Department, Pan Motor Company

ARCHITECTURAL PERSPECTIVE DRAWING

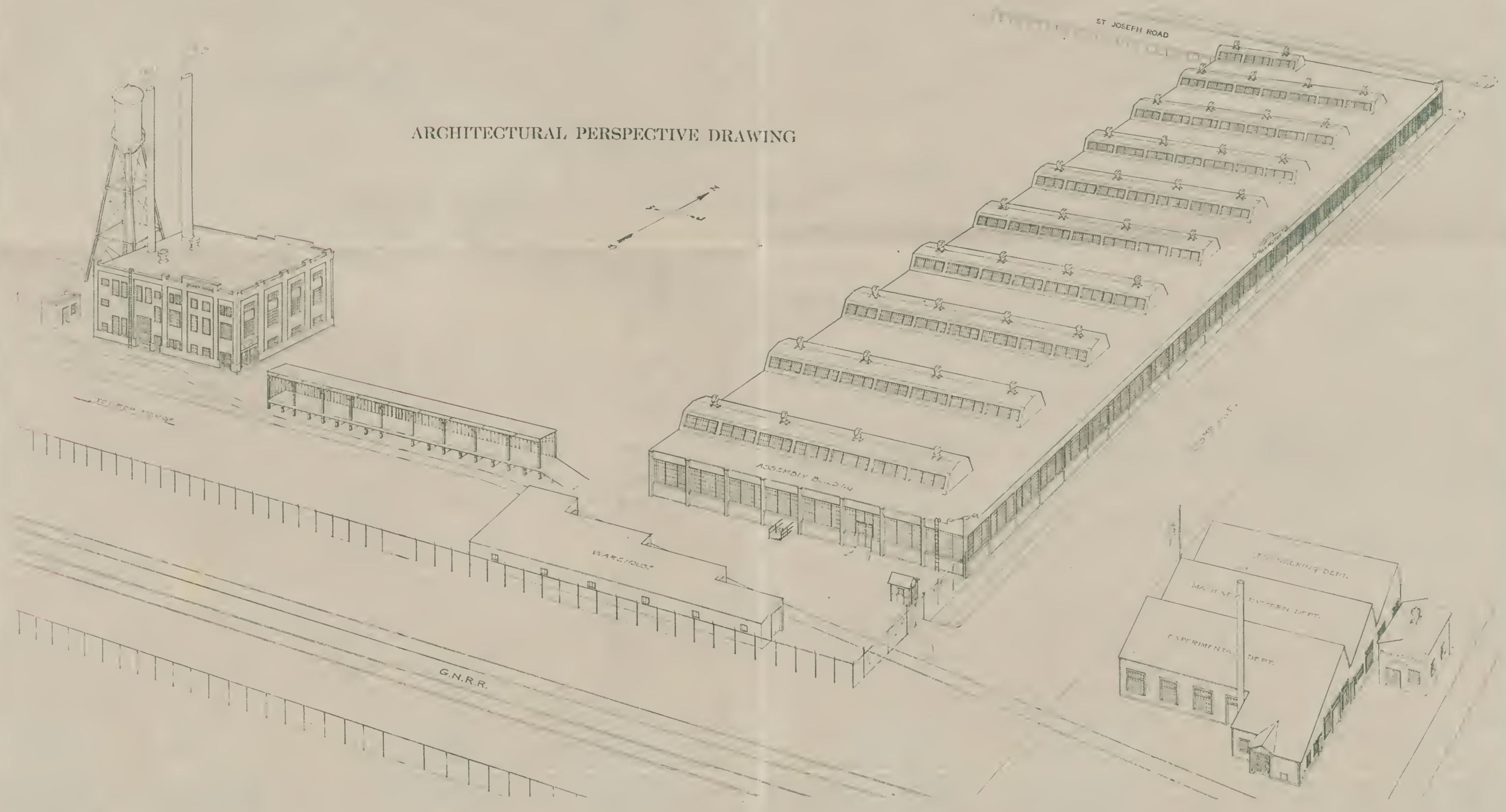

All buildings shown here are completed and in use

GROUND PLAN

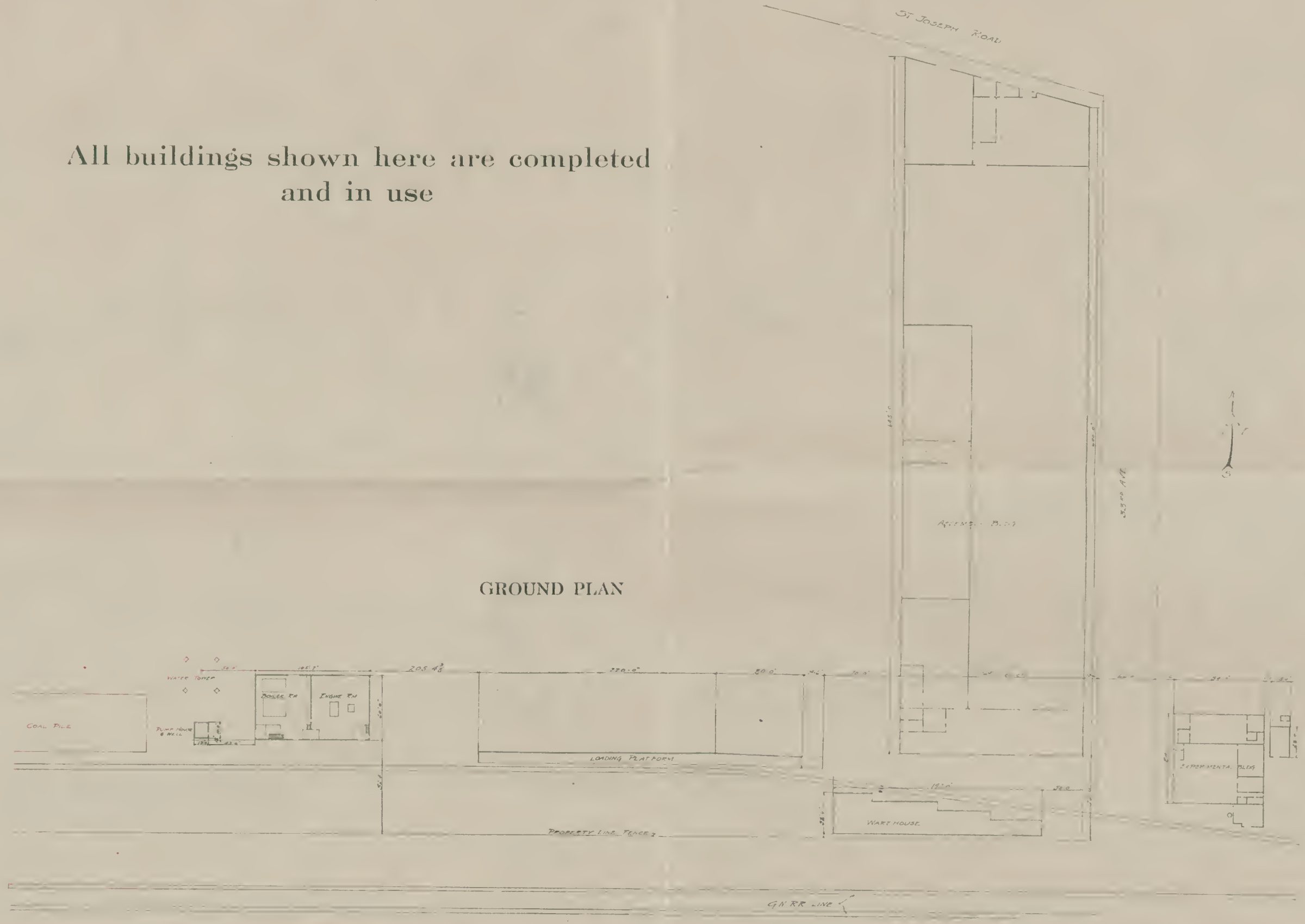

# Perspective and Ground Plan of Drop Forge Plant Group

Drawn by Works Engineering Department, Pan Motor Company

All buildings shown here are either already completed and in use or in some stage of construction. The principal purpose of this reproduction is to show the relative size and location of each unit of the Forge Department when all are completed. Compare this with the reproductions of the actual photographs appearing on other pages.

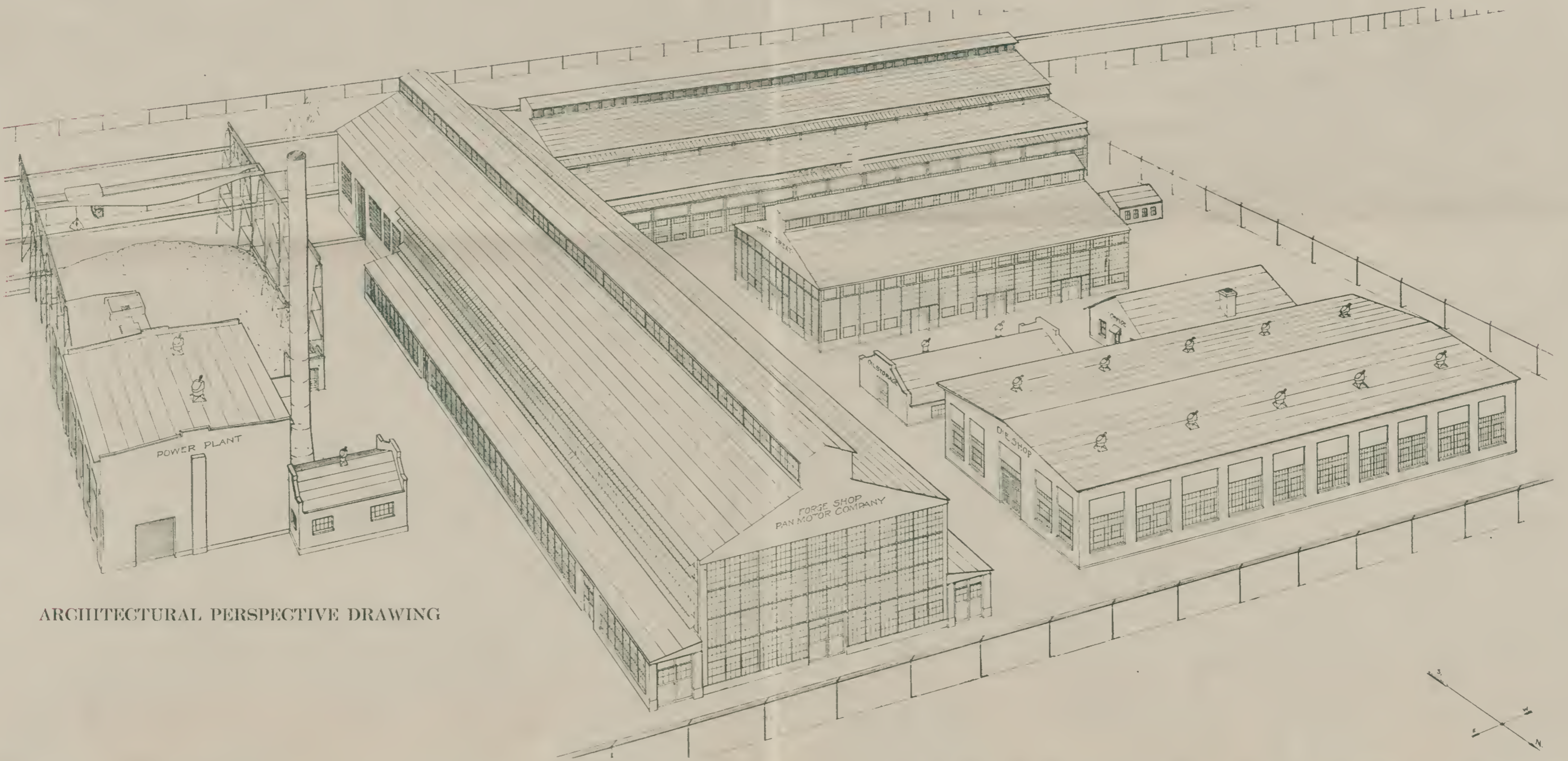

ARCHITECTURAL PERSPECTIVE DRAWING

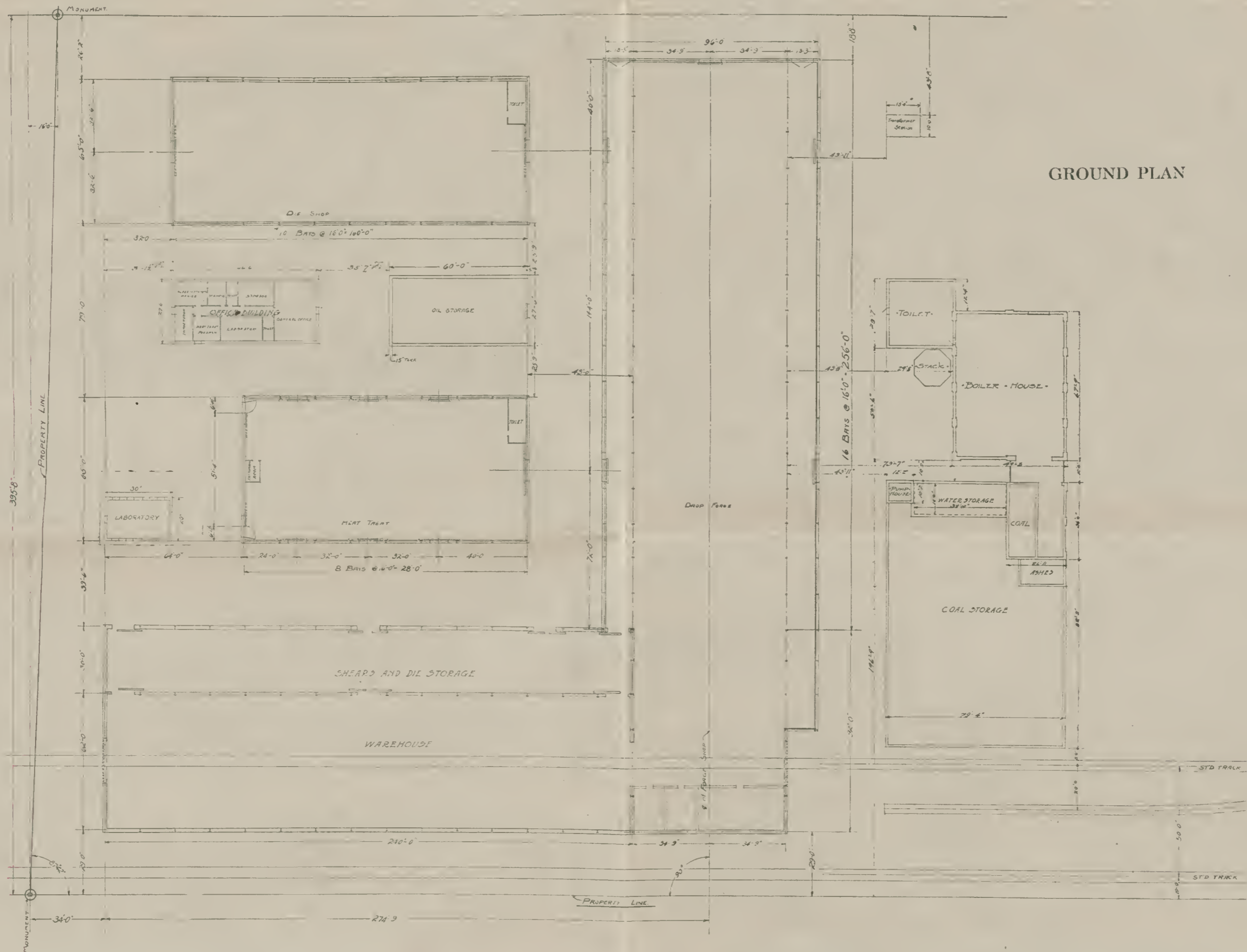

GROUND PLAN









*“ON the job day and night; at his desk, with his coat off, doing the thousand and one things necessary to be done with speed and alacrity; facing his labors and the future quietly and cheerfully, knowing full well that constant, intelligent effort is the price that must be paid for success, Samuel Conner Pandolfo has in a little more than a year made one of the most remarkable individual industrial showings recorded in history.”*

—C. W. W.

Copyright 1918

By

Pan Motor Company

Saint Cloud, Minnesota

All Rights Reserved

DEC 21 1918

P I C T O R I A L P R O O F  
O F P R O G R E S S



P A N M O T O R C O M P A N Y  
S A I N T . C L O U D , M I N N .

13200  
13

0-1-50-01

©CLA508821  
DEC 31 1918

R



# P U R P O S E O F B O O K

**T**HIS volume has a purpose and that purpose is to tell the plain, unvarnished truth about the Pan Motor Company. It has been the earnest effort of those who have gathered and prepared for publication the information contained in the following pages to anticipate and answer fully and in detail any question that may come to the mind of the reader regarding not alone the company itself, but the city and state in which it is located. It is believed that all statements are correct and is hoped that nothing has been overlooked.

The story of Saint Cloud is a comprehensive and interesting one. Much valuable data relating to Stearns county and Minnesota are given. The advantages of the location are pointed out and proven in a most conclusive manner. No attempt has been made to overstate the facts, and as for the illustrations, they were made from actual photographs. The camera, having a reputation for honesty, may be regarded as absolutely reliable.

Pan-Town-On-The-Mississippi is a wonderfully developed yearling and furnishes a rich and delightful subject for both writer and photographer. It is one of the necessary adjuncts of the great Pan enterprise and bespeaks the broad, keen vision of the efficient Pan management.

In dealing with the Pan Motor Company there has been one central and governing thought—to tell the story as it is—to open to plain view its past and present and, in so far as it is humanly possible, to lift the veil of the future. In doing this, great care has been exercised in avoiding the unreasonable and impractical. Consequently nothing is contained herein that is not history or good sense.

How the idea of the Pan Motor Company was first conceived and took form in the fertile brain of its founder, S. C. Pandolfo, is related in detail and the entire story of achievement, from the day of its birth to the present moment, is set forth in plain English. The great plant as it now stands is minutely described in word and picture.

The personnel of the company is dealt with in an exhaustive manner, giving the reader full information relative to the men back of the enterprise, who and what they are and what they stand for in the business, financial and industrial world, from the president down.



It is the true history of a young industrial giant, advancing with great, firm strides, knowing its own power and confident in its ability to achieve the end for which it was created. The man who can go studiously through these pages and who, when he has finished, is not moved by the marvelous accomplishment so clearly and positively indicated is indeed strangely constituted.

It should be remembered that considerable time is required in compiling a work of this character and that owing to the rapid growth of the plant many of the illustrations are already out of date. This situation cannot be avoided with an enterprise that has attained the remarkable speed of the Pan Motor Company and the reader can safely go on the assumption that many changes and improvements have taken place and will take place since this book was started and before it reaches the public. Every day Pan makes a bigger and better showing. Every working hour tells a new story. But we can't photograph the future. If we could this volume would be several times its present size.

Bewitching as fiction and as stern and accurate as mathematics is this wonderful tale of Pan. May the following pages do it justice.

Saint Cloud, Minn.  
October 15, 1918

—B. F. Forsyth  
C. W. Williams  
Compilers

*ATTENTION is called to the fact that, although the greatest care has been exercised by the authors, in the compilation of this comprehensive volume, to make it an accurate, errorless, true-to-fact story of the history and achievements of this company from its inception to the time the copy was placed in the hands of the printer, the officers of the Pan Motor Company assume no responsibility or liability for any errors, inaccuracies or misstatements of fact which may occur in this printed book.*



# CONTENTS

SAMUEL CONNER PANDOLFO—The Man Behind	- - - - -	Frontispiece
PURPOSE OF THE BOOK	- - - - -	7
PROLOGUE—"To the Glory of Allah"	- - - - -	11
HISTORICAL SKETCH	- - - - -	15
AN INVITATION	- - - - -	21
SAINT CLOUD—The Home of the Pan	- - - - -	22
Minnesota's Resources—Chart B	- - - - -	Cover Pocket
Transportation Facilities—Chart A	- - - - -	Cover Pocket
<b>PRODUCTION</b>		
The Building of a Motor Car	- - - - -	29
Assembling the Model 250	- - - - -	53
Painting the Model 250	- - - - -	64
Pattern Making	- - - - -	75
Dependable Power a Foundation Stone	- - - - -	88
The Pan Drop Forge Plant	- - - - -	100
How Drop Forgings are Made	- - - - -	102
Heat Treating the Forging	- - - - -	109
<b>BUILDINGS AND EQUIPMENT</b>		
Experimental Engineering Building	- - - - -	30
Blacksmith Shop	- - - - -	41
Main Production Unit—Factory No. 2	- - - - -	47
Loading Platform	- - - - -	83
Warehouse	- - - - -	86
Main Power Plant	- - - - -	87
Pump House	- - - - -	98
Water Tower	- - - - -	98
Die Shop	- - - - -	101
Heat Treating Plant	- - - - -	121



BUILDINGS AND EQUIPMENT—Continued

Laboratory Building	-	-	-	-	-	-	-	-	-	-	-	-	-	-	-	-	-	124
Oil Storage Building	-	-	-	-	-	-	-	-	-	-	-	-	-	-	-	-	-	126
Drop Forge Office Building	-	-	-	-	-	-	-	-	-	-	-	-	-	-	-	-	-	129
Drop Forge Power Plant	-	-	-	-	-	-	-	-	-	-	-	-	-	-	-	-	-	130
Hammer Shop	-	-	-	-	-	-	-	-	-	-	-	-	-	-	-	-	-	133
List of Additional Machinery Ordered																		144
“A Sermon In Bricks”	-	-	-	-	-	-	-	-	-	-	-	-	-	-	-	-	-	151
Property Plat	-	-	-	-	-	-	-	-	-	-	-	-	-	-	-	-	-	152
Ground Plans	-	-	-	-	-	-	-	-	-	-	-	-	-	-	-	-	-	153-157
Quantities of Construction Materials Used	-	-	-	-	-	-	-	-	-	-	-	-	-	-	-	-	-	158
Perspective and Ground Plan—Drop Forge Group—Chart C																		Cover Pocket
Perspective and Ground Plan—Engineering, Production and Power Group—Chart D	-	-	-	-	-	-	-	-	-	-	-	-	-	-	-	-	-	Cover Pocket
PAN—Feature Car of the Future	-	-	-	-	-	-	-	-	-	-	-	-	-	-	-	-	-	163
Brief Specifications	-	-	-	-	-	-	-	-	-	-	-	-	-	-	-	-	-	174
Proving the Power of Pan	-	-	-	-	-	-	-	-	-	-	-	-	-	-	-	-	-	177
ADMINISTRATION	-	-	-	-	-	-	-	-	-	-	-	-	-	-	-	-	-	185
Board of Directors	-	-	-	-	-	-	-	-	-	-	-	-	-	-	-	-	-	187
Executive Department	-	-	-	-	-	-	-	-	-	-	-	-	-	-	-	-	-	194
Engineering and Manufacturing Corps	-	-	-	-	-	-	-	-	-	-	-	-	-	-	-	-	-	198
General Offices	-	-	-	-	-	-	-	-	-	-	-	-	-	-	-	-	-	215
PAN-TOWN-ON-THE-MISSISSIPPI	-	-	-	-	-	-	-	-	-	-	-	-	-	-	-	-	-	231
Plat of Pan Addition	-	-	-	-	-	-	-	-	-	-	-	-	-	-	-	-	-	235
Motor Hotel	-	-	-	-	-	-	-	-	-	-	-	-	-	-	-	-	-	254
PEACE	-	-	-	-	-	-	-	-	-	-	-	-	-	-	-	-	-	255
FUTURE PLANS	-	-	-	-	-	-	-	-	-	-	-	-	-	-	-	-	-	257
Lifting the Veil of the Future	-	-	-	-	-	-	-	-	-	-	-	-	-	-	-	-	-	259
Plans, Purposes and Objects for Which the Pan Motor Company was Organized																		263
THE PROMOTOR	-	-	-	-	-	-	-	-	-	-	-	-	-	-	-	-	-	265





# P R O L O G U E

**T**HERE was a certain citizen of Bagdad who was minded to build a minaret to the glory of Allah. It was to be taller than any other in the realm and was to have a window facing Mecca far up on its side where the Muezzin could stand and call the faithful to prayer. He considered the matter a long time and when his mind was fully made up, told his fellow townsmen of his intention.

At first they gazed upon him in amazement as he explained how this minaret was to be built. Some looked at one another pityingly and pointed at their foreheads. Others argued with him vehemently that the time was wrong—that the drouth had killed all the vines so that there would be no wine and the flocks were without grass, that there was nothing to sell to get the gold with which to pay the workmen, and besides they were at war with the infidels who were even then beating at the gates.

When he still persisted in his plan they went about among the people and cried out that this fellow was a thief and would steal a part of the money they gave to the glory of Allah.

Still the man went on proclaiming his faith in his undertaking, in spite of all that was said against him.

Then there arose a sound of many blows—even as strong men beating clamorous anvils, and of mocking, until the land was full of the sound of it. And a great company of knockers stood about saying that it could not be done, that no man could be found foolish enough to give gold for such a crazy thing. Others hailed him and his workers before the Caliph Haroun-al-Raschid and bore witness against them that they were thieves and fools. The Caliph found no guile in them and in fact, praised them for their piety and wisdom.

Suddenly the hammer brigade was sore confounded. The uproar they made saying that the thing could not be done was overwhelmed by the noise of the builders doing it. High above every other near it the new minaret to the glory of Allah (of whom there is but one) stretched up, and the unbelieving dogs outside the gate gazed at it astonished.

Then the defenders perceived that the minaret was so high that from its top they could cast fire and stones down upon the infidels who besieged them, and quickly did so, driving them away in dire confusion.

Then the knockers' brigade and the anvil chorus all shouted for joy with the rest and sought to shake the hand of this citizen and said they had believed in him all along.

But the man was so busy finishing the minaret that he did the same as he had before—he paid no attention to them or what they said.





# HISTORICAL SKETCH







# HISTORICAL SKETCH

**S**AMUEL CONNOR PANDOLFO is a superior man. In brain power, in will power, in energy, in foresight, in magnetism, in courage and in resourcefulness he has few superiors in the world of finance and industry; and yet he is a man of and for the people. His life has been a busy one and his labors have been of such a character as to bring him in touch with the rank and file, with the working man, with the mechanic, with the farmer, with the business man, with the ranchman and stockgrower; in short, with the real backbone of the human race—the very cream of the earth. He has always had dealings with the producers, the men who create the wealth and the men upon whom the rest of the people depend for sustenance. This intimacy has given him a clear insight into human nature. He knows and sympathizes with the thoughts and aspirations of the common people in all walks of life.

## His Life Insurance Career

His activities for many years prior to the inception of the Pan Motor Company were directed in a channel where more real good has been accomplished than in any other business, that of life insurance, which has for its fundamental principle the care and protection of the women and children. He operated in the great, broad states of Texas, Oklahoma, Arizona and New Mexico, a vast district noted throughout the nation for its splendid manhood and womanhood. He was in his true element; the business and the surroundings were congenial and as an insurance man he was one of the most successful that ever entered the Southwest. His agency covered the four states just mentioned and was the largest in the world in point of territory and one of the most important in the character and amount of business done; Mr. Pandolfo, personally, and through his various agencies and agents scattered over this vast district, placed on the books of his companies nearly a hundred million dollars. This was the only life insurance general agency in the world representing three companies at the same time. Of course this huge business required extensive capital for its successful operation. In the Southwest there is practically only one pay day in the year and that comes when the farmers realize on their crops and the stock growers make their annual shipments to the Eastern markets. In the meantime insurance agencies had to be financed and as a consequence there was never a time when Mr. Pandolfo was not carrying considerable paper. There was nothing surprising about this situation and as long as prices were good



the business advanced by leaps and bounds. But with the advent of the European war the bottom fell out, cotton prices slumped and the banks were forced to withdraw credits right and left. In fact, all business conditions in the South were demoralized and the prospects for a change for the better were remote. This left Mr. Pandolfo deeply involved, but by no means broke; he had plenty of paper which in normal times would have been worth its face value and from which he has since realized thousands of dollars, besides he had a substantial income from insurance renewal commissions.

It was this deplorable situation and unforeseen circumstance that caused Mr. Pandolfo to first consider the advisability of retiring from the insurance business. Had it not been for the war it is safe to say that he would still be operating in the field in which he was so successful for so many years. His heart was in the work, because he realized that while he was making money for his companies and himself he was also giving in return for that money the greatest and best value it would buy and in addition a protection to the home that was practically invaluable.

This opens to view the dominating characteristic of S. C. Pandolfo—his kindly feeling for the people, his inherent desire to see the people share more fully in the good things of life, to see them have more opportunities, more comforts, more conveniences. And when it is stated that out of this desire and combination of circumstances sprang the idea of the Pan Motor Company, with its original, frank and unique plan of operation, there is no desire to appeal to sentiment or to magnify an unimportant fact. Opportunities for studying the automobile needs and requirements of the South and West were plentiful and his mind was on the problem a considerable portion of the time, for he realized that no make of car selling at a popular price quite filled the bill, that there was really room for many improvements and that the automobile of the future, so far as the country is concerned, must embody many essentials so far overlooked or ignored. There are plenty of cars that perform admirably on the boulevards, but none had given entire satisfaction over the farm lands and prairie districts of the West, through the mountains and over the deserts, up and down, in and out, and under all manner of road conditions. More power was needed, greater clearance was demanded, better facilities for carrying supplies and equipment, and the sleeping problem on long trips was a matter requiring serious consideration. All of these points and many others, now embodied in the 1919 Pan, were brought vividly to the mind of the organizer of the Pan Motor Company in those strenuous days in the West.



### Owned 37 Automobiles

S. C. Pandolfo was the first man to use an automobile for getting over the country in a business way in the Southwest. From its first introduction to the present moment he has been an automobile fan, and although neither an engineer nor mechanic, he probably has as good an idea of what a car should be and do as any man in the world. While looking after his insurance business in the four big states mentioned above he traveled constantly and during the period purchased and drove thirty-seven machines, representing practically all of the leading makes. Certainly this long experience with so many kinds of machines, in a country with every possible climatic and road condition, should suggest to the mind of any thinking man a number of ways in which car building might be improved, and even more so in the case of Mr. Pandolfo, who had made the automobile his main hobby for years and had dreamed of his present project and its great possibilities as far back as eight years ago.

### Idea Develops On One of His Long Drives

It was on one of his long drives, unaccompanied, over roads that made innumerable demands for a more versatile car that this thought took full form and developed into an idea that would not be denied. The determination to remedy the situation had seized him and from that time forward his thoughts and energies were occupied in developing a plan of operation and in making that plan effective. It was the birth day and the birth place of the Pan Motor Company, now so much in evidence at Pan-Town-On-The-Mississippi.

Mr. Pandolfo was wise enough to see that under the conditions prevailing in the Southwest at that time his future was uncertain, and believing that he was entitled to make more money than seemed possible under such adverse circumstances and having had for some time a desire to become identified with the automobile industry he considered the occasion opportune and the step was taken.

### Procrastination Is the Thief of Time

Having once made up his mind to organize a company, build an automobile plant and eventually create and manufacture the ultimate Pan car, the next step that naturally occurred to him was to do it. Mr. Pandolfo is not a procrastinator. With him there is no delay. Now is the only time he knows and what there is to do, so far as he is concerned, must be done now. Suiting his action to his disposition he proceeded to get busy and placed his proposition before a number of people in the terri-



tory in which he was then located. His plan was favorably received and he was accorded the moral and financial support of many of the substantial business men, financial men, ranchmen and farmers of the South and West.

### Offices Opened in Chicago

Later he opened offices in Chicago from which he operated for a time and always with the same satisfactory results that had been experienced from the start. The Pan Motor Company was a success from the beginning, for two very definite and distinct reasons. First: Its plan of organization was and is as far in advance of the method ordinarily employed in such undertakings as the car it is now building is in advance of the first high wheel, solid tired horseless carriage. Second: The man behind the enterprise, the man in whose brain the idea first took form, is a man who never quits, who never lets up on his speed, who gets what he goes after and who knows no other goal but success.

### Location of Plant Decided On

In the meantime the question of location had been engrossing his attention. A number of points had been considered and many inducements and concessions had been offered by the commercial organizations of various cities throughout the Central West, but so far none of these seemed to have in the fullest measure all the elements and advantages necessary to the proper development of the business. Mr. Pandolfo had an extraordinary project on foot and was naturally looking for an extraordinary location, one that would have merits in harmony with his enterprise, one that would supply as nearly as possible all the needs of such an institution. Nothing less would be satisfactory.

Such was the situation when Minnesota attracted his attention. Looking over this wonderful state he observed that it was rich in agriculture, never having had a crop failure; that it supplied three-fifths of the iron ore of the United States and had timber resources unsurpassed anywhere; that its water power was abundant; that labor and living conditions were of the best; that it was within immediate and direct touch with the greatest markets, and that it possessed to an unusual degree other more or less minor advantages. Thus it was that Minnesota made the most favorable and convincing appeal. In Mr. Pandolfo's mind the Gopher state had every appearance of being one hundred per cent satisfactory. But what city gave the best access to these resources and the markets of the world? This was another question, but one whose solution proved to be simple enough. A brief study of the map answered the question in favor of Saint Cloud, and so Saint Cloud was selected as a possible location.





The next step in order was to see what the people of Saint Cloud might think about it. You know some communities object to being modernized and industrialized. They don't like the idea of new blood, new energy and an influx of live, wide-awake, up-to-date people. They want to go along in the old rut and do just as they did fifty years ago. But not so with Saint Cloud. The people here realized at once that a real man had entered the gates of the city and that a modern enterprise of no inconsiderable proportions was seeking to become a part of the municipality. So, after due deliberation, they extended a befitting welcome and the first plan contemplated some concessions. These, however, were later thankfully refused by Mr. Pandolfo who preferred to cast his lot in Saint Cloud on its real merits as a location for an automobile factory and to proceed with his plans without let or hindrance, either then, now or in the future.

#### Incorporated January 8, 1917

The Pan Motor Company was incorporated under the laws of the state of Delaware January 8, 1917, and on the 1st of March following offices were opened in the Farmers' State Bank Building at Saint Cloud. Mr. Pandolfo had associated with him at that time the present secretary of the company, John Barritt, the present auditor, Edward J. Gorman, and A. Robinson, a salesman, who is still with the company. The first board of directors consisted of five members and included among its number some of the best financial and business men of Saint Cloud. Later the number was increased to twelve, the seven additional members bringing increased financial strength and prestige to the organization. The Commercial Club and the business men generally gave the enterprise their fullest support and progress was rapid.

#### Building Program Started June 1, 1917

On the first of May a factory site, comprising  $47\frac{3}{4}$  acres, was purchased and in June the first building, Factory No. 1, was under construction. From that time to the present moment there has never been a let-up on the building program, other than that necessitated by weather conditions. The first ten Pan cars were manufactured by an Indianapolis concern and on July 1st the first of these made its appearance on the streets of Saint Cloud, having been driven by Mr. Pandolfo from the Indiana metropolis without accident or trouble and on schedule time.

On July 4th a great barbecue was held on the grounds where the drop forge plant now stands and the new Pan car was on exhibition all day. Without a doubt it was the greatest day in the history of Saint Cloud; it was estimated that 70,000 people were in attendance. This wonderful demonstration gives the reader some insight into the powerful personality of Mr. Pandolfo; his faith in and



respect for the people and his remarkable power and magnetism. He and the product of his brain were the centers of attraction. It has been so from the first and today the man, Pandolfo, and the organization he heads, the Pan Motor Company, are known throughout the length and breadth of the country where people talk plain English and keep themselves posted on industrial events and enterprises of the greatest importance.

#### Constant, Intelligent Effort Price of Success

The Pandolfo spirit is the spirit that wins. On the job day and night; at his desk with his coat off, doing the thousand and one things necessary to be done with speed and alacrity; facing his labors and the future quietly and cheerfully, knowing well that constant, intelligent effort is the price that must be paid for success, he has in a little more than a year made a most remarkable showing. It is the work of the Pandolfo spirit. That spirit permeates every department of the organization. It is imparted to every individual connected with the company, from the office boy up. It is in the air at Pan Town and Saint Cloud and the citizen who does not feel it and is not moved by it is dead from the shoulders up.

With every possible element in its favor, with the unbroken success it has already achieved, amply attested by the photographs in this book, with nothing against it except the jealousy its importance has created in certain quarters, the Pan Motor Company is moving rapidly on its way to greater and better things.



*"An Achievement"*



## An Invitation

*REALIZING the impossibility of conveying to the reader an accurate and exact impression of the great plant of the Pan Company in all its innumerable details through the medium of language and pictures, regardless of the time spent and the great care exercised in the preparation of this book, the management wishes to take advantage of the opportunity here presented to extend a cordial invitation to each individual and the public generally, to visit Saint Cloud—the home of the Pan—and to view with their own eyes the splendid work that has been done. All who can possibly do so are not only invited, but they are urged to make the trip. It is a sight well worth seeing, and once seen will be long remembered. After a trip through Pan Town and the Pan Plant, the reader will realize the inadequacy of the contents of this volume and to what extent they fall short in disclosing the real situation.*

*Come and look us over. We will be pleased to see you and you will be glad you came.*



# SAINT CLOUD THE HOME OF THE PAN

THE history of almost any community is interesting. This is particularly true of Saint Cloud. But the world today is giving little heed to history. It is too busy making history. Live, red-blooded men are interested only in the present and the future. What has been is no more. Records are being smashed on every hand. The world is moving at a pace never before known and Saint Cloud has a proud place in the vanguard of progress. It is not the purpose here to consider what has been, but what is, and what will be.

Precedents cut very little figure in modern life. Old dates and old incidents are losing their charm, except for those who have not yet entered into the spirit of the times. There are thousands of cities with a creditable past, but the past is gone and for the most part forgotten in the teeming activity of the ever-present now. Those who pause and look behind are overwhelmed. Those who welcome the rising sun and face the coming day drive on to better things and ultimate victory.

Saint Cloud, Minnesota, is a modern city with its head up and facing the future. It is not an accident nor an incident, but a premeditated intention. It is not of minor consequence, but of major importance. It is not a satellite, but a planet. It is not on the edge of any community, but in the middle of one of the greatest and richest sections on earth. These are not broad, sweeping statements. They are concentrated, undeniable facts.

## Ideally Located

The capital of Stearns County, the best agricultural and dairying county in the state, Saint Cloud is located on the Upper Mississippi river, seventy-five miles south of the center of Minnesota, the commonwealth with ten thousand lakes.

In the building of a city, location is vital. Accessibility is of paramount importance. This fact was recognized by the Indians who called the present site of Saint Cloud O-za-te, meaning "the forks of the road." Here three great National Highways and innumerable country roads furnish easy communication with all points on the compass. The National Parks Highway, or Red Trail, from New York to Seattle, the Jefferson Trail from Winnipeg to the Gulf, and the Minnesota Scenic Highway, all lead

Continued on page 25



ST. GERMAIN STREET LOOKING WEST



ELKS HOME



ST. GERMAIN STREET LOOKING EAST POST OFFICE ON RIGHT



ONE OF THE GRANITE QUARRIES



ST. RAPHAEL'S HOSPITAL



ONE OF THE POWER DAMS

VIEWS IN AND AROUND SAINT CLOUD



PUBLIC LIBRARY



PAPER MILL NEAR ST. CLOUD



ONE OF THE CHURCHES AND PAROCHIAL SCHOOL



STATE NORMAL SCHOOL



THE INSTITUTE AND AUDITORIUM



HUNDREDS OF ISLANDS DOT THE MISSISSIPPI



TECHNICAL HIGH SCHOOL LOOKING ACROSS LAKE GEORGE

VIEWS IN AND AROUND SAINT CLOUD



Saint Cloud—Home of the Pan—Continued from page 22

in and out of Saint Cloud, giving the city unexcelled advantages in the highly important matter of good roads in all directions; for be it understood that the roads in Minnesota and especially in the country tributary to Saint Cloud are the finest in the land. Two transcontinental railways, with their numerous branches, furnish swift passenger and freight service to all commercial centers and the outside world, while the Mississippi river, with its navigation possibilities and almost unlimited water power, now harnessed and in daily use, is one of the city's most valuable assets.

Thus are supplied the three great means of travel and distribution of commodities—water, road and rail. When air transportation becomes a common practice, as it doubtless will at an early date, Saint Cloud will be found “up in the air,” for the enterprise of its citizenship as it is now constituted will not permit it to fall behind (or below) in the race it is making for industrial and commercial supremacy.

Saint Cloud has a population of 16,000 and is growing rapidly. Its people are industrious, frugal and progressive. The city is clean physically and morally. It has wide, clean streets and alleys, clean back yards, beautiful lawns, fine shade trees, numerous parks and handsome homes. As a matter of fact, Saint Cloud is essentially a home city, with probably ninety-five per cent of its people living under their own roofs.

#### Educational Facilities are of the Best

Both the city and the state are noted throughout the country for their institutions of learning. Minnesota has larger funds for this important purpose than any other state in the Union and Saint Cloud is one of its educational centers. Here is located the largest and the best of the State's four Normal schools. This institution has a capable and efficient faculty of forty-two members and every modern convenience and equipment. It has two large dormitories for the accommodation of young women students at a minimum cost. A special building is provided where students may acquire actual experience before assuming their work as teachers. The normal department embraces an elementary course of three years and an advanced course of five years, also a professional course of one to two years for graduates of approved High schools and a kindergarten training course of two years. The Saint Cloud Normal school has a record of the largest attendance of all state Normal schools and has graduated over 2,000 pupils. The buildings and grounds are attractive and well kept and the location is ideal, overlooking the Mississippi river.

During the past year a new Technical High School building has been completed at a cost, including equipment and site, of \$240,000. It is located on the banks of Lake George, with a campus of five acres, and is undoubtedly one of the best and most modern school buildings in the state. The people of Saint Cloud are justly proud of this splendid institution. The Catholic diocese maintains a High school

Continued on page 32







# PRODUCTION

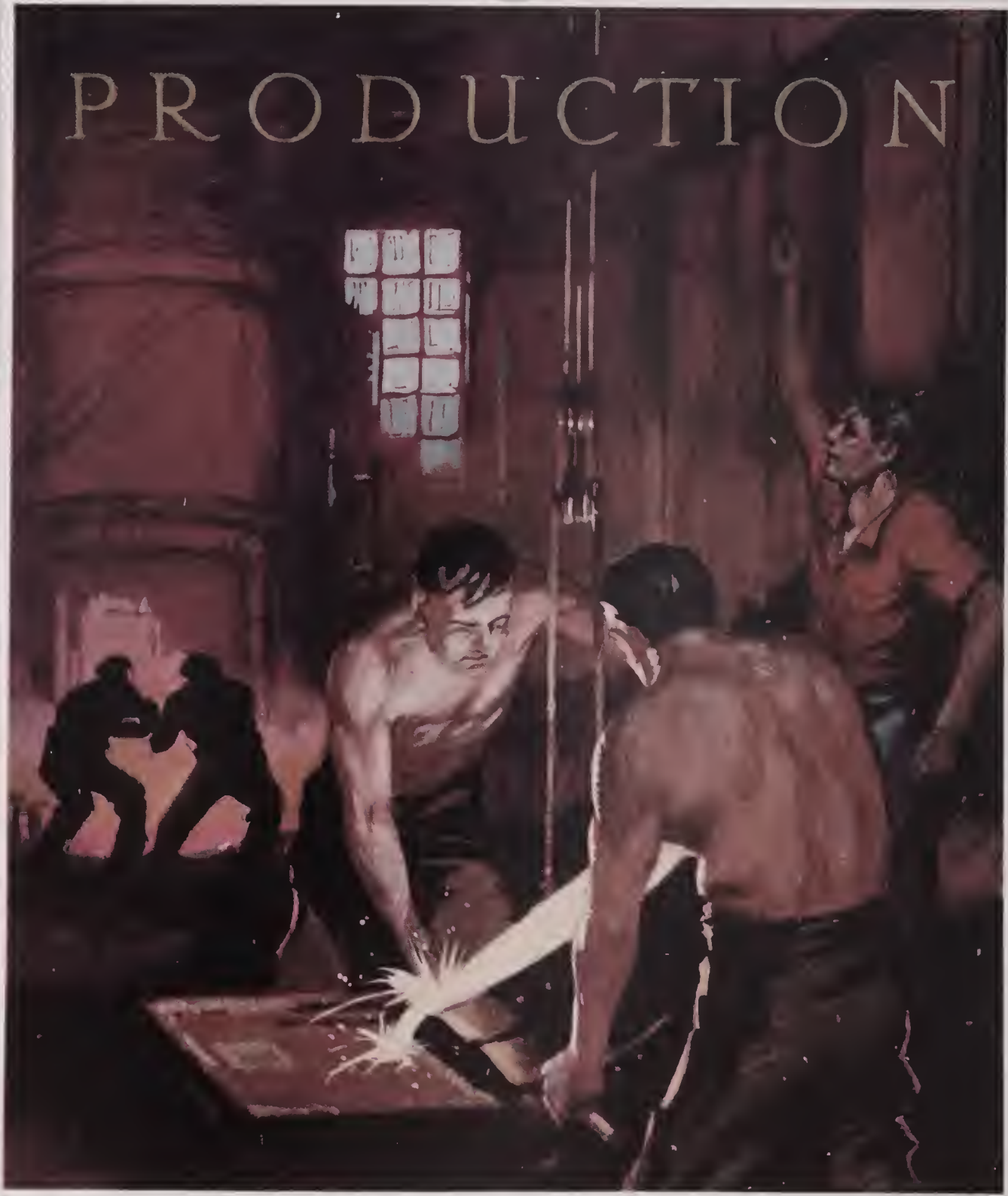





# THE BUILDING OF A MOTOR CAR

**B**UILDING a motor car is not at all like what a little boy said of cigar making—"nothing to it at all—they just take some tobacco and make 'em."

They take iron and steel to "make 'em," but there is a great deal to it.

First is the drafting room where the complete car is carefully and painstakingly drawn to scale and later full size. The labor involved in this part of the process is prodigious, sometimes months elapse before a satisfactory set of plans is ready for the experimental work-shop.

Then a complete car is built by hand in the experimental work-shop, a building set aside from the main factory and devoted to experimental and research work. It can be imagined that this shop—really a small factory—must be fully and completely equipped in order to handle such an order.

This was the first building to be put up on the property—passers-by who, in July, 1917, saw that lone building beside the railroad track in the midst of the wide prairie, stared at it and passed on.

They knew little and cared still less what it was, but it was the start—the foundation of greater things to come.

Too many new automobiles are manufactured and sent out on the roads before their time, and the purchasers do the testing. It may look like economy to cut a few hundred dollars off the expense of building a new model but it is the dearest economy that was ever practiced.

An automobile, truck or tractor may look well on paper—a great many things are theoretically correct but practically are absolute failures. The true acid test is the test of daily use under every condition that can possibly be conceived.

There is only one way to do this—just one. That is to build the machine by hand, test everything in it in every possible way and then run it, not one thousand miles, but ten thousand, fifty thousand—far enough and hard enough to try out every atom in it.

If it stands up to punishment it is an automobile. If it does not—to the junk pile.

Concluded on page 31



# EXPERIMENTAL ENGINEERING BLDG



FIRST UNIT OF PAN PLANT

This building was the first to appear on the Pan property. While the big concrete factory building was in course of construction Pan cars were turned out here.



AT WORK ON THE 1919 PAN MOTOR



SOME EXAMPLES OF WOOD PATTERN MAKING

The Building of a Motor Car—Concluded from page 29

The new model Pan or the car on which the company will go into quantity production, was run over eight thousand miles and then taken to pieces. The designers carefully checked up every piece in it without finding the slightest indication of undue strain or any appreciable wear.

They put it together again and sent it out for more punishment. It is being overloaded, driven at high speed over rough roads, sent up stiff climbs, through sand, through mud, through all kinds of roads and in all kinds of weather.

No more tedious or more long drawn out job can be imagined than the building of this first car. Of course some few parts are to be had ready made such as wheels and springs, etc., but for the most part, it is the raw material—and brains.



THE RAILROAD ENTRANCE TO THE PLANT

The Company's side track joins the Great Northern at this point and runs the entire length of the south side of the plant, over a half-mile long. From here connections are made with the Northern Pacific. See Chart "A" and note excellent transportation facilities afforded Saint Cloud

*Saint Cloud—Home of the Pan—Continued from page 25*

and three parochial schools, all having a large attendance. The High school building was recently erected at a cost of \$75,000, including equipment, and is admirably adapted to its purpose.

At Collegetown, a short distance from Saint Cloud, is St. John's University. It is located on the shores of Lake Sagatagan, among the pine groves, and is one of the largest theological schools in the West. It furnishes accommodations for 400 boys and 51 instructors. At St. Joseph, a suburb of Saint Cloud, is located St. Benedict's Academy for girls. Both of these are noted schools and attract attendance from a distance. The city also has two business colleges and other schools.

The Saint Cloud Library and Free Reading Room is one of the centers of attraction and is well patronized. It contains 15,000 volumes. In the basement is a well furnished assembly room. It was largely through the efforts and financial assistance of the Ladies' Reading Room Society, which furnished

*Continued on page 34*

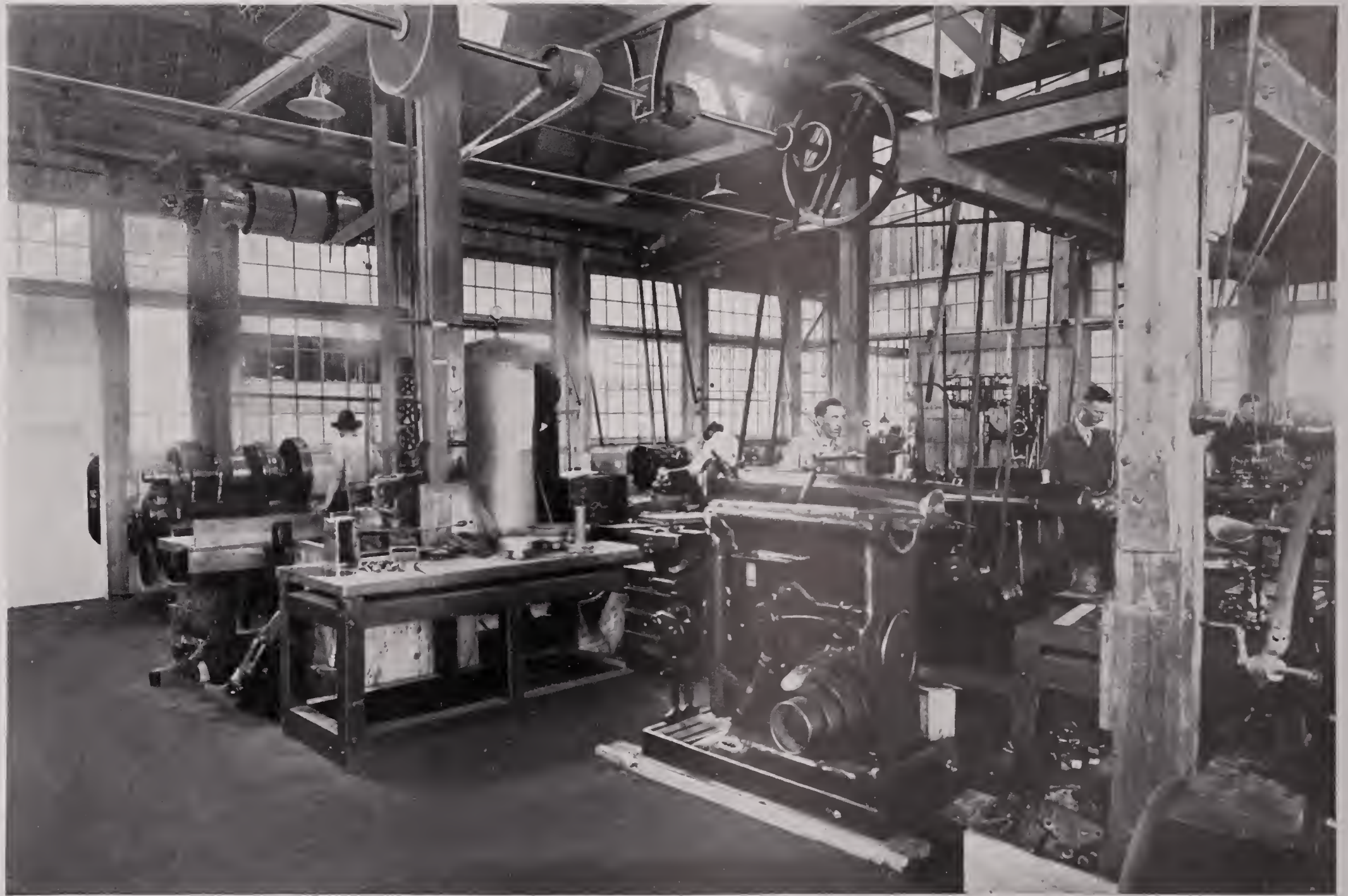

A SECTION OF THE EXPERIMENTAL MACHINE SHOP

An experimental department must be equipped to build the entire car—It is really an automobile factory on a small scale—where the most modern machinery is required.

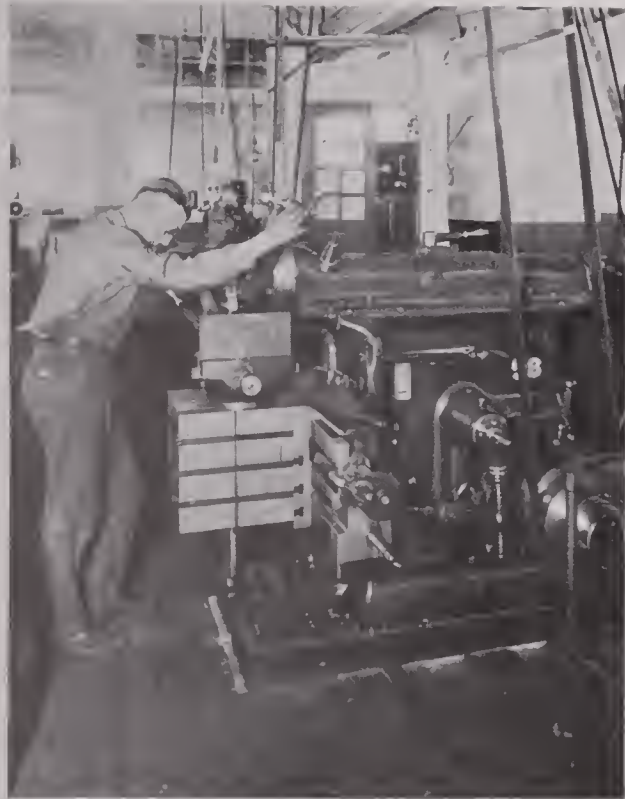

EBERHARDT HI-DUTY SHAPER



SIPP QUICK CHANGE SENSITIVE DRILL

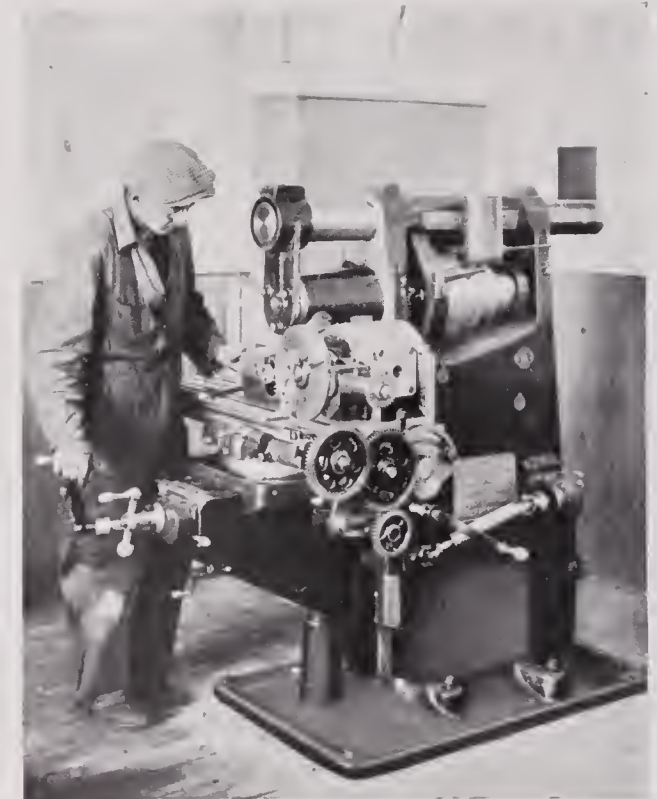

CINCINNATI No. 2 UNIVERSAL MILLER

Saint Cloud—Home of the Pan—Continued from page 32

the site for the building, that this necessary institution was secured. There are a number of other literary and study organizations, as well as numerous clubs and societies of a social character.

### Religious Denominations Well Represented

Saint Cloud is well supplied with churches. The leading Protestant denominations are represented with good church buildings and, in the main, strong congregations. This being the Bishop's See of the Catholic church a cathedral and two parish churches are required and are well attended. The Baptists have two churches, the Lutherans four, Episcopalians one, and the following denominations are all represented with one church: Unitarian, Christian Scientist, Presbyterian, Methodist, Seventh Day Adventist, Church of God and Gospel Hall. The Methodist society has recently erected a new edifice with a parsonage; the Baptists have also recently erected a new parsonage, and the Presbyterians have just completed a new church building, constructed of granite, which is one of the finest in the state.





CINCINNATI UNIVERSAL TOOL GRINDER



LELAND-GIFFORD HI-SPEED SENSITIVE  
DRILL PRESS



WEIGEL 25-INCH DRILL PRESS

### Has A Live Commercial Club

Saint Cloud has one of the most active Commercial Clubs in the country. Through its constant efforts many improvements have been made and its influence is felt throughout the county and the state. Its membership is composed of a live, aggressive bunch of business and professional men who know how to do things and who never rest until they have accomplished their purpose. They have a working program and all hands are constantly on the job. There are no drones, no shirkers, no loafers; but all are steadily working for the best interests of Saint Cloud, Stearns County and Minnesota. This pull-together spirit and this constant plugging have brought about many important improvements in recent years and there is a community interest and singleness of purpose which mean much to the future of the city. The club has large and convenient quarters in the heart of the city which are open at all hours of the day and evening. Geo. C. Mantor, secretary of the club, is a live wire and is thoroughly informed not only regarding the city, its points of interest, its business and social life, its needs



HAMILTON 16-INCH ENGINE LATHE

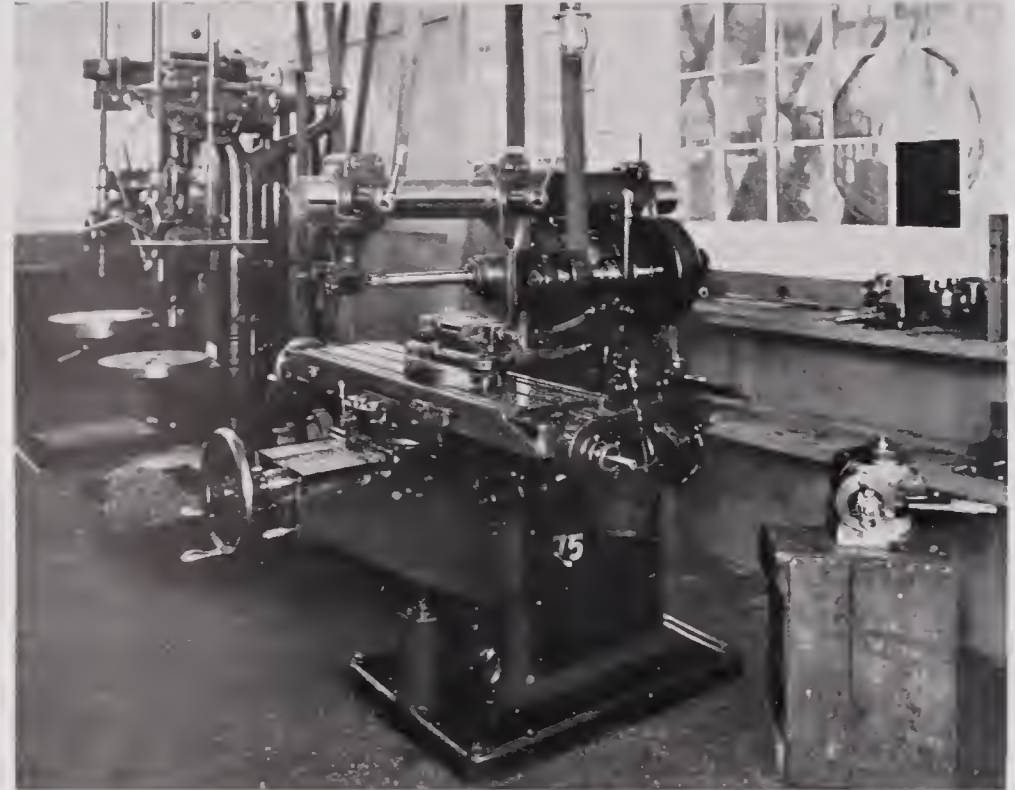

LE BLOND HEAVY DUTY MILLING MACHINE

and requirements; but is also fully posted on county and state matters. This information is on his tongue's end and finger tips and may be had for the asking.

The Saint Cloud Businessmen's Association includes in its membership a large majority of the business and professional men of the city. Its object is to promote the mutual interests of its members and furnish protection in the way of credits. It is an effective organization and is doing good work in its various lines of endeavor.

#### Many Fraternal Organizations

In the fraternal field practically every organization worthy of note is represented. The Elks have a membership of 550 and have recently built a new, handsome home at a cost of \$10,000. The first secret society to have an organization here was the Ancient Free and Accepted Masons, who now have a home in Masonic Temple for North Star Lodge No. 23, Royal Arch Masons and Knights Templar. Other lodges are the Eastern Star, Odd Fellows (with Ursula Rebekah), Knights of Columbus, Catholic Order



HAMILTON 14-INCH ENGINE LATHE



OXO-ACETYLENE WELDING DEPARTMENT

of Foresters (including St. Mary's Court and St. Francis' Court), Knights of the Maccabees, Ladies' Benefit Association of the Maccabees, I. O. R. M., Saint Cloud Camel's Lodge, Degree of Pocahontas, Ancient Order of United Workmen, Degree of Honor, Modern Woodmen of America, Royal Neighbors, Woodmen of the World, Woodmen Circle, Modern Brotherhood of America, United Commercial Travelers, Sons of Herman, Teutonia Lodge, Royal Arcanum, Modern Samaritans, Independent Order of Foresters, Fraternal Order of Eagles, Ancient Order of Hibernians, Daughters of Erin, Equitable Fraternal Union, Brotherhood of All Railway Employees, Court of Honor, Brotherhood of American Yeomen, Ladies' Catholic Benevolent Association, St. Joseph's Benevolent Society and North Star Benefit Association. There is also a Trades and Labor Council, representing the organized labor unions of the community.

The Saint Cloud Automobile Club is one of the largest in the state outside of the Twin Cities. To this organization much of the credit is due for the many splendid roads leading to and from the city and for the construction of the Scenic Highway which skirts the Mississippi river for several miles and which is one of the most beautiful drives in the state.



THE BLUE PRINT ROOM—ELECTRIC PRINTER AND DRYER



ONE OF THE TOOL CRIBS

Other organizations worthy of mention are: the James M. McKelvy Post of the Grand Army of the Republic, the Ladies of the G. A. R., and the Women's Relief Corps. The Old Settlers' Association of Stearns and adjoining counties holds its annual meetings in Saint Cloud. The Saint Cloud Humane Society is active and is doing good work. The Saint Cloud Gun Club has a club house and practice grounds near Waite Park. Two first class theatres furnish plenty of wholesome amusement and entertainment through the medium of pictures, vaudeville and the drama.

#### Social and Recreational Advantages

One of the most deserving institutions in the city, however, and one which is serving a most worthy purpose is the Saint Cloud Institute which was opened to the public in the late spring of 1917. The Institute was erected by the Rev. Joseph E. Busch, D. D., Bishop of Saint Cloud and a man of exceptionally clear vision and broad-minded views. It is a handsome structure and its club room and auditorium are frequented by all the people, regardless of religious affiliations. The board of governors is composed

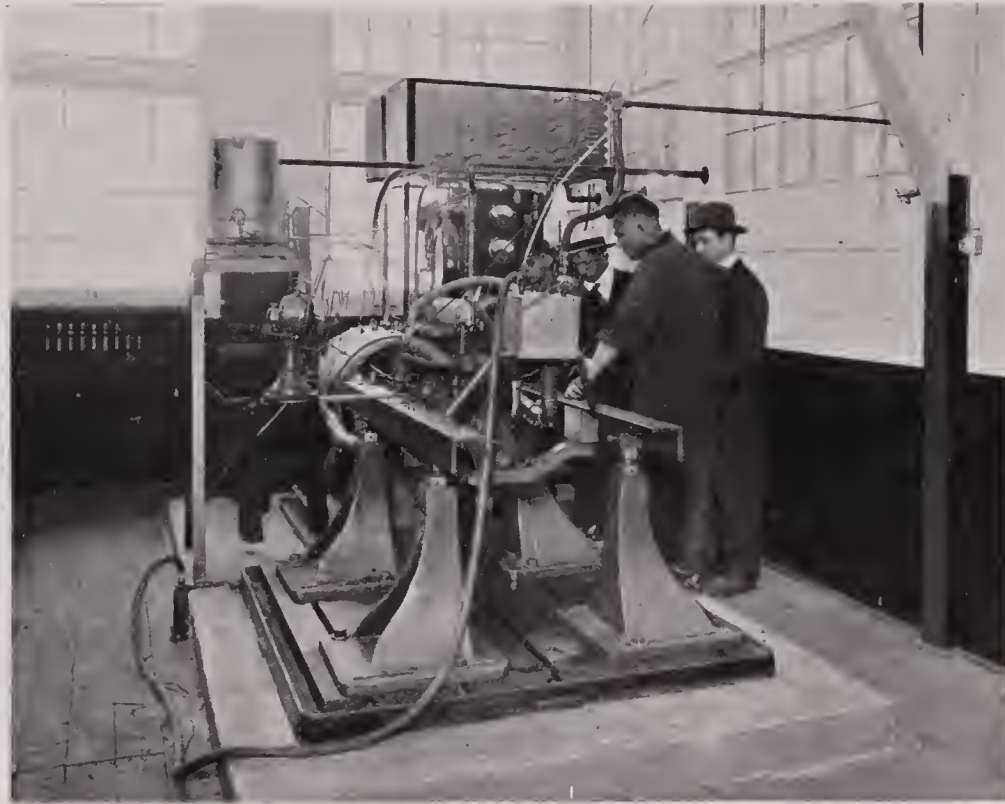

DYNAMOMETER TESTING DEPARTMENT

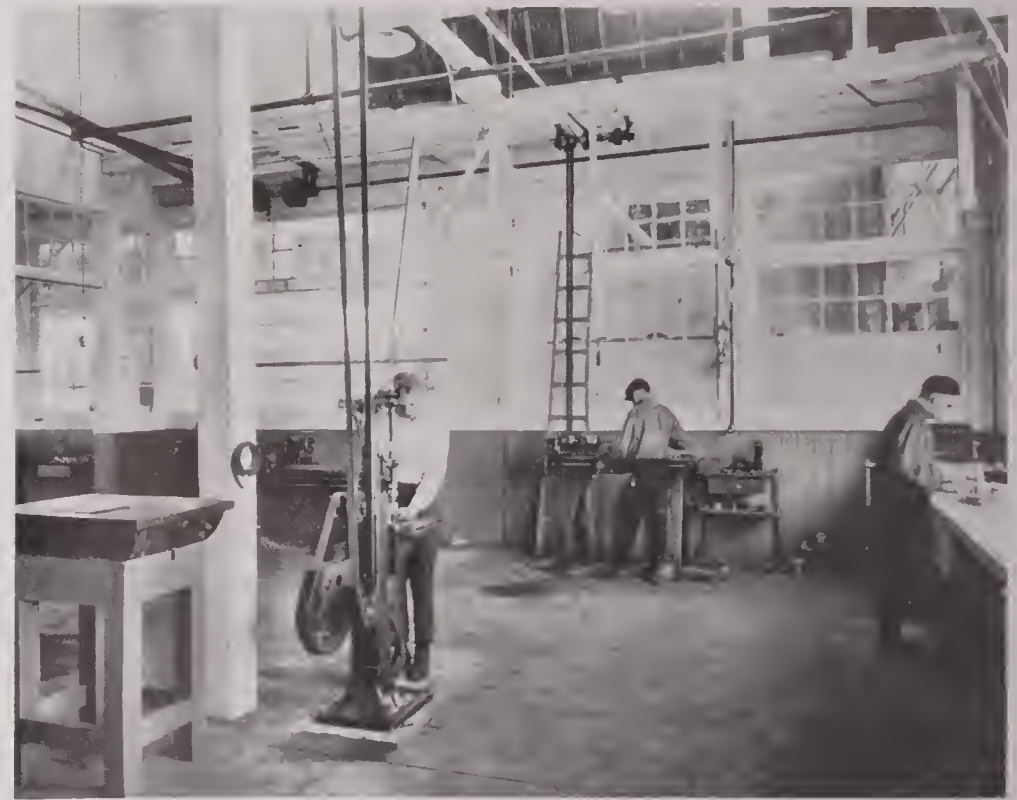

ANOTHER SECTION OF THE MACHINE SHOP

of members from various churches, with Bishop Busch as president. The main building is 45 feet wide and 175 feet in length. The south wing is 120 feet in length and extends along First street south. The style of architecture is of the Colonial type, the construction is of solid brick with Saint Cloud granite trimmings. The auditorium will seat 900 people, while there are halls for societies, club rooms, band room, swimming pool and all other conveniences. The building has an attractive exterior and adds greatly to the architectural beauty of the city.

The Town and Country Club has attractive grounds on the outskirts of the city, with golf links, tennis courts and other features customary with such organizations. The club house has a beautiful situation on the banks of the Sauk river.

There are four city parks—Central park, Empire park, Riverside park and Hester park. In each of these free concerts are given during the summer season by the Saint Cloud Military Band. There is also Athletic park, for baseball and football games. The Benton County fair grounds are located on the east side of the Mississippi river, midway between Saint Cloud and Sauk Rapids. In point of exhibits and

Continued on page 41

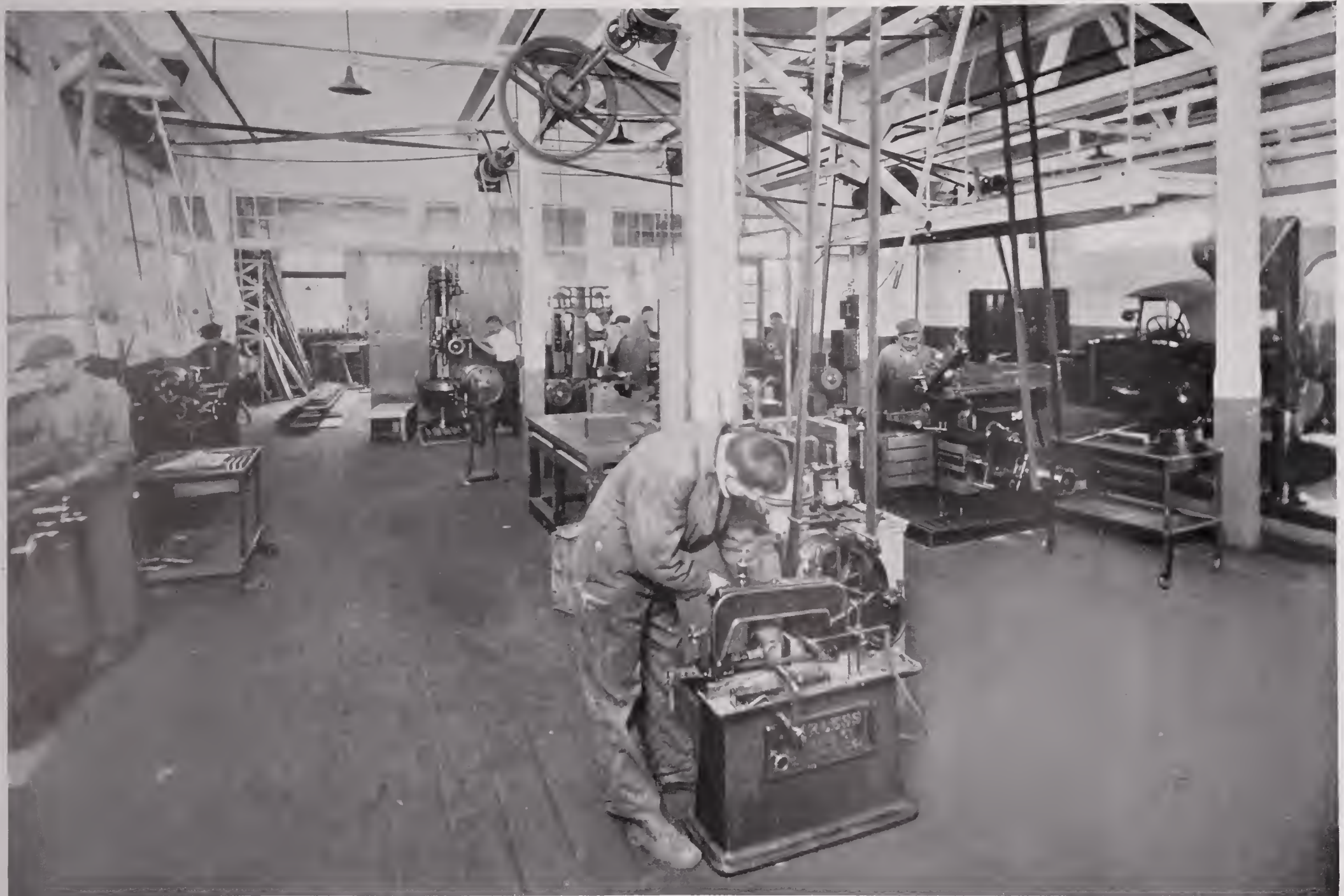

ANOTHER VIEW OF EXPERIMENTAL MACHINE SHOP

Here is where the experimental models are built by hand to prove the car, tractor or truck designed on paper will be practical for the work it will be subjected to on the road and field.



RIVETING MODEL 250 FRAMES

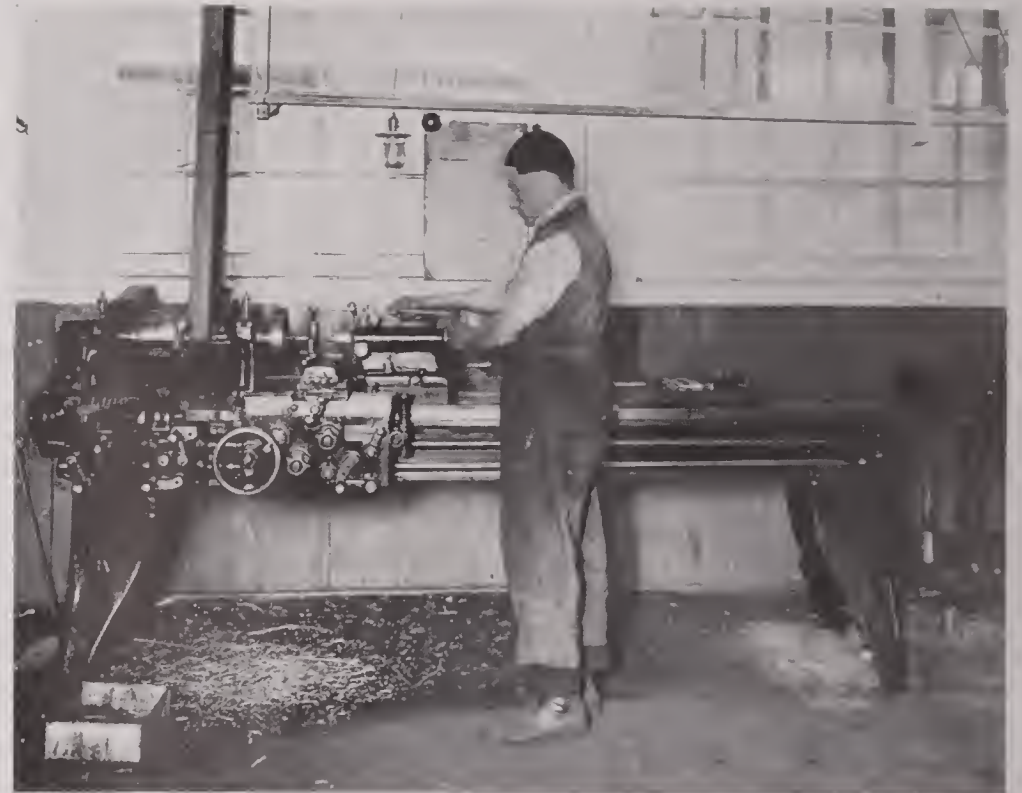

AMERICAN 11-INCH ENGINE LATHE

Saint Cloud—Home of the Pan—Continued from page 39

attractions, as well as buildings and management, the yearly fairs held on these grounds are recognized as the best in the state, ranking second only to the state fair itself.

This is one of the more important events of the year and has had much to do with the agricultural development of this section of the state. Located as it is, at almost the junction point of the three great, wealthy counties of Benton, Stearns and Sherburne, it is rightly regarded as a Tri-county institution. The society owns over 30 acres of beautiful park lands on which are located some of the finest fair buildings in the West, including a main exhibit building, school building, poultry building, live stock barns, grand stands and bleachers, athletic field and race track and large dance pavilion.

The city has two well managed, wide-awake daily newspapers, both giving their readers the latest telegraphic news up to the hour of going to press. They are independent in politics and lend their great influence in all matters pertaining to the best interests of the city, state and nation. They are both loyal to the core.



V. C. TOOL GRINDER



PEERLESS HACK SAW



SENEGA FALLS 9-INCH ENGINE LATHE

St. Raphael's Hospital is a modern institution, occupying a five-story building and conducting a training school for nurses; while St. Joseph's Home for the Aged, located in a beautiful grove on the east bank of the river, furnishes care and comfort for the infirm and those too old to care for themselves.

The Minnesota State Reformatory is located in Saint Cloud on the east side of the Mississippi river, where it has spacious grounds surrounded by a high granite wall. The buildings, which are most substantial in character and imposing in appearance, as well as the walls, are the work of the inmates, built under expert supervision and direction, a granite quarry being on the grounds and within the inclosure. A farm of several hundred acres is under cultivation and furnishes plenty of useful employment for the boys, a considerable portion of the supplies consumed at the institution being derived from this source. The management is progressive and operates under the most up-to-date and approved methods for handling wayward youths and directing them into paths of usefulness and good citizenship.





BARNES 16-INCH UPRIGHT DRILL PRESS



WILLEY ELECTRIC TOOL GRINDER

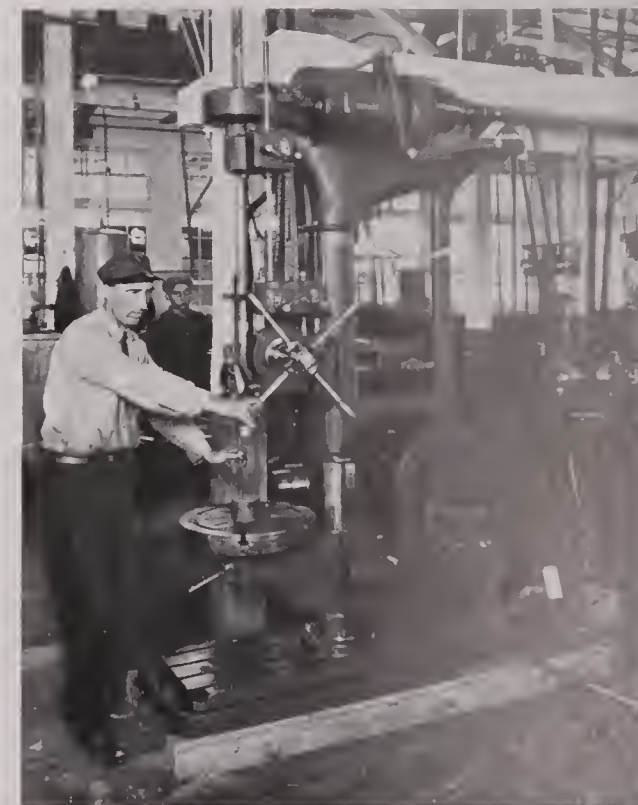

WEIGEL 20-INCH DRILL PRESS

### Building Indicates Rapid Growth

Saint Cloud has numerous hotels and rooming houses for the accommodation of the public, but owing to the rapid growth of the city it became necessary to increase the housing facilities as rapidly as possible. With this object in view three house building concerns were organized and hundreds of houses have been erected during the recent months. Another company composed of substantial business men was organized to build apartment houses. One of these was soon completed and there were 70 applicants for its 40 apartments. A second apartment building is planned and will soon be a reality, but extensive building operations along this line of course have been somewhat curtailed by war conditions. This is also true of the hotel situation, for had it not been for the war Saint Cloud would now have one, possibly two, new modern hostelries in addition to those already here. But these improvements will be coming along shortly and when they are completed they will be modern and up-to-the-minute in every respect.



SHOWING TEMPERING OVEN AND OTHER EQUIPMENT

FOR FORGING OF SMALL PARTS AND TOOLS

THE ENGINEERING DEPARTMENT'S BLACKSMITH SHOP

### Loyalty of Citizens

If there is a city on the map that is loyal it is Saint Cloud. As an evidence of this it is only necessary to call attention to the fact that every war movement, every Red Cross drive, every Liberty Loan or Thrift Stamp drive, in fact all war requirements were boosted over the top while many other localities were getting ready. On one occasion Saint Cloud's Red Cross quota was subscribed in an hour. At another time the citizens here purchased 50 per cent more than their quota of Liberty Bonds in three hours. Saint Cloud adopted the war chest plan while others were talking about it and subscribed and pledged its full share towards relief work throughout the duration of the war. Loyal? Where is a city more loyal? Where could you find better citizenship or more practical, genuine patriotism? Is there a better city to live in or a better people to be among than those who stand by their flag and respond promptly and whole-heartedly to the demands of their government?



THE BOILER ROOM AND PUMP STATION



THIS PUMP SUPPLIES PURE WATER FROM DEEP WELL

According to a recent report sent out from Washington Saint Cloud is the second war garden city in the country. The number of gardens given in the report was 2,500 for a population of 16,000. According to the commissioner's records, 2,285,000 home food products gardens were planted this year in the United States. The number given for the city of Saint Cloud does not cover the entire acreage planted by the citizens, as many residents have lake homes nearby where they raised a considerable supply of vegetables that were not listed in the war garden census.

### Modern City Government

Some six years ago Saint Cloud adopted the Commission form of government and has benefited greatly by the change. Expenditures have been reduced, better fire protection and water supply provided, the white way method of street lighting adopted, streets paved and others repaved with better material,

Continued on page 51





FACTORY BUILDING NUMBER TWO—MAIN PRODUCTION UNIT AND THE EXPERIMENTAL BUILDING

This colored view made from an actual photograph gives some idea of the great size and permanent character of the Main Factory Unit





VIEW OF MAIN PRODUCTION UNIT FROM POWER HOUSE

Showing part of Saint Cloud, Great Northern R. R., Experimental Engineering building, side track, warehouse and loading platform on right, on the left part of Pan Town may be seen.

Saint Cloud—Home of the Pan—Continued from page 45

an auto street sprinkler purchased and various other improvements have been secured. The business of the city is now transacted from a handsome new building recently completed, which gives ample space for all departments. The municipal government is under the charge of three commissioners, elected at large; a mayor who has charge of the Department of Public Affairs and Safety, an acting mayor who is at the head of the Department of Finances and Accounts and a commissioner of Streets and Public Improvements. In addition to the usual city officials there is a Library Board, Board of Health, Board of Public Charities and a Park Board. The assessed valuation of Saint Cloud in 1917 was more than four million two hundred thousand dollars.

Continued on page 56



LOOKING DOWN THE MAIN ASSEMBLY LINE IN FACTORY BUILDING NUMBER TWO

Here you see the Model 250, "Queen of the Highway" in various stages of assembly—from the point where work begins on the frame to the final stage when the car is driven off under its own power.





# ASSEMBLING MODEL 250

**T**HE assembling of a motor car is always an interesting sight whether the assembly is made from parts manufactured by the company, as the future Pan car will be, or from parts furnished by individual manufacturers, specialists in their line. In either event, the assembling process is necessary. It might be well to add that only a small percentage of the automobile manufacturers make their own parts, particularly in the early years of their history.

Although the assembling of the Model "250" Pan is done in a systematic manner, attention is called to the fact that when intensive production begins on the new model, or 1919 Pan, a much more efficient assembling system comprising the latest type of progressive or conveying machinery will be installed, and each worker will have his individual operations to perform. In confining the production



OPERATION NO. 1  
Assembling Model 250

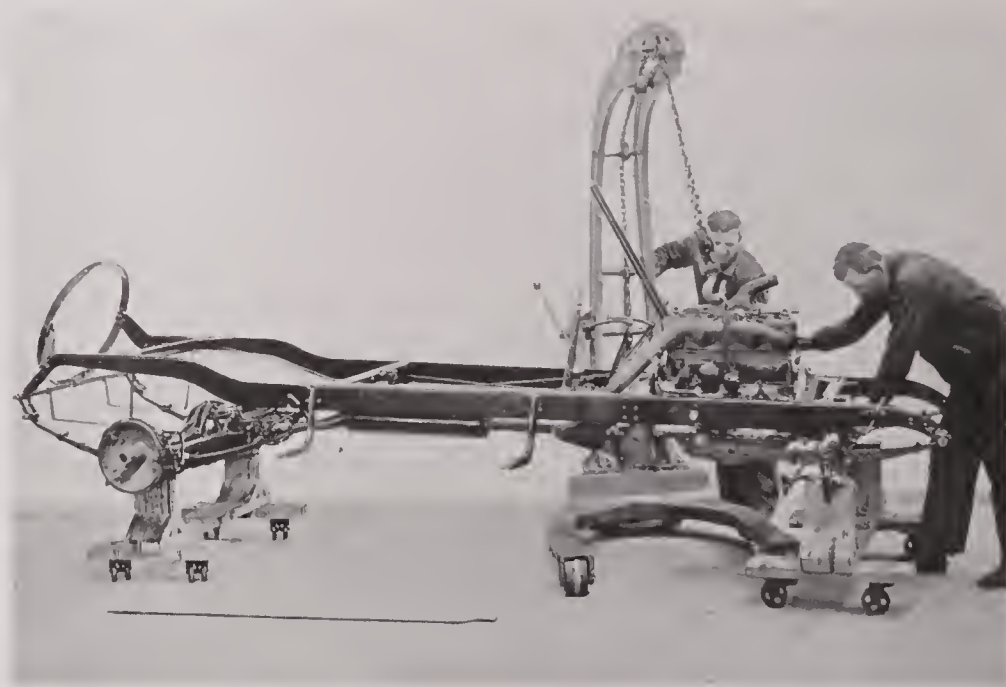

OPERATION NO. 2  
Assembling Model 250



OPERATION NO. 3  
Assembling Model 250



OPERATION NO. 1  
Assembling Model 250

of the Model "250" to a few hundred cars, it is apparent that it would not be good business to install such a system for the assembling process as would be needed later on when the 1919 car is put into production, as practically an entire new system of conveying machinery would have to be built.

Photographs showing the twelve distinct steps of the main assembly in the production of the Model "250" are reproduced here.

Operation 1 starts with the frame and the rear and front axles to which the springs, which already have been assembled in the Sub-Assembly, are attached. The tire carriers, brackets and various other frame members have already been put together in what is known as the Sub-Assembly.

The Motor is dropped into place in Operation 2, and the brakes and drive shaft are connected up. The transmission, clutch, generator, starter and carburetor have already been assembled and attached to the motor in the Sub-Assembly.

In Operation 3, sod pans are attached and the grease cups and differential are filled with grease.

Dust shields, running boards, hood sills, radiator shield and the left and right front fenders are attached in Operation 4.



OPERATION NO. 5  
Assembling Model 250



OPERATION NO. 6  
Assembling Model 250

The next operation, No. 5, comprises the hanging of the Combination Compartment Tank in the rear, attaching the body, putting in the steering wheel and fitting the floor boards.

At Station 6, the spark and gas control system is put in place and at Station 7, the rear fenders are attached.

Front and rear wheels are put on at Station 8 and all are "trued up."

In Operation 9, the radiator is attached and the leather lacings are inserted. The hood and wind shield are attached as are also the tail and head lights.

Upholstering, putting on the top and trimming the body are the operations at Station 10.

In the next Operation, No. 11, the battery boxes are attached, storage battery placed and starter, switches and lights are connected up.

In the final Operation at Station No. 12, the car receives its supply of gas and water and is turned over to the inspectors who run it off the assembly line under its own power.

The car is then subjected to a rigid inspection and test and if it proves up to the high standard set by the chief inspector, it is christened "Queen of the Highway" and is ready for delivery.

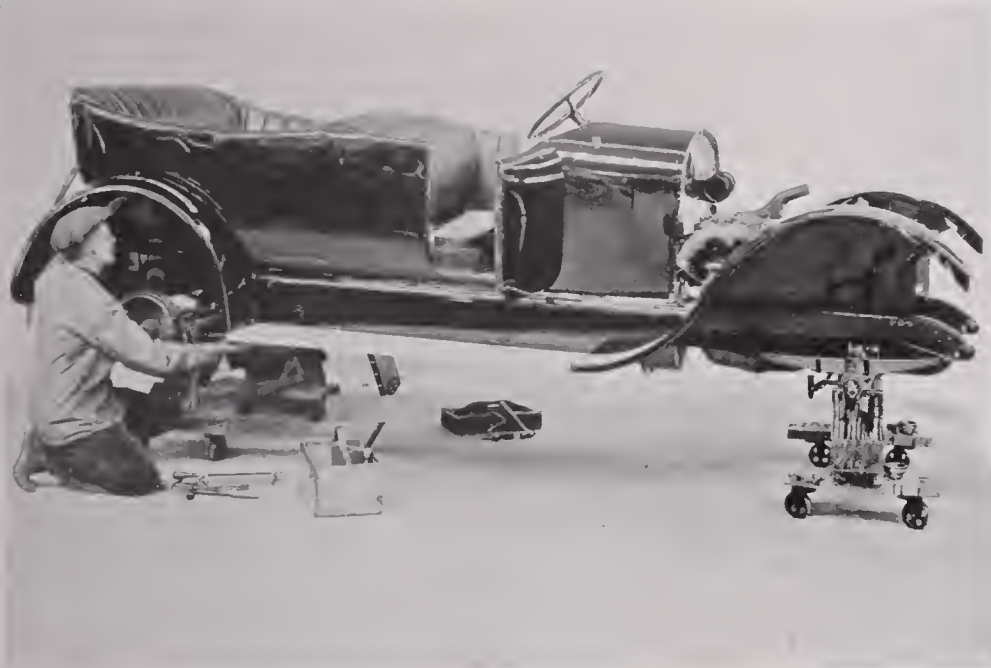

OPERATION NO. 7  
Assembling Model 250



OPERATION NO. 8  
Assembling Model 250

Saint Cloud—Home of the Pan—Continued from page 51

Saint Cloud has a well-equipped fire department and good fire protection. The department includes nine men and a chief. The equipment consists of a hose cart; hose wagon; an American La France fire auto truck, which is a combination chemical ladder and hose truck of the most modern type, with a 70-horse power motor; a 75-horse power triple combination pumper; a city service truck fully equipped; chemical hand fire extinguishers; 8,000 feet of hose and other apparatus. The city has a Gamewell fire alarm system, 18 alarm stations and a siren whistle at the pumping station, where electric pumps have been installed. The water supply is owned by the city and the water which is taken from the Mississippi river has been pronounced pure and suitable for domestic purposes by the State Board of Health.

The street car service is exceptionally good. The system is locally owned, is well managed and does a paying business. The company has approximately ten miles of track, connecting the business section with the southern outskirts, the Great Northern Railway station, the Great Northern shops at Waite Park and with the town of Sauk Rapids. The equipment is modern, the majority of the cars being of steel construction.

Continued on page 58



OPERATION NO. 9  
Assembling Model 250



OPERATION NO. 10  
Assembling Model 250



OPERATION NO. 11  
Assembling Model 250



OPERATION NO. 12  
Assembling Model 250

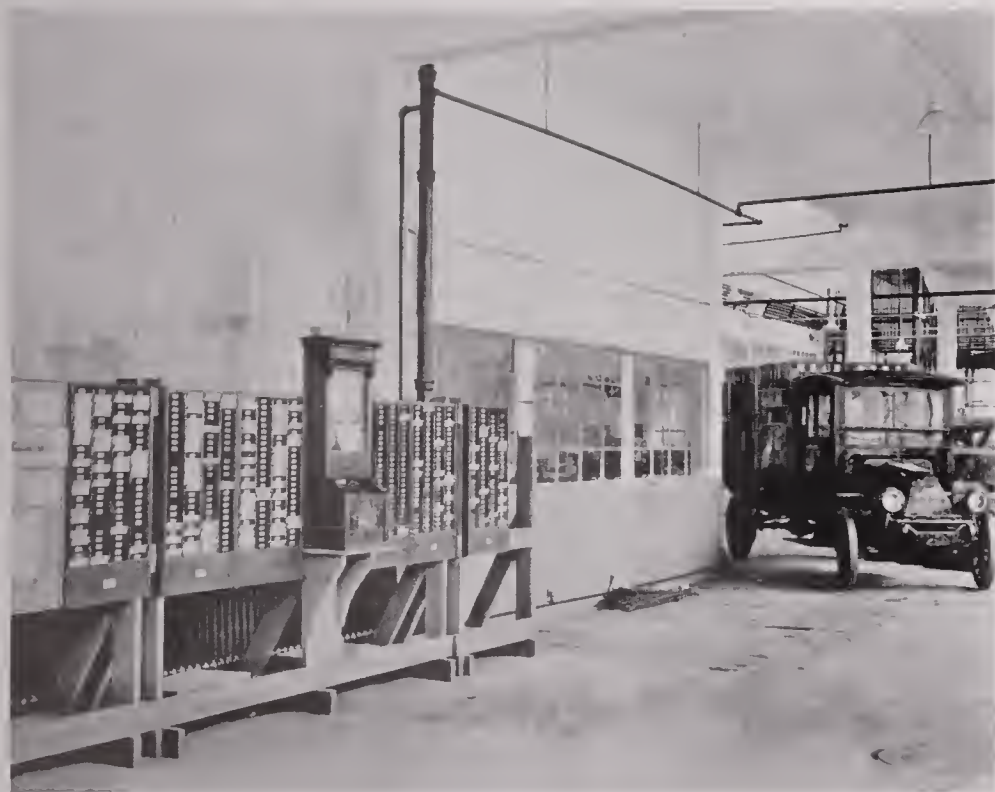

A CORNER OF RECEIVING AND SHIPPING DEPARTMENT



MODEL 250'S IN EARLY STAGE OF ASSEMBLY

St. Cloud—Home of the Pan—Continued from page 56

### Vast Amount of Water Power

A dam across the Mississippi at the southern end of the city supplies vast water power for manufacturing and other purposes. A canal has been constructed on the west side of the river for plant sites and it is the intention to improve the east side in a similar manner. Two plants are now located at the dam, one with four water-wheel units having a total capacity of 3,000 horse power and two steam turbines with a total of 2,345 horse power. The second plant has two water-wheel units with a total capacity of 1,072 horse power. A third plant is located in the business section of the city, with three generators for street lighting service. At this station is also located the gas generating plant, holders and storage tanks. This plant is the property of the Saint Cloud Public Service Company. It supplies lights for the city, furnishes power for a large number of manufacturing plants and gas for cooking pur-



ELECTRIC "JITNEYS" SAVE TIME AND LABOR



CHASSIS READY FOR FINAL ASSEMBLIES

poses to almost a thousand patrons. In connection with the Union Power Company, an allied concern, it has 202 miles of high tension transmission lines extending to and through 33 towns in Stearns and adjoining counties. Through this connection with the Saint Cloud plant these towns are provided with electric light and power. The same interests control the Sauk Rapids water power, which it is expected will soon be utilized to provide the additional power demanded by the rapid increase of the business and the extension of the service.

The Northwestern Telephone Exchange Company has one of its most important District Headquarters in Saint Cloud, occupying a modern building planned and erected for telephone use exclusively. The rapid growth of the city and community is convincingly demonstrated by the following figures: 1912 this Exchange had 1,412 subscribers, which included 409 telephones used by farmers. Since that date the number of subscribers in Saint Cloud has increased to 2,742, including 595 farm telephones. In 1912 there were 13 operators handling an average of 273,700 calls per month. The increased demand

Continued on page 62



BATTERY TESTING AND CHARGING DEPARTMENT

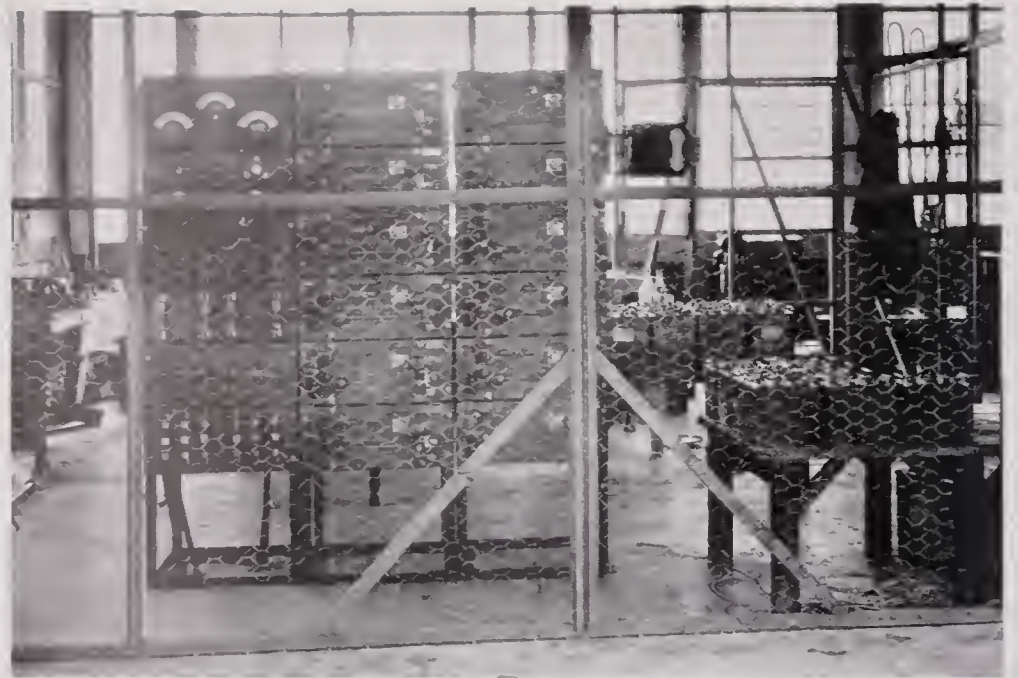

BATTERY CHARGING APPARATUS



TWO VIEWS OF STORE ROOMS IN ELECTRICAL DEPARTMENT





TWO VIEWS OF THE MAIN STOCK ROOM



A CORNER IN THE MAIN STOCK ROOM



CORNER OF WORKS DEPARTMENT STORE ROOM



MODEL 250 PANS READY FOR DELIVERY



WORKS ENTRANCE TO FACTORY

Saint Cloud—Home of the Pan—Continued from page 59

for service now calls for 32 operators, handling 495,500 calls per month. In 1912 there were 20 employees on the payroll; today there are 65. Five years ago this office handled nine counties and twelve exchanges. Today the Saint Cloud district includes 32 counties and 40 exchanges, owned by the Northwestern Company; 160 connecting exchanges owned by independent companies, and over 700 farm-line companies, all connecting with the Northwestern and representing approximately 75,500 telephones. This service requires 17,674 miles of exclusive toll wire; to maintain the lines and equipment 225 people are employed, and 256 operators have all they can do. The telephone building is of recent construction and was erected at a cost of \$165,000. Including equipment the present plant is worth \$250,000. The company has expended considerably over a million dollars during the last five years in extensions and improvements on its properties and will continue to expand as business requirements demand. The telegraph and A. D. T. service supplied by the Western Union is up to standard and all business is disposed of promptly and satisfactorily.



CHASSIS IN SECOND ASSEMBLY STAGES

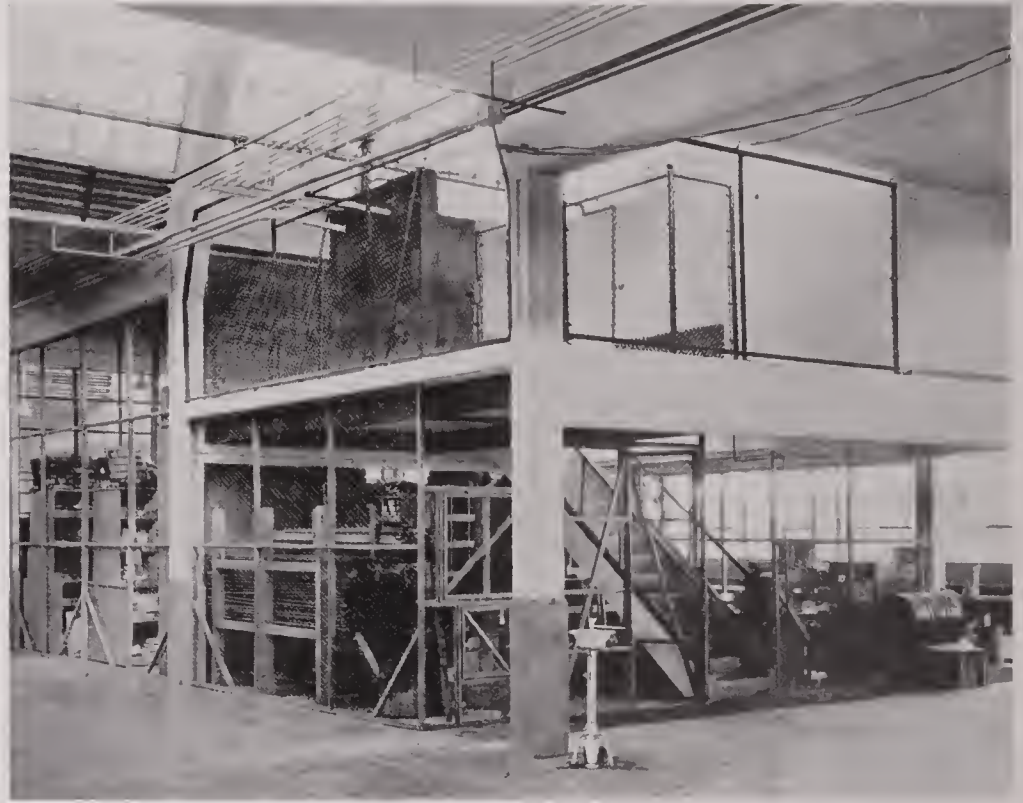

STORE ROOMS LOCATED UNDER BALCONIES

Building material is abundant. Besides four large lumber yards there are three brick yards, where brick of an excellent quality is made. There are also several concerns which do cement work. Two large foundries are able to furnish anything needed in the way of iron or steel for building purposes. They also manufacture machinery and farm implements.

Saint Cloud is noted for its beautiful homes, shade trees and well kept lawns. Its high altitude, wide avenues, cement walks, pure water and healthful climate make it an ideal residence city.

Saint Cloud merchants and business men are wide-awake and progressive. The stores are modern and up-to-date, with handsome window displays, carrying complete stocks of the latest and best merchandise and all lines are fully represented.

The shops of the Great Northern Railway Company are located at Waite Park, just outside the city limits, at the western terminus of the street railway, and constitute one of the largest and most important

Continued on page 68



## PAINTING THE MODEL 250

**W**E GIVE little thought as our automobiles plow through mud and water, run on sandy roads, stand for hours in the sun and rain, how much patient labor and painstaking care must go into the painting of them. If we pay any attention to it at all it is to complain because cold rain turns the varnish green for a few minutes until it dries off.

Painting like every other mechanical process has made great strides ahead in late years. The Pan Motor Company is fully abreast of the times with the latest appliances for spraying paint on their cars, but until quantity production is undertaken these will not be used. When that time comes all but the finishing coats will be laid on in that way.

The model 250 cars now being turned out are all being painted by hand with the exception of the wheels and the interiors of the compartment tanks, which are painted by the spraying apparatus shown in one of the photographs.

First a foundation must be laid just the same as a building. The different coats must be put on in their proper order and under the right conditions or trouble will result.

The room must be heated to from 90 degrees to 120 degrees in order that the paint shall flow freely.

The views taken in the paint shop all show this—a solid bank of radiation the whole length of the outside walls and under the windows in the skylights.

To start with, all paint and grease is first cleaned off the bodies with a sand blast and the bare clean metal is exposed. All rough surfaces are rubbed smooth. Then a metal primer is laid on to securely anchor the successive coats to the metal. After that comes the lead coat followed by putty glazing. Four coats of what is known as “rough stuff” follow, one each day and it can then be said that the foundation is laid with the job ready for finishing.

The next is one of the most laborious parts of the whole process—the rubbing of the whole job with lump pumice stone and water to get a smooth glassy surface. The stock joke of the painters who do this is that it “takes a strong back and a weak mind.”



VIEWS OF THE PAINT SHOPS IN MAIN UNIT

That is not true—it takes a strong back all right but it is a particular, painstaking job. The final appearance can be made or marred by the degree of thoroughness with which this work is done.

When the surface has been rubbed to the proper surface, the first coat of color is put on. This dries twelve hours and the glass coat is laid on which is allowed to dry twenty-four hours.

It looks fairly well now to the layman—much better than when you ran the old fliver out behind the barn last spring and painted her up with a can of ready mixed—but it is far from finished.

The color varnish comes next and then after thirty-six hours of drying is rubbed with felt, pulverized pumice and water. The object of this rubbing is to remove all brush marks bringing it down to an absolute “flat” surface. All varnish coats are put on by hand to get perfect work. The rubbing varnish goes on after this and is dried forty eight hours.

It is rubbed for finish next and the last coat, the finishing varnish, is “flowed” on.

First and last we have gone through with twenty-three distinct and separate operations, and eleven coats of paint and varnish are on the car.



PAINT SUPERINTENDENT'S DEPARTMENT



FACTORY SERVICE DEPARTMENT

The time taken to run a car through the paint shop is eighteen days—not much like a coat of quick drying buggy paint on the old fliver one day and running it the next. This time will of course be considerably shortened when intensive production begins under the spray system. This equipment is already bought and is ready to install. It is to be of the most modern type and will also comprise a battery of enameling ovens in which the cars will pass through in a continuous stream during the enameling process.

No class of workmen are more particular about their tools and surroundings than painters. They have to be in order to do good work. Absolutely no dust can be permitted and brushes must be the best and in perfect condition.

They do not exactly encourage sight seeing because of the criminal propensity of all mankind to exercise a testing finger to “see if it is dry.”

Do this once, and forever after you are banished from the inner holy of holies where the painters hold forth, unless your hands are tied behind you.

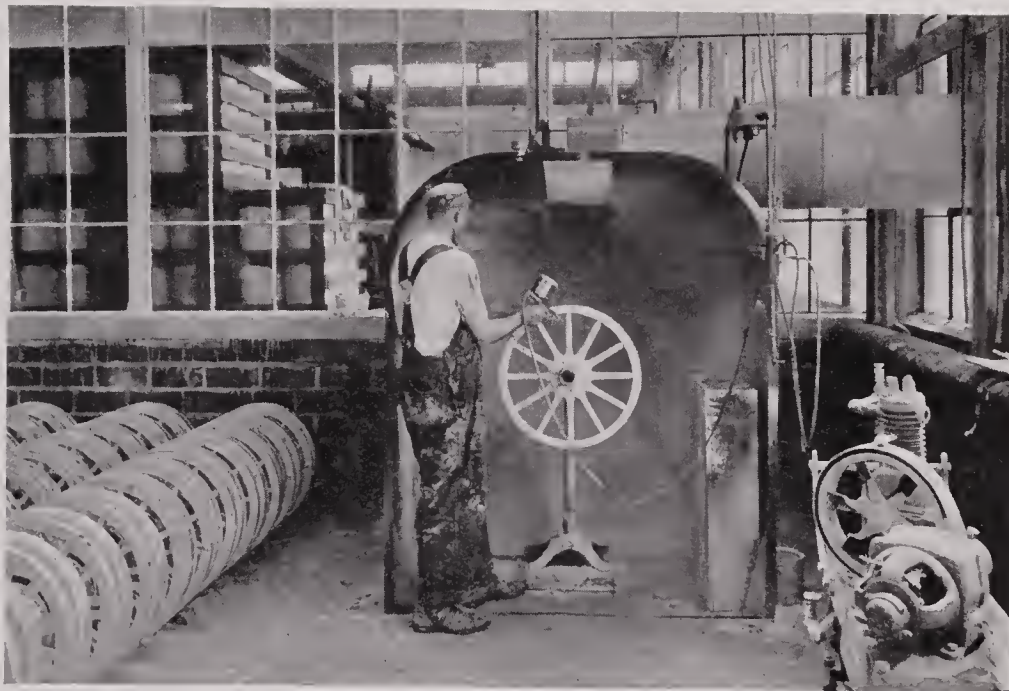

THE MODERN WHEEL PAINTER

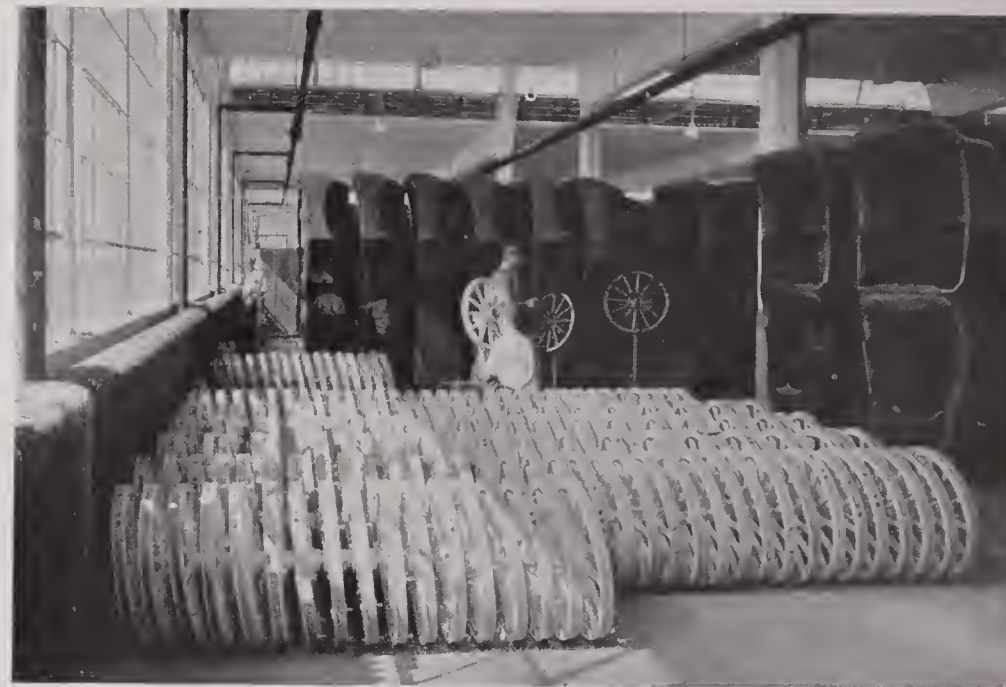

STRIPING WHEELS

VIEWS TAKEN IN THE PAINT SHOPS



PUTTING ON THE FIRST COAT



BODIES IN VARIOUS STAGES OF PAINTING

96.



LOOKING DOWN THE MAIN AISLE

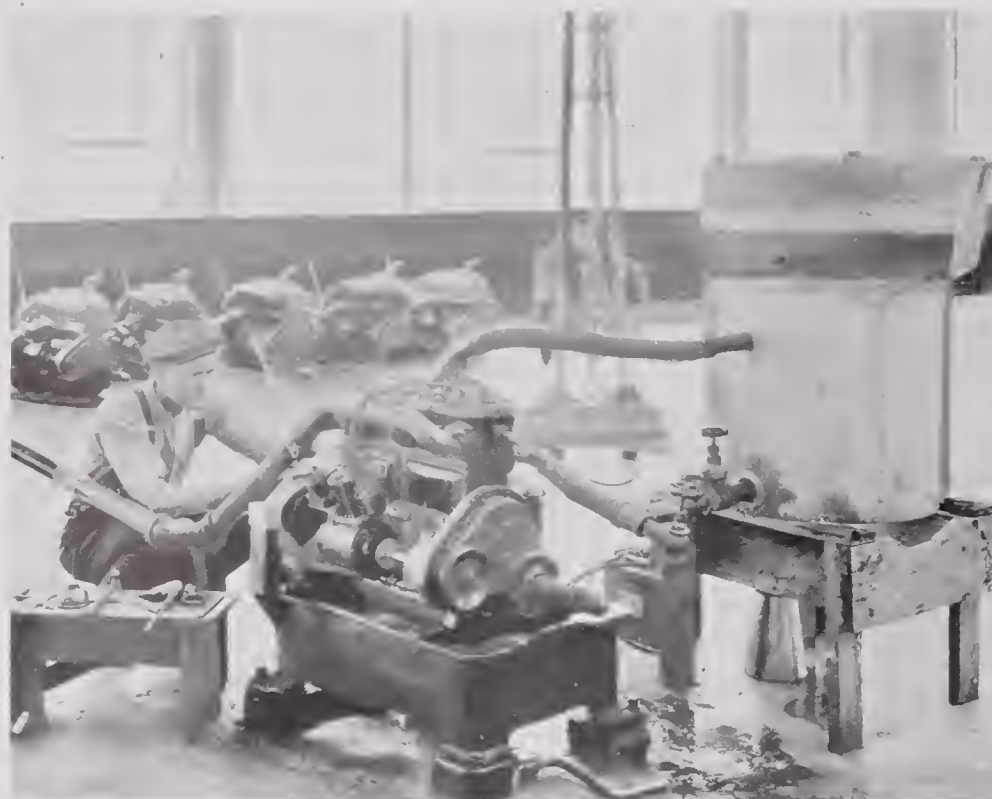

BLOCK-TESTING MODEL 250 MOTORS

Saint Cloud—Home of the Pan—Continued from page 63

industrial institutions in this section of the state. These shops occupy a number of large and substantial buildings, equipped to do both construction and repair work, and give employment to over one thousand men. An average of 71 cars per day are being turned out. The yards contain large quantities of supplies for distribution to different points along the main line and its branches as they are needed. It is expected that the plant, already large, will be further augmented at an early date, as more building space, more equipment and larger facilities generally are needed to handle the business and meet the demands of a constantly growing traffic.

#### Commercial And Manufacturing Interests of First Rank

Outside of the Twin Cities and Duluth Saint Cloud ranks first in the state as a manufacturing and commercial center. While this has been true for many years it is emphatically so today, for it is doubtful if another city in the entire country has experienced such phenomenal growth and development in the recent past. Of course this is not accidental. There is a reason for this expansion. In fact



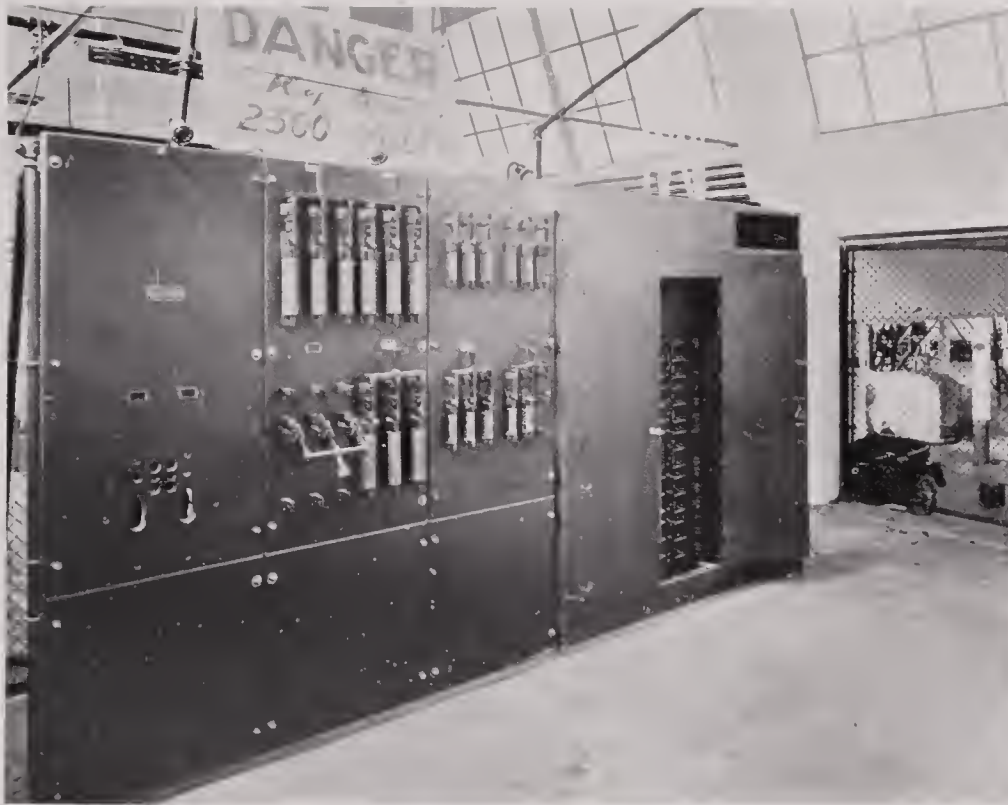

SWITCHBOARDS LOCATED ON BALCONIES



CARS READY FOR FINAL INSPECTION

there are many reasons, and all good ones, why Saint Cloud should be not only the leading manufacturing and industrial center of the state, but one of the foremost commercial cities of the nation. It has the location and almost innumerable natural advantages. It has unusual railroad facilities, making it a logical distributing center for a vast territory. It is the county seat of Stearns county, the fourth county in the state in both wealth and population, and the largest county in the southern half of the state, having an area of 851,246 acres of which only 37,000 acres are water. The incorporated limits of the city embrace parts of Stearns, Benton, and Sherburne counties, the major portion being in Stearns county.

The country tributary to Saint Cloud is settled by the most thrifty and practical farmers in the world and this has naturally developed into one of the greatest producing districts in the state and nation. It is only reasonable, therefore, that the city should experience rapid growth along manufacturing and industrial lines. In the center of a giant hardwood timber belt, with vast supplies of building stone of the highest quality, at the door of the greatest iron mines in the United States, with cheap



A CORNER OF THE UPHOLSTERING SECTION



CONCRETE FLOORS PAINTED TO PREVENT DUST

transportation on river and lakes, with practically unlimited water power, with plenty of skilled labor in all lines, with ideal living conditions and with a population that is fully alive to the situation, is it any wonder that Saint Cloud is forging to the front? Indeed, would it not be remarkable if such resources and such advantages were allowed to remain undeveloped and unemployed by a wide-awake, aggressive people in these strenuous days when every demand for them is being made not only by the country in which they are located, but by all the leading nations of the earth?

The Census of Manufacturers, as issued by the Department of Commerce of the United States—the latest issue—gives some very interesting figures and proves beyond question that Saint Cloud not only has grown rapidly, but will continue to grow until it takes rank among the busiest cities in the country. In 1914 there were seventy-seven different manufacturing establishments in the city, employing 1,429 wage-earners, the value of whose output was \$4,102,969. The industries represented included granite sheds, flour mills, foundries, machine shops, wood-working factories, cement works, printing establishments, tobacco manufacturers, bakeries, wagon and sled factories, and many others. The per-

Continued on page 72



### Horse Races

Question: Who will win the war between America ruled by free men and Germany ruled by "Prussianism"?

Answer: The winning nation will be the one who can produce the most food, shoes, automobiles and other goods.

The German people are being kept in ignorance by the Kaiser's propaganda. They are being misled by the Kaiser's agents who are trying to get them to believe that Germany is the only nation that can win the war.

The American people must be kept informed of the truth. They must know that Germany is not the only nation that can win the war.

The U. S. Department of Labor is working to keep the American people informed of the truth. They are trying to get the American people to know that Germany is not the only nation that can win the war.

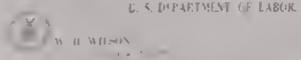

### BEWARE

### GERMAN TRAPS

### GERMAN TROUBLE MAKERS

Do not let Germany even attempt over here what she did in Russia.

When we win the war, we can settle our other disputes. If we shouldn't win the war, the Kaiser would settle them for us.

U. S. DEPARTMENT OF LABOR.

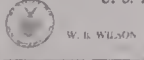

### WHY

does drifting from job to job give comfort to the Kaiser?

### BECAUSE

idle machines reduce production and weaken our Army.

### WHY

does Uncle Sam need you on the job?

### BECAUSE

the fighters for freedom must be armed and fed and clothed.

A chain is only as strong as its weakest link. You are a link in the chain of production. If you do not stay on the job you weaken the chain.

### STICK TO YOUR JOB

until the U. S. Employment Service tells you to change.

U. S. DEPARTMENT OF LABOR.

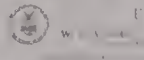

### Our Children!

The Kaiser's agents are trying to get our children to believe that Germany is the only nation that can win the war.

The Kaiser's agents are trying to get our children to believe that Germany is the only nation that can win the war.

The Kaiser's agents are trying to get our children to believe that Germany is the only nation that can win the war.

The Kaiser's agents are trying to get our children to believe that Germany is the only nation that can win the war.



### SINCE THE BEGINNING

### OF THE WORLD

Classes and peoples have won power as they have proved themselves to be necessary for the defense of the State.

Those of us who do the most toward winning this war will receive the most benefits after the war is over.

U. S. DEPARTMENT OF LABOR.

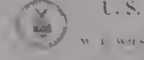

### GERMANY'S STRENGTH.

Germany's strength is the willingness of her military caste to sacrifice her people. They see the big prize - the chance to rule the world - and they are willing to pay the price in German suffering.

To hold democracy the right to rule ourselves and to be free men - our people must of their own free will pay even a bigger price and make even a greater sacrifice.

We must rise above thinking too much of profits or wages. We should be ashamed of that money we are getting just because of the war.

When our Sammys return they will ask us only one question:

What did you do to help win the war?

U. S. DEPARTMENT OF LABOR.



### LET US REMEMBER RUSSIA!

The Russians meant well. But they took time to talk while the house was burning!

Of course the Kaiser encouraged them.

He knew that would be the easiest way to lick them!

WE MUST NOT LET HIM PLAY THE SAME TRICK ON US.

U. S. DEPARTMENT OF LABOR.

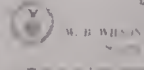

### GET THE HABIT OF DOING THINGS RIGHT

THIS WILL MEAN:

- Greater Production
- Less Waste
- Increased Earnings

### HELP WIN THE WAR QUICKLY

U. S. DEPARTMENT OF LABOR.



### OUR CHANCE

He lives best who serves his fellows best.

This war is our chance, not to GET more, but to DO more.

The group which does the most toward winning the war will have the greatest influence after the war is over.

U. S. DEPARTMENT OF LABOR.

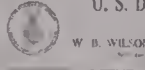

### BOOT STRAPS

We don't try to pull ourselves up by our boot straps - do we? Then why try to get richer by producing less?

However much we may want better ways of distribution, we must first have Greater Production in order to win this war.

By the further development of those qualities of enterprise, initiative, originality, and hustle, characteristic of the American people, labor can earn an additional debt of gratitude from our country.

U. S. DEPARTMENT OF LABOR.

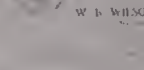

ONE OF THE FACTORY BULLETIN BOARDS

Posters furnished by the U. S. Department of Labor are posted in conspicuous places throughout plant so that the worker is constantly reminded of the need of giving his best efforts at all times.



HOT WATER FOR LAVATORIES



FACTORY FILLING STATION



SANITARY DRINKING FOUNTAINS

Saint Cloud—Home of the Pan—Continued from page 70

centage of increase in the number of wage-earners during the period from 1910 to 1911 was 128.3, more than three times that of St. Paul and Duluth, more than four times that of Minneapolis, more than twenty times that of Winona and more than thirty times that of Mankato. Now, it is a well known fact that the years since 1914 have been the most prosperous in the history of Saint Cloud. Consequently the intelligent reader can readily appreciate the significance of more recent figures, were they available, and realize what an eloquent and convincing story they would tell.

### The Granite Industry

Saint Cloud is widely known as "The Granite City." The immense beds of granite deposits in the immediate vicinity constitute its greatest source of wealth and form the basis of its leading industry. The beds are easily worked and the supply is practically inexhaustible. The stone is adapted to a wide range of uses, is of a fine texture, with 27 varieties of color, from deep, dark grey to deep red and from black to white. When polished it is unsurpassed by any granite in the world. There is the light, medium



BATTERY CHARGING GENERATOR



NATIONAL COUNTING SCALE



PORTABLE AIR COMPRESSOR

and very deep red, resembling in color the Scotch granite and Tennessee marble; grey, light, mottled and deep; other shades so dark as to be almost black. The predominating colors, however, are dark red, grey, black, pink and blue—all fine texture and all susceptible to the highest polish. It is used extensively for monuments, building purposes, cut to measure, hammered or rough-faced. It has been used effectively in the seam-faced rubble, with dressed trimmings; for columns, pillars, steps, sills, curbing, paving blocks, piers, retaining walls, and so on. The crushed granite cannot be excelled for paving and road-making. Carloads of monuments and granite in other forms are shipped daily from Saint Cloud to both near and distant points throughout the country. Many of the fine buildings seen in the great cities are constructed of Saint Cloud granite. The vast superiority of the stone brings wider recognition and a constantly increasing demand. This is unquestionably one of the big, permanent industries of Saint Cloud. More than forty quarries are now in operation and new plants are being organized and equipped in considerable numbers each year.

Continued on page 76

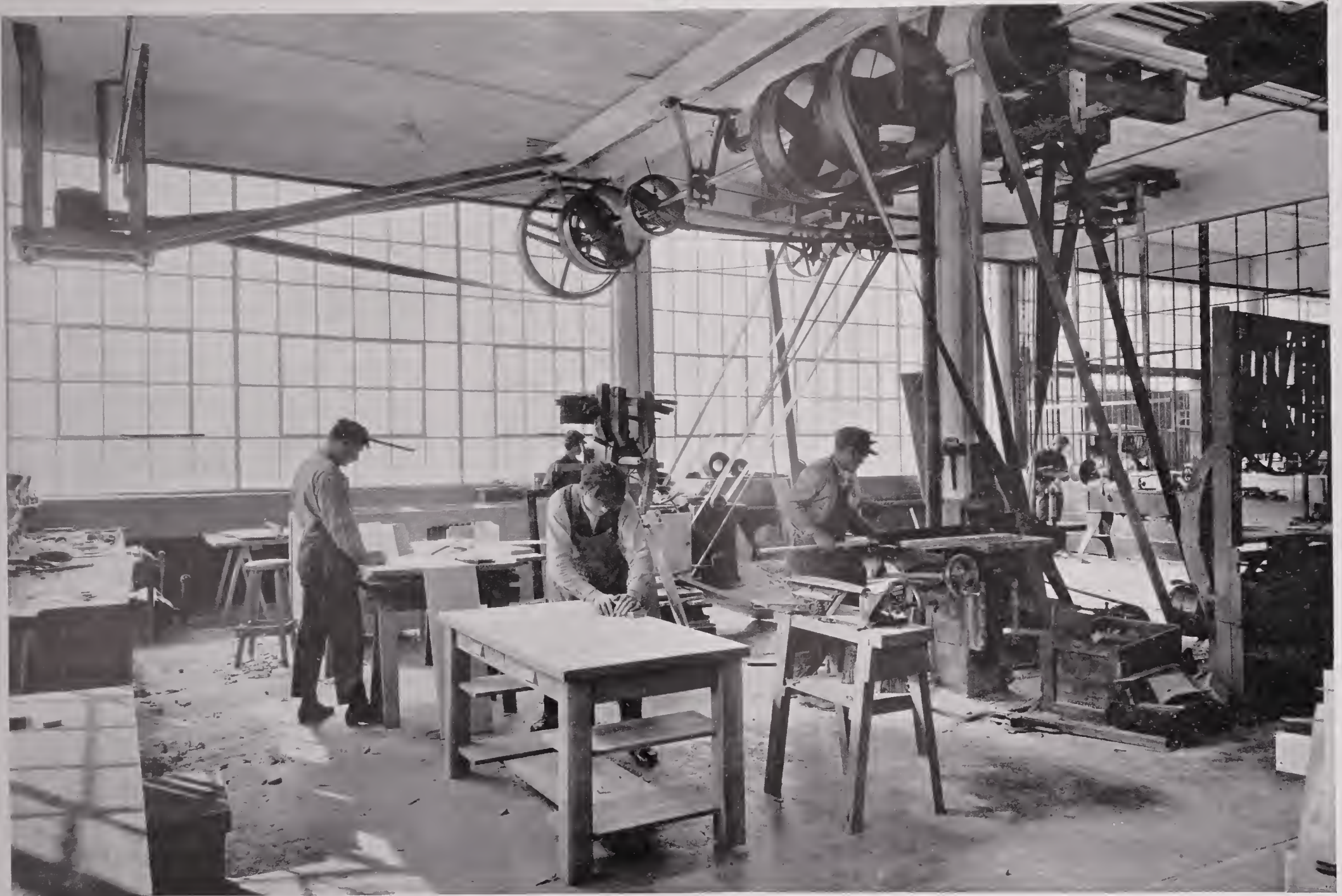

### THE WOODWORKING AND PATTERN SHOP

This department is located in Factory Building Number Two and is well equipped to turn out the many wood patterns necessary in the development of a machine—all cabinet work is also done here.



VIEWS OF THE PATTERN SHOP IN MAIN FACTORY

**A** WELL equipped pattern shop is one of the first things needed in a plant such as the Pan Motor Company. Almost every step in their development calls for patterns and templates of all kinds.

The experimental shop must of course have practically the whole of every new model made up in wood, not only in order to make any castings that may be required of iron, steel or bronze, but for the purpose of inspecting the appearance of various parts and judging how they will look when the car is completed.

It can very well be imagined that this is a task that will test the powers of even the most skilled worker in wood. There are no "wood-butchers" or "cracker-barrel whittlers" here—no one can do such work as is required of the pattern-maker but the expert wood worker, who must be as much an artist as the sculptor or painter. Modern machinery and equipment back of these artists are necessary to get such work out in good shape so no expense has been spared to supply it.

Passing on through the works the traces of the pattern maker's hand are seen everywhere. In the mill work it is special brackets and hangers for the shafting—in the power house it is the pipe supports and hangers and other special castings for the construction of the boilers.

The forge shop has also drawn heavily on the pattern making department, as, for instance, the outside casings or shells of the ovens for heat treating were first made in the pattern shop and cast in a local foundry.



GREENLEE UNIVERSAL SAW TABLE



CRESCENT 36-INCH BAND SAW

Saint Cloud—Home of the Pan—Continued from page 73

Over a thousand men find profitable employment in this business. As the quarrying cost of granite is comparatively slight, the expense of the finished product is to be charged mainly to labor, and as much of this is skilled, the monthly pay roll at the quarries is a big item and means much to the local merchants and business men.

Some idea of the growth of this industry may be gained from the following comparative statement:

1913—No. men employed,	750;	value of production,	\$1,009,338.
1914—No. men employed,	773;	value of production,	\$1,015,415.
1915—No. men employed,	880;	value of production,	\$1,101,220.
1916—No. men employed,	1030;	value of production,	\$1,303,560.

During this three year period the number of men employed increased 280, or over one-third, and the value of production \$294,222, or almost thirty per cent. The increase the present year will run above the average. It is safe to say that the value of the output at the present time is considerably over \$2,000,000 annually.





YATES 21-INCH-3-KNIFE SURFACER



YATES 16-INCH JOINTER



TOLEDO AUTOMATIC SCALE

### Banks Show Healthy Condition

The banks are the real pulse of any city. They tell the financial story in cold figures and every figure has a meaning. The dollar today is more important than ever before in the world's history, not because it has greater value, but because the people have learned how to use it, how to make it work, how to make it do things it has never done before. Dollars were effective in winning the war. Therefore, the city that is well blessed with dollars is well on the road to victory and a realization of its most cherished hopes. Nothing can stop the dollar, if it is well managed.

Saint Cloud has the money and the brains to use it to the best advantage. There are six banks doing business in the city. Two of these, the First National and the Merchants National, hold federal charters and four, the Zapp State Bank, Security State Bank, Farmers State Bank and Saint Cloud State Bank, are operating under the Minnesota state banking laws.

Continued on page 79



TOILETS LOCATED ON BALCONIES  
Conveniently Accessible But "Out of the Way"



SECTION OF LAVATORIES AND LOCKER ROOM  
Every Employee Has His Individual Locker



SANITATION IS PARAMOUNT  
Every Health Precaution Is Taken



"CLEANLINESS NEXT TO GODLINESS"  
No Unnecessary Waiting to "Wash Up"



VIEW OF MAIN PRODUCTION UNIT FROM WEST SIDE

Space for future expansion has been provided for; Additional units will be added on this side of the Main Production Unit, Factory Building No. 2, as the necessity arises.

Saint Cloud—Home of the Pan—Continued from page 77

These banks show a healthy condition and a steady, consistent growth from 1903 to the present year, as indicated by the following figures, which give the total deposits for the city and the county at various times during the period:

Year	Saint Cloud	Stearns County	Year	Saint Cloud	Stearns County
1903.....	\$ 475,300.18.....	\$ 1,152,640.33	1916.....	\$1,223,037.78.....	\$10,947,297.97
1908.....	1,051,837.15.....	2,941,864.00	1917.....	4,891,871.59.....	12,460,428.95
1913.....	3,212,894.40.....	7,669,385.55	1918.....	5,566,173.11.....	14,402,009.90

It will be noted that the fiscal year which closed June 30, 1918, from the standpoint of bank deposits, was the most prosperous in the history of the city and the county, the increase in the city for the year being considerably over one-third of that of the entire county and proving beyond a doubt that Saint Cloud is rapidly becoming a financial center of great importance. It is generally conceded that the splendid gains of the past two years are to a great extent due to the Pan.



WORKS ENTRANCE TO MAIN FACTORY



WINDOWS ARE KEPT BRIGHT

The post office tells the same story about Saint Cloud that is told by the banks, the telephone company and other institutions whose monthly and yearly records furnish reliable information and unmistakable evidence of the steady progress of the city. One of the sure indications of a healthy growth

Continued on page 82

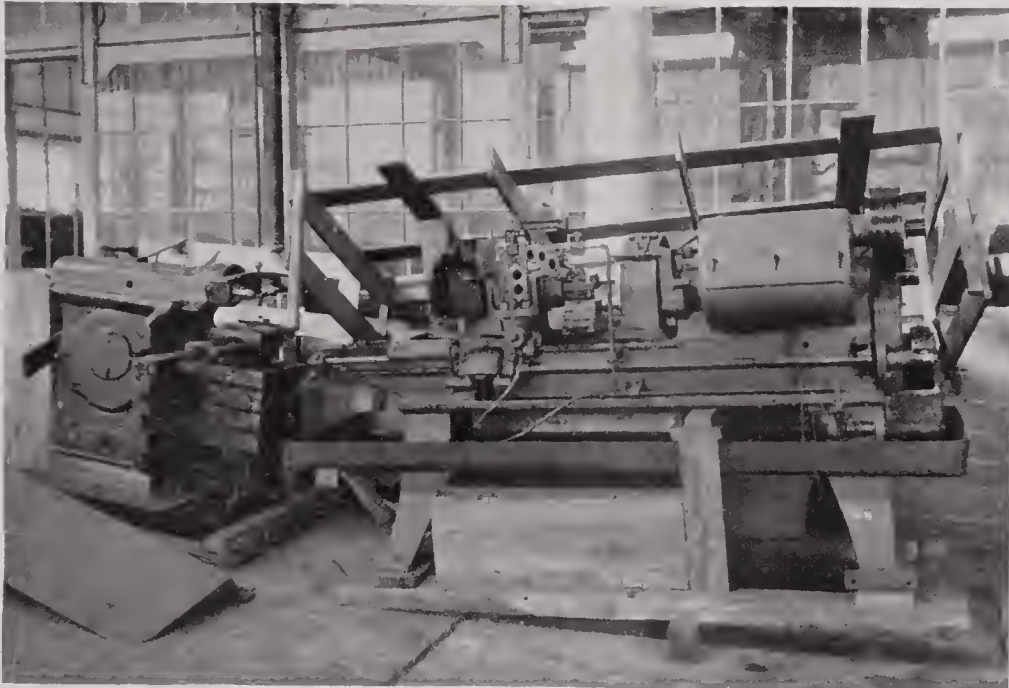

NEW MACHINERY ARRIVES ALMOST DAILY

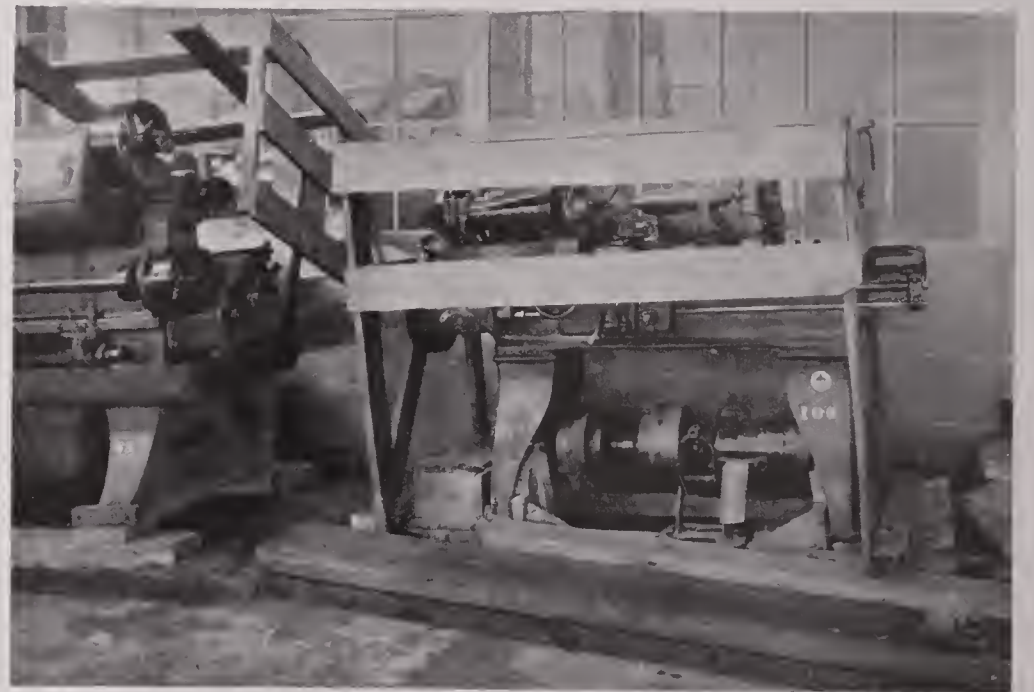
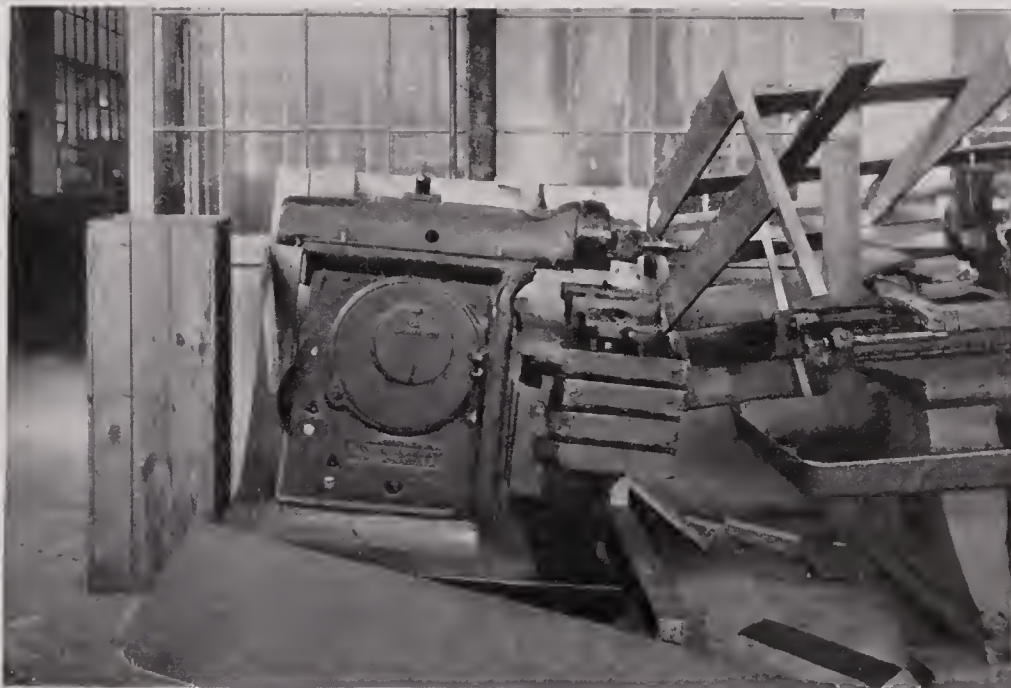

ADDITIONAL MACHINERY READY TO BE UNCRATED AND SET UP



GROUND ENTRANCES ARE GUARDED



STEEL FENCING PROTECTS THE PROPERTY

Saint Cloud—Home of the Pan—Continued from page 80

is to be found in the receipts of the post office. The increase in business and population is indicated as clearly by the following figures as is the time of day by the hands on the clock.

The gross receipts of the Saint Cloud post office from the sale of stamps, stamped envelopes, postal cards, newspaper wrappers, etc., for the several calendar years ending December 31, from 1905 to 1917, are given below and make a splendid showing:

1905.....	\$20,600.66	1908.....	\$27,050.02	1911.....	\$31,794.71	1914.....	\$41,438.75
1906.....	23,595.74	1909.....	28,493.64	1912.....	32,591.87	1915.....	49,172.57
1907.....	24,567.32	1910.....	29,577.45	1913.....	36,677.26	1916.....	52,471.99
		1917.....	\$73,507.56				

For the first six months of the present year, to June 30, 1918, the receipts were \$54,536.79, or \$25,791.92 more than they were for the corresponding period of last year. These figures show a gain of nearly fifty per cent, and in view of the fact that the average increase in post office receipts throughout the country is something like six per cent, this showing is nothing short of remarkable.



THE WORKS ENTRANCE



SHIPPING AND RECEIVING PLATFORM

The post office personnel includes a postmaster, assistant postmaster and superintendent of mails, 13 clerks, 10 city carriers, 2 substitute city carriers, 6 rural carriers, 2 mail messengers, 2 special delivery messengers and other help. The building itself is a handsome and imposing structure, centrally located and when first erected gave ample space for the accommodation of the business, but like many other cities, Saint Cloud has outgrown its post office facilities and steps have been taken which insure an additional building at an early date.

#### Dairies Make Millions

Minnesota, the Father of rivers and Mother of lakes, is also the Bread and Butter state of the nation, with dairying as one of its most important, if not its leading industry. It is doubtful whether within any section of like area a greater number of successful creameries can be found. It is the exceptional community which does not have one or more. Among the ten thousand lakes in the state are nestled 841 creameries, 85 cheese factories and 100 ice cream factories.

Continued on page 98



SOUTHEASTERN CORNER PLANT  
Showing Side Track Entrance



"GUARD POST NO. 1"  
Entrance to Factory Grounds



TWO VIEWS OF THE WORK OF THE MODERN TRENCH DIGGER AND SAPPER





VIEW FROM THE WATER TOWER

Showing the Main Factory, Experimental Building, part of Power Plant, Loading Platform and Warehouse. Part of Saint Cloud proper can be seen in the upper right hand corner and Pan Town in the upper left hand corner.



VIEWS OF WORKS DEPARTMENT WAREHOUSE



THIS BUILDING IS OF A TEMPORARY CHARACTER AND HOUSES CONSTRUCTION MATERIAL



# MAIN POWER PLANT





# DEPENDABLE POWER A FOUNDATION STONE

**M**ANKIND has no record of a time when the possession of mechanical power has not been the deciding factor in the fate of nations. Everything else is subordinate to it. This may be disputed but it is true nevertheless. The recent struggle in Europe resolved itself into a fight for the possession of just two things—coal and iron—power and steel. The hardest fights the world ever saw or ever will see have been over the coal fields of northern France.

The issue may be and is, clouded by a multitude of other things—crowns and dynasties, kings and princes and their petty quarrels but in the last analysis it is power—potential and active. All industry is dominated by this one thing. The possession of dependable power is the foundation stone upon which every industrial enterprise is built. Without it Napoleons of finance are helpless, and captains of industry become privates in the rear rank.

One of the most potent reasons for the location of the Pan Motor Company in Saint Cloud was the magnificent water power development along the Mississippi.

Fully alive to the necessity for uninterrupted service twenty-four hours a day and seven days in the week, the company has made elaborate preparations. A substantial pole line has been set to a point just off the company's property and a transformer station of two thousand horse power capacity has been built, which connects with the Public Service Company lines. From that point on, all wires are underground in the elaborate system of tunnels and galleries. This is good insurance against accident and interruption of service, and loss of life.

Just across the Great Northern Railroad from the transformer station and near the center of the property stands the central power station of the Pan Motor Company. There is nothing more exasperating than the "cussedness" of inanimate things. No matter how skillfully men may build, no matter what precautions they take against trouble—still trouble comes. Transmission lines some-

Continued on page 90



THE BOILER ROOM IN MAIN POWER PLANT

With the completion of the automatic stoker system these boilers will be fed from overhead bins kept filled by a crane and clamshell bucket operating between the coal pile and boilers.

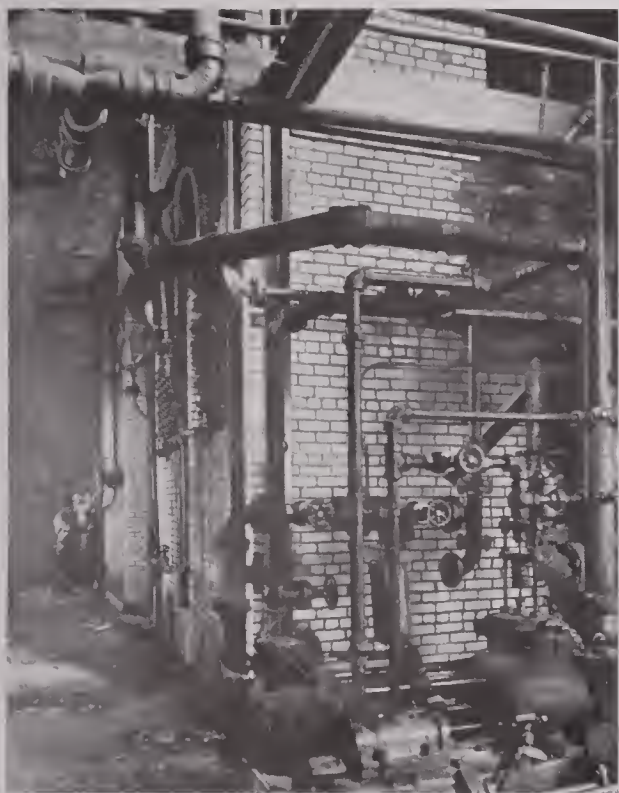

IN THE REAR OF THE BOILERS



TWO 150 H. P. FRANKLIN BOILERS



ALONG SOUTH SIDE BOILER ROOM

Dependable Power a Foundation Stone—Continued from page 88

times blow down, anchor ice clogs water wheels and racks, generators may run for years and then suddenly go up in a burst of flame, and so on ad finitum. When the power stops every machine is silent, and a howl goes up that rattles the windows. Remarks that burn the wires come over the telephone. No matter if it is the first time in a year, they want power—quick!

Then we know why there is a central power station large enough to light a small city in the center of the property. There can be no half-way business about building a power plant. Either it is adequate and dependable or it is not.

The building that houses this vital center of activity is a brick, concrete and steel structure, 106 feet long, 60 feet wide and three stories high. The foundations go down to a solid bottom. Plenty of light is provided all over the building—no dark dirty corners full of oily waste and trash will be permitted. Two Franklin water tube boilers of 150 H. P. each, and one Freeman with 395 H. P. normal



400 H. P. FREEMAN WATER TUBE BOILER



SIMPLEX WATER METER



COOK DEEP WELL PUMP

rating stand in the boiler room. The water is in a network of tubes inside, and the fire passes between them in a zig-zag path, giving up most of its heat before the waste gases finally pass up the tall stacks and are free. The fires are fed by automatic stokers, and an interesting feature of them is that the coal is forced up under the fire and the ashes are raked off the top.

There are two stacks, one 100 feet high, six feet in diameter, the other 80 feet high and three feet six inches in diameter. An engine driven fan, in addition to the natural draft will give the boilers sufficient capacity over their rating to take care of any emergency that is likely to occur.

The operation of the fan and stoker is a fascinating thing to watch. Whenever the steam pressure falls the sensitive governor on the engine of the fan speeds it up. The stokers are mechanically driven and they, too, respond to the same impulse and drive more coal into the fires. As soon as the steam pressure rises, they slow down.

Continued on page 93

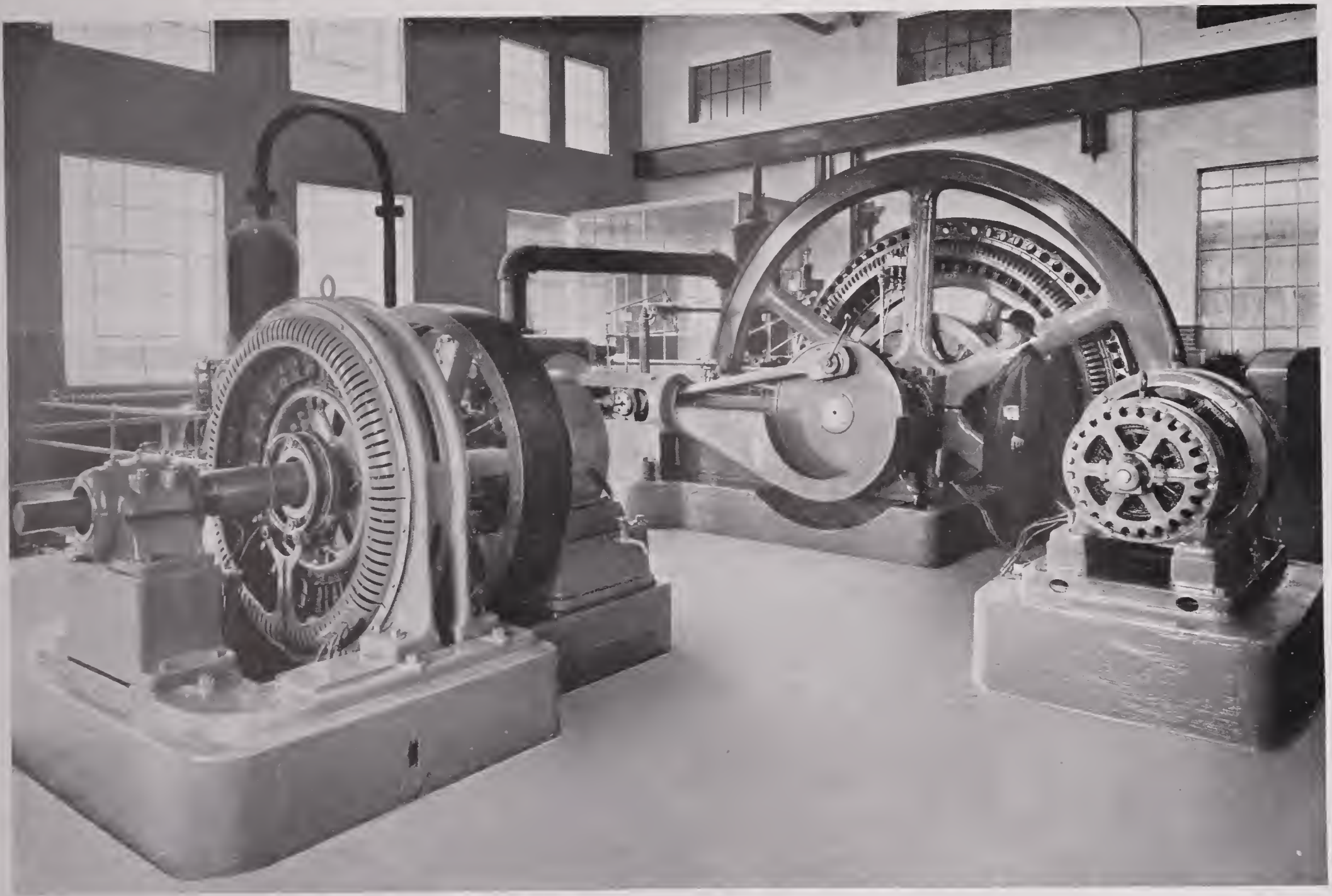

THE ENGINE ROOM IN MAIN POWER AND LIGHT PLANT

Several thousand dollars were saved in the purchase of the Pan power plant equipment through the foresight of the management. It is large enough to take care of the light and power needs of a good sized city.





DRAFTING ROOM AND COMPENSATOR STATION



TOLEDO AUTOMATIC COAL SCALE

Dependable Power a Foundation Stone—Continued from page 91

Water is fed into the boilers by two heavy duty pumps, either one able to supply all three. If the water stands at a proper level in the boilers everything is serene, but if it falls below the deadline set for it, an alarm blows. Nothing else in the world gets quicker action out of a fireman than that alarm whistle. Automatic coal bunkers and ash conveyors will be part of the equipment, so that fuel will be delivered and ashes taken away by the most approved and up-to-date appliances.

Passing on into the engine and dynamo room, one sees the prime movers, one an Allis-Chalmers compound engine driven generator of 175 K. W. capacity (about 235 H. P.) and an Ideal Compound Engine machine of 75 K. W. (or 100 H. P.) rating. These stand on solid foundations and one notices that each one is entirely separate from the floor—that is, the foundations are not connected with the building. This is to prevent a curious thing—when heavy engines run together on the same foundation or are solidly connected they tend to fall “into step” or rotate in unison. Every other vibration seems to fall into step with them and all together they fairly rock the whole building on its foundations eventually destroying both machinery and building.



RHEOSTAT AND TRANSFORMER RACK

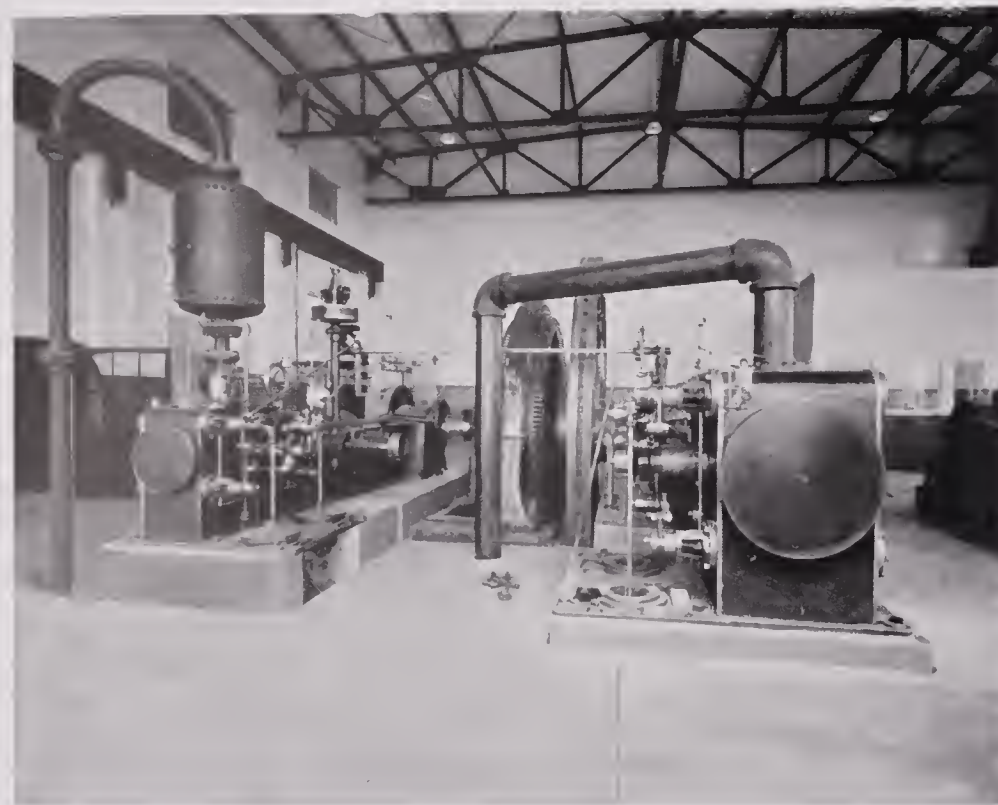

ANOTHER VIEW OF THE ENGINE ROOM

Over in one corner of the big room is the chief operating engineer's office. It will be provided with every appliance to show operating conditions all over the plant. There is an instrument that tells at a glance how much water has been evaporated in a given time. The coal weights are automatically recorded to show how much coal is burned in any given period. The steam flow meters will give the amount of steam used and the recording electric meter will show the output of electric power. Checked one against the other and placed on a chart, comparisons will be made between runs of days, months and years and the slightest lowering of efficient economical operation detected.

In the other corner the switchboard will be found, the vital center of the whole plant. It is of polished marble and somewhat resembles a monument. It is. The words and terms the switchboard operator uses so easily are the most enduring memorials that any man can possibly have. The term "volts" is the imperishable memorial to Volta. "Ampers" perpetuates the name of Ampere. Other terms

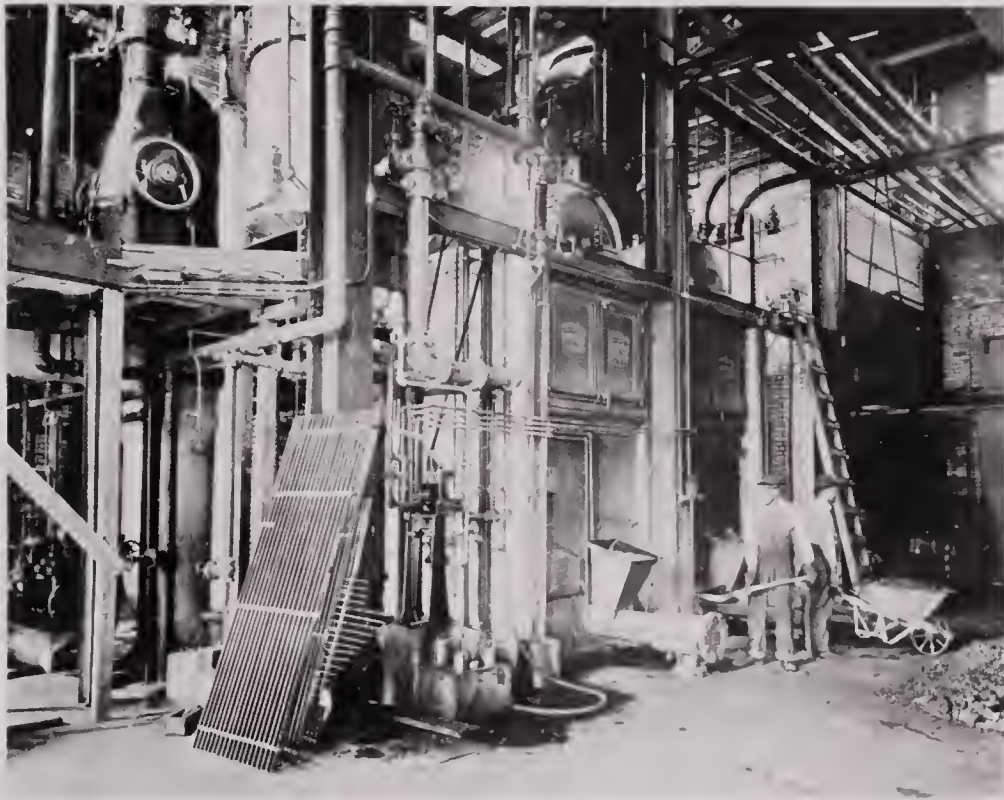

KEEPING THE HOME FIRES BURNING

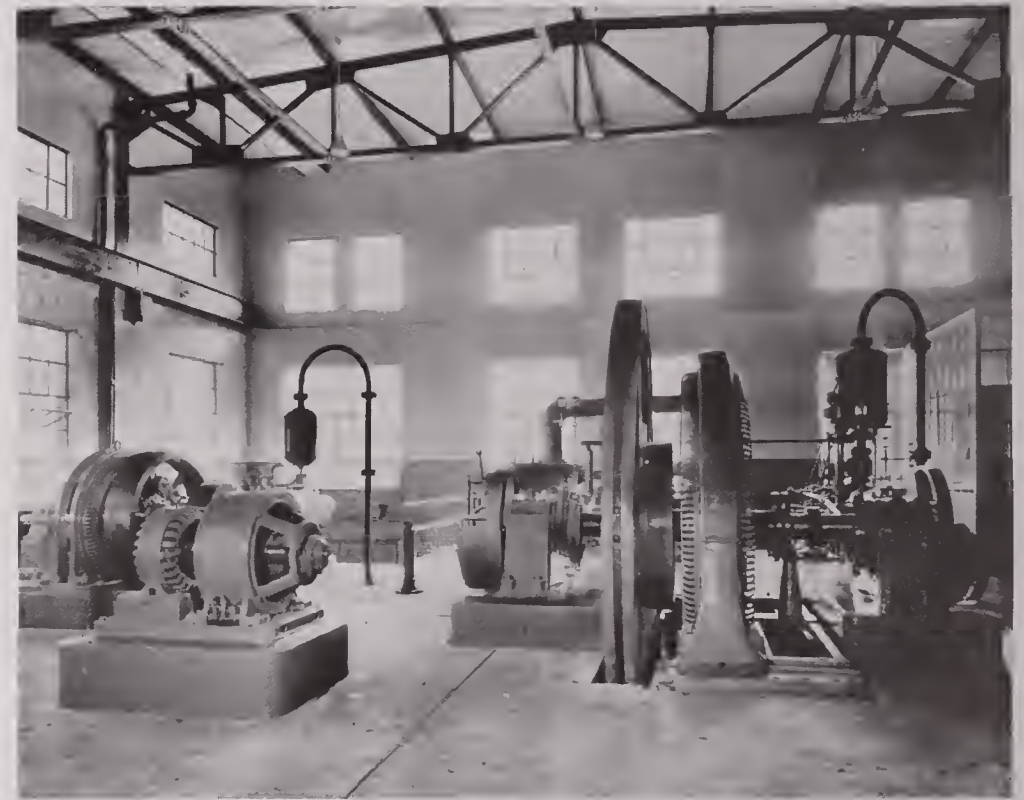

PLENTY OF LIGHT IN THIS ENGINE ROOM

more or less used by the electrical engineer carry the names of a number of other pioneers of the science down through the ages.

The old fairy tales we read with their wonders and marvels, their magic enchantments and remarkable happenings were but the dim gropings after the secret unknown power that the ancients felt pervaded all creation. They saw it in the lightning, leaping from crag to crag. They heard it in the thunder, its workings confused and mystified them at every turn, but not until our time was it harnessed and set to work.

The whole plant has been designed to allow for future expansion. As the business grows new units will be added fast enough to keep pace with the call for power. On first thought, it might seem to be better business to put in engines and boilers large enough to take care of the needs of the whole factory when it is complete, but that is not true. The best engineering practice is to divide the source of power



APPROXIMATELY 3,000 TONS OF COAL IN THIS PILE



THE OIL TANKS—A GRADE FOR EVERY PURPOSE

into several units as experience has proved that this is the way to avoid trouble. One big unit is liable to be out of commission and the job is flat, while it is very unusual for more than one of several units to be laid out at a time.

Another point that was considered when the 100 H. P. Ideal engine was put in was that at times when only a few machines and lights were in operation, the smaller engine would be large enough to take care of the load and incidentally decrease the operating costs. The two engines now in place are non-condensing as the exhaust is used for heating. The plant is already turning out 2,300 volts for power and lighting. An interesting fact about the Pan Motor plant is that its present estimated value exceeds the purchase price by approximately 100 per cent, due to an opportune buy last year when a Minnesota city decided to sell its power and light equipment. No time was lost in closing the deal at a bargain price and shipping the machinery to Saint Cloud.

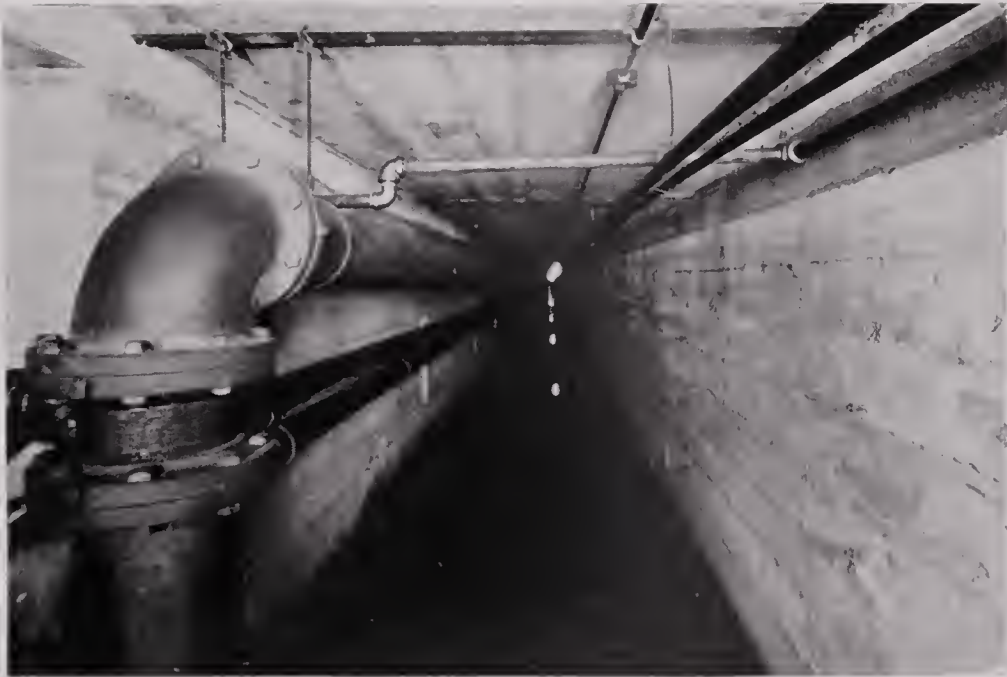

LONG DELAYS CAUSED BY BURSTED STEAM PIPES, ETC., ARE TO BE AVOIDED

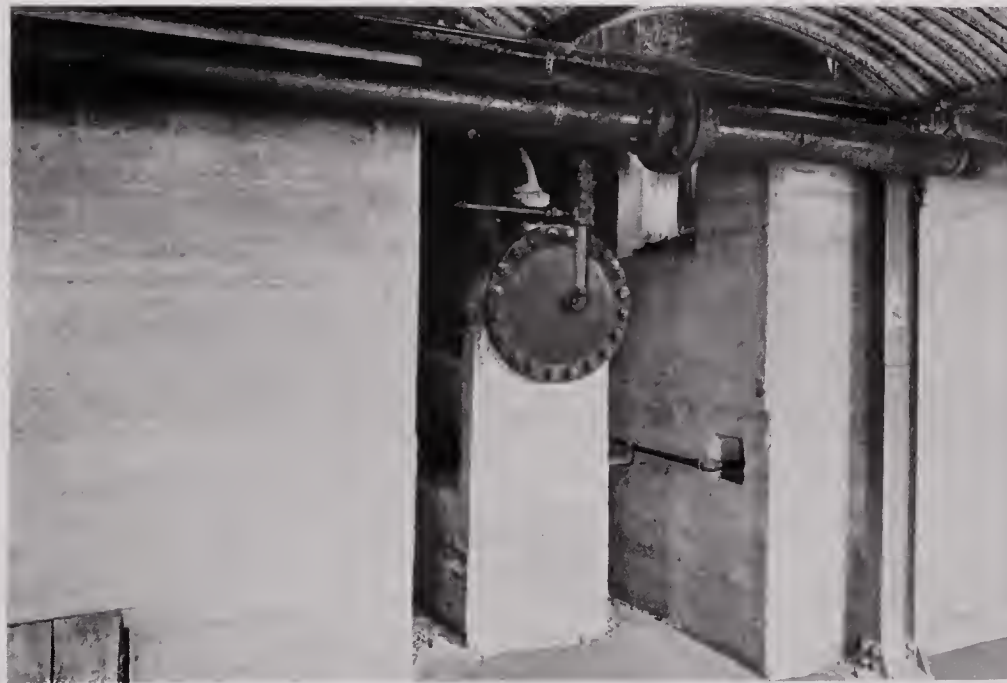

THESE LONG TUNNELS RUN FROM THE POWER HOUSE TO ALL BUILDINGS



WATER TOWER AND PUMP HOUSE

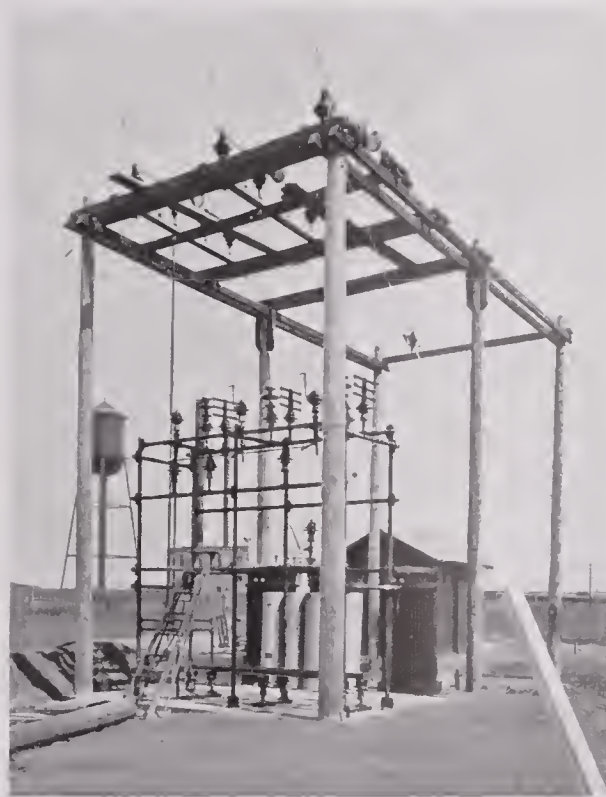

"STEP DOWN" TRANSFORMER STATION



PROPERTY FLOODED BY LIGHT AT NIGHT

Saint Cloud—Home of the Pan—Continued from page 83

The creameries alone paid into the coffers of the farmers last year \$14,176,033.18, an average for the whole state of 44.32c per pound for butter fat. The total value of Minnesota's dairy products for the year exceeded \$110,800,000.00. This includes butter, cheese, milk and ice cream. This money remains at home, is circulated in the state and is a year-round income for the farmers.

The National Creamery Buttermakers' Association offers at each of its conventions a \$100 silk banner to the state whose average of the ten highest entries is the greatest. Only two out of fourteen banners that have been offered have gone to other states, Minnesota having won twelve. Seventeen prizes in all have been offered in competition between the states, and Minnesota has won fifteen of them. This, it must be admitted, is a remarkable record and one that the dairymen of the state may well be proud of.

Stearns county is the banner creamery county of the state, having 32 creameries with 3,390 patrons, 28,751 cows, receiving yearly 2,786,966 pounds of milk and 17,412,950 pounds of cream, producing 4,556,172 pounds of butter fat and 5,598,944 pounds of the best and sweetest butter on earth. In 1917 the creameries of Stearns county paid to the farmers for butter fat \$2,000,693.32 and received for their butter \$2,242,878.16.



LOOKING WEST FROM WATER TOWER

Showing coal pile, side tracks and forge plant; also Great Northern to west and south. Waite Park, where the car shops of the Great Northern Railway are located, is shown in the upper left hand corner of photograph.

The creamery business is bringing about wonderful changes in Minnesota farm life. Much credit is due the farmers for the progress made in the raising of better bred cattle. Some of the finest herds in the country are to be found here and these wonderful producers are being cared for by intelligent farmers who understand the up-to-date methods of feeding, which fact accounts for the thousands of new silos which dot the country here and there all over the state. Along with this advancement go the beautiful farm houses, fine barns and creamery buildings, all of which conspire to increase the community spirit and insure permanent residents. One of the new features in the modern creamery building is a comfortable rest room for the farmers' families, and club rooms on the second floor where meetings for business and pleasure are held. These advantages make the creamery a community center.

Because of this intelligent management of the business on the part of the farmers and because of the exceptional natural advantages here offered, the average price paid Minnesota farmers for milk and butter fat is in excess of that of almost any other section. The average cow is depended upon to yield an annual return of from \$50 to \$75. In other words, one milch cow will bring in more in dollars

Continued on page 110



# THE PAN DROP FORGE PLANT

ONE of the outstanding features of the company's achievements for 1918 was the building, and equipping of its big drop forge plant, already in operation and almost fully equipped at this writing. Only those who have had an opportunity to watch its construction from the start early in the year to its present stage can fully realize how successfully this gigantic project is being rounded out in so little time.

Here, like in every other department, the company is building along the lines that will insure it a permanent and profitable place among the largest and most modern drop forge plants in the nation. The character of its buildings and machinery, their size and number, and the energetic and skillful organization behind it are ample evidence of its qualifications for a position at the top of the list.

The Pan drop forge plant comprises eight department units or buildings; the die shop, power plant, forge or hammer shop, oil storage, heat treating plant, physical and chemical laboratory, material, die and shear storage warehouse (under construction) and general office building. The construction of these buildings alone was a big task. Tens of thousands cubic feet of concrete, several hundred thousand brick, several hundred tons of steel and nearly 35,000 square feet of glass and steel sash are the approximate quantities of some of the most important materials that went into their construction.

No expense has been spared in the equipping this plant with the most efficient and modern types of machinery. A trip through the various buildings will convince the most critical technical inspector of that fact. The die shop, where the first drop forging operations begin, is one of the finest machine shops in the country. This unit of the forge plant has been in operation since July of this year. In the main forge unit or hammer shop one sees some of the modern giants of the industrial world—the drop forge hammers and trimming presses, some of them weighing 60 tons—huge monsters, grim and businesslike.

Of the nineteen hammers with which this shop will be equipped, seven are already in place and the balance of them are expected shortly. Forgings are being made daily at a rate that indicates that the

Continued on page 143







# D I E S H O P



ONE OF THE UNITS OF THE DROP FORGE DEPARTMENT

In this building are located the modern die makers' equipment and machinery—It is in here that first drop forge making operation takes place.  
It is one of the finest machine shops in the country.



# HOW DROP FORGINGS ARE MADE

**D**ROP forgings are the vital parts of the automobile, tractor and truck, the bayonet, the shell, the cannon, in embryo. It is interesting—this process from the die block to the finished product.

First of all, the character of the forging begins with the quality of the die block, and a great deal must be relied upon the ability of the operator. The die block is first planed, leaving stock on one side, which later forms the “edger” or “breakdown.” The shanks which result on the lower edge of the blocks form the gripping surface by which the dies are held securely in the hammers.

A templet or pattern outline of the forging to be produced is made, from which the shape of the forging is traced into the planed surface of the die block. The machine then mills the “roughing” cut to the shape required following the design traced into the block. A finishing or smoothing cut is taken over the impressions in the die block after the roughing cut is completed. The “edger” or “breakdown” is then formed. This operation constitutes part of the sinking of the die.

The “edger” is used to take the rough shape of the forging. This makes possible some of the really remarkable products which come from the hammers. With the three operations the die is almost complete. Accuracy requires every possible expert attention. The skilled mechanic then scrapes and smooths the impression, bringing it to the highest possible degree of perfection. Both halves of the die are placed together, face to face, and a lead cast is poured so that the dimensions may be checked. The depressions for the flash or surplus stock are next formed on both halves.

The proof of the die is cast by pouring lead into the impressions in the blocks, when placed face to face. The cast is carefully checked and if found to be correct is sent to the purchasers for the approval of their engineering department.

The next operation is the sinking of the depression for the flash. Small sized dies are then sent to the heat-treating department for the tempering process. The larger die blocks, such as those used in making crankshafts, axles, etc., are tempered before the die making operation begins. The dies are now ready for the forging operation.



CARE AND ACCURACY—THE DIE SINKER'S WATCHWORDS

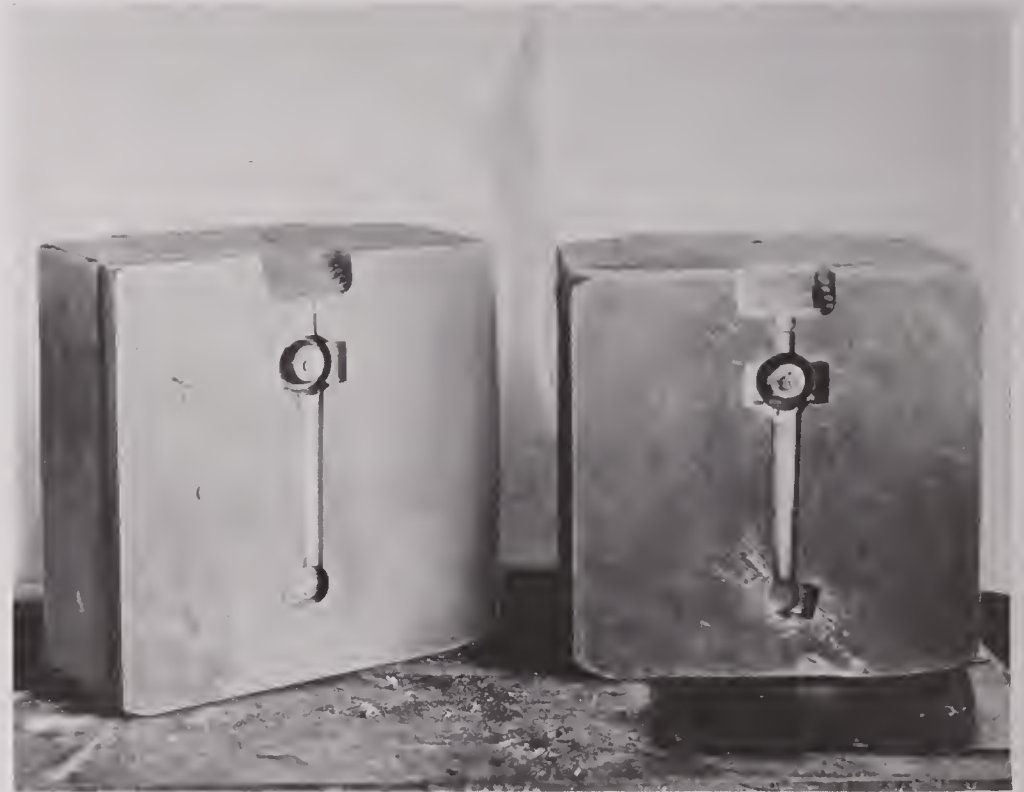

CONNECTING ROD DIES READY FOR HAMMERS

The steel to be used in the making of drop forgings is received in a crude stage in standard mill sizes from one-half to five or more inches square and also round bars of from one-half to five or more inches in diameter.

Proper handling of raw steel stock is a matter of great importance. The stock is kept under cover from the weather and the different grades and sizes are separated according to their mechanical content.

Every bar of steel is carefully inspected when received, to detect possible defects. Material showing seams, shuts, or other defects is rejected. An accurate analysis of the chemical content of the drillings selected methodically is made in the laboratory. This analysis is carefully checked with the purchasers' specifications and if not in accordance therewith, the material is rejected.

Upper and lower dies are then placed in the hammer, and with smashing blows the forging is made. Immediately after receiving the blows from the hammer, the white hot forging is carried to the trimmer where the flash or surplus metal is trimmed off.

Continued on page 105



LOOKING EAST IN DROP FORGE DIE SHOP

The first operation in the manufacture of drop forgings—making the dies—takes place here. Here one sees some of the finest machines ever assembled for die making and machine work.

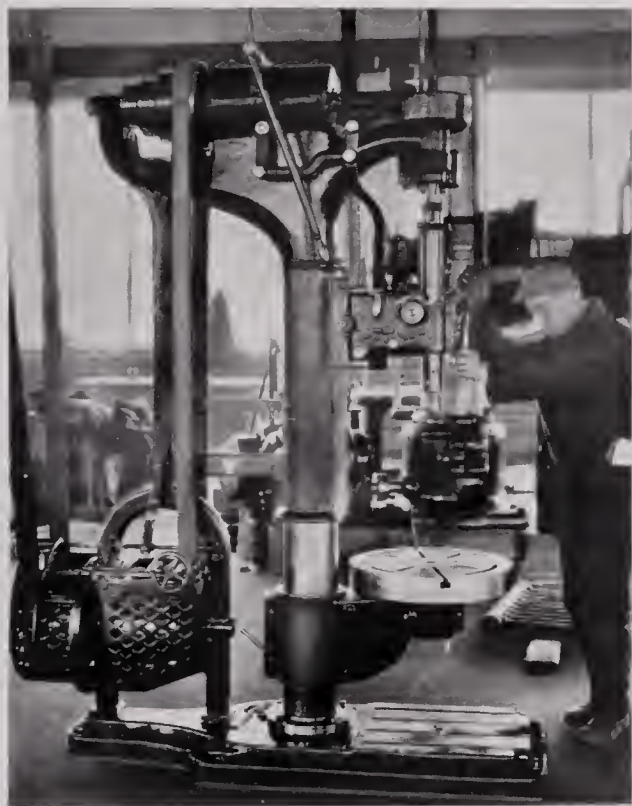

WEIGEL 26-INCH DRILL PRESS

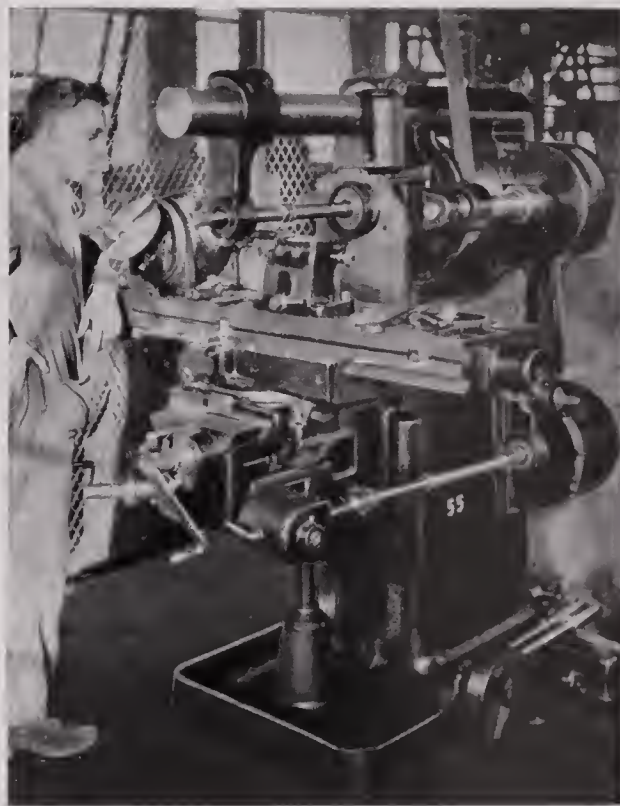

UNIVERSAL MILLING MACHINE



OSTER PIPE THREADING MACHINE

How Drop Forgings Are Made—Continued from page 103

This trimmer is fitted with a cutter which bears the exact outline of the forging being made. The trimmer puts the finishing touch to the forging, with the exception of the upsetting of the flange, should any flange be required. When the dies are sunk, sufficient allowance is made for the stock required for the flange. The flange end is again heated and placed into the dies in the upsetting machine. This machine is virtually a horizontal motor-driven hammer. It is not a pounding device like a steam hammer, but a ramming device, which rams the stock on the flange end of the forging into the required shape of the flange.

Upset forgings are required in crank-shafts, drive-shafts, wheel-hubs, counter weights, worm and bevel gears, etc.

Operation number twelve covers heat-treating. The forging heat being so far above the average critical temperature, it is necessary to heat-treat the steel after the forging process to restore its physical properties; all forgings which will be subjected to severe shocks or strains, should, therefore, be properly heat-treated. Simply allowing the forging to cool from the forging heat is by no means proper



EVERY No. 1 1/2 DRILL PRESS



UNIVERSAL GRINDER



EVERY No. 2 1/2 DRILL PRESS

heat-treatment. Heat-treatment begins after the forging has cooled. The forgings are taken from the hammers to the heat-treating department. Here they are given a preparatory heat to reduce forging strains. Next they are treated to the critical temperature and quenched and then drawn and tested to the proper hardness. This hardness is the proof of the suitability of the forging for the wear and strain of actual use. The forgings are then pickled to remove the scale.

The forging is then subjected to an oil and water quenching operation. An abundance of water insures absolutely uniform cooling and consequently a uniform hardness.

After the forgings have been heat-treated, it is necessary to heat them again to reduce the quenching strains, and prepare the metal for the machine. This is known as the "draw-heat" and is considerably lower than the critical temperature. After the forgings have remained in this heat for the required length of time, they are removed from the furnace and allowed to cool in the air. This process, properly carried out, so conditions the steel as to permit a free machine operation.

Concluded on page 108

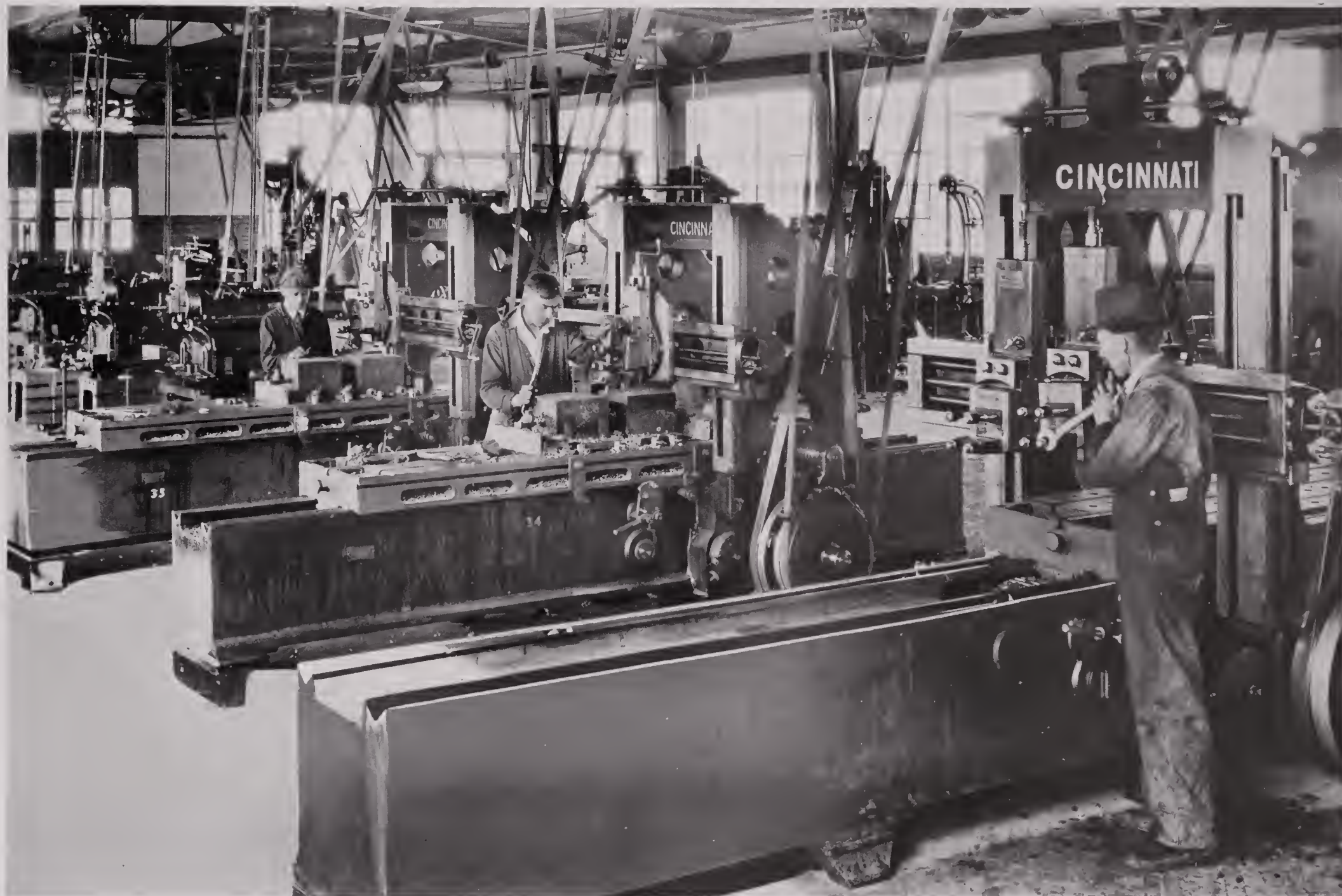

A BATTERY OF CINCINNATI PLANERS IN DIE SHOP

The face of the rough die block is first planed down to a smooth surface on one of these machines before further operations begin. The shanks are also formed here.



GISHOLT 42-INCH BORING MACHINE

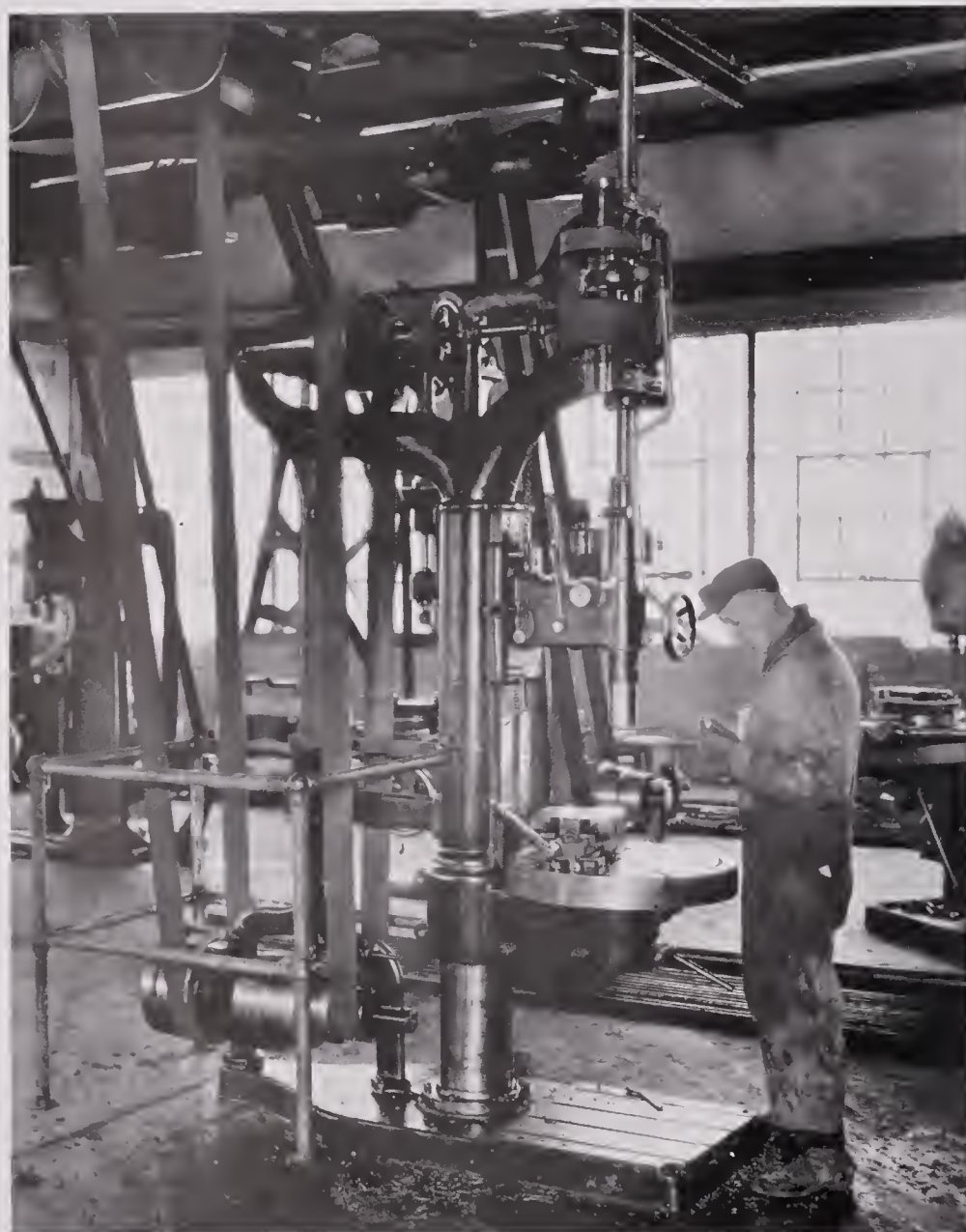

SUPERIOR 28-INCH DRILL PRESS

How Drop Forgings Are Made—Concluded from page 106

The temperature required for the proper heat-treatment is determined by a chemical analysis of the steel. Special equipment is used in determining the temperature while the heats are in progress. It is quite impossible to gauge accurately the temperature of the furnace during a "heat" without this equipment. Scientific exactness in every step—modern machinery and equipment—skill and care are what make forgings dependable.





# HEAT TREATING THE FORGING

**F**OR hundreds of years—in fact clear back to the dawn of history—the Japanese have made wonderful swords. The tempering of these blades has always been a religious ceremony to be carried out with scrupulous exactness, so much heating and hammering, so much prayer, so many plunges into water, etc.

The modern metallurgist reading the account of it and shrewdly guessing at the properties and composition of their steel, smiles as he figures mentally, the degrees of heat and the time taken to repeat the prayers. He thinks if he followed the same program with a stop watch instead of the heathen incantation he could get the same result. Of course he could—even though those old swords, some of them a thousand years old, are still considered without an equal by the posterity of its maker.

It has been only a little while since our heat treat experts went through with very much the same performance. There is only one essential difference—we might have talked about heavenly things when it didn't come out right, but there wasn't much religion about it.

There is a wide gulf between the rule-of-thumb methods of yesterday and the modern heat treating of today.

Contrary to the impression that seems to be common, there is nothing mysterious about the tempering of steel. It is entirely a matter of a careful analysis of the steel in the first place, with proper heating and cooling afterward.

It is usually sent from the mills by heats, that is, each batch of steel is bundled up by itself as it comes from the rolling mill. Then when a piece of steel from this heat is analyzed and tested, its properties and composition are known, the proper treatment for the entire batch of parts is determined by chemical content.

Then the engineer has something definite to go on. He does not stop at that. The next step is an experimental heat treatment after which a bar is prepared and its resistance to a pulling or "tearing apart" test is noted. Then follows a Brinnell and Slearoscopic test to determine hardness, and a very ingenious test to determine its resistance to sudden shocks or breaking strains. All this work will be done in the laboratory that stands just back of the heat treating building.

Continued on page 122

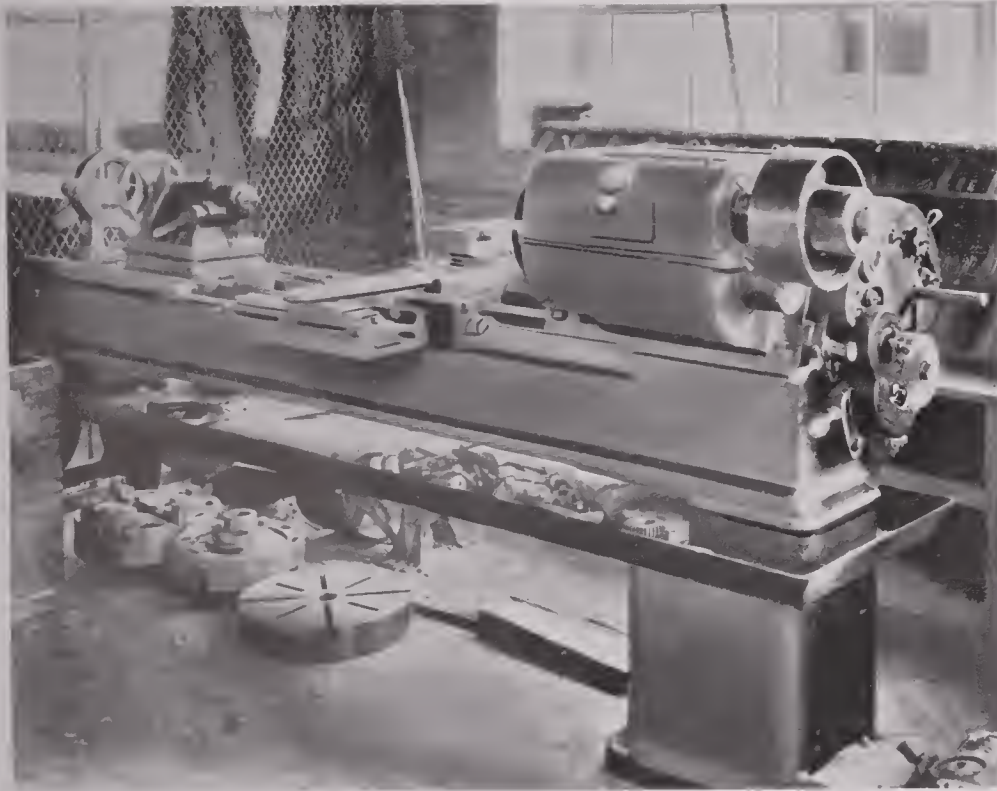

SPECIAL EQUIPPED AMERICAN 16-INCH LATHE

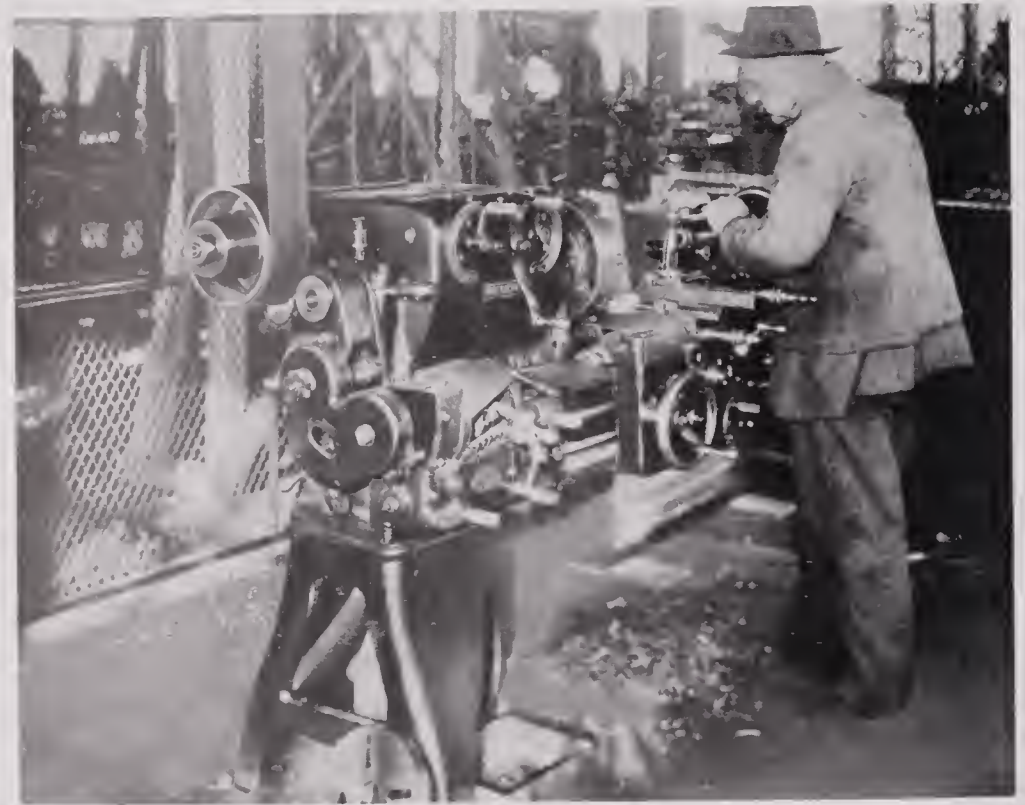

AMERICAN 16-INCH ENGINE LATHE

Saint Cloud—Home of the Pan—Continued from page 99

and cents than five beeves. The people of Stearns county and Minnesota have all the respect in the world for the cow. They know her true value. She is a money-maker, a bank roll builder, and she is coming more and more into her own.

#### Center of a Rich Farming Section

No country is richer than its soil. Farming is the biggest business in the world. The financial, industrial and commercial life of the nation is in the hands of the man who tills the soil. When trouble comes, when calamity threatens, when the nation is imperiled, the first cry is for food and more food—increased production—and the farmer at once goes to work with redoubled energy to save humanity. Agriculture, therefore, being the earth's most vital and important industry, how fortunate the city whose tributary country is rich in soil productiveness, rich in climatic conditions, rich in water supply and rainfall, possessing all the requirements and all the elements necessary to diversified farming and stock growing!

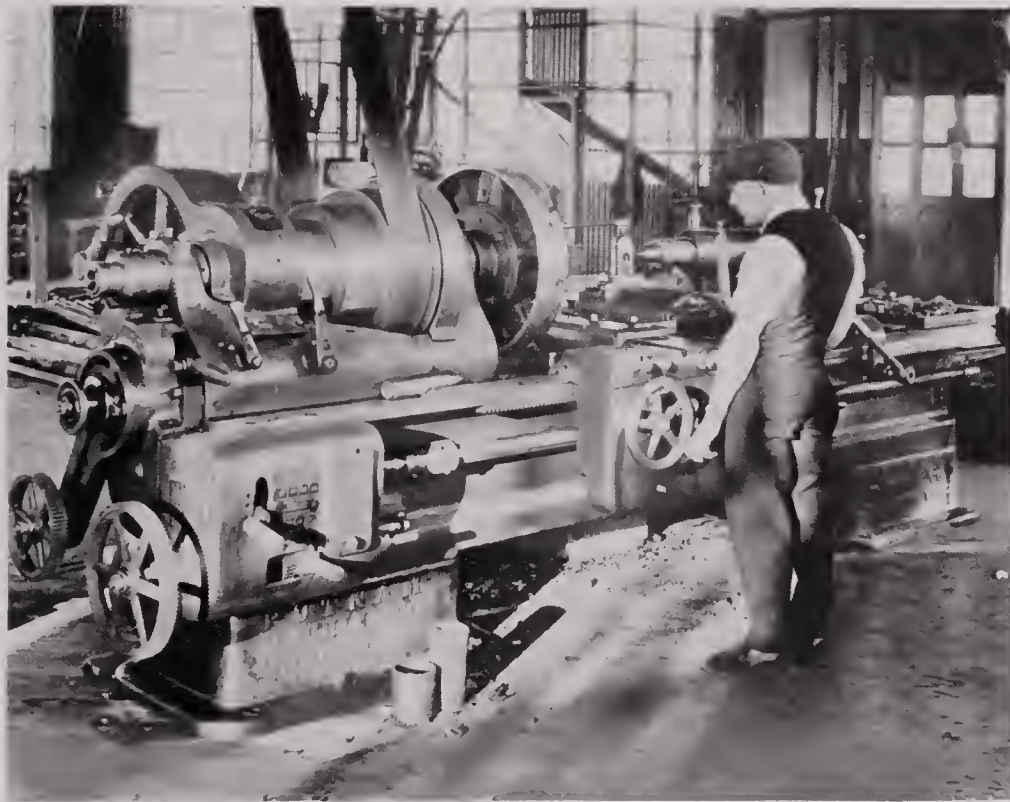

PUTNAM 30-INCH ENGINE LATHE



A SECTION OF THE TOOL CRIB

Saint Cloud is the hub of one of the richest farm and stock districts in the country and has never known a crop failure. This last statement will bear repeating in larger type: **THE SAINT CLOUD DISTRICT HAS NEVER KNOWN A CROP FAILURE.**

The soil is a rich dark loam and sandy loam with a clay subsoil. Twenty good crops of wheat have been grown on this soil without any interval of rest for the land or change of crop, and yet the productive power of the land remains almost as great as it was the day the sod was first broken. Minnesota is known as "The Granary of the United States" and "The Home of the Greatest Flour Mills." These expressions were not coined without cause. They tell briefly the story of the productiveness of fertile fields and bespeak a prosperity that is evidenced on every hand.

Stearns county ranks fourteenth in land area and fourth in population among the 86 counties of the state. The greater part of the land area is a heavy black loam. This is especially true of the southern and southwestern portions of the county, while in the central and northern portions the soil turns to a heavy yellow clay. In the river bottoms, those of the Mississippi and the Sauk, there are



DIAMOND POWER GRINDSTONE



CANTON PORTABLE HOIST CRANE



DIAMOND POWER TOOL GRINDER

areas of heavy black sand with rich clay subsoil. The population of the county at the present time is approximately 50,000 people; it has an area of 849,990 acres and a total assessed valuation of \$24,739,500.00, fourth in the state.

The principal crops are: Wheat 104,447 acres, oats 76,329 acres, barley 24,776 acres, corn 50,967 acres, rye 16,326 acres, potatoes 4,056 acres, flax 7,776 acres, hay 108,234 acres. Corn, wheat and oats are the leading crops and produce wonderful yields. In recent years tobacco growing has been demonstrated as a safe and profitable crop. In 1917 growers cleared as high as \$300 an acre from tobacco.

The farmers of Stearns and adjoining counties are lovers of blooded stock and great strides are being made in this direction. Besides the numerous herds of pure-bred Shorthorn cattle and the large number of Clydesdale horses, for which this section is already widely famous, the hog business is fast developing into an industry of the greatest importance. The poultry business is also highly developed and is a source of substantial revenue. This is likewise true of the bee industry, there being no better honey on the market than that produced in Minnesota.

Continued on Page 114

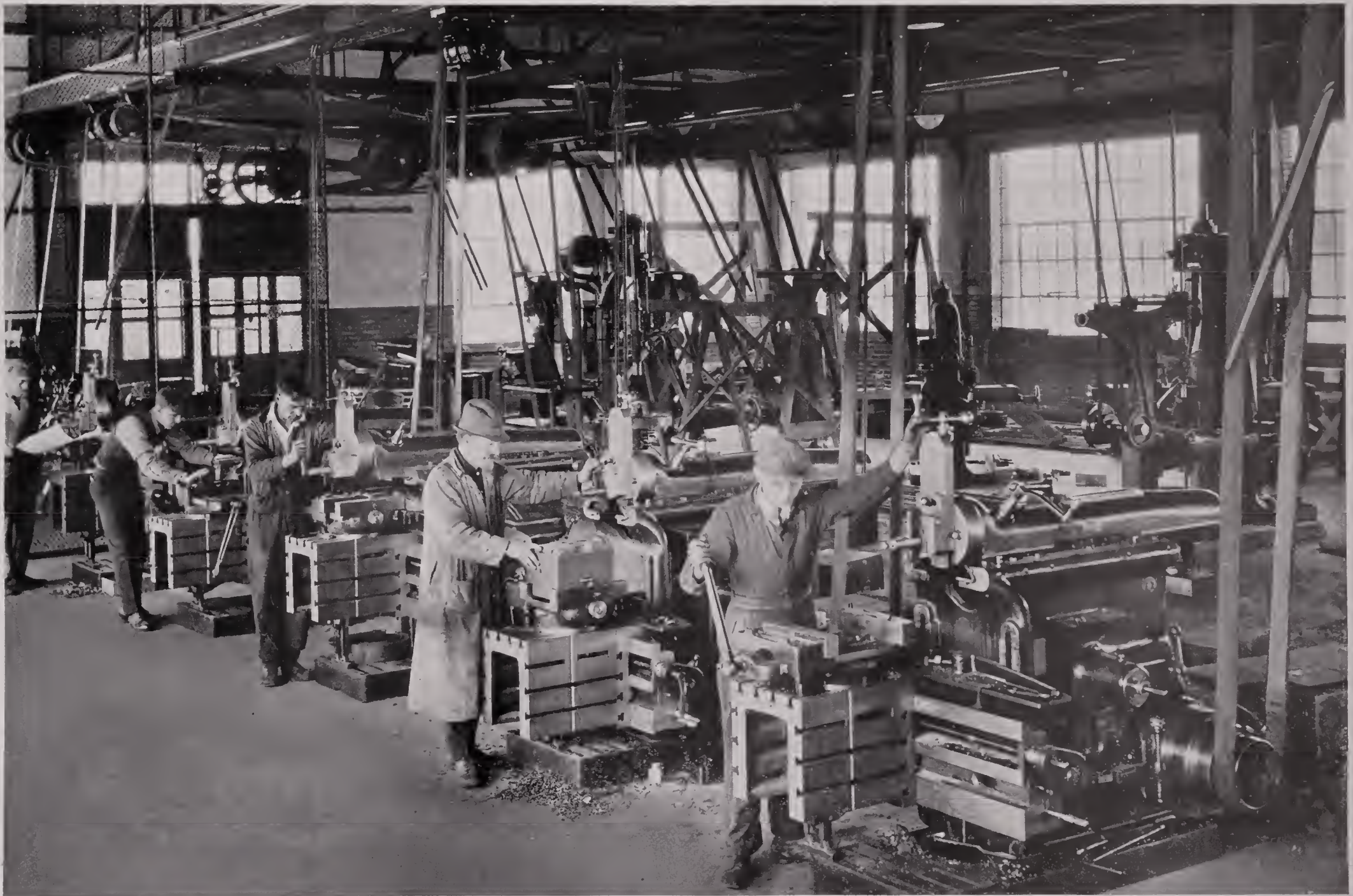

A BATTERY OF GOULD AND EBERHARDT SHAPERS

There are many intricate patterns in die and trimmer blocks which necessitate the use of these delicately adjusted shaping machines of which there are five set up.

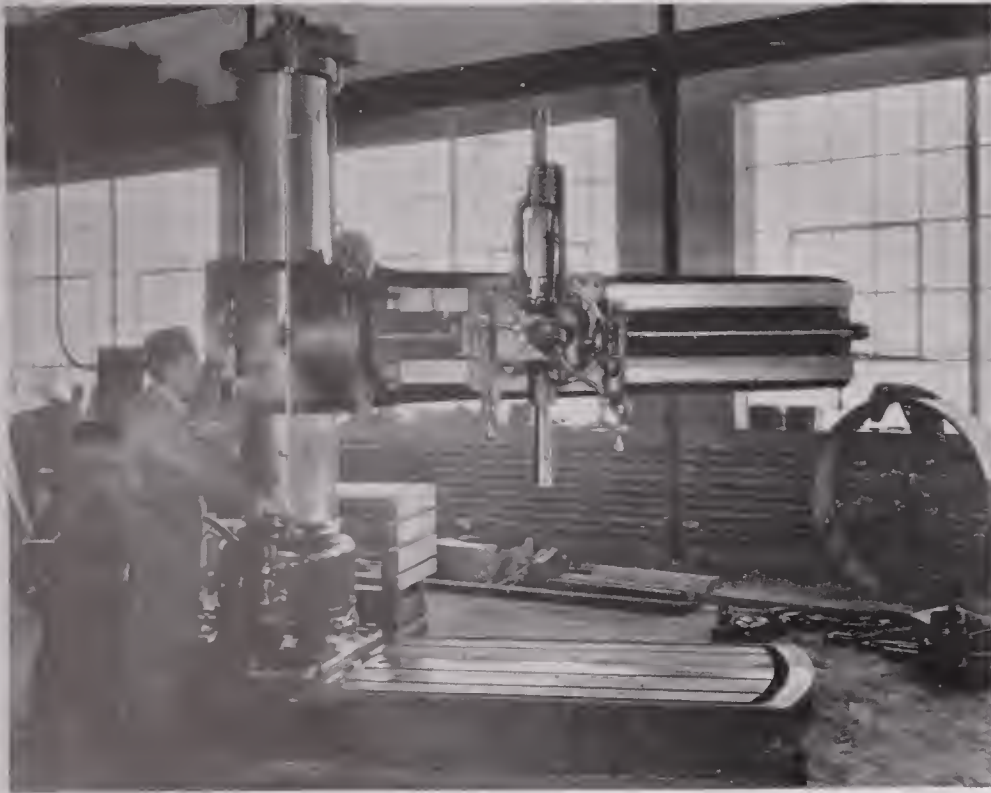

AMERICAN 6-FOOT RADIO DRILL



DIES AND TRIMMING BLOCKS

Saint Cloud—Home of the Pan—Continued From Page 112

### Minnesota's Ten Thousand Lakes

No man can work all the time at top speed and produce the best results. There must be relaxation, diversion. Both the body and the mind require an occasional outing. It is the law of nature and must be obeyed. Without it the human machine becomes sluggish and loses its pep and punch. This thought must have been in the mind of the Creator when He brought Minnesota out of chaos, for there is not a state in the Union that offers more in the way of real sport. Man's needs in this respect were fully anticipated and Minnesota's Lake Park Region, along the Great Northern Railway, with its sky-blue lakes, its virgin forests, its numerous and beautiful rivers and streams, furnishes the fisherman, the vacationist and the sportsman an unlimited choice of diversion. With over ten thousand lakes within its borders this is easily and by far the greatest recreation state in the nation.

Almost every variety of fresh water fish is indigenous to Minnesota's waters. The large and small mouthed bass engage the attention of most fishermen who delight in a real battle, but the Great North-

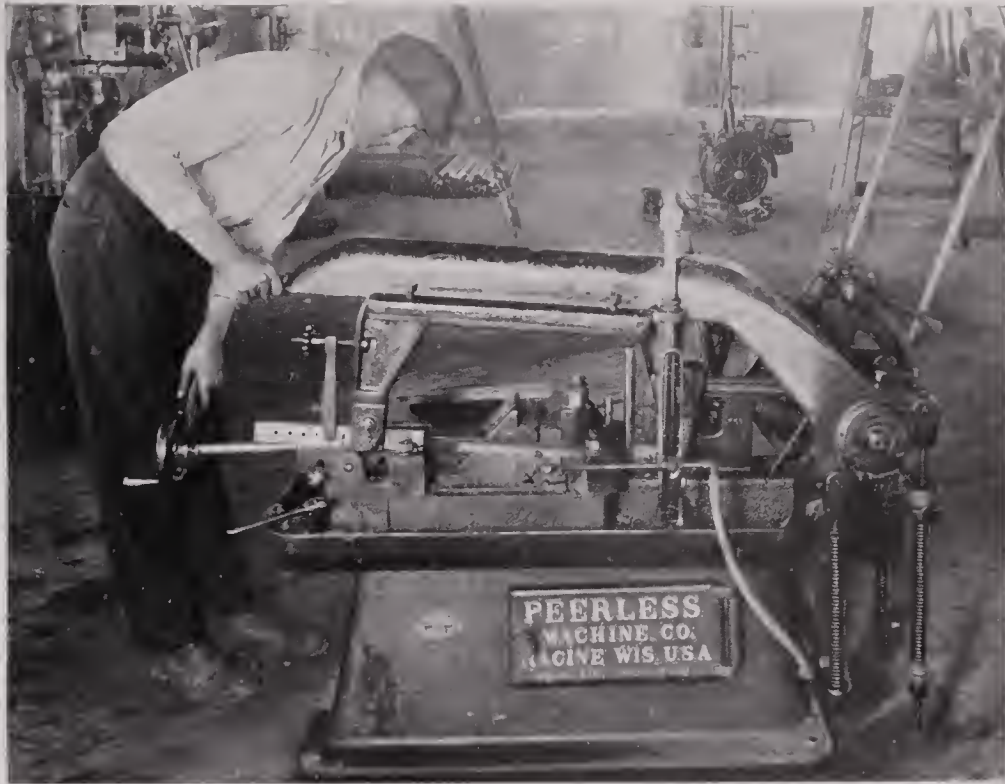

PEERLESS HI-SPEED HACK SAW



ONE OF THE THREE TON OVERHEAD CRANES

ern pike which closely resembles the muscallonge, the golden pike, the muscallonge itself and the pick-erel, all give plenty of excitement and adventure, while crappies, that savory pan fish, will help to fill the creel and add to the memories of the great "fish fries" for which the state is famous. The speckled trout is here also and will make it interesting for all who are looking for a lively time.

Whether it is fishing or hunting, camping out in the cool woods or on the shores of limpid waters, bathing and swimming, sailing and boating, or if it is tennis, or golf or sketching, or if it is rest and recuperation, there is no spot on the globe that has advantages over Minnesota. Every delight that is dreamed of by the active business and professional man of the city is here freely and abundantly furnished. The beautiful lake shores furnish ideal locations for summer homes in a climate where the seasons are ideal, where robust health is the key-note and where life is worth living.

Stearns county alone has 80 lakes that are a mile or more long and 125 smaller ones. Many of these each season attract tourists and outers from various sections of the country. Besides the Mississippi the principal streams of the county are the Sauk, Watab, Clearwater and Crow rivers. There

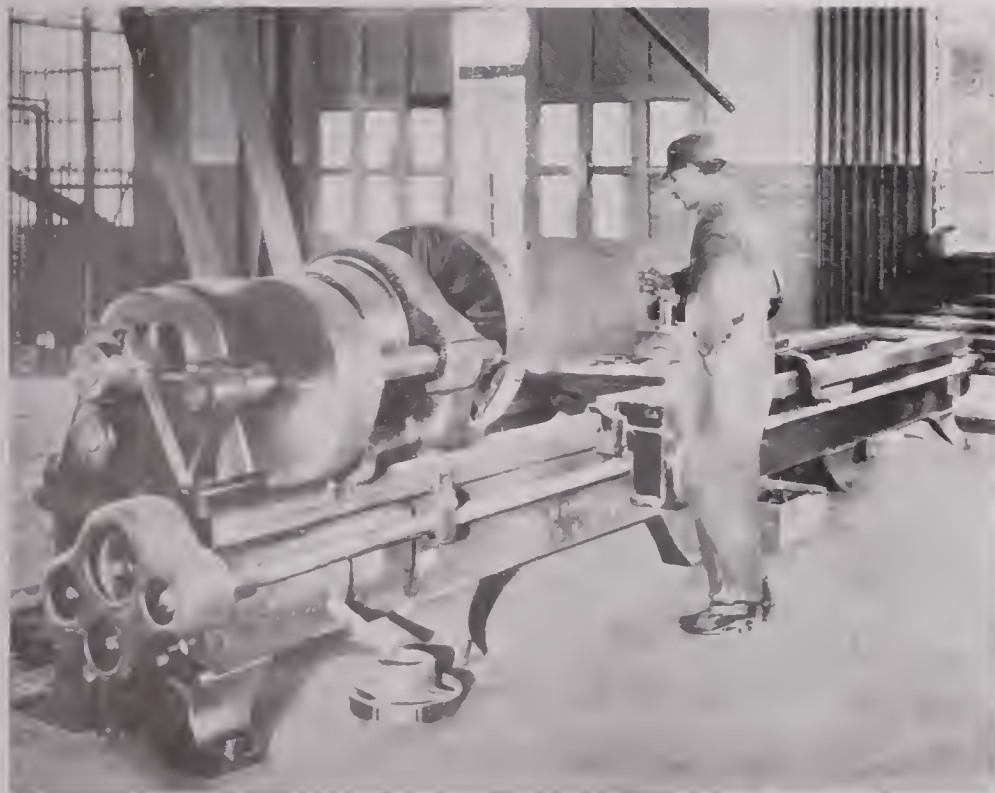

NILES-BEMENT-POND 32-INCH LATHE



ERECTING FORGE POWER PLANT STACK

are also many smaller tributary water courses, all of which are not only of value in a recreation sense, but are necessary to an agricultural, dairying and stockraising county.

Minnesota is naturally the Mecca of the summer homeseeker. Its climatic, scenic and piscatorial advantages are yearly attracting an increasing number of sojourners from all parts of the country. Minnesota has five thousand six hundred square miles of water, exclusive of Lake Superior, this being a larger water area than that of any other state. It occupies the most elevated plateau between the Gulf of Mexico and Hudson Bay, with an average elevation of about 1,000 feet above sea level. Fogs and damp weather are practically unknown. The rarefaction and dryness of the atmosphere tend to make this the healthiest country on earth. Although there is plenty of warm weather during the summer, the heat is not excessive or debilitating. During the hottest days of the season the thermometer registers, on an average, from 85 to 90 degrees, and the nights are invariably cool and refreshing.

Continued on page 118



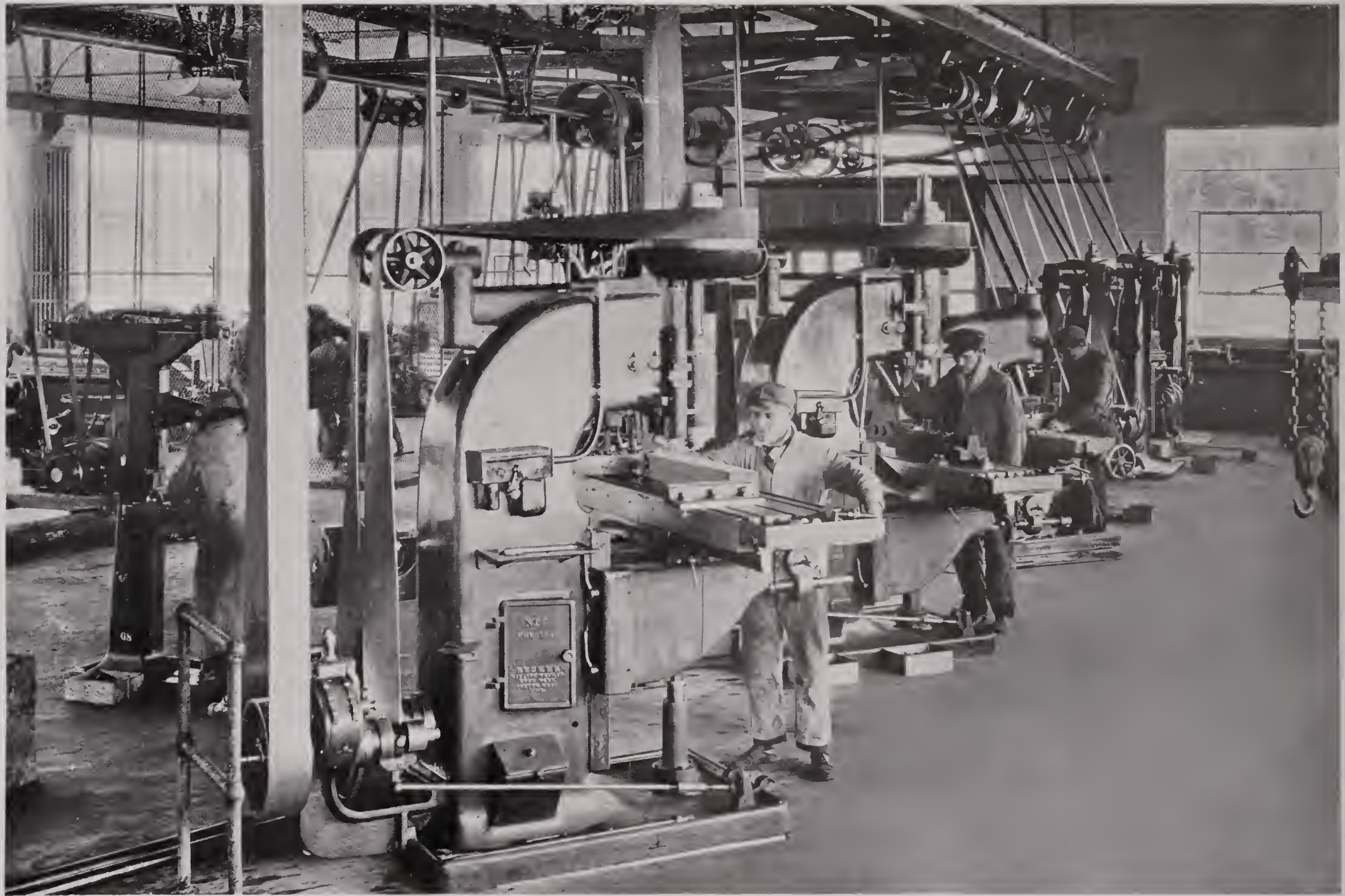

A BATTERY OF VERTICAL MILLING MACHINES

Milling work on the heavy dies such as crank shafts, axles, etc., is done on these big Becker and Milwaukee milling machines. These are two Beckers and one Milwaukee set up



PRATT & WHITNEY PROFILER  
One of a Battery of Three.

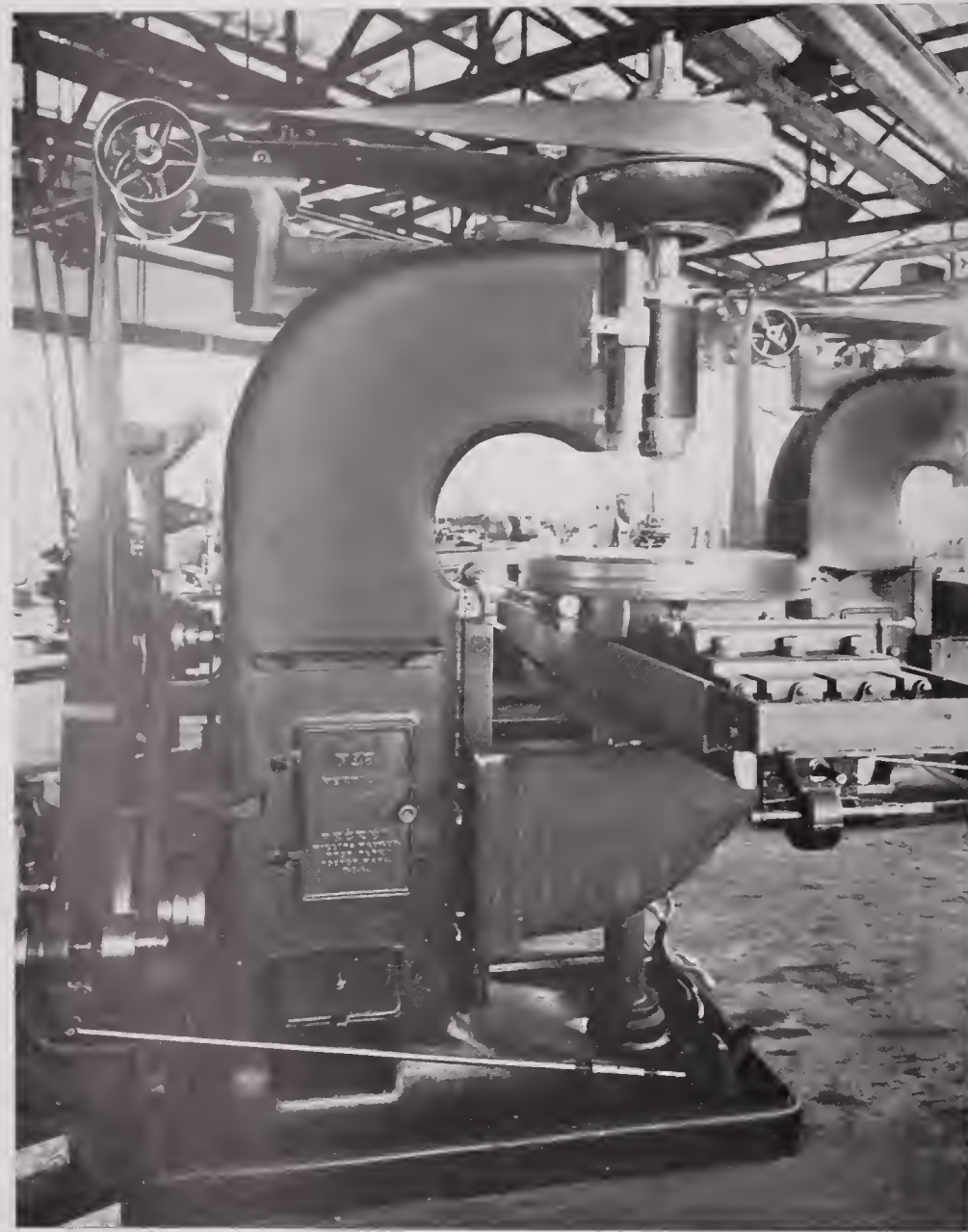

BECKER NO. 6 VERTICAL MILLER  
For Heavy Die Work.

Saint Cloud—Home of the Pan—Continued from page 116

Minnesota's beautiful highways afford ample pleasure for the motorist. Any one of its summer playgrounds can be reached by automobile and any number of delightful trips can be made from these resorts over splendid highways. In 1917 the Minnesota State Highway Commission expended \$3,884,000 for road improvement and during the present year is expending twice that amount, or \$7,700,000.



DIAMOND AUTOMATIC SURFACE GRINDER  
For smoothing die block surfaces.

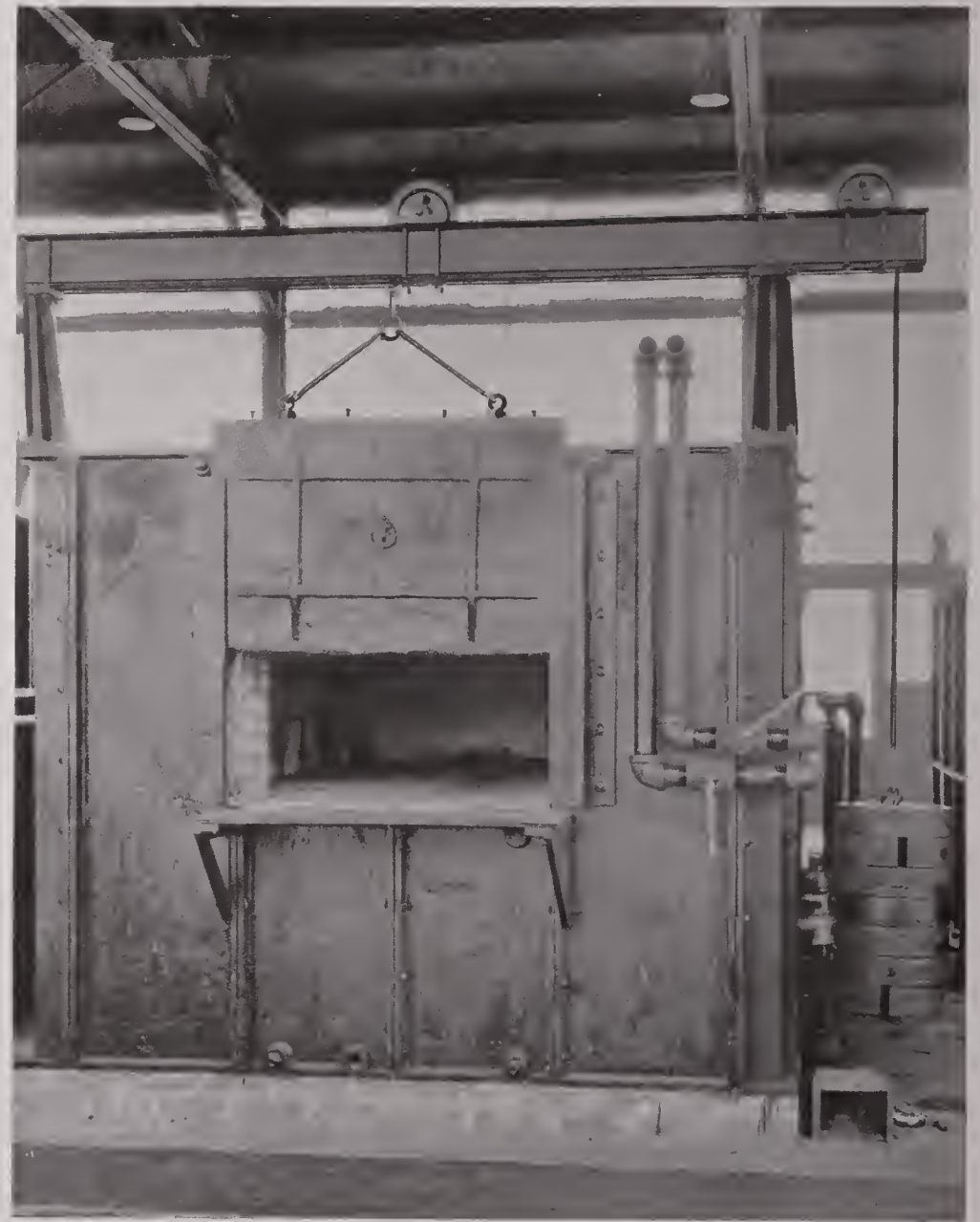

ONE OF THE BIG HEAT-TREATING OVENS  
In which forgings are tempered.

### Living Conditions are Excellent

In the midst of plenty, where the great bulk of the population are producers, where practically everything that goes on the table is raised and grown within a radius of a few miles and where there



THE DROP FORGE PLANT FROM THE NORTH

is every possible transportation facility, living expenses should be reduced to a minimum. They not only should be, but in the case of Saint Cloud, they are. War prices do not prevail here to any appreciable extent. Of course there has been some advance, but for the actual necessities of life present prices are very little above those of pre-war times. To tell the plain truth, a family can live here on slightly more than half the amount it costs to exist in the big cities. The laboring people of Saint Cloud are far above the average in intelligence, many of them having been born and reared in and near the city. They are well paid, well housed, well clothed and well fed, while their children have the advantages of the best public schools in the country.

Beautifully situated high on the banks of the Mississippi, where the river makes a sharp turn, forming almost a circle, revealing a glorious vista, both up and down stream, with dense foliage marking the upper reaches to the rapids and the mouth of the Sauk, while to the south are the thousand islands that fill the river for miles, Saint Cloud, the metropolis of Central Minnesota, has an ideal location for a city of homes.

Good health, good fellowship and a spirit of optimism are the dominating characteristics of this happy, fortunate people. They value their health above all things else and while the location and

Continued on page 126



# HEAT TREATING PLANT

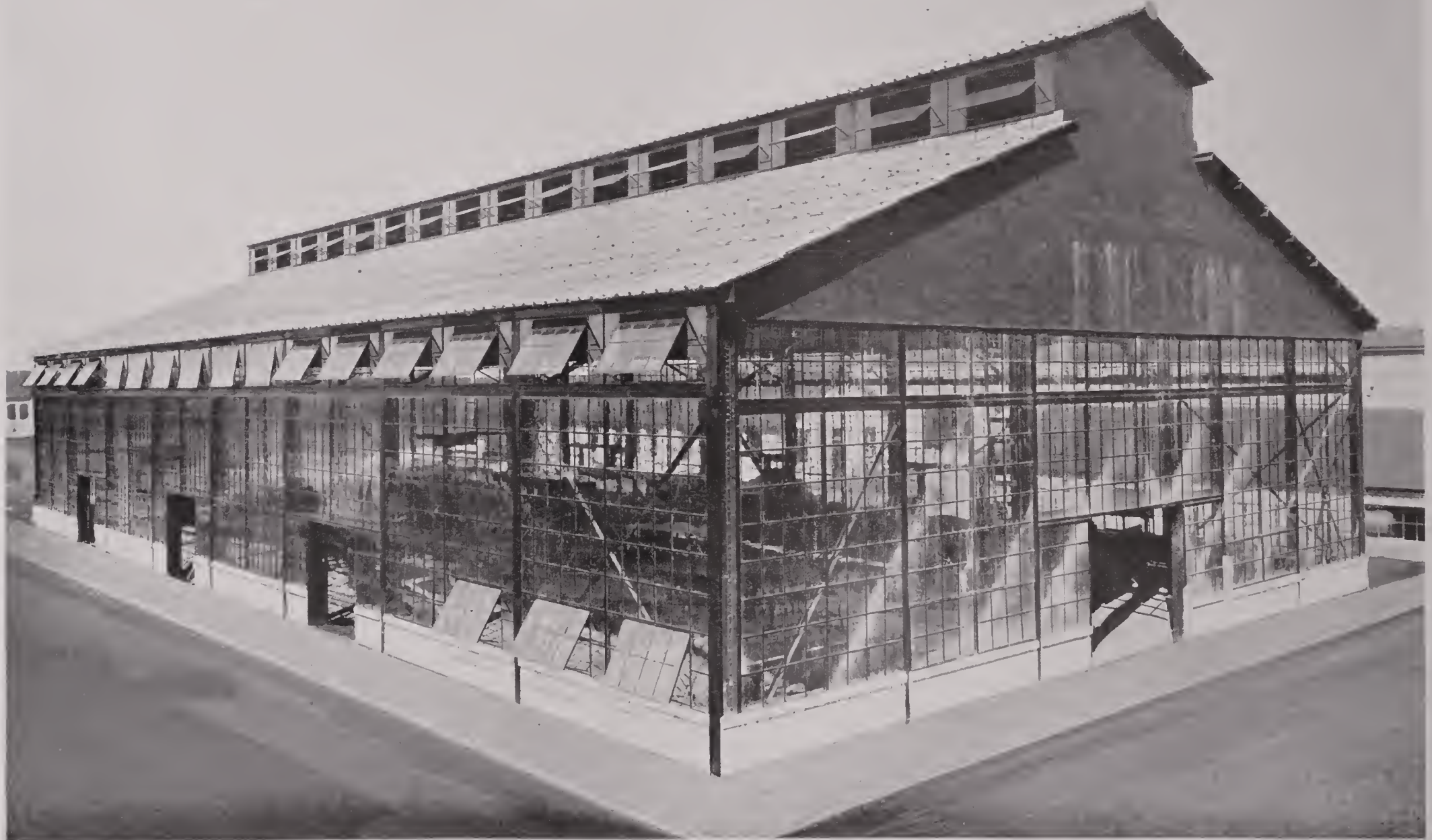

ANOTHER IMPORTANT DEPARTMENT OF THE DROP FORGE PLANT.

Well lighted, well ventilated, well planned throughout for the important work to be done in it. The Pan Heat Treating Plant is constructed entirely of steel, concrete and glass.



LOOKING DOWN CENTER OF HEAT TREAT OVENS



THE BLACKSMITHS' FORGES AND ANVILS

Heat Treating the Forging—Continued from page 109

If the word goes out that the suspected batch—suspected is used advisedly, as it is treated like a suspected criminal until its worth is proved—of steel is suitable for the work in hand it is cut into multiples of the object to be made and sent to the Drop Forge Shop where it is heated, forged and trimmed.

Back it comes, no longer in rigid bars but as aeroplane parts, truck parts, hammock hooks, helmets, connecting rods—the thousand and one things the world uses in such vast quantities, but its nature has changed. Heating and forging has made it coarse in structure and weak. It must be refined and made strong again by the proper heating and cooling.

The parts are placed in the under-fired furnaces or ovens and given the same treatment as the original experimental heat treatment. These are of a special design by Pan Heat Treating Experts. An ingenious arrangement of lights in connection with the pyrometer or heat registering devices on each of the twelve ovens shows at a glance when the heat is at the proper point. Both oil and water are used

Concluded on page 124



INTERIOR OF THE HEAT TREATING PLANT

This picture taken during the equipping of this plant shows the big tempering ovens in which the forgings are placed and hardened to withstand the strains they will be subjected to.



DROP FORGE LABORATORY BUILDING



INTERIOR LABORATORY BUILDING DURING CONSTRUCTION

Heat Treating the Forging—Concluded from page 122

for cooling as the case in hand demands. This is contained in movable tanks running on tracks, pushed to a position in front of the oven to be emptied, and the whole batch raked in. Then comes careful examination of each piece and the final O. K. of the inspector. The parts are then ready for the machine shops or for shipment.

This process is housed in a building just west of the Hammer shop. The walls are of steel and glass, giving an abundance of light even on the darkest and most cloudy days. It is 128 feet long, 65 feet wide with tile roof. The furnaces are heated with oil from the central supply tank, and tunnels or galleries pass under the floors the same as all of the other buildings, leaving the floor space around the ovens entirely clear.

The cooling or quenching vats are kept supplied with cold water from the general water system, fed by the big tank near the central Power station, and adequate sewers carry away all waste hot water.

It is all very matter-of-fact and commonplace. So much heat, so much cooling, a certain response to a certain test, a certain result. There is no superstition connected with it. There is nothing spectacular only a sweaty back-aching job all day and every day.





ONE OF THE BATTERIES OF HEAT TREATING OVENS

Somewhat like a baker's oven in appearance—but a loaf of bread would not last long in them—they furnish the intense heat by which the forgings and dies are tempered—oil is the fuel.



THE OIL STORAGE BUILDING



INTERIOR OIL STORAGE BUILDING

Saint Cloud—Home of the Pan—Continued from page 120

climatic conditions naturally produce strong, vigorous men and women, nothing is overlooked in the way of cleanliness and sanitation on the part of those who have in custody the good health of the community. As a consequence the city is noted for its low death rate and freedom from disease. From a moral standpoint this is an ideal community. Influences that tend to degrade are suppressed and every effort is made to supply clean, wholesome entertainment and surroundings for the young and the old. The result is that Saint Cloud has a splendid citizenship, composed of broad minded, clear thinking, intelligent men and women, whose children are being well trained, well educated and directed into paths of industry and usefulness.

Neither too hot nor too cold, too high nor too low, too wet nor too dry Saint Cloud and contiguous country are not only adapted to the production of great crops and fine stock, but also have the elements necessary to the development of the most efficient human machine. In the summer there is no extreme heat, such as prevails in the southern and central states, yet the days are long and the sun is warm, a condition exceptionally favorable to the growing of corn. The air is comparatively dry

Continued on page 128

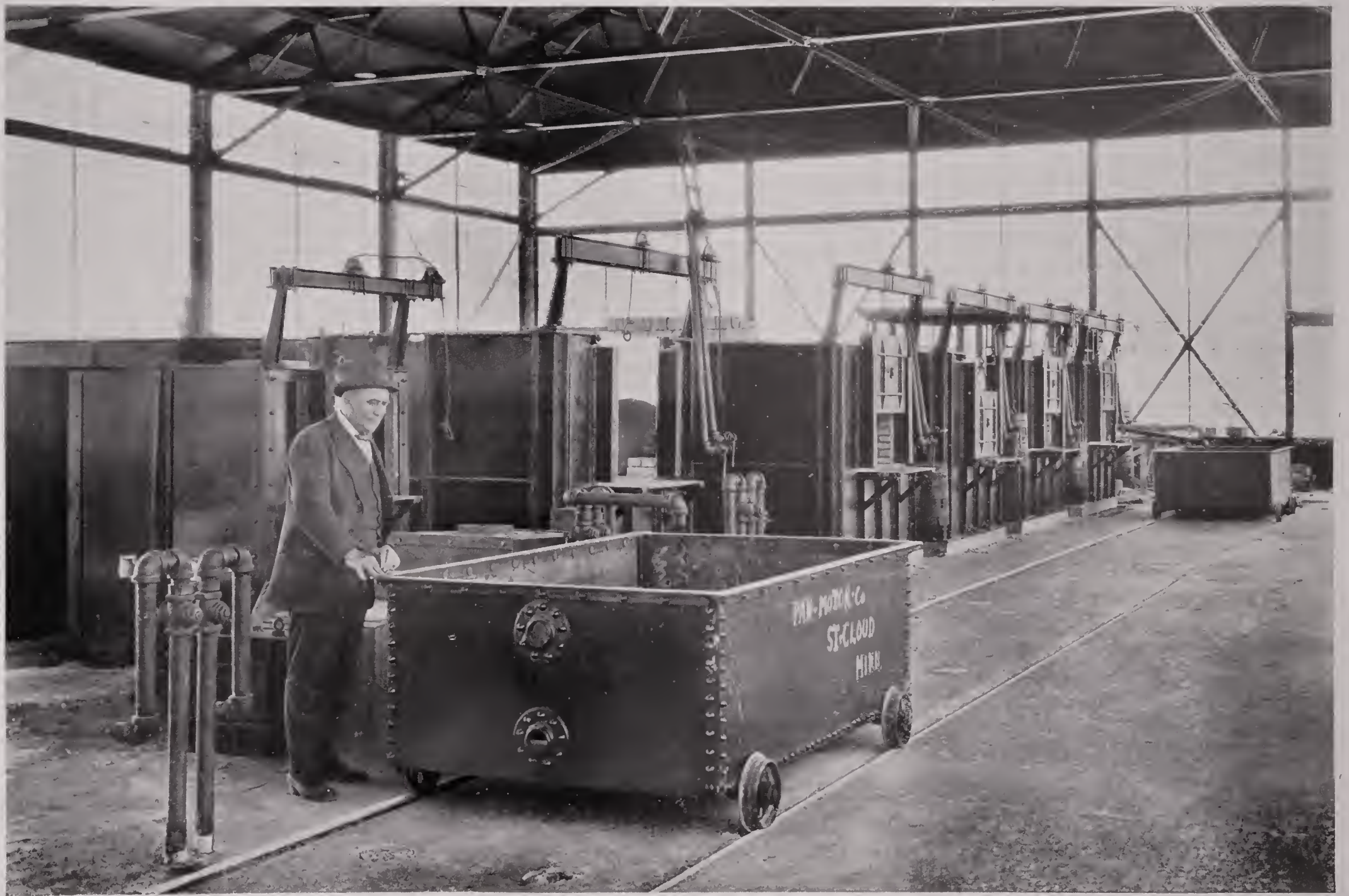

ANOTHER VIEW OF THE HEAT TREATING OVENS

Tank cars running on tracks along the line of ovens make the handling of the quenching fluids, oil and water a comparatively simple matter in the Pan Heat Treating Plant.



EAST SIDE OF DROP FORGE PLANT

Saint Cloud—Home of the Pan—Continued from page 126

the year round and the cold is not as biting as it is at many points further south. The winters are by no means severe and medium weight clothes are sufficient for comfort under all ordinary circumstances. In other words, the climate is ideal for health, cold enough in winter to make one's blood circulate properly and warm enough in summer to open the pores of the skin and permit the comfortable use of the lightest apparel.

#### Excellent Transportation Facilities (See Chart "A")

Saint Cloud is the railroad center of the Upper Mississippi country, sixty-five miles northwest of the Twin Cities. It is 139½ miles by rail from Duluth and only 283 miles by rail from Sioux City, Iowa. It is on the main line of two great transcontinental systems—the Great Northern and the Northern Pacific, both of which roads operate through trains from Chicago to the coast, which pass through Saint Cloud daily. It is the midway station on the Great Northern Sioux City-Duluth line, giving direct rail and water connection with Lake Superior and eastern Canadian points. This easy access to the head of the lakes is highly valuable owing to the fact that it means cheap transportation to all points



THE DROP FORGE OFFICE BUILDING



ONE OF THE FORGE SHOP FURNACES

in the Northeast and the seaboard. The line to Sioux City gives Saint Cloud direct connections with the great Southwest, one of the richest markets in the world, while the two main lines of the Great Northern and the Northern Pacific extend to the Pacific coast, putting Saint Cloud in direct touch with intervening states and the Canadian Northwest. Saint Cloud is the hub of seven main and branch lines and direct connection is made with Winnipeg, International Falls and other points north. Two trunk lines supply service between Saint Cloud and the Twin Cities, where direct connection can be made with seven of the country's greatest railroads, reaching out in all directions, east, south and west.

Direct lines to the north put Saint Cloud in immediate touch with the great forests of the state and the products of the big lumber mills are received here at a minimum transportation cost, an item of the greatest importance to manufacturing enterprises using lumber of various kinds in their product. This is also true in regard to the iron mines and the great steel mills at Duluth. Saint Cloud, by means of short, direct transportation, has iron and steel at its very door, being from one to two thousand miles nearer the source of supply than any of the manufacturing cities of the East.

Continued on page 132



STEAM BOILER PLANT OF DROP FORGE DEPARTMENT

In here are housed the big boilers that will furnish power to the hammers. The big self supporting stack shown under construction will carry the smoke from underneath the boilers instead of from above.

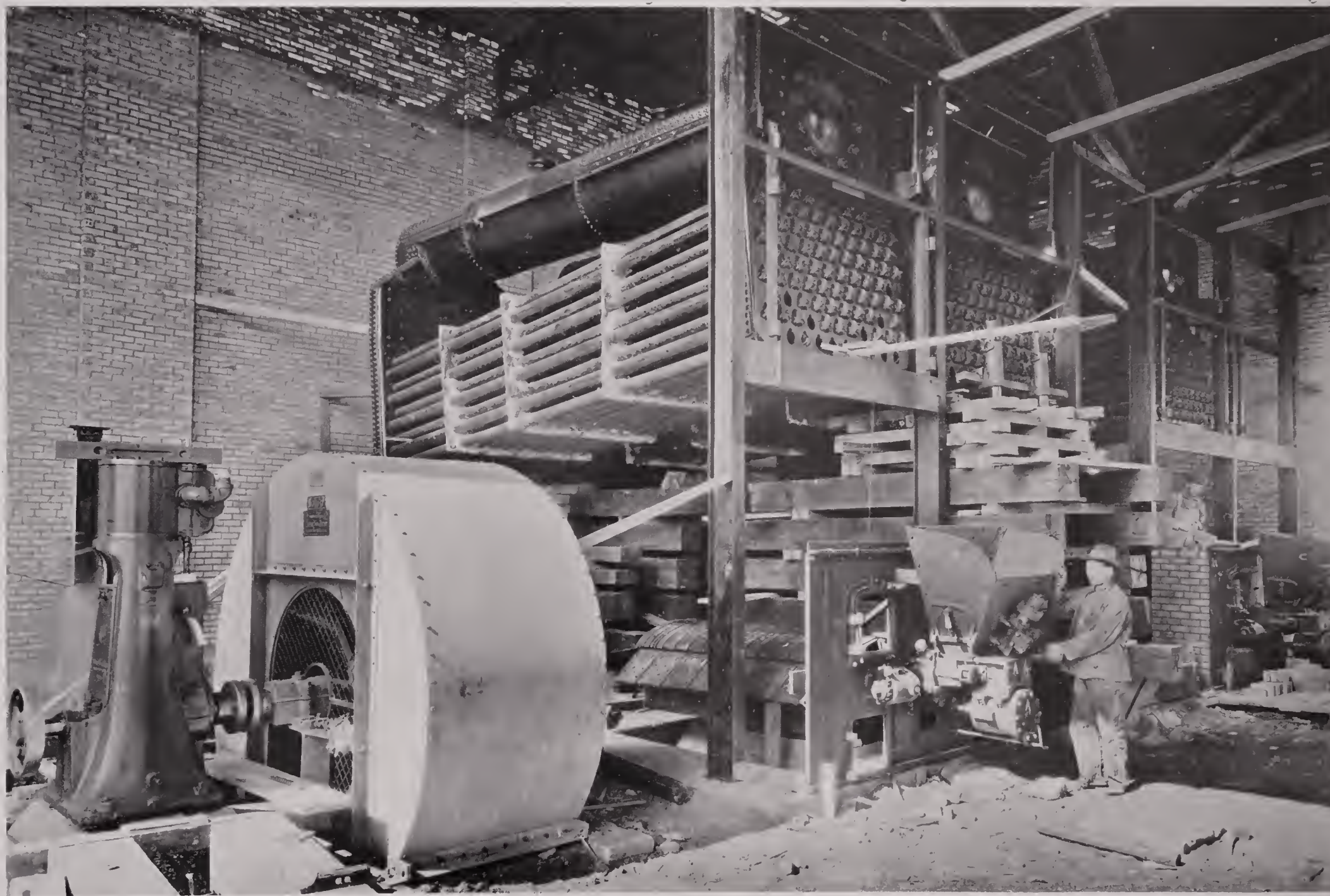

INSIDE THE DROP FORGE BOILER PLANT

This photograph taken during the installation of the plant's equipment shows the three big boilers that will furnish the steam to drive the hammers, also the steam-driven blower.



THE FORGE PLANT GROUP FROM THE WEST

From right to left are shown the following units: Die shop, office building, oil storage building, heat treating plant, laboratory building and main forge shop. The forge power plant is located on east side of forge shop and does not show in this photograph.

Saint Cloud—Home of the Pan—Continued from page 129

It is only seventy miles over the Jefferson Highway from Saint Cloud to the head of navigation on the Mississippi at Minneapolis, and inasmuch as water transportation on the Mississippi river is to be more fully developed in the near future Saint Cloud enterprises, by reason of a short haul to the river and cheap boat transportation, are within easy reach of the rich markets in the Mississippi valley, as well as those of the far South.

Thus it is that Saint Cloud has unsurpassed railroad and transportation facilities, enabling manufacturers and producers to reach all outside markets on direct lines and at favorable rates. A city that is ambitious to become an industrial center can have no greater magnet than the facilities supplied by its railroads, its highways and its waterways, putting it within easy and cheap access to the raw materials used by the manufacturer and giving it the same outlet to the richest markets of the world for its finished product. In this regard Saint Cloud stands alone.

Continued on page 131



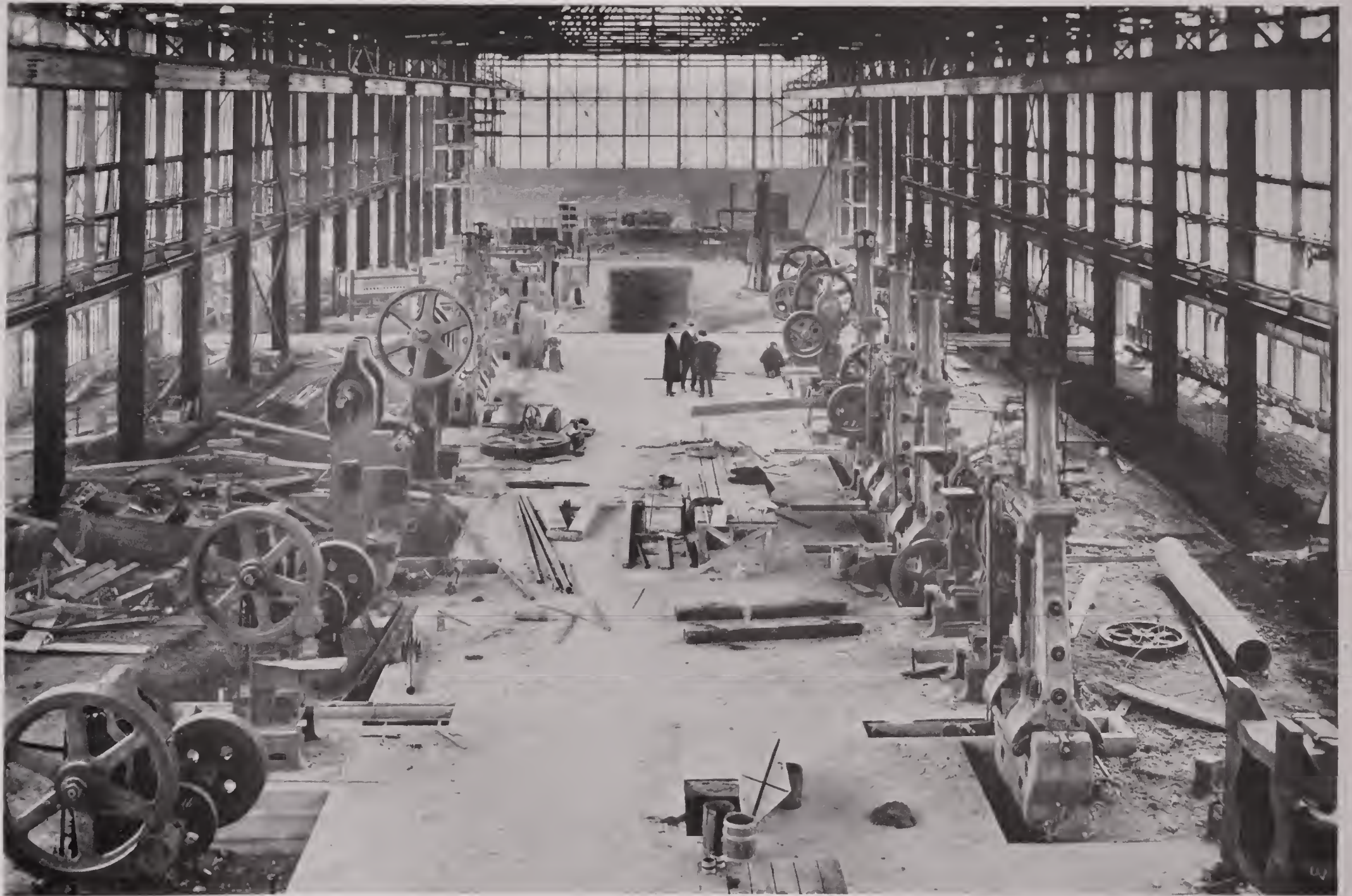

LOOKING SOUTH IN THE BIG HAMMER SHOP

This picture was taken from the ten-ton overhead crane which travels the length of the building. Here are shown several of the giant hammers and trimming presses that form a part of the equipment.

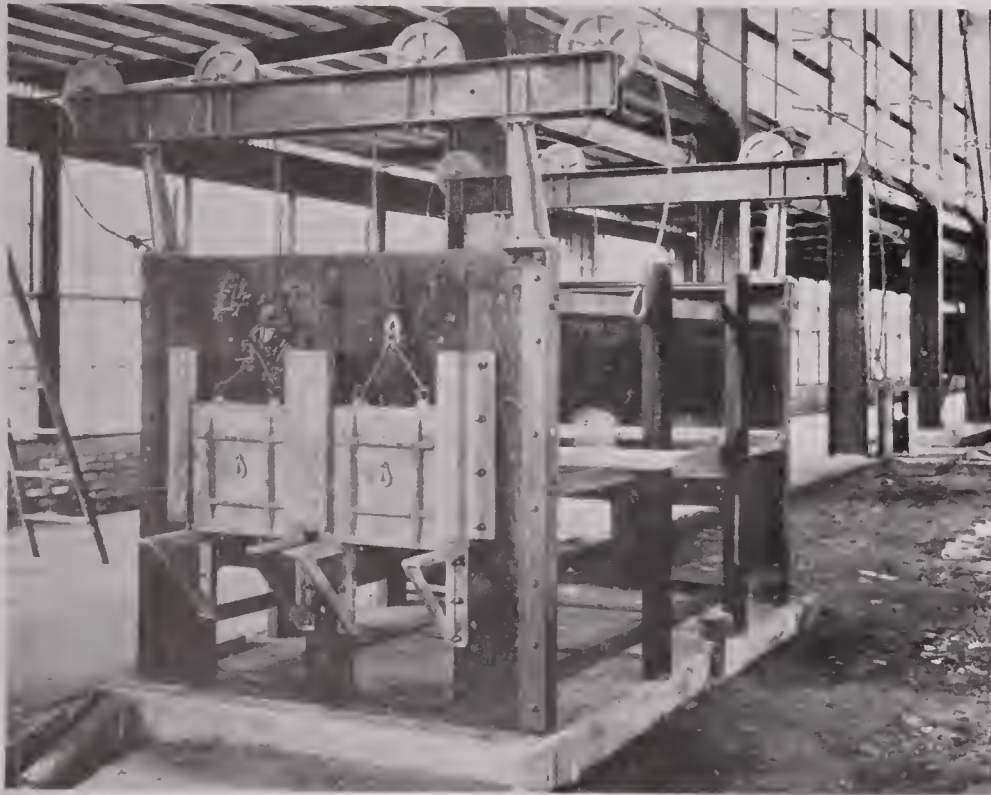

BLACKSMITH FURNACE DURING CONSTRUCTION



HEATING FURNACE AND AJAX UPSETTER

Saint Cloud—Home of the Pan—Continued from page 132

### Favorable Labor Conditions

From the standpoint of the manufacturer more favorable labor conditions could not be found. Far enough removed from the congested centers to be free from all strikes and labor disturbances and in the midst of a thickly populated country whose people are far above the average in intelligence and mechanical application, Saint Cloud has never experienced and is not likely to experience any trouble along this line. Indeed there is here at this time an almost unlimited supply of material of the best type, much of which is mechanically inclined, that can be drawn on and developed into skilled workmen as conditions demand. It may be said further that this source of labor supply is largely Scandinavian, which means that the district has, in embryo at least, a working population the superior character of which is recognized the world over. As an artisan and craftsman the Scandinavian is unsurpassed and his steady, dependable habits make of him a most reliable workman. The laboring man who comes here from other cities and other states finds conditions in the way of housing, food supplies, recreation, and

Continued on page 136

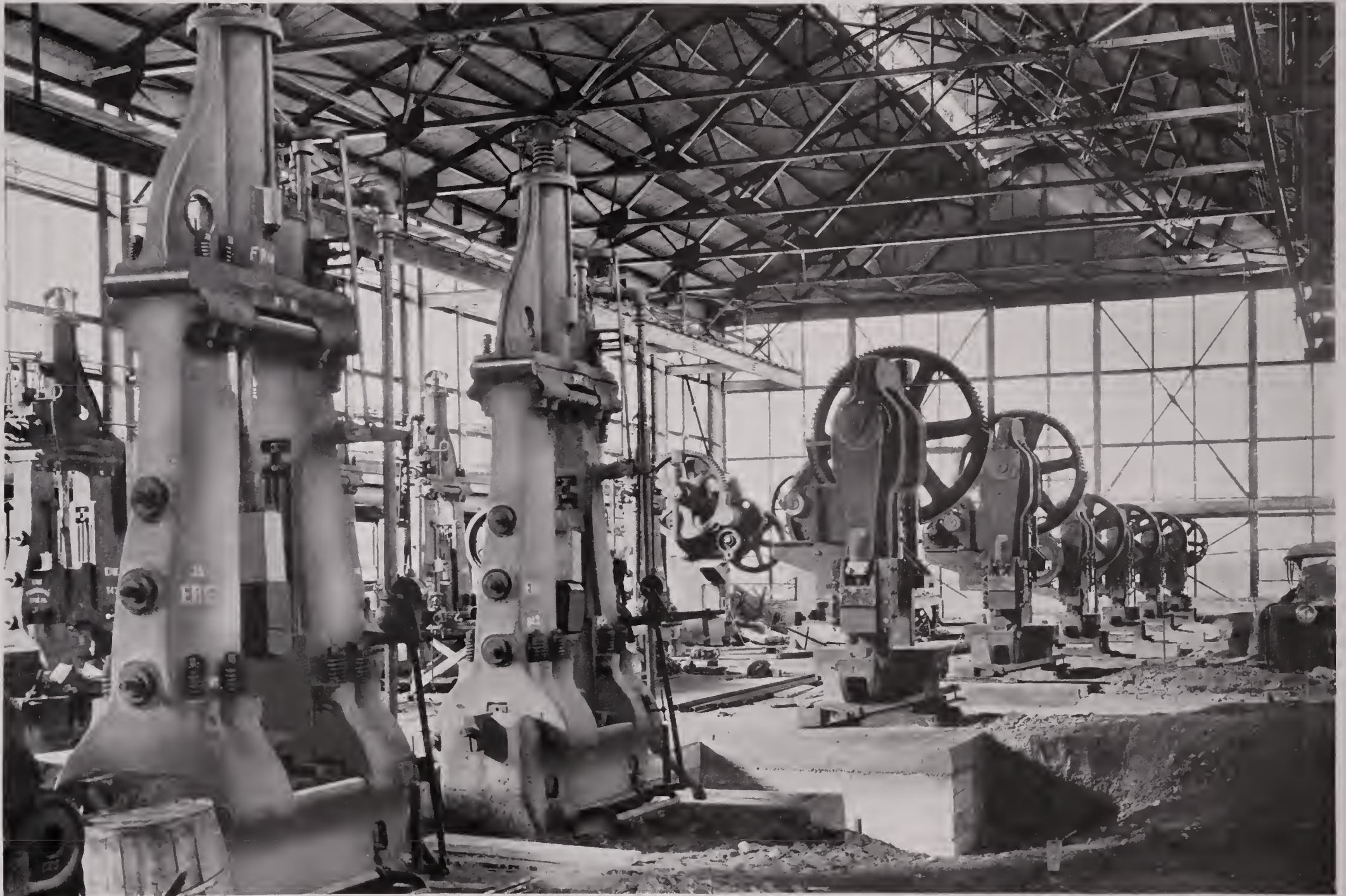

A SECTION OF THE HAMMER SHOP

Some of the giant hammers and trimmers that are lined up in two rows that run the length of the building—a formidable array of modern giants, prepared to do gigantic work.

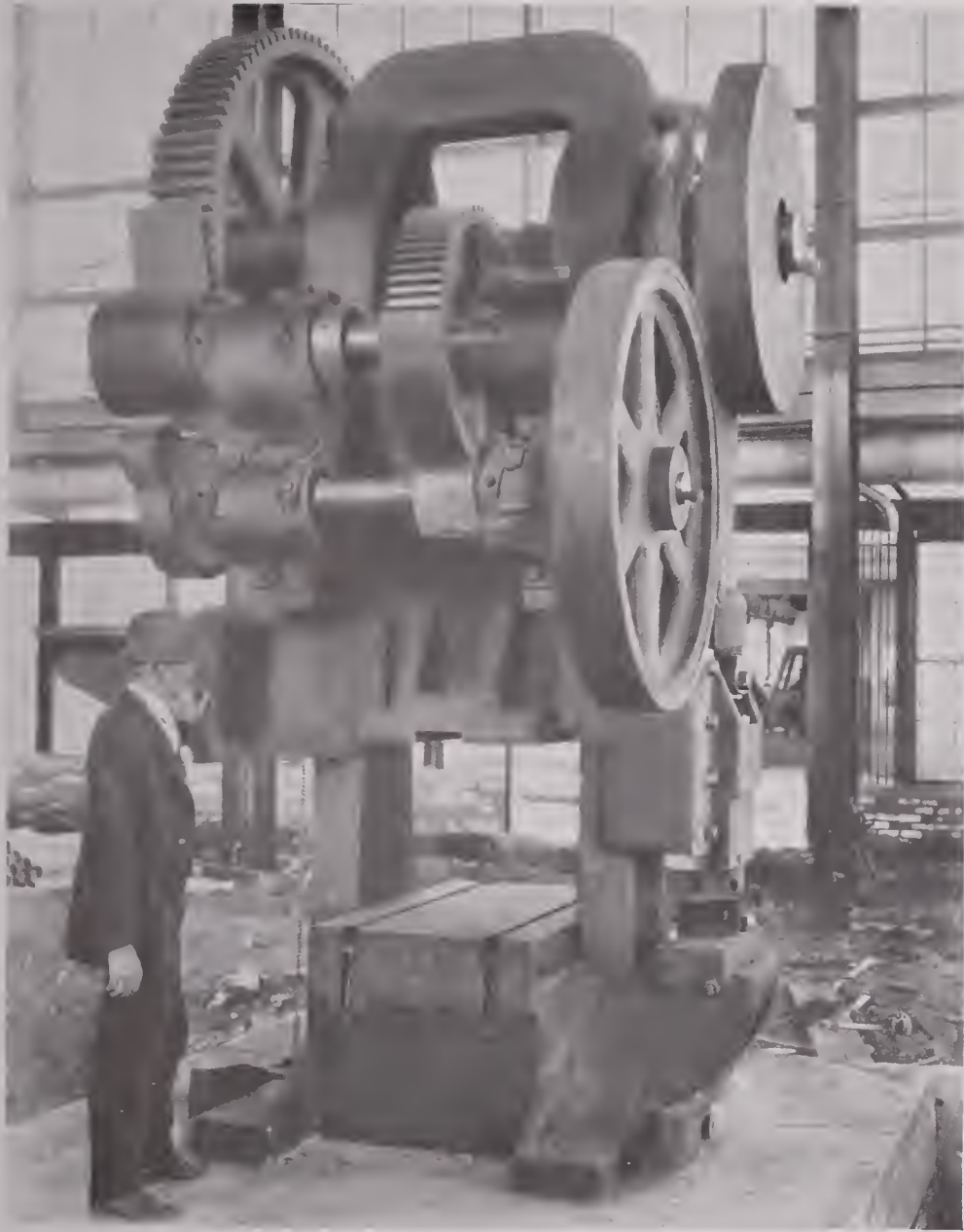

TOLEDO NO. 59 TRIMMING PRESS  
There are Two of These Machines Set Up

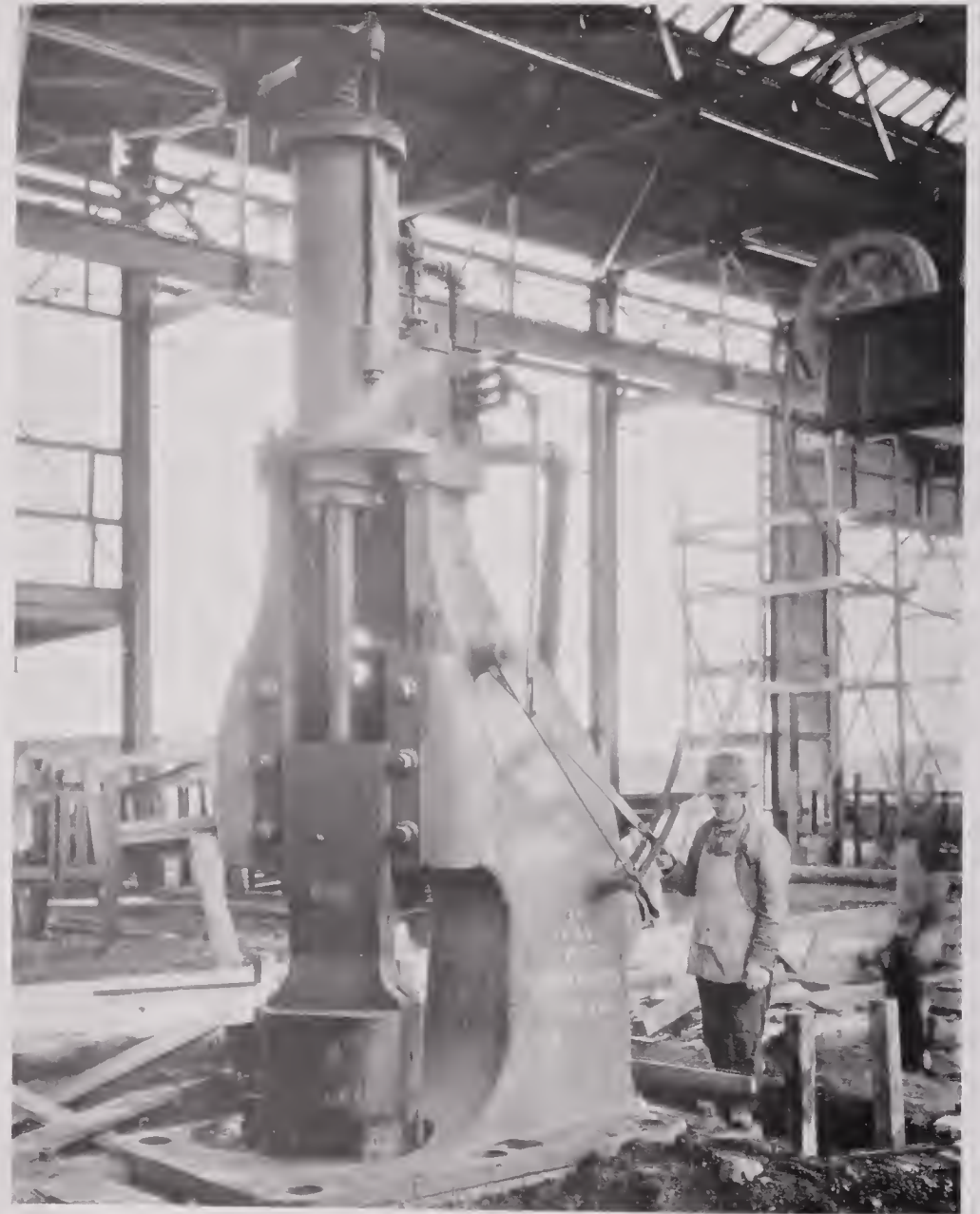

ERIE 2,000-POUND BLACKSMITH HAMMER  
Imagine It Under the Spreading Chestnut Tree

Saint Cloud—Home of the Pan—Continued from page 131

schooling for his children so far superior to those under which he existed elsewhere that he is unwilling to depart, and if need be would gladly remain in Saint Cloud at a lower wage than he might be able to obtain in a less favored locality, realizing that by so doing he would be money ahead in the long run.

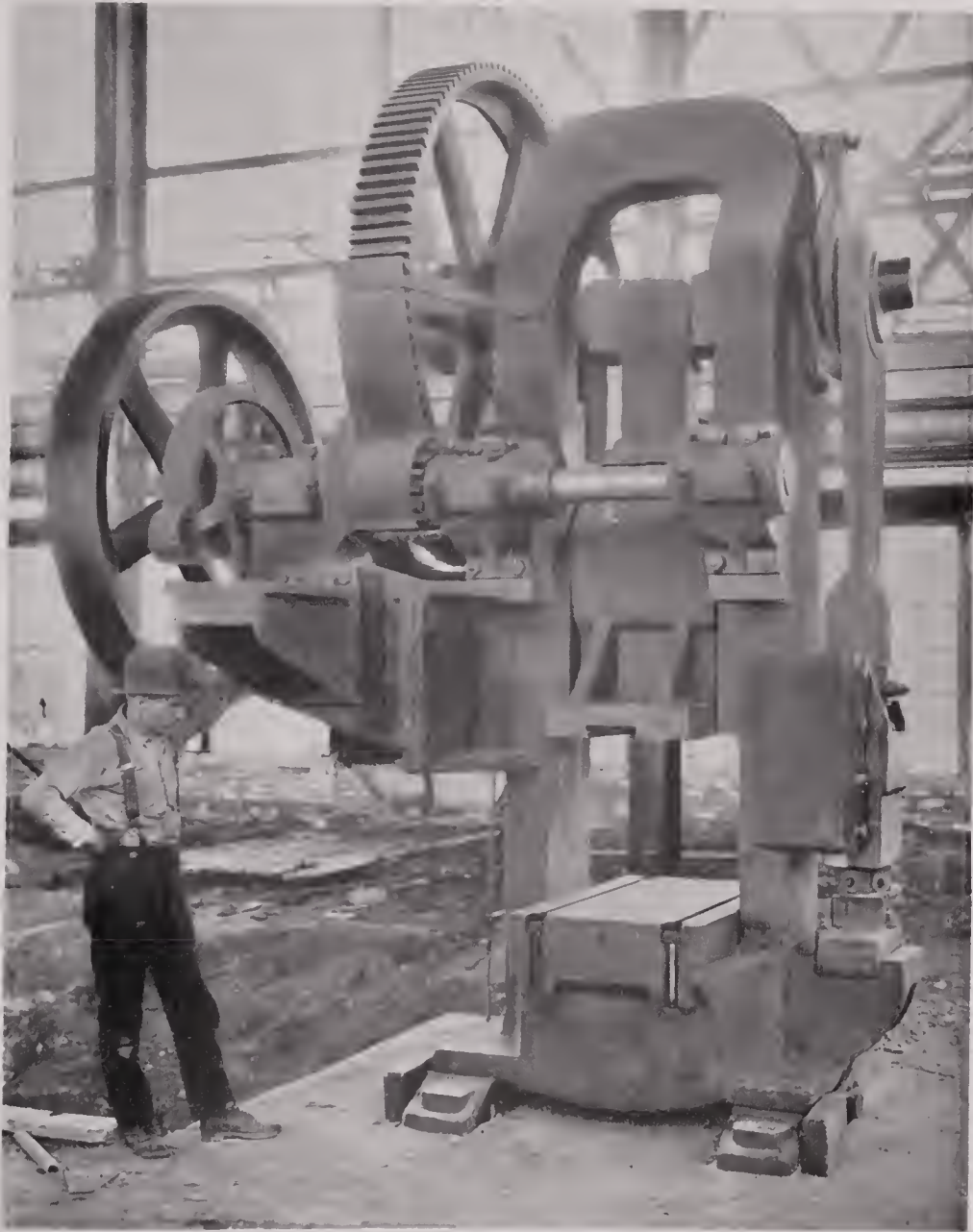

TOLEDO NO. 58 TRIMMING PRESS  
There Also Are Two of This Size Set Up

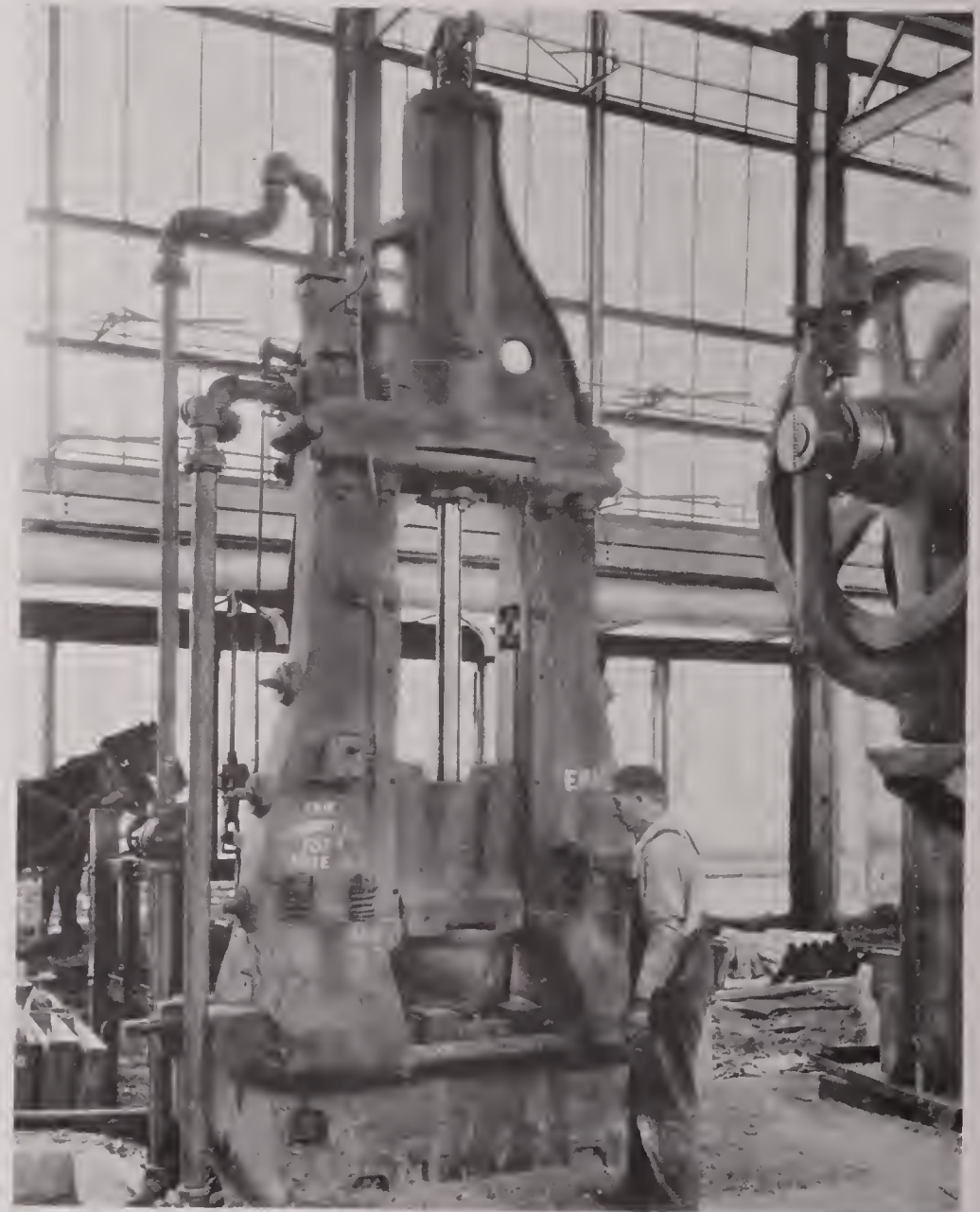

ERIE 1500-POUND FORGE HAMMER  
Four of these 1500-Pounders are in Place

What a man makes is important, but no more so than what he saves. The best place, therefore, for the mechanic, the laboring man and all who make their living with their hands or hands and brains combined, as does the skilled craftsman, is the place where labor is well paid, where rents are low, where

Continued on page 139



LOOKING NORTH IN HAMMER SHOP

This picture was also taken from overhead crane. Note the tunnel which runs beneath the floor the entire length of the shop—where the steam, oil and water pipes are located.

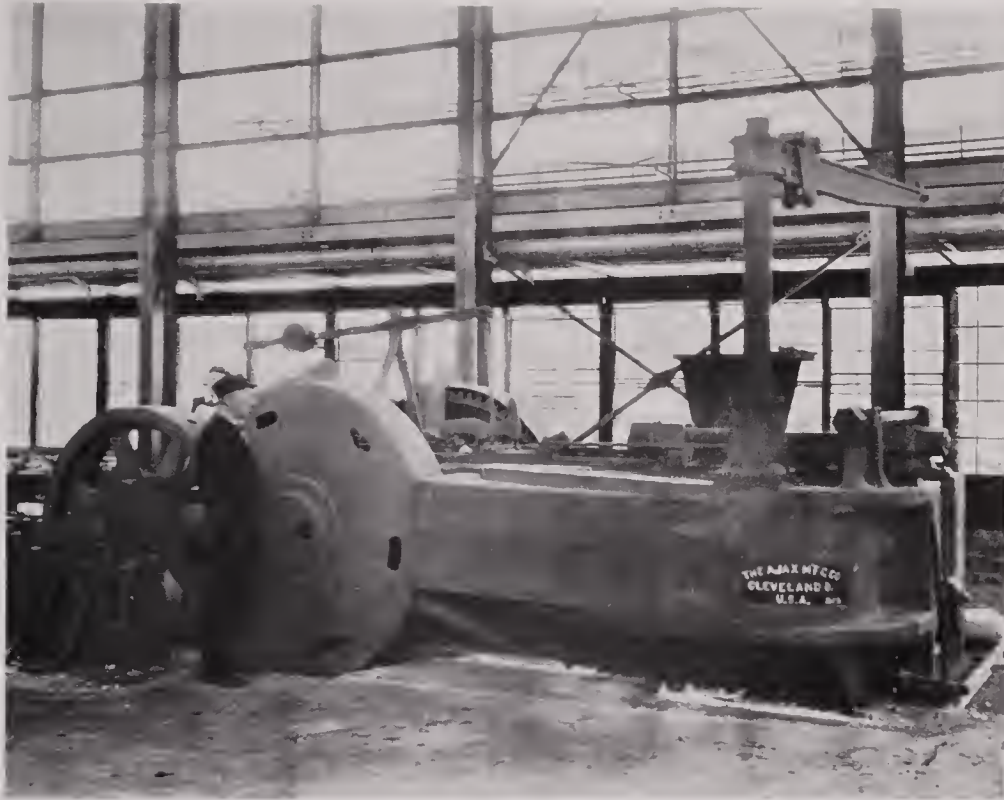

ONE OF THE AJAX UPSETTERS  
"A Hammer Lying Down"—Shoves Instead of Pounding



10-TON CRANE FOR WAREHOUSE  
This is a Duplicate of the Hammer Shop Crane

Saint Cloud—Home of the Pan—Continued from page 137

the food supply is ample in quantity and reasonable in price and where all other conditions make for health and comfort. Such a place is Saint Cloud, and the fact that it is such a place precludes the possibility of any labor shortage or labor trouble of any kind.

### Minnesota Iron Mines Greatest In World

Minnesota is a portion of a mining province known as the Lake Superior District, comprising the states of Michigan, Wisconsin and Minnesota. In 1917 this district produced 61,437,003 gross tons of iron ore, 97 per cent of which went down the Great Lakes to American and Canadian furnaces. Thirty-four million gross tons of pig iron were made from this output, which is 85 per cent of the entire pig iron output of the country. Fifty-two per cent of this ore is mined by steam shovels from great open pits; 48 per cent from underground mines. The ore at present is valued at \$5.50 to \$6.25 per ton when delivered at lower lake ports.

Continued on page 111

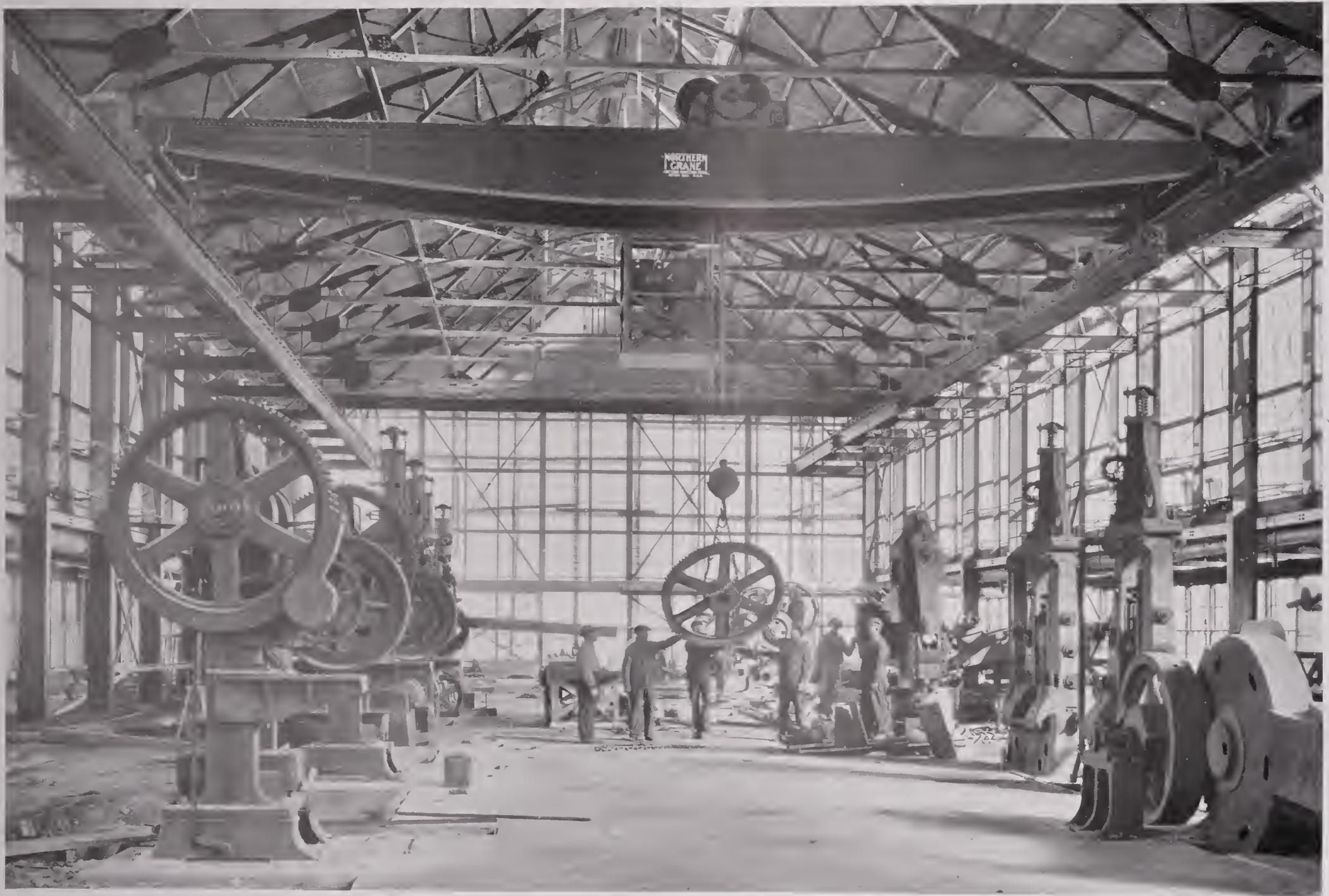

THE 10-TON OVERHEAD CRANE IN HAMMER SHOP

This giant carrier is electrically operated—Its large capacity enables it to handle the heavy machinery, material, etc., direct from railroad car to any part of the shop.



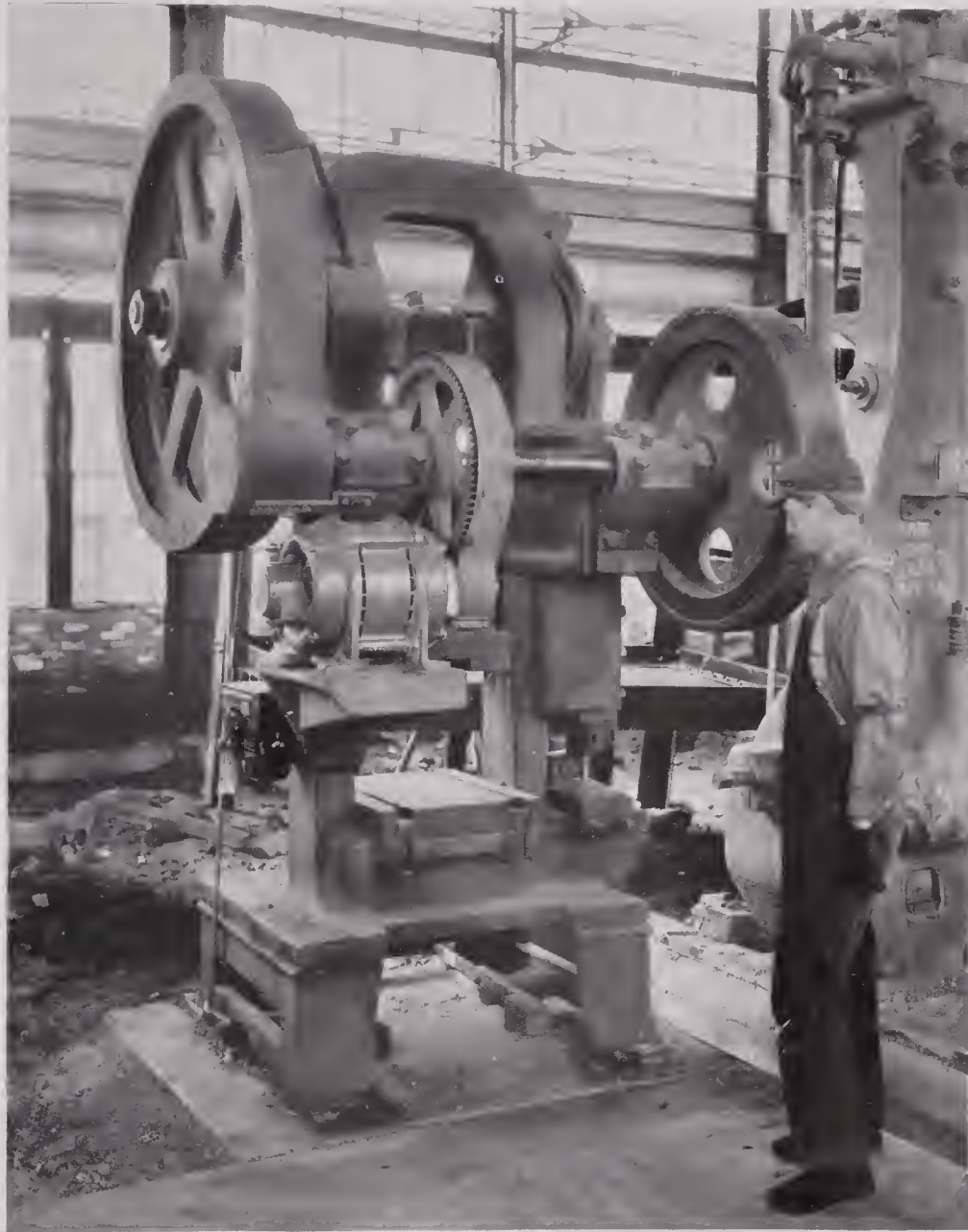

TOLEDO NO. 55½ GEARED TRIMMER  
All Trimmers are Electrically Driven

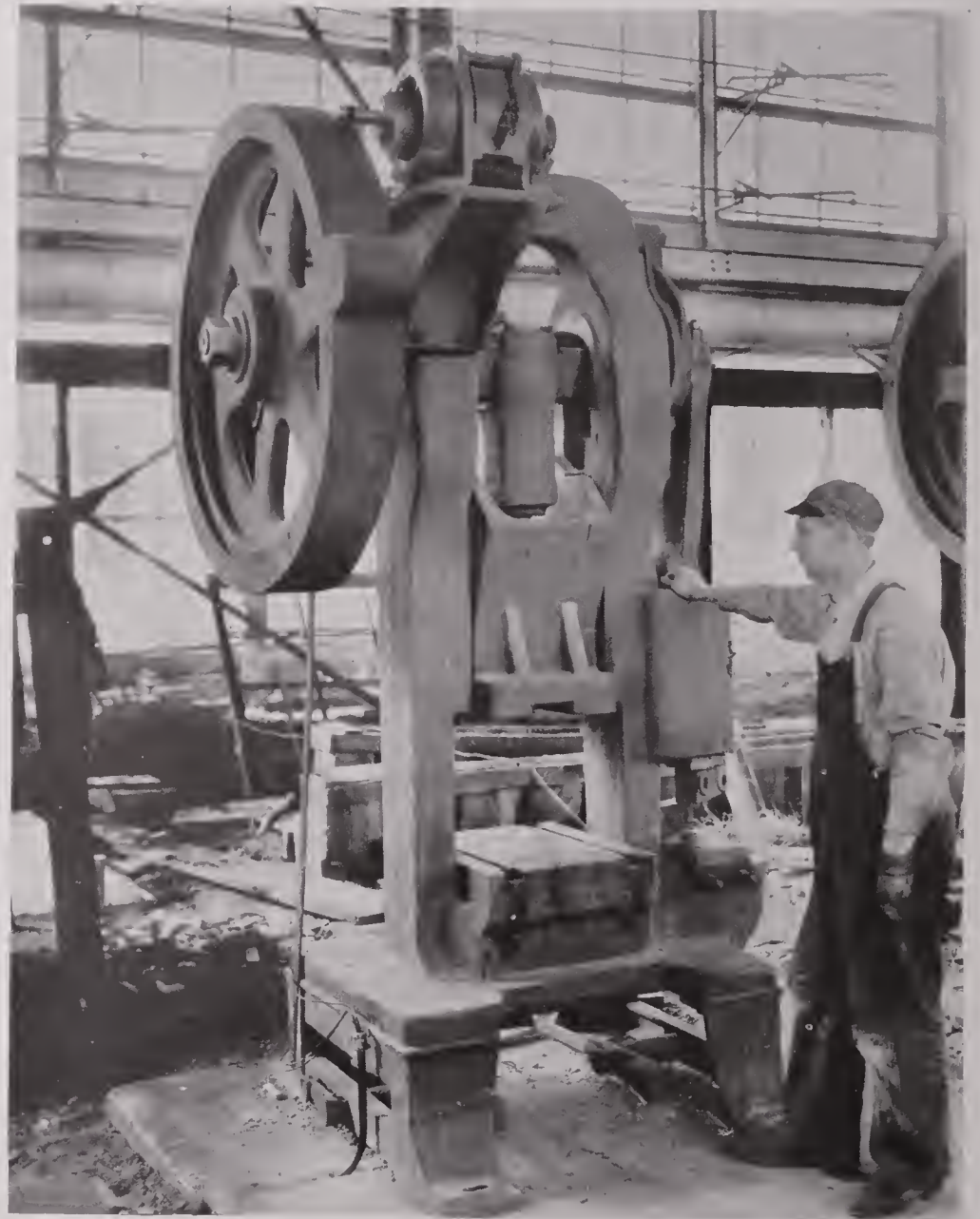

TOLEDO NO. 55½ TOGGLE TRIMMER  
Two of These are Ready for Operation

In the Lake Superior District it is estimated that there are about 1,600,000,000 tons of iron ore in reserve, containing more than 50 per cent of metallic iron; in addition there is a large tonnage of lower grade material, comparable in metallic content with the iron ores of Great Britain. The production

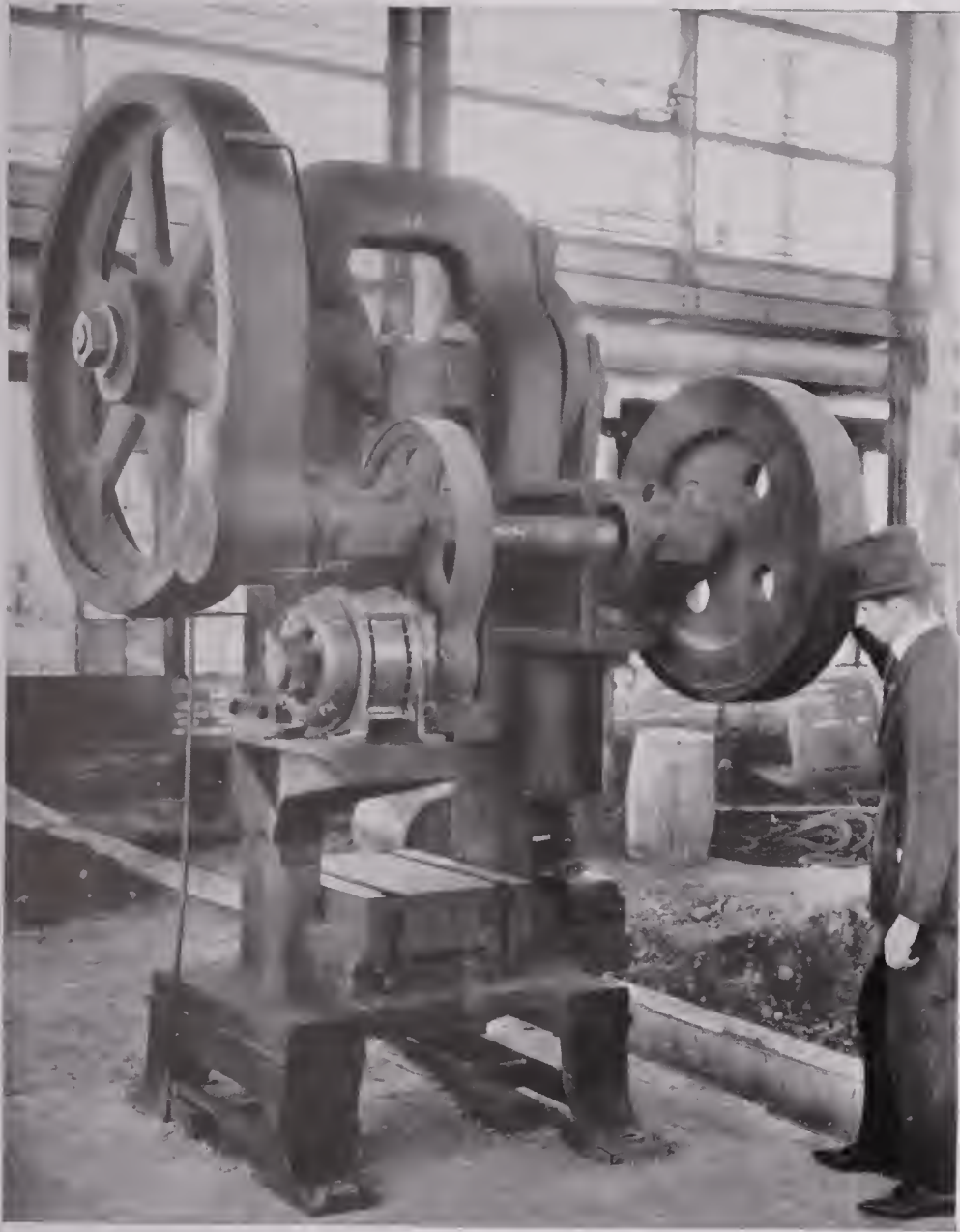

TOLEDO NO. 56 TRIMMING PRESS  
Four of These are on Their Foundations

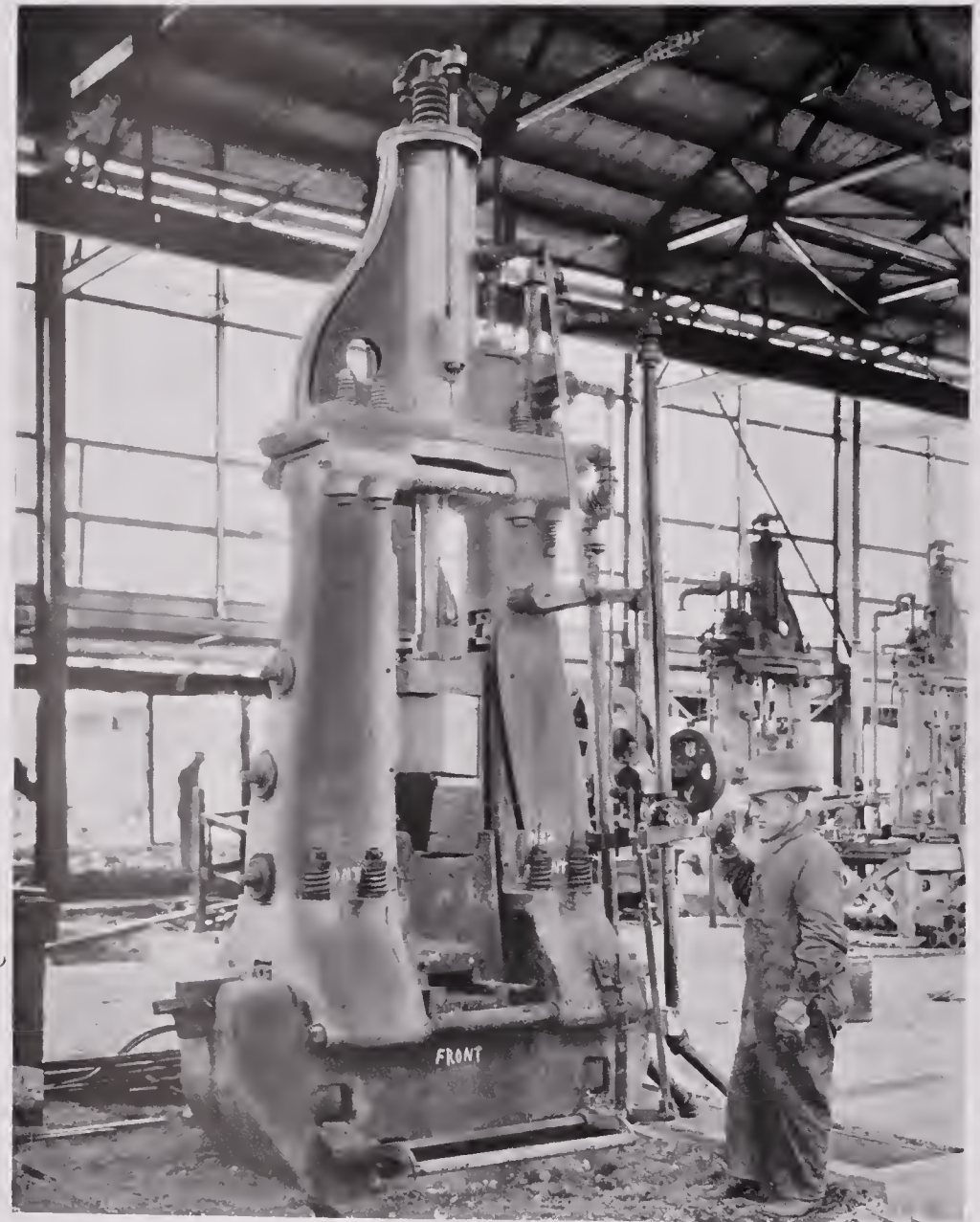

ERIE 1,000-POUND FORGE HAMMER  
The 1,000-pounders Set Up Number Two

of iron ore from the Lake Superior District is expected to exceed 100,000,000 gross tons during the present year. A new record of iron ore production in Minnesota for the present year has been announced by State Auditor J. A. O. Preus, who says that the season's output from state-owned mines alone will be

Continued on page 148



WHERE WATER SUPPLY IS LOCATED  
Forge Steam Plant to be Fed From Underground Tank



110 TONS OF RAW STEEL FORGING BARS  
Approximately Million and a Quarter Pounds Received to Date

The Drop Forge Plant—Continued from page 100

approximate capacity of the plant when fully complete will exceed 1,500,000 pounds of forgings a month working only one shift. All but two of the huge concrete foundations, some of them reaching 30 feet underground, are in and ready for the setting of the hammers to come. These foundations are topped with “cushions” of solid oak timbers, to withstand the tremendous shocks from the hammers. Practically all of the trimming presses, one for every hammer, are set up and ready for operation, as are also the two great upsetting machines.

Like in the die shop and forge shop the several other units of the plant impress the visitor with their up-to-dateness and size. Everywhere one sees evidence of the foresightedness, skill and energy displayed by the builders. For instance, the company did not confine itself to only half-ton, one-ton and two-ton hammers in equipping its forge shop. It added four-ton and six-ton giants to its equipment, knowing that in the making of the larger forgings there was the making of greater profits. It did not follow precedent in building its heat-treating furnaces. It knew that they could be built better



so its heat-treating experts went ahead and designed and built a better type. They cost more, but the additional cost is dwarfed into insignificance when compared with their greater efficiency and the better quality of forgings that can be turned out. There are a great many other examples of progressiveness to be found that will impress the layman as well as the technical expert.

A glance at the many photographs of buildings, machinery and equipment as shown in this book combined with the following list of machinery ordered and to form part of its equipment will give the reader a fair idea of how surprisingly big is just one of the many departments of the Pan Motor Company.

### List of Machinery and Equipment Ordered for the Various Units of the Drop Forge Plant in Addition to That Which is in Place as Compiled from Purchase Records on Nov. 15, 1918.

- |  |   |
|--|---|
| 1 Three-Ton Traveling Crane, Euclid standard, three motor, floor operated, variable speed control.   | 1 12-inch Platinum Thermo Couple, protected over the lower 6 inches with quartz tube and furnished complete with bracket support for furnace. |
| 1 Solenoid Braker.   | 1 18-inch Base metal Thermo Couple insulated and protected over lower 8 inches with nickel Chromium tubes.                                    |
| 2 12000-pound Erie Steam Drop Hammers.   | 2 15-foot lengths of compensating leads, each connected to 25 feet of double conductor copper wire.   |
| 4 2000-pound Erie Steam Drop Hammers.  | 12 Automatic Signaling Pyrometers range 0° to 1200° F.  |
| 2 3000-pound Erie Steam Drop Hammers.  | 12 Automatic Switches for operating signal lights.  |
| 2 8000-pound Erie Steam Drop Hammers.  | 12 Batteries of 3 colored lights complete with sockets mounted on frames.   |
| 2 4000-pound Erie Steam Drop Hammers.  | 12 24-inch Nickel Chromium base metal thermo couples.   |
| 1 Long & Alstatter size "F" Guillotine type bar shear. Having capacity to shear 4 inch square bars.  | 12 12-inch Nickel Chromium protecting tubes for above thermo couples.   |
| 1 Pond 42 inch x 42 inch x 14 feet Planer with 2 heads on cross rail and with two side heads.  | 12 15-foot lengths compensating leads to carry the cold junctions away from furnaces.   |
| 6 Norton No. 831593 Grinding Wheels size 5x1½x1½ Grain 46 Grade K Face Record CEB land 1.  | 1 Brown Automatic Signaling Pyrometer range 0°-2000° F. for Cyanide furnace.  |
| 1 Brown High Resistance Pyrometer, type II. Fig. 19 with double scale 0° to 1600° F. For Base Metal couple scale 0° to 3000° F. for Platinum Thermo couple for High Speed Steel treating with four point rotary switch and case 52 and 58. | 1 Automatic switch and battery of three lights.   |
|  | 1 Angle type of nickel Chromium thermo couple 12x24 inch.   |



- 1 12-inch pure nickel tube for protection to above thermo couple.
- 1 length 15 feet compensating lead.
- 1 Automatic Signaling Pyrometer for lead pot.
- 1 Automatic Switch and Battery of three lights.
- 1 12x24 inch Nickel Chromium base metal thermo couple.
- 1 12-inch Nickel Chromium protecting tube for protection to above.
- 1 15-foot length compensating leads.
- 1 125-K. V. A.—G. E. Transformer Type II.—2200—Primary 220-440 volt Secondary Complete with Oil.
- 1 Trimmer Miller.
- 1 25-K. V. A. Single phase type II. Transformer, 60 cycle, with the following ratio: 2200—110-220 2300—115-230 2400—120-240. Complete with transil oil.
- 1 28-inch "Superior" Vertical Milling Machine complete with taper attachment.
- 1 Coal Handling bridge, including two clam shell buckets.
- 1 Complete track switch complete with all necessary current conducting materials.
- 1 4000-pound capacity cage operated Electric Hoist.
- 1 No. 134 Single Stage Centrifugal Air Compressor outfit complete.
- 1 Pratt & Whitney No. 4 Die Sinking Machine with regular equipment.
- 1 16-inch x 10 feet Pratt & Whitney Quick Change Gear Tool Room Lathe with regular equipment.
- 1 2-inch Acme Single Bolt Cutter complete with Pump, Countershaft Wrenches, and Automatic Attachment.
- 1 4-inch Acme Single Bolt Cutter complete with Pump, Countershaft Wrenches, and Automatic Attachment.
- 1 24-inch Gould & Eberhard High Duty Shaper with Gear Box, selective type all case hardened gears, vise and wrenches, but without countershaft.

- 1 Mono Rail Track with Switch.

#### 132 Items for Chemical and Physical Laboratory

- 1 75 H. P. Slip Ring Type Motor 440 V. 3 phase, 60 cycle, complete with drum type controller and resistor.
- 1 "Toledo" No. 59 $\frac{3}{4}$  Forge Trimming Press.
- 1 50,000-pound capacity Olsen new three screw type direct motor driven Universal Testing Machine with automatic beam.
- 1 Lewis Hayes Type Extensometer.
- 1 Olsen Hydraulic Brinell Hardness Testing Machine No. 2 with Misiascope.
- 1 Double Pointed Center Punch. 2 inch Ga.

#### Additional List for Other Units of Plant

- 1  $\frac{1}{2}$ -inch Extra Heavy Steam Trap of Sarco Thermostatic design. For Elect. Con. Stores.
- 1 LeBlond Lathe. Factory No. 2.
- 1 Taper attachment for same. For Factory No. 2.
- 1 Draw-in attachment with eight collets. Factory No. 2.
- 1 14-inch 8 foot Bed Lodge & Shipley 3 steps cone drive Engine Lathe with regular equipment. Factory No. 2.
- 1 12-inch 4 Jaw Independent Lathe Chuck. Factory No. 2.
- 1 Pratt & Whitney List No. 305 side mill cutter. Factory No. 2.
- 1 La Pointe No. 2 Broaching Machine. Factory No. 2.
- 1 La Pointe No. 3B Broaching Machine. Factory No. 2.
- 1  $\frac{5}{8}$ - $\frac{7}{8}$  Cleveland Model "A" Automatic Threading Machine with tools and attachments. Factory No. 1.
- 2  $\frac{3}{8}$ - $\frac{1}{2}$  Cleveland Model "A" Automatic Threading Machine with tools and attachments. Factory No. 1.
- 1  $\frac{3}{8}$ - $\frac{1}{2}$  Cleveland Model "B" Automatic Threading Machine with tools and attachments. Factory No. 1.



FROM THE SOUTHWEST

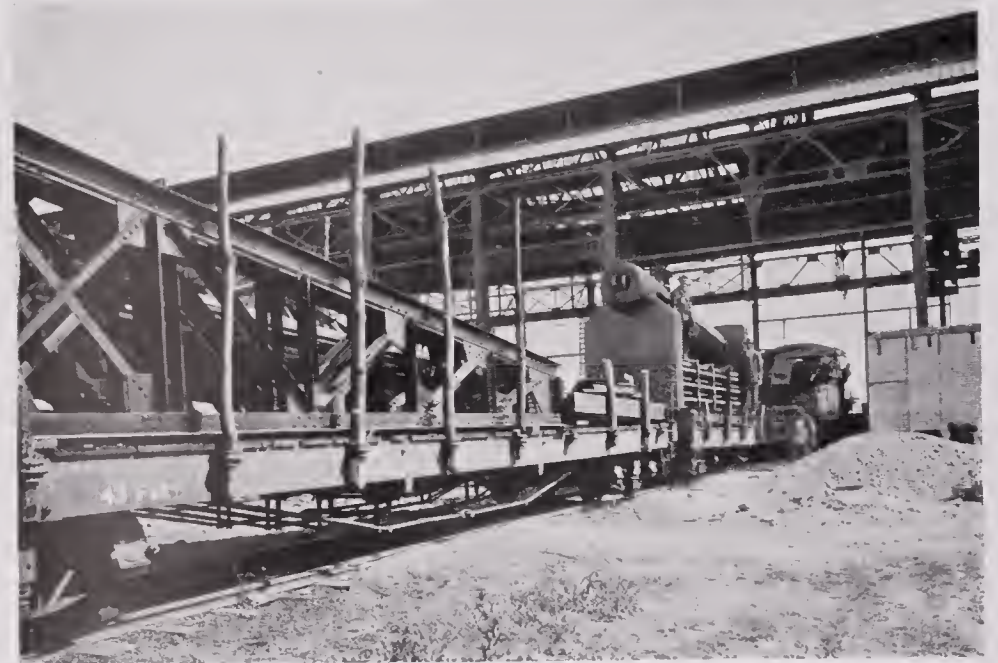

TRAINS RUN THROUGH BUILDING

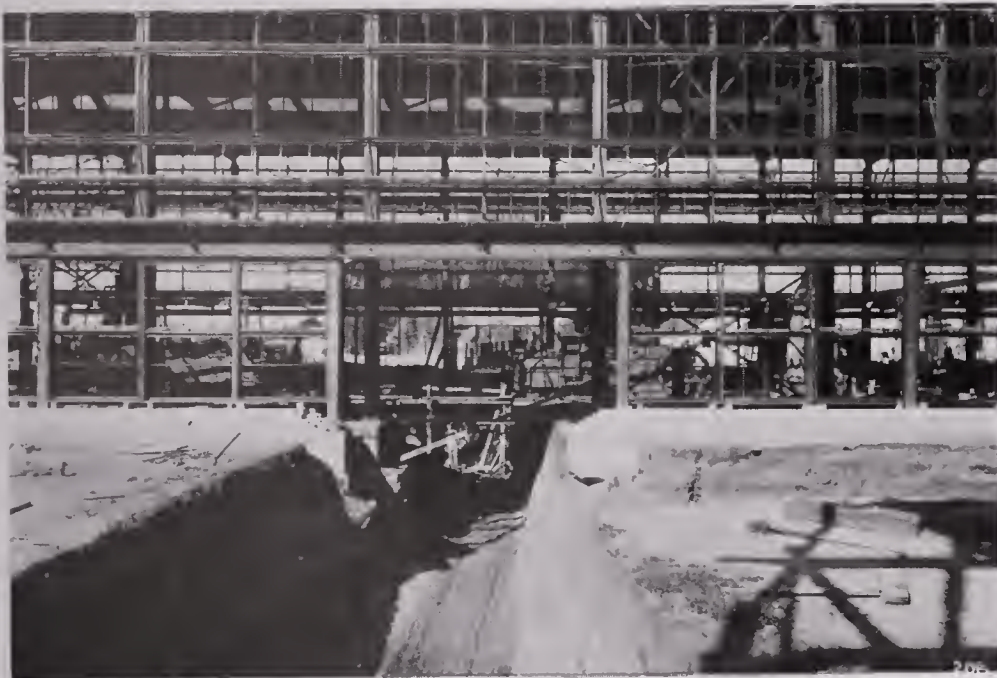

STEEL SASH IN READY FOR GLASS



FROM THE SOUTHEAST

VIEWS OF THE HAMMER SHOP DURING CONSTRUCTION



NOT A ROUNDHOUSE—JUST UNLOADING

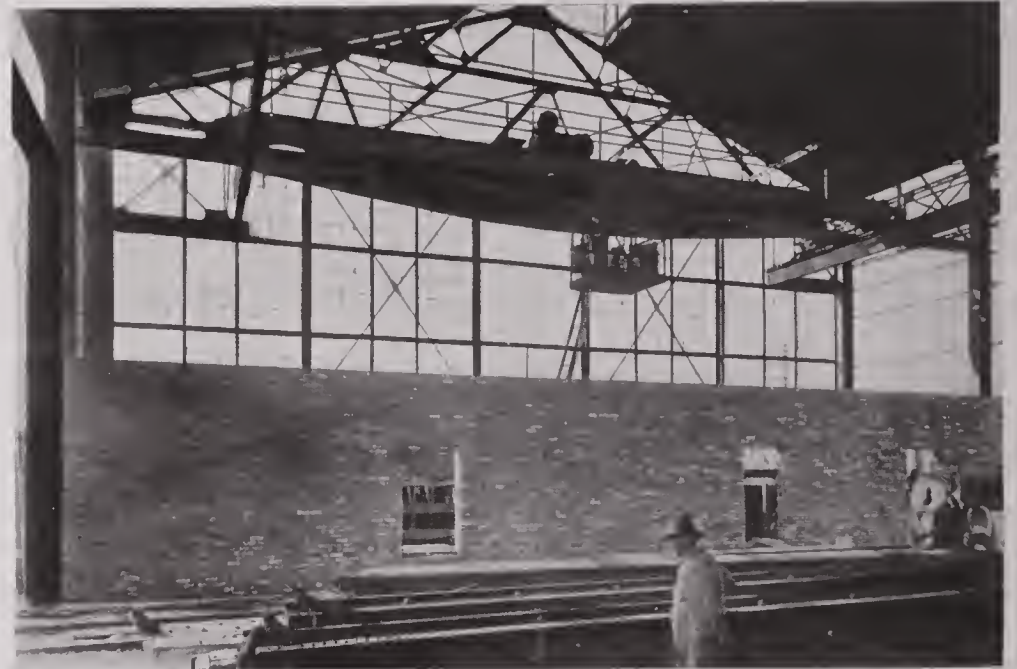

THE SCRAP BINS AT SOUTH END



FROM NORTHEAST



FROM HAMMER SHOP ROOF

VIEWS OF THE HAMMER SHOP DURING CONSTRUCTION



PLANT OF THE MINNESOTA STEEL COMPANY, AT DULUTH. (SEE CHART B.)

Representing an investment of about \$25,000,000. It has been announced that four steel fabricating plants, representing \$15,000,000 additional are soon to be built. This big steel plant is less than 110 miles from Saint Cloud. Universal Portland Cement Company's plant in foreground.

nearly 5,000,000 tons, exceeding by over a million tons the previous record. According to Auditor Preus, ore shipments from the Superior District up to the first of October had exceeded the tonnage for the entire season of 1917, which, as stated above, aggregated 61,437,003 tons and included 45,398,787 tons from Minnesota mines.

"I am confident that the state-owned mines will forward not less than 1,650,000 tons," says Mr. Preus, "and the total may exceed that estimate at the end of the season. The old record of 1916 was not broken last year because navigation was open only for a comparatively short time, there was a shortage of boats and because of other minor reasons."

The latest official reports of 1918 ore shipments from state mines, furnished by J. P. Funk of the minerals department, with corresponding figures for previous years, afford these comparisons:

1918, tons shipped, 3,650,000; 1917, 2,608,114; 1916, 2,938,083; 1915, 1,184,419.

Incidentally, the heavy shipments mean that the state will receive this year more than \$1,150,000 in royalties on ore from state-owned iron mines.

Iron is the metal of war; the substance that supplies the guns, the shells and the armor plate. No other state in the Union made a more vital contribution toward winning the war than Minnesota,

Concluded on page 150





THE LARGEST OPEN PIT IRON MINE IN THE WORLD

This picture gives some idea of the immense iron ore deposits to be found in Minnesota. This is the Shenango Mine at Hibbing, about 200 miles from Saint Cloud, the Home of the Pan Motor Co. (See Chart B.)



A TYPICAL MINNESOTA WHEAT FIELD

Saint Cloud—Home of the Pan—Concluded from page 148

with its inexhaustible store of iron and manganese ores now produced in such great quantities from the Mesaba, Vermillion and Cuyuna Ranges. The war time demand for this most essential commodity hastened the opening of two new mines on state properties which began shipment a few weeks ago, one is the Margaret on the Mesaba Range and the other the Martin on the Cuyuna Range. The biggest open pit mine in the world is the Shenango, at Hibbing, Minnesota, where huge steam shovels load the ore from the surface, affording a sight of the greatest industrial magnitude.

The manganese requirements of the steel industry of the United States before the war were met largely by imports from high grade deposits in Russia, India and Brazil. The imports from Russia and India were cut off early in the war, and the burden of production fell upon the shoulders of domestic owners and producers by reason of the United States Shipping Board transferring ships from the manganese ore trade to trans-atlantic war service; and this increased demand, imposing a gigantic task, has been faced with a smile and the manganese requirements of the nation have been promptly met, thanks to the great iron resources of Minnesota and her sister states. And all this great mineral wealth is within a few short miles of Saint Cloud, practically in the city's back yard.



## “A SERMON IN BRICKS”

**T**HE Pan Motor Company is a real institution, with real money invested. Its buildings are modern and fireproof, with up-to-the-minute machinery and equipment, of steel and concrete construction, substantial, accurate and correct in detail and harmonious throughout. Maps, drawings and photographs, appearing herein, give full details relative to their construction, arrangement and material contents. With the exception of the Experimental Building, all were planned by the Works Department of the Pan Motor Company and with the exception of the Experimental Building and Factory Building No. 2 all were erected by the Works Department.

To date, the company has expended over one and a half million dollars on buildings, machinery and equipment and all are paid for. Paying is a habit with Pan. Its plant is the best that money and men can build, comprising fifteen structures in all and covering a ground area of approximately five acres.

This modern plant, erected and equipped at a cost exceeding the total amount of the capital stock of all the banks in Stearns County, Minnesota, of which there are forty-three, is the finest and most complete of its kind in the Northwest and one of the most up-to-date in the entire country.

Besides the vast amount of money this building program has required, the physical and mental energy that has been expended is by no means small. Brains and brawn have been on the job constantly, practically day and night, since the great work was started.

The various buildings comprise the following: Experimental Building, Blacksmith Shop, Main Production Unit or Factory Building No. 2, Warehouse, Loading Platform, Main Power House, Pump House, Water Tower, Drop Forge Power House, Drop Forge Building, Die Shop, Oil Storage Building, Drop Forge Office Building, Heat Treating Plant and Laboratory.

With all these modern buildings in mind it may be appropriate to state that the real builder is one of the country's greatest blessings. The man who puts one brick on top of another is preaching a sermon—a sermon of industry, of progress and prosperity—and his work is just as essential to the life of the nation as that of the man who stands in the pulpit.

If all the bricks in all the buildings in the Pan Motor Company's plant were placed in a row, they would reach from Saint Cloud to St. Paul and back again. And yet bricks constitute a small item in the construction of many of the larger units comprising this great plant.

Continued on page 153



# PROPERTY PLAT

17 3/4 Acres

Showing Where Buildings Completed Or Under Construction Are Located

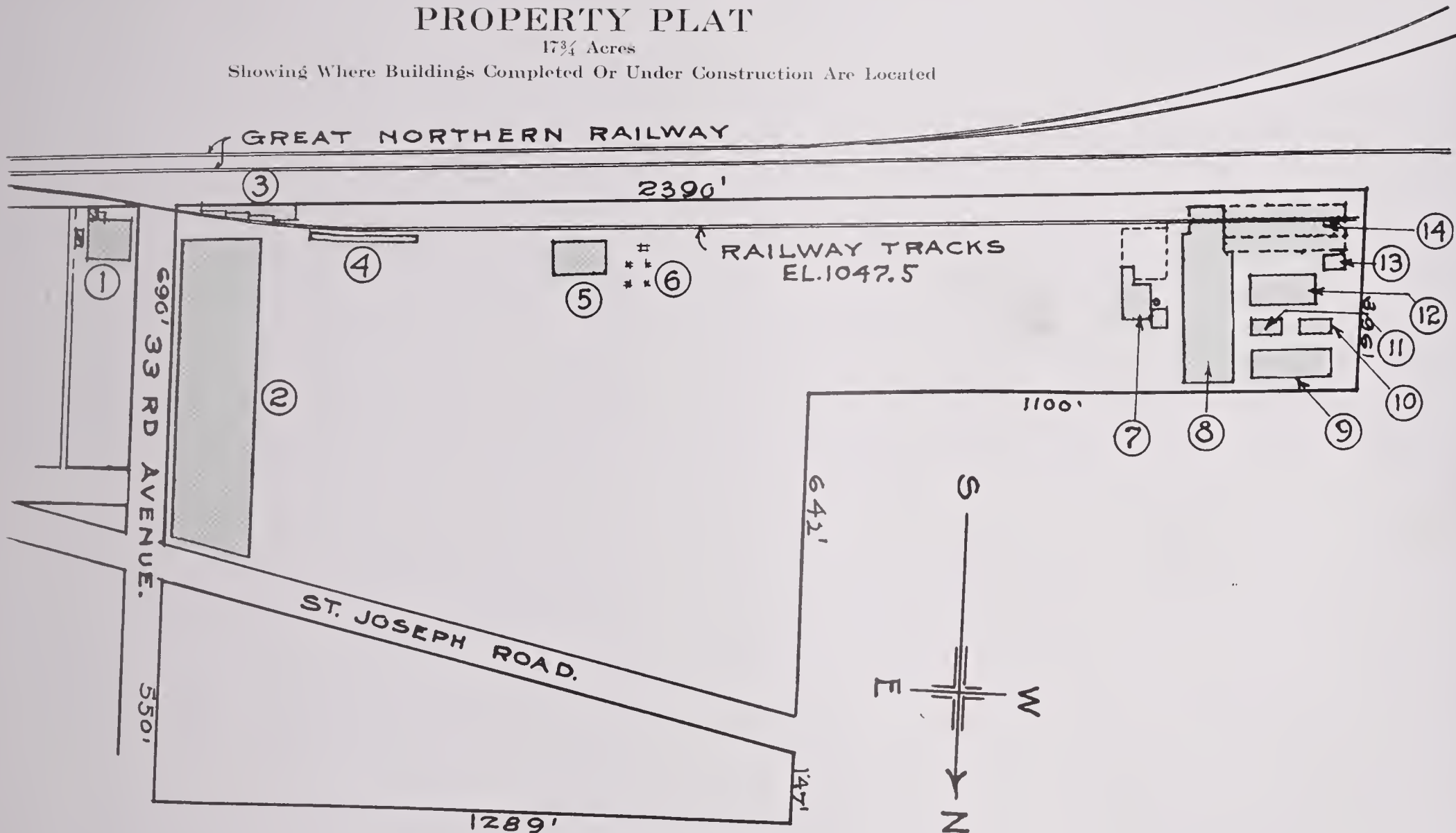

- 1—Experimental Engineering Building and Blacksmith Shop.
- 2—Factory Building No. 2.
- 3—Works Department Warehouse.
- 1—Shipping and Receiving Platform.

- 5—Main Power and Light Plant.
- 6—Water Tower and Pump House.
- 7—Drop Forge Power House and Coal Storage.
- 8—Drop Forge Hammer Shop.

- 9—Die Shop.
- 10—Drop Forge Office Building.
- 11—Oil Storage Building.
- 12—Heat Treating Building.
- 13—Metalurgical Laboratory.
- 14—Drop Forge Warehouse Site.



**GROUND PLANS**  
Works Engineering Department

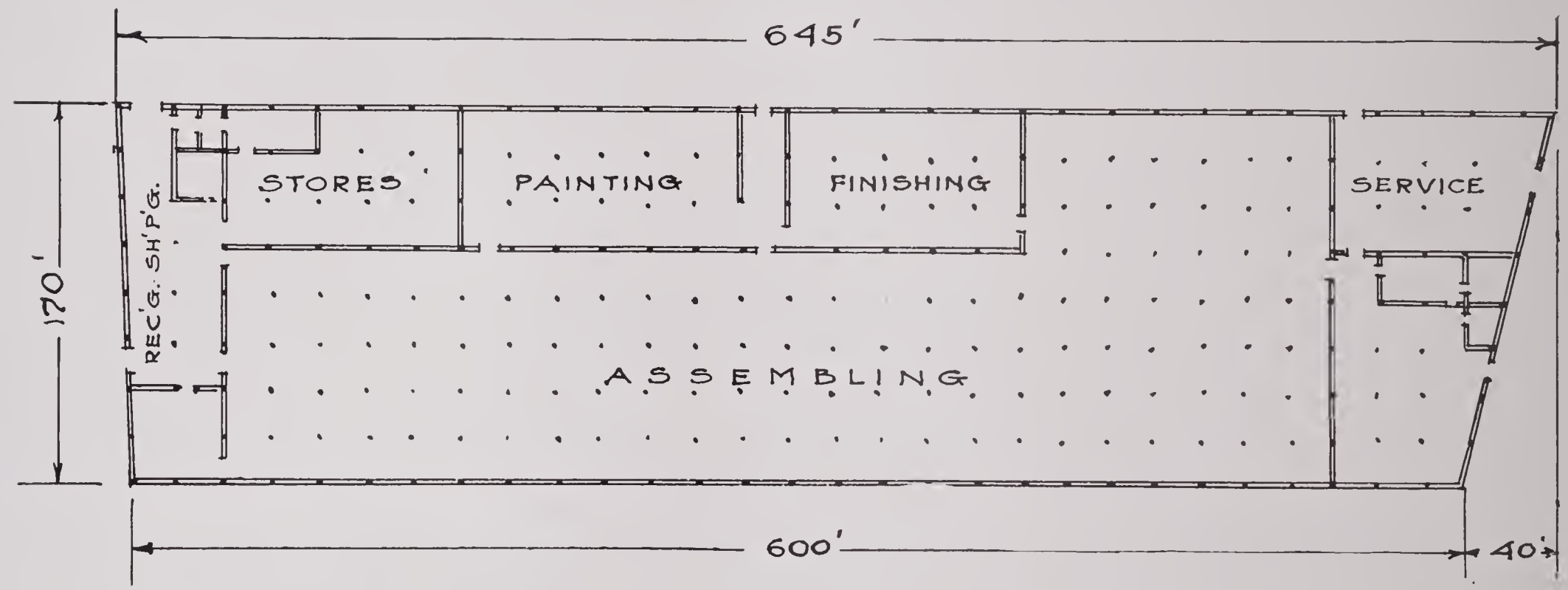
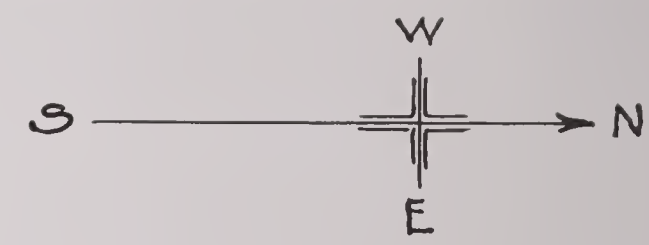

MAIN PRODUCTION UNIT—FACTORY BUILDING NO. 2

Sermon in Bricks—Continued from page 151

It's a wonderful sermon these Pan bricks are preaching. It is a long sermon—150 miles from one end to the other. It is an eloquent and impressive sermon, and one that any layman should readily understand. It means much to the industrial world. It means more to the industrial United States. It means most to industrial Minnesota and the thrifty city of Saint Cloud—the Home of the Pan.

There are many interesting facts in connection with the building of this huge enterprise. For instance, in all its present structures, counting what is to be used in the Forge Plant Warehouse, there are 228,265 cubic feet of concrete, which is a lot of concrete and gives one a concrete idea of the solidity of the company; there are one thousand tons of structural and reinforced steel, over two hundred fifty thousand feet of lumber, over one million two hundred thousand brick and tile, over six hundred



# GROUND PLANS

Works Engineering Department

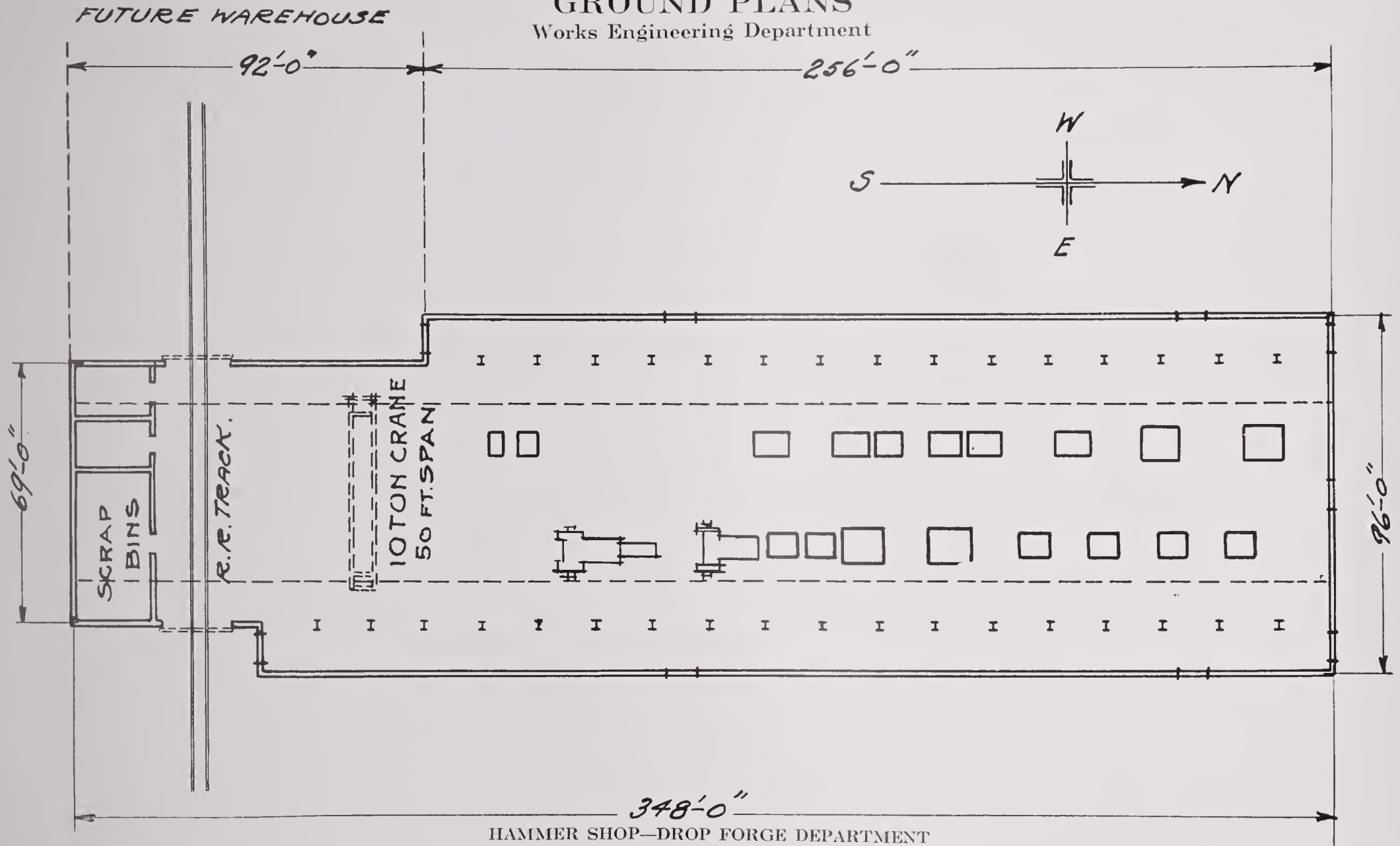

sixty thousand square feet of composition roofing, eighty-one thousand square feet of cement tile roofing, over sixty-seven thousand square feet of steel sash and glass and over seventeen thousand seven hundred square feet of stucco on metal lath.

Certainly, this is a vast quantity of building material, the whole comprising some of the country's most modern industrial buildings. Such a program has required a lot of money; it has required a lot of

Concluded on page 159

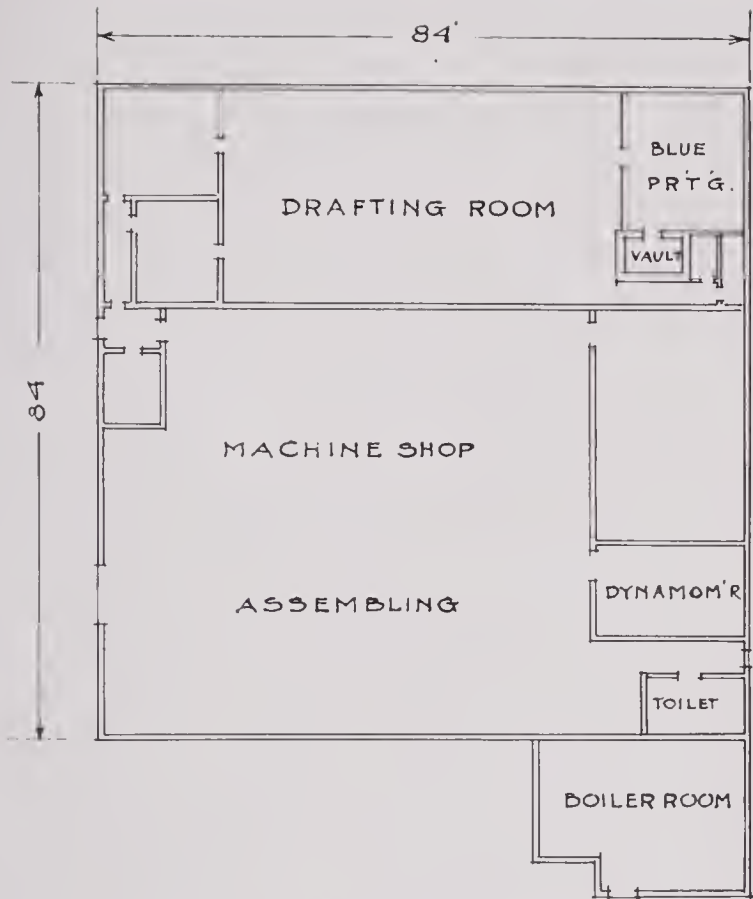

EXPERIMENTAL ENGINEERING BUILDING  
AND BLACKSMITH SHOP

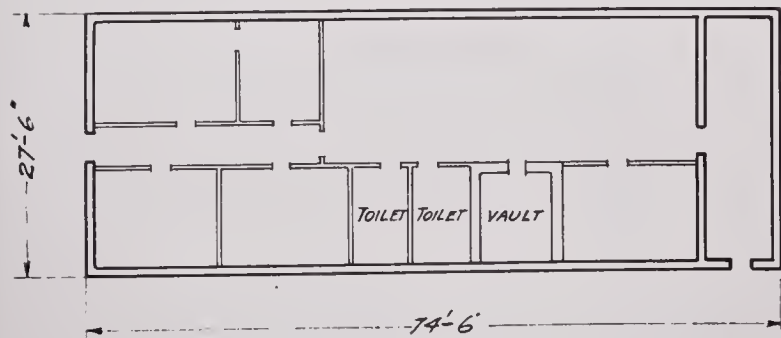
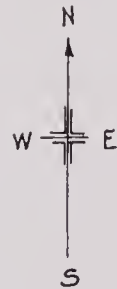
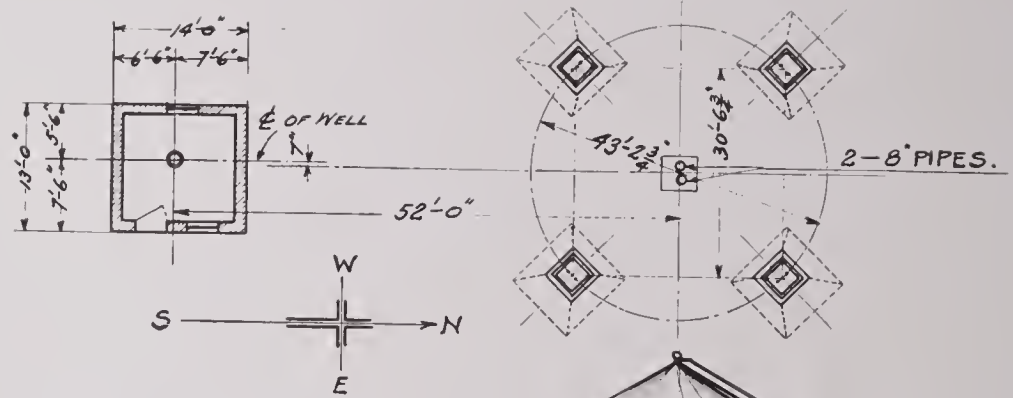
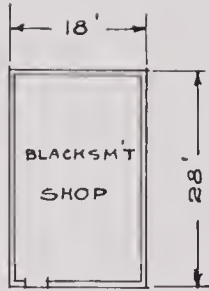

OFFICE BUILDING—DROP FORGE DEPARTMENT

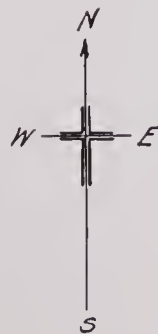

## GROUND PLANS

Works Engineering Department



WATER TOWER AND PUMP HOUSE

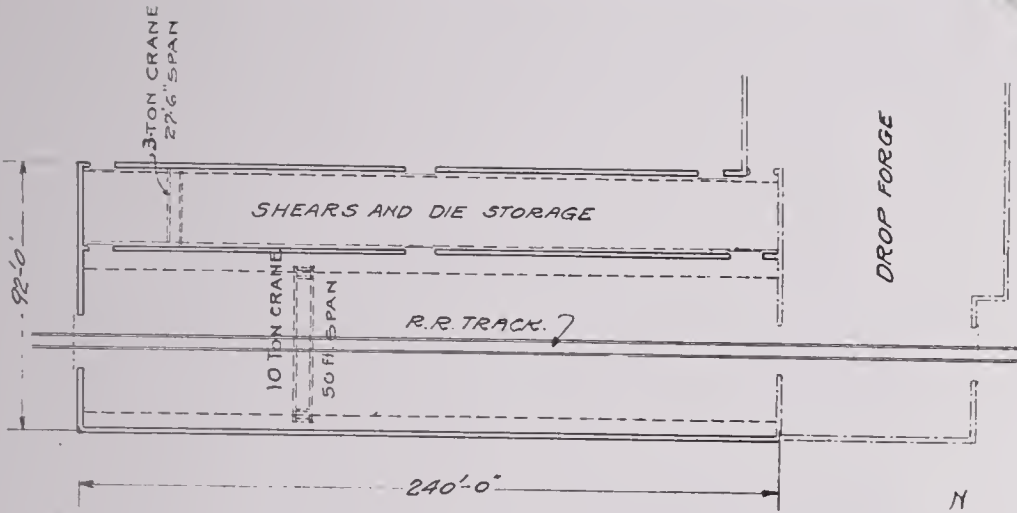

DROP FORGE WAREHOUSE  
(Not Yet Constructed)

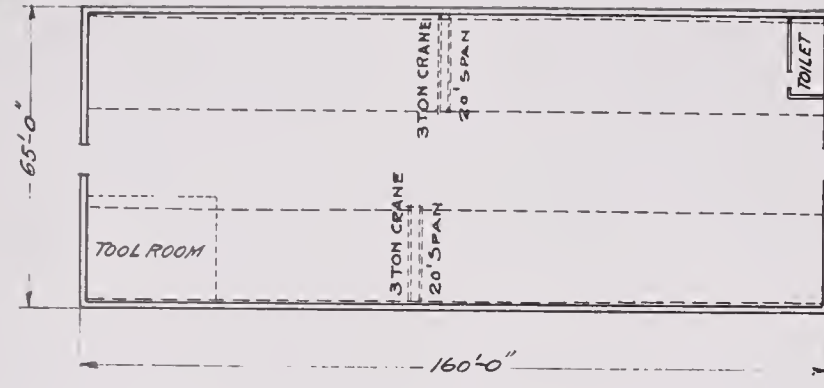
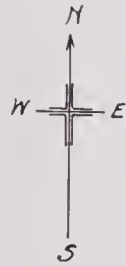

DIE SHOP

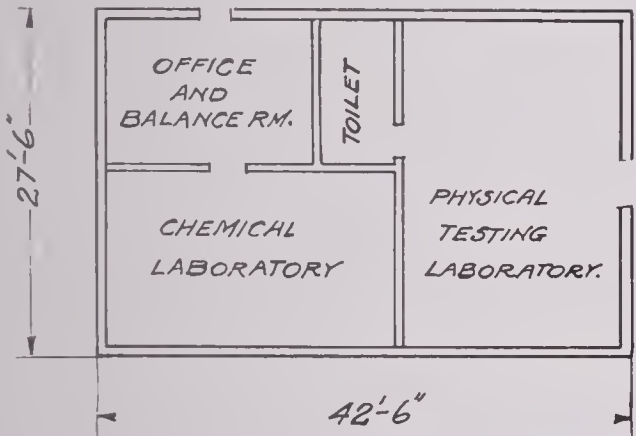

METALURGICAL LABORATORY BUILDING

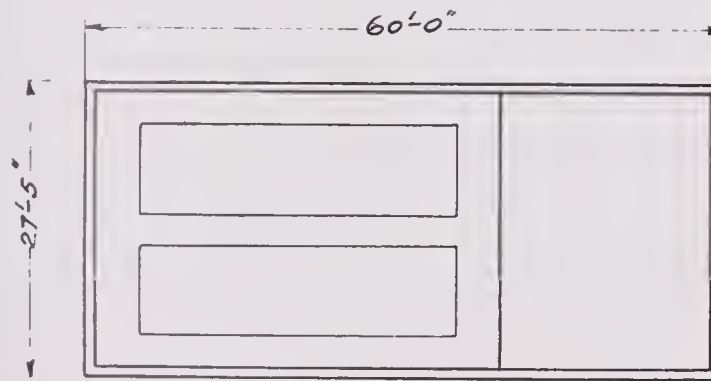
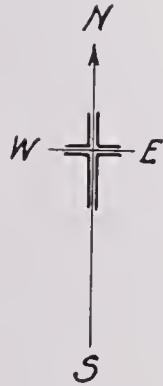

OIL STORAGE BUILDING

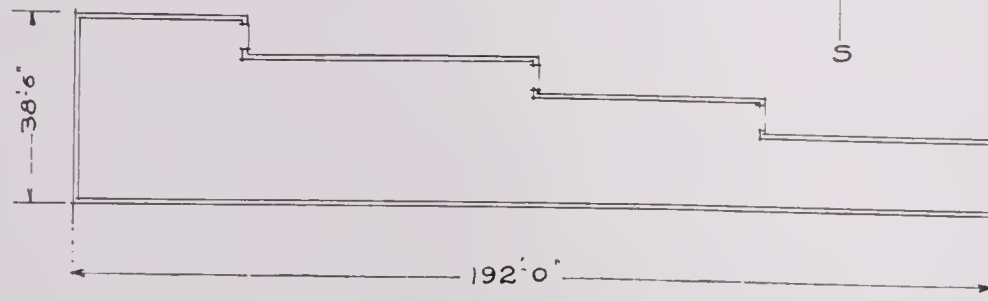

FRAME WAREHOUSE

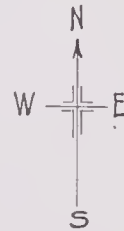

## GROUND PLANS

Works Engineering Department



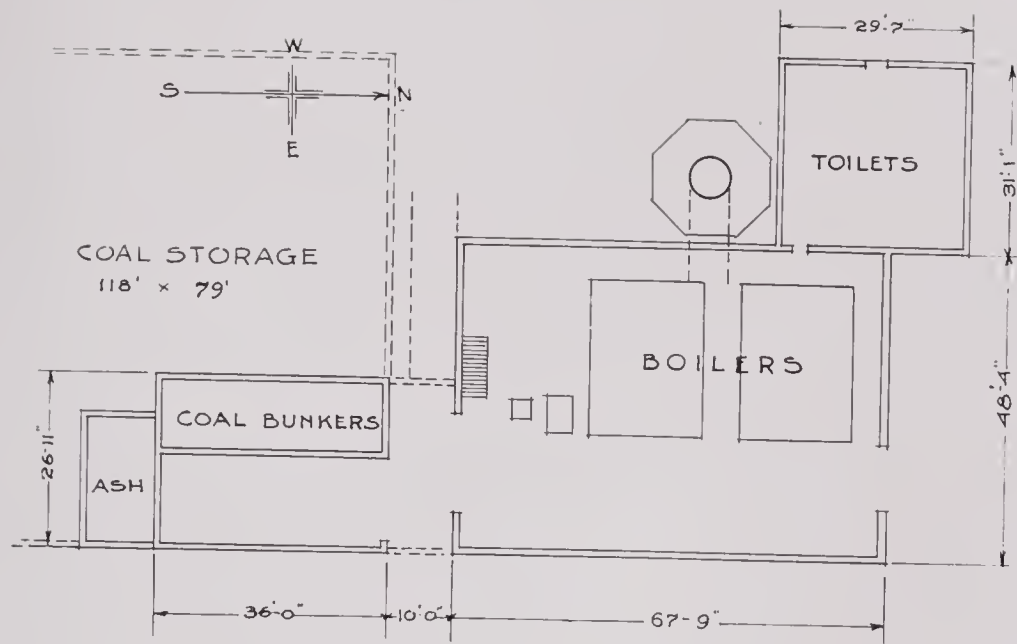

POWER PLANT—DROP FORGE DEPARTMENT

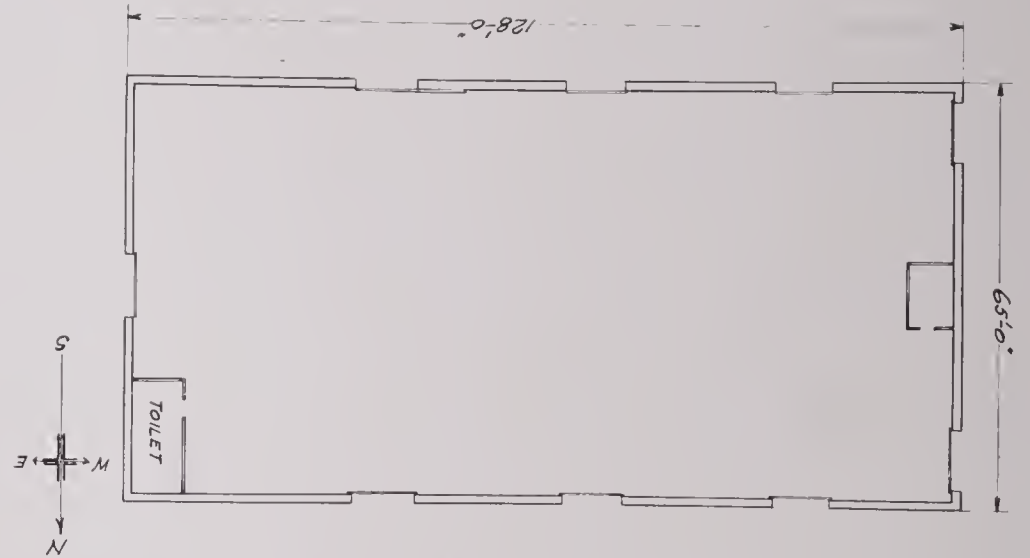

HEAT TREATING BUILDING

## GROUND PLANS

Works Engineering Department

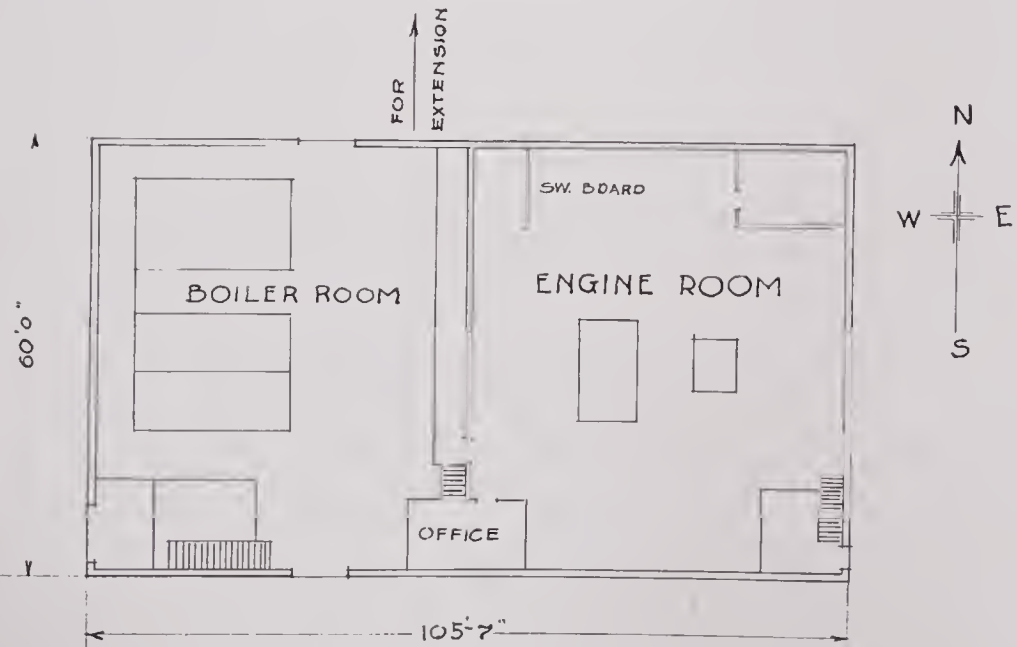

MAIN POWER PLANT

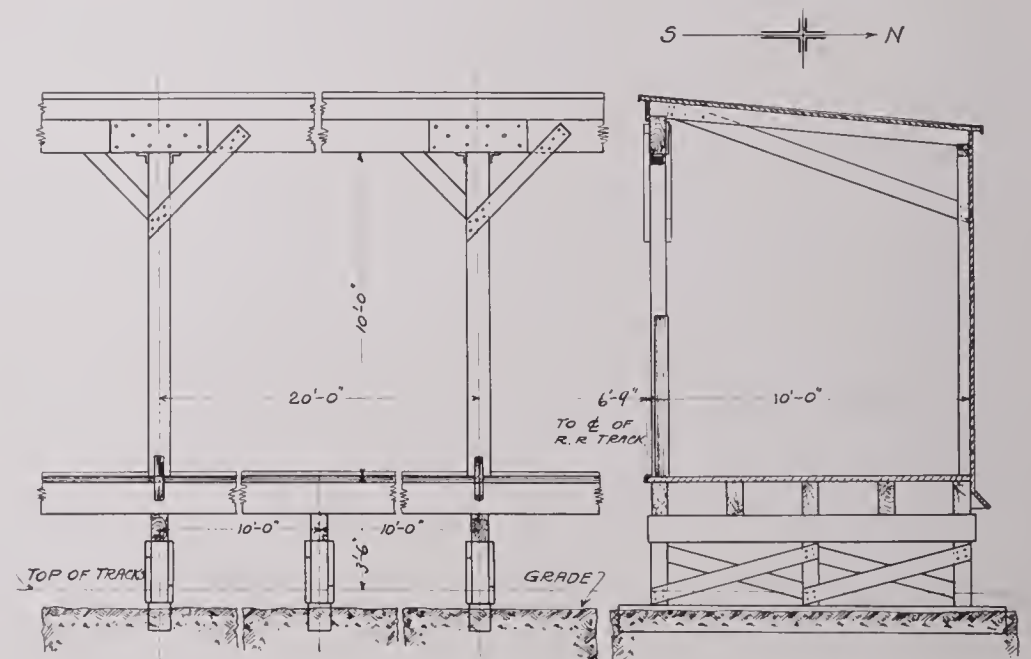

LOADING PLATFORM



## Approximate Quantities of Building Materials Used in Construction of the Present Units of the Pan Motor Company Plant

These figures give some idea of the great quantities of material it takes to construct a big plant like the Pan Motor Company's. It will be noted that figures have been given for buildings under construction as well as for those completed

Building	Ground Area Square Feet	Contents, Cubic Feet	Concrete, Cubic Feet	Structural Steel, Tons	Reinforcing Steel, Tons	Brick and Tile, Number	Ventilators, Size and Number	Lumber, Feet, B. M.	Composition Roofing, Square Feet	Cement Tile Roofing Sq. Ft.	Steel Sash and Glass, Square Feet	Stucco on Metal Lath Square Feet	Radiation, Square Feet
Experimental.....	7,592	118,648	1,080					89,000	8,000				3,400
Blacksmith Shop..	504	9,072	105			Brick, 10,000 Tile 3,200		2,000		700			
Main Factory.....	105,740	1,903,320	136,000		267	Brick, 31,000 Tile, 99,000	38—21 in. 6—12 in.		105,000		11,200		36,308
Warehouse.....	5,286	52,860						22,000	5,300				
Loading Platform..	3,000							33,000	3,000				
Main Power House..	6,330	253,200	10,000	90 $\frac{3}{4}$	2	Brick, 310,000	2—30 in.	15,000	6,100		1,361	500	1,526
Pump House.....	182	2,520	510	4 $\frac{1}{10}$		Brick, 10,000		600	200		30		84
Water Tower.....	1,021	75,000 Gal.	400	60									
Forge Power House	1,740	152,000	22,000	21		Brick, 180,000	1—36 in. 1—21 in. 1—18 in.	10,000	5,000		806		120
Drop Forge.....	31,400	1,108,872	21,000	363	1 $\frac{1}{2}$	Brick, 30,000			6,600	46,000	22,000	2,000	
Die Shop.....	10,708	257,000	7,000	56	1	Brick, 200,000	10—14 in.	50,000	11,700		2,600	220	5,740
Oil Storage.....	1,650	39,500	5,600	4	1 $\frac{3}{4}$	Brick, 28,000	2—12 in.	1,500	2,000		122		186
Forge Office.....	2,048	30,720	1,400			Brick, 36,000		16,000			Glass, 330	1,900	576
Heat Treat.....	8,450	253,500	15,000	60	$\frac{1}{2}$	Brick, 17,000				10,000	6,425	1,600	
Laboratory.....	1,168	17,520	1,200			Brick, 23,000		9,000			Glass, 200	3,000	350
Forge Warehouse..	22,080	720,000	7,000	170	1 $\frac{1}{2}$	Brick, 230,000	6—24 in.		7,200	21,300	2,200	5,500	
Totals.....	211,902	4,948,732	228,625	825 $\frac{3}{20}$	275 $\frac{1}{4}$	1,210,200	70	251,100	160,100	81,000	77,271	17,720	48,890



#### A "GOLD MINE" ON THE PROPERTY!

It has been estimated by a concrete expert that this gravel pit, located on the plant site, is saving the company \$1,000,000 in its building program because of the short haul and the fact that at the same time the necessary excavation for the unit to be built on this location is being made. The excellent grade of gravel found here insures the making of the best grade of concrete.

Sermon in Bricks—Concluded from page 151

material; it has required a lot of labor. But the most surprising feature of the entire project is the shortness of the time consumed. All the work has been done in a little over one year—the last year of the Great War—the one year which will go down as the period of the least building activity in the industrial history of the nation. In such an unfavorable period and in so short a time the Pan Motor Company has made this splendid showing, proving that it is a builder of the first magnitude. It builds with bricks and steel and concrete and glass. But it is not only a builder of buildings—modern in type and design, permanent and substantial in character—but it is a builder of automobiles, and very soon of trucks and tractors. These are being built and will be built in accord with the Pan building principle, which means that they are being built and will be built the best that money and brains and experience and skill can make them.

It is a principle of Pan to build the best.

(Also see Charts C and D.)



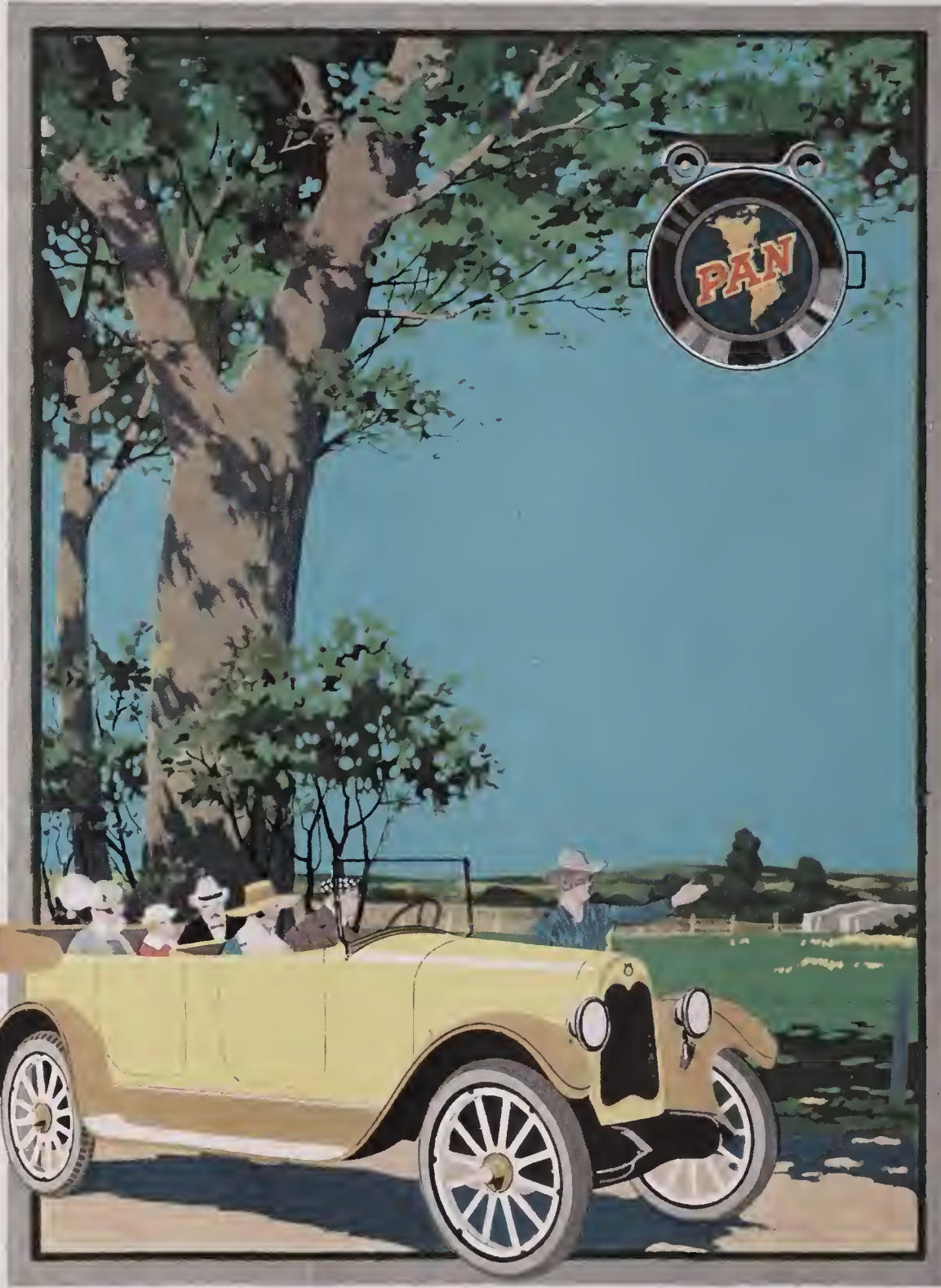





## PAN-FEATURE CAR OF THE FUTURE



**T**AKING advantage of the temporary lull in automobile manufacturing circles due to restrictions brought about by the war, Pan engineers concentrated their attention on the development of the 1919 Model, or the Pan car of the future. Although the car had been announced early in the year, the chassis exhibited at the January and February shows, and plans made for going into early production, the engineering staff was glad to have the additional time in which to further develop what is considered one of the finest light weight, four cylinder passenger cars designed.

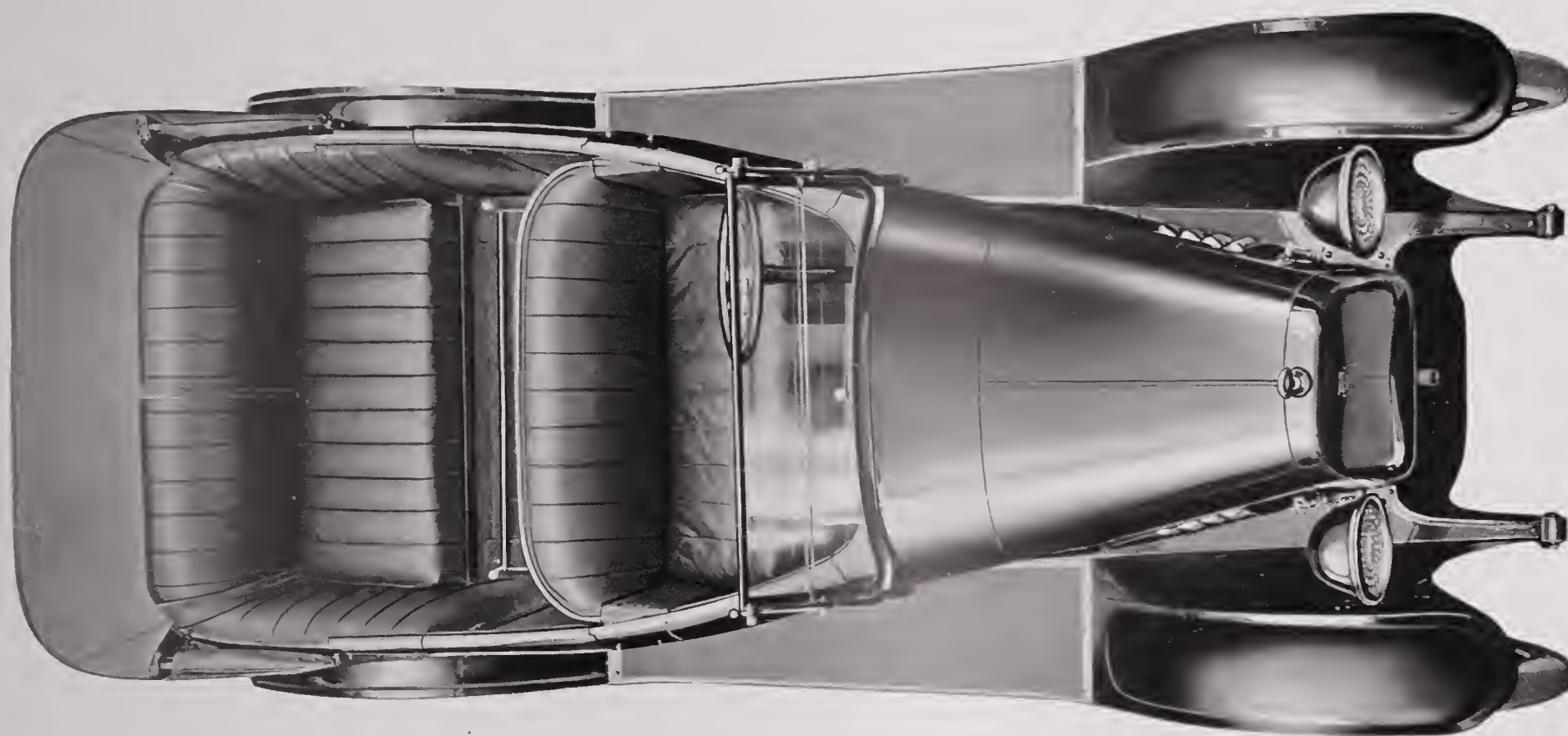

BEAUTIFUL LINES CHARACTERIZE THE NEW PAN

Several more practical features have been added and in some instances it was found that the original features could be improved upon. Now the Pan engineers believe they have reached the acme of perfection in this type of car.

With the signing of the Armistice in advance of an ultimate peace, with the engineers satisfied that their work was ready to turn over to the manufacturing end, and with the lifting of restrictions by the Government, steps were immediately taken for an early production. Plans are well under way and it is expected that the new Pan will be on the market by next season.

Unlike the Model "250," the new Pan will be built complete in its own plant. Production will be confined to one chassis which it is planned to equip with touring, roadster and sedan bodies.





THE PAN "TOURIST SLEEPER" MODEL

In a two page article announcing the new Pan, the Automobile Journal, which is claimed to be the most widely read owners' magazine published in the United States, had the following to say in its August issue:—

"The first announcement of a 1919 Model Passenger Car comes from the Pan Motor Company of Saint Cloud, Minnesota, manufacturers of the Pan, and it is of unusual interest, as while the majority of makers are continuing their old models, this company is to introduce many new features."

Although many new ideas are incorporated in the new Pan, there is nothing radical in its design.

The most interesting feature of this car is its compact motor. It is of a light weight, high speed, four-cylinder type,  $3\frac{1}{4}$  inches by 5 inches. Both intake and exhaust valves are  $1\frac{3}{4}$  inches in diameter

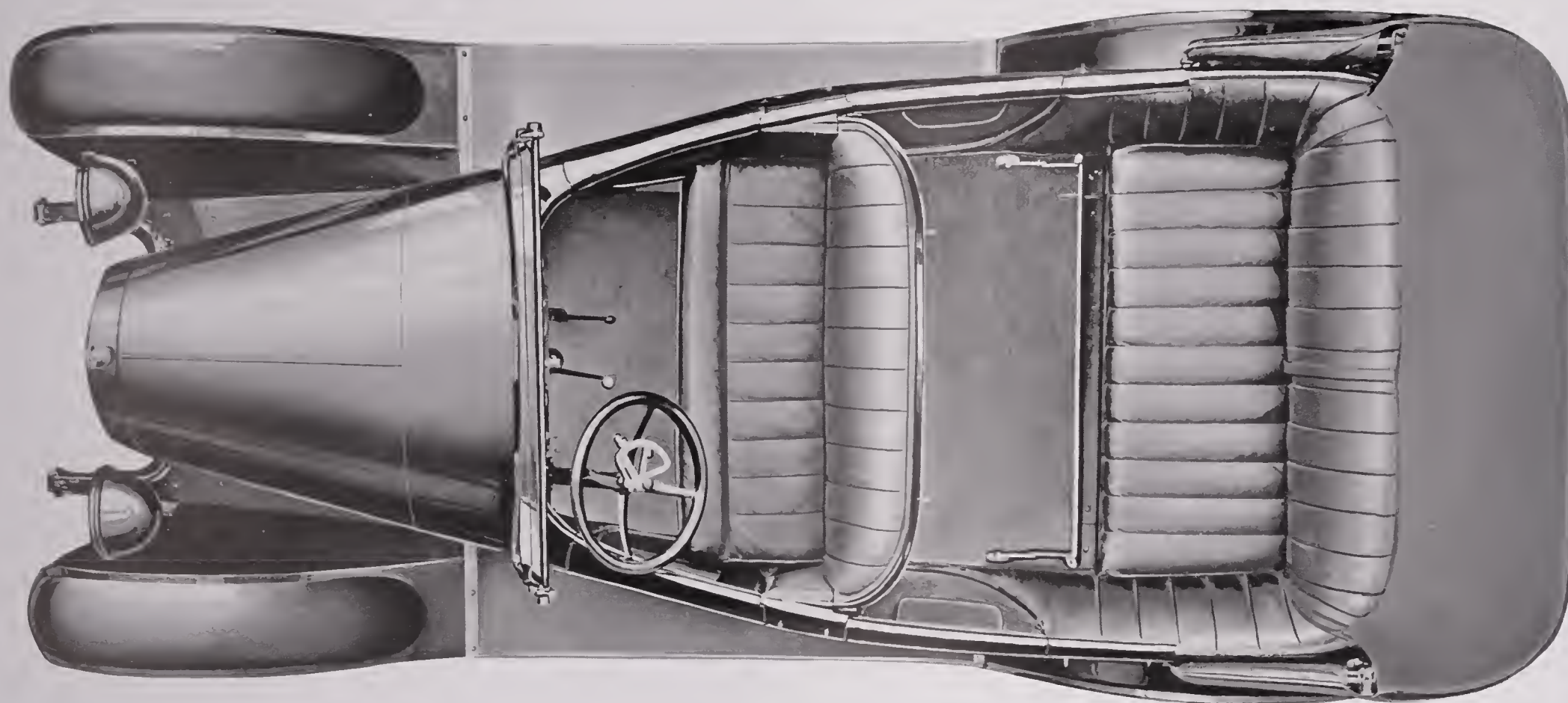

THE PAN SEATING ARRANGEMENT SIMILAR TO OTHER CARS, BUT—

in the clear. The over-all length is only 27 inches and the weight is about 400 pounds. Considering bore and valve sizes and the unusual amount of water space, the new Pan-Powered motor is considered the most compact motor made.

The intake valves are in the head and the exhaust valves are on the side. The cylinder head is removable which leaves both sets of valves accessible. The carburetor is bolted directly to the head and the intake manifold is cast integral with the head. The flow of gas from the carburetor is evenly distributed to all cylinders through the design of intake manifold. Hot air is supplied to the carburetor from a passage cast integral with cylinders.

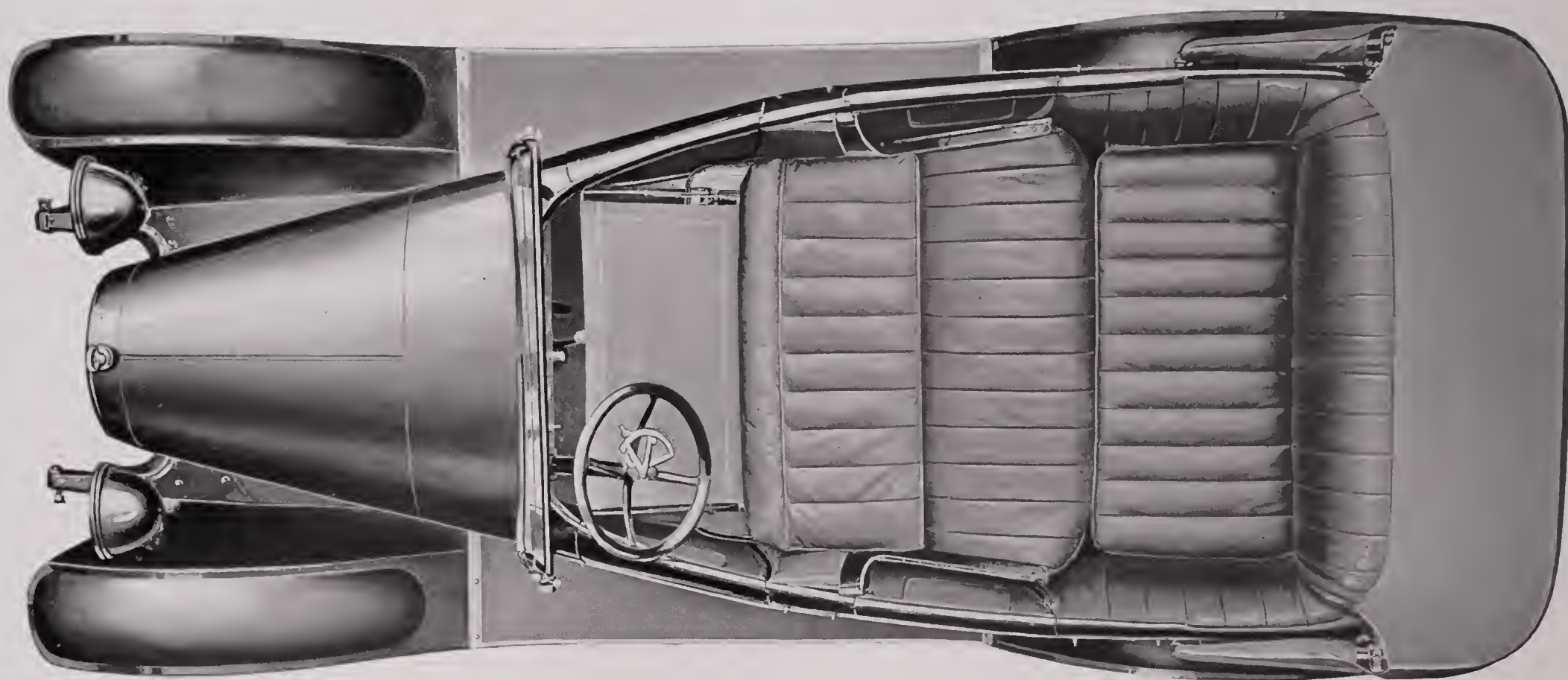

—IN A JIFFY IT CAN BE CHANGED TO A FULL SIZED BED

The crank shaft is fully counterbalanced by a new device and is a two bearing ball-bearing shaft. The crank pins are unusually large for this size of motor, being  $2\frac{1}{8}$  inches in diameter. Due to the use of ball bearings and the special counterweight, a very compact and rigid barrel type crank case is employed, being cast en bloc with the cylinders.

The intake and exhaust valves are opened by the same cam shaft; the cams are integral with the shaft which is carried in three babbitt bearings. The intake valves are operated through straight push rods.

Thermo-syphon water circulation is used, the water entering at the center of the left side of the cylinder block and leaving from the front end at the top. There are large water jackets all around the motor and free water circulation around spark plugs and valves.

Continued on page 169

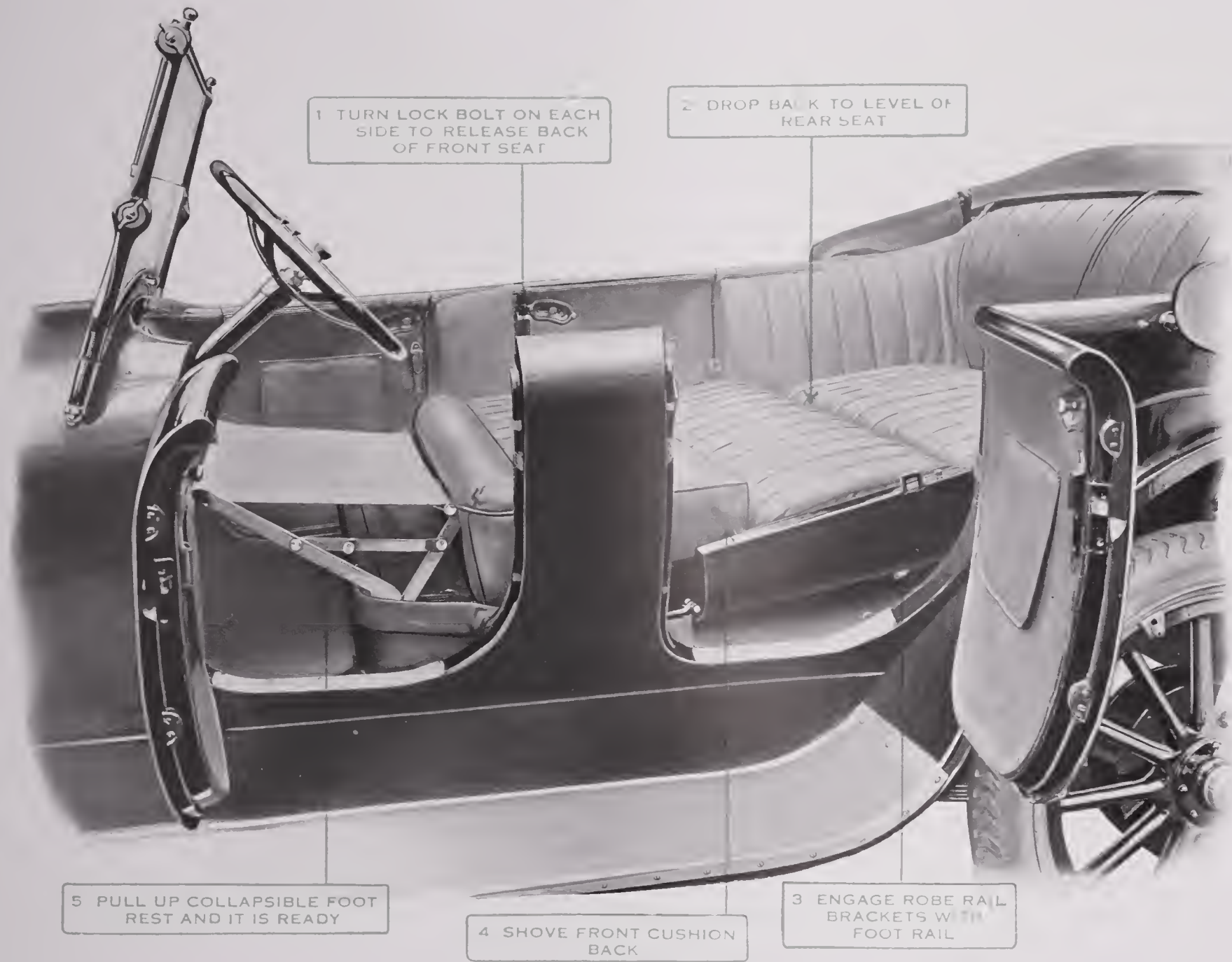

1 TURN LOCK BOLT ON EACH SIDE TO RELEASE BACK OF FRONT SEAT

2 DROP BACK TO LEVEL OF REAR SEAT

5 PULL UP COLLAPSIBLE FOOT REST AND IT IS READY

4 SHOVE FRONT CUSHION BACK

3 ENGAGE ROBE RAIL BRACKETS WITH FOOT RAIL

DETAILS OF "TOURIST-SLEEPER" BODY AND HOW IT IS OPERATED



FRONT AND REAR VIEWS "TOURIST SLEEPER" MODEL

Pan—Feature Car of the Future—Continued from page 167

Lubrication is of constant level circulating system. The reservoir is in the aluminum oil pan which is readily removable—and due to the type of sod pan used is exposed to the air which results in the oil being kept very cool.

The gasoline is supplied through gravity system, the tank being located in the cowl. The filler cap is conveniently located under the hood.

The motor is designed so that any standard type of starting and lighting equipments with S. A. E. flanges can be mounted. Battery ignition is used. Any make of distributor using the S. A. E. standard distributor mounting can be used. Headlights are adjustable so that light can be thrown on the engine or along the sides of the car.



THE PAN SEDAN IS TO BE EQUIPPED WITH SLEEPING CAR ARRANGEMENT

The clutch is an eight inch, single disc, dry plate and the transmission is a standard, three speed type, fitted with ball-bearings and provided with a lock to hold the gears in neutral.

Another clean-cut feature of this car is the design of brakes. The emergency brake is mounted on the rear of the transmission case and the service brake is on the rear axle, both brakes being internal and enclosed, making them practically dust-proof. The emergency brake is 10 inches in diameter and  $2\frac{1}{2}$  inches wide. The service brake is 12 inches in diameter and  $2\frac{3}{4}$  inches wide. A self releasing emergency brake lever is used.

The rear axle is of the three-quarter floating type and both front and rear axles are equipped with Timken bearings. The rear axle ratio used is 5 to 1.



DESIGN OF THE NEW PAN ROADSTER

In a series of road tests this car has been driven on high gear at a speed of from less than 3 miles to 60 miles per hour. Considering the extremely low gear ratio this is a remarkable performance. Due to the use of Lynite pistons and counter balanced crankshaft, there is practically no vibration at any speed.

The spring suspension is semi-elliptic in front and semi-elliptic employing Hotchkiss drive in rear. This car is exceptionally smooth riding and holds the road at high speed, due to its balance and use of long springs; the front spring being 36 inches long and the rear being 50 inches long. Spring center distance at the rear is 42 inches.

The frame is of a deep channel construction, being  $6\frac{1}{8}$  inches deep. The spare tire carrier is of very light and rigid construction and is equipped with a special tire lock.

Continued on page 173

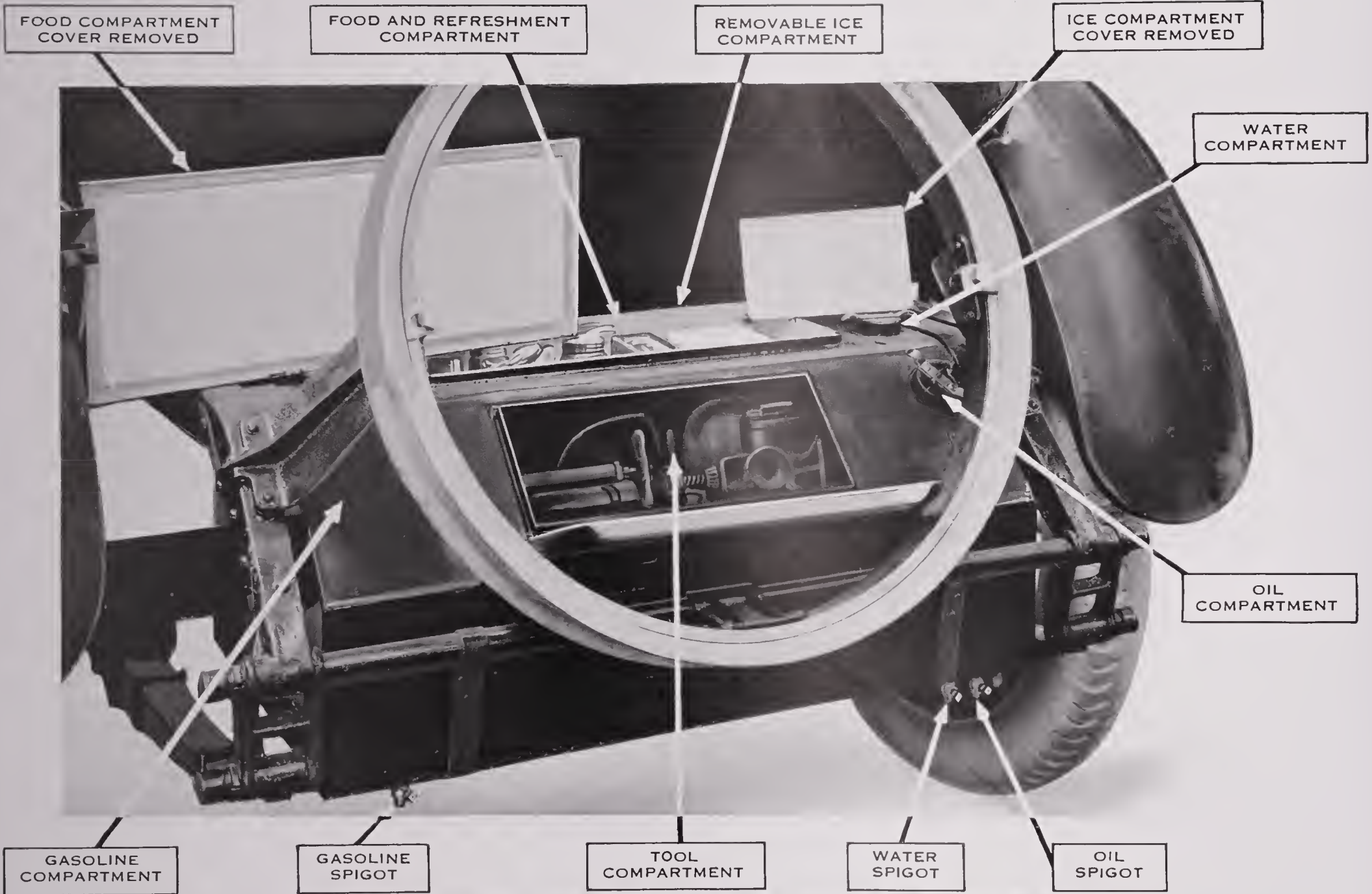

PANDOLFO COMBINATION COMPARTMENT TANK REGULAR EQUIPMENT OF PAN





Pan—Feature Car of the Future—Concluded from page 171

With the exception of the front axle spindle bolts, steering gear and rear-axle wheel bearings, there are no grease or oil cups on the car, self-lubricating bushings being used throughout.

The wheel base of this car is 108 inches, and due to the compact motor design, there is as much body room on this chassis as in the average 115-inch wheel-base car. The general appearance of this car would lead one to believe that its wheel base is much larger. It has a road clearance of 11 inches. The tires are 33 by 4.

A rather unique but practical feature of the 1919 Pan that will soon prove itself indispensable to the motorist who wants the utmost in comfort and convenience is the Pandolfo Sleeping-Car Body. By simply turning two lock bolts the back of the front seat can be dropped down on a level with the rear seat cushion forming a bed that for size and comfort is not equalled by the average hotel bed or Pullman berth. In designing this body, E. C. DeSmet, body designing engineer, carried out the ideas furnished by the president of the company.

The Pan is also equipped with the Pandolfo combination-compartment tank at the rear, allowing one to carry a reserve supply of gasoline, oil and water. There is also a compartment for tools and a compartment for provisions, cold drinks and ice. The weight of the car fully equipped is approximately 2,300 pounds.

In the opinion of many, Pan of 1919 is another excellent example of Pan foresightedness—another evidence of Pan progressiveness—another indication of Pan possibilities.



THE PAN COUNTERBALANCED CRANKSHAFT



## BRIEF SPECIFICATIONS PAN OF 1919

**MOTOR:** Pan design, 4-cylinder, 3½ inch bore, 5 inch stroke, actual horsepower 45-50.

**CARBURETOR:** Either Stromberg or Zenith, 1 inch horizontal type.

**IGNITION:** Remy distributor, closed circuit type; 6-volt, Gould battery.

**LIGHTING:** Auto-Lite.

**STARTING:** Auto-Lite.

**COOLING:** Thermo-Syphon.

**TRANSMISSION:** Pan design, selective type; three speeds forward and reverse. Shafts mounted on ball bearings. Gear ratios, direct drive on high, 4.9 to 1; intermediate 10 to 1; low 19¼ to 1; reverse 15¾ to 1.

**CLUTCH:** Borg & Beck; standard 8 inch dry plate disc.

**FRONT AXLE:** Pan design, Timken bearing equipped.

**REAR AXLE:** Pan design, three-quarter floating, Timken bearing equipped throughout.

**SPRINGS:** Rear, Hotchkiss drive, semi-elliptic, 2 inches wide, 50 inches long. Front, semi-elliptic, 1¾ inches wide, 36 inches long.

**FRAME:** High carbon, pressed steel; depth of channel section 6½ inches.

**BRAKES:** Emergency brake internal expanding, mounted at rear of transmission case. Service brake, internal expanding, mounted on rear wheels. Both brakes enclosed and dust proof.

**DRIVE SHAFT:** Standard Spicer universal joints, tubular construction.

**STEERING GEAR:** Gemmer, worm gear type. Control, center.

**WHEEL BASE:** 108 inches.

**TREAD:** Standard.

**WHEELS:** Second growth hickory, artillery type, 12 spokes front and rear, Firestone demountable rims.

**TIRES:** 33x4 all around; non-skid on rear.

**ROAD CLEARANCE:** 11 inches.

**BODY:** Five passenger, Pandolfo "Tourist-Sleeper" Model, also Sedan and Roadster.

**TOP:** One man type equipped with side curtains opening with doors.

**EQUIPMENT:** Boyce moto-meter, Stewart-Warner speedometer, electric horn, complete set of tools, tire pump, jack, tire carrier in rear; Pandolfo combination compartment tank.

**WEIGHT:** 2,300 pounds fully equipped.

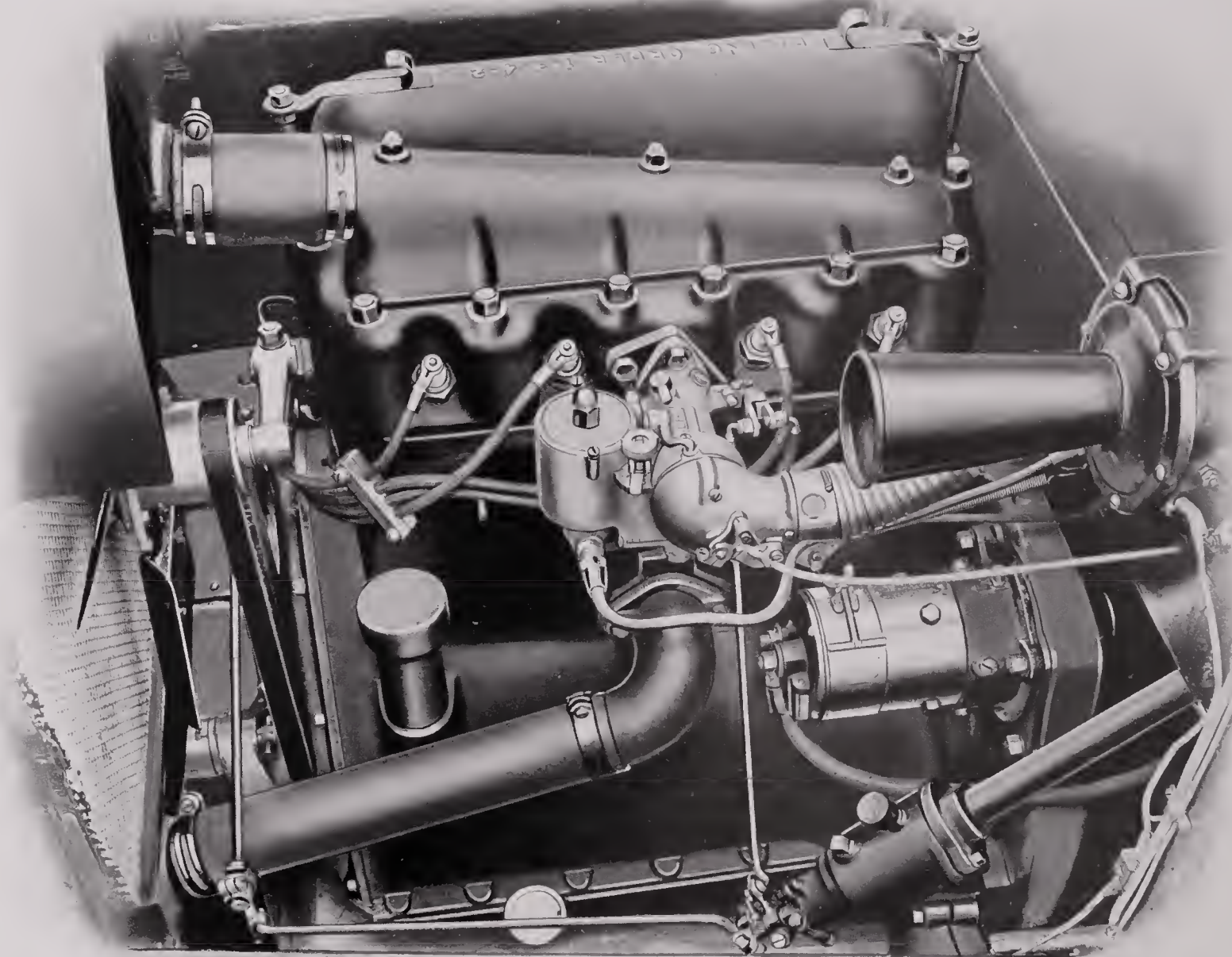

CARBURETOR SIDE OF THE PAN POWER PLANT

Showing how carburetor is bolted direct to the head, location of the spark plugs, and how conveniently accessible are all parts. Simplicity, accessibility and compactness are features of the Pan engine.

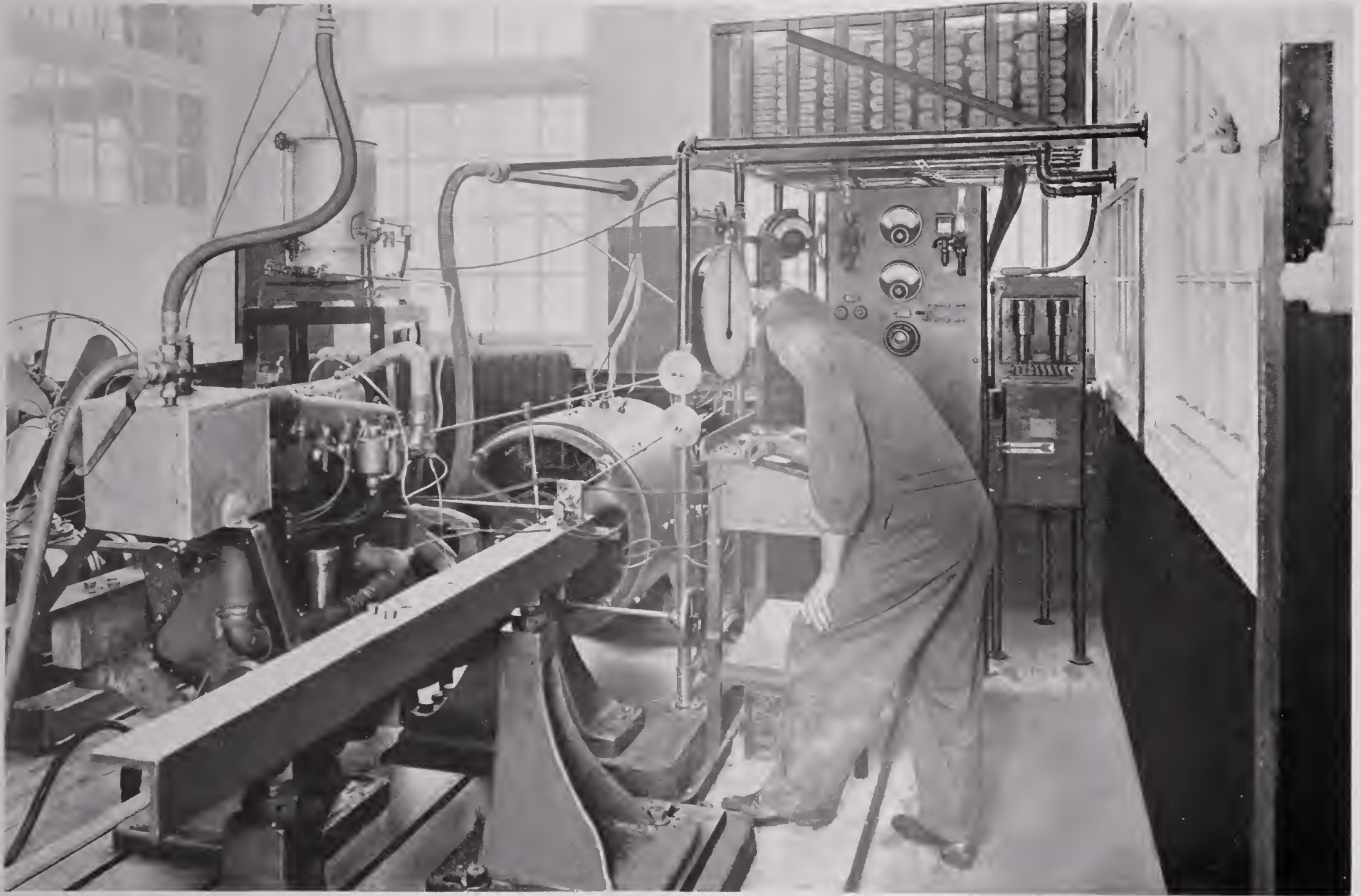

DYNAMOMETER TESTING THE PAN-POWERED MOTOR

No guesswork goes in motor manufacturing—The engineer is “from Missouri”—His motor must prove its worth—nothing escapes this critical machine. Some interesting facts concerning the Pan Motor are shown on the test charts appearing on another page.



# PROVING THE POWER OF PAN

**I**T is not everybody that knows what the horsepower curve of an internal combustion motor is. Whether the instrument of measure is the obsolete Prony Brake, the more up-to-date Fan Dynamometer, or the still more advanced Electric Cradle Dynamometer, this curve will enable one to determine very quickly some of the qualities of the engine.

To obtain this curve consider a horizontal line OX (See Chart No. 1) on which is marked the angular speed of the engine measured in revolutions per minute (R. P. M.) and indicated by an electric tachometer attached to the dynamometer. Consider also a vertical line OY on which is registered the corresponding horsepower (H. P.) of the engine taken from the reading of the dynamometer scale by a very simple calculation. Draw at different points lines respectively perpendicular to OX and OY, the intersection of those lines will permit the drawing of the horsepower curves.

The horsepower curve of the Pan 1919 motor was obtained with a Sprague Electric Cradle Dynamometer. Sparing the reader the rather technical description of this apparatus, it simply provides a very accurate and reliable means of measuring the power of an engine and generally proving its points of superiority or inferiority, if such there be.

The examination of the horsepower curve will immediately give valuable indications. Note first that the curve is a perfectly straight line up to 1400 revolutions per minute. This shows that the power is proportional to the angular speed of the engine (R. P. M.) and immediately displays the advantages of the Pan's large valves and proves without doubt that the volumetric efficiency is maximum and to use a common expression, that the motor "breathes" well and is well "fed."

Another glance at the curve will show that the maximum horsepower of practically 50 H. P. is developed at 3000 R. P. M. which is also the best proof of the perfect balance of the engine and its complete lack of vibration.

The continuous climbing tendency of the curve gives the reason for the tremendous get-a-way of the 1919 Pan car itself and explains why this car, according to the expression of many who ride in it, is "chuck full of pep."

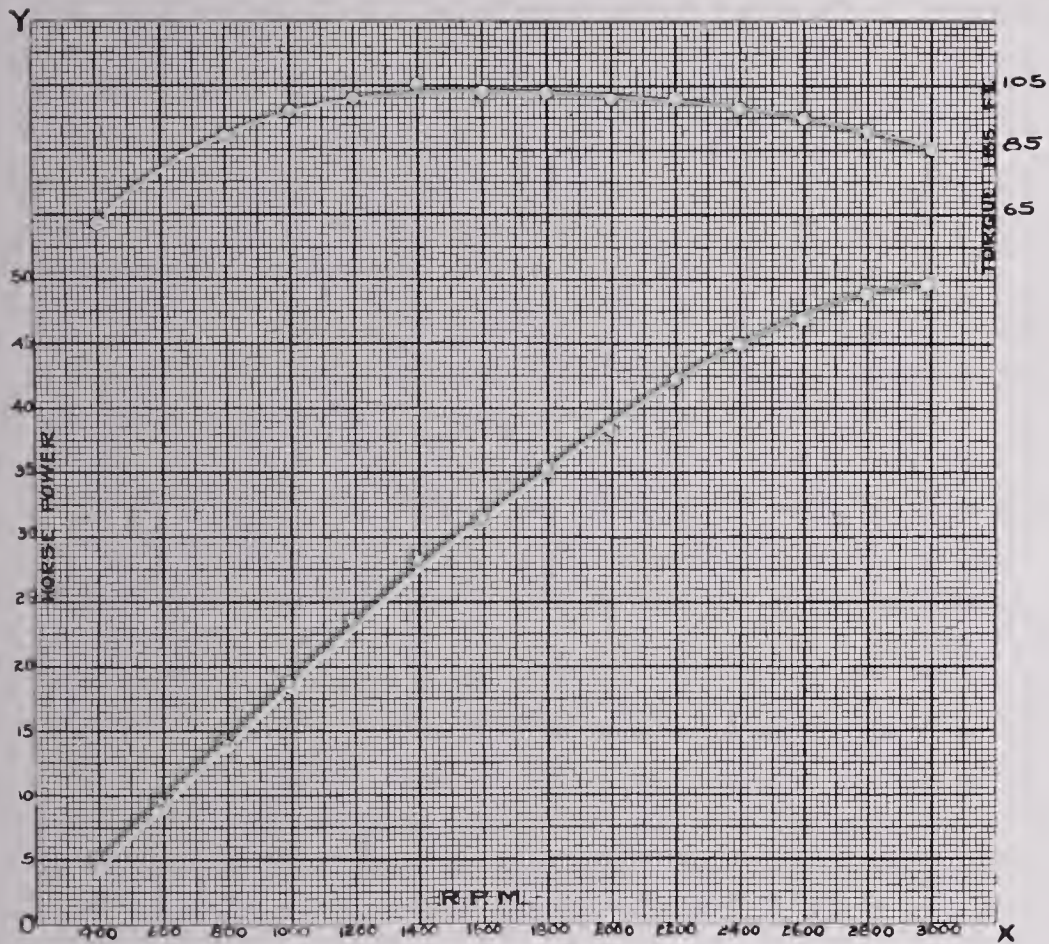

CHART 1  
Pan-Powered Motor—1919 Model

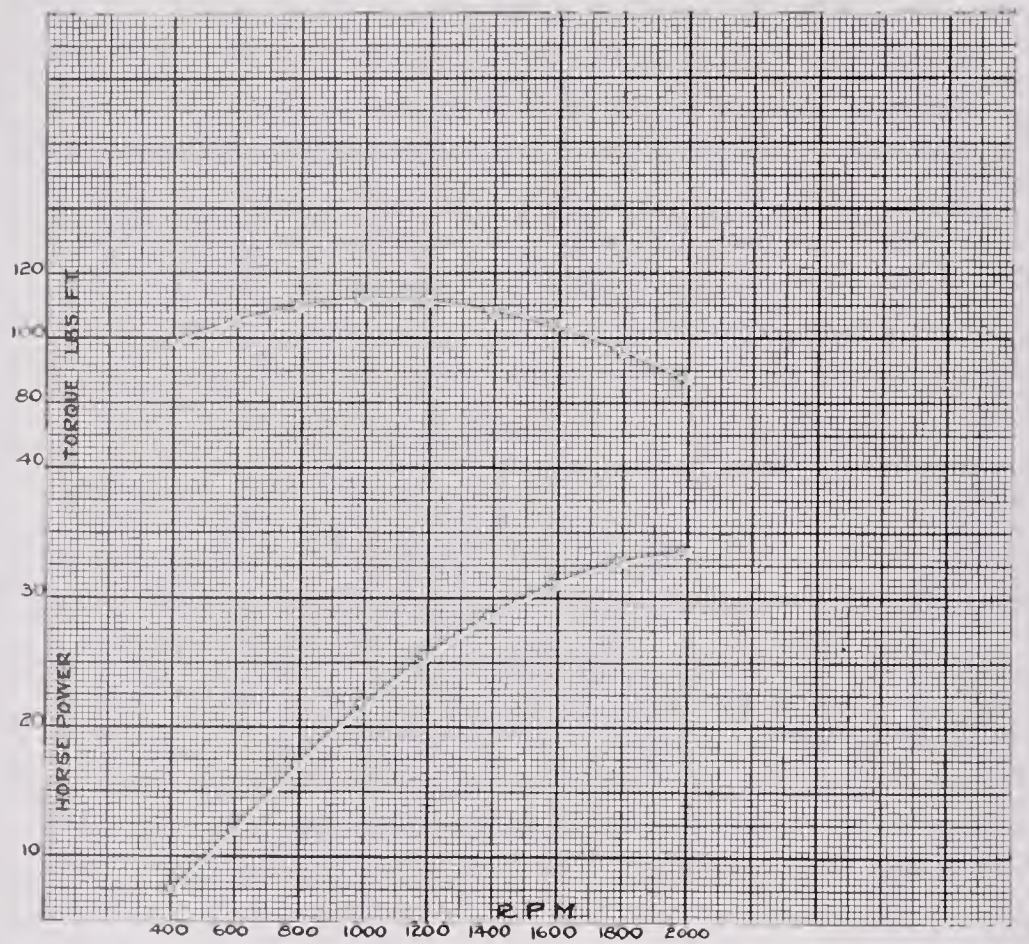
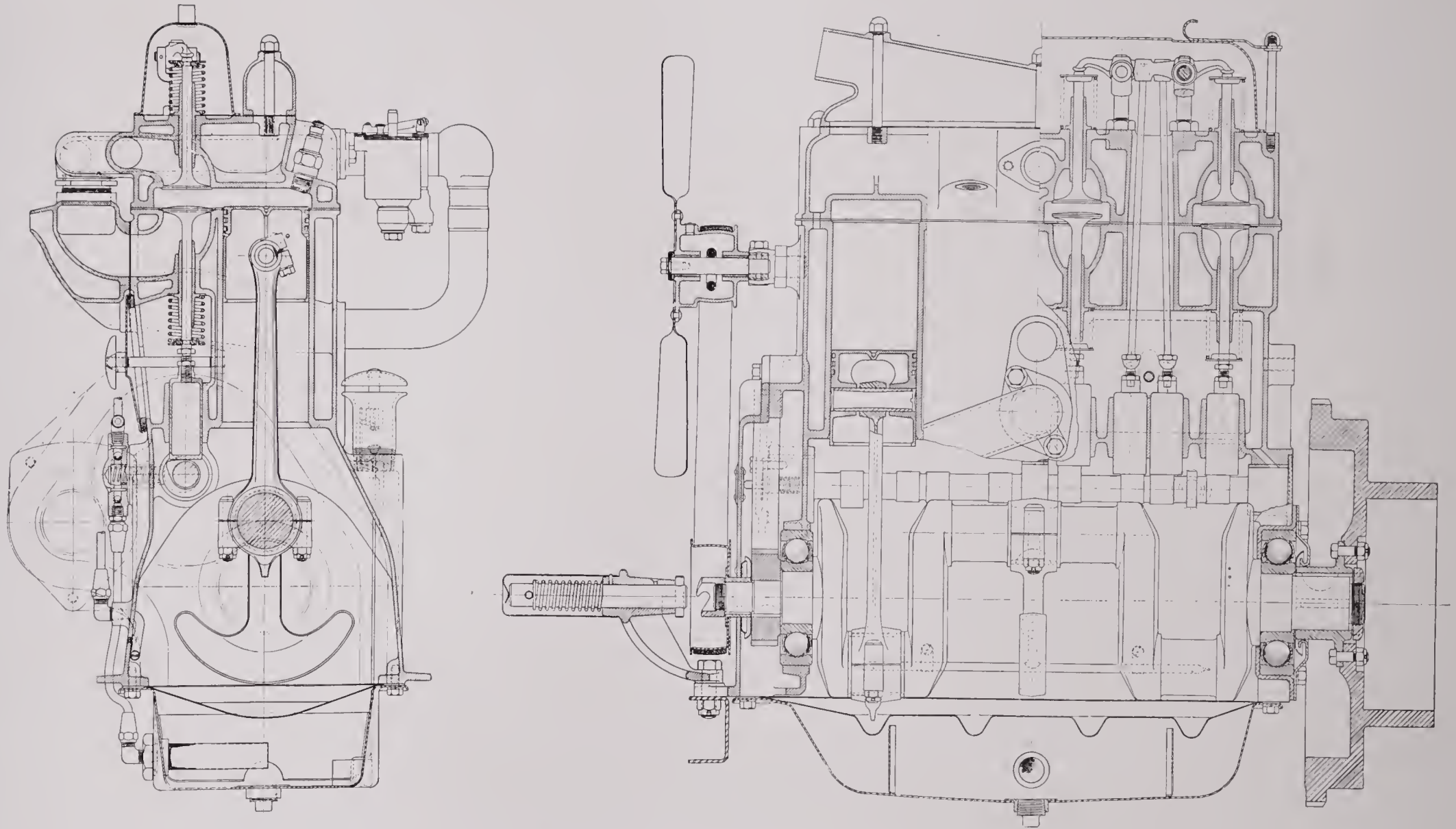

CHART 2  
A Well Known Motor

The torque curve, shown above the horsepower curve on the chart, was also charted from the reading on the dynamometer scale and tells just how the motor is pulling under wide open throttle at given speeds. The theoretical and ideal torque curve would in reality be a perfectly straight horizontal line. This curve is impossible to obtain in practice; however, it is the aim of all motor designers to produce an engine that will come as near to this ideal as possible.

In order to emphasize the splendid characteristics of the Pan 1919 motor, it has been compared with a standard and well known motor manufactured by one of the leading motor manufacturers in this country. The curve on chart 2 refers to a four cylinder,  $3\frac{1}{2}$  by 5 "L"-type motor, that has a  $\frac{1}{4}$ -inch larger bore than the Pan engine. A very superficial examination will show that this engine develops its maximum power of 33 horse at 2000 revolutions per minute, while the Pan engine develops at this same speed 38 horsepower and does not reach its maximum of  $49\frac{3}{4}$  until 3000 revolutions per minute are recorded. In regard to the torque curve, note that the Pan torque curve is a great deal closer to the ideal straight line than the other one, and further, that the Pan motor pulls its maximum load at 1400 revolutions per minute and continues pulling almost this same load up to 2200 revolutions per minute. Translating it in ordinary language, the Pan car will pull an even load at almost all speeds ranging from 15 to 60 miles per hour.



DETAILED DRAWING OF THE PAN-POWERED MOTOR

The drawing at the left shows the method of crankshaft balance, position of both valves and carburetor bolted direct to cylinder head. The sectional side view on the right shows the large crankshaft ball bearings; large water jackets around all parts, the camshaft and valve assembly, etc.

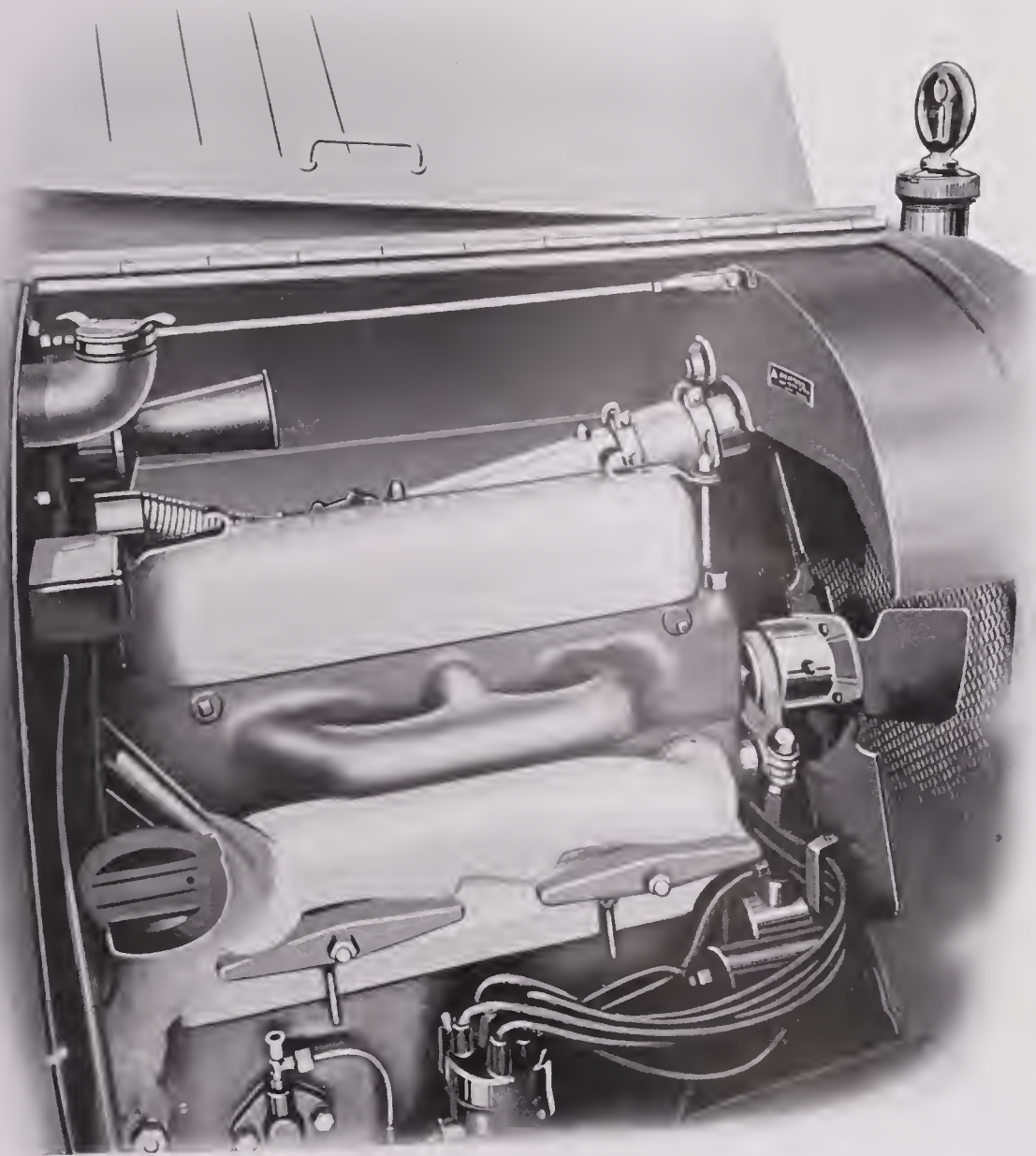

EXHAUST SIDE OF THE PAN POWER PLANT

An inspection of the right side of the Pan motor again impresses one with its simplicity, compactness and accessibility. Note how the gasoline filling cap is conveniently located under the hood.



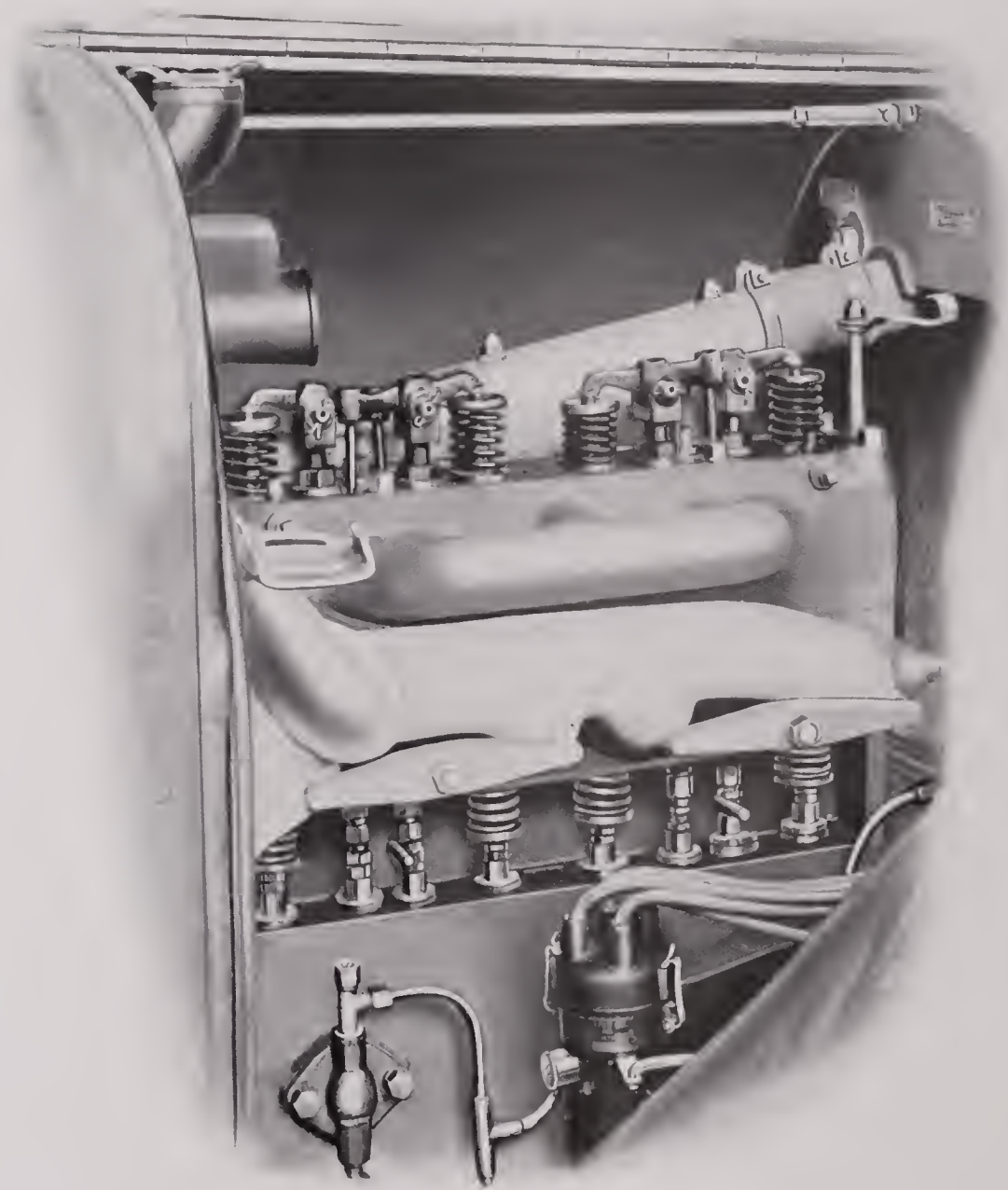

EXHAUST SIDE WITH TOP COVER AND SIDE PLATE REMOVED

Showing the arrangement and accessibility of the valves and the manifold cast integral with the head. Rocker arms and straight push rods operate both the intake and exhaust valves.

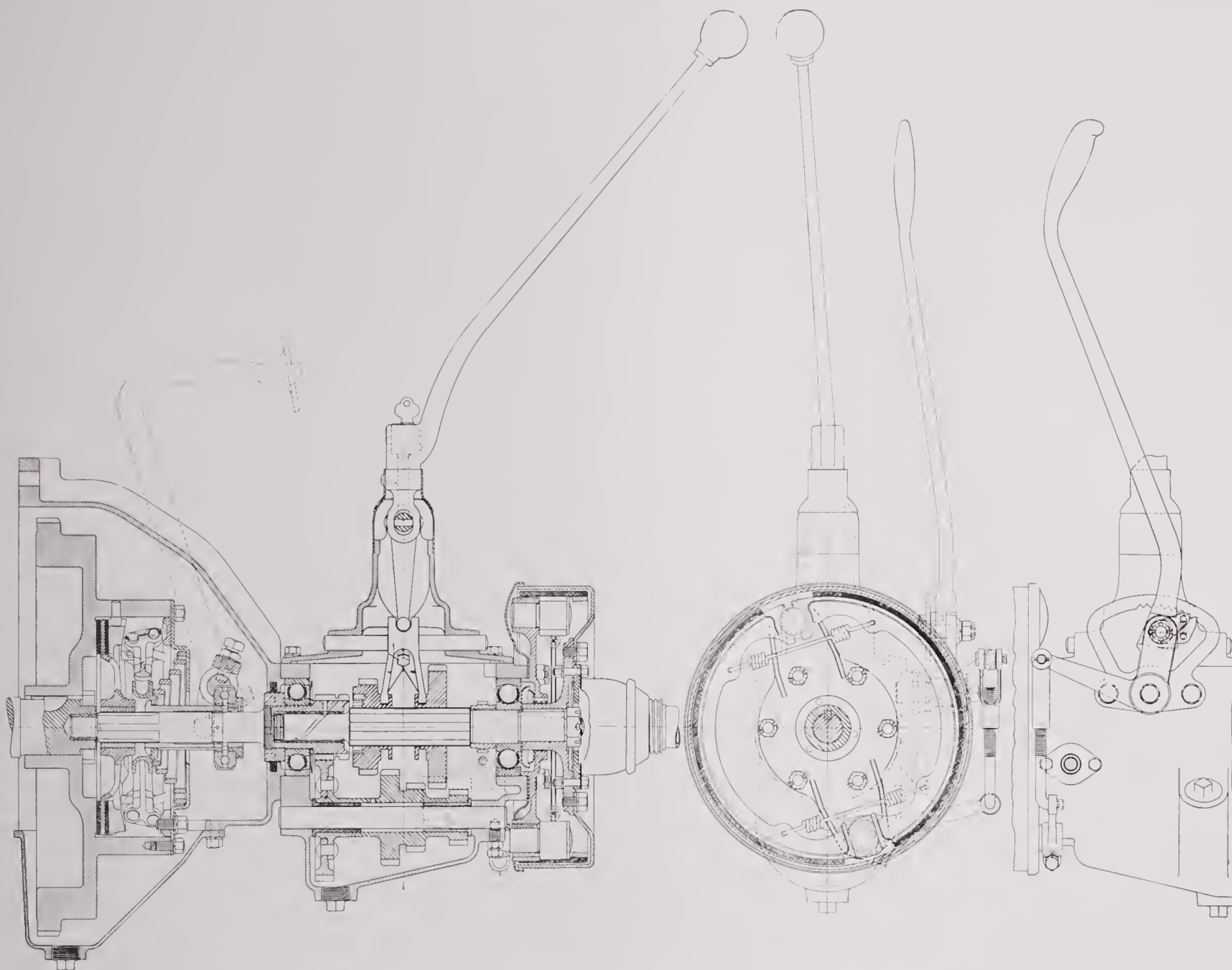

DETAILED DRAWING OF PAN CLUTCH AND TRANSMISSION

Showing single disc, dry plate type of clutch; standard type of selective transmission, but fitted with ball bearings and provided with lock to hold gears in neutral; emergency brake on drive shaft and self-releasing brake lever—all of Pan design.

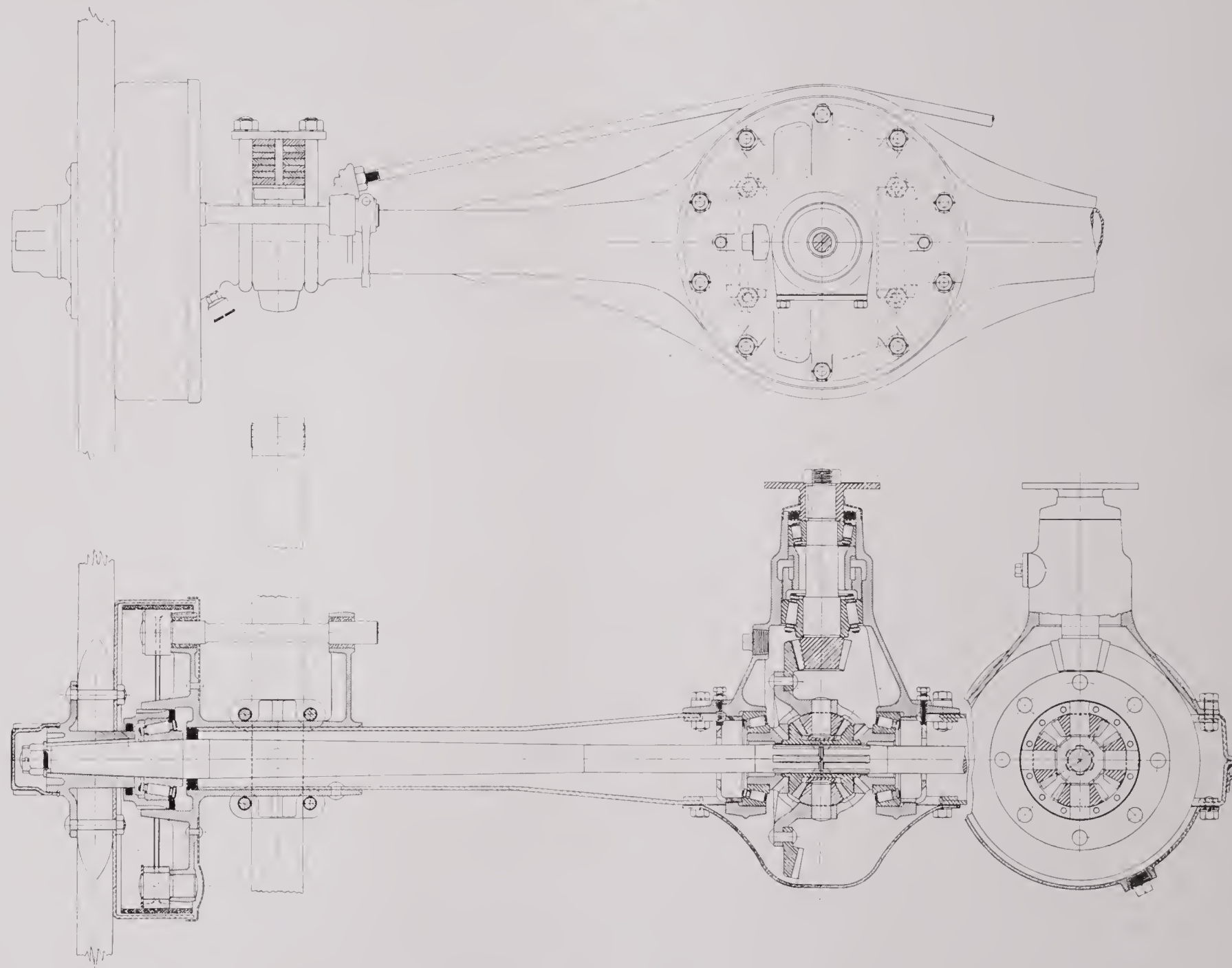

DETAILED DRAWING OF THE PAN REAR AXLE

The Pan rear axle is of the three-quarter floating type and is equipped with Timken bearings; exposure of braking surface to dirt and water is eliminated in this design.





# ADMINISTRATION







# BOARD OF DIRECTORS



S. C. PANDOLFO  
Founder, President and General Manager

AT TIMES it is impossible to put one's thoughts and feelings into type—impossible to do one's subject justice. Such is the situation now. There is something about the board of directors of the Pan Motor Company that does not lend itself readily to description and the writer wishes he could take the reader by the arm and introduce him to each member of the board personally. Nothing further would be required to convince him of the splendid type of men who are directing the destinies of this great project. There is not one of the dozen on the board who is not four-square, who cannot shake you by the hand, look you in the eye, and by his conversation and demeanor, demonstrate to your entire satisfaction that he is "all wool and a yard wide," that he is the identical person he pretends to be on a hundred per cent basis. They are bankers, business and professional men who are actively interested in the enterprise they have backed

---

Samuel Conner Pandolfo was born on a farm at Macon, Miss., 1871; attended Southern University, Greensboro, Ala., 1892-1894; principal of schools two years in Alabama. Emigrated to Texas 1896 and became principal at Lindale, Tex., high school. Principal of schools three years in Texas. Went to New Mexico 1900 and became superintendent of public schools, Los Cruces, N. M.; was in school work 7 years, then went into commercial life; was head bookkeeper and credit man for M. B. Goldenberg Co., Tucumcari, N. M., later entering the real estate and general insurance business. Concentrated on life insurance 1901 and built up one of the largest life insurance general agencies in the world, covering Arizona, New Mexico, Oklahoma and Texas. Retired from life insurance work March, 1916, to organize and build the Pan Motor Co.



with their reputations. All but two of them live in Saint Cloud and have their interests here and hereabouts. They meet regularly every week and as often as is necessary between. Some of them were born here. They are the reliable, dependable type of men—every last one of them. They are successful and mature in years and judgment. They do not lend their names and influence to enterprises other than the most substantial. They are hard workers, loyal to their associates and square dealers. They do not shirk duty or responsibility and when they go on the job they mean business. They are behind the Pan Motor Company with their whole hearts and souls, with their money and their might. As they have been successful personally and individually, they will be even more so unitedly. It is the law among men, as well as among states and nations. The Pan directorate is a twelve-cylinder organization, a powerful human engine, and is making the grade on high, because every cylinder is functioning. Coordination performs wonders. Here, then, is the Pan secret—unity of brains, energy, money and a worthy purpose—a successful combination.

Study their pictures—look them over critically—inspect their features—analyze their characters—read their minds and hearts, if you can; observe their records—note the work they are doing, the positions they hold, their standing in the business and financial world; and then make up your own mind as to the kinds of men they are. As they look out at you from these pages you must be impressed with their intelligence, their powerful personalities, their self-confidence, their grim determination. Twelve real men.



Chas. F. LADNER  
Vice President

Born in Penn., 1857; president Chas. F. Ladner Hardware Co., Saint Cloud, and Retail Hardware Merchants' Fire Insurance Co. and Hall Hardware Co., Minneapolis; vice president, Saint Cloud Iron Works and Miner Theatre Co., Saint Cloud; director Security State Bank and Commercial Club; county chairman Public Safety Commission; Liberty Loan director for Stearns County.





JOHN BARRITT  
Secretary

Born in England, 1879; specialized in higher accounting under English chartered accountant; secretary-treasurer and chief accountant for Bushworth Bros., Ltd., Engineers, Colne, England; came to America, 1908, to accept like position with Avery Scale Co., Milwaukee, Wis., a branch of W. & T. Avery Co., Ltd., Birmingham, England; was the founder and president Cheyenne (Wyoming) Business College.



CHARLES D. SCHWAB  
Treasurer

Born in Minn., 1872; president Farmers State Bank, Saint Cloud, and First State Bank of Clear Lake, also president Farmers Loan and Investment Company, of Saint Cloud, a hundred thousand dollar corporation. Mr. Schwab is quite wealthy, owns valuable farm and ore lands and is one of the most substantial bankers and business men of Minnesota.



HUGH EVANS

Born in South Bend, Minn., 1859; high school and business education; came to Saint Cloud in 1900 and organized the Saint Cloud Grocery Company, one of the large and prosperous wholesale firms of Central Minn., of which he is president; director of the Commercial Club; was mayor of Saint Cloud for two terms.



FRED SCHILPIN

Born at St. Joseph, Minn., 1868; is secretary-treasurer of the Saint Cloud Daily Times; one of the owners of the Security Blank Book and Printing Company of Saint Cloud, a modern and up-to-date establishment; the Associated Press member here and is postmaster of Saint Cloud. He is a thoroughly capable and successful business man, and a real live wire.



GEORGE E. HANSCOM

Born in Stearns County, Minn., 1872; received high school and business education; graduate Northern Indiana Normal School; president Merchants National Bank, Saint Cloud, and First State Bank of Stewartville; vice president State Bank of Mayer, State Bank of Watertown, State Bank of Maple Plain, State Bank of Long Lake, and Farmers and Merchants State Bank of Sedan.



CHARLES BUNNELL

Born in Canada, 1857; came to Minn. in 1887; was identified with N. P. Clark lumber and stock business and is now trustee for the Clark estate; treasurer Saint Cloud School Board; director Commercial Club; trustee Elks Lodge and director Elks Home Fund Association. He is one of the substantial business and stock men of Minnesota.



P. R. THIELMAN

Born in Saint Cloud, Minn., 1872, and is a splendid example of home-grown success. He is a large real estate operator; director of the Saint Cloud Farmers State Bank and secretary and treasurer of the Farmers Loan and Investment Company, a hundred thousand dollar corporation. He is a scientific and successful stock farmer and large land owner.



GEORGE HEIDMAN

Graduated from the Law College of Cincinnati University in 1895 and admitted to the bar by the Supreme Court of Ohio in the same year. Opened offices in Cincinnati and later his firm also had offices in New York. He is one of the country's most successful patent attorneys. Located in Chicago in 1907 as senior member of the firm of Heidman & Street.



H. C. ERVIN, Jr.

Born in Penn., 1886; educated Saint Cloud high school and University of Minn.; director, secretary-treasurer and manager Saint Cloud branch The H. C. Ervin Co., one of the leading flour manufacturers of Minn.; director and vice president Beltrami Elevator & Milling Co., Bemidji, Minn.; director Merchants National Bank, Saint Cloud. Ervin's Best is one of the most famous brands of flour.



NORMAN A. STREET

Born in Chicago, 1876, and has lived there ever since; graduate of Yale University and Northwestern University Law School. He is the son of a wealthy lumberman and a member of the law firm of Heidman & Street, successful Chicago attorneys, legal representatives of the Pan Motor Company, specializing in corporation practice, patent law and trade marks.



## EXECUTIVE DEPARTMENT

ALL success is of human origin. The greatest achievements are the work of man. Brains are behind every industry, large or small, and the quality and character of the brains determine the ultimate success of the enterprise. Human energy is the greatest power in the world. Final victory in the great war just ended was on the side of the sturdiest characters and the best thinkers. It is not guns nor food nor money nor men that brought the Hun to his knees. Indomitable manhood, unswerving devotion to the principles of right and justice, stalwart character and clear thinking, these were the forces upon which the nation relied and through which it achieved success.

So, in the industrial world, it is not money, it is not buildings and equipment, it is not location, it is not resources and facilities, it is not one or all of these combined that plays the leading role in the building and operation of a great enterprise. The human force, the brain power, the mental and physical energy of the organization, these are the deciding elements and where they are well supplied the victory is won.

It is doubtful if a more high class, evenly balanced organization was ever assembled than the one now directing the destinies of the Pan Motor Company. Headed by its founder and president, S. C. Pandolfo, one of the country's greatest organizers and executives, who has surrounded himself with men of wide financial and business experience and others possessing the highest type of ability in all the various branches of the automobile industry, this company has already astounded the world with its marvelous speed and splendid achievement. It is only fair to state that the story of a year as told in this book in word and picture has been made possible solely through the intelligence, foresight, energy and actual genius of Mr. Pandolfo and his faithful associates. They are the real power, the real force back of the Pan and with the momentum already gained it will be a comparatively easy matter to forge on and on until the last trench is won and the flag of Pan floats proudly over an American industrial institution, second to none, with its output in the markets of the world, giving comfort and service to the progressive and appreciative people of all nations.



J. H. McQUERRY  
Assistant to President



B. BRATTER  
Sales Manager



B. F. FORSYTH  
Advertising Manager



C. W. BATTLEY  
Traffic Manager



MANUEL SHERRY  
Purchasing Agent



C. W. WILLIAMS  
Assistant Advertising Manager



B. E. LANGWORTHY  
Assistant Purchasing Agent



F. G. CARVER  
Assistant Secretary to the President



CHAS. T. LAZZARI  
Foreign Secretary



J. B. MCGOLRICK  
Information and Reception



W. A. FURLONG  
Assistant to Secretary



G. E. TEAGUE  
Circulation Manager





H. M. DAHL  
Cashier



E. J. GORMAN  
Chief Auditor



E. M. JEFFERY  
Assistant Auditor



MRS. FLORENCE COLEMAN  
Company Postmistress



BO WESTMAN  
Internal Auditor



H. W. MURPHY  
Traveling Auditor



# ENGINEERING AND MANUFACTURING CORPS

**T**HE goods, the product, the output is the final test of any manufacturing enterprise. This is emphatically true of the automobile, truck and tractor business. The whole burden of permanent success is on the shoulders of the engineering and manufacturing staff and that is why the Pan management has been so particular in selecting its mechanics and skilled workmen in all branches of the industry. They are among the best in the country and what they do is done right. When they turn out a job it is finished, complete in every detail, nothing omitted, nothing included that should not be. The Pan product is made and will be made as good as it can be made, because it is and will continue to be the work of the best engineering and mechanical experts who can be obtained. The Pan car says to its owner: "I will take you to the place you are going; I will do all that you expect me to do, and more; I know but one duty and that is to serve you; you may depend upon me; I am reliable; that is the way I am built; my constitution is strong; I am equal to any task; I obey you cheerfully; your comfort, your pleasure and your convenience are my religion; that is the kind of an automobile I am."

It takes brains, experience and skill to build a car that can say to its owner: "Depend on me," and then live up to its promise to the last fiber of its being. The Pan plant has the brains, the experience and the skill and the Pan product is delivering the goods in that very manner.

What a satisfaction to know that the machine you are using is right; to know that the men who built it are right; to know that the company manufacturing it is right, and to know that you yourself are right in the purchase and possession of such a car.

If there is any doubt in the mind of the reader as to the high character of the Pan engineering and manufacturing corps that doubt may be readily dispelled by a study of the type of men holding leading positions in these departments. Every one of them has a record bristling with achievement in his particular field. Every one of them is holding his job on account of his special fitness, by virtue of his experience, his training and his native talent. Every one of them is ambitious, anxious to give to the company the best that is in him, loyal and conscientious to the core. Look them over, read their records, and then say whether or not they are capable of performing their duties to the last letter.



VICTOR GAUVREAU

Chief Automobile Designing Engineer



L. R. BROWN

Manager of Manufacturing



A. KRIEG

Chief Tractor Designing Engineer

Mr. Gauvreau is one of the most experienced and one of the most capable designing engineers in the country. He is a graduate of both the Portiers Technical High School and the Arts et Metiers Technical College of France and a member of the Society of Automotive Engineers. Prior to his connection with the Pan Motor Company Mr. Gauvreau was on the engineering staff of such well known companies as the Peugeot, Mercer, Chevrolet and Weston-Mott. He was research engineer on the Buick and designer of the Dodge; also the designer and builder of the famous Frontenac racers. His expert services are highly valued by the Pan management, as they mean much to the future success of the company. The best engineers design and build the best machines. Such being the case, the ultimate Pan should have no superiors.

Mr. Brown has had an exhaustive experience in practically every branch of the motor industry from the smallest job to the manager-ship. He had charge of special sales for the Seager Engine Works, Lansing, Mich., and was superintendent of the Neway Motor Company. He spent eight months of his own time in Detroit, Cleveland, and Toledo learning the methods of operations of production, also tooling and lining up of machinery and assembling for production and the personnel of the organization in the various automobile, truck and tractor plants. He was general superintendent and assistant factory manager of the Duplex Truck Company, and general superintendent of the Republic Truck Company, where he tripled production in one year. He was supervising the production of the Ordnance Department for the government in the Detroit district prior to coming with the Pan.

Mr. Krieg is one of the foremost tractor engineers in America and is regarded as an authority on the tractor. He is a graduate in mechanical engineering and a member of the Society of Automotive Engineers. He came to the Pan Motor Company from the Emerson-Brantingham Company, with whom he was associated for seven and one-half years as chief engineer of the Tractor Works and for whom he designed several highly successful machines. Mr. Krieg was also associated with the Westinghouse Air Brake Company, the Twin City Rapid Transit Company and the Fawcens Machine Company in various engineering capacities. He also has four years of practical shop work to his credit. With Mr. Krieg on the job the Pan tractor is destined to take a leading position among the best tractors of the future. Of this there can be no doubt.



R. J. FITNESS

Assistant Automobile Designing Engineer

Mr. Fitness came to the Pan Motor Company after thorough training and wide experience. He was educated at the Detroit Technical Institute, Detroit, Mich., and has been on the engineering staff of such well known companies as the Cadillac, Packard, Studebaker, Dodge Brothers, Continental Motors and Nordyke and Marmon. He is, therefore, well equipped for his present position with the Pan Motor Company through early technical training and practical knowledge obtained in the leading plants of the country. Mr. Fitness is a member of the Society of Automotive Engineers and is also one of the valued members of the Pan engineering corps. In him the company has another highly capable engineer who is ambitious and whose industry and mechanical genius are such as to guarantee for him a position of leadership in his chosen profession.



R. A. DeVLIEG

Methods Engineer

Mr. DeVlieg is a member of the Society of Automotive Engineers and has held the following positions prior to his coming with the Pan: Tool maker for the Olds Motor Co., Lansing, Mich.; tool maker and mechanic for the Burroughs Adding Machine Co., Detroit; draftsman for the Universal Motor Truck Co., Detroit; tool designer for the Cadillac Motor Co.; instructor in machine shop practice in Detroit evening high school four years; checker in engineering department, later assistant chief draftsman, still later chassis engineer and finally chief engineer ordnance division of the Dodge Brothers Motor Co.; chief engineer in charge of the machine and tool designing department Kearney & Trecker Co., Milwaukee, Wis. Such is the wide experience of Mr. DeVlieg. In the face of this splendid record who can deny his efficiency.



M. V. TERRY

Superintendent of Production

Mr. Terry came to the Pan from the Buick where he was mechanical engineer and designer of motor cars, trucks and engines. He was also truck designer for the Packard and axle and brake designer for the Weston Mott Company. He spent four and a half years with the Champion Ignition Company and rose from tool, die, gänge and special machinery designer to assistant engineer, and later chief engineer. He is a graduate of the University of Michigan where he received his degree of mechanical engineer. He holds a commission as Captain in the Engineer Officers Reserve Corps, and is also a member of the American Society of Mechanical Engineers. He is in charge of Factory Building No. 2, main production unit, where Pan cars are now being turned out. He knows his business thoroughly and is delivering the goods in a most satisfactory manner.



H. E. LAMBERT

Chief Draftsman, Tractor Dept.

Mr. Lambert is chief draftsman in the tractor designing department and is well qualified to perform the duties of that responsible position. He received technical training in the Mechanical Engineering College of the University of Minnesota and has had plenty of practical experience while holding important positions on the engineering staff of such concerns as the Diamond Iron Works and the Jessen Engineering Company of Minneapolis, the Llewellyn Iron Works of Los Angeles and the National Paper Box Company. Thus schooled and thus trained, he came to the Pan Motor Company and has made good. He is another able member of the efficient Pan staff. He is also a member of the Society of Automotive Engineers and is one of the most capable men in his line in the United States. It is this type of ability that insures permanent Pan success.



JOSEPH NELSON

Experimental Engineer

Mr. Nelson has had wide automobile experience with some of the best companies in the country and is well equipped for the position he holds with the Pan Motor Company. He has charge of the experimental engineering department and is the right man in the right place. He was associated with Mr. Gauvreau, chief designing engineer of the company, in designing and building the famous Frontenac racing cars. He was also connected with the Maxwell and the Buick companies and directed in the building and designing of their racers. He is not only well trained in the business, but has a capacity and a genius for the work, which enable him to obtain desired results promptly. Mr. Nelson is a wide-awake young man and is giving his best thought and his best energy to the position he now holds with the Pan Motor Company.



E. C. DESMET

Body Designing Engineer

Edgard C. DeSmet, body designing engineer for the Pan Motor Company, graduated with honors from the Industrial College of Ghent, Belgium, and studied body designing with Van den Plas, Brussels. He was a draftsman for the Locomobile and the Dodge companies and has made a fine record in his department of the automobile industry. Mr. DeSmet is the designer of the Pandolfo sleeping car body, which is the regular touring body for the "1919" or ultimate Pan Car, one of its highly valued and most attractive features. He has other top and body ideas which are practical and which, when fully developed, will doubtless prove of great value to the manufacturers and much convenience to the public. Mr. DeSmet is a young man with a good, clear head and has a promising future in store for him with the Pan Motor Company.



C. W. ROGERS

Body Finisher and Striper

Mr. Rogers has had about twelve years active experience in his line, serving four years with the D. F. Isaacs Carriage Company of Coffeyville, Kansas, as a carriage painter; three years with the Kansas City Southern Railroad Company at Pittsburg, Kansas, as a coach painter; three years with the Packard Missouri Motor Company of St. Louis, Missouri, as a body finisher; one year with Jones Motor Car Company of Wichita, Kansas, as body finisher, and one year with the Pan Motor Company as finisher and stripers. Mr. Rogers is a thoroughly capable mechanic and is a varnish expert of recognized ability. His long experience and natural talent for the work fully qualify him for the important position he holds. As a matter of fact, he could scarcely have a better or more favorable and satisfactory record.



F. A. GUSTAFSON

Superintendent Paint Shops

Mr. Gustafson got his first experience with Monroe Brothers, well known carriage builders of Illinois, and later went to Chicago, working for some of the oldest carriage firms in the state. He was with the Thomas Scott Carriage Company of St. Paul and the Mansor Tibbet White Elephant Buggy Company of St. Louis, later known as Deere & Mansor, for whom he was assistant manager for five years, and two years as foreman in the paint shop. He was stripers and ornamentor for the Pope Toledo Car Company, Toledo, O., and later went to the Velie Motor Car Company, Moline, Ill., acting as superintendent of their paint shops, for both pleasure car and truck plant, for nine years. While there he laid out and installed one of the most up-to-date paint shops in the country. From Moline he came to Saint Cloud and joined the Pan.



M. SHARRON

Enameling Expert

Mr. Sharron holds a responsible position, one requiring experience and skill of the highest character, and one that only a man of the most thorough training is qualified to fill. The Pan Motor Company has in its enameling expert just such a man. He is widely experienced and has a natural talent for the work that gives his services exceptional value. He was formerly in charge of the enameling department of the Velie Automobile Company of Moline, Ill. He was also in charge of the painting department of the Western Tube Company of Kewanee, Ill., and of the Allis-Chalmers Company, Milwaukee. Just prior to coming with the Pan organization, he completed the installation of the enameling system of the Jones Motor Car Company, Wichita, Kansas. He is, therefore, fully qualified and well equipped to meet all the requirements of his position.



W. STAUFFACHER  
Foreman Block Test

Got his first experience with the Hart Parr Company of Charles City, Iowa, serving two years on the erecting and assembling floor, one year in the testing and finishing department and three years on the road as service man and on sales. On leaving the Hart Company he accepted a position as foreman of the Minneapolis Steel & Machine Company of Minneapolis, Minn., in the testing and experimental departments. While there he made two trips to Texas on new tractors being tried out; and besides their own tractors, motors, lighting plants and other machines using motors for power, five hundred large tractors for the Case Company of Racine, Wis., and about 5,000 Bull Tractors for the Bull Tractor Company passed through his department. He had been with this company about five years when he came to the Pan. Mr. Stauffacher is making good.



O. H. HANSEN  
Factory Employment Manager

The position of employment manager is a highly important one in an enterprise having the magnitude of the Pan Motor Company. It not only requires training and experience in dealing with men, but also a natural ability to judge and handle skilled workers. The successful employment manager holds a vital position in modern industries and is doing a splendid work. Mr. Hansen fills this office for the Pan in a most satisfactory manner. He was formerly with Rathbone, Lard & Company, stove works, where he was time-keeper and paymaster for four years and later had charge of the receiving department and stock room. This work prepared him for the greater work he is now doing for the Pan. He has been with the company almost from the first and the high standard of its employees bespeaks his ability as factory employment manager.



GEORGE STONE  
Chief Automobile Inspector

Was born in Franklinville, N. Y., in 1889, and has been in the automobile business since 1909, in which year he embarked in the garage business for himself, conducting the enterprise successfully for three years. He then joined the Packard forces, holding an important position in the inspection department. In 1916 he was with the Elgin in a similar capacity and in 1917 he was on motor repairs for the Overland service in Buffalo, N. Y. He has thus had wide and continuous practical and manufacturing experience in the automobile industry and is particularly fitted for the important position he now holds and has held with the Pan Motor Company since December 1, 1917. Mr. Stone is doing exceptionally good work and has brought his department to a degree of efficiency which insures the best possible results. He has the true Pan idea of doing things.



J. A. KEENE  
Foreman Pattern Shop



M. N. SCHNETTLER  
Foreman of Automobile Assembly



JOHN POGREBA  
Foreman Service Department

Mr. Keene has the usual record found among the members of the mechanical and engineering staff of the Pan Motor Company. He was foreman of the pattern shop of the National Iron Company, Duluth, Minn., for seven years; J. A. Seck Manufacturing Company, Chicago, five years; Universal Pattern Machine Works, Minneapolis, one year. In addition to the above positions, he has done pattern making for the following concerns: Horton Manufacturing Company, Minneapolis; Allis-Chalmers Company, Milwaukee; Clark-Osborne, Erie, Pa. He was also foreman of the pattern shop of the Monitor Drill Company, St. Louis Park, Minn. Mr. Keene belongs to the highest and best class of skilled workmen and as foreman of the Pan pattern shop is making a new and enviable record, which not only means individual success but the furtherance of Pan success.

Mr. Schnettler is a well trained and widely experienced automobile man. Besides making the subject a special study, being a graduate of Rahe's Automobile Training School at Kansas City, Missouri, he has had six years of actual experience with some of the best companies in the business. He was connected with the Hupmobile people for two years and later was with the Velie Automobile Company for three years, from which position he came to the Pan Motor Company about a year ago. In his position here as foreman of assembly he has made good, his experience and training having proven to be of very great value to both himself and the Pan Motor Company. It is this character of expert talent that is placing the Pan car in the front rank of moderate priced automobiles and that may be relied upon to keep it there. Mr. Schnettler is an enthusiastic Pan fan.

Mr. Pogreba is another Pan Motor Company employee of ripe experience, having been connected with the McCadden Machine Works of Saint Cloud from 1912 to 1914 inclusive, making pistons and McCadden leakless piston rings for high powered machines and racing cars. He has been identified with the automobile business in various capacities for several years. His experience as a mechanic and his wide range of automobile knowledge and information are particularly valuable to him in his present position as foreman of the service department. He is a valuable man to the Pan Company. He has the energy and the necessary push to back his experience and training and is conducting his department according to the most approved and up-to-date methods, to which are added original and practical ideas of his own. He knows his business well.





H. J. CATER  
Chief of Guides, Factory

Mr. Cater is a wealthy retired farmer and was formerly in the banking business. He is too full of life to be idle and the position as chief of guides at the great Pan plant just suits him. He is a Saint Cloud product, knows the city and country hereabouts, is thoroughly familiar with the factory and its equipment, having seen it started and watched its rapid development to the present moment. He is affable and takes particular delight in supplying the visitor with the fullest and most complete information relative to the wonderful machinery housed in the various units of this great modern plant, of which he together with the rest of the staff are justly proud. Mr. Cater takes great interest in his work and is imbued with the genuine Pan spirit. He has great faith in the future of the company and is a faithful, loyal employee.



JOSEPH PELARSKE  
Maintenance Foreman

While the position Mr. Pelarske holds is not one of the first importance it requires a special type of ability inherent in few people. Inefficiency and neglect in his department is intolerable and for that reason he has been placed in charge as maintenance foreman in recognition of his experience in a similar position with the Great Northern Railway Company Car Shops at Waite Park, Minn., where he gave complete satisfaction and left a good, clean record. Mr. Pelarske knows his duties and the duties of those who are working under him and makes it his business to see that all details are looked after promptly and in the manner required in a modern, up-to-the-minute industrial plant. He spent thirty-five years of his life on a farm, which has been more or less true with many of the most prominent and capable men of the country.



WILLIAM GRIEBLER  
General Stock Keeper

Mr. Griebler spent twenty years of his life in the hardware, tinsmith and pump business, mastering it in all its various details. He then went on the road as cigar salesman, which position he held for eight years. Quitting the road, he entered the service of the City of Saint Cloud as a member of the fire department, remaining five years. These long terms in different lines have given him a wide experience which enables him to perform his present duties with the Pan Motor Company greatly to his credit and to the best interests of the company. His position is a responsible one and requires a man of considerable business training and the ability to handle innumerable details systematically and with dispatch. Mr. Griebler is such a man. An honest, conscientious worker, having constantly in mind the best interests of the company, he is rendering a valuable service.



A. R. SMITH

General Manager, Drop Forge Department

Mr. Smith is recognized as one of the leading drop forge experts in the country. He was general superintendent of the five forging plants of the Maxwell Automobile Company; general superintendent of forging for the United States Motor Company, and general superintendent of the Anderson Forge & Machine Company, where he turned out as much work in one shift as was previously done in two, which is a remarkable record. He was also connected with the Waverly Company, Indianapolis, and at another time with the Erie Foundry Company. His great experience and exceptional ability make his services invaluable to the Pan Motor Company, as general manager of its drop forge department. In fact Mr. Smith is regarded, and rightfully so, as one of the best on the efficient Pan force. His record in the drop forge business is one to be proud of.



JOHN D. BOYLE

Metalurgist, Drop Forge Dept.

Attended the Mining and Mechanical Institute, Freeland, Pa., and worked in the blacksmithing, forging and heat treating departments of Coxe Brothers Company, Drifton, Pa. Was on heavy gun forgings in the heat-treating department of the Bethlehem Steel Co., and later was transferred to the metalurgical, estimate and production departments. While with the Bethlehem Company he spent nearly three years in the service of the government in the Panama zone as master mechanic and mechanical inspector. He installed and was in complete charge of the heat-treating plant of the Chalmers and later was with the Anderson Drop Forge & Machine Company of Detroit as foreman of their laboratory and heat-treating department and in charge of their metalurgical department. He left the Anderson Company to come with the Pan Motor Company.



HENRY RADEMAKERS

Superintendent Die and Forge Shop

Attended Academy of Fine Arts and Technics, Rotterdam, Holland, three years; studied mechanical engineering Armour Institute, Chicago, five years; has made a speciality of die-sinking and drop forge work for twenty-eight years. He was foreman of the experimental department of the Vaughan-Bushnel Tool Works, Chicago; die-sinker with the Chicago Drop Forge & Foundry Co.; superintendent of die and forge departments of the Waverly Electric Automobile Co., Indianapolis, and later with Fenkle & Sons Co., Chicago; returned to the Chicago Drop Forge & Foundry Co. as chief inspector, and later became general foreman; was estimator for drop forge work with Whitman & Barnes, Chicago, and was with the Anderson Drop Forge & Machine Co. of Detroit as foreman of the die shop prior to his connection with the Pan Motor Company.



F. F. TAYLOR

Sales Manager, Drop Forge Department

Mr. Taylor has made steel, bought steel, sold steel and knows steel, having spent 15 years in the steel, automobile and drop forging business. His experiences in steel-making cover one year with the United Engineering & Foundry Co. of Pittsburg and two years with the Monarch Steel Casting Co. of Detroit. He was in the buying end of the business for the Continental Motors Co., the Packard Motor Car Co., the Lozier Motor Car Co., and the Detroit Steel Products Co., all of Detroit. Prior to his connection with the Pan Motor Company he was for four years with the Anderson Forge & Machine Co. of Detroit in the production and sales department. Mr. Taylor is a practical drop forging expert. There are few men in the country having the comprehensive steel information possessed by Mr. Taylor. He knows it from all angles.



FLOYD S. MILLER

Superintendent of Construction and Maintenance, Drop Forge Dept.

After leaving school Mr. Miller became a machinist, devoting three years to the trade. He then took up structural steel construction with the Vincennes Bridge & Construction Company, remaining in that line of business with the same company for about eight years. He was then advanced to the position of master mechanic, in which capacity he served the same company six years longer. He was in the employ of this company about fifteen years, all together, when he resigned to go with the Anderson Drop Forge & Machine Company of Detroit as their millwright foreman, remaining eighteen months. He left that concern to come with the Pan Motor Company, and his record here is in harmony with his experience, training and practical knowledge as a high class machinist who knows his business well and who works conscientiously.



W. H. WAYMAN

Production Manager, Drop Forge Dept.

Mr. Wayman is another able and experienced member of the production and manufacturing staff of the Pan Motor Company who has a good record and whose services are highly valued by the company. Before coming to the Pan as production manager he was connected with the Warner Gear Company of Muncie, Ind.; the Anderson Forge & Machine Company, and the Harroun Motor Company in similar capacities. Mr. Wayman is peculiarly fitted for his line of work both by nature and training and it is extremely doubtful if a better man could be found anywhere in the country to fill the important position he holds with such marked ability and such general satisfaction. His department gives evidence of being under the supervision of a master hand and the results obtained furnish ample proof that he is the right man for the position he holds.



E. F. CAMPBELL

Special Automobile Mechanic, Die Shop

Mr. Campbell has had about twenty years' experience in his line. For two years he was connected with the Gaar-Scott Machine Company of Richmond, Indiana, as machinist. From this position he went to the Manitoba Iron Works, Winnipeg, Canada, in the same capacity, remaining one year. He then entered business for himself and for four years operated a general machine repair shop at Long Prairie, Minnesota. Disposing of this business, he came to Saint Cloud and entered the employ of S. Ten Voorde as general automobile repair man, holding this position for twelve years. He then came to the Pan Motor Company and is a valuable acquisition as special mechanic in the die shop. He brought to his position many years of experience and practical training which he is now drawing on and which enables him to render the best of service in his line.



L. R. PORTER

Stock Keeper, Drop Forge Dept.

Mr. Porter was formerly traveling salesman for C. B. Henschel Manufacturing Company of Milwaukee, Wis., and is a thoroughly capable and experienced man. He has been with the Pan Motor Company almost from the first and has held other important positions, always performing his duties conscientiously and in a systematic, business-like manner. He is, therefore, not only a capable man in the abstract meaning, but is especially valuable to the enterprise in his present position, having in charge all raw stock and die storage materials while in process of production. He is peculiarly fitted for this work, which requires constant application and strict attention to details. His is a work that calls for native ability more even than experience and this is the quality with which Mr. Porter is especially endowed. His record with the company proves it.



HARRY ANDREWS

Foreman of Die Shop

Mr. Andrews is a well seasoned, high class man with a record that bespeaks competency and efficiency of the broadest and best type. After completing his schooling, he took up tool making as a trade, continuing in this line for about eight years. He spent six years with the Toledo Tool & Machine Company, Toledo, Ohio, as a die maker. He was with the Anderson Drop Forge & Machine Company, Detroit, Michigan, as a die sinker for ten years. He was in charge of the trimmers for this company for three years. He left the Anderson Drop Forge & Machine Company to join the Pan forces and has proven a highly valuable man to this company. As foreman of the die shop, Mr. Andrews is giving the highest satisfaction and is getting the right results. He keeps constantly in mind the best interests of the company and is well liked by his associates.



J. D. CLARK  
Trimmer Die Maker

Mr. Clark was with the Maxwell Motor Company, New Castle, Ind., for one year and the Imperial Drop Forging Company, Indianapolis, two years. He was also with the Anderson Drop Forge & Machine Company and Detroit Drop Forge Company of Detroit and the Indianapolis Drop Forge Company of Indianapolis. He held a position as machinist with the Hercules Gas Engine Works and the Bucyrus Steam Shovel Works, Evansville, Ind., and the Lyon Atlas Engine Works, Indianapolis. In addition he has had experience in automobile production work with the Chalmers Motor Company. Thus he has had a well rounded experience and comes to the Pan Motor Company fully prepared to perform all the duties devolving on him as trimmer die maker. He takes a personal pride in the high quality of the service rendered by the Pan engineering and mechanical staff.



E. L. JACKSON  
Die Sinker

Mr. Jackson's first position was with the Fairbanks-Morse Company of Indianapolis for whom he worked as a tool maker. He was with the Keyless Lock Company of Indianapolis in the same capacity. He held a position in the Frankford Arsenal, Philadelphia, as a trimmer maker and an apprentice die sinker for three and a half years. He was with the Union Switch & Signal Company of Swissvale, Pa., as a die sinker for two years; the Cleveland Axle & Manufacturing Company of Cleveland for one and a half years; the Imperial Forging Company of Indianapolis for nine months, and the Anderson Forge and Machine Company of Detroit for one year. He then joined the forces of the Studebaker Corporation and when that company began the erection of the 155 M.M. shell shop, Mr. Jackson was made superintendent of construction and equipment.



B. F. WATTS  
Die Sinker

Mr. Watts was educated in the public schools of Indianapolis and took a three year course in high school manual training. His first position was with the Waverly-Electric Automobile Company, Indianapolis, as an apprentice die sinker under A. R. Smith and Henry Rademakers. After six years with this company, he went to Newcastle, Indiana, and worked for the Maxwell Company, remaining one year. Returning to Indianapolis, he held positions with the Indianapolis Drop Forge and the Imperial Drop Forge Companies, covering a period of two years. He was with the Dodge Brothers for a time and spent over two years in the employ of the Anderson Forge & Machine Company, from which position he came to the Pan Motor Company which he says has one of the largest and most modern drop forge plants in the country.



LEON H. MILLER  
Die Sinker

Mr. Miller occupied a position as tool maker with the Republic Iron & Steel Company of Muncie, Indiana, with whom he remained for one year and six months. He then entered the employment of the Warner Gear Company, also of Muncie, remaining three years. He was die sinker with the Dean Forge Company of Muncie. This position he held for three years. He then went to the Maxwell Motor Company of New Castle, Indiana, remaining two years. He was with the Overland Axle Company of Canton, Ohio, one year and eight months, the Imperial Forge Company of Indianapolis, seven months, and the Anderson Forge & Machine Company of Detroit one year and six months. He left the Anderson people to join the Pan as a tool maker and drop forge die sinker. While working at his trade, Mr. Miller completed a course in mechanical engineering.



E. H. GERTZ  
Die Sinker

Mr. Gertz was a machinist in the employ of the Brown Hoist Machine Company, Cleveland, Ohio, and was on die work with the following concerns: Cleveland Hardware Company and Columbia Hardware Company of Cleveland, Ohio; Timken Axle Company and the Anderson Drop Forge Machine Company of Detroit, Mich. He was with the above companies eight years in the aggregate, six of which was spent as a die sinker. His record before his connection with the Pan Motor Company was that of a high class mechanic and conscientious worker. Since coming to Saint Cloud he has consistently maintained that high reputation and has made an enviable place for himself on the mechanical staff of this up-and-coming company. It is upon the type of workers represented by Mr. Gertz that this enterprise largely depends for its future success.



A. J. WILLIAMS  
Die Sinker

Mr. Williams has had a wide experience in his line. He was trimmer and die maker for two and a half years with the Anderson Drop Forge & Machine Company of Detroit, Michigan, prior to his coming with the Pan Motor Company. He had previously held the position of trimmer and die sinker with the Detroit Forge Company, Detroit, Michigan, where he remained one year; Timken Detroit Axle Company, Detroit, Michigan, one year; Pontiac Drop Forge Company, Pontiac, Michigan, one year, and the Dominion Forging & Stamping Company, Walkerville, Ont., one and a half years. This gave Mr. Williams six years of drop forging and die making experience before his connection with Pan. His work is high class and shows evidences of thorough training and true mechanical skill. He has the Pan spirit and gives the company the best that is in him.



P. C. DEPEW

Receiving and Shipping Clerk

Mr. DePew, was in the railway mail service for six years, which experience did much to broaden and quicken his comprehension of his present duties with the Pan Motor Company. He also had road experience, traveling for the Drake Marble & Tile Company of Minneapolis. He was for a time connected with the Boyd Transfer Company of Minneapolis. Later he was receiving and shipping clerk for the Presto-Lite Company at St. Louis Park, Minn. He held a like position with the Monitor Drill Company at St. Louis Park and for the Fiske Rubber Company of Minneapolis. He was with this last named company when he decided to cast his lot with the rapidly growing Pan Motor Company as its receiving and shipping clerk, a position his years of training and his natural aptitude had prepared him to fill in a most satisfactory manner.



A. C. PETTERS

Tool Maker, Die Shop

Mr. Petters holds his position on account of his special fitness for the work. He got his training in positions requiring the widest latitude and the most comprehensive knowledge of the business, such as machinist for the Minneapolis Steel & Machinery Company, Minneapolis; the Grundman Auto Company, Saint Cloud, and the McCadden Machine Works, Saint Cloud. In this last position, he had charge of all tool and jig work. Being apt and having a mechanical mind of unusual acuteness, Mr. Petters has developed into a high class, expert machinist. In his present position as tool maker in the die shop of the Pan Motor Company, he has given the best of satisfaction and his services contribute largely towards maintaining the high standard of workmanship already well established by the mechanical and engineering forces of the Pan Company.



F. M. DERRY

Die Sinker

Mr. Derry's experience dates back ten years when he first entered the employ of the Dayton Motor Company, Dayton, Ohio. Since that time, he has held important positions in his special line with the following widely-known companies: Maxwell Motor Company, New Castle, Ind.; Hercules Forge Company, Imperial Forge Company, Downey-Milford-Shields Company, and the Waverly Company, Indianapolis, Ind.; Michigan Forge Company, Pontiac, Michigan; Anderson Drop Forge & Machine Company, Timken Axle Company and Dodge Bros. Company of Detroit. He resigned his position with the last named company to come with the Pan Motor Company. It would be indeed hard for a man to obtain a wider or more thorough experience and training in drop forging and die making than has been afforded Mr. Derry through the above positions.



GEORGE BOOTH

Works Managing Engineer

George Booth was factory mechanical engineer for the Buick and was formerly designer for the Welch Motor Company, Pontiac, Michigan. He worked in like capacities for the Palmer-Bee Company, Detroit; Goodman Manufacturing Company; Davy Brothers, Sheffield, England; Hick-Hargreaves & Company, Bolton, England, and other prominent concerns. He graduated from the Preston (England) High School and served a seven years apprenticeship with Markham & Company engineers, Chesterfield, England. As Works Managing Engineer the Pan Motor Company has in Mr. Booth an exceptionally efficient and highly valuable man, well trained, with wide experience and marked ability. His record since coming with the Pan is one of which he may feel justly proud. Mr. Booth meets every requirement of his exacting position and gets the best results.



J. M. ALDEN

Chief Draftsman, Works Dept.

Mr. Alden has had an active experience in his line covering a period of seventeen years in the following positions: Two years as draftsman with Omeyer & Thori, architects; one year as draftsman with Thomas G. Holyoke, architect; two years as draftsman in the engineering department of the Great Northern Railway; six years as chief draftsman with J. Walter Stevens, architect; and six years in architectural practice as a member of the firm of Alden & Harris, architects, all of St. Paul, Minn. He discontinued the partnership in April owing to unfavorable conditions imposed by the war and shortly afterwards entered the employ of the Pan Motor Company. He has specialized in structural and reinforced concrete engineering and heating and ventilation. His long experience and natural aptitude have made him highly proficient.



PAUL REUTER

Mechanical Engineer, Works Dept.

Paul Reuter received a technical education in one of the foremost schools of Europe and is a man of wide experience and much native mechanical ability. He designed automatic machinery for a New York incline railway and was one of the leading designers for the Dodge Brothers Company of Detroit, Michigan. One of his recent important jobs before coming to the Pan Motor Company was the erection of six modern electric gantry cranes in the United States Navy Yards. His early training, his ability and his record are in harmony with the usual Pan Motor Company standards and his work as mechanical engineer for the company has been highly satisfactory, possessing the qualities of the expert. But nothing less was to be expected of a man who had behind him such a splendid record in mechanical engineering achievement.





HARMON E. BECKER  
Chief Operating Engineer

Mr. Becker is one of the best posted steam, electric light and power men in the Northwest, having had many years of experience in this line of work in connection with some of the largest and most efficient plants in the state. He organized, financed and managed the Foley Electric Light and Power Company in 1911 and in 1916 disposed of the business, selling out to the Saint Cloud Public Service Company. He supervised the building of a high line for the Globe Electric Company of Milwaukee and at one time was assistant chief operator of the Twin City Rapid Transit Company. He was also connected with the Minneapolis General Electric and the Consolidated Milling Company. This wide and varied experience has served to equip him with the necessary engineering knowledge required in the important position he now holds with the Pan Motor Company.



CHAS. A. TYLER  
Foreman Electrical Production

Mr. Tyler has been in the electrical business practically all his life. He was employed for six years by the Bell Telephone Company and for four years of that time was wire chief. He was with the Allis-Chalmers Manufacturing Company for three years on construction and maintenance, and was night chief electrician for one year with the A. O. Smith Automobile Parts Company. For two years he was with the Watab Pulp and Paper Company of Sartell, Minnesota, as armature winder and general repair man. This varied experience, covering a period of twelve years with leading and well known companies, has equipped him thoroughly for his present important position with the Pan Motor Company. Mr. Tyler is a clean cut, clear-thinking, ambitious young man and is giving his best energies to his present work. He is getting good results.



H. W. SULLIVAN  
Chief Engineer Power Plants

Mr. Sullivan has had twelve years' experience on power plant work. He was employed by the Bridgeman-Russel Company of Duluth, Minnesota, for three years as assistant engineer, and was assistant engineer at the Minnesota State Reformatory for nine years. In addition to his practical experience he has completed a correspondence course in steam engineering with the International Correspondence School of Scranton, Pa. He came with the Pan Motor Company August 1st, 1918, and as chief steam engineer in the main power plant is rendering efficient and satisfactory service. Mr. Sullivan is a practical man and has also mastered the theoretical side of the steam engineering science. Consequently his knowledge of power plant work is thorough and complete. The Pan Motor Company has in Mr. Sullivan a highly capable steam engineer.



GROUP OF PAN MOTOR COMPANY EMPLOYEES TAKEN IN FRONT OF MAIN UNIT



ANOTHER VIEW OF THE DROP FORGE PLANT GROUP



# GENERAL OFFICES



FIRST NATIONAL BANK BUILDING



**T**HE various factory heads of the Pan Motor Company have their offices at the plant, while the general offices of the company are located in the downtown section of Saint Cloud. Those of the president, traffic manager, advertising manager and publicity department occupy the entire third floor of the First National Bank Building; the secretary's offices and the auditing department are on the second and third floors of The Farmers' State Bank Building, while the mailing and circulating departments are located at 218 Fifth Ave. South, where they occupy two floors and the basement, or the entire building. This arrangement is temporary and will obtain only until such time as the company can erect its own office and administration building at the plant, as contemplated in the original plans.

Concluded on page 227



BOARD OF EDUCATION BUILDING, 218 FIFTH AVENUE SOUTH  
Entire building occupied by the Company.



FARMERS' STATE BANK BUILDING, 18 FIFTH AVENUE SOUTH  
The first offices of the Company were located here.



OFFICE OF PRESIDENT AND GENERAL MANAGER  
First National Bank Building



EXECUTIVE RECEPTION AND SECRETARY  
First National Bank Building



ASSISTANT EXECUTIVE SECRETARY'S DEPARTMENT  
First National Bank Building



EXECUTIVE STENOGRAPHIC DEPARTMENT  
First National Bank Building



OFFICE OF ADVERTISING MANAGER  
First National Bank Building



OFFICE OF SALES MANAGER  
First National Bank Building



ASSISTANT ADVERTISING MANAGER'S OFFICE  
First National Bank Building



SALES AND ADVERTISING STENOGRAPHIC DEPARTMENT  
First National Bank Building



OFFICE OF SECRETARY  
Farmers' State Bank Building



ASSISTANTS TO SECRETARY  
Farmers' State Bank Building



RECEPTION—SECRETARY'S DEPARTMENT  
Farmers' State Bank Building



CASHIER'S OFFICE  
Farmers' State Bank Building



COMPANY POST OFFICE  
Farmers' State Bank Building



FILING DEPARTMENT  
Farmers' State Bank Building



SECRETARIAL DEPARTMENT  
Farmers' State Bank Building



OFFICE OF FOREIGN SECRETARY  
Farmers' State Bank Building





CHIEF AUDITOR'S OFFICE  
Farmers' State Bank Building



SECTION OF AUDITING DEPARTMENT  
Farmers' State Bank Building



TRAFFIC STENOGRAPHIC DEPARTMENT  
First National Bank Building



SECTION OF AUDITING DEPARTMENT  
Farmers' State Bank Building



OFFICE OF TRAFFIC MANAGER  
First National Bank Building



OFFICE OF CIRCULATION MANAGER  
Board of Education Building



ADDRESSING DEPARTMENT  
Board of Education Building



GOVERNMENT ENVELOPE STORAGE  
Board of Education Building



MAILING DEPARTMENT  
Board of Education Building



ADDRESSOGRAPH DEPARTMENT  
Board of Education Building



MULTIGRAPH DEPARTMENT  
Board of Education Building



STATIONERY AND PRINTING STOCK ROOM  
Board of Education Building



RECEPTION  
Factory Building Number Two



OFFICE OF PURCHASING AGENT  
Factory Building Number Two



INTERNAL AUDITING DEPARTMENT  
Factory Building Number Two



OFFICE OF CHIEF OPERATING ENGINEER  
Factory Building Number Two



OFFICE OF WORKS MANAGING ENGINEER  
Factory Building Number Two



MECHANICAL ENGINEER, WORKS DEPARTMENT OFFICE  
Factory Building Number Two



DRAFTING ROOM—WORKS DEPARTMENT  
Factory Building Number Two



WEIGHMASTER, SHIPPING AND RECEIVING DEPARTMENT  
Factory Building Number Two



AUTOMOBILE DESIGNING ENGINEER'S OFFICE  
Experimental Engineering Building



TRACTOR DESIGNING ENGINEER'S OFFICE  
Experimental Engineering Building



DRAFTING ROOM—ENGINEERING DEPARTMENT  
Experimental Engineering Building



OFFICE OF SUPERINTENDENT OF PRODUCTION  
Factory Building Number Two



SECRETARY'S OFFICE, DROP FORGE DEPARTMENT  
Drop Forge Office Building



SECTION OF TIMEKEEPER'S OFFICE  
Drop Forge Office Building

General Offices—Concluded from page 216

Some idea of the remarkable growth of the company and its present enormous proportions may be had from the fact that at the beginning a little over a year ago three small offices in the Farmers' State Bank Building furnished ample room for all purposes. The immediate and rapid expansion of the business, however, soon demanded more space, and continued to demand more from time to time until it now requires the equal of a six-story modern business building to accommodate its various executive and administrative departments, occupying, as it does, a total aggregate floor space of about 18,000 square feet. This figure does not include the floor space occupied by the various engineering and manufacturing staffs in several of the factory buildings which would bring the total to nearly twice the amount.

Just as this book is going to press plans are under way to locate all of the administrative offices in factory building No. 2 because of the rapidly expanding business of the company. New departments are being constantly added and the present ones enlarged. New members are being added almost daily to the various staffs as the wheels of the Pan industry turn faster.

Pan is growing bigger and faster each day.



OFFICE OF GENERAL MANAGER DROP FORGE DEPARTMENT  
Drop Forge Office Building



OFFICE OF SALES MANAGER DROP FORGE DEPARTMENT  
Drop Forge Office Building



OFFICE PRODUCTION SUPERINTENDENT DROP FORGE DEPT.  
Drop Forge Office Building



DRAFTING ROOM DROP FORGE DEPARTMENT  
Drop Forge Office Building





LOOKING DOWN MAIN AISLE FACTORY BUILDING NUMBER TWO

A well lighted, well ventilated and well planned factory building that can be easily adapted for various other manufacturing purposes and a type that can be extended to take care of future expansion.





# PAN TOWN ON THE MISSISSIPPI



The Above Colored Photographs Show the Residence and Grounds of S. C. Pandolfo, President of the Pan Motor Company, which adjoins Pan Town, where Mr. Pandolfo has built over fifty homes for other officers and employes of the company





STREET SCENES IN PAN-TOWN

Note the Improvements—Sidewalks, Curbs, Graded Streets, Lights, Trees, Shrubbery and Lawns.

**A**MONG all the large industrial centers of the country there are but very few in which the housing question is not—even today—a most serious problem. In many communities it has been found necessary to appoint special committees and employ experts to investigate and look for a solution that shall make for a better town in which to live. Tenement surroundings do not go far toward making happy home circles and dissatisfied men do not produce the best results.

In communities like Saint Cloud, which pride themselves upon the number of individually owned homes, a sudden influx of many new people presents at once a most troubling housing problem. This question was not lost sight of when Mr. Pandolfo began the construction of the huge plant. There were no surplus houses in the town where the staff and other employees could find homes. Coincident with the beginning of the factory construction he at once secured a tract of land near the plant, yet far enough away to be free from smoke, noise and other possible discomforts. On this tract there are now



STREET SCENES IN PAN-TOWN

No Unsightly "Company Houses" Here—Every One a Modern Home and Different.

58 homes completed, all built by capital independent of the Pan Motor Company. All of these are of modern type, actually handsome, and with a variety of architecture as to make this new town, "Pan-Town-On-The-Mississippi," as it is called, added to a good old town, a thing of beauty. It has its own sewerage system; a white way lighting system, placed upon concrete ornamental posts, is set up; an entirely independent water system is provided, with pure water supplied for all purposes from deep wells. It has its own volunteer fire department, and police protection. Sidewalks and curb are in and the streets are graded. Its landscaping is under the supervision of an expert.

An organization, in which every resident of the community is a member, meets at regular intervals to discuss and take action on matters that affect the welfare of the little city. A Sunday School has been provided and a school site has been secured nearby. Social events of various nature provide a fund of wholesome entertainment.

Concluded on page 236



PLAT OF PAN ADDITION ("PAN-TOWN") TO CITY OF SAINT CLOUD  
 Shaded Portion Indicates Lots On Which Homes Have Already Been Built



Lot 11—Block 2



Lot 21—Block 5

Pan-Town—Concluded from page 231

This addition would grace the best residential districts of any city in the country. And, best of all, Mr. Pandolfo gives any employee of the company who desires to own his own home, every facility to purchase the property on easy payments and long time with low interest charges. This feature alone will be worth much to the enterprise, as through it there will come a community spirit not often found in industrial projects.

For the unmarried workman and for the public generally a modern hotel has been built by Mr. Pandolfo at a cost of nearly \$20,000, and is now in operation. It is well appointed throughout and is under the supervision of experienced management, being conducted on a plan calculated to foster harmony and a spirit of pull together among the employees of the company who make it their home.

Other features, which enter into real fundamentals, will be incorporated among the desirable advantages of Pan-Town from time to time and as rapidly as possible. A hospital to care for the sick; a community house for the entertainment and club life of the hundreds of employees; an athletic field for the indulgence of manly sports, all will have their part in this great whole, which to the careful observer looks about like the last word in the industrial development of our times and furnishes unquestionable evidence of a directing intelligence that sees clearly into the future and prepares in advance for all eventualities.





Lot 22—Block 6



Lot 13—Block 3



Lot 2—Block 5



Lot 23—Block 5



INTERIOR VIEWS PAN-TOWN HOMES



WELL PLANNED COMFORTABLY FURNISHED ROOMS CHARACTERIZE PAN-TOWN HOMES



Lot 13—Block 6



Lot 12—Block 6



Lot 21—Block 2



Lot 19—Block 4



Lot 10—Block 3



Lot 10—Block 2



Lot 15—Block 5



Lot 22—Block 3



Lot 11—Block 2



Lot 2—Block 2



Lot 19—Block 2



Lot 18—Block 2



INTERIOR VIEWS PAN-TOWN HOMES



HERE ONE FINDS THE "HOMEY ATMOSPHERE" SO OFTEN LACKING IN INDUSTRIAL HOME SITES



Lot 11—Block 6



Lot 11—Block 3



Lot 8—Block 2



Lot 22—Block 2



Lot 1—Block 5



Lot 6—Block 2



Lot 6—Block 5



Lot 20—Block 3





INTERIOR VIEWS PAN-TOWN HOMES



PAN-TOWN PROVIDES AN ESSENTIAL FACTOR TO THE WORKER'S SUCCESS—RIGHT LIVING



Lot 4—Block 2



Lot 15—Block 2



Lot 10—Block 4



Lot 19—Block 5



Lot 12—Block 2



Lot 20—Block 6



Lot 16—Block 3



Lot 7—Block 3



Lot 1—Block 6



Lot 12—Block 3



Lot 20—Block 2



Lot 21—Block 4



Lot 17—Block 1



Lot 8—Block 5



Lot 3—Block 3



Lot 5—Block 3



Lot 16—Block 2



Lot 13—Block 2



Lot 10—Block 5



Lot 18—Block 3



Lot 18—Block 6



Lot 8—Block 6



Lot 17—Block 5



Lot 16—Block 6



Lot 10—Block 6



Lot 6—Block 6



Lot 15—Block 4



Lot 14—Block 6





Lot 9—Block 3



Lot 17—Block 2



Lot 2—Block 6



Lot 11—Block 3



**THE MOTOR HOTEL**  
Is Located Near the Plant

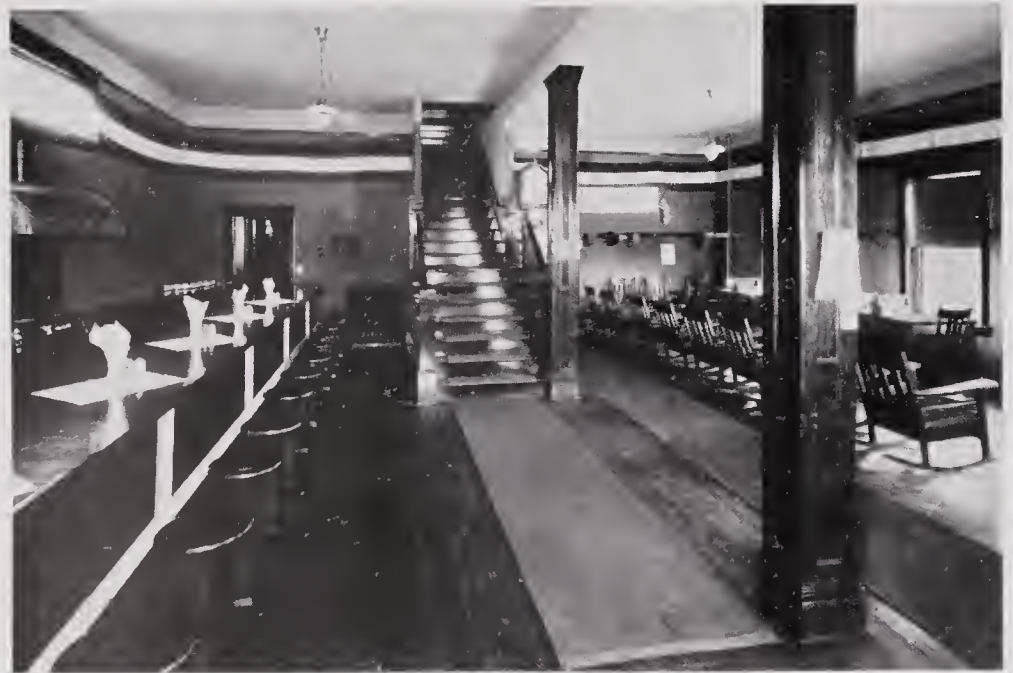

**THE LOBBY**  
Counter Lunches Can Be Served At All Hours



**HOTEL DINING ROOM**  
Where Meals Taste Like Real Home Cooking



**HOTEL KITCHEN**  
Is Modernly Equipped and Clean



# PEACE

**J**UST as this book is going to press the civilized world is thrilled with the greatest news story of all time. An armistice has been signed. The war is over. Peace has come at last. No, peace has not come. It was not a case of coming. Peace has been bought and dearly paid for. Like any other prize that is worth winning, it had to be purchased at a cost. No prize ever cost more. Let us hope that it will be worth the price.

As this has been the most destructive war in history, may the period we are now entering upon be the most constructive.

The human race has done its worst. May it now do its best.

Where there is famine, may there be plenty. Where there is sorrow, may there be happiness. Where there is hate, may there be love.

Let us transform our war tanks into farm tractors and proceed to make the world secure in prosperity.

Let everybody get in the game. Let every dollar do its bit.

It was necessary a little while ago for all of us to make bullets. It is necessary now that we make hay.

The only way that war can be finally and completely justified is through its beneficial effects. It is up to us to see that nothing but good comes out of the inferno through which the world has just passed.

If this nation will devote half the energy to industry and commerce and the proper development of its natural resources that it devoted to the winning of the war we will soon have Old Man Poverty and all his family backed up in the corner yelling for ice water.

With the same earnestness of purpose and the same determination which the Pan Motor Company manifested in promptly placing its plant, its services, its all, at the disposal of the Government when war was declared, it now enters upon the reconstruction period. Everything it is or hopes to be is dedicated to the cause of peace.

Peace, prosperity—a better and richer world—is the purpose and the prayer of Pan.





# FUTURE PLANS







## LIFTING THE VEIL OF THE FUTURE

**W**HILE the Pan Motor Company has already reached a stage where it may be classed among the big industries of the nation, with its great modern plant units now in operation and with an army of 50,000 loyal boosters who have invested in its capital stock, it is really only in its swaddling clothes. While it has made unparalleled progress and developed unheard of speed in building and financing, all that has been done so far is simply of a preliminary character, preparing for and leading up to vastly greater eventualities.

Given the money and the influence there is no limit to achievement, no human possibility that may not be successfully accomplished. This fact is well illustrated in the effective manner in which our country entered the European War. The United States had the money and it had the men. There could be only one result—the best fed and best equipped army in the world—which meant victory, success. There is nothing that money and influence cannot do. Nobody knows this better than the founder of the Pan Motor Company and his plans from the beginning had their foundation and inspiration in this certain definite knowledge.

S. C. Pandolfo does not hedge himself about by limitations nor will he allow the Pan Company to be so restrained in its future operations. On the contrary, his original aim and object was to develop a world enterprise whose ramifications would necessarily extend in many directions, embracing not alone the manufacture of automobiles, trucks and tractors, though these are three distinct industries in themselves, with their necessary adjuncts represented in the drop forge and die plants, also distinct industries, but in addition a tire plant and eventually steel mills.

The steel business, supplying limitless opportunity for the investment of capital and being the most stable industry in the world, offers a fitting culmination for a project of the scope and character of the Pan Motor Company and with it will come a full realization of the purposes and complete rounding



out of the plans of the man whose mental and physical energies brought the organization into being and made this comprehensive and seemingly pretentious program not only possible, but logical and practical, with every stage in its development coming in its proper sequence and as the natural outgrowth of prior activities and successes.

There is no metal having the commercial value of steel and none so universally used in its various shapes and forms. Steel comes nearer possessing actual intrinsic money value in a wider sense than any other commodity and is the foundation of more articles of manufacture than any other metal. Of course, it is generally understood that steel enters largely into the manufacture of automobiles, trucks and tractors and plays a major part in all die making and drop forgings.

Imagine the wonderful advantages, therefore, of the company operating in all these various industries and supplying itself from its own iron mines, smelters and steel mills with this essential and valuable product; operating and owning its own brass, aluminum and grey iron foundries; its own machine shops, to be among the largest in the world; its own woodworking and body departments, second to none; its own sheet metal works; its own wheel factory, and eventually its own water power plant. This is the ultimate aim of the Pan Motor Company and it may be said right here that while it is a big undertaking and will require vast sums of money and influential backing of the most positive and determined type, its day of realization is by no means remote. In five years from now this company hopes to be, expects to be, and should be a hundred million dollar corporation, with its several distinct factories operating in all the various lines mentioned above, with its products, superior in design and character of construction and equitably priced, supplying the markets of the world.

What does this mean to the public? What does it mean to the company? What does it mean to Pan employees?

To the public it means that the best engineering and mechanical skill, the latest machinery and the world's most modern plants will supply it with the most serviceable automobile, truck and tractor, the best tire and other products, built and constructed under the most favorable conditions. Having its own mines and its own steel mills from which to draw its raw materials, with its various other plants, factories and departments, and producing on a mammoth scale, the actual cost of the finished





article will be reduced to a minimum. This reduction in the cost of production will have its natural sequence in a reduced selling price, which will mean a substantial saving to the ultimate consumer. The two tendencies of a big business of this character operating in the public's favor are in the direction of a better product and a smaller cost. The higher the grade the lower the price, is a paradoxical expression, but when applied to the products of the ultimate Pan Motor Company its truth cannot be reasonably questioned. Thus the public will profit in two important ways: It will be able to buy better goods for less money, and, as Shakespeare said, this is "a consummation devoutly to be wished."

To the company it means that it will receive the profits from several individual and distinct industries, any one of which has practically unlimited possibilities. It is not necessary here to give figures and details relating to the enormous profits that have been made in the automobile business. Every school boy knows that it is one of the biggest money-making industries in the world. The same is true of the tire business; and the steel business is regarded the world over as the king of all industries. The truck and the tractor are of more recent origin, but both are well established, and the future agricultural and commercial development of the nations of the earth will demand these in constantly increasing numbers. As a matter of fact, it is extremely doubtful if any known industry has the future possibilities of either the truck or the tractor, and the company engaging in their manufacture on a large scale, turning out high grade and fairly priced machines, is going to reap a rich harvest for years to come. Is there a company in the land with greater or wider possibilities?

To Pan employees it means that they will be on the pay roll of the biggest-souled corporation in existence, one that will take particular and especial care to provide the most delightful surroundings, both in the plants and in the homes. Living and working conditions will be as nearly ideal as it is possible to make them. The most liberal wage scale will be established and in addition thereto all company employees will share generously in the profits of the business, this being the avowed policy of the founder of the enterprise and one of the many features of the project which have operated in the creation of such a wide and friendly public sentiment in favor of the Pan Motor Company.

This, then, is the destiny of the Pan organization and no mental or physical energy, no human effort and no money will be spared in bringing the business to its final stage of development, making of it a world enterprise in the fullest sense, supplying a world market with those articles most necessary



to world progress, giving employment to thousands of contented workmen and earning handsome profits on all money invested.

Of course, there are Doubting Thomases. There are those who will say it is only a dream; it can't be done, just as there were those who said a year ago that what is now could never be. This book furnishes undeniable evidence of the mistakes of the latter; and, so, the Pan book of the future, when the final chapter is written, will prove the error of those who now contend that the program as outlined above is impractical and impossible. The doubter jumps at conclusions. He talks without thinking. Never having done anything worth while himself and knowing that he never will, he naturally doubts the ability and capacity of others. He forgets, if he ever knew, that there is nothing impossible to those who have the will to win. He forgets, if he ever knew, that money and influence are capable of any human accomplishment. He forgets, if he ever knew, that the Pan Motor Company is one of the most efficient organizations in the world today, that it is inspired by the highest and best motives, that it is in existence for the purpose of being just what it started out to be and none other and that it has at its head the necessary executive ability to bring it to ultimate success.

Let those who doubt the immediate future of this company learn their lesson from its short, but eventful past. Let those who say it can't be done open their eyes to substantial, material actualities; let them consider well what has been done and then, using the reason and the wisdom that God has given them, let them form just, rational and impartial conclusions as to what can be and what will be done through the same agencies that have operated thus far in bringing the Pan Motor Company to its present high state of development. What has been can be and five more years like the one just past, with the impetus that naturally belongs to a moving organization, growing in power with increasing speed, the Pan should be the identical thing it is intended to be—a leading world enterprise, with a heart and a soul, backed by all the money and all the influence necessary to make its presence felt in every corner of the earth. A great, big, good-natured giant, with unlimited human power and a surplus of financial strength that can never be used to the utmost; this is the Pan Motor Company of the future.



## Plans, Purposes and Objects for Which the Pan Motor Company was Organized

- First—To design, perfect and manufacture the most practical and useful popular-priced automobile possible.
- Second—To design, develop and manufacture the most serviceable and common sense all around farm tractor that men, money and up-to-date machinery can build.
- Third—To design, to refine and to perfect in its experimental department and on the road the most desirable and satisfactory medium-priced truck that engineers, mechanics, men and money and machinery can build; and then manufacture it in big quantities.
- Fourth—To build and equip and eventually have the finest, the best, the most up-to-date and the largest drop forge department in the world.
- Fifth—To eventually build and operate its own Rubber Tire Factory.
- Sixth—To own, within a few years, its own Iron Mines.
- Seventh—To build, own and operate, some time in the future, its own Smelters and Steel Mills.
- Eighth—To build, own and operate its own brass, aluminum and grey iron foundries, just as soon as possible.
- Ninth—To own and operate its own machine shop, which, it is believed when eventually completed and fully equipped, will be one of the largest and very best in the world.
- Tenth—To build, own and operate its own Woodworking and Body Departments, which, it is intended, shall be second to none.
- Eleventh—To build, own and operate its own sheet metal works.
- Twelfth—To build, own and operate its own wheel factory.
- Thirteenth—To eventually construct and own, if possible, its own water power plant.
- Fourteenth—To become, as rapidly as possible, a Giant Manufacturing Institution, which is a very different thing from an assembling proposition, and to make good, in a big way, for those who might have vested interests in it.



THE FIRST PAN!

The first Pan Cars made their appearance on the streets of Saint Cloud early in July 1917. They were built at Indianapolis by a firm of consulting engineers then employed by the Company. Every one of the original Pans are still in service.



# THE PROMOTER

**T**HIS is not the Stone Age. Conditions that prevailed before the flood do not prevail now. The modern man is not a bearded beast. Why? Because some fellow promoted the razor.

The ox cart is a thing of the past. Why? Because the steam engine, the automobile and the flying machine have been promoted.

Battering rams are not popular in modern warfare. Why? Because T. N. T. and other explosives are on the job.

The world owes its deliverance from crude methods to the promoter. The promoter has brought us knowledge, comfort, convenience and happiness.

The fig leaf has been superseded by the seal skin. Woven silk has taken the place of straw. Why? Because the promoter has been busy.

Instead of the tallow candle we have the electric light. Why? Because some crazy individual got a brilliant idea and promoted it successfully.

We know the earth is not flat. Why? Because Columbus, a great promoter, proved that it is round.

Our religion, the best on earth, is the work of the world's greatest Promoter—Jesus. He was crucified.

In spite of his magnanimous character and splendid works the promoter has been discredited, lied about, maligned. It is too bad. But it is a human trait. The fellow that does the most good gets the least credit, especially in his own time and generation.

There are exceptions. President Wilson is promoting peace and the civilized world is with him.

Our esteemed countryman, Charles Schwab, who promoted steel so long and with such rare ability, but whose success made him enemies, is now promoting shipping, as only a real promoter could, with the unanimous approval of the people.

Promoting is the grandest, noblest business on earth. The promoter has brought order out of chaos. With barbarism as his only raw material he developed civilization. He has humanized, Christianized and civilized the cave man.



Democracy, the highest and best form of human government yet evolved, to perpetuate the principles of which this nation has just given its best blood, was originally the idea and later the achievement of the promoter.

Freedom of thought, freedom of speech, freedom of action—the right to live—we owe to the promoter.

England's Magna Charta, the Declaration of Independence and the Constitution of the United States were the promotions of oppressed peoples.

Moses promoted the Ten Commandments; and the Golden Rule, first in its negative form and later in its present, perfect, positive form, as enunciated by Jesus, stands out as the star promotion of the ages.

Fulton promoted the steam boat; Howe the sewing machine. Harvey promoted the knowledge of the circulation of the blood; Newton that of the law of gravity; and Darwin promoted the idea of the survival of the fittest.

Edison promoted the phonograph; Wright Brothers the air boat; Marconi the wireless; and Ford the Tin Lizzie, successfully; the Peace Ship, otherwise.

All the big jobs have been performed by promoters. They are, have been and will be the restless spirits who dare to venture into unknown fields, to risk their fortunes, their good health, their lives, if necessary, to open new mines, to make new discoveries, to develop new countries, to build new industries, to obtain new information, to apply new ideas and to try out new plans. Through their efforts the race is blessed with an endless series of progressive changes, leading constantly to greater human comfort and fuller and better lives.

Certainly there have been bad promoters, just as there have been bad preachers, bad teachers, bad husbands, bad wives and bad children. We are frank to admit that the Devil himself was some promoter and the archdemon of them all, Kaiser Wilhelm, is the world's most successful promoter of murder. But the promoters of peace have got him bested and out of all the misery and all the crime and all the suffering will come a better world in which to live. More good than evil is promoted and will be promoted, because that is the direction in which the human race is moving.

America was first discovered and then promoted. The United States is a promotion. Each state in the Union is a promotion. Every railroad in the country, every industry, every bank, every college, every university, every church, every Sunday school, every meat market and every grocery store is a



promotion. They are all here and doing business because there were those who were willing to take a chance and run the risk of failure.

Where would the race be without the speculator, without the promoter? It would still be in the jungles and only slightly removed in countenance and ambition from its caudal prototype.

The promoter leads; others follow. The promoter steps out into the night—into the darkness—and without knowing his destiny, but with a heart for any task, finds gold. He gets the news back to the home guards and they follow, making the trip in the daylight. It is easy to pick up a fortune after some industrious party has found it and pointed it out to you.

Where would the oil industry be without the men who have the nerve to risk their money and their time in developing and proving undrilled and unknown territory? There wouldn't be enough gasoline in the country to prime a carburetor.

Let us give more credit to the man who is game and who encourages gameness in others. Be game and gain. And if loss comes, be all the gamer. A man may be excused for losing anything and everything but his head.

The speculator, the pioneer, the exploiter, the promoter, they are the boys who have developed the nation's resources, who have builded its enterprises, who have established its industries, who have founded its cities.

With a brain that is active, a heart that is strong and with a body that is all energy the real promoter is ready for any job. He opens new roads, develops new territory, discovers new mines. Sometimes he gets paid for his work. Sometimes he does not. But he keeps on going. That is the way he is built. He builds factories, builds cities, creates employment. He is the forerunner of population and prosperity, of railroads and residences, of commerce and cornfields.

He is at the head of the procession. He points the way to new wealth and new methods. What he gets for his trouble may or may not be enough; it may or may not be too much; but the good he does and the wealth he creates for the enjoyment of his and future generations are uncalculable.

The promoter shows the rest of the world how to make money—how to get rich. When he takes the risk out of a proposition by proving its worth, his critics, the conservatives, are anxious to get in with him and ride, or take it away from him entirely. In other words, the whole job of supporting the human race rests primarily on the shoulders of the promoter. Without the promoter the rest of us would starve, if we didn't freeze first.



Don't lie about the promoter. Don't slander him. Don't discourage him. He has a hard enough job as it is. And remember, he is feeding you, clothing you and keeping you warm. He has provided you with conveniences. He gave you your automobile and installed your telephone. He has been good to you, in spite of your attitude towards him. He is a magnanimous man and deserves magnanimous treatment.

Besides he is busy and has other greater and even better work to do. He must not use his God-given talents less, but more. He must not be hindered, but helped. No man or set of men is qualified to stand between the promoter and his job. His work is too important, too vital. Whatever his faults, whatever his mistakes, he is still the world's greatest builder. As a producer, he stands alone. He is in a class by himself. He is head and shoulders above all the rest. His motives may be questioned, as they have been, for there are those who pretend to possess an ability not yet listed among the attributes of men—the power to analyze the human soul. If the wide world contains a man who has this wonderful power he is the party that should pass on and approve the projects of the promoter. If no such prodigy exists, instinct and horse sense should be our guides.

With the coming of peace the earth is going to be smaller—much smaller. And that very smallness is going to call for bigger men—much bigger. It is going to call for men who can face in any direction and see around the globe. It is going to call for business executives and trade promoters who can sit at their desks in their American factories and analyze commercial and industrial conditions in South America, Asia and Africa. Who are these men? Where are they coming from? They are the country's real promoters. They are the men who are going to do the big jobs in the immediate future. They are at once the heart and brain of the race. They have the intelligence to meet all emergencies and the humanity to do justice. Their purpose will be not alone to make money—to pile up profits—but to serve the nation and mankind throughout the world.

With the coming of this smaller earth and with America in possession of greater wealth and much richer in money, supplies and materials than any other nation on the globe, will come the real test of Democracy and the man who promotes his own best interests and the best interests of the United States is the man who will be guided in his relations with other peoples by high ideals and fair dealing.

America is a world power and the American people as an honorable people depend upon the character, integrity and decency of the men who are to promote American world trade.

So, let us quit trying to submarine the promoter. He is our best friend—the greatest character in history—and the man upon whose broad shoulders rests the future welfare of the race.

It is our sacred duty and blessed privilege to promote the promoter.





*A* GLANCE at the reproduction of the perspective drawing included in the cover design will aid the reader in visualizing the Pan plant of the future, as originally planned by Pan engineers to look when entirely completed.



*“An Achievement”*









