

曹衣張

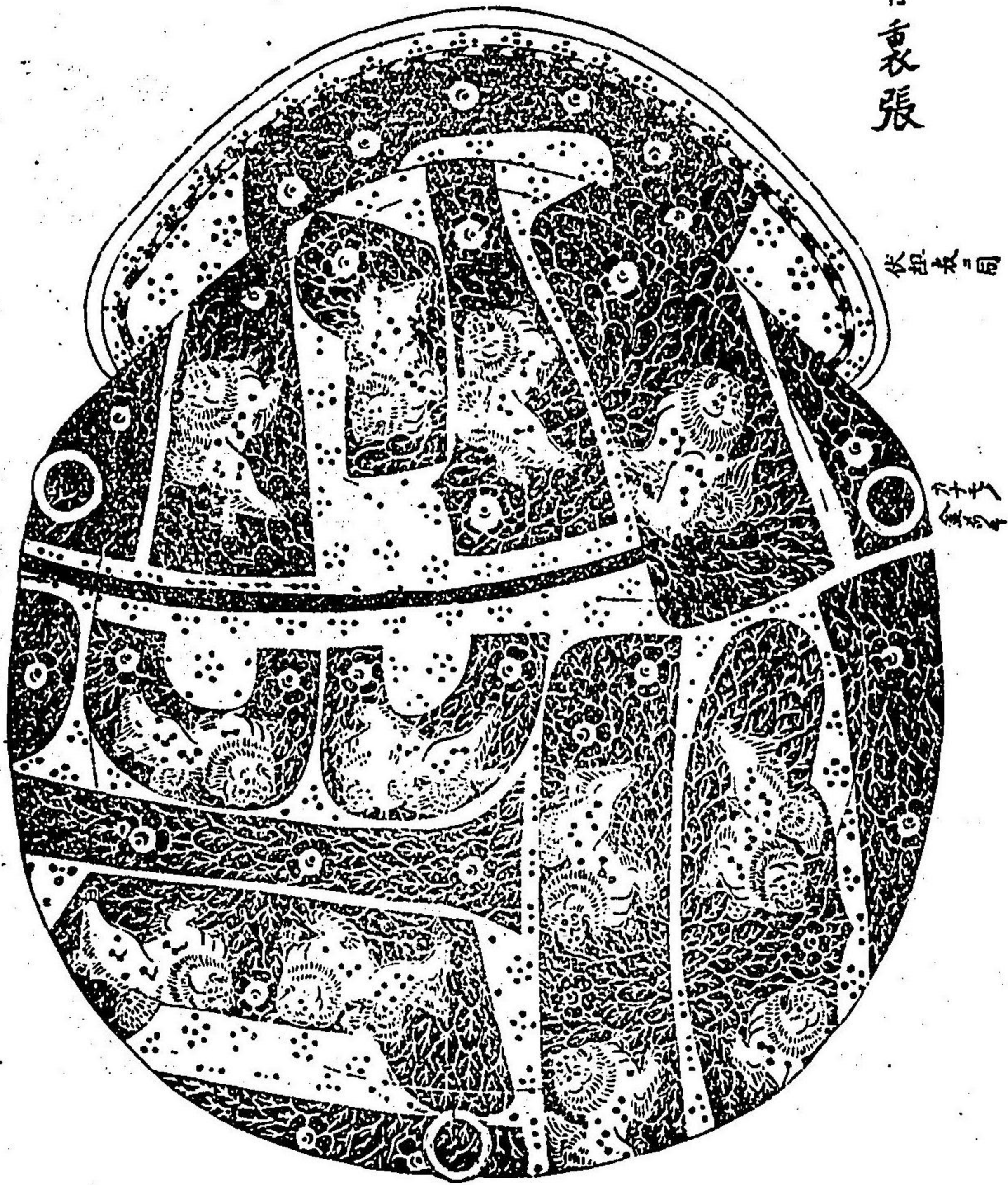

大和國信貴山本覺院藏楠正成卿由月大袖圖

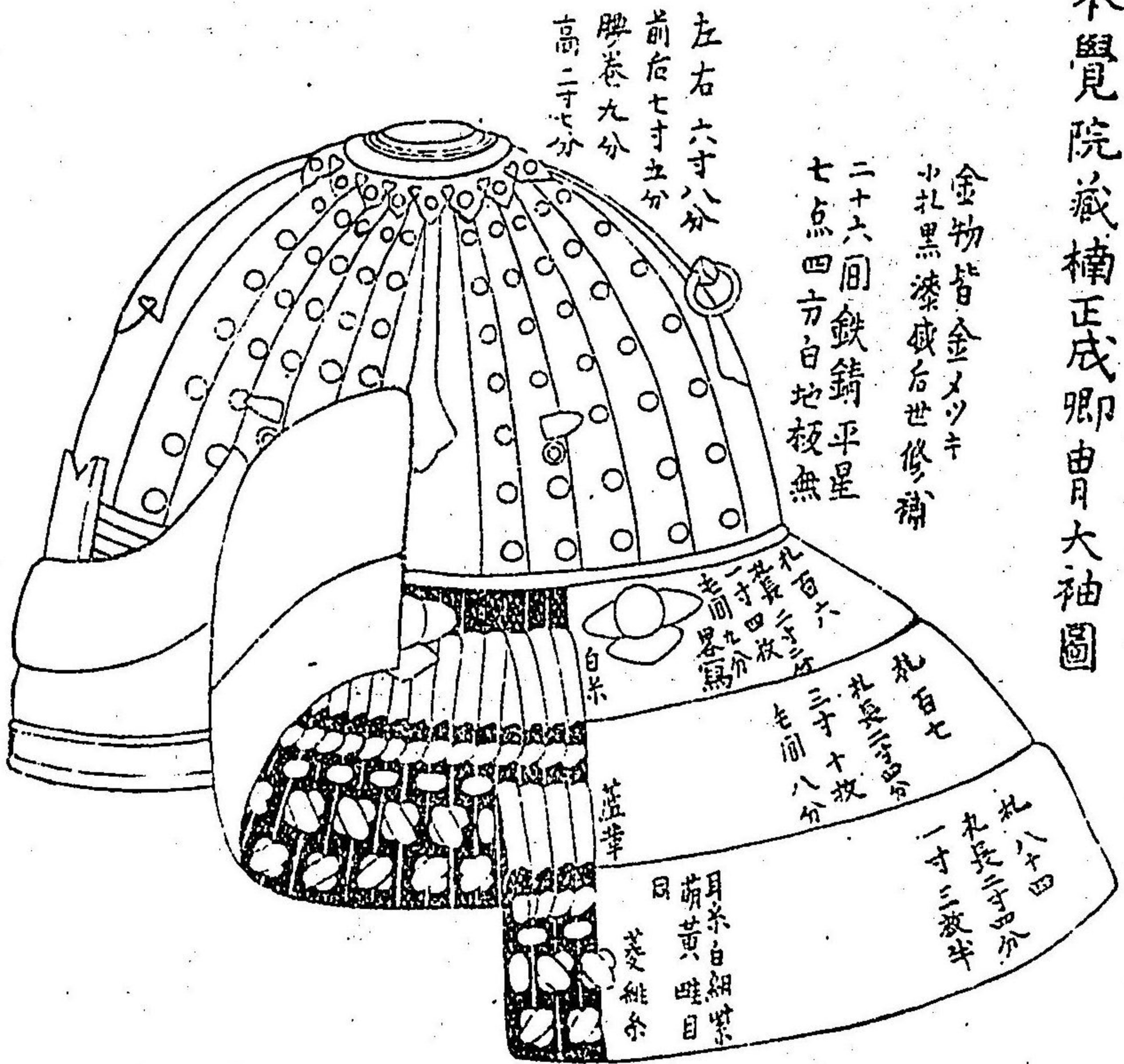

金物皆金メソキ
小北黒漆破石世修補
二十六回鉄錆平屋
七点四方白地板無

左右六寸八分
前後七寸五分
腰巻九分
高二十七分

和由六
和由七
和由八
和由九
和由十
和由十一
和由十二
和由十三
和由十四
和由十五
和由十六
和由十七
和由十八
和由十九
和由二十
和由二十一
和由二十二
和由二十三
和由二十四
和由二十五
和由二十六
和由二十七
和由二十八
和由二十九
和由三十

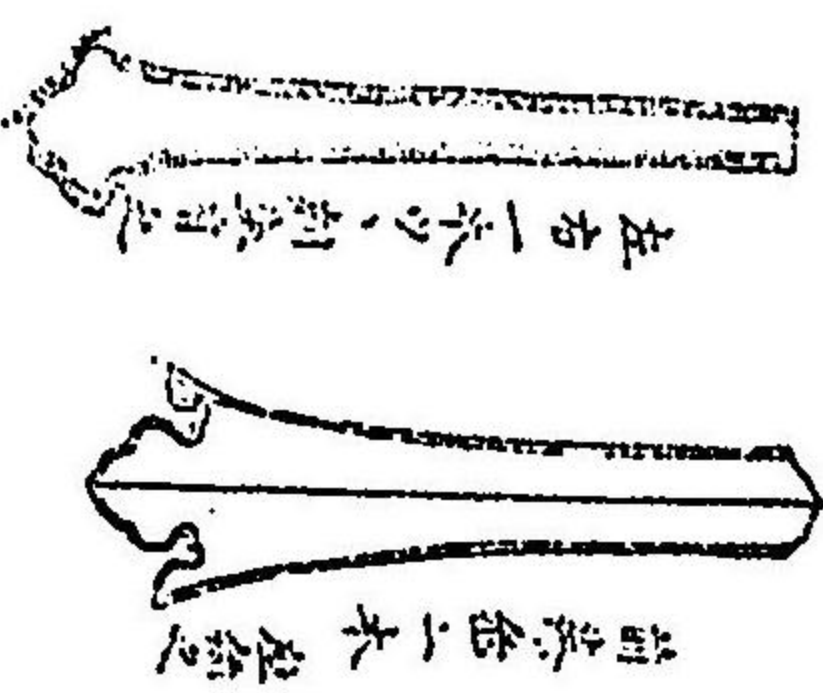
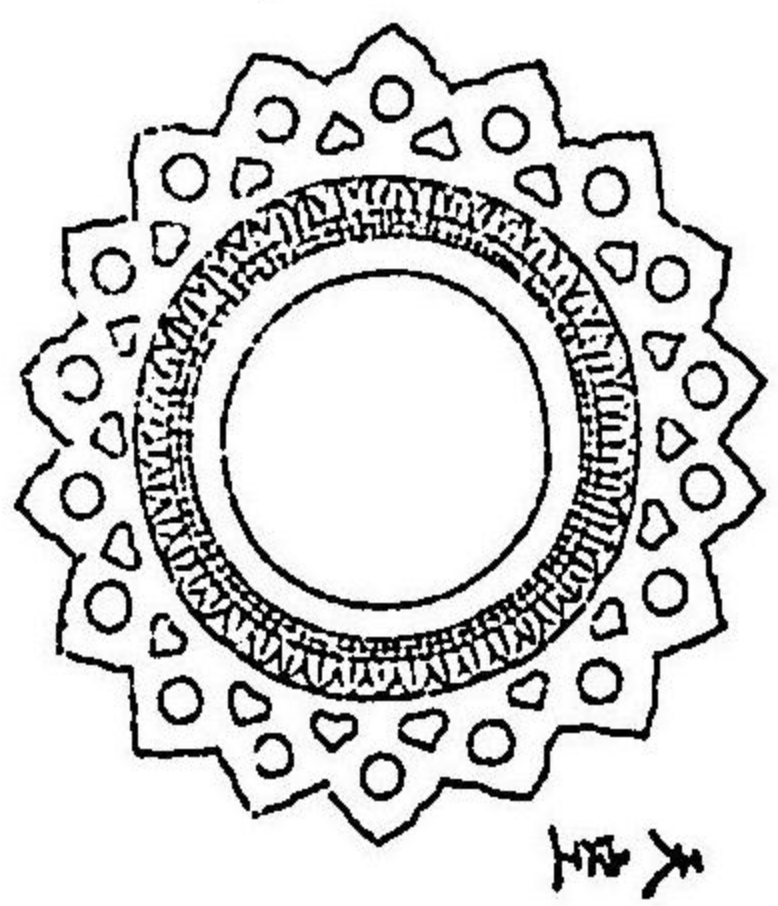
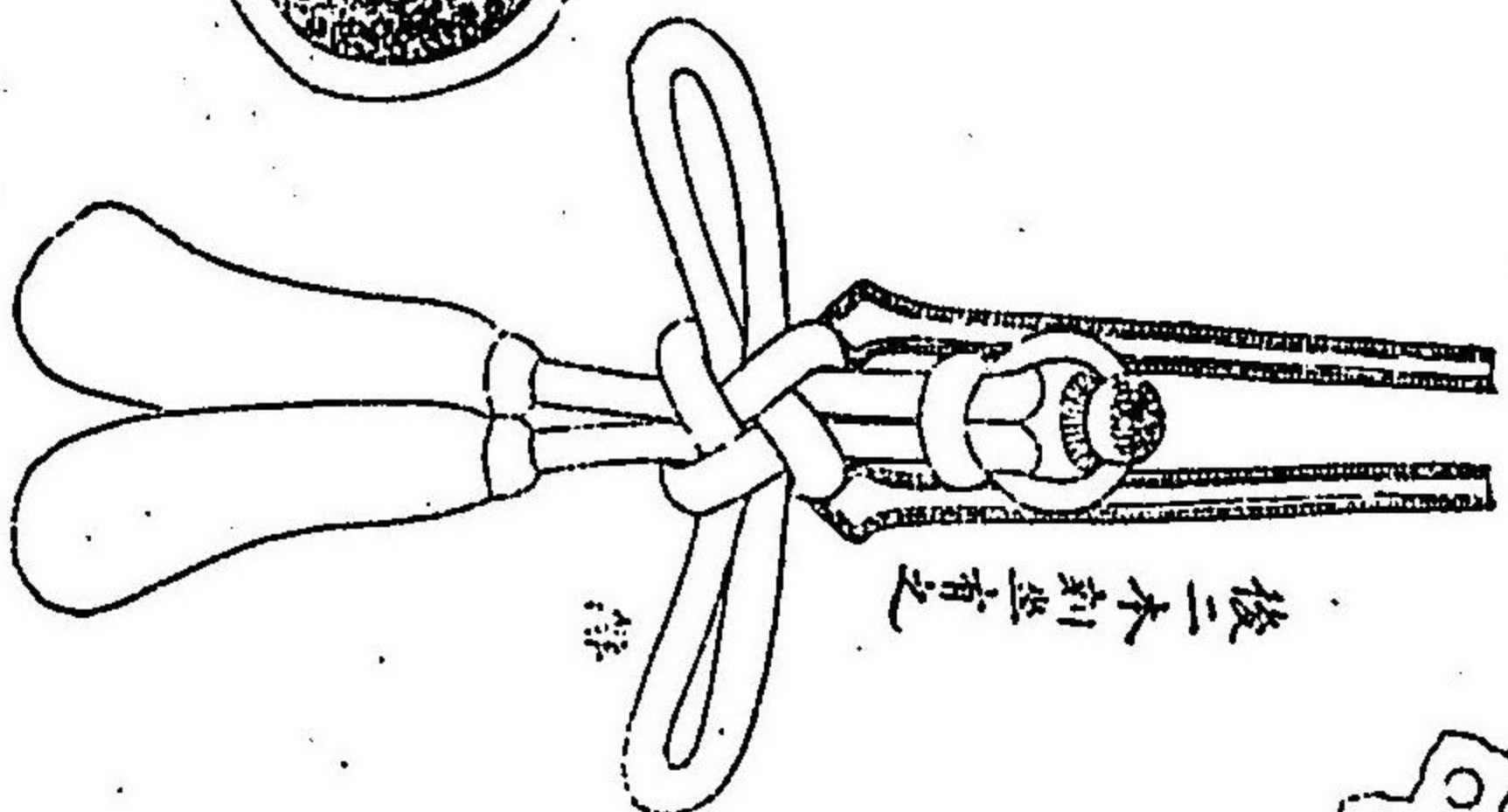
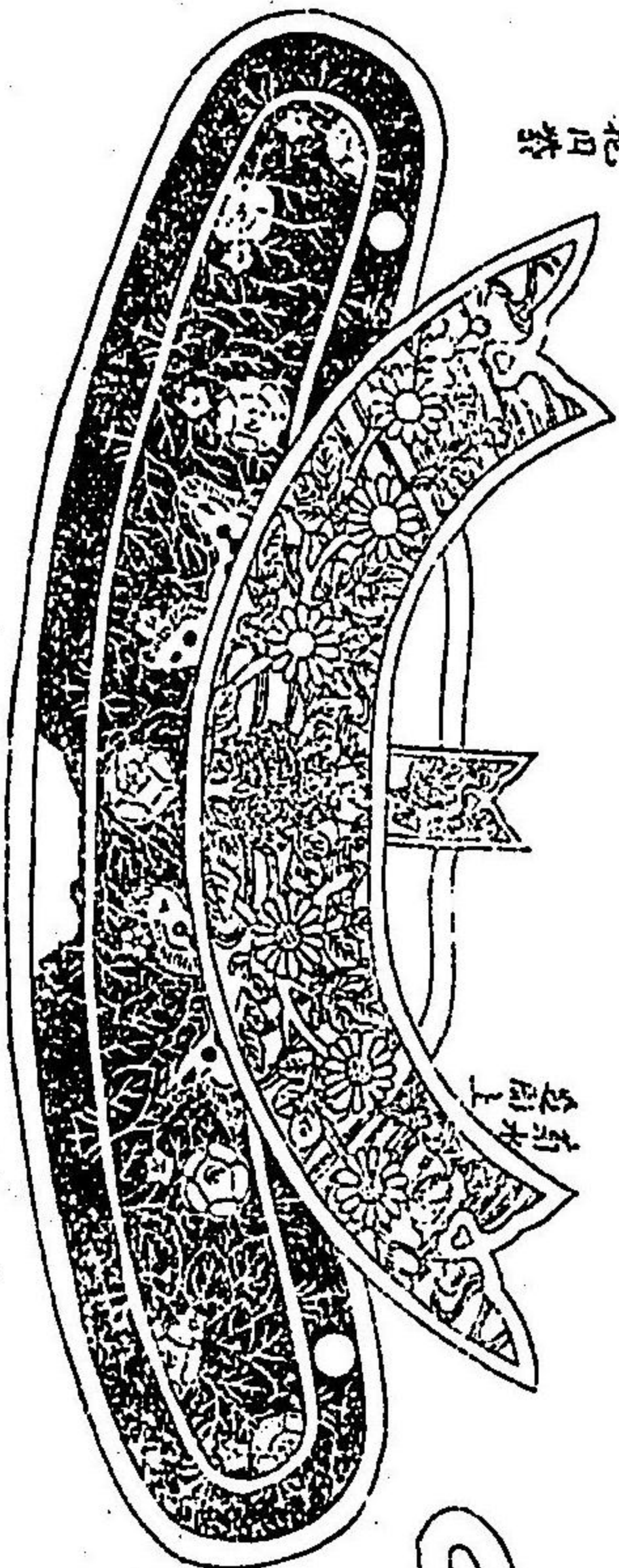

右袖之項在袖食野或附特之有秋樣至未食正之書記有之

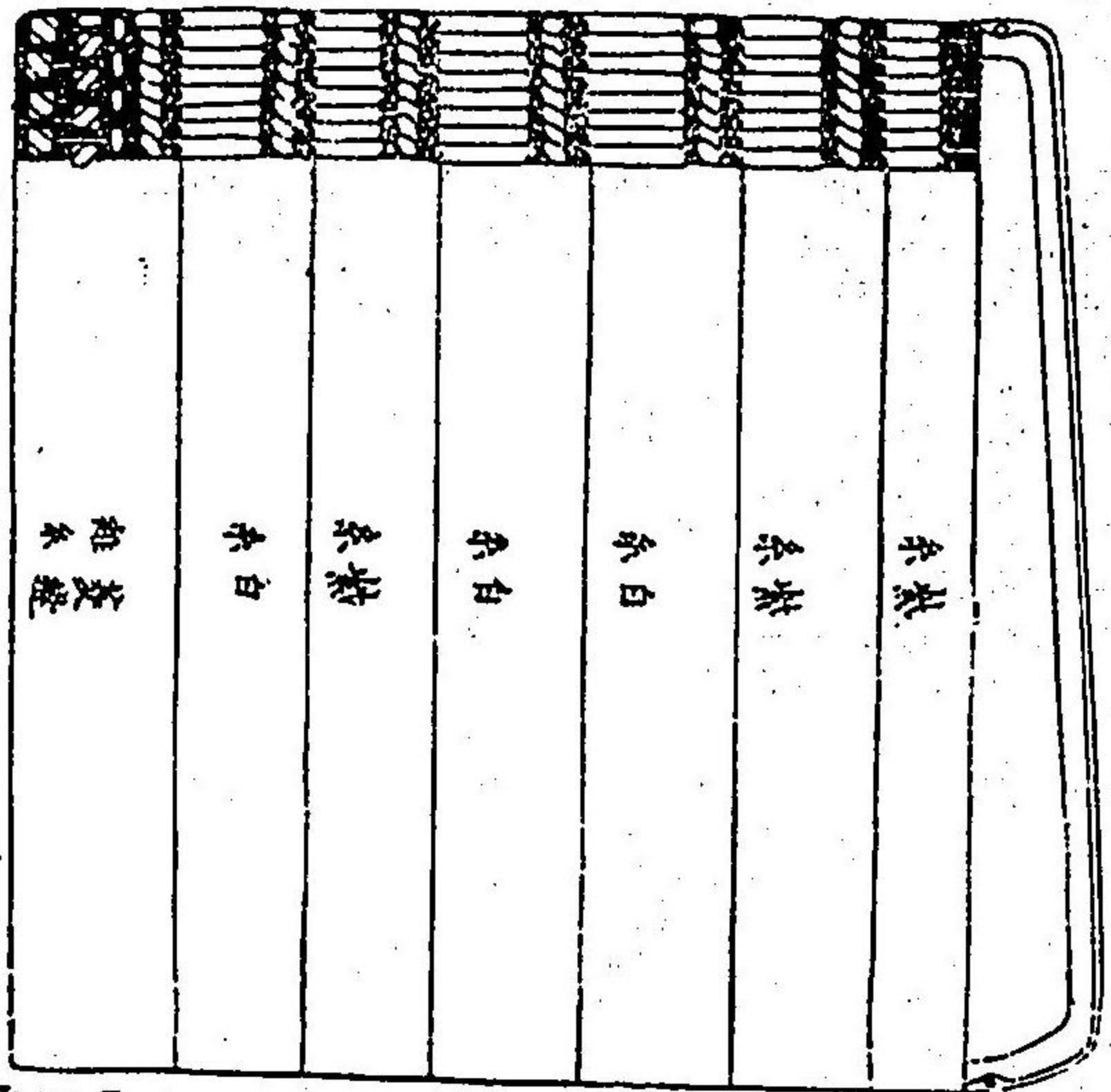

袖全圖

此毛及單八枚札長寸二分毛間之份
黑漆
唯目同
耳赤白 紺熱黃

伏銀白紺赤紅
胸黃
小樣至皇
并金物餘矣
冠板裏馬皮
包黑漆扣銀
七木掛飾銀
一方所裝
紛是賀特精

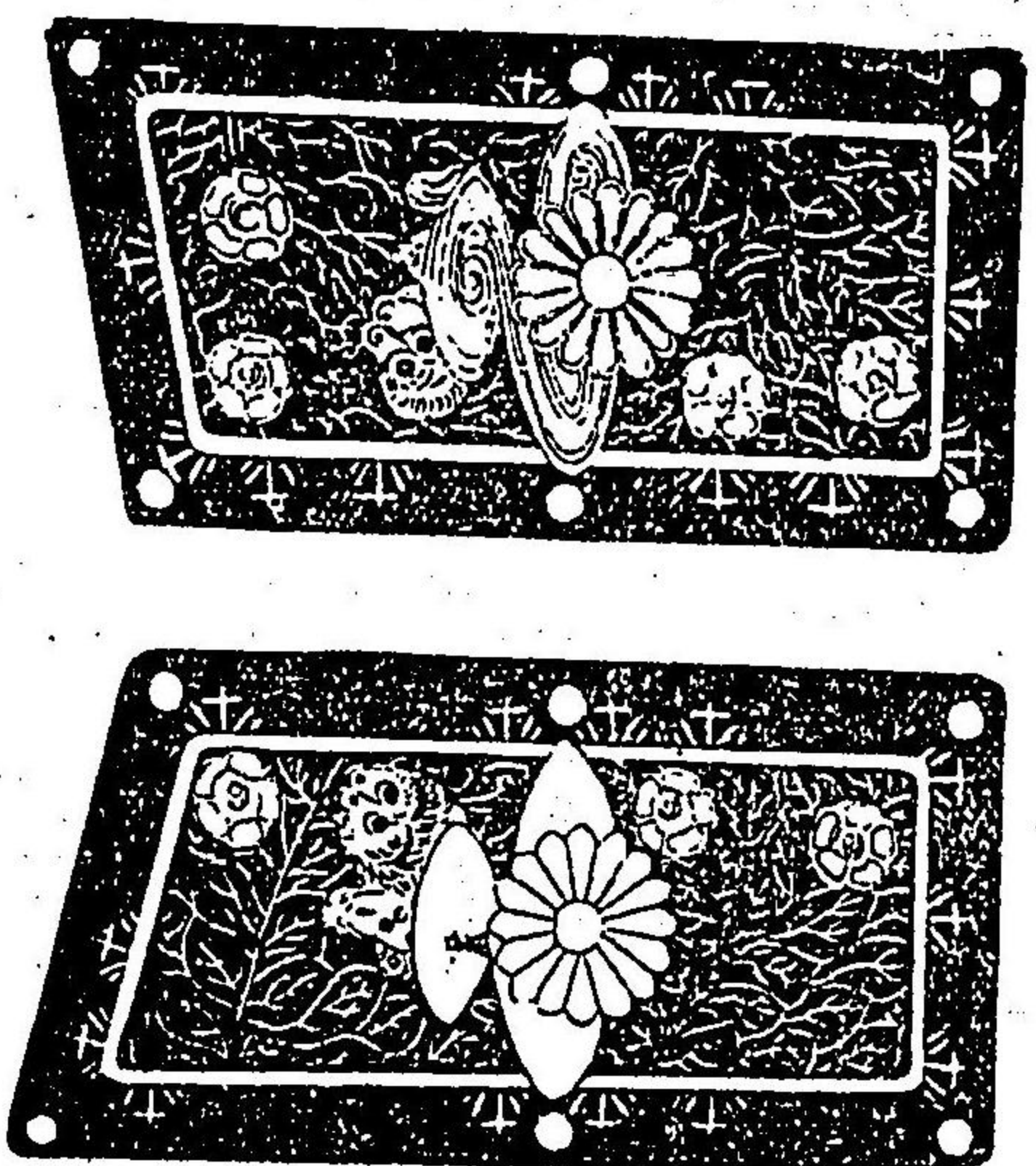

吹返

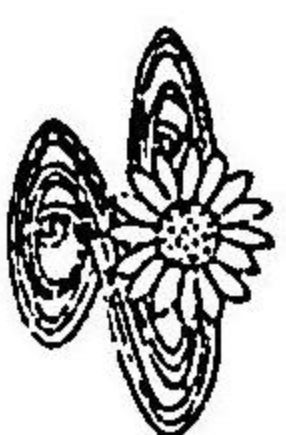

針有銀金物

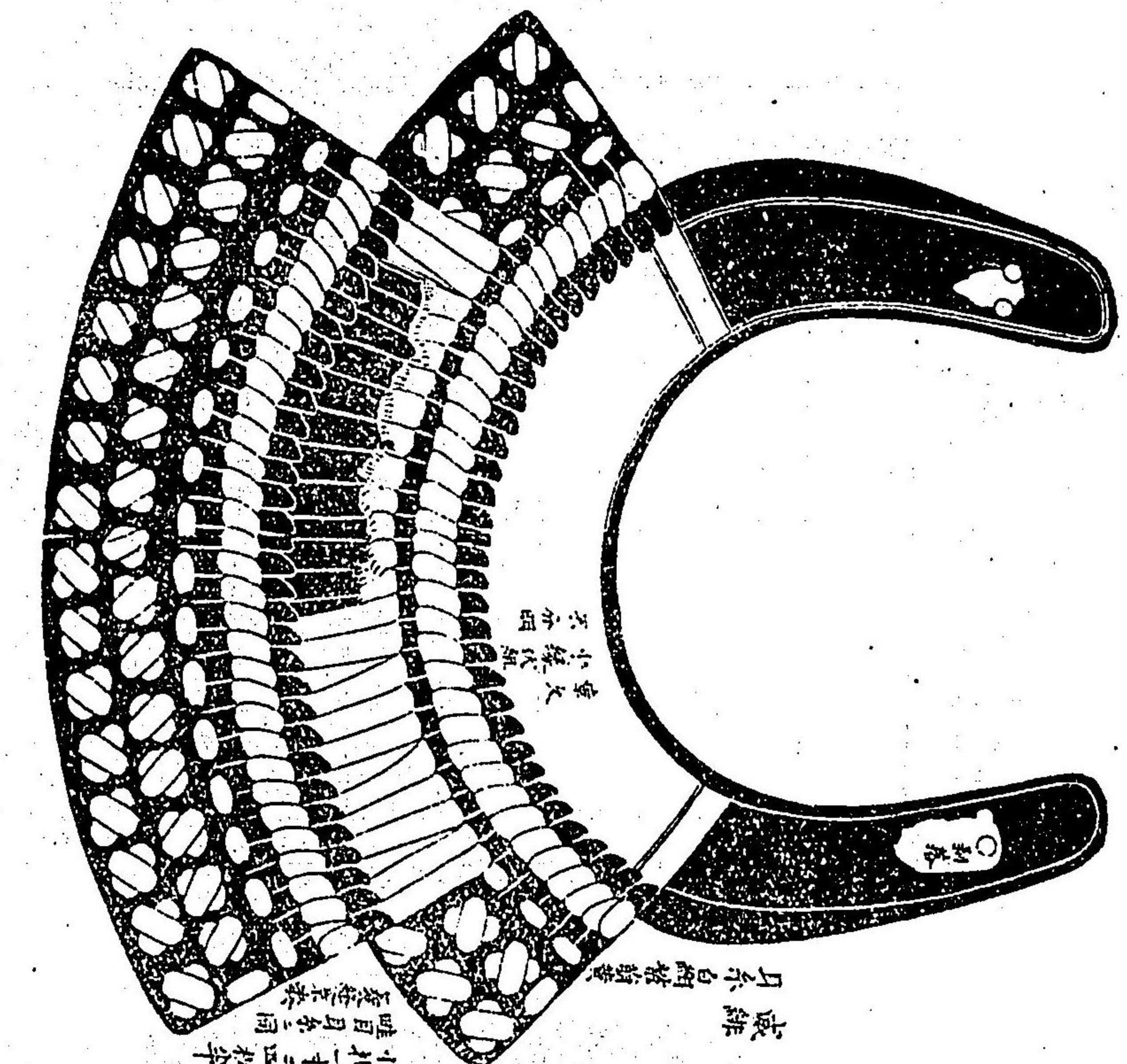

大和國志貴山本覺院藏大塔宮咽輪圖

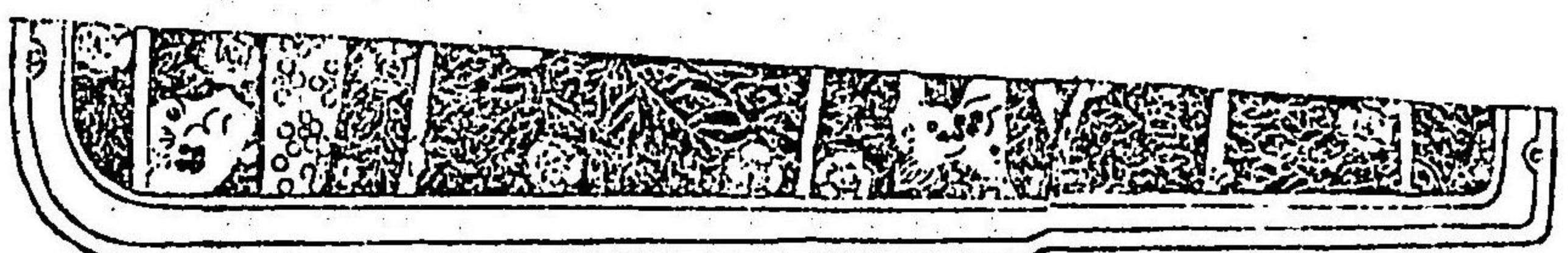

冠板

或家藏半首圖

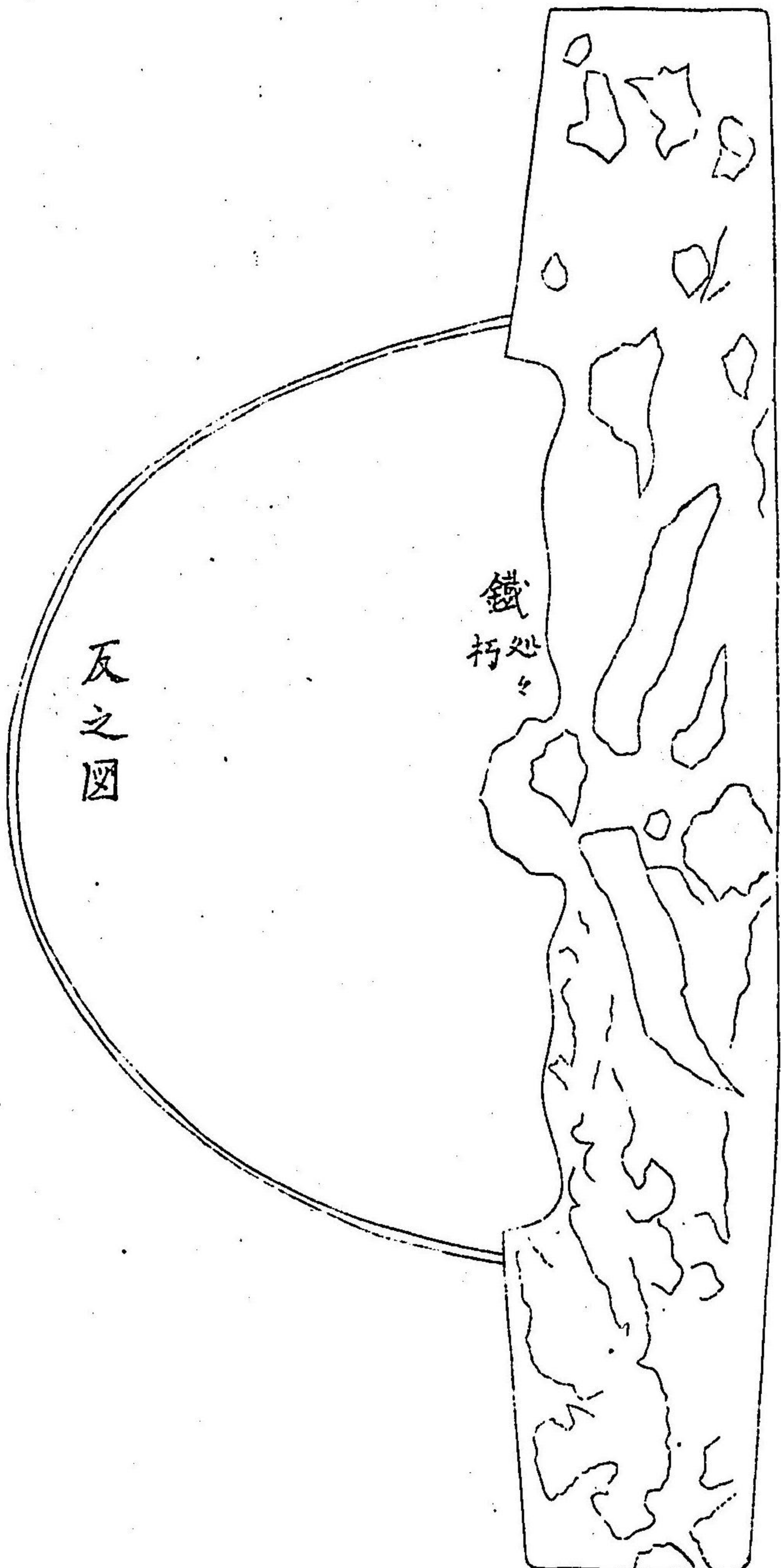

南都春日神庫所藏田中冑圖

近人岩井某所藏模本

同藏果草威胴凡此冑一領有之製大概同

甲冑六金物皆金
威黑草小緑五呈
伏紐白紺紫耳糸目
白紺紫前黄

此冑小扎威毛ヲ
畧未同

全圖

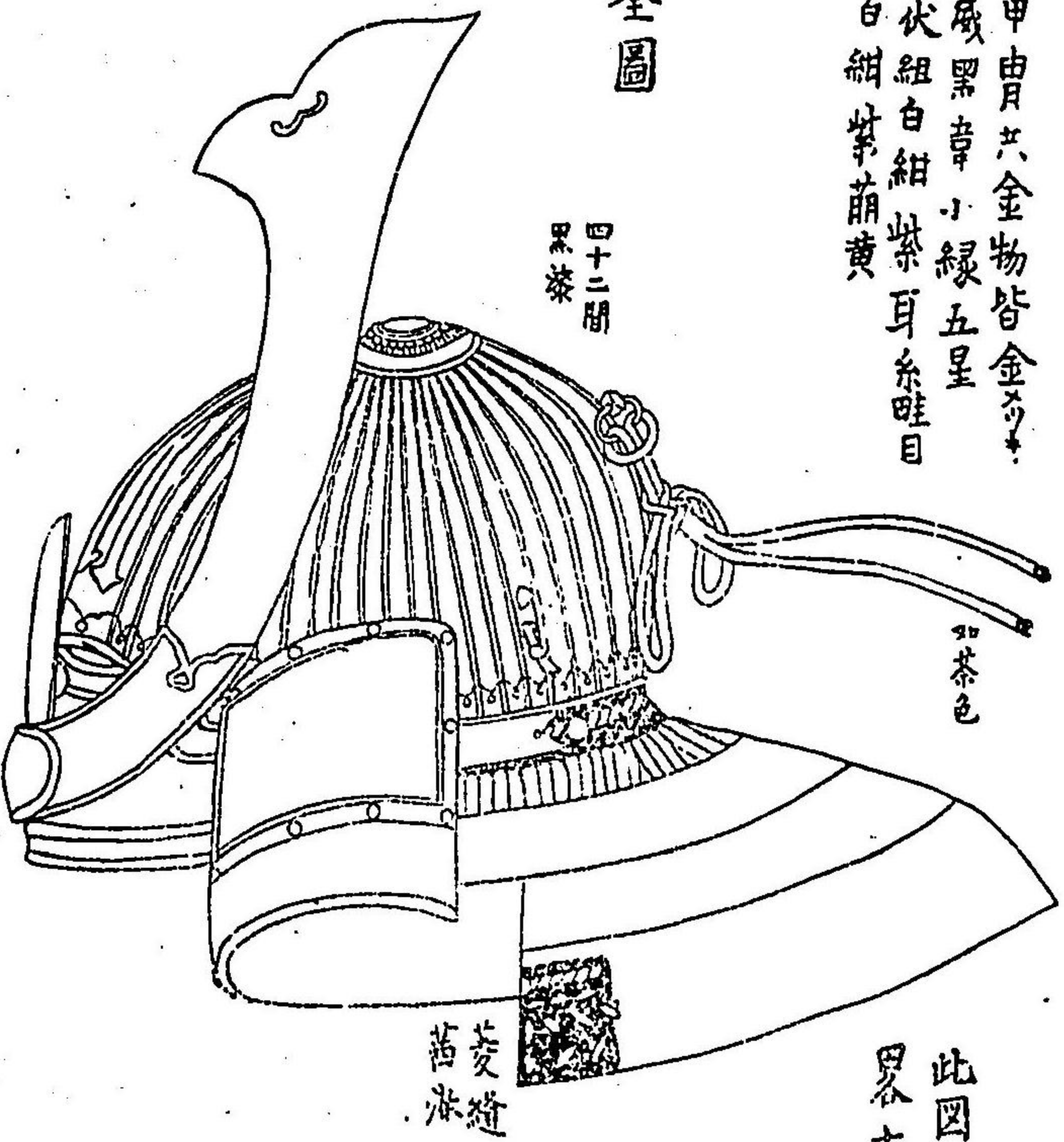

四十二間
甲冑

如茶色

菱縫
舊漆

藤花前木
重二木刺坐三

鉄冑張眉相敷
其蓋四葉染草

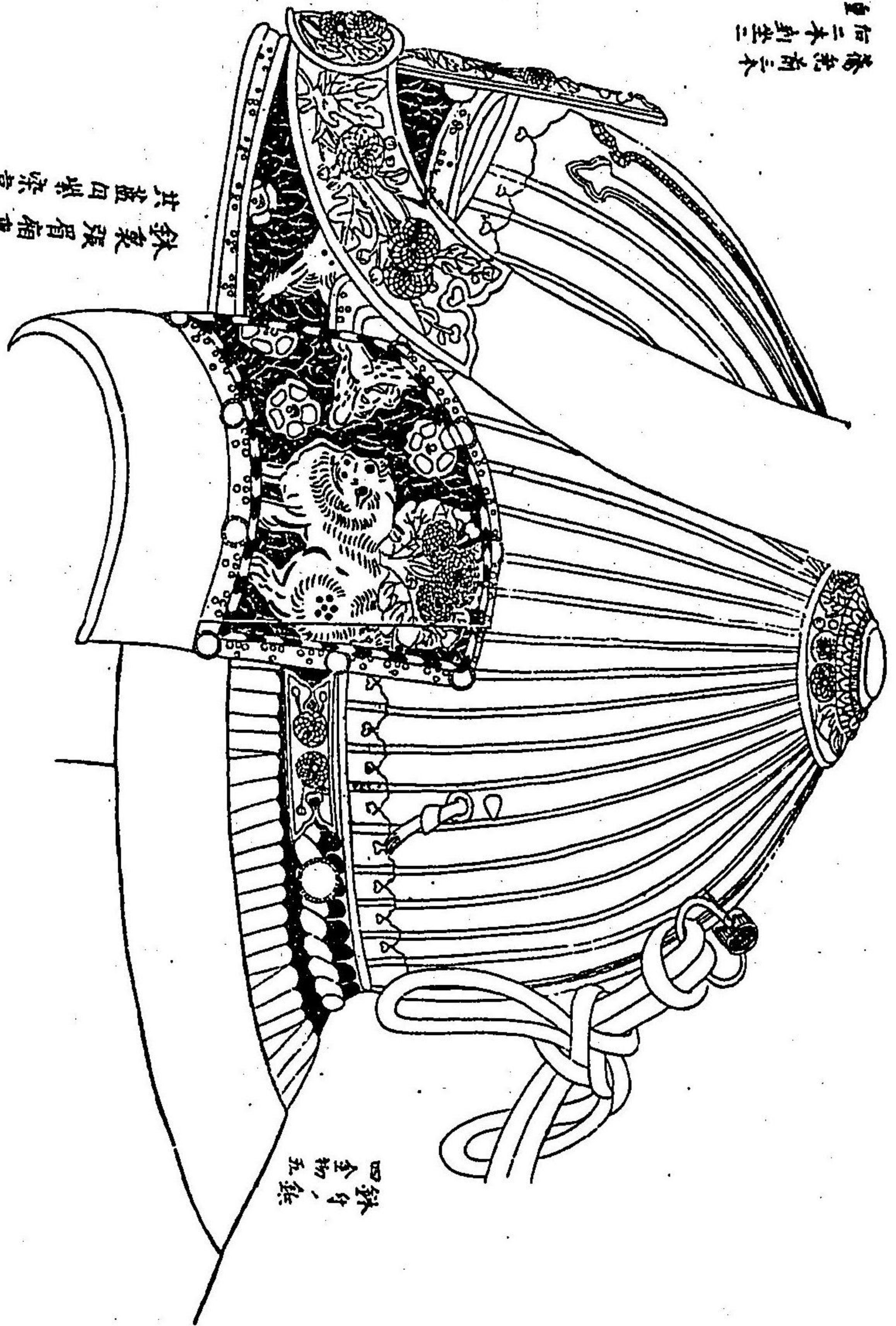

四鉄冑
五金物

袖全圖

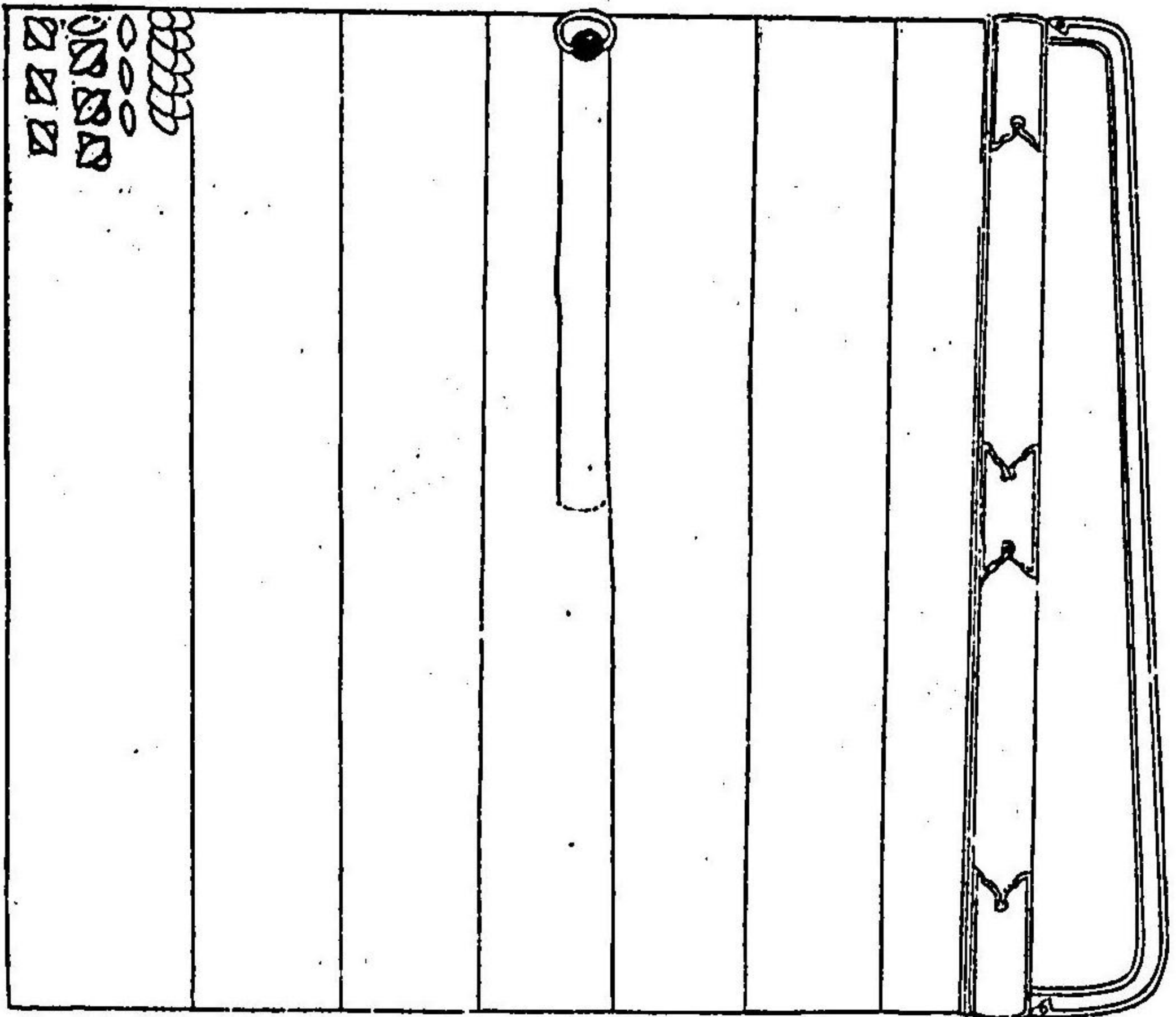

水引紅白綾 月長唯目前二同

鐵形

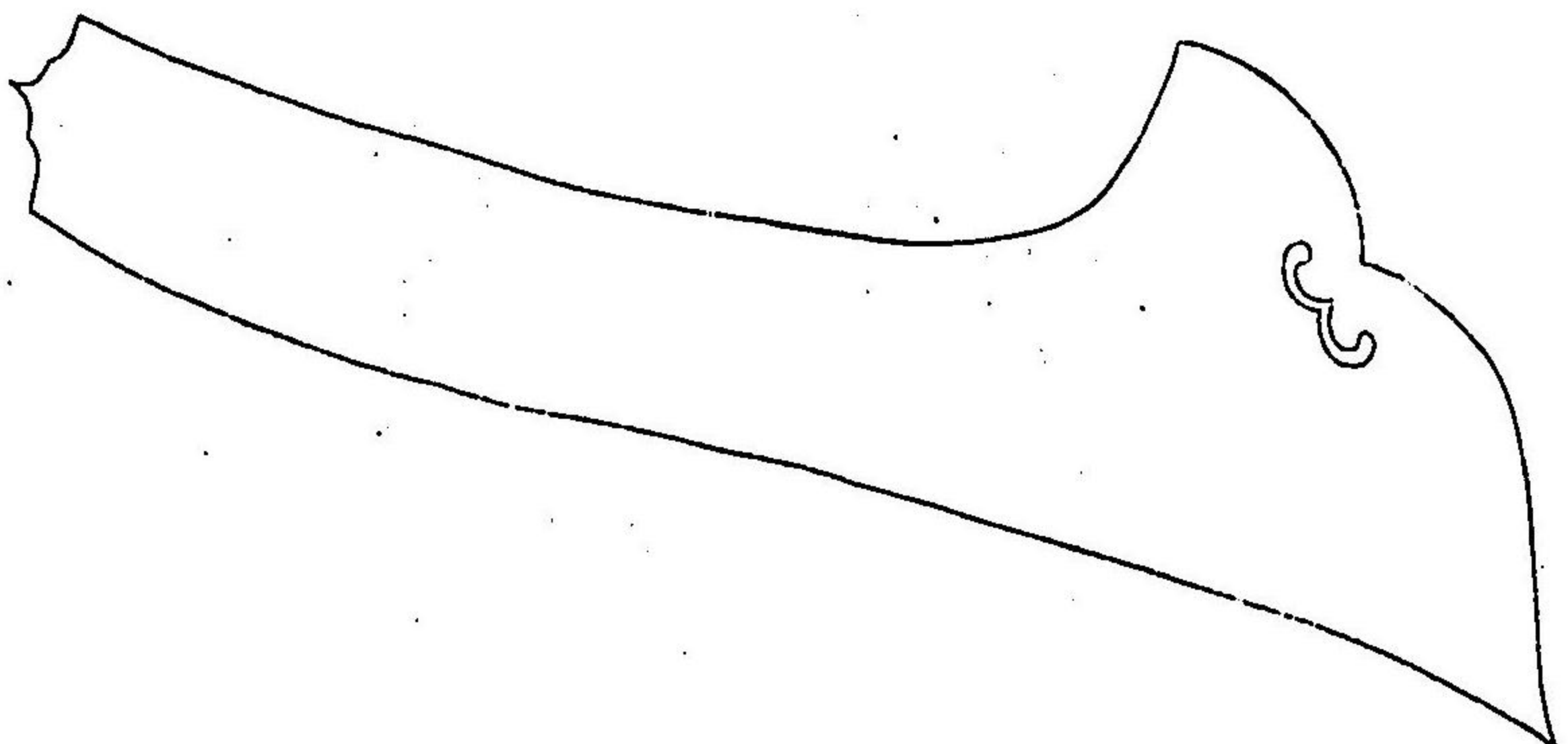

冠板小疊大短片二同

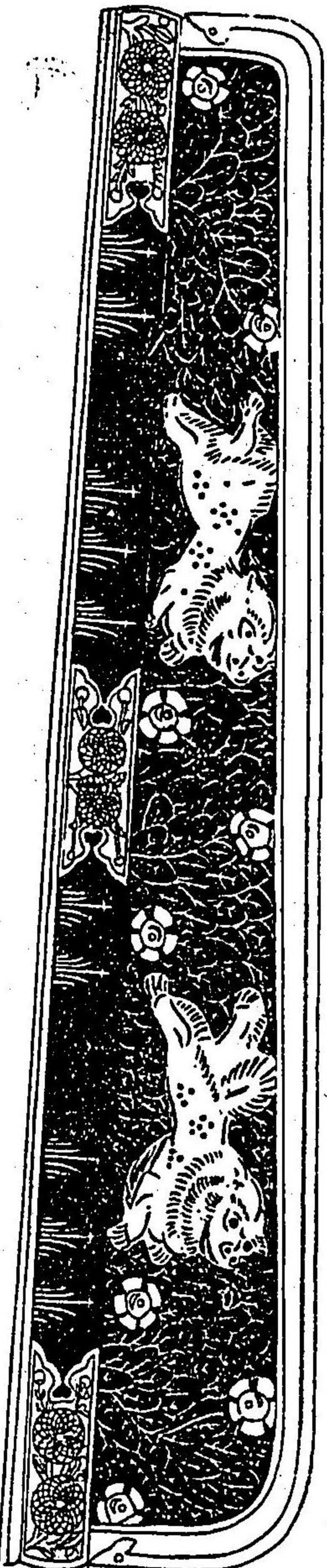

茶金物

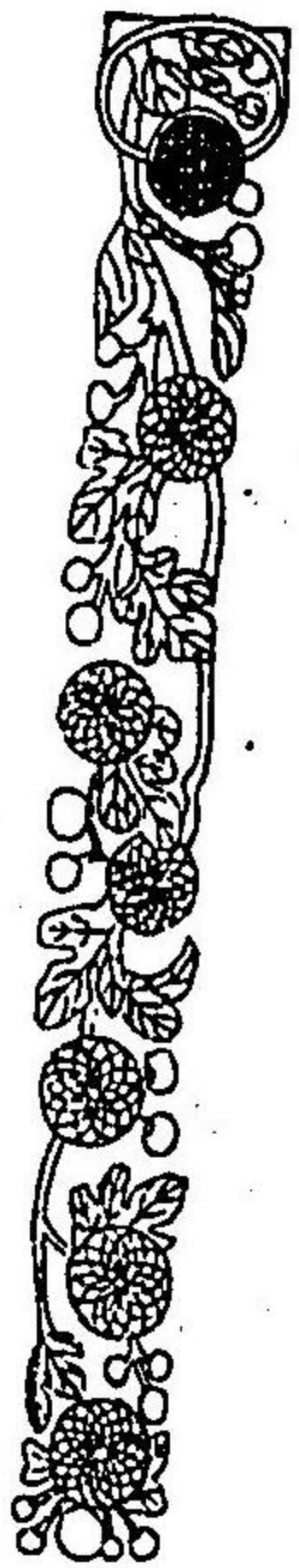

裏字由裏三同



杏葉

胴丸全圖

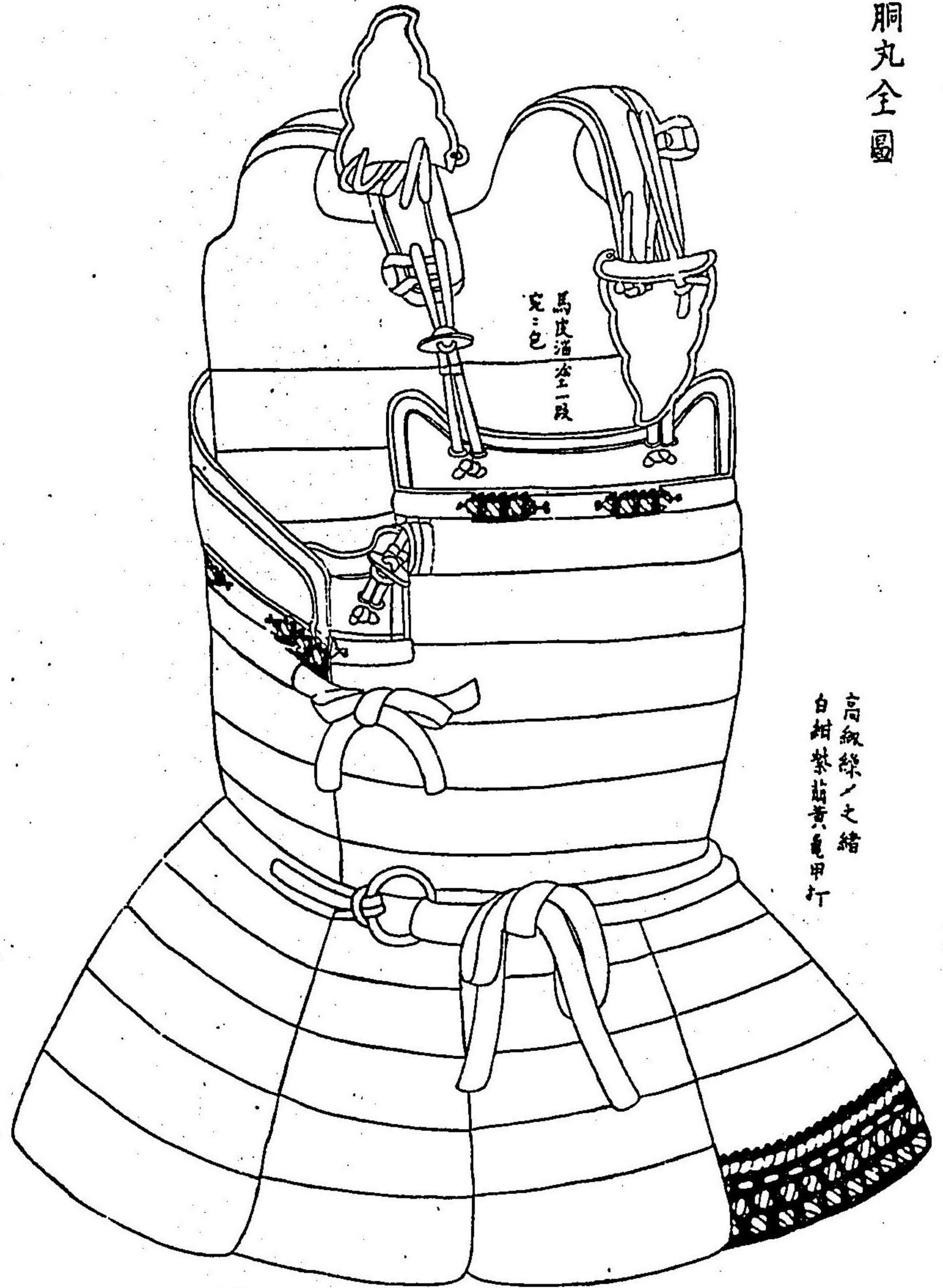

高紙線ノ之緒
白紺紫黄青甲打

胸金物

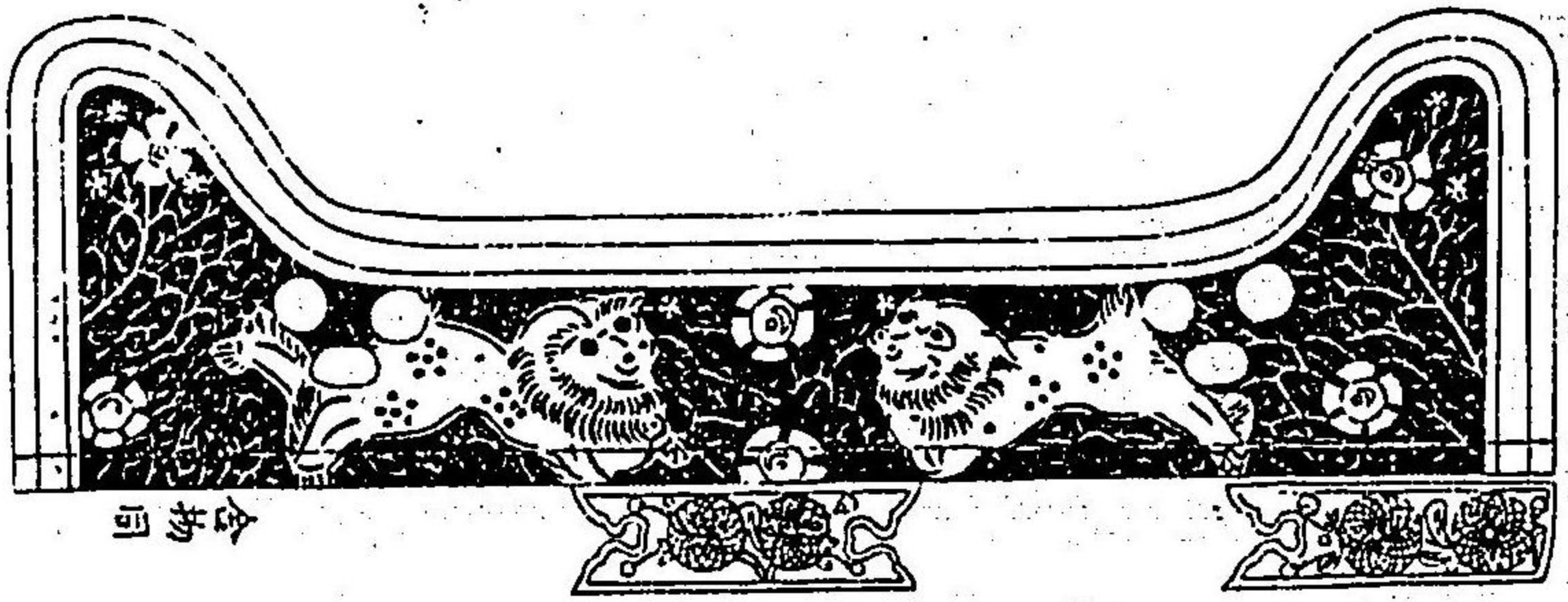

射向

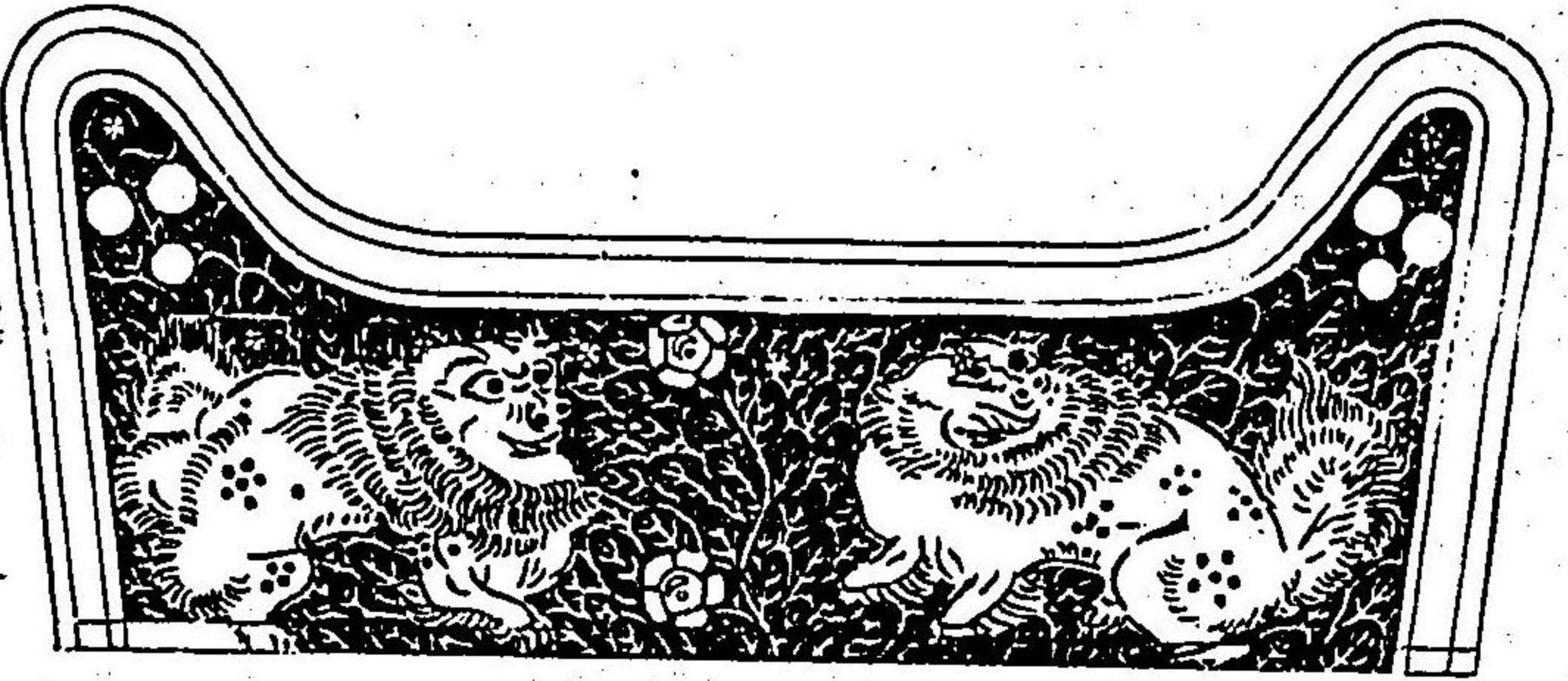

引合

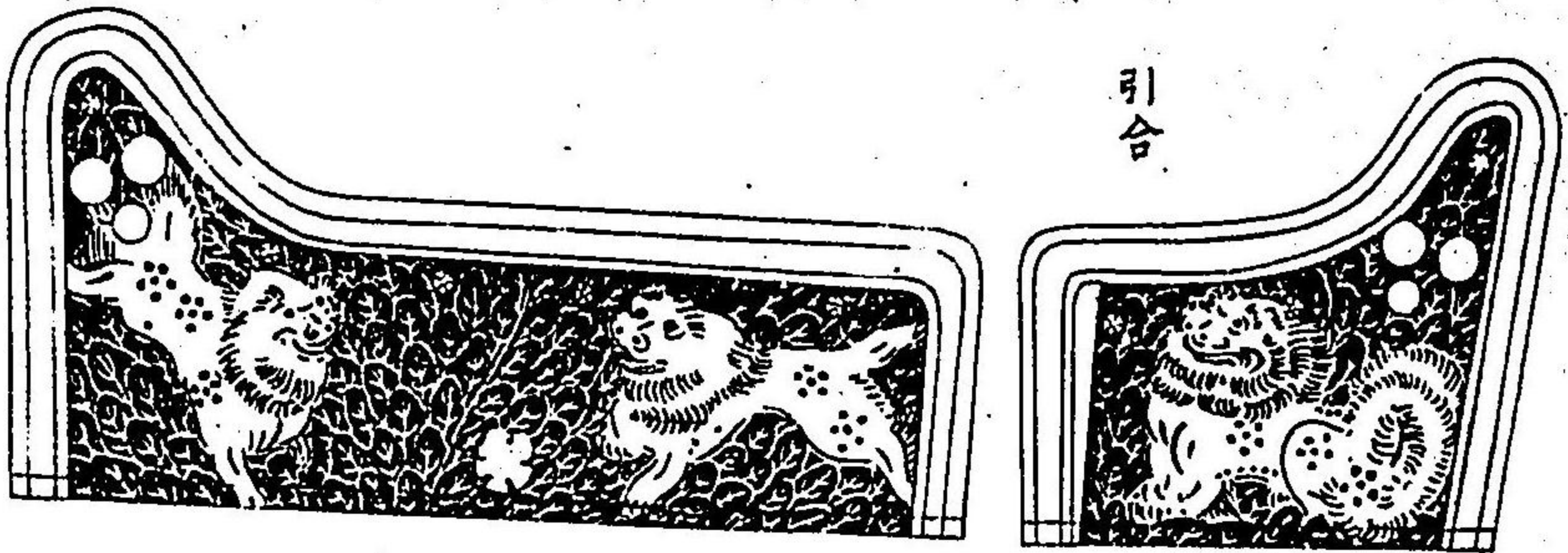

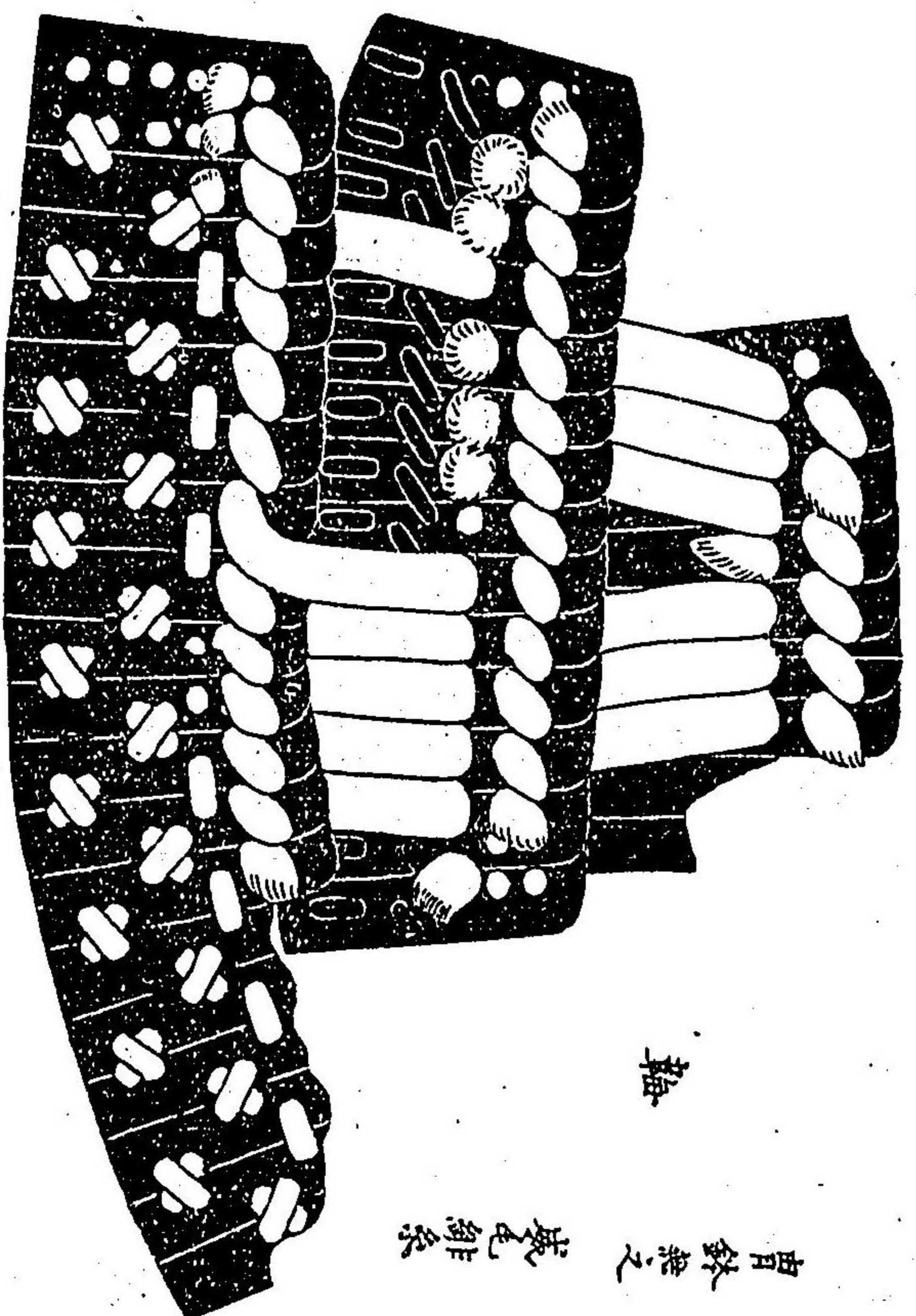
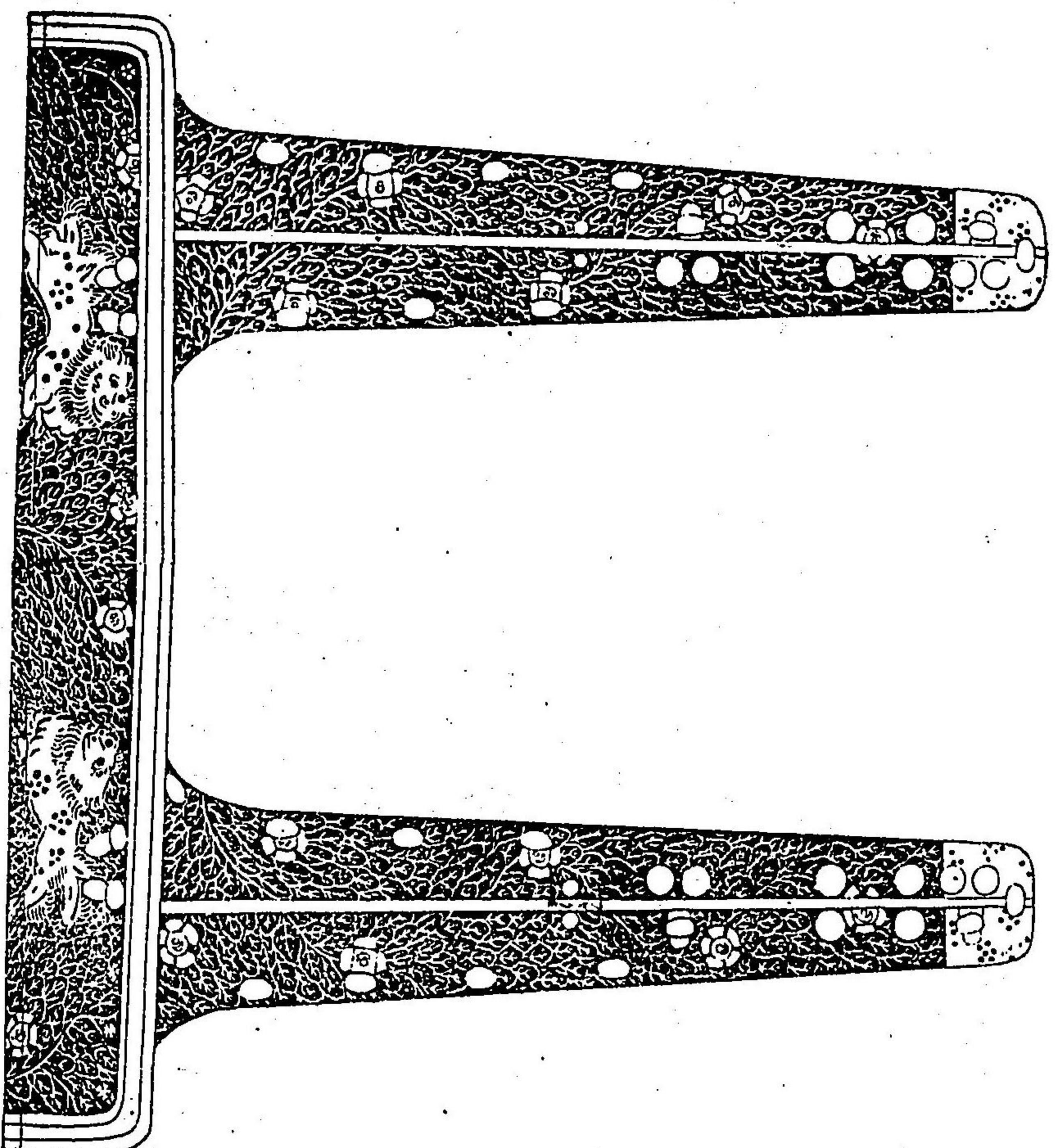

輪

曾針之

威毛維糸

菱縫馬皮之上朱漆

甲冑中北銀一枚者三枚

陸奥國棚倉郡古和氣神社藏鐵圖

カサ子



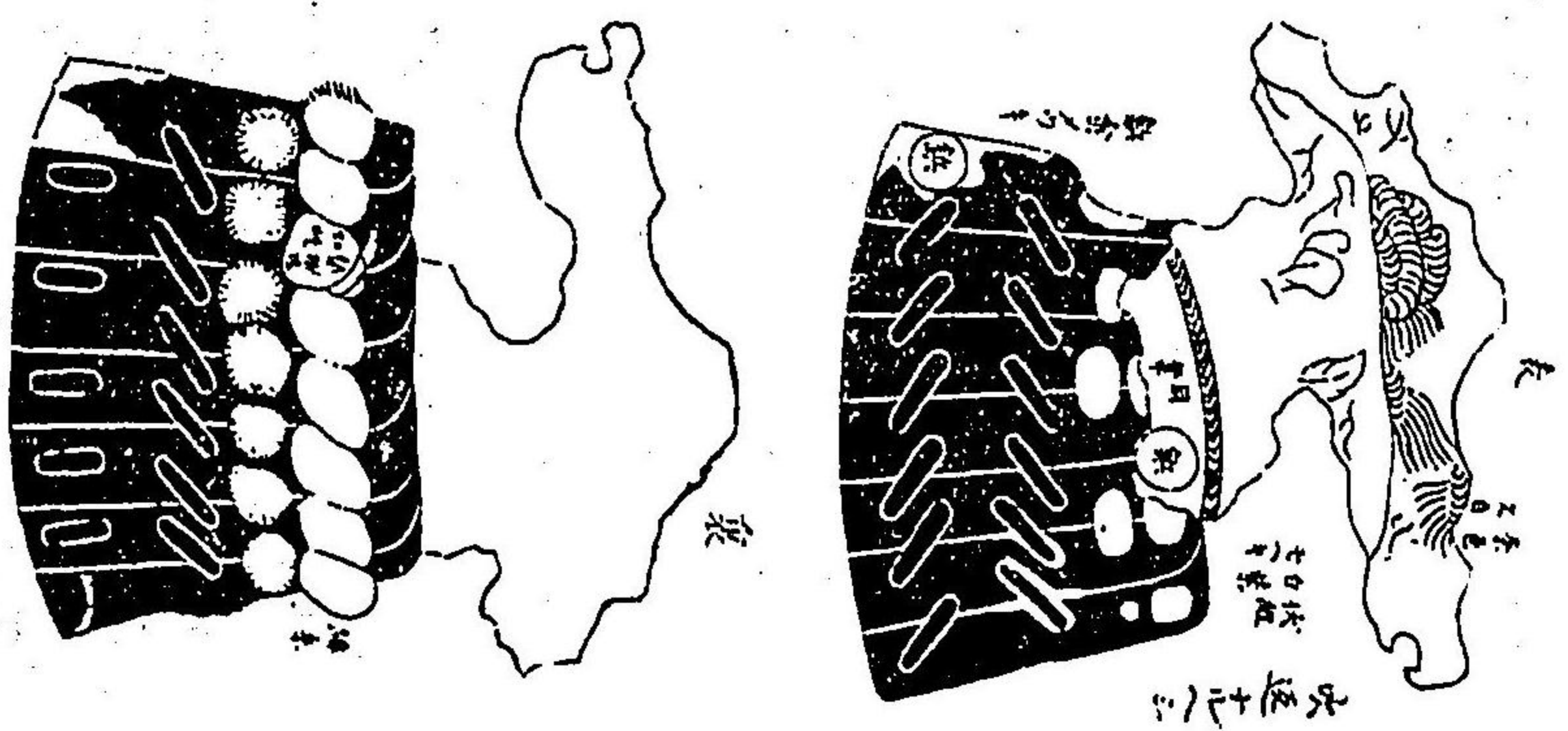
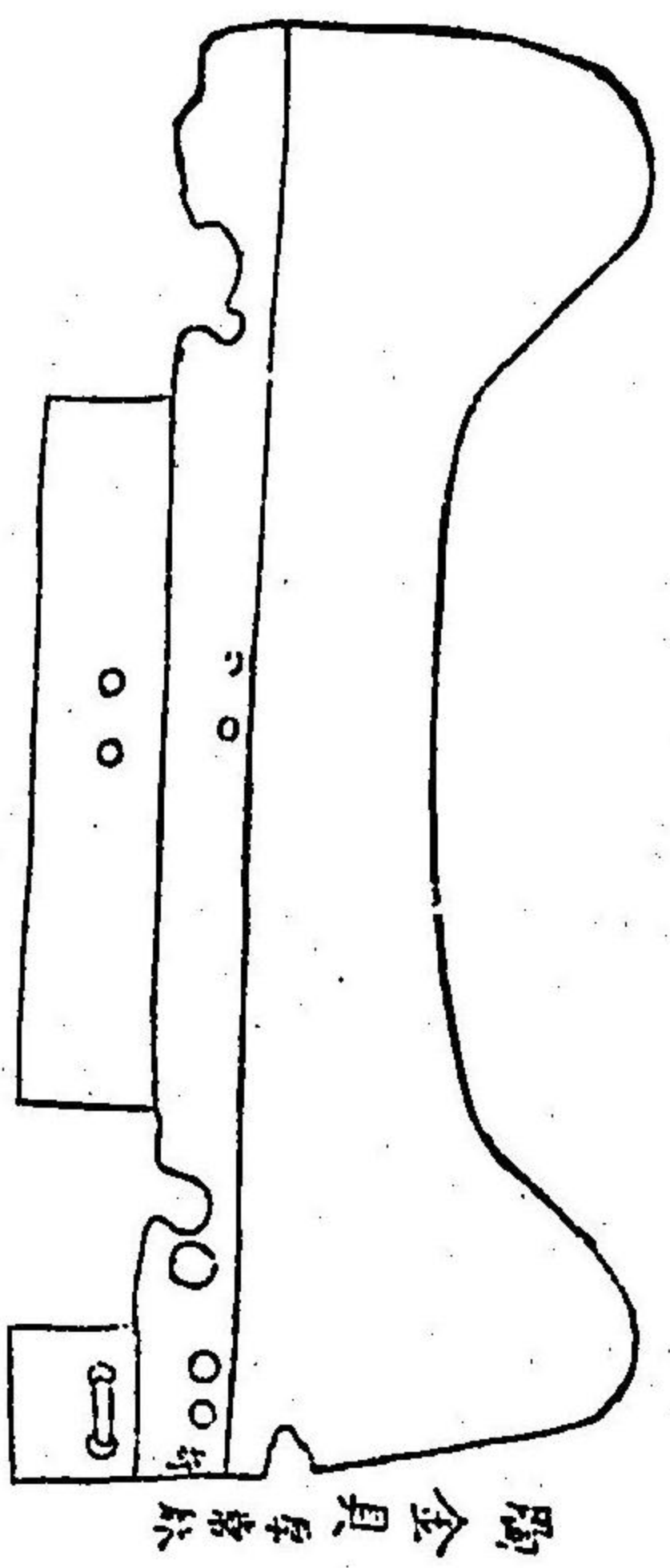

胸草摺小札

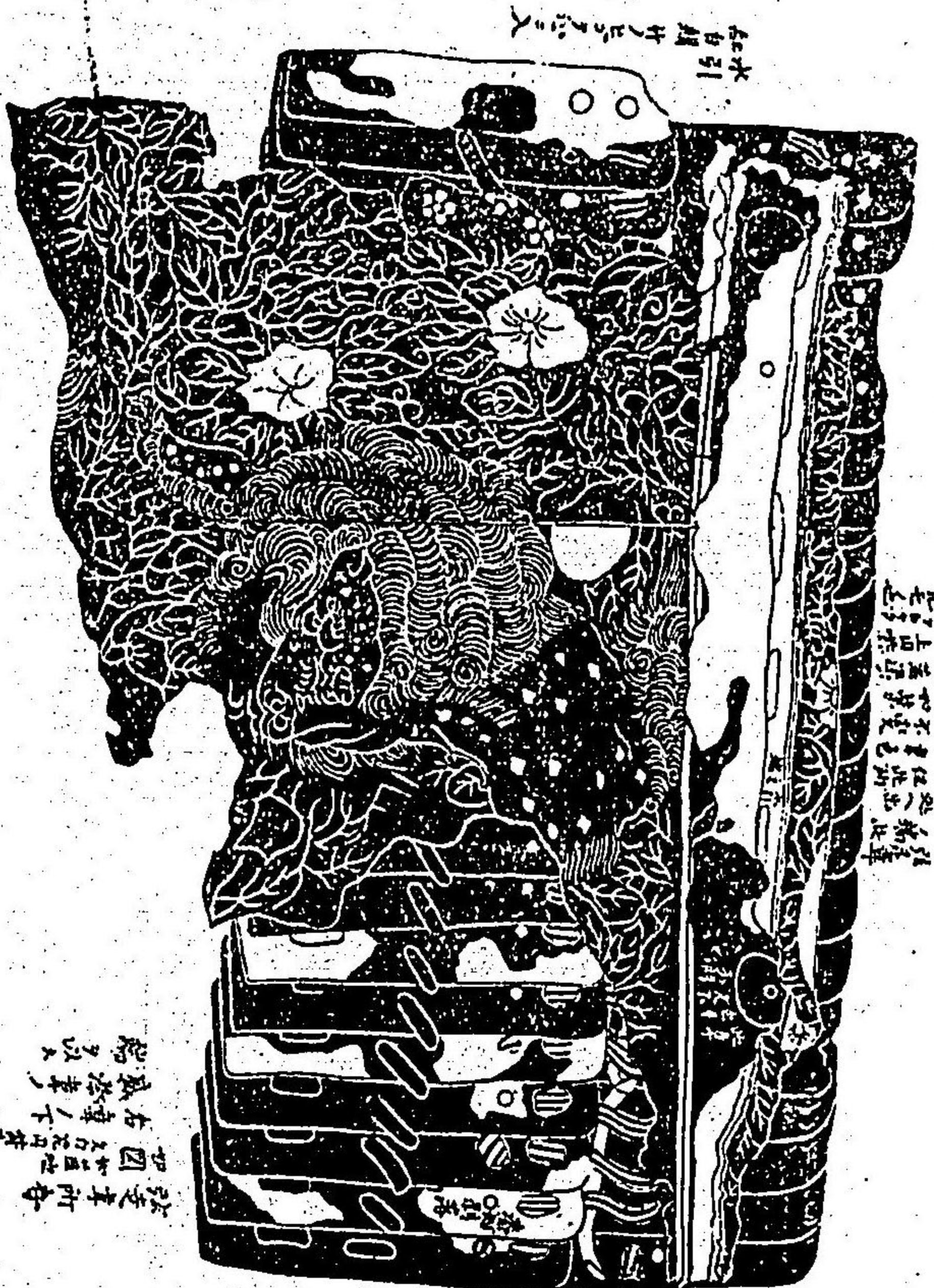
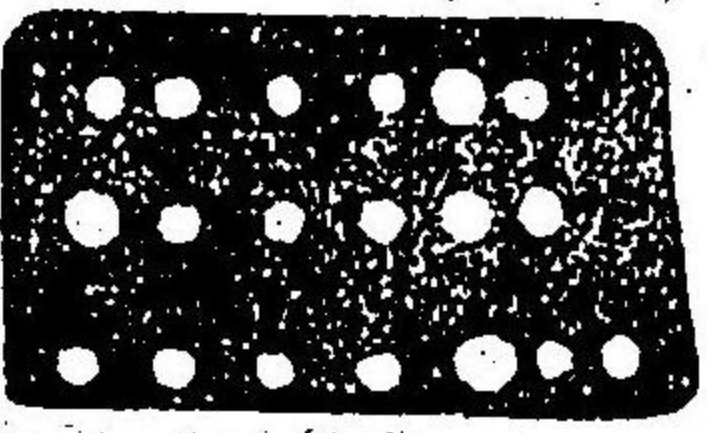
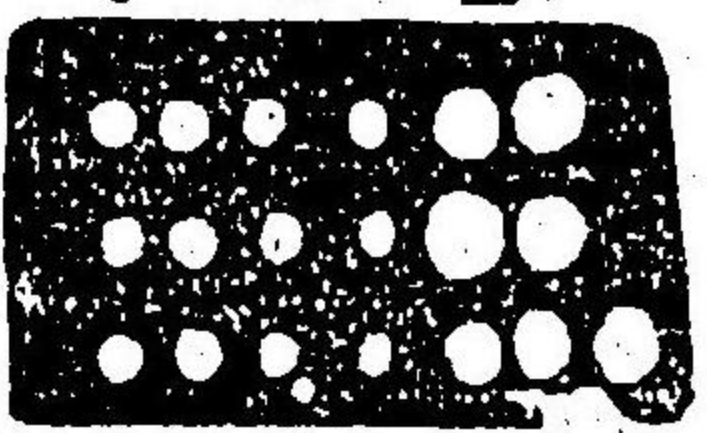

胸板二之板表圖

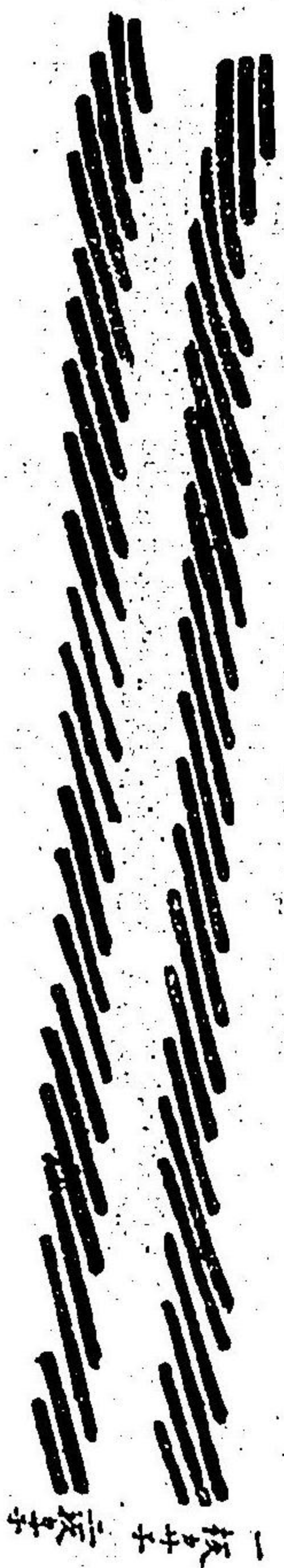

一板子 一板子

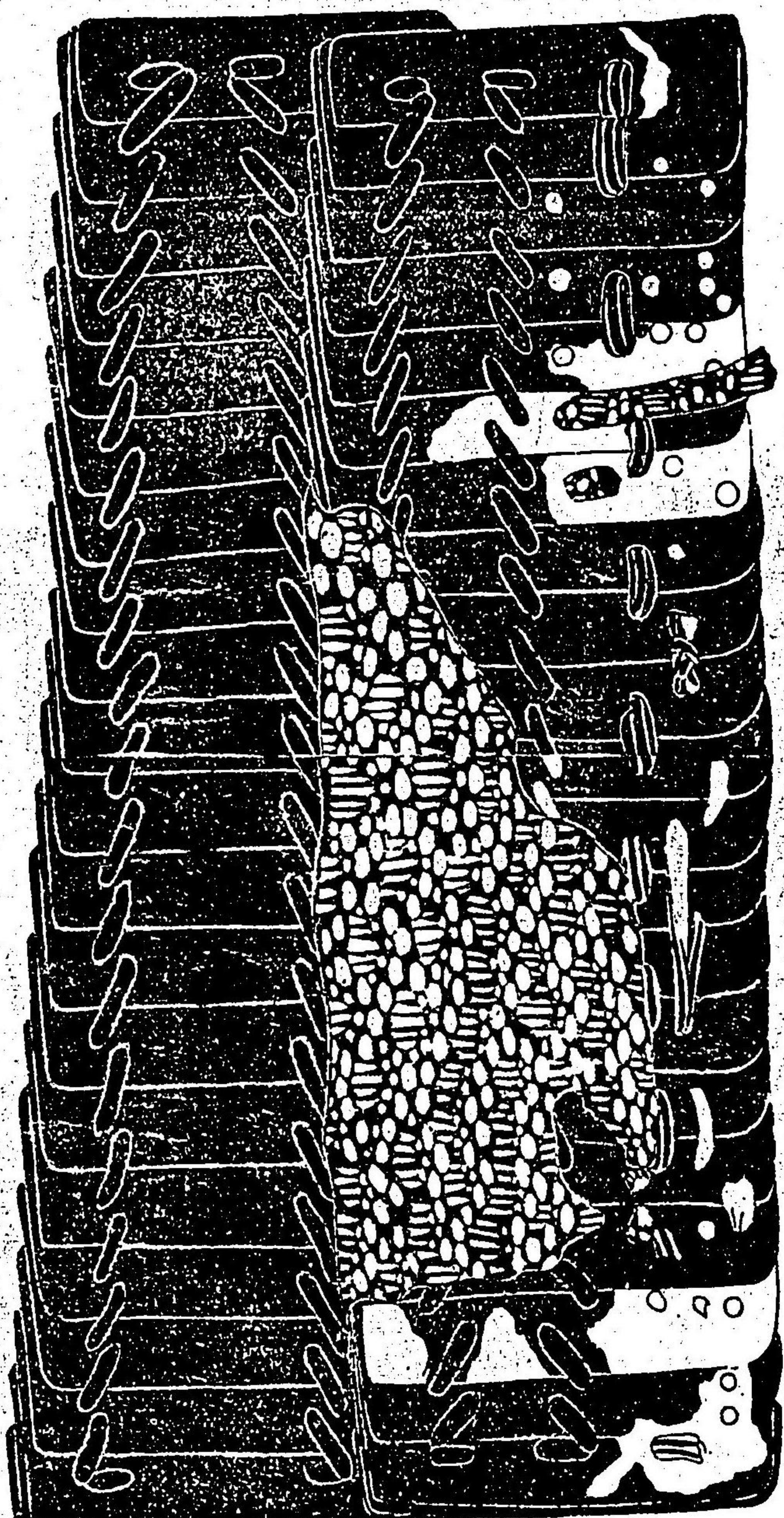

甲冑

同裏圖

此包草色如漆

上平入取水引之金物又々者トナリトナリ限越

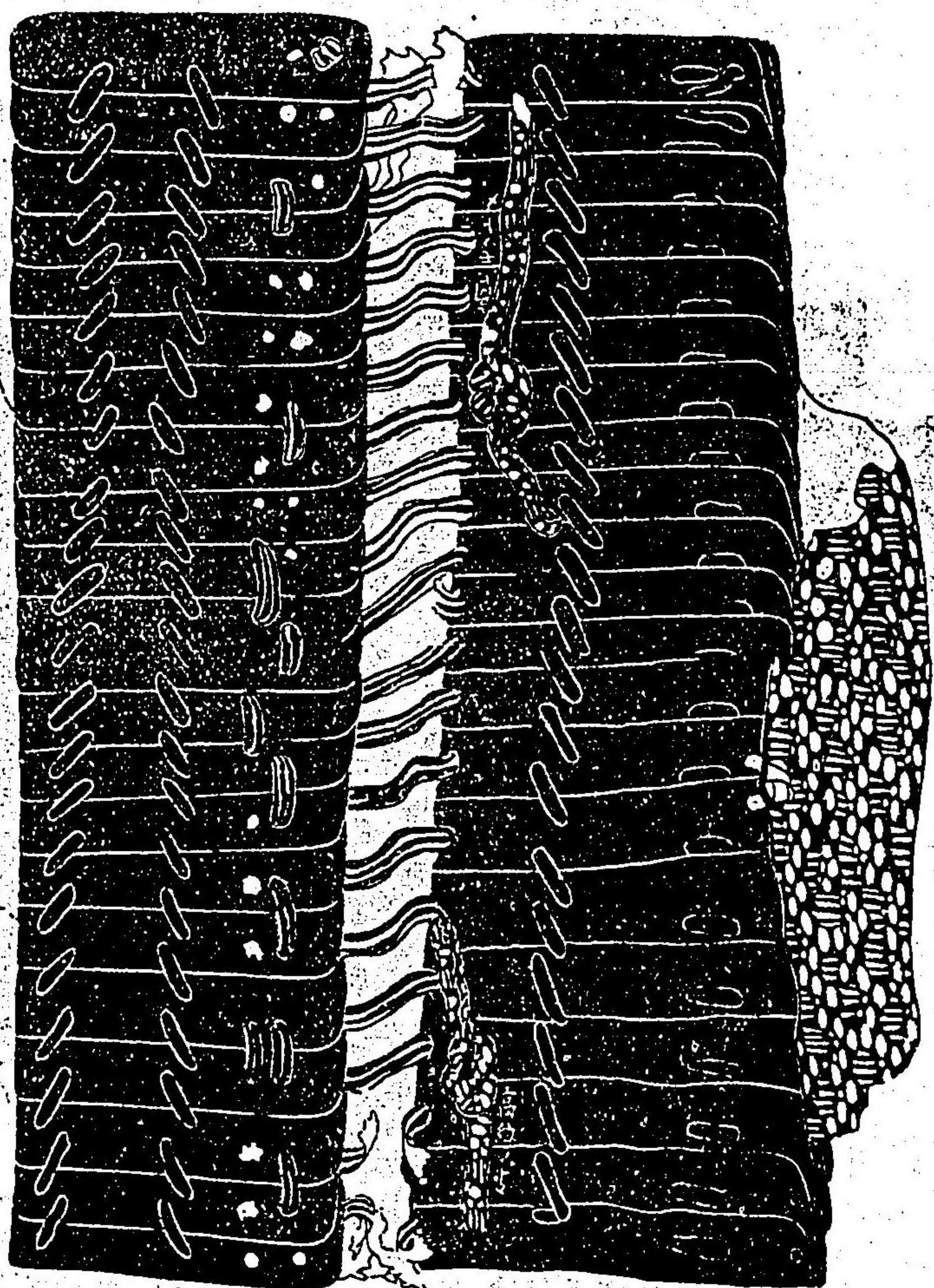

同一之板ノカニ之圖

甲冑

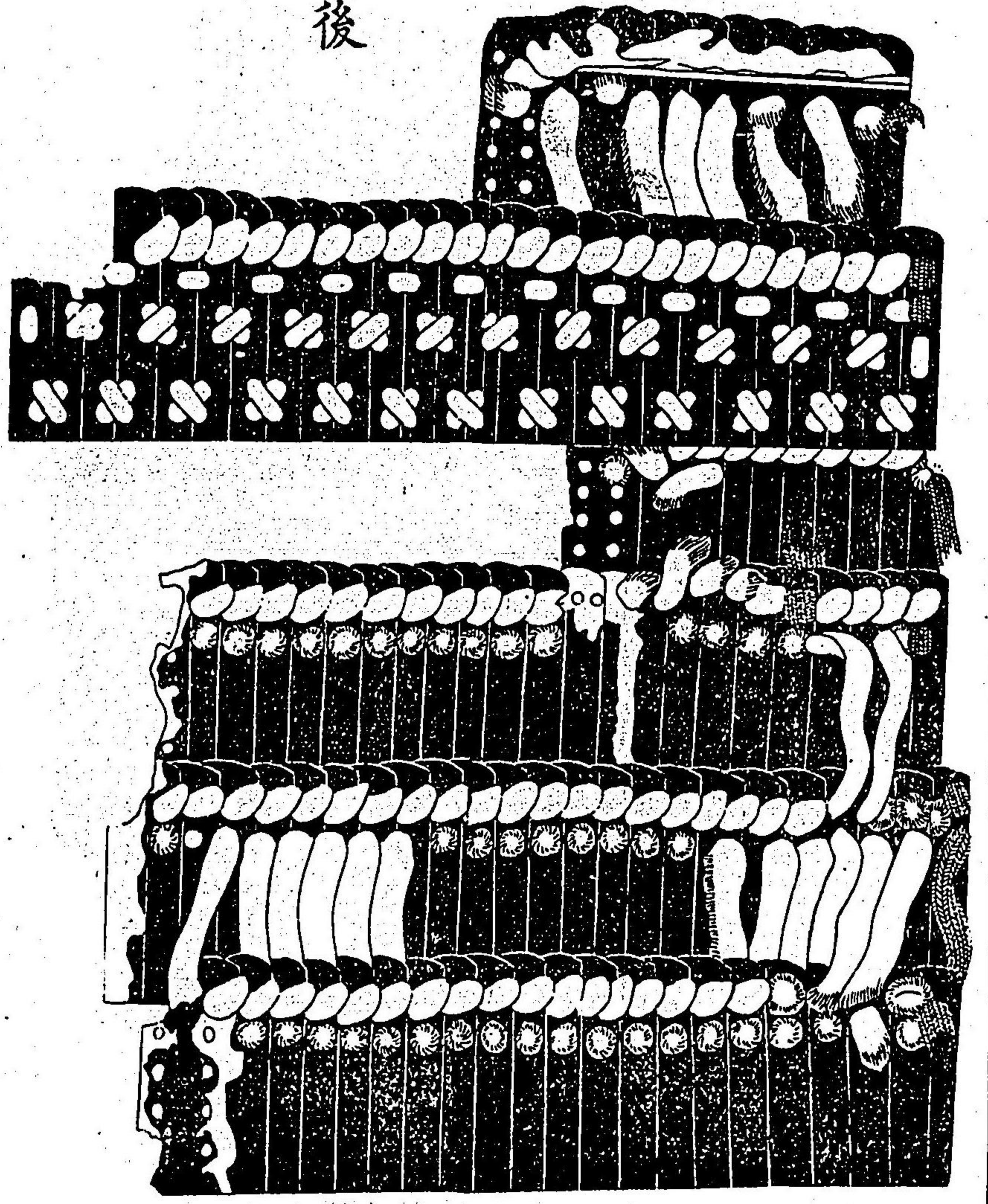

胴後

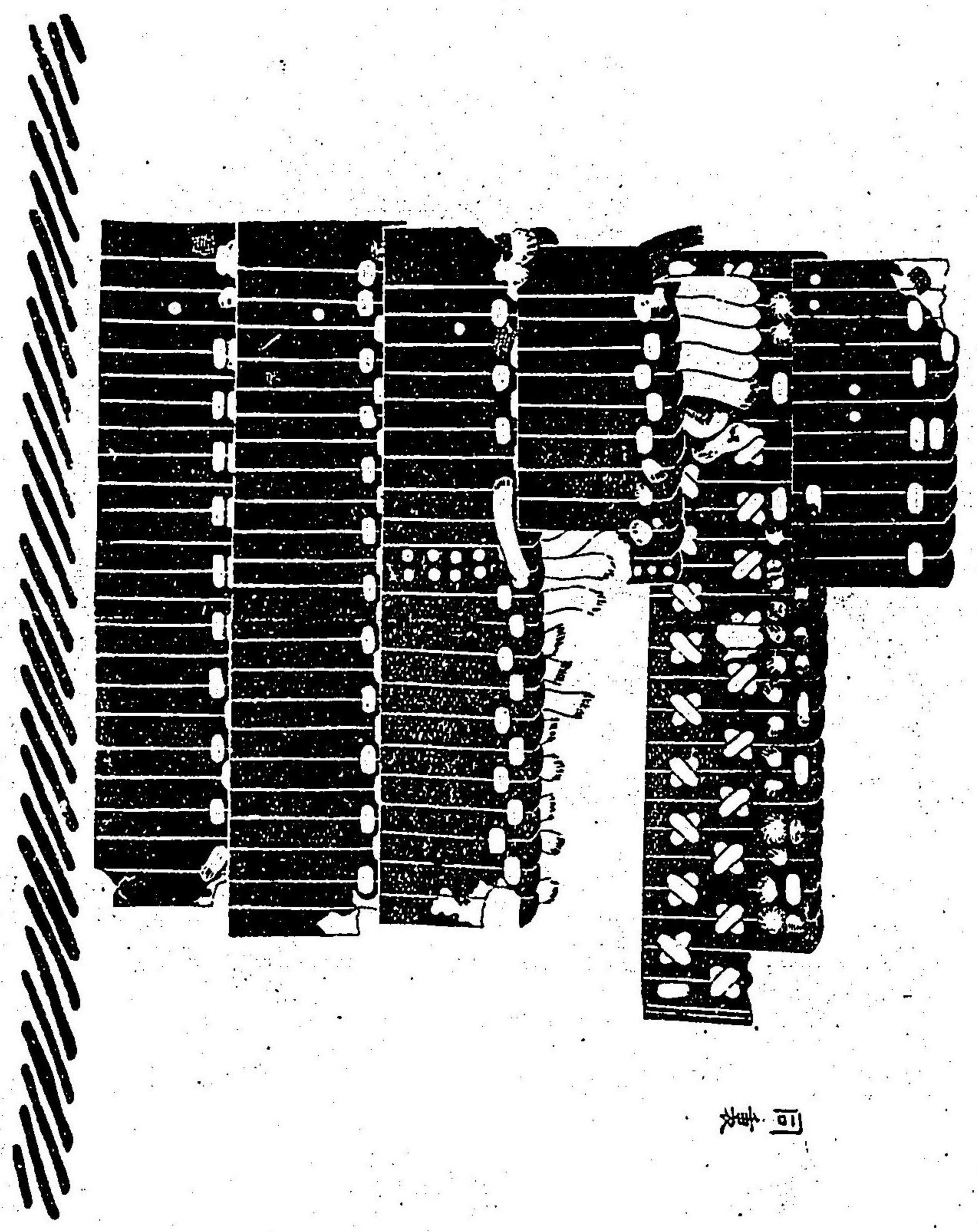

同裏

綿ガ之所存

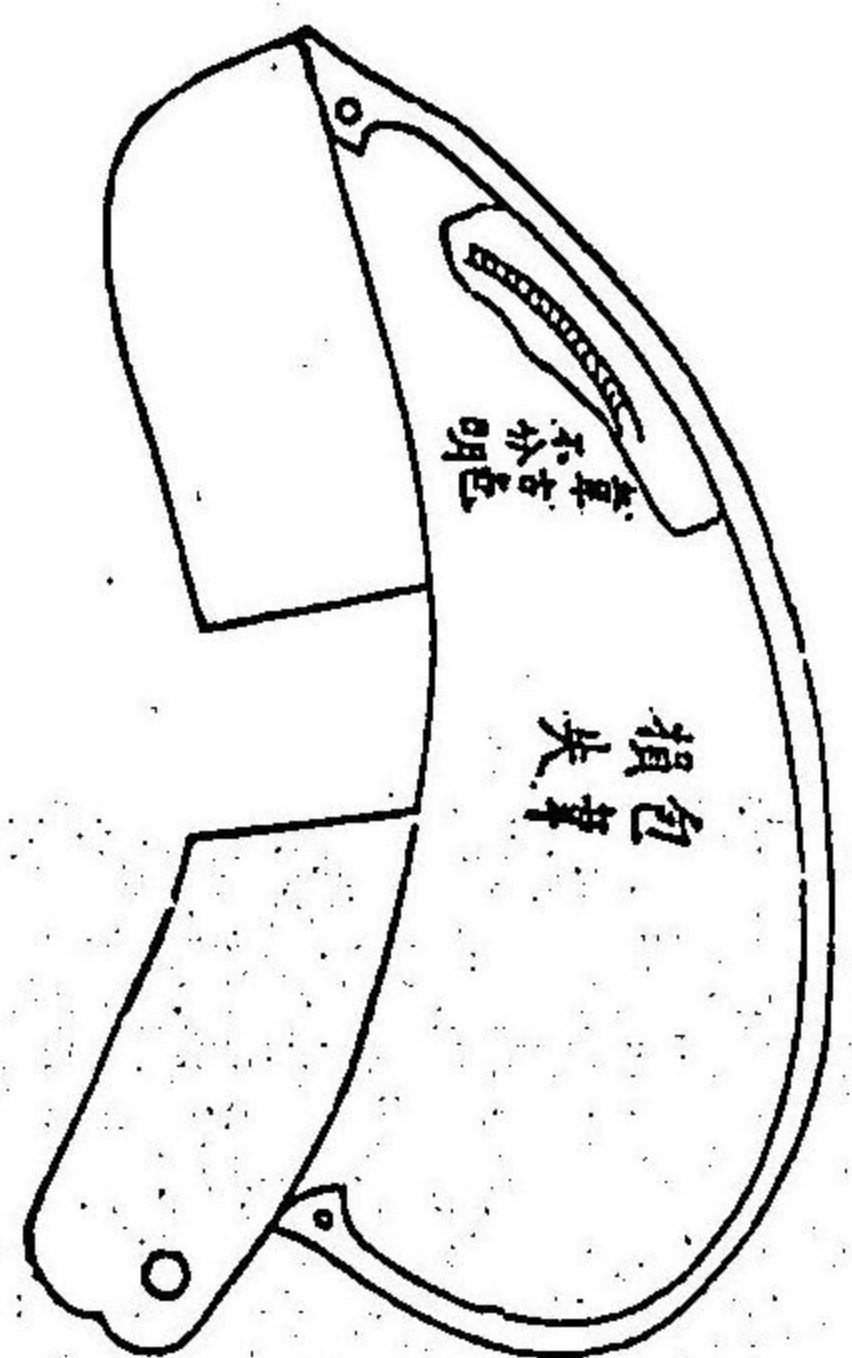
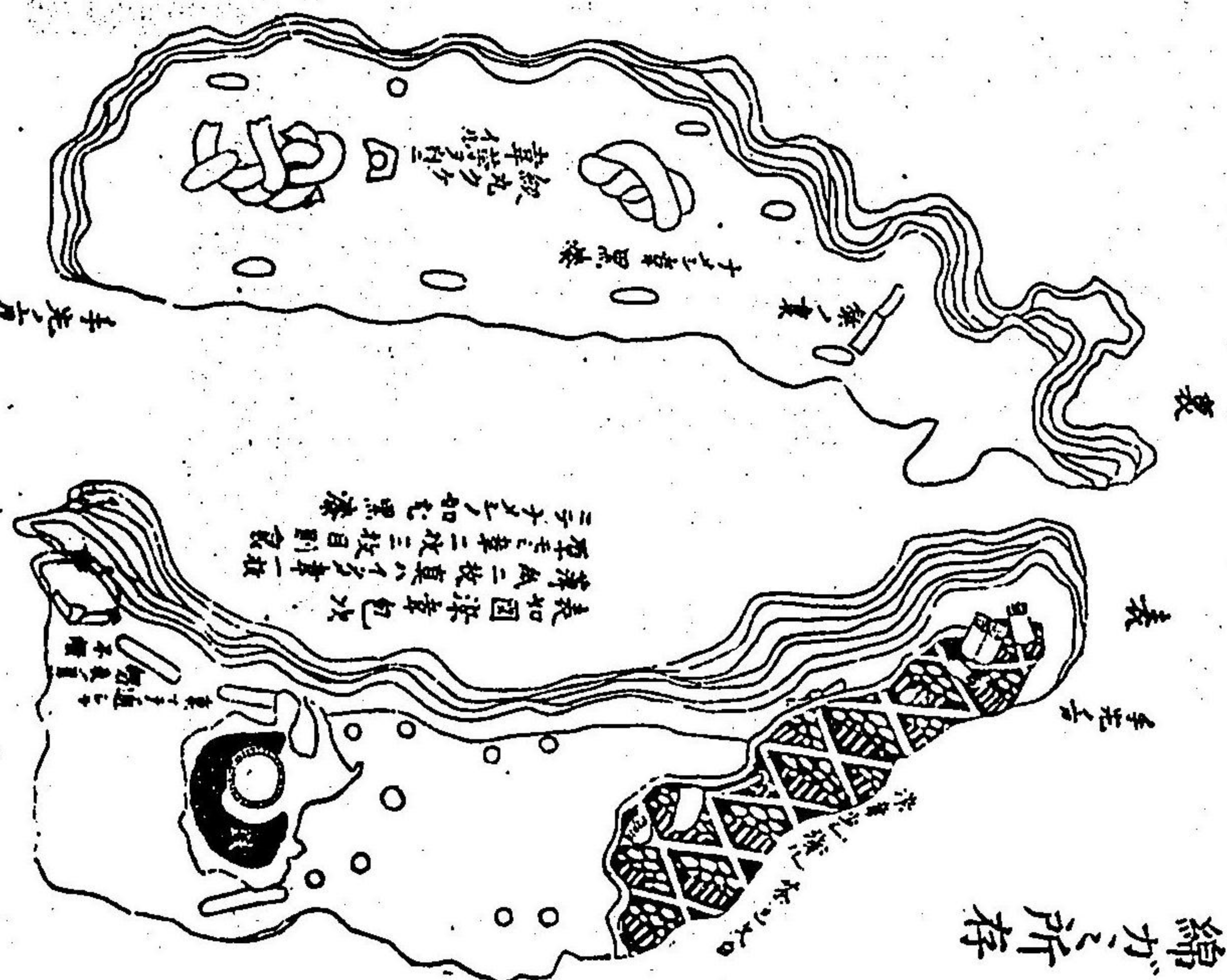

障子板如此雜有之

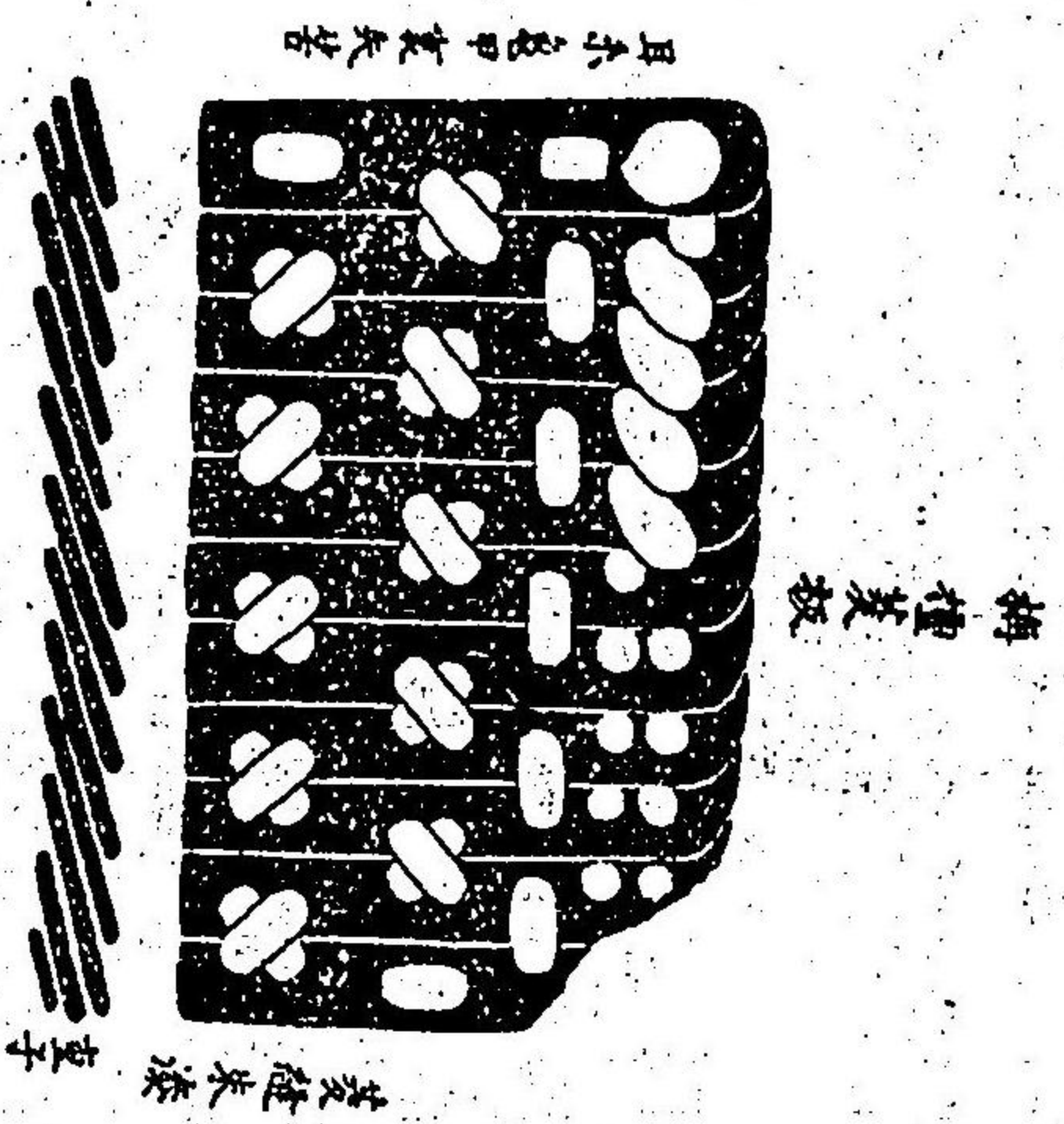

耳糸急甲實失告

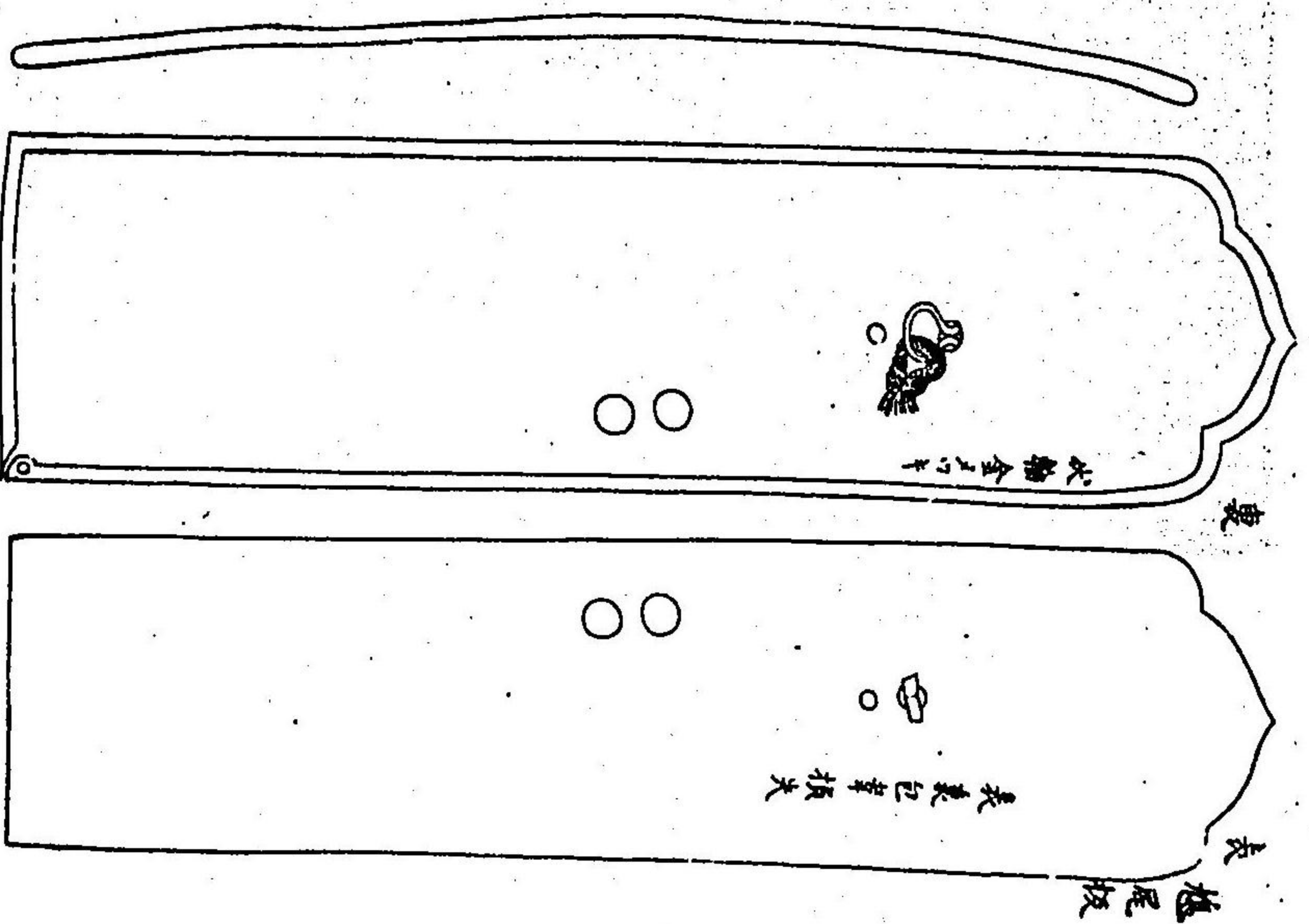

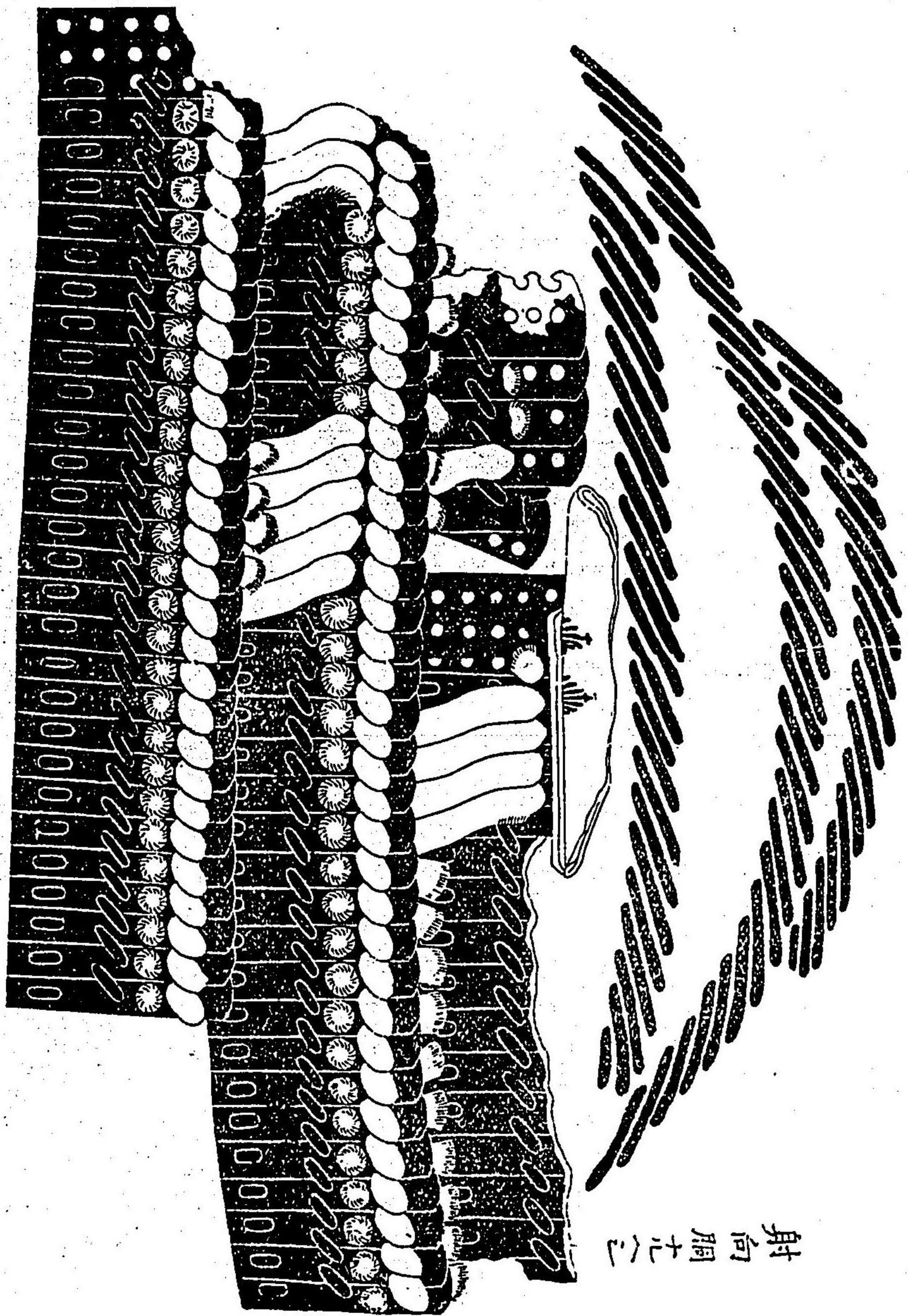

射向洞七之

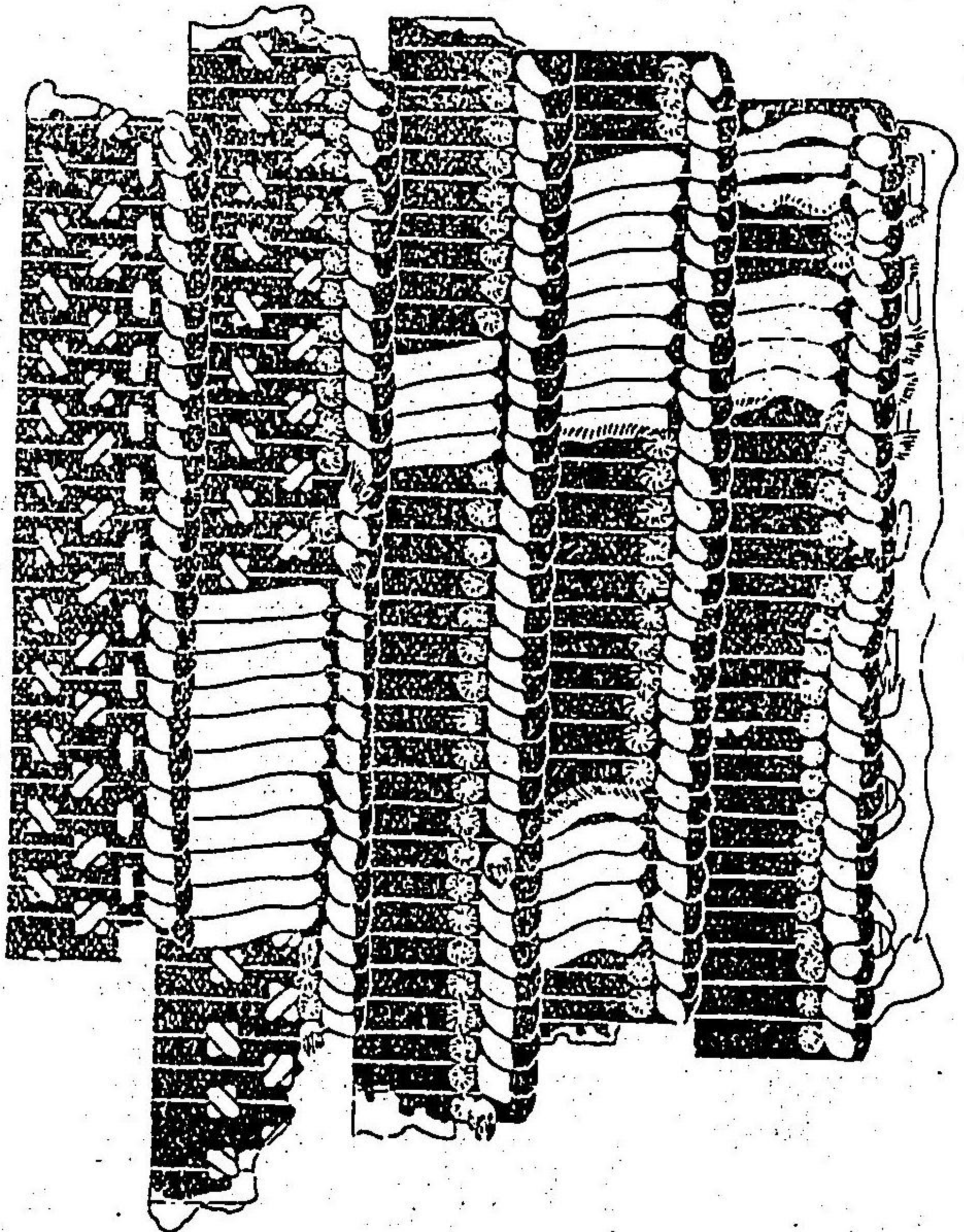

射向草摺七之

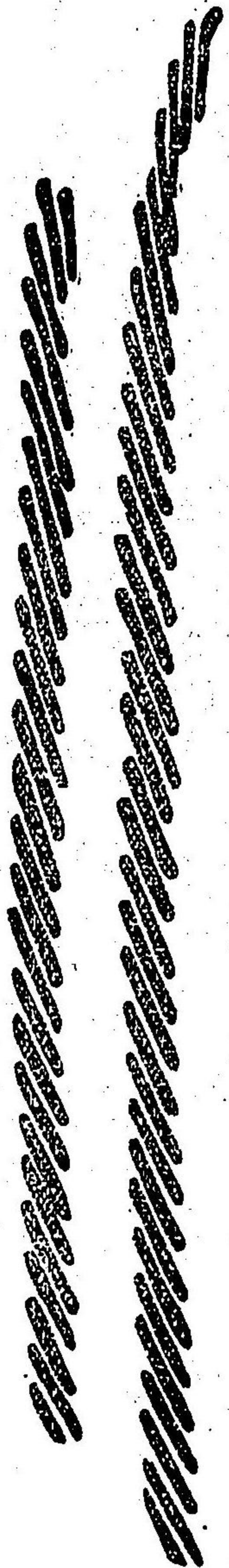

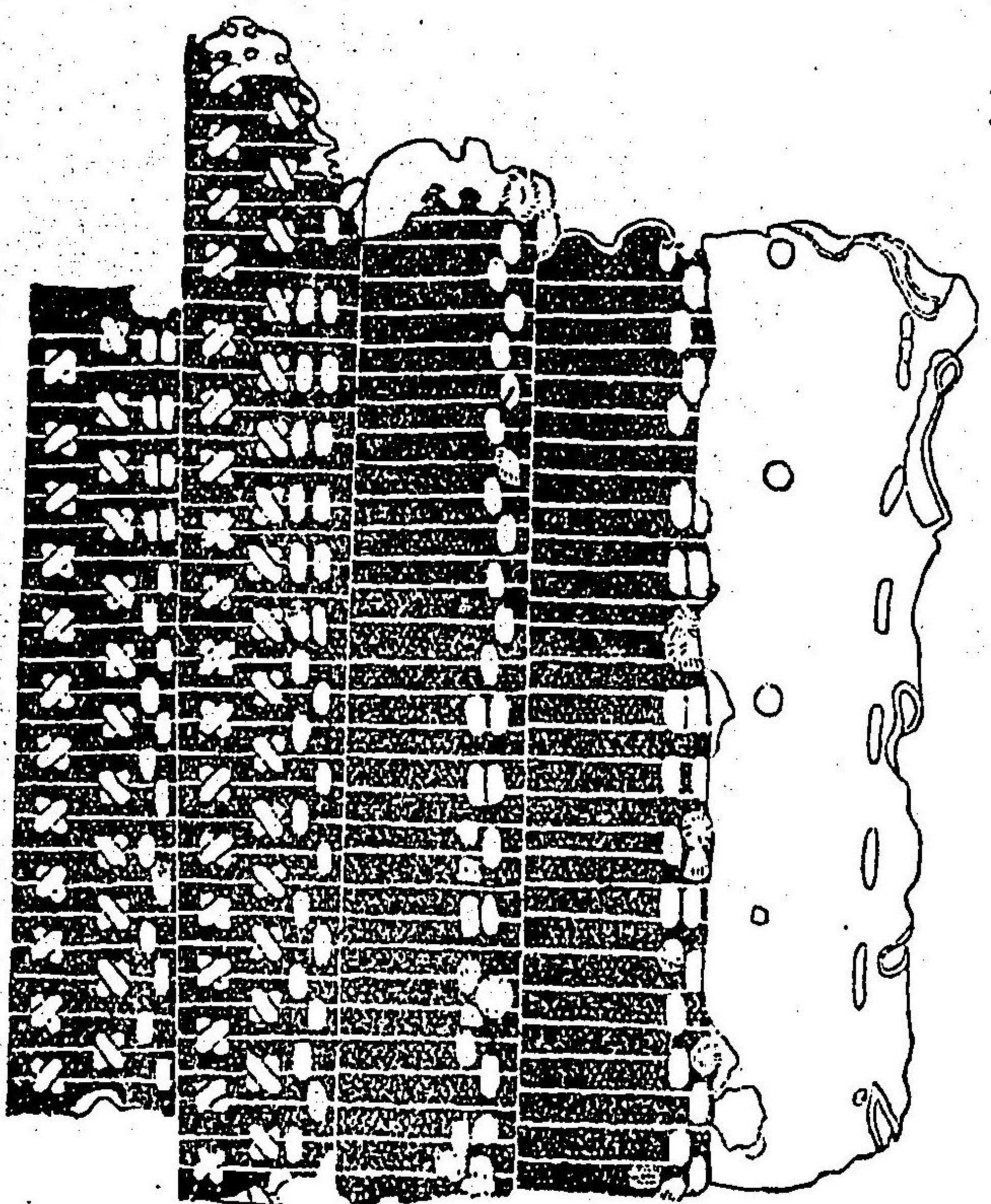

同表

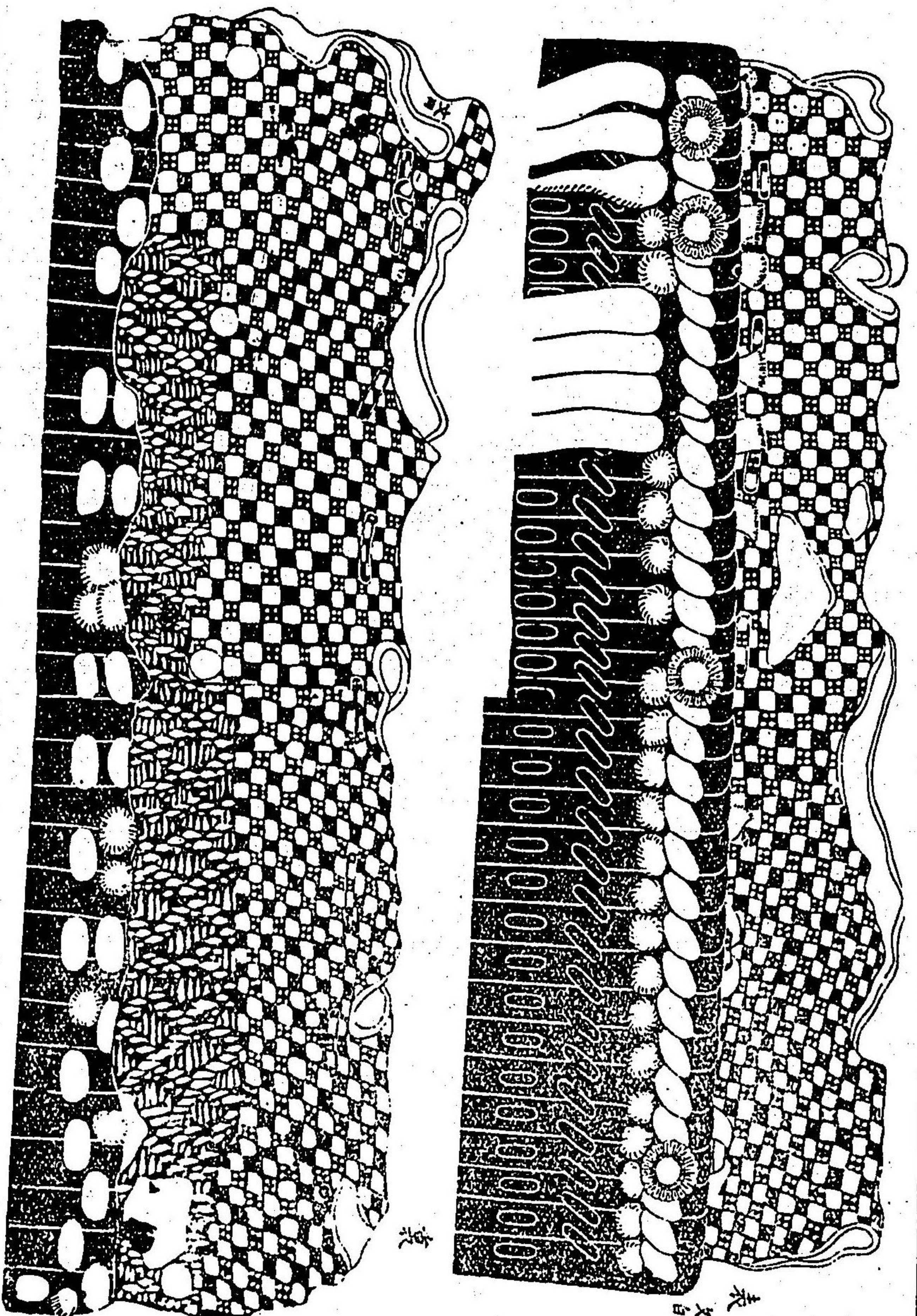

射向端
附之圖
表
文
章
記

表

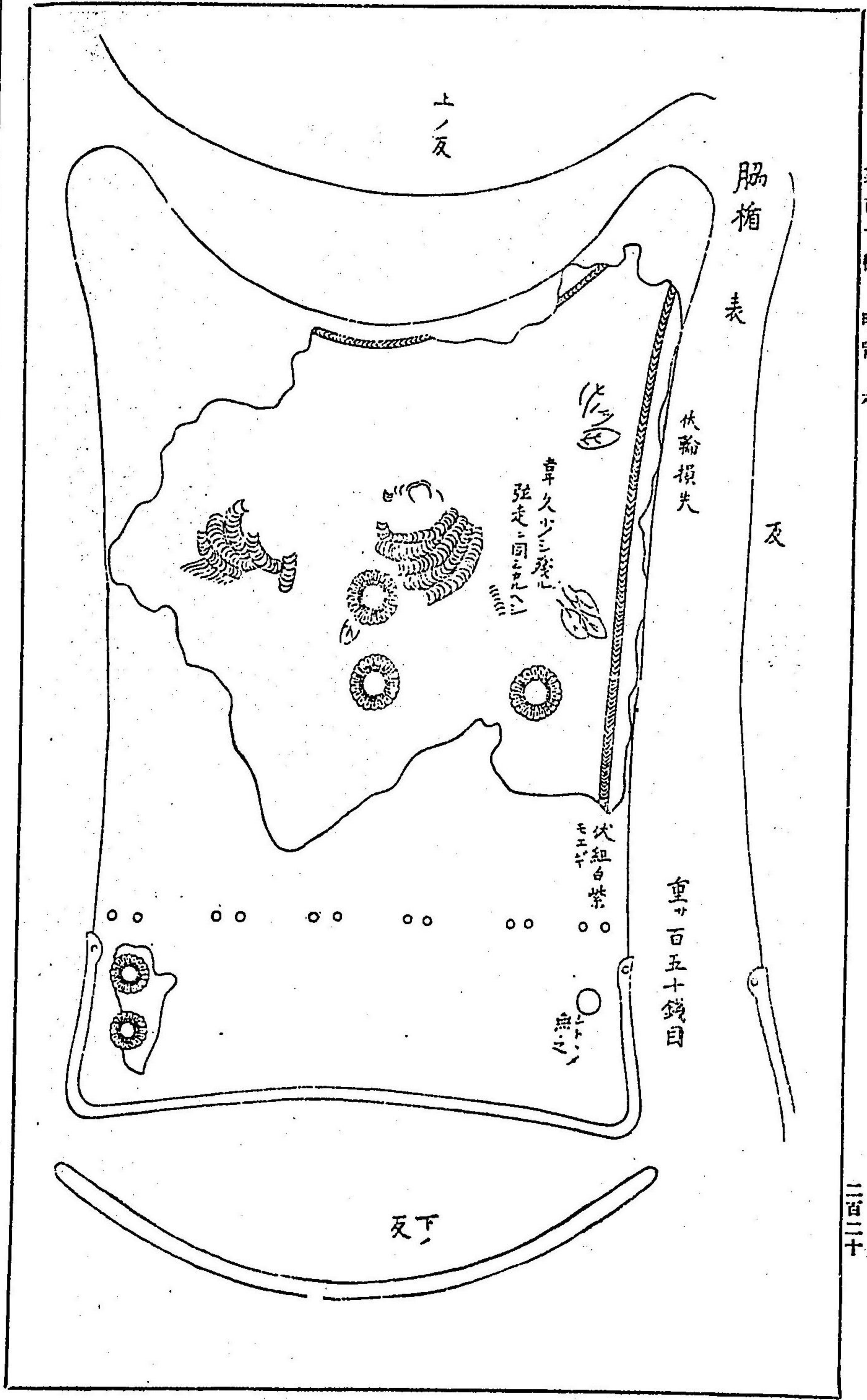

同裏

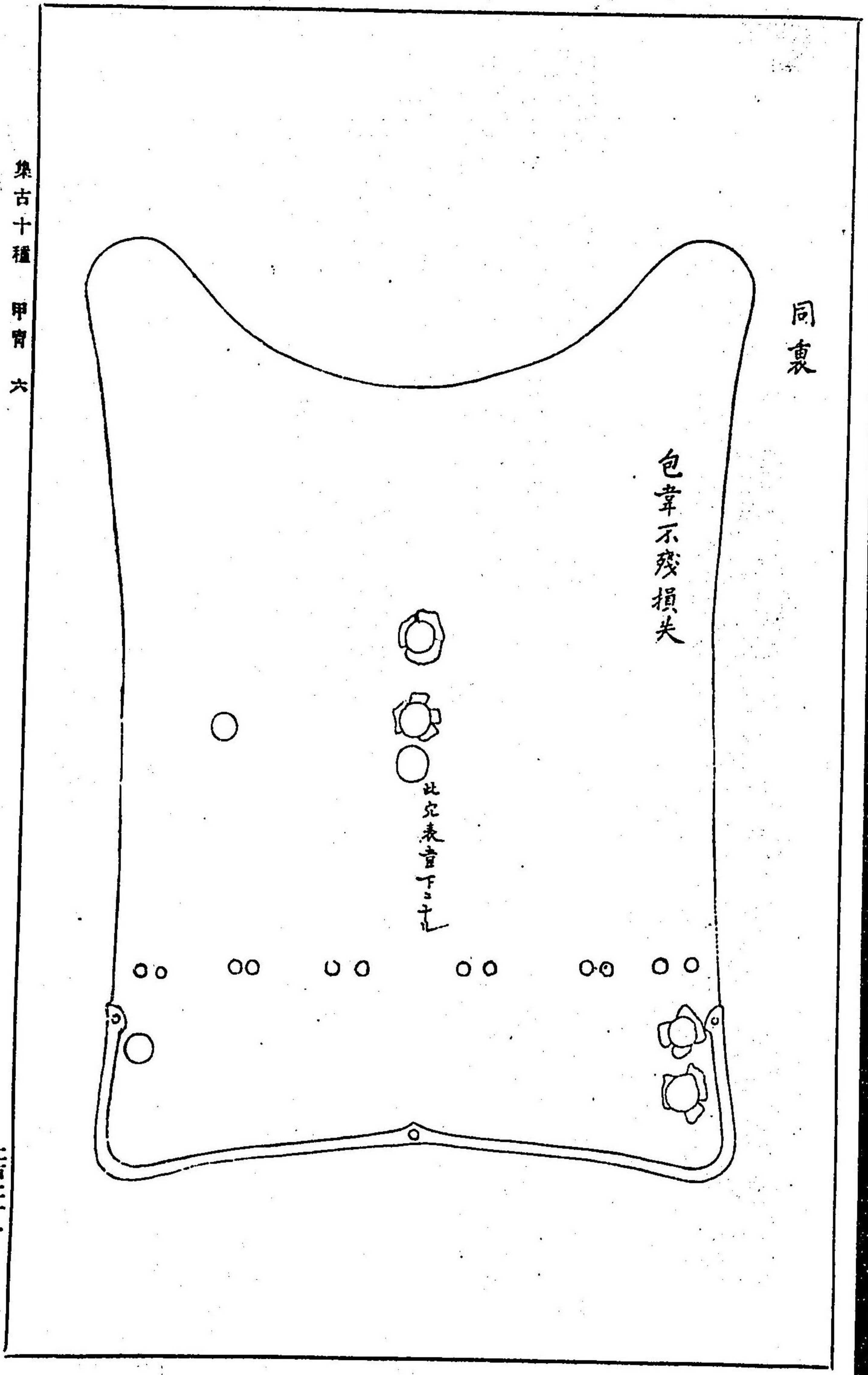

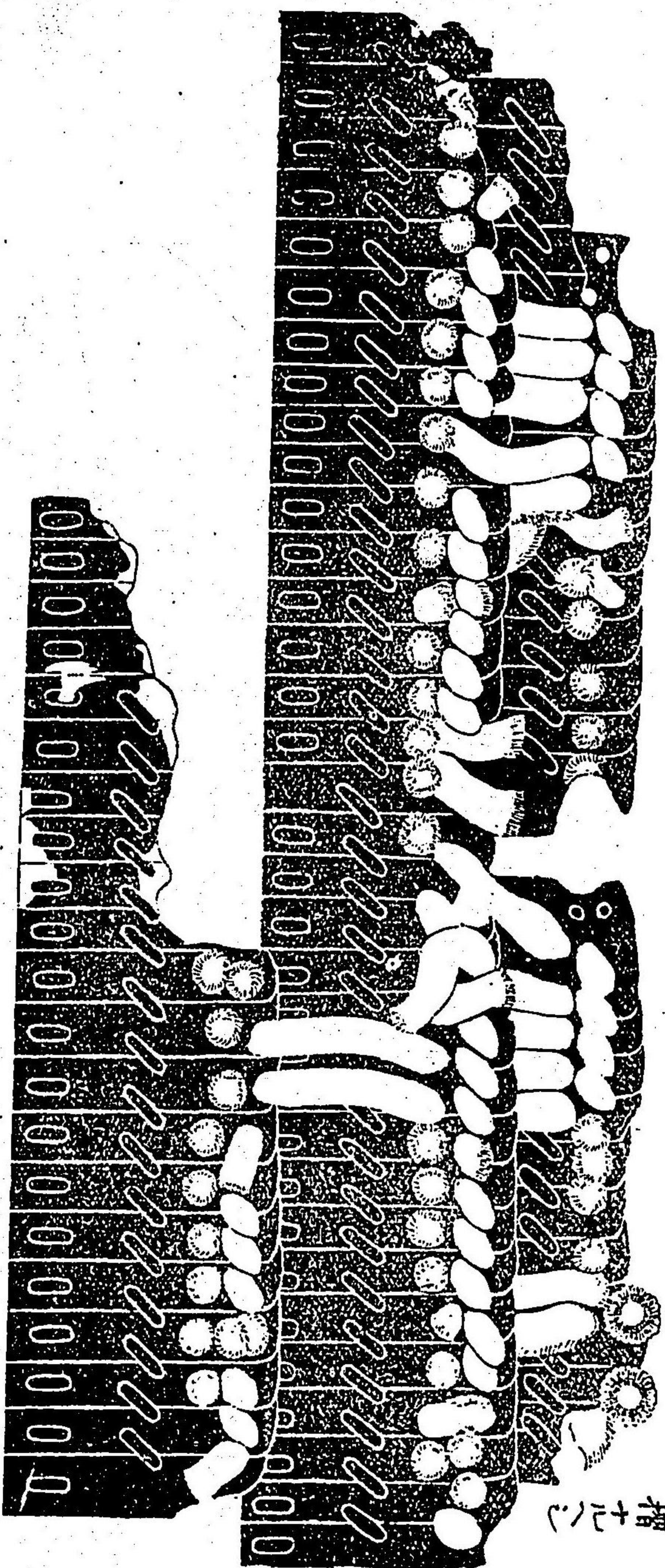

管九

妻手草摺十七之

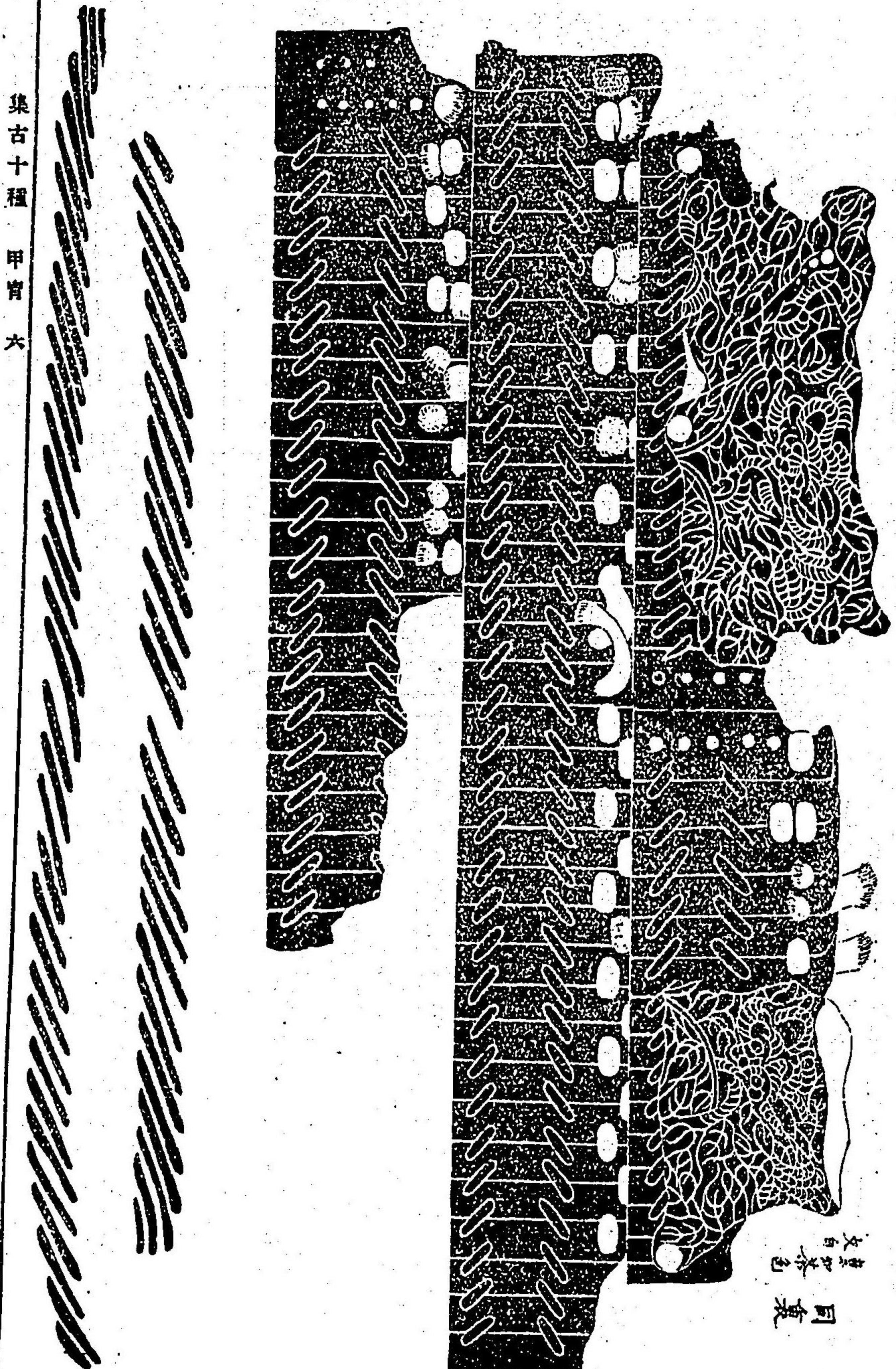

女白
草摺
同裏

袖冠板

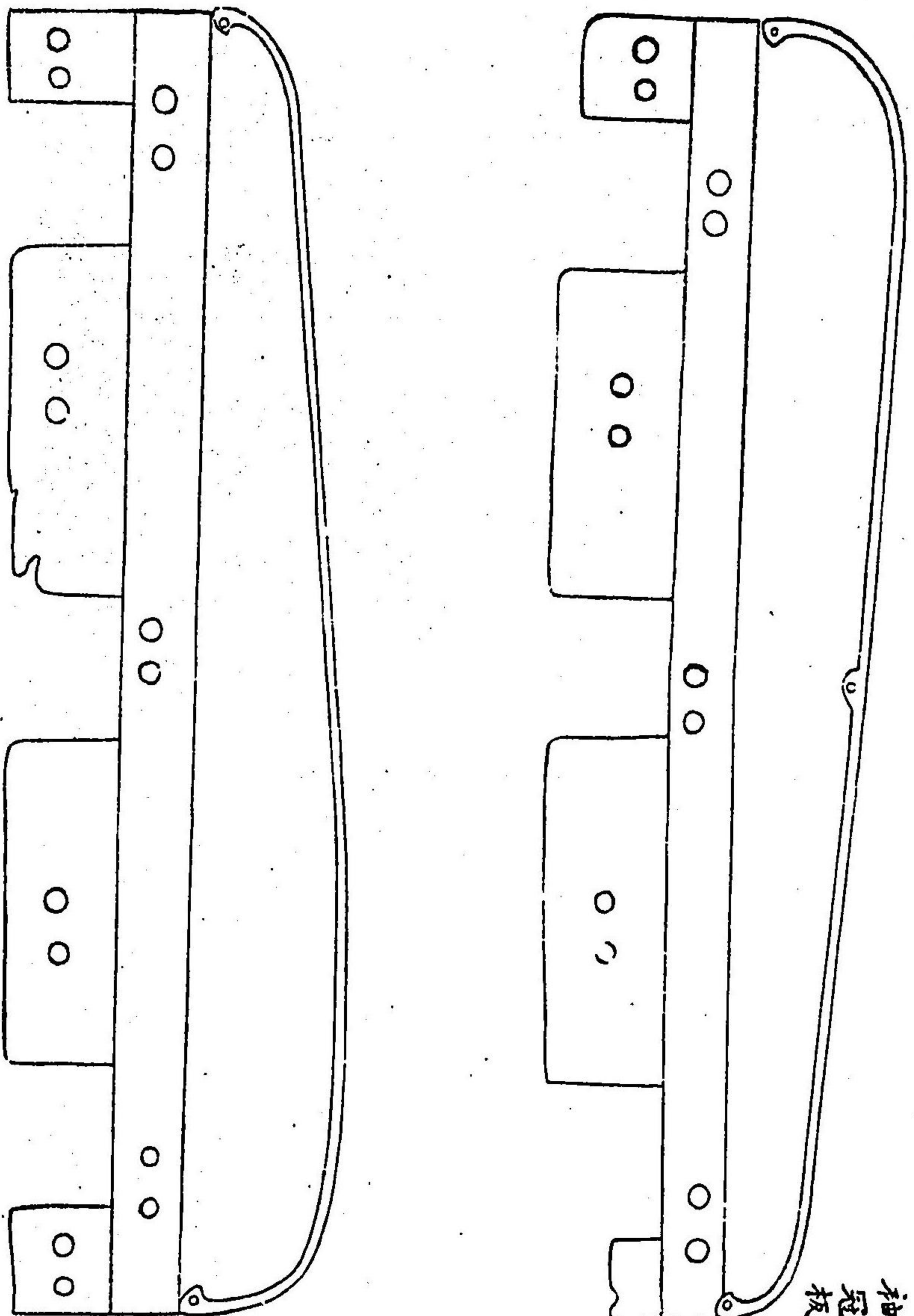

袖

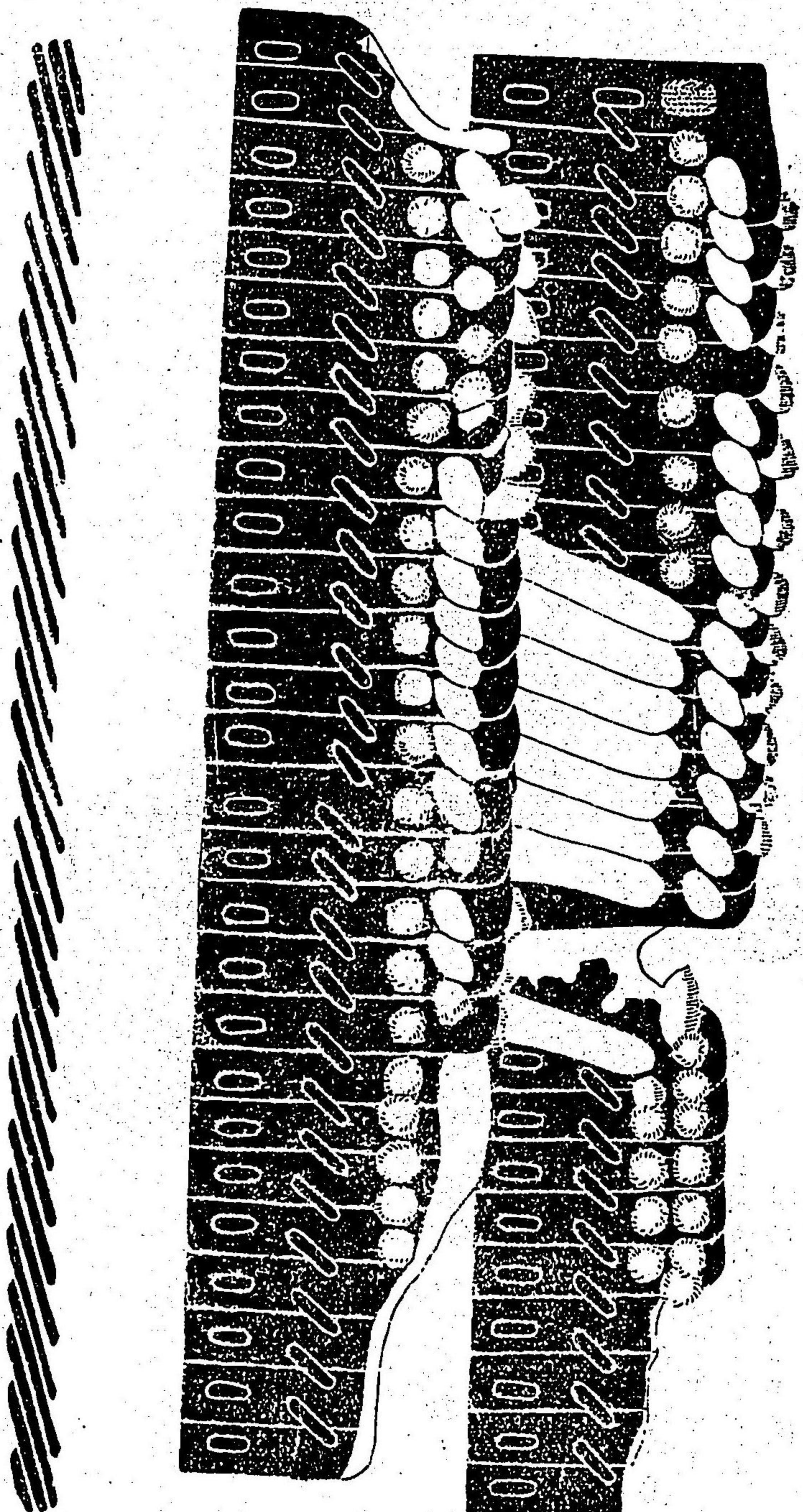

出雲國日御崎神社藏甲由目圖

由目全圖

四方白地板金ノツキ
四天鉄無之
鉢付ノ鉄少シツテ透アリ

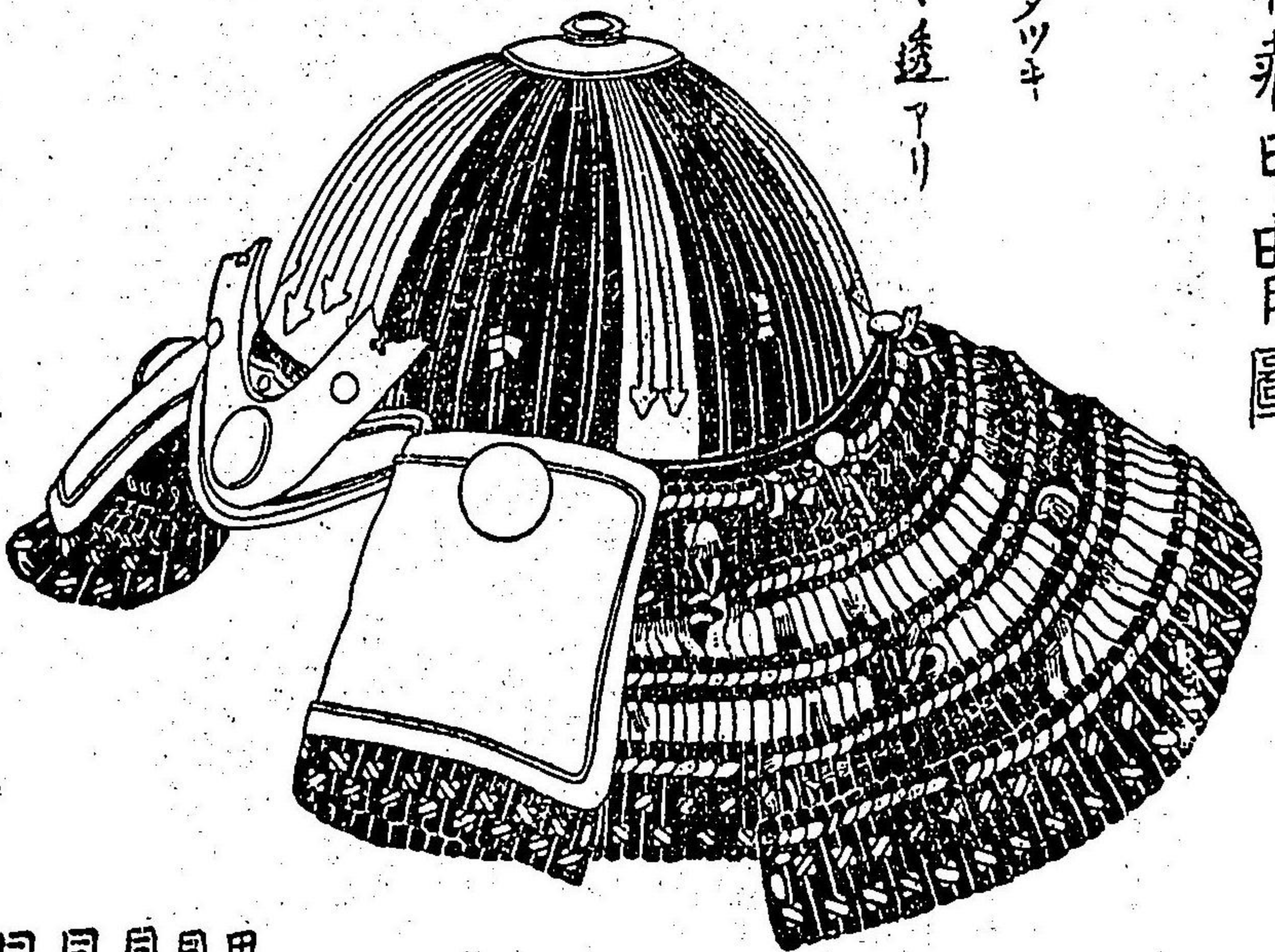

甲冑威糸白菱系緋
同 金物金ノツキ
同 目糸白蒔黄紫
同 畦目伏組亦同
同 小縁五星

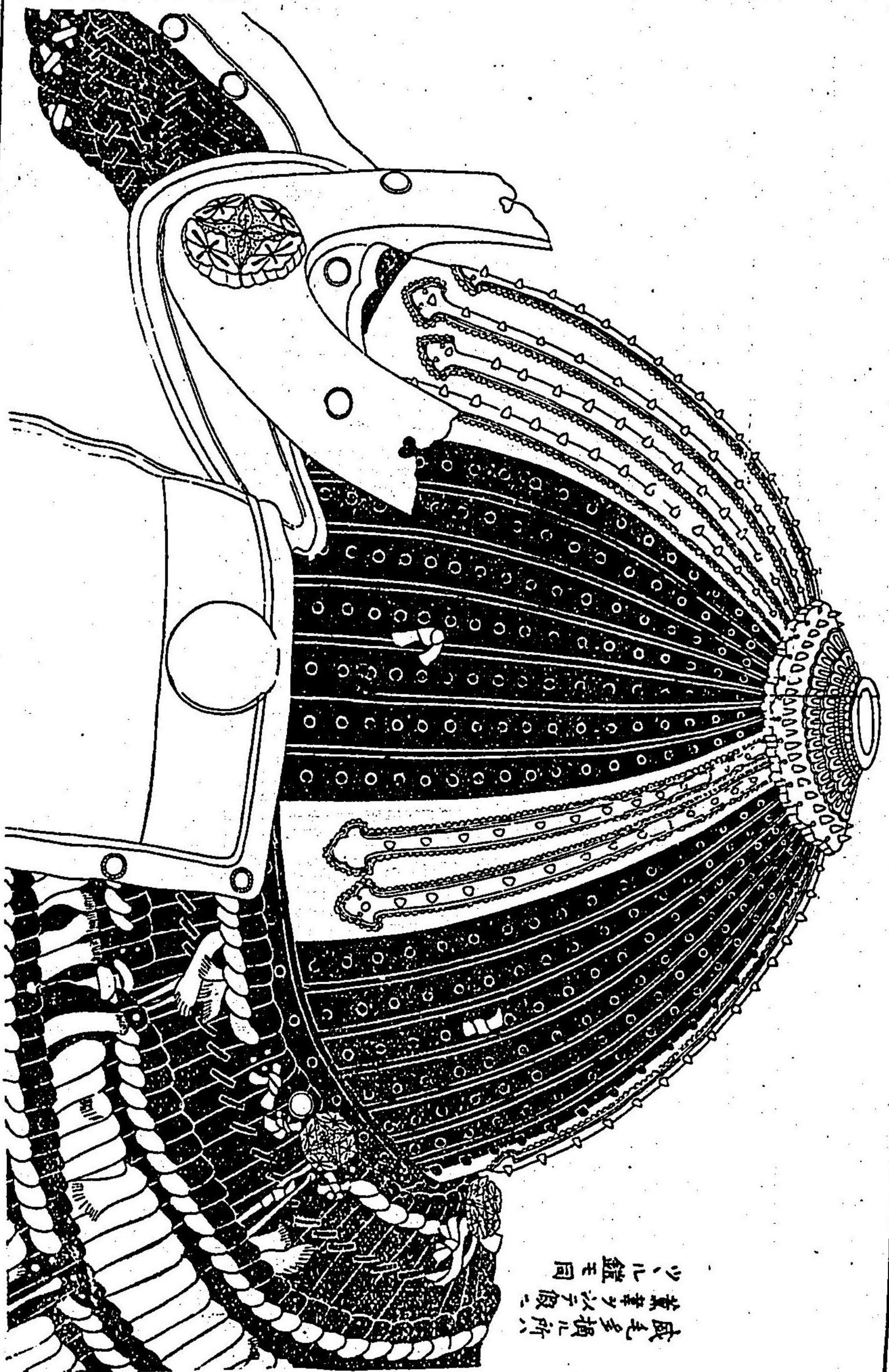

威多損ニ所
兼サ以テ假ニ
少ニ鑑玉同

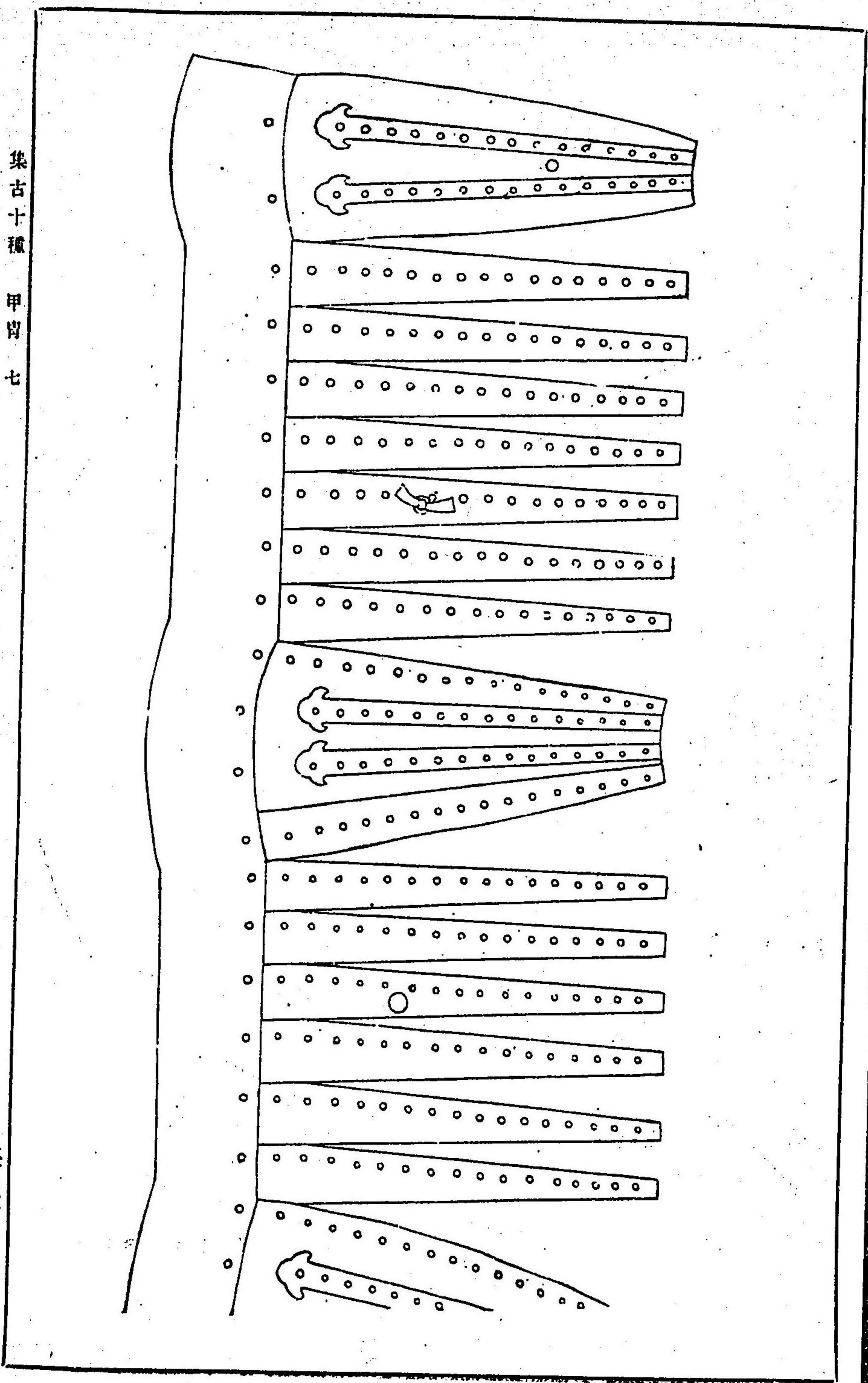
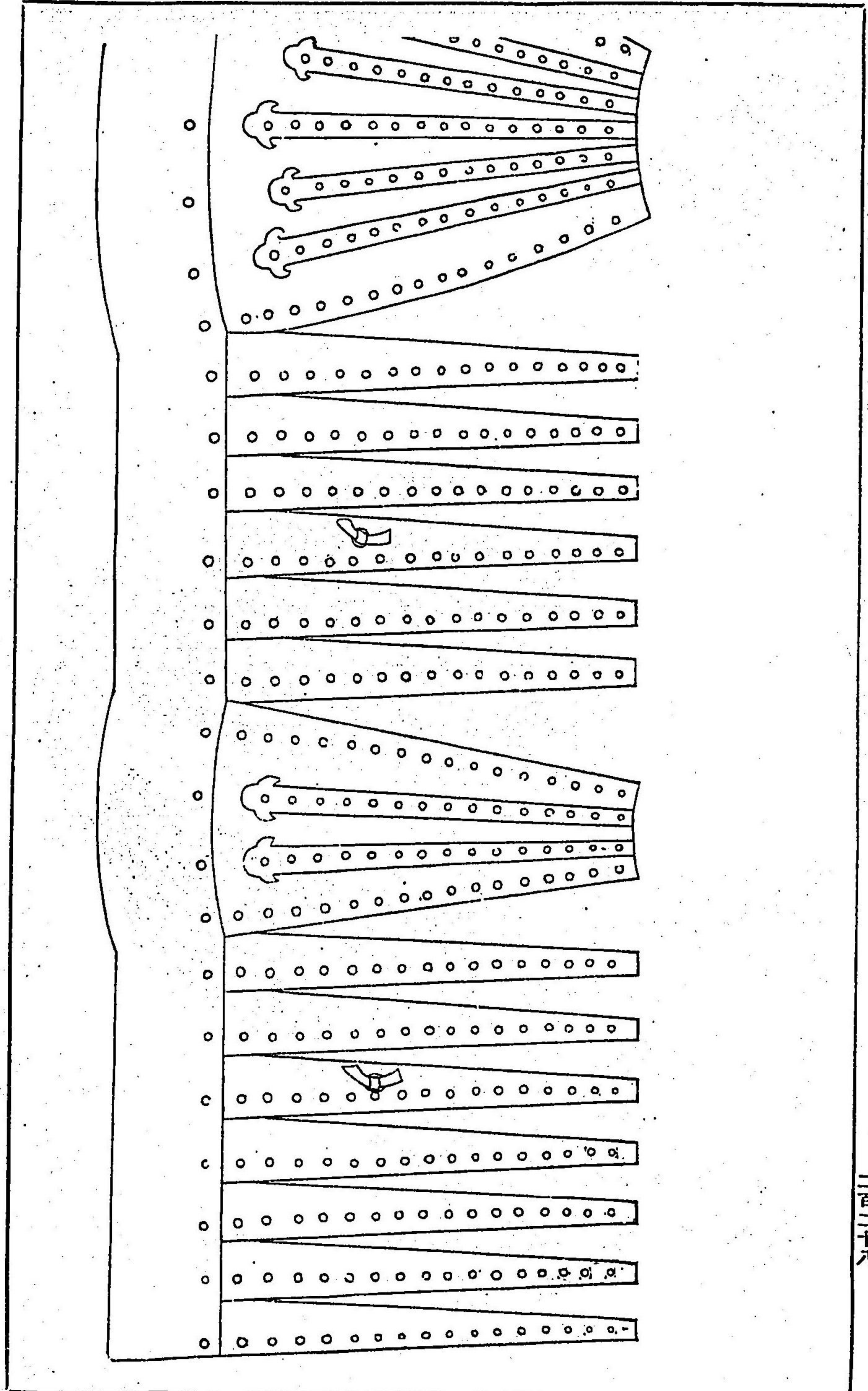

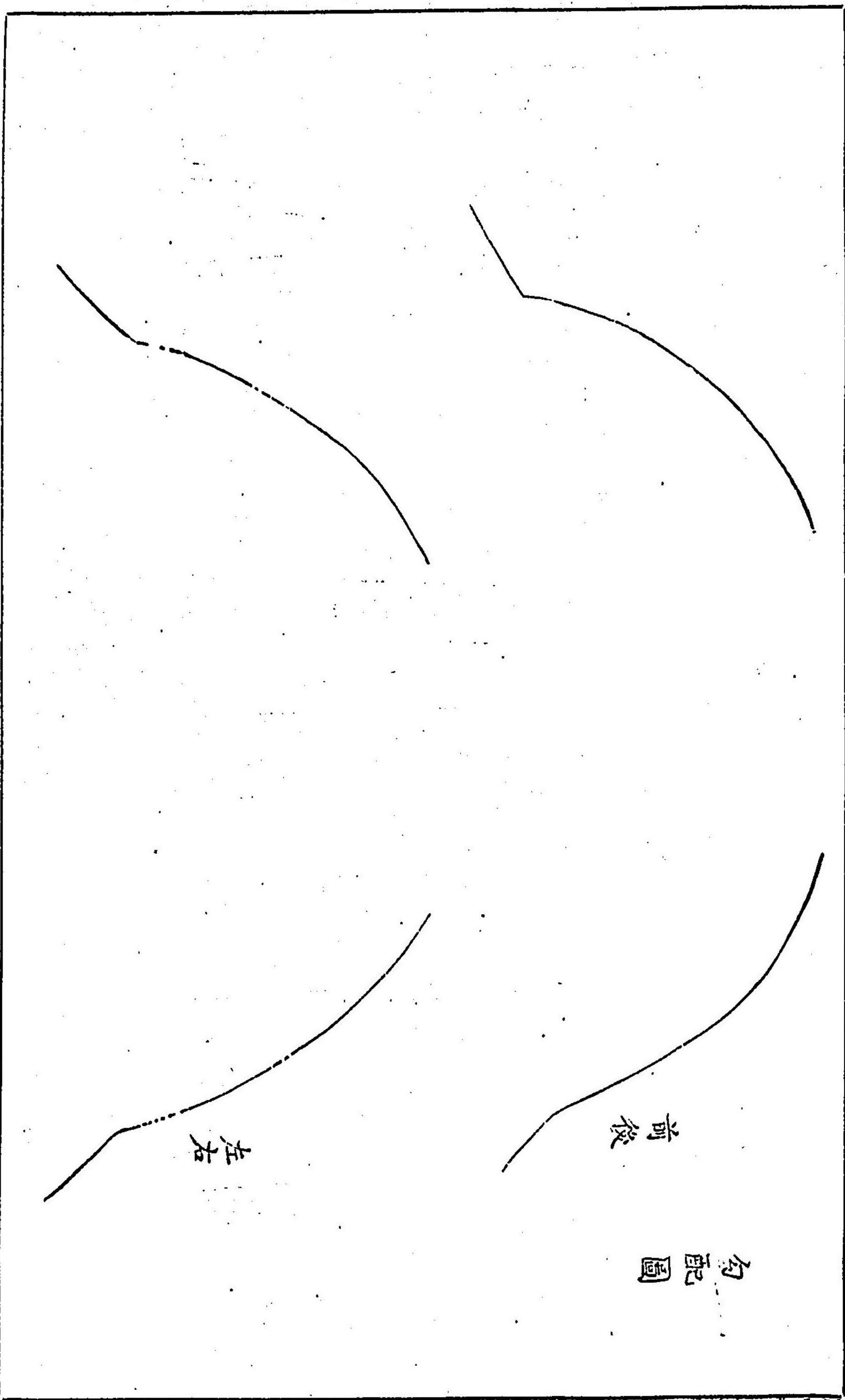

勾配圖



眉相裏

此宋二所出牡丹獅子
之華漆色皆同

悉于裏包葺
皆同色同文

此宋二所出牡丹獅子
之華漆色皆同

葺藍地白文双鉤ノ所由葺
悉于葺文古色不分明故ニ
其大概ヲ三ルヌ
故葺裏之間魚子鉄葺其外皆白

眉廂

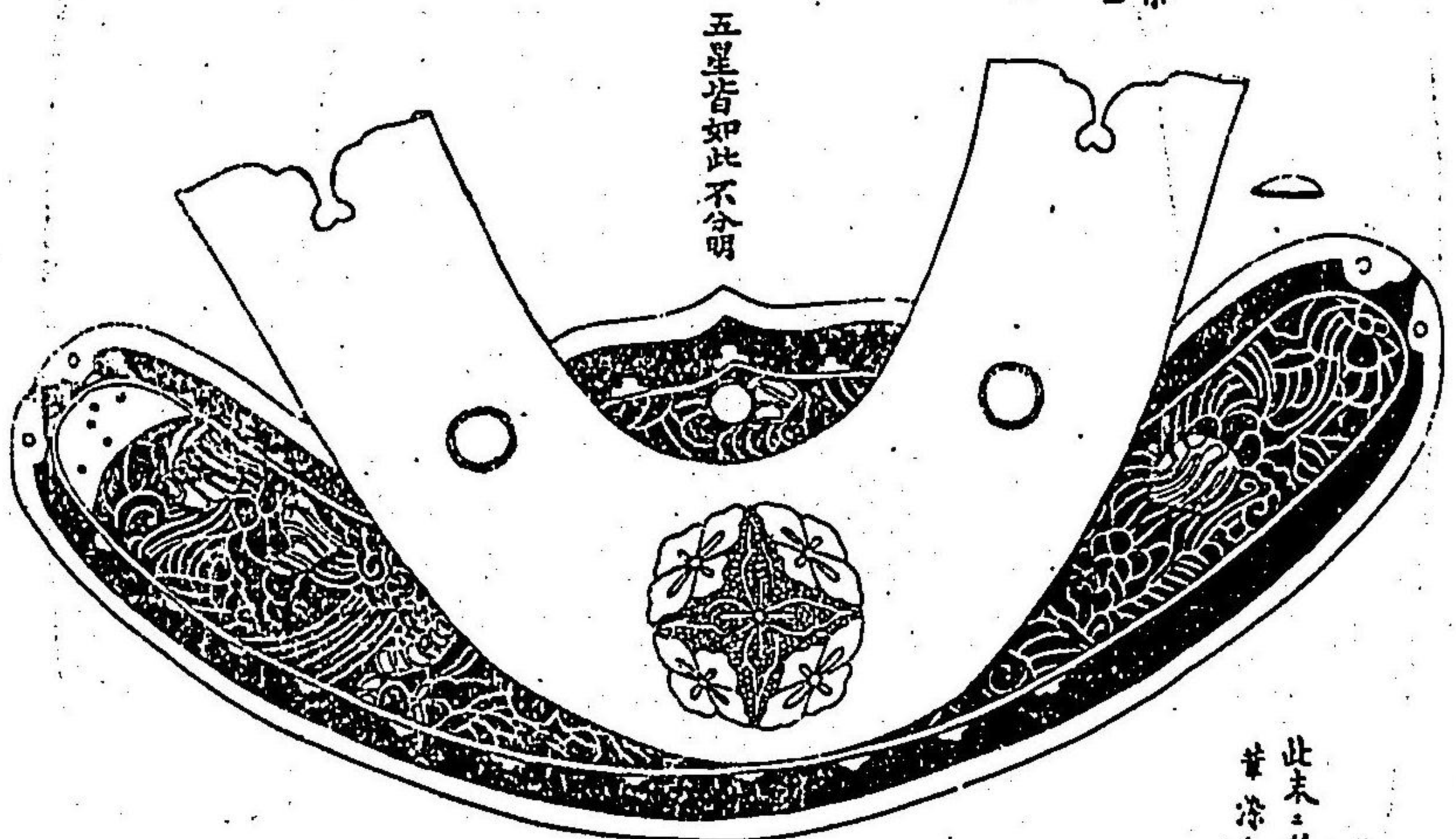

五里皆如此不分明

此宋二所出龍文之
華漆色皆同

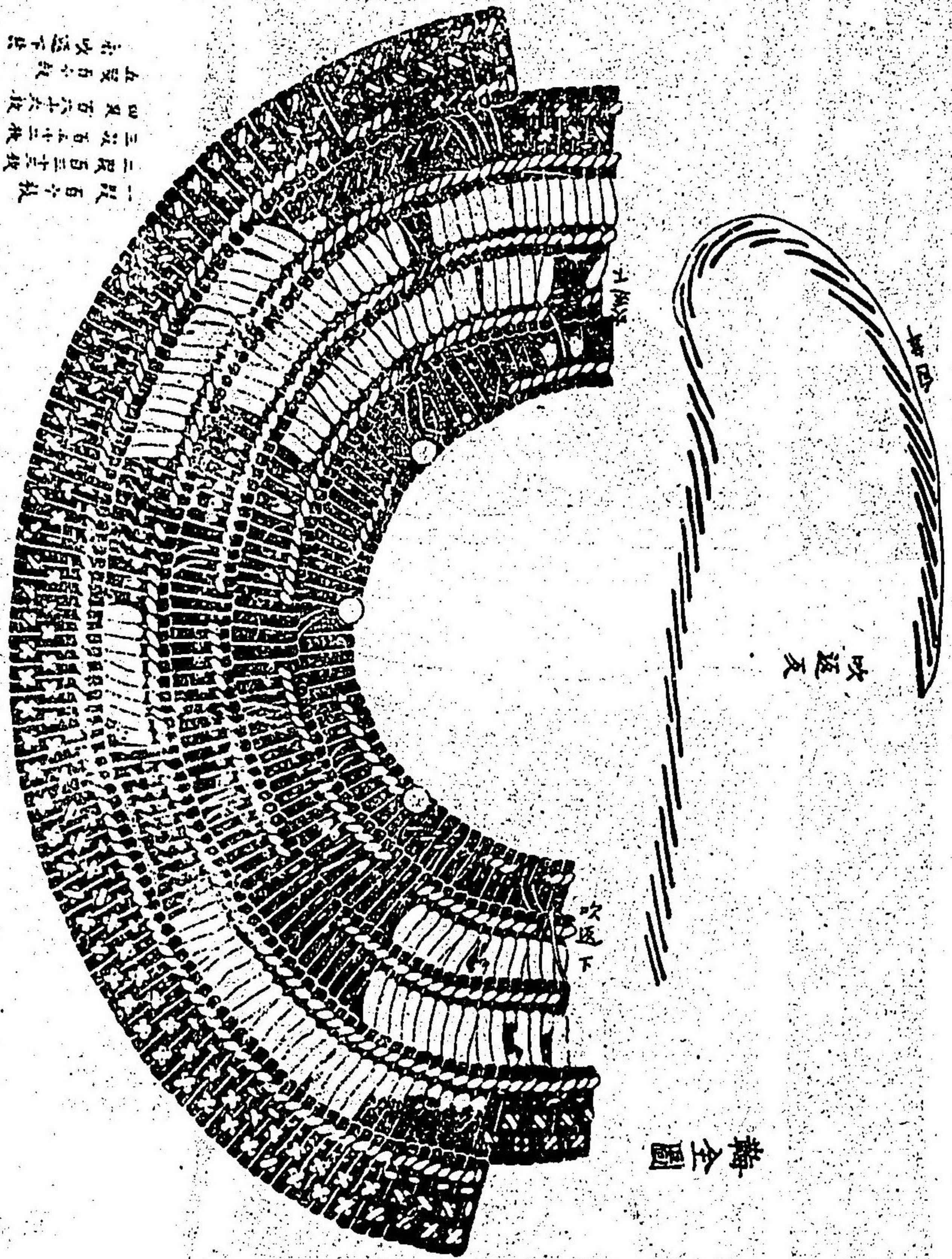
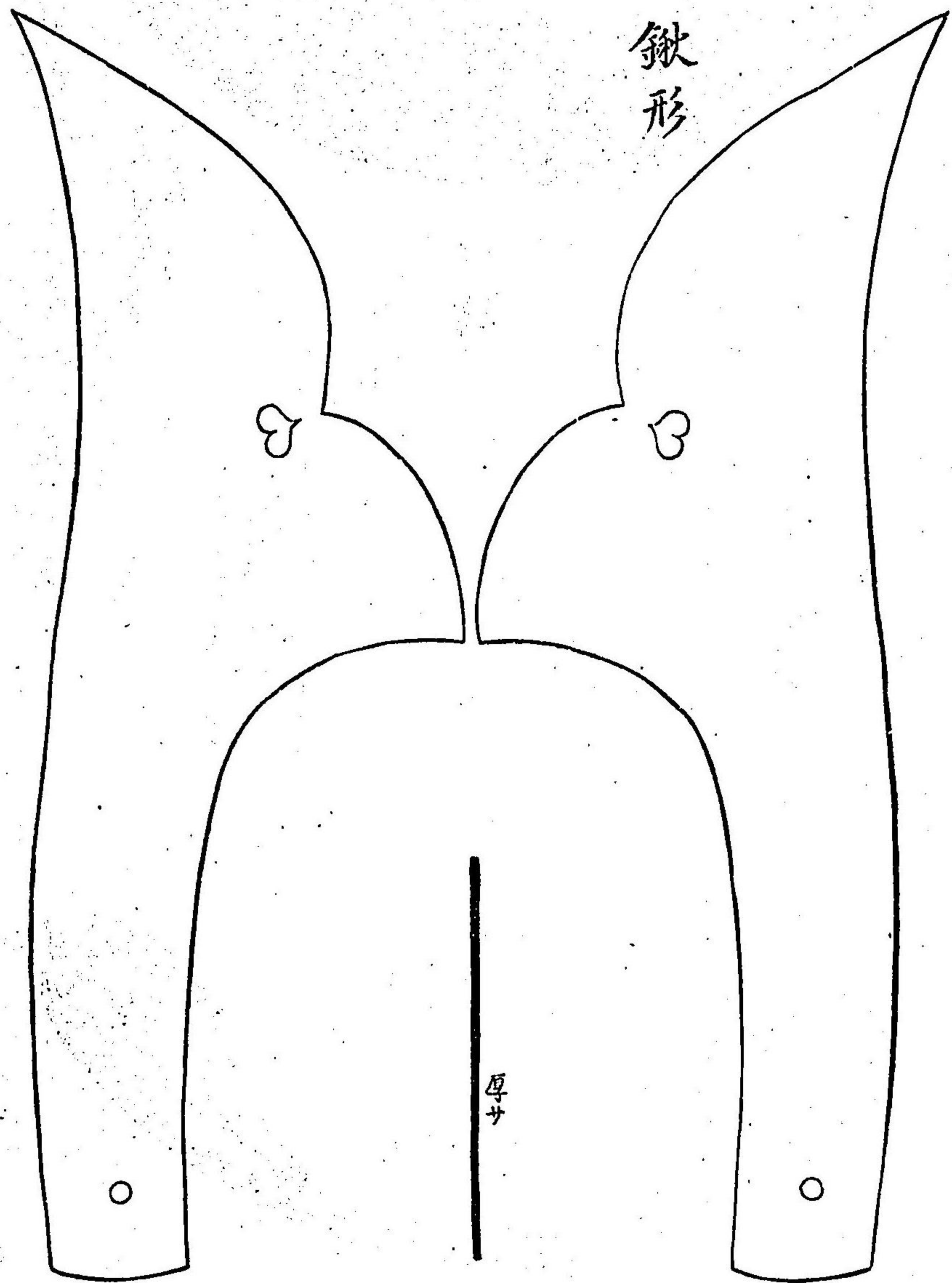

一段 百廿枚
 二段 百廿枚
 三段 百廿枚
 四段 百廿枚
 五段 百廿枚
 六段 百廿枚
 七段 百廿枚
 八段 百廿枚
 九段 百廿枚
 十段 百廿枚

鞬全圖

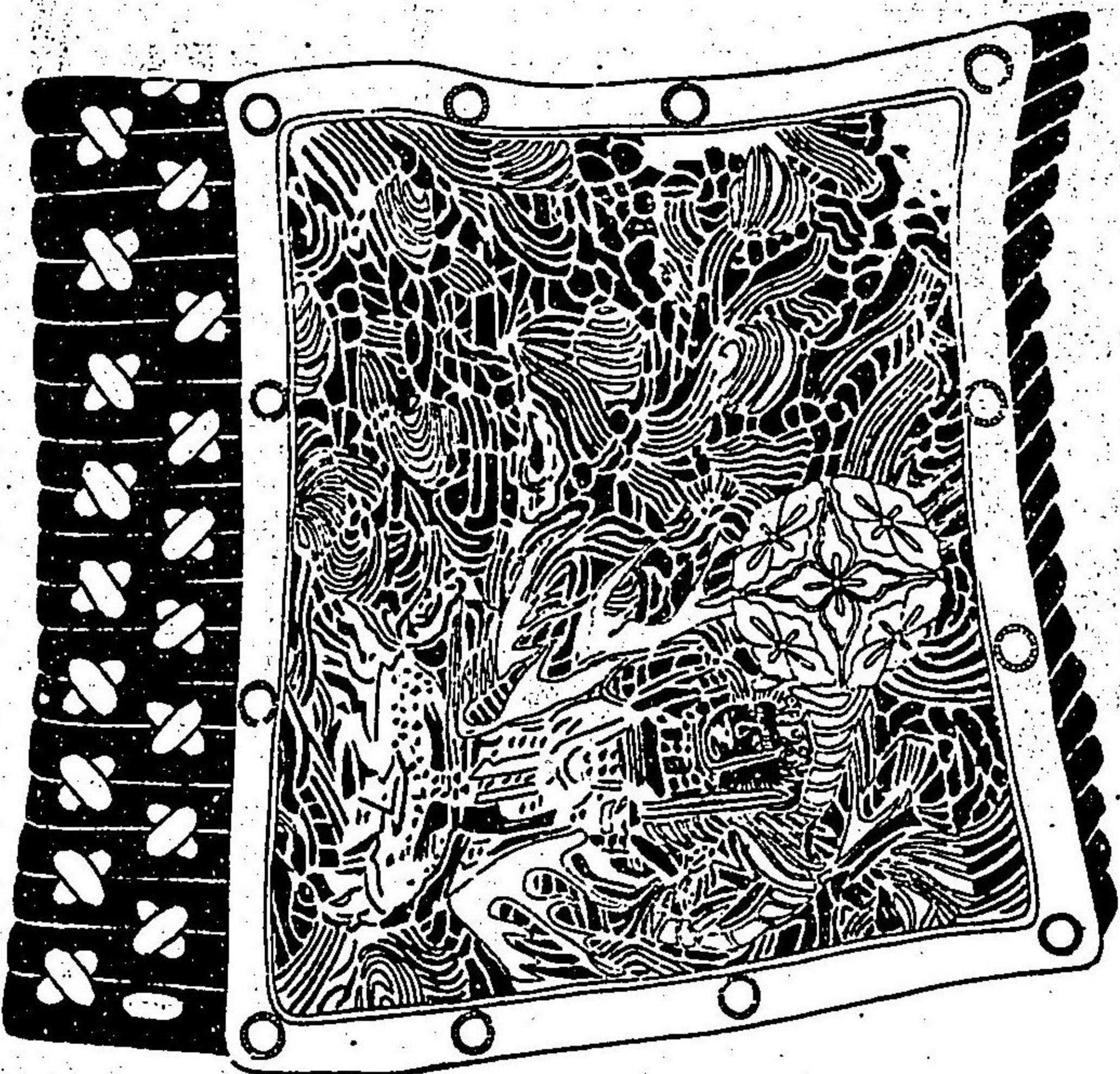
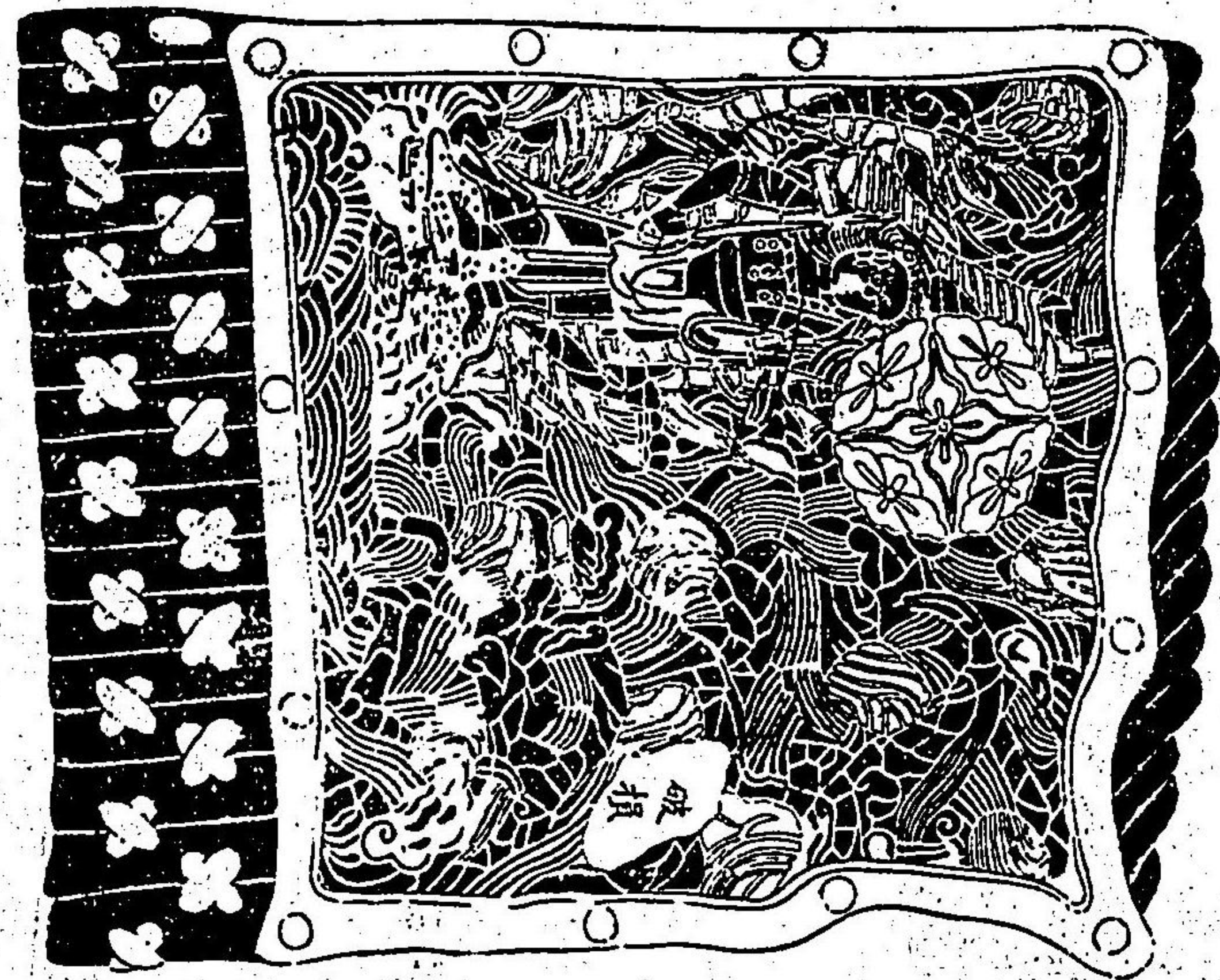

吹返

享文黑所
藍及鈎所
同裝

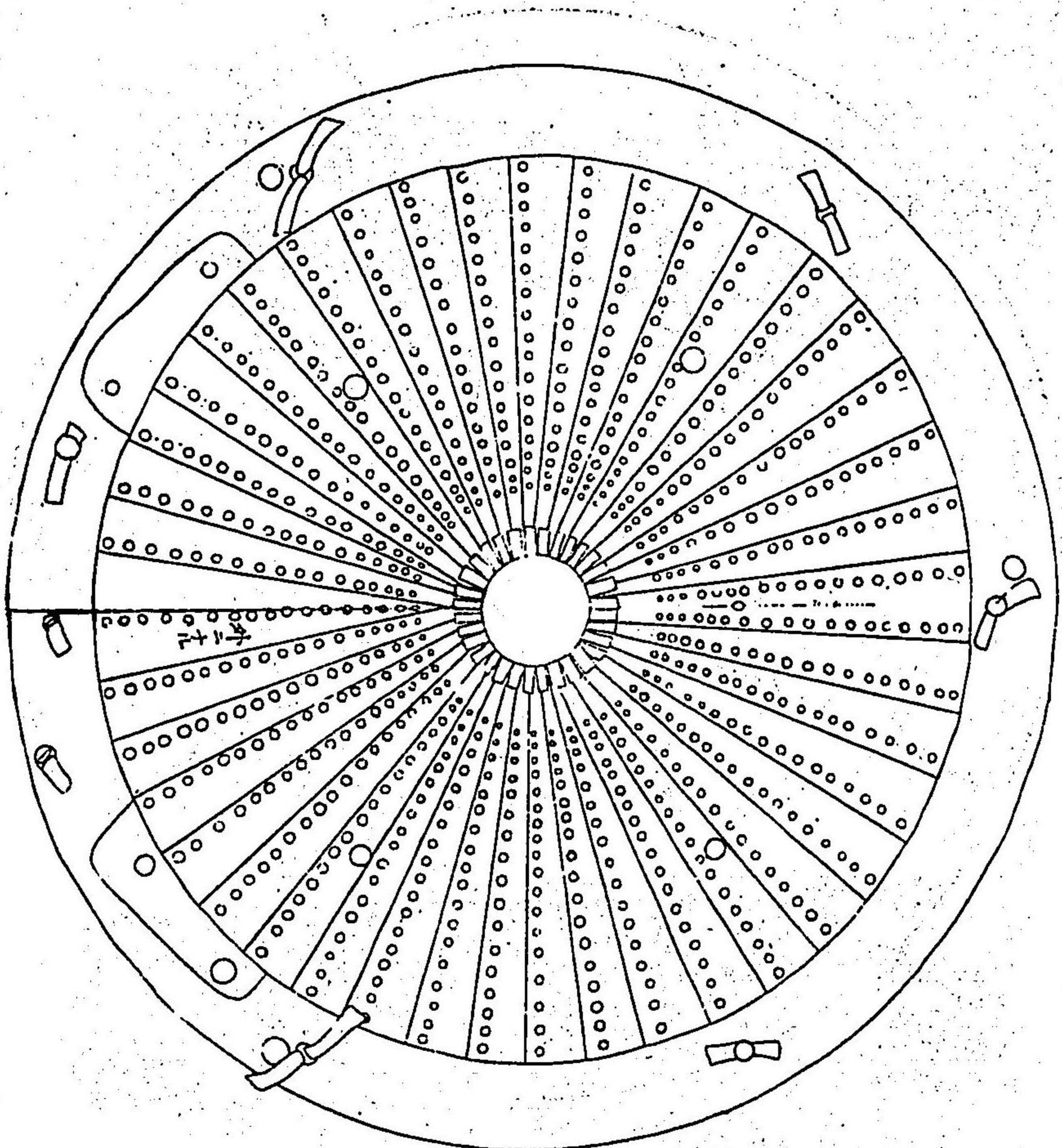

餅敷

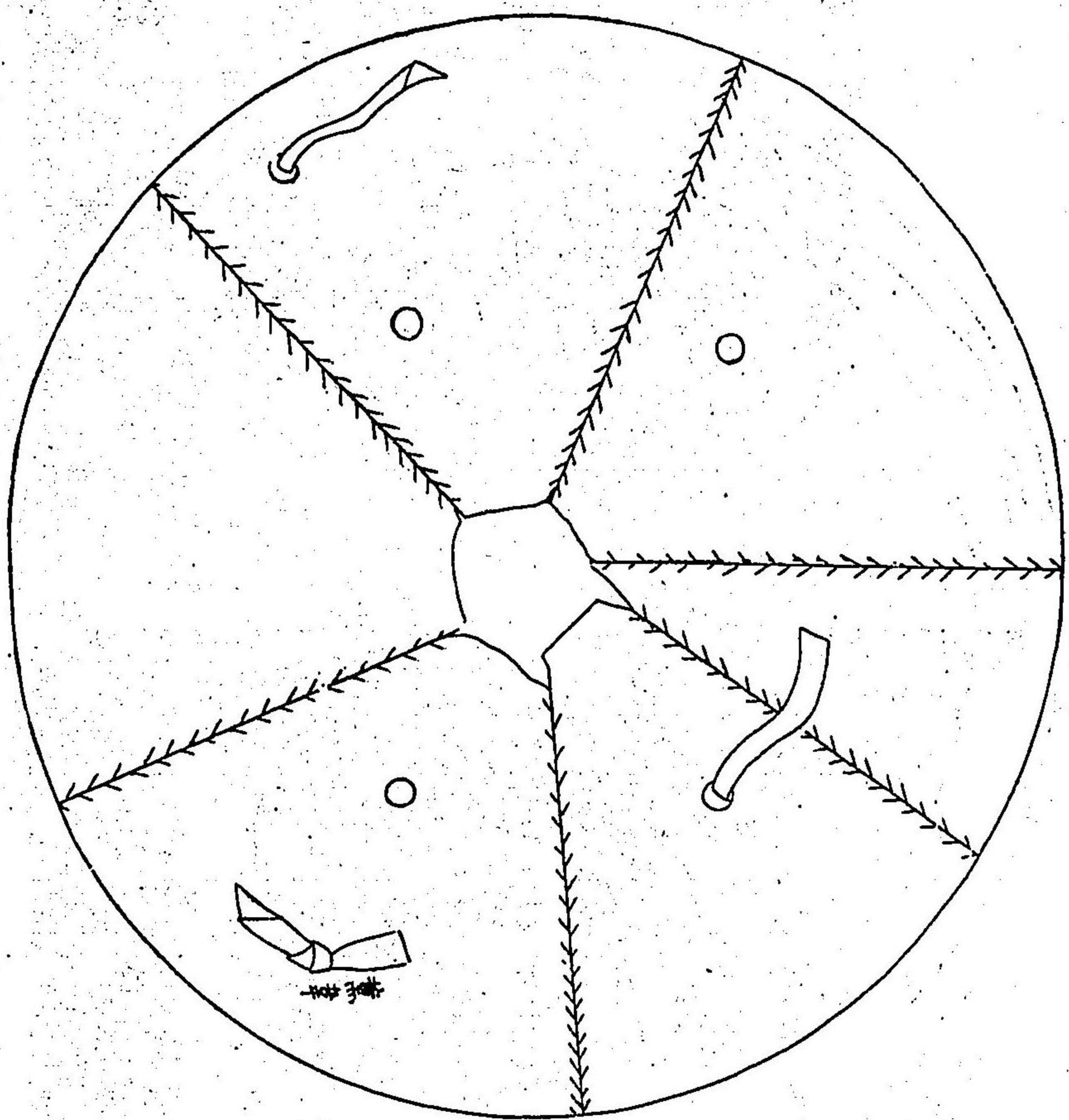

由數張滑革栗色麻糸縫合

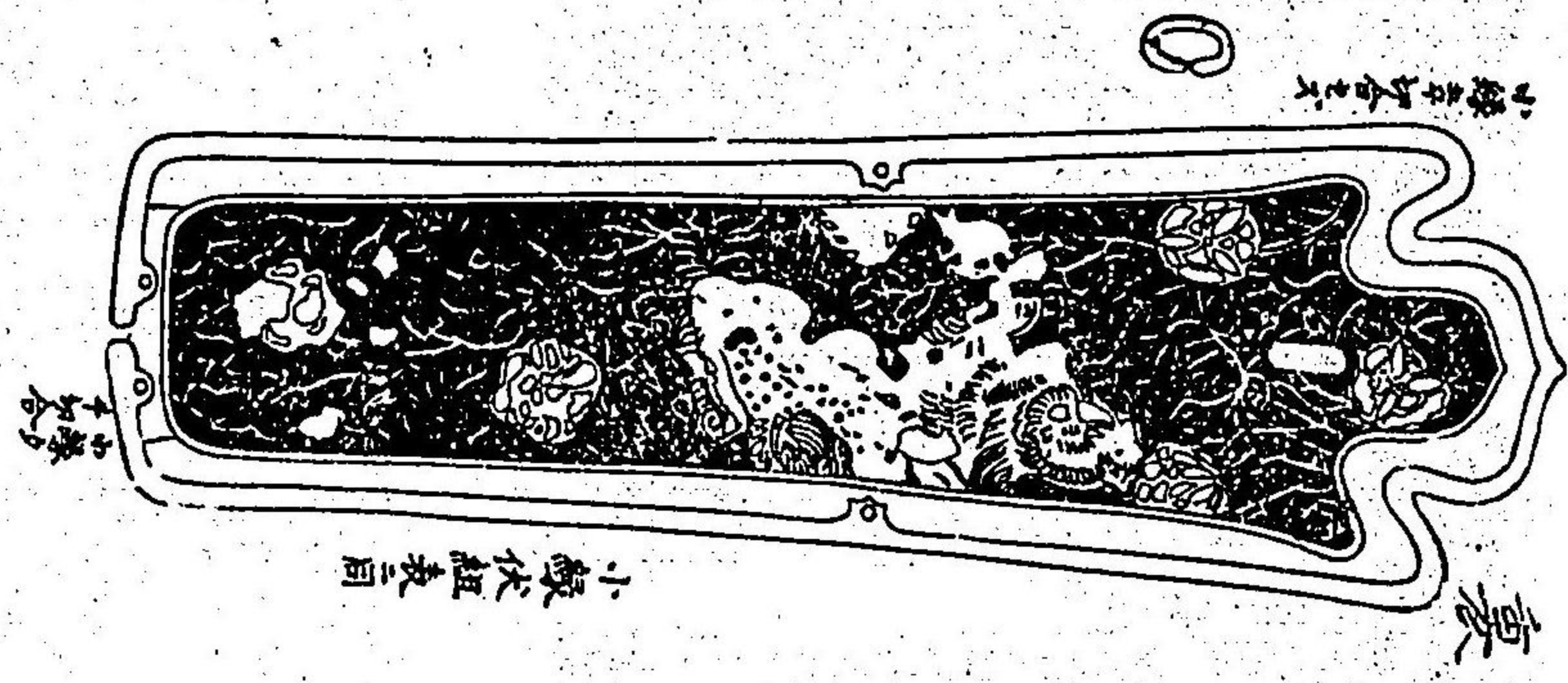

小鐵伏紐表同

鳩尾板

掛板無之

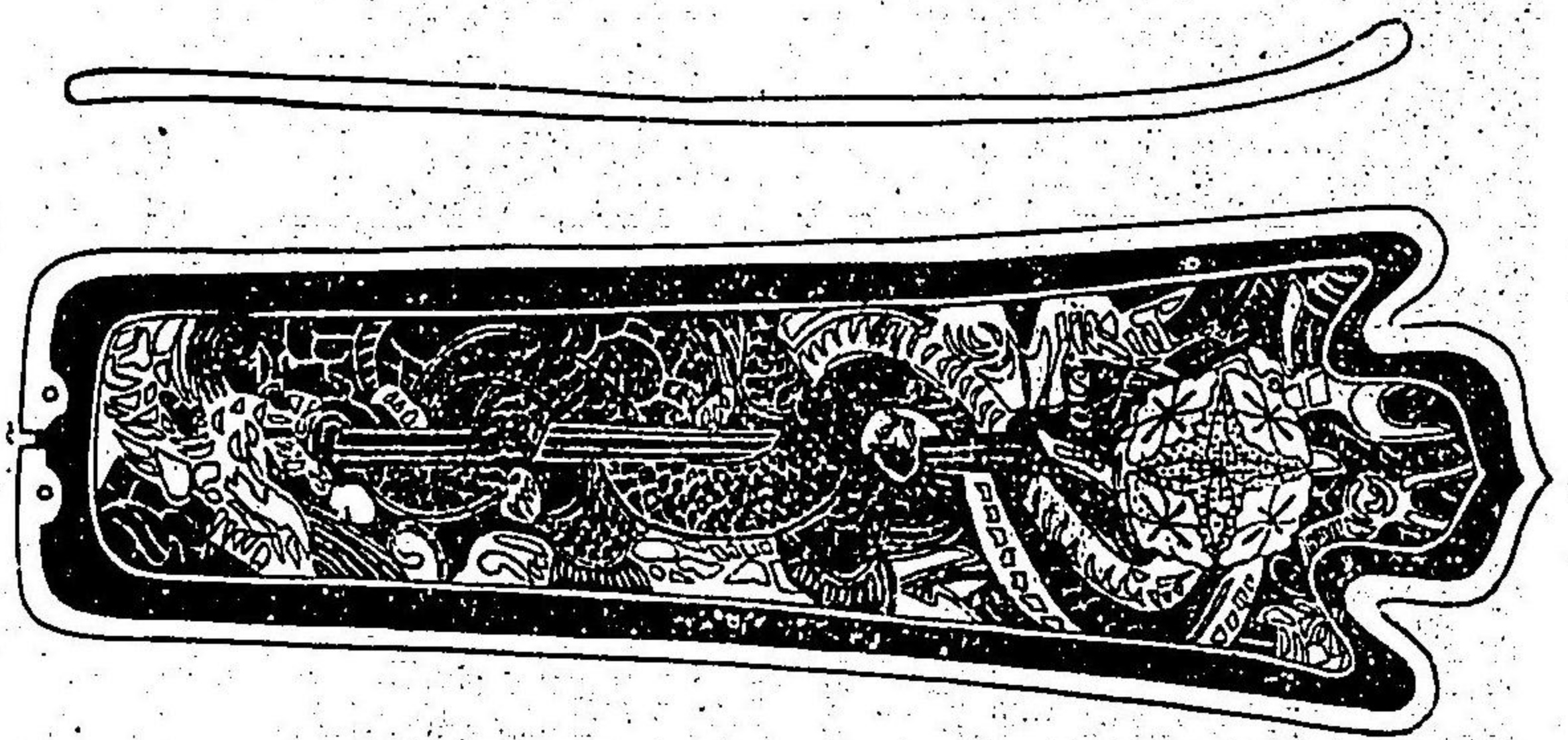

小鐵片各六

小鐵片

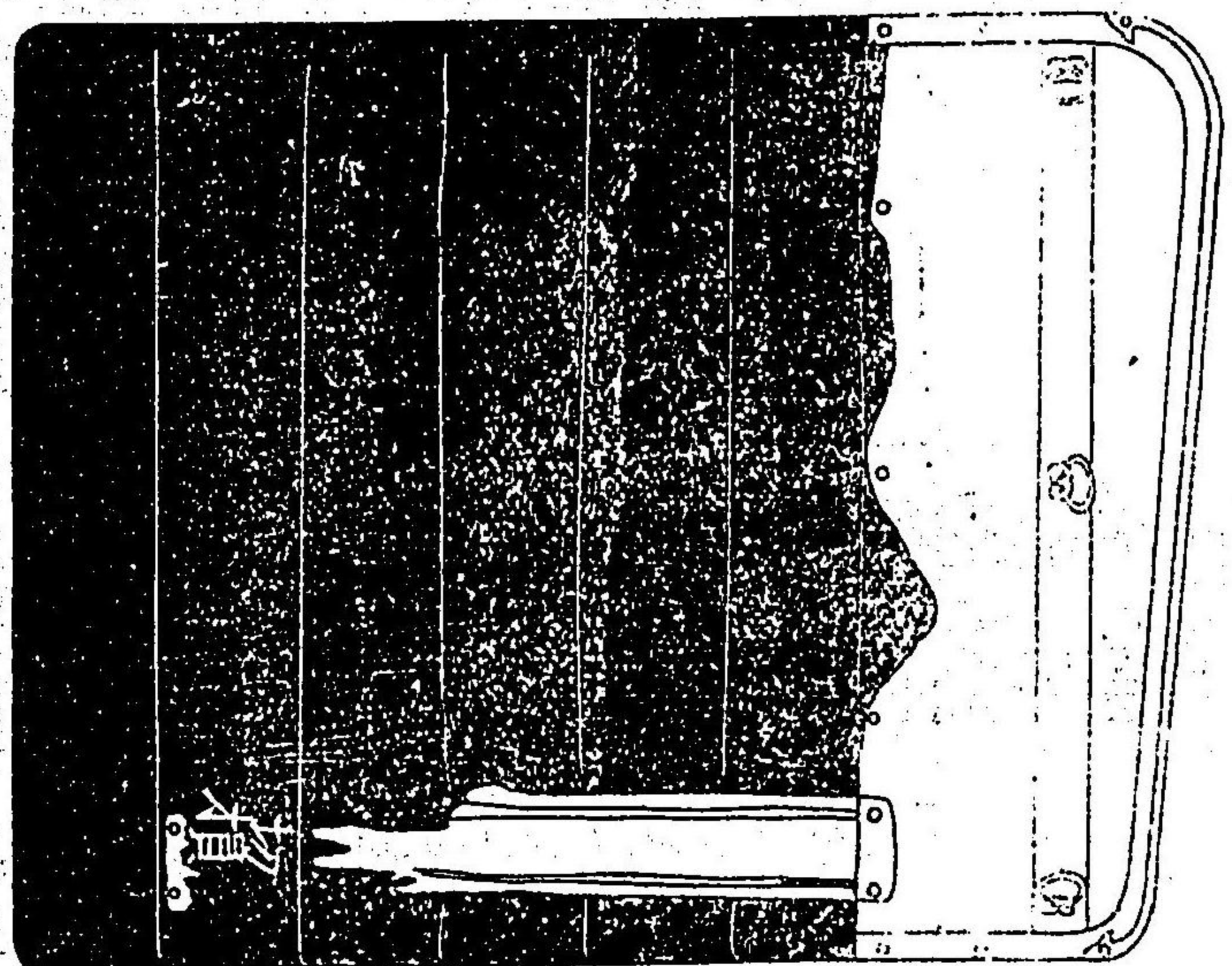

同敷

鐵片摺五二六無之

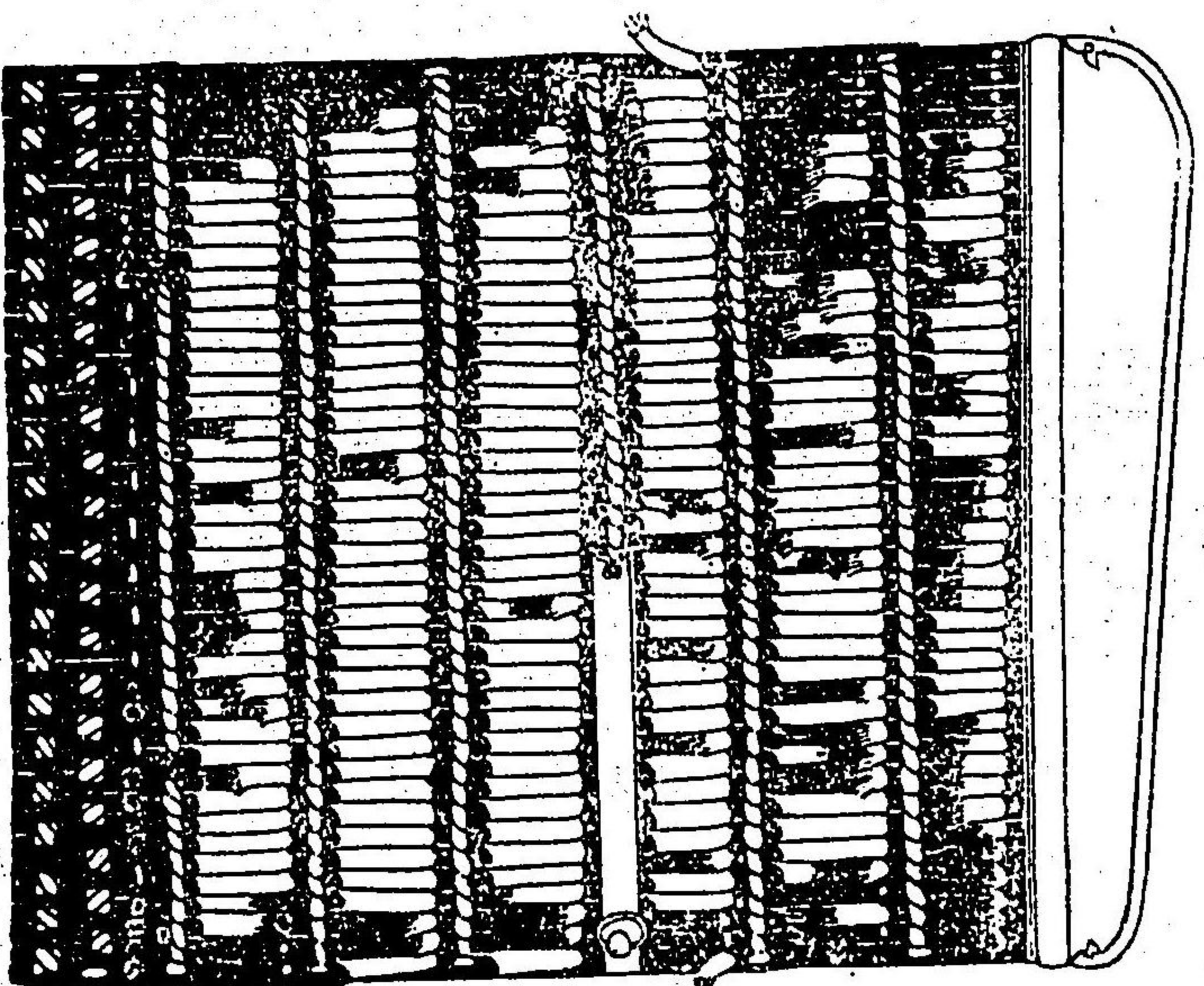

袖全圖

上段小鐵交 以下骨斗

品奉甚地良



袖冠板

白練貫竹笠

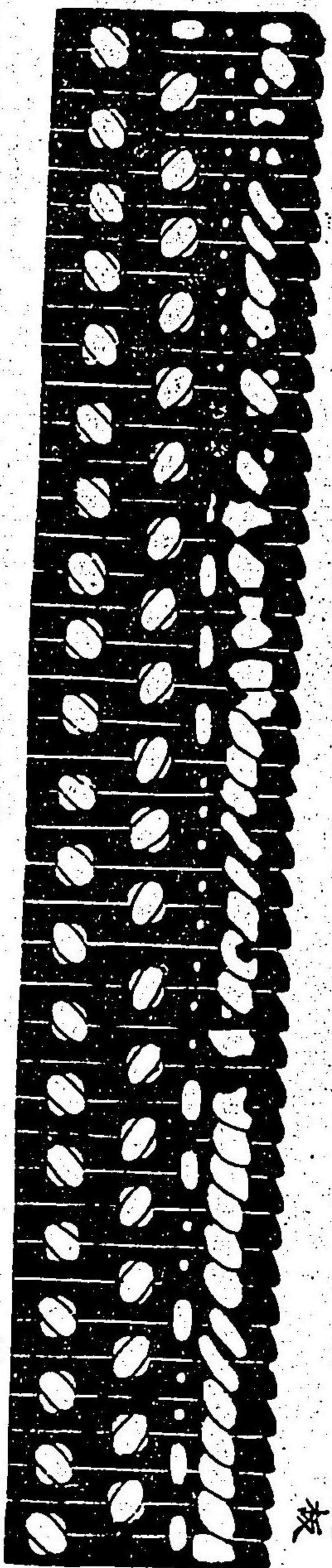

同菱板

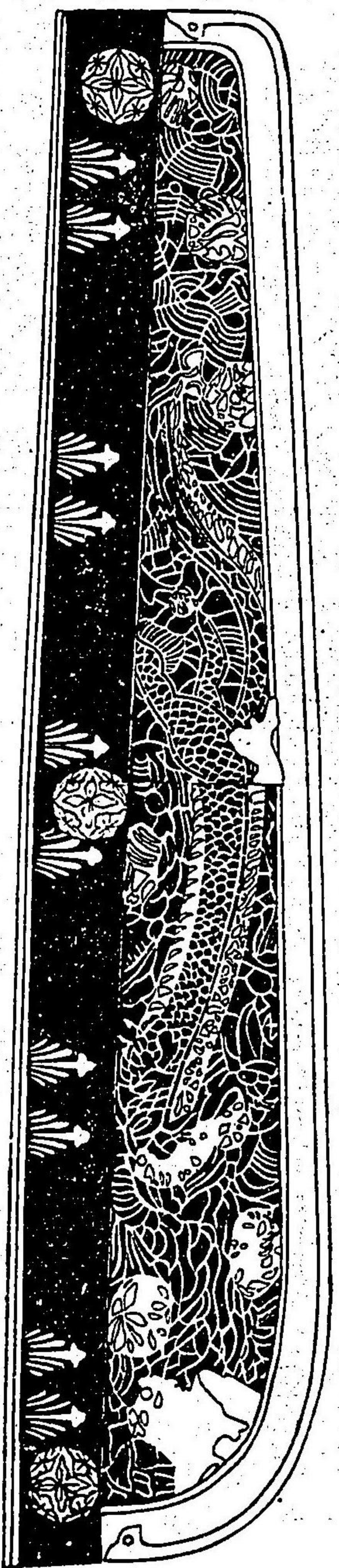

四

莽金物
上置

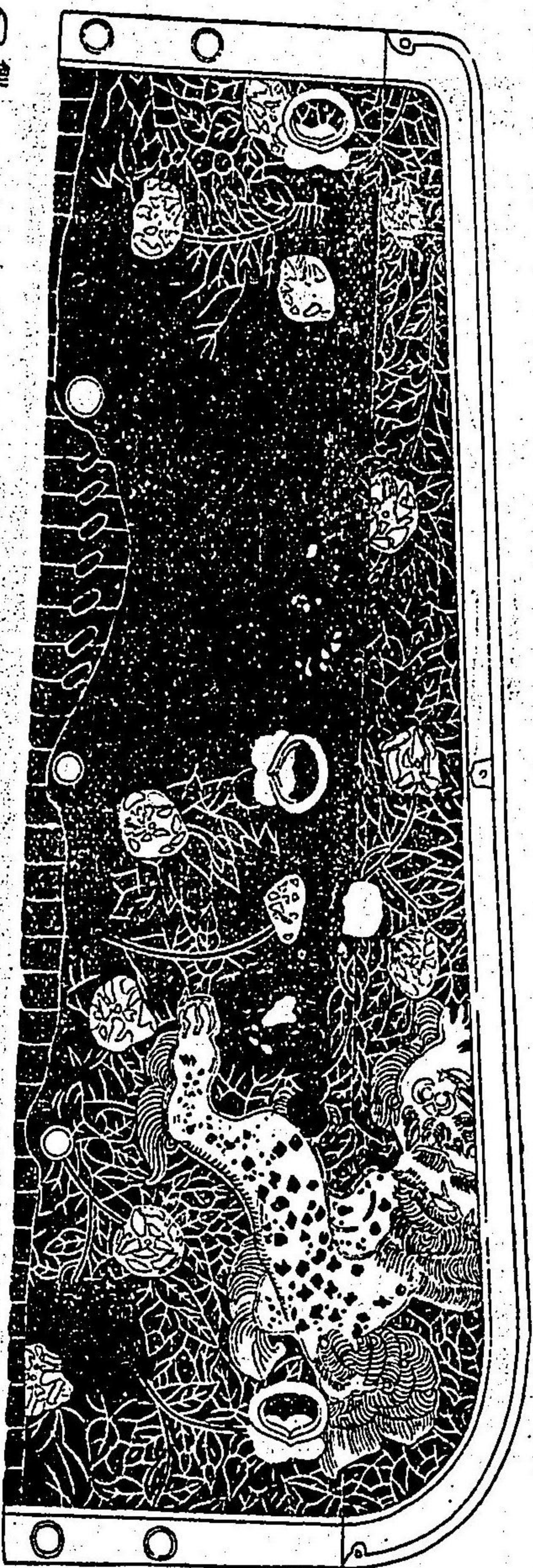
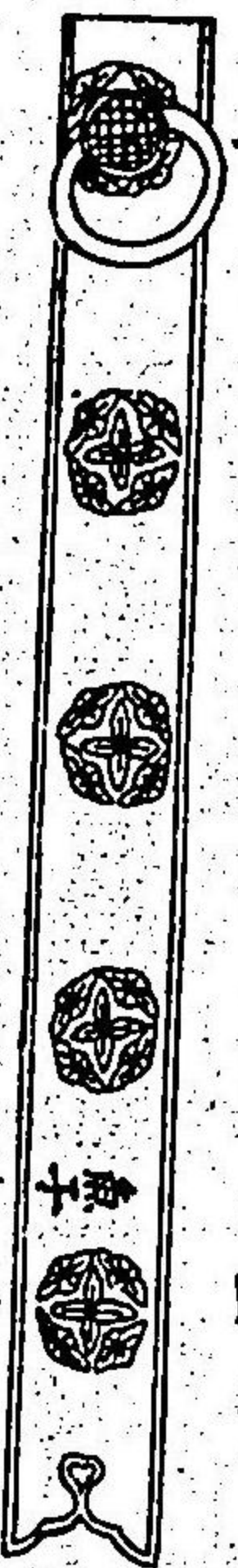

同表

一別

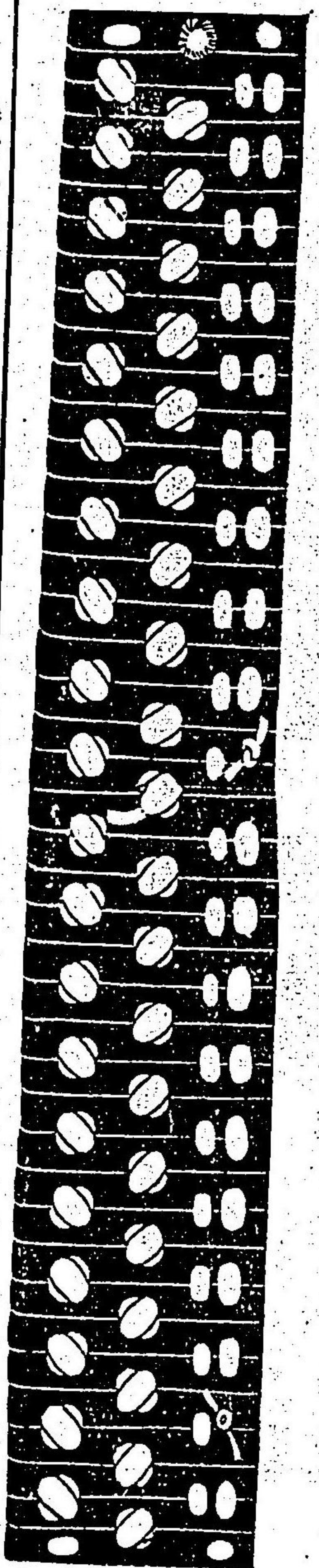

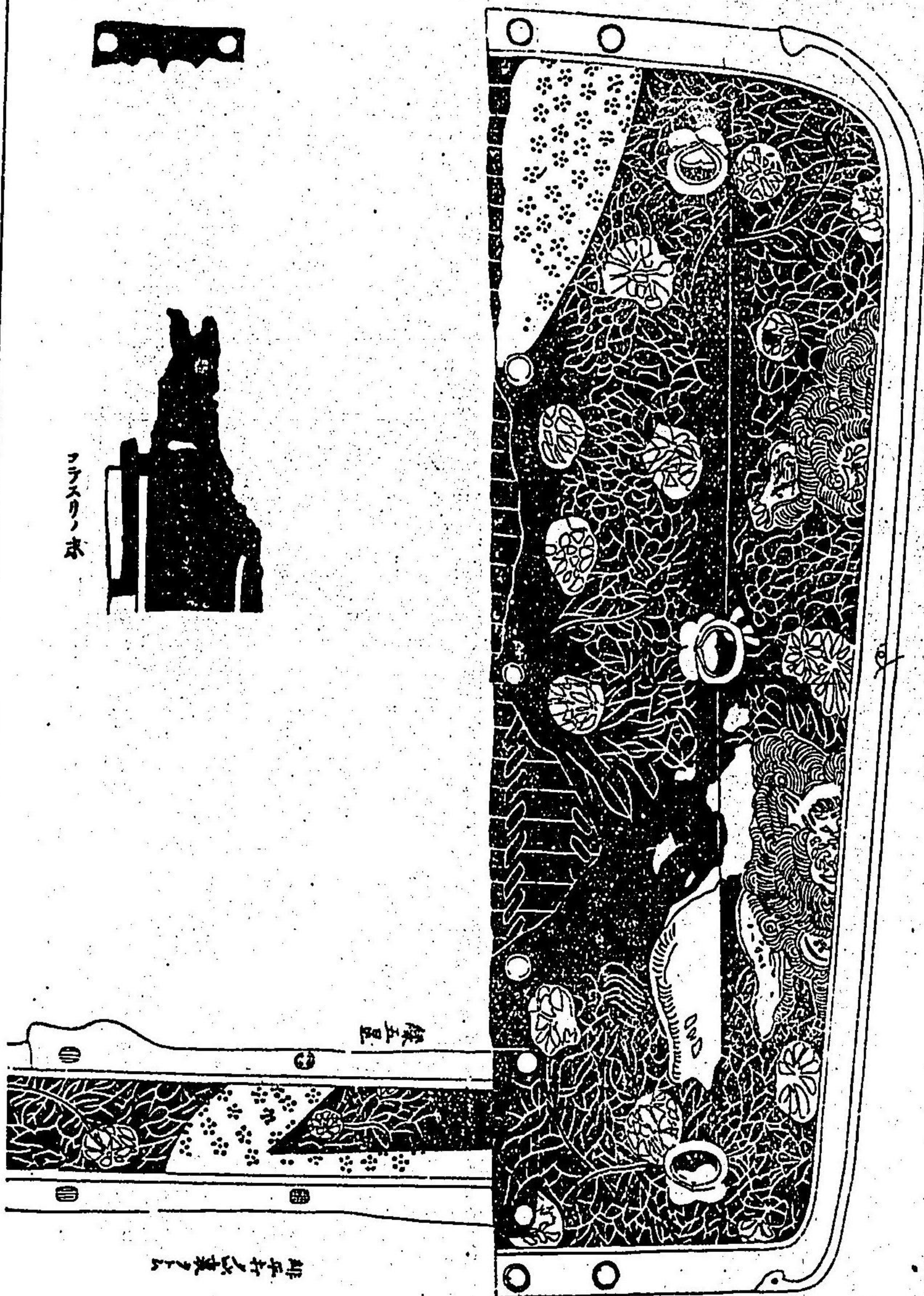

同

袖緒 左右三筋宛

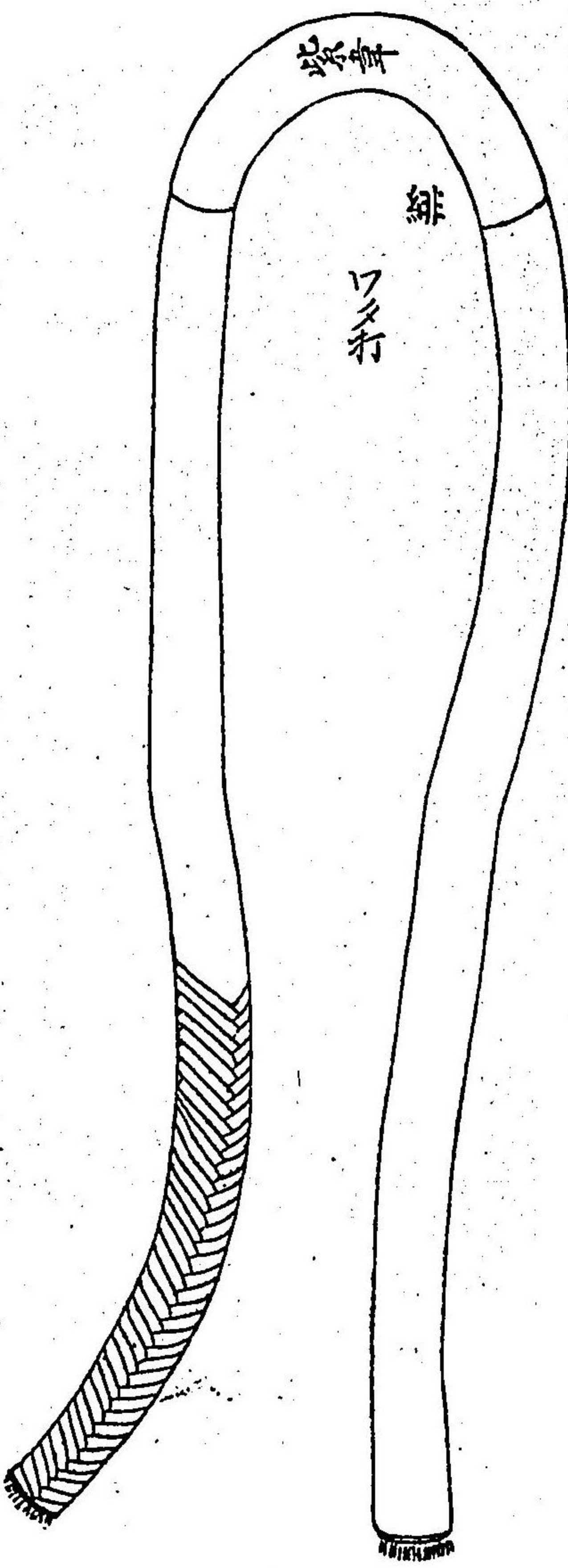

籠手摺ノ裏

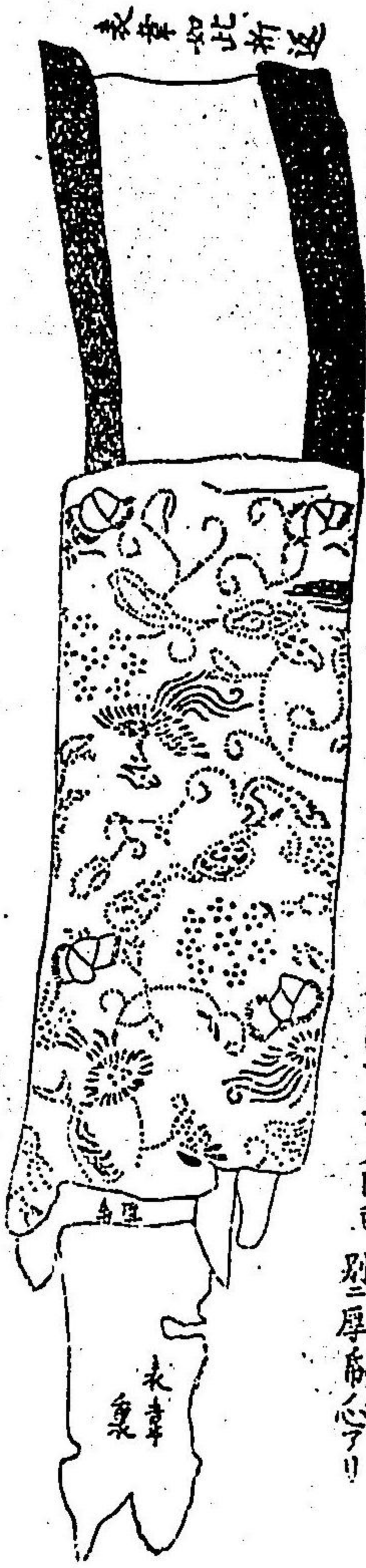

地白茶純子ノ如久同也 別ニ厚筋ハアリ

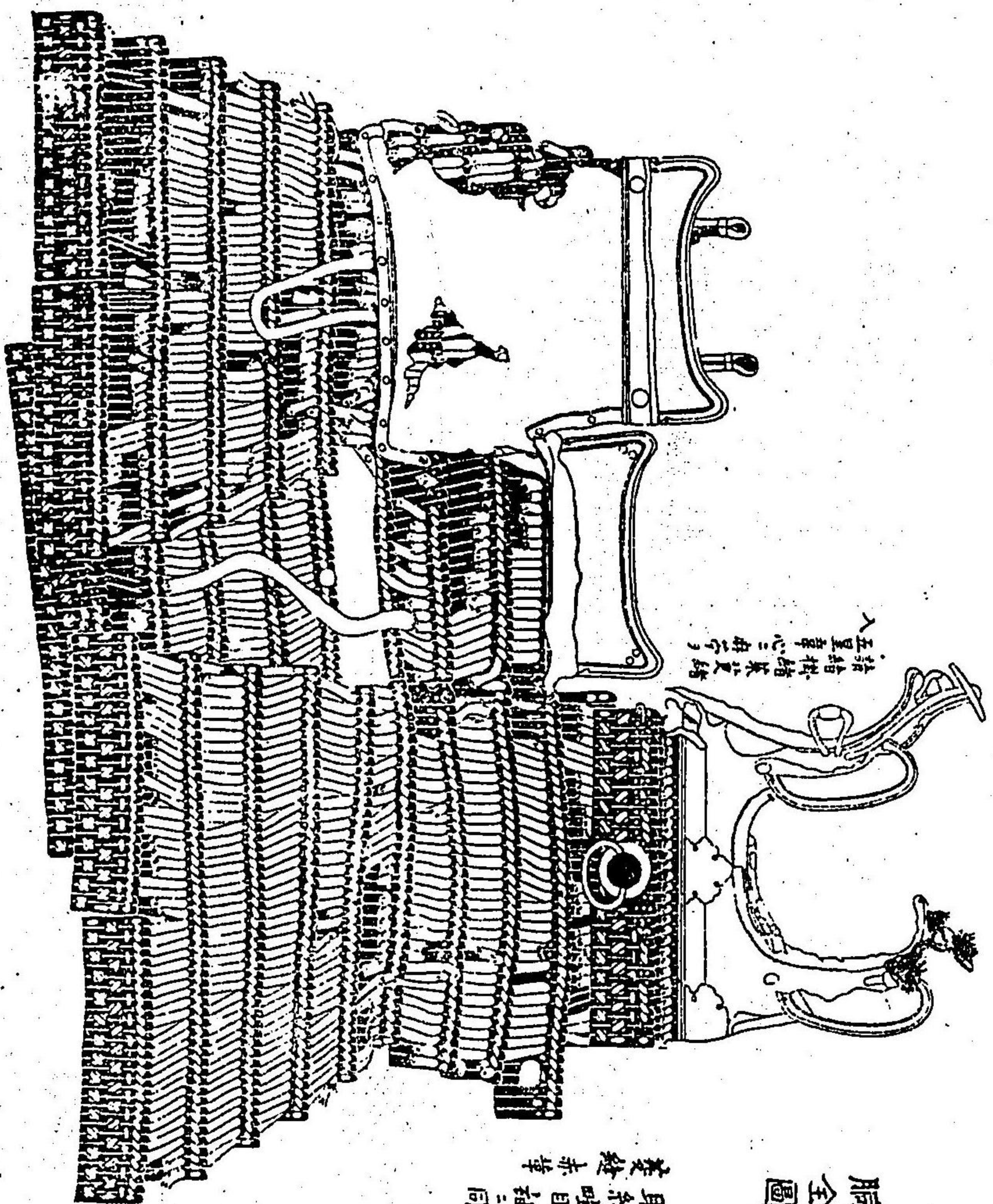

胸全圖

小孔長二寸二分幅七分半鑲華板
 裏栗色華二隊宛已
 月糸哇目抽二同
 葉縫赤華

諸結帶結束以夏絲
 五里華心二母字
 入

胸板

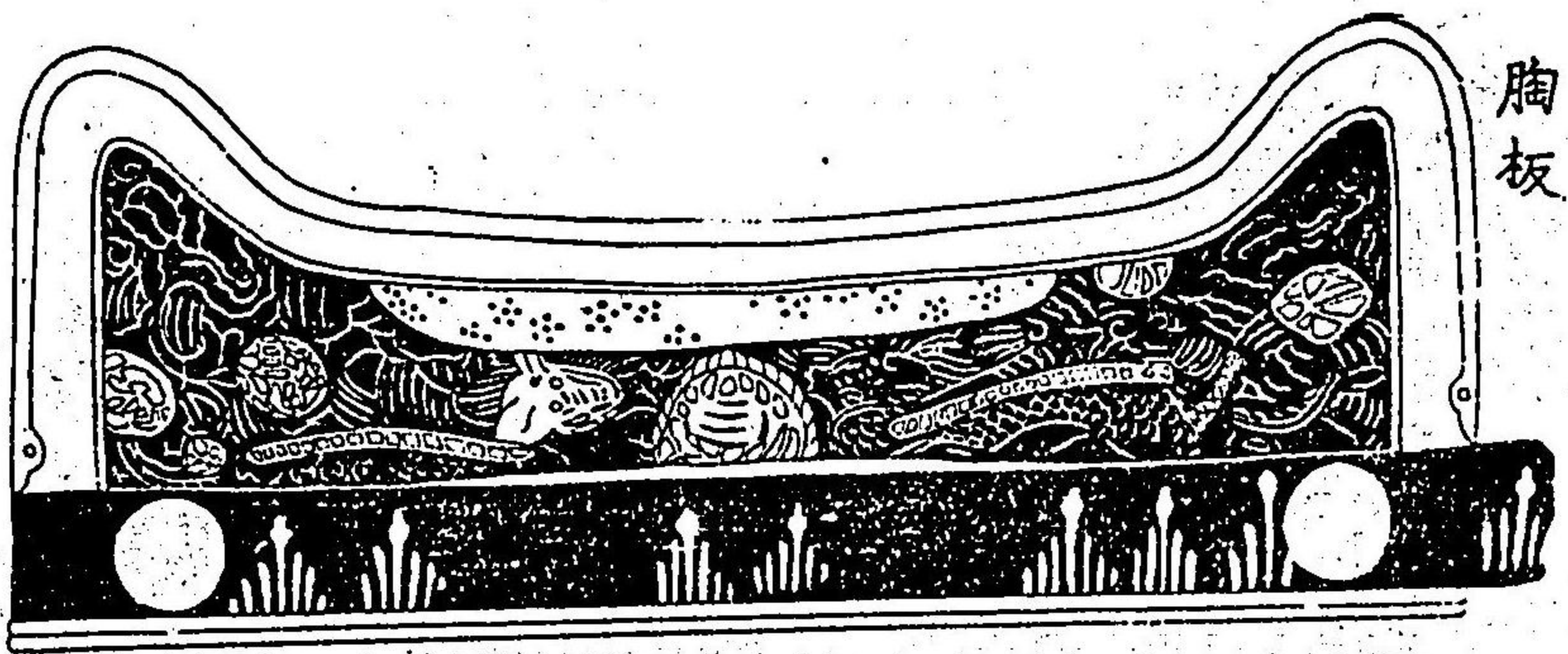

裏

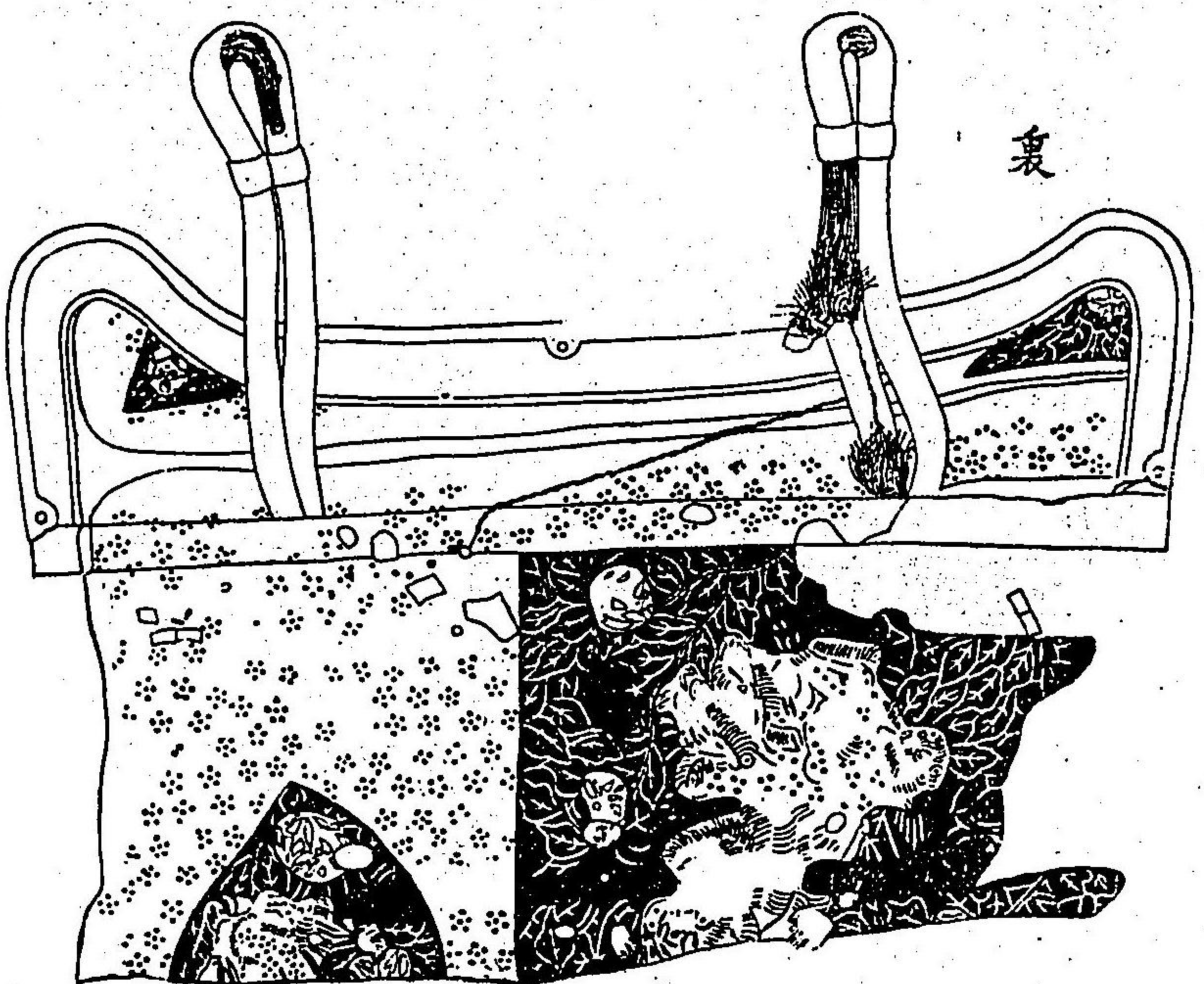



破損之革 虎之破損

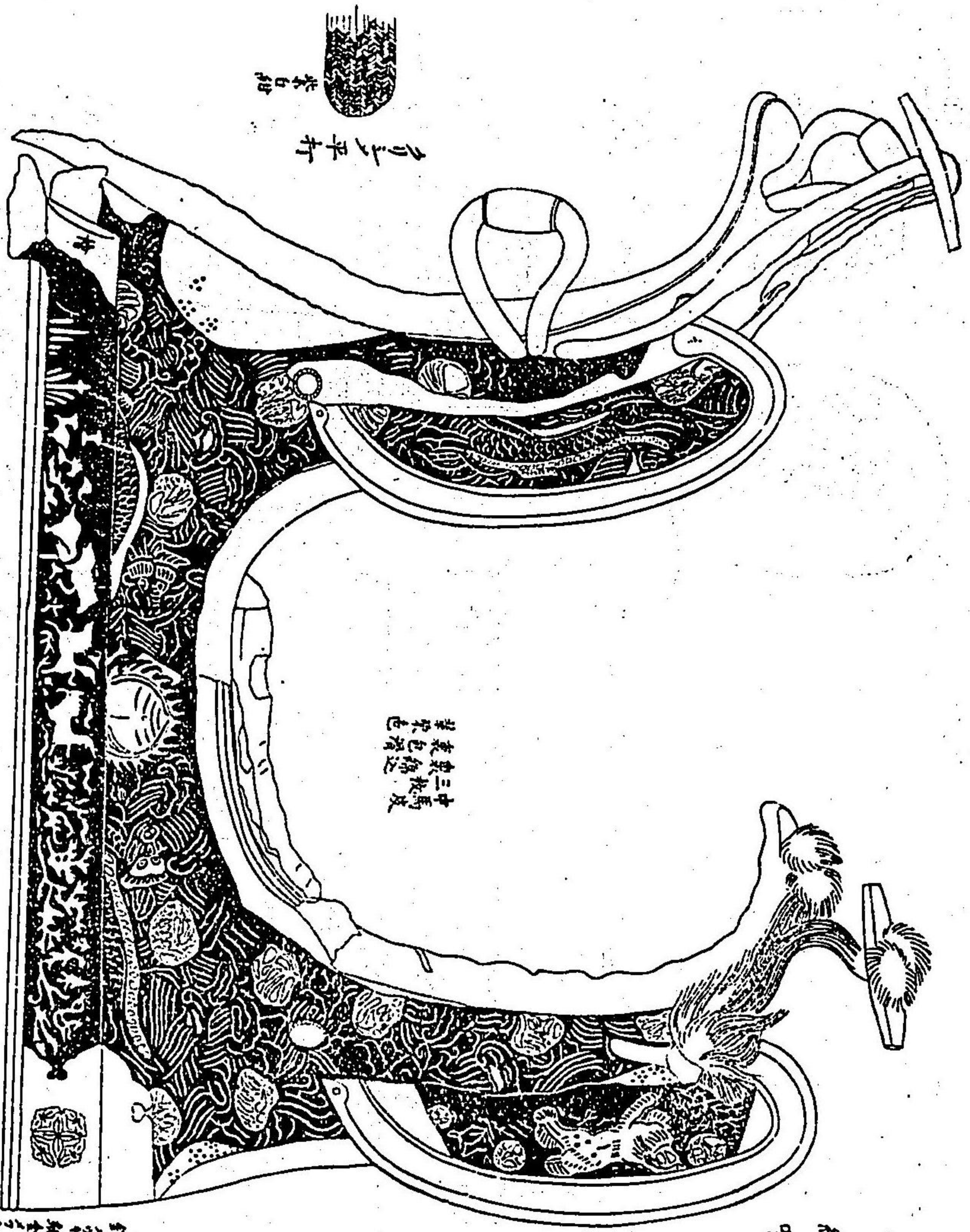

綿嗑

中馬
三批馬
裝束色澤

平打
茶品

中馬
裝束色澤

總角

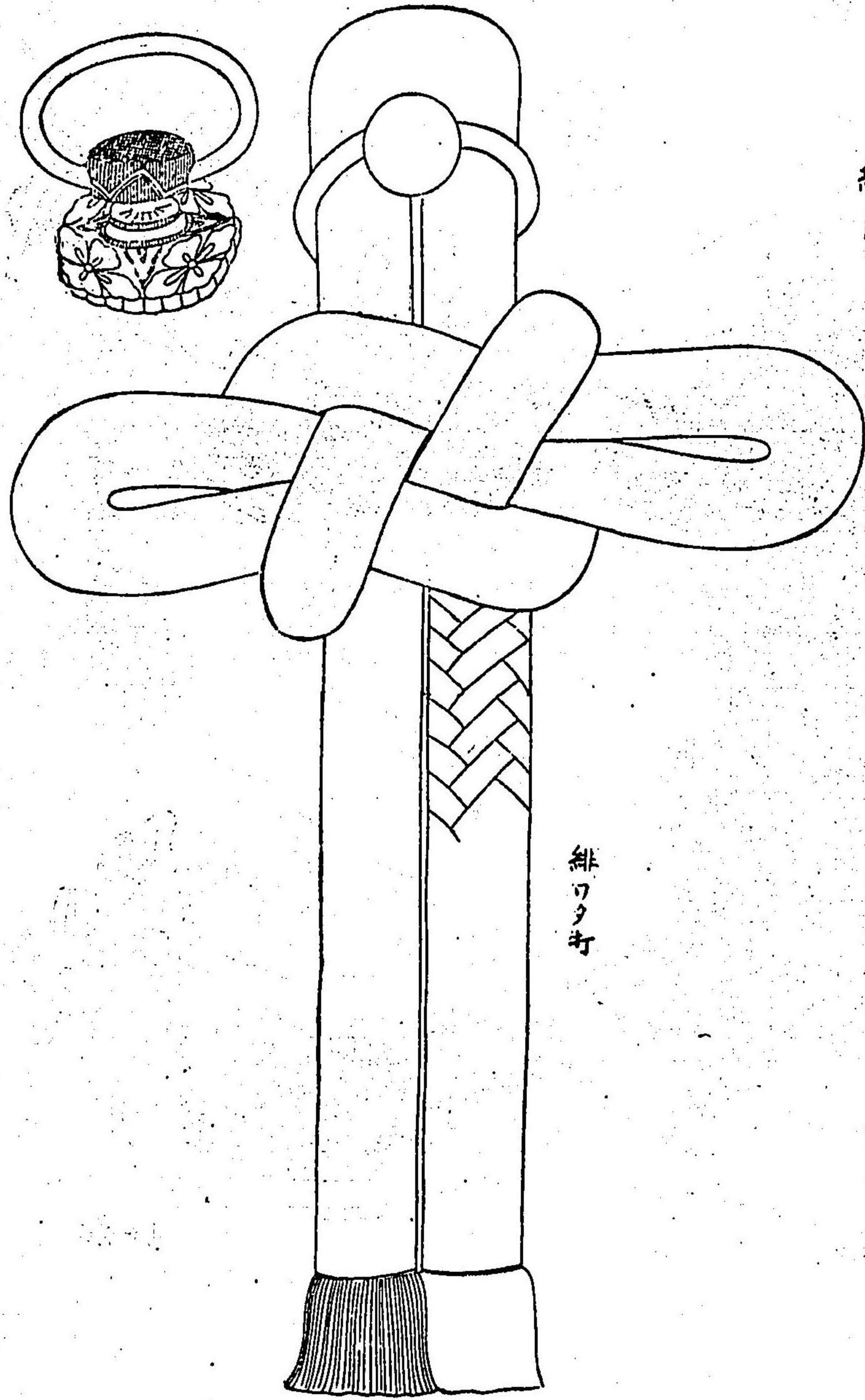

緋ワタ打

舟向表

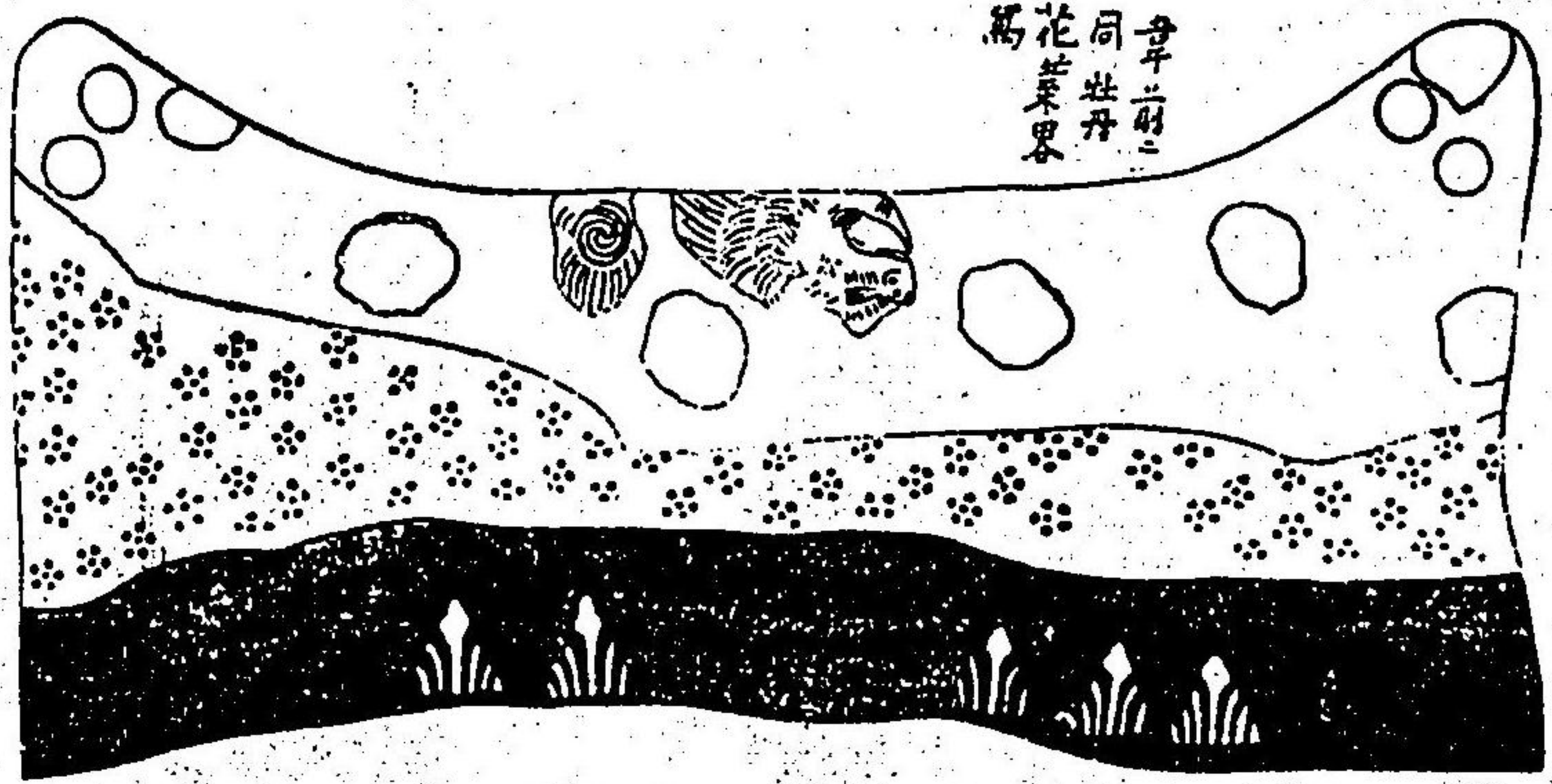

舟向表
同姓丹
馬花葉界

品草

同裏

幸同

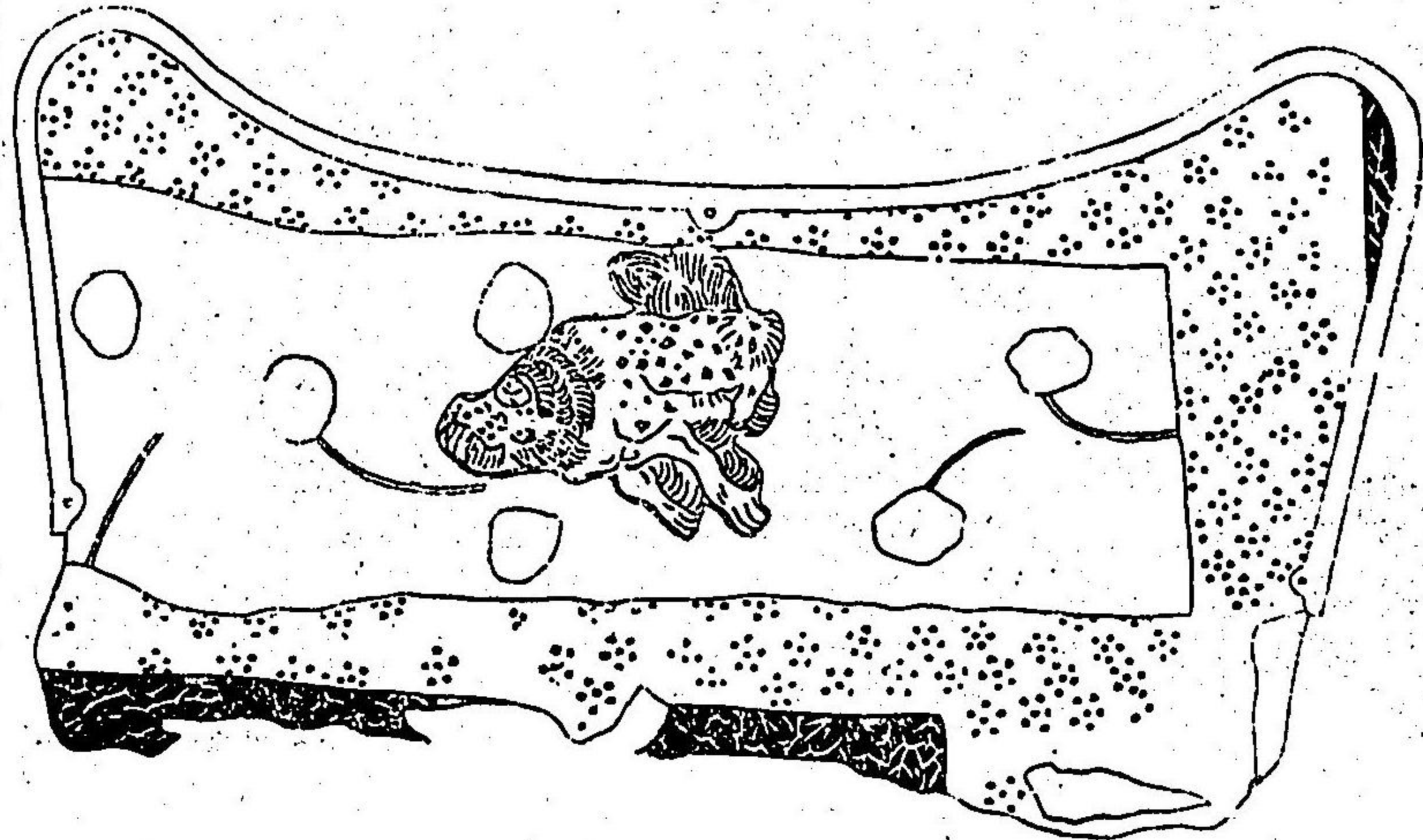

玉綴小縁伏紐界局



射向端

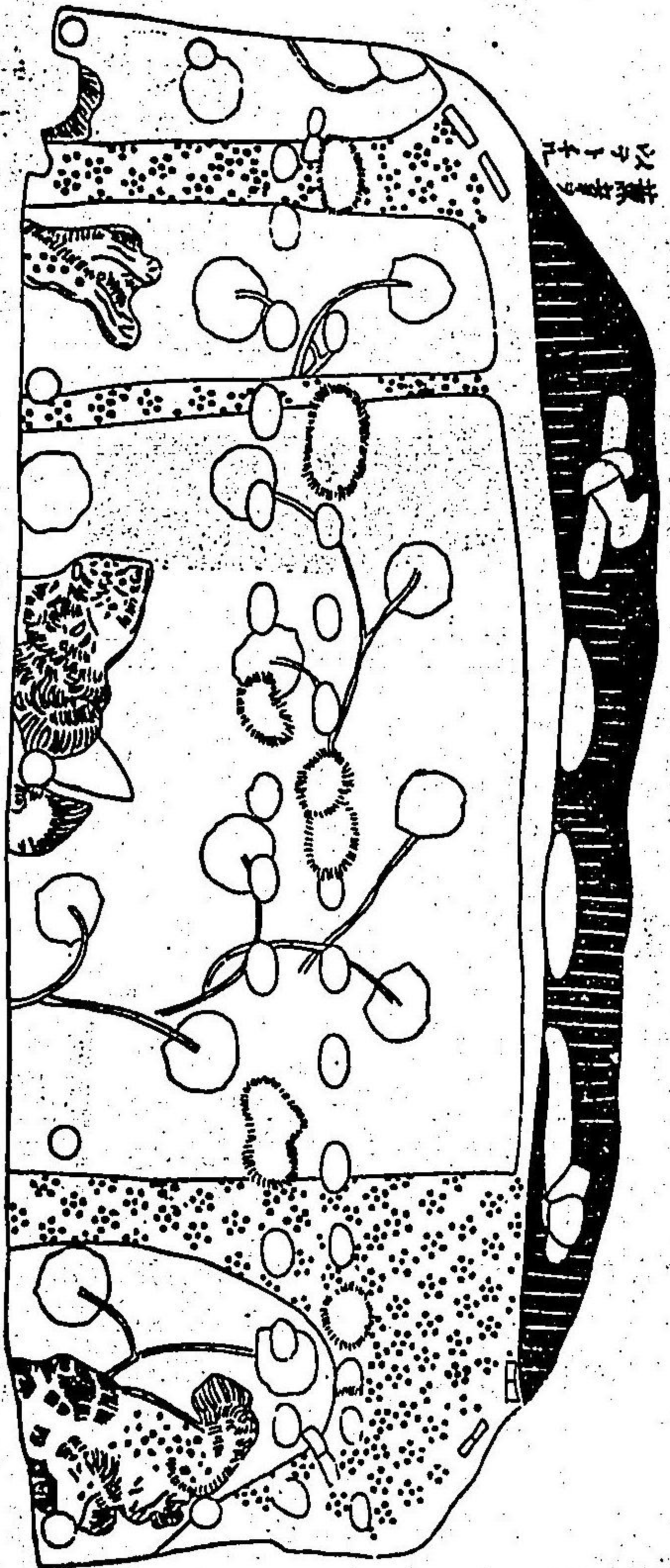

表裏全前圖

同表

脇楯全圖

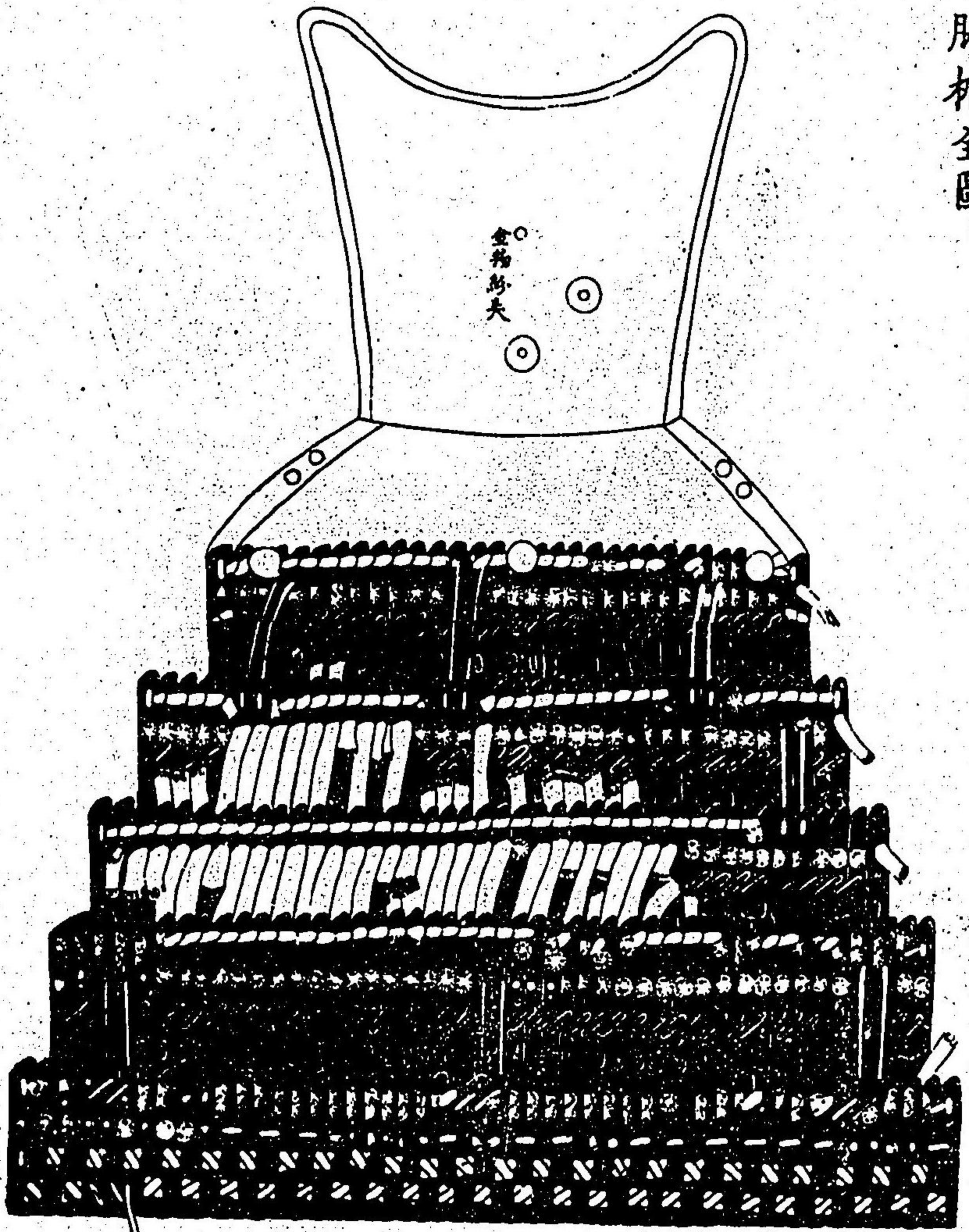

金指形夫

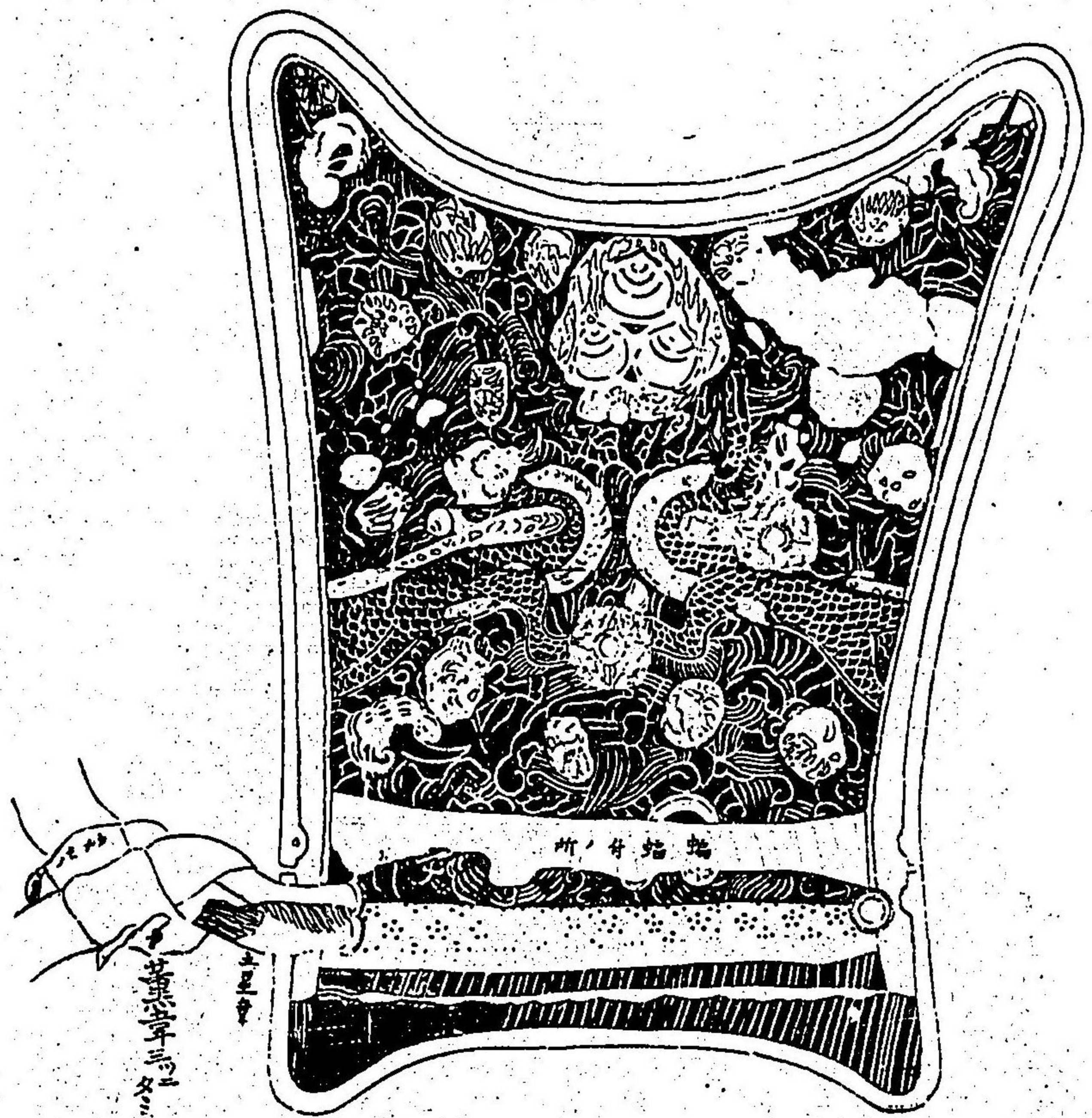

裏

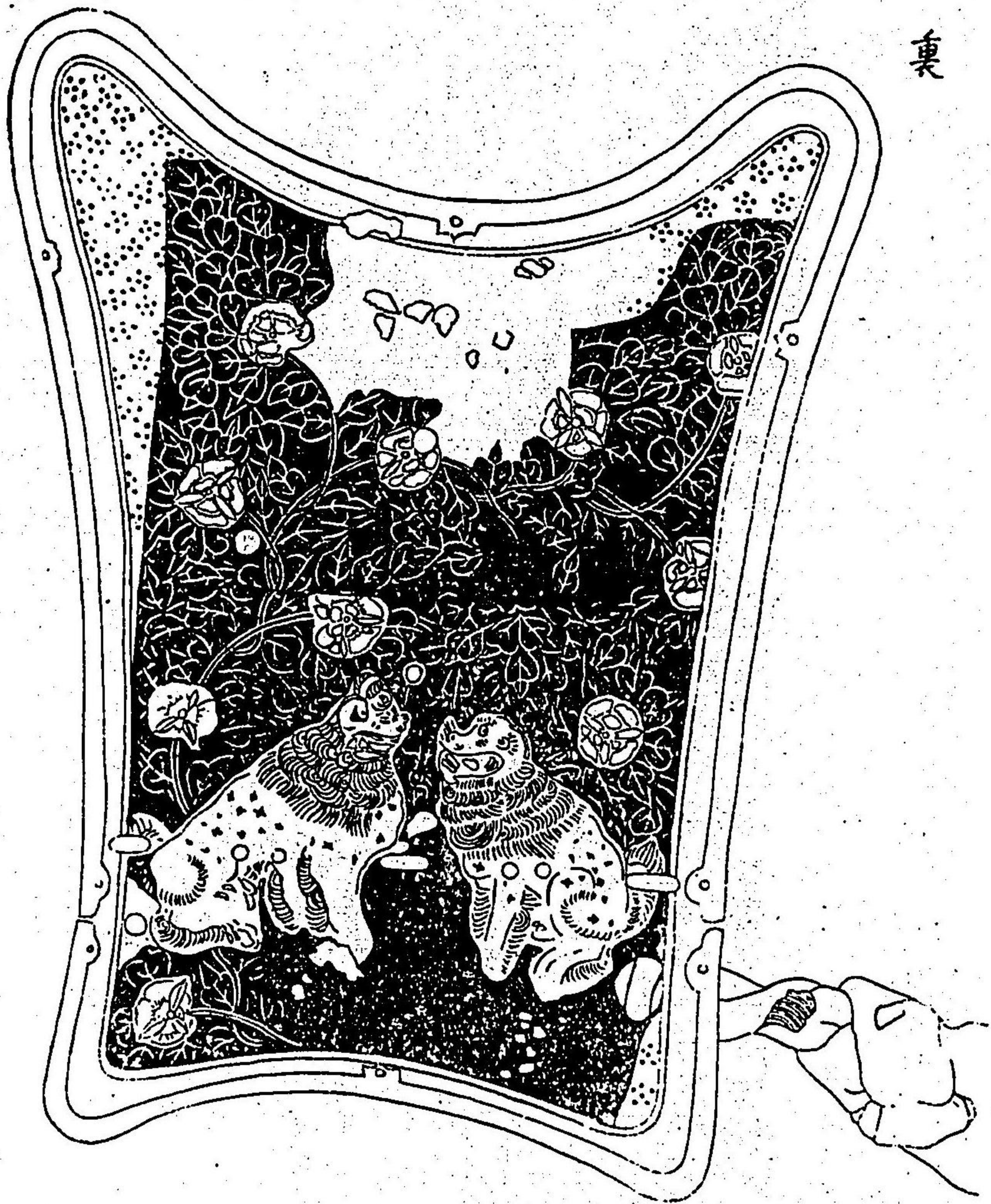

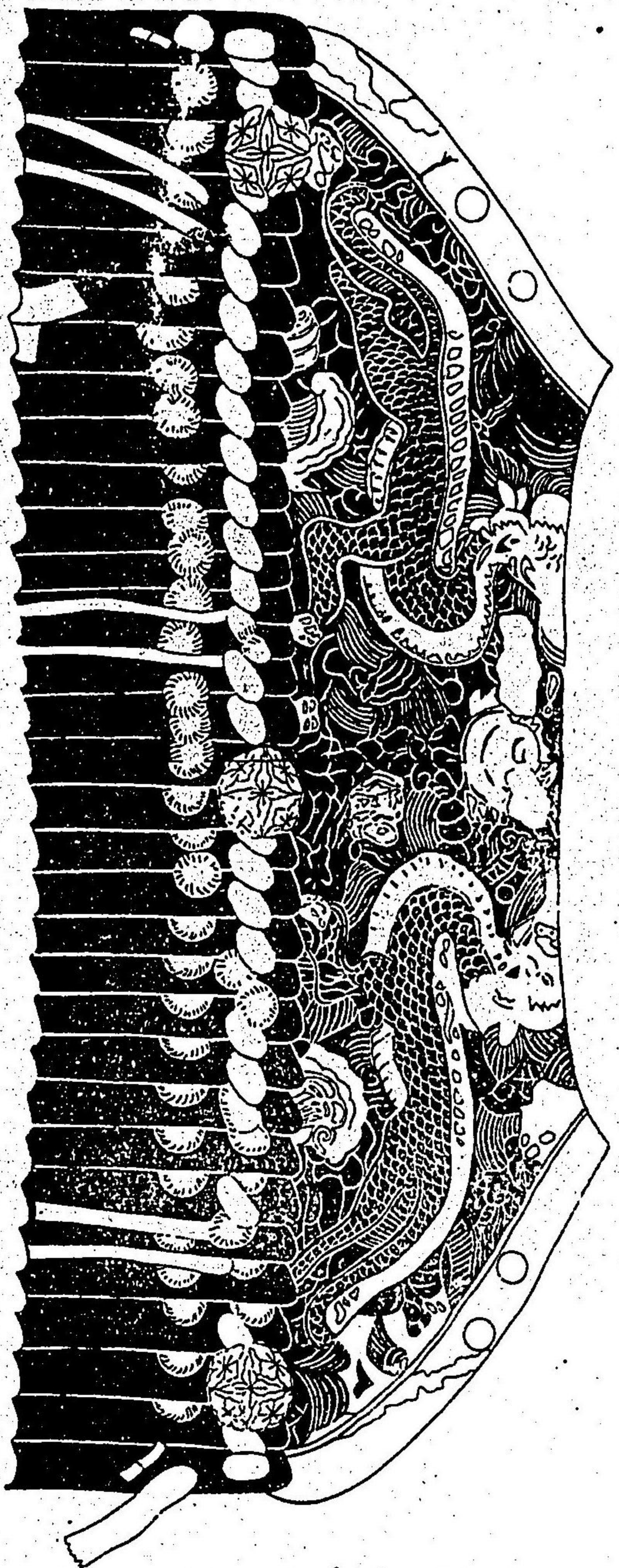

脇指蝙蝠付表

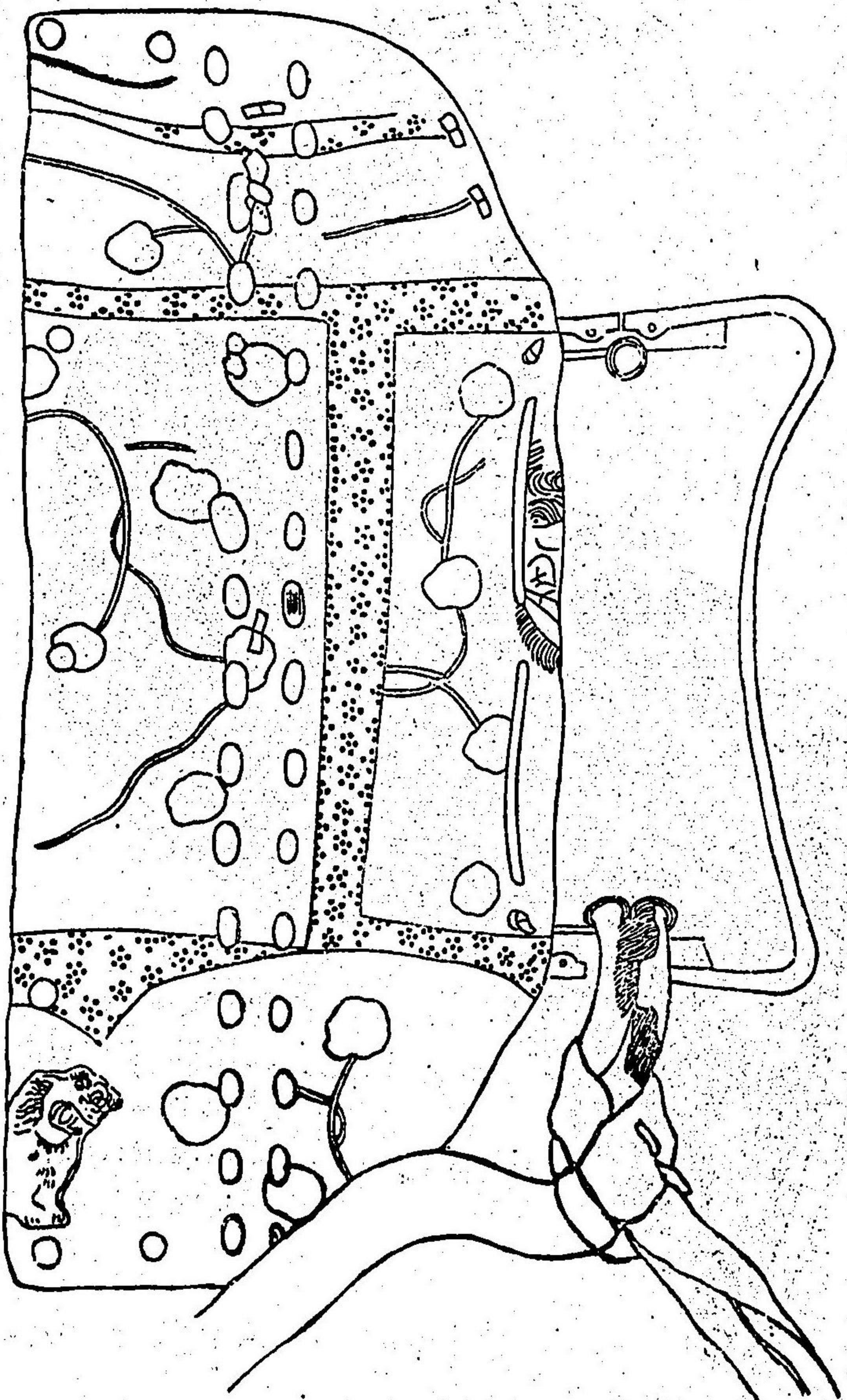

同裏

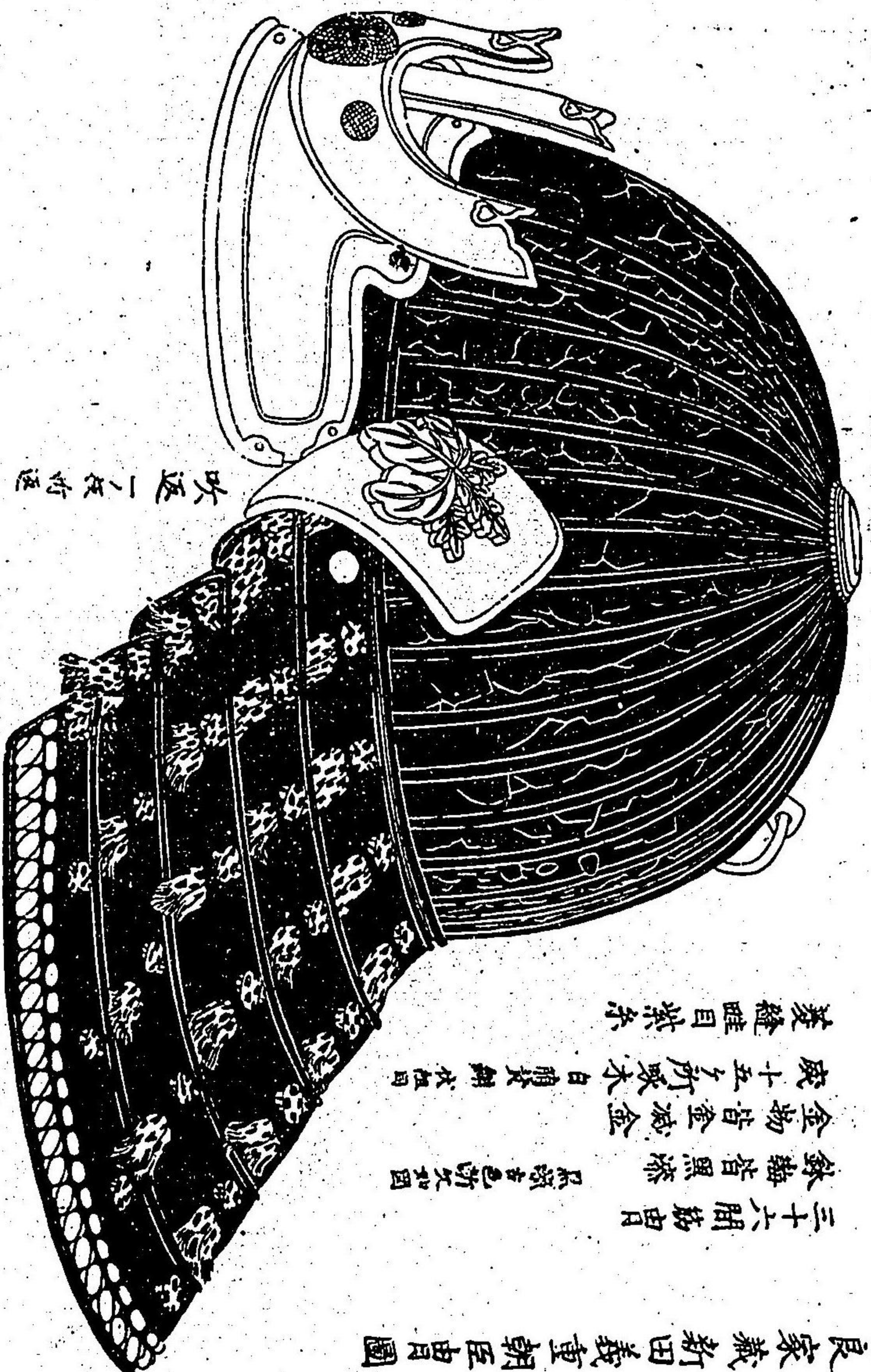

由良家藏新田義重朝臣由圖

吹返一長竹透

鍬形

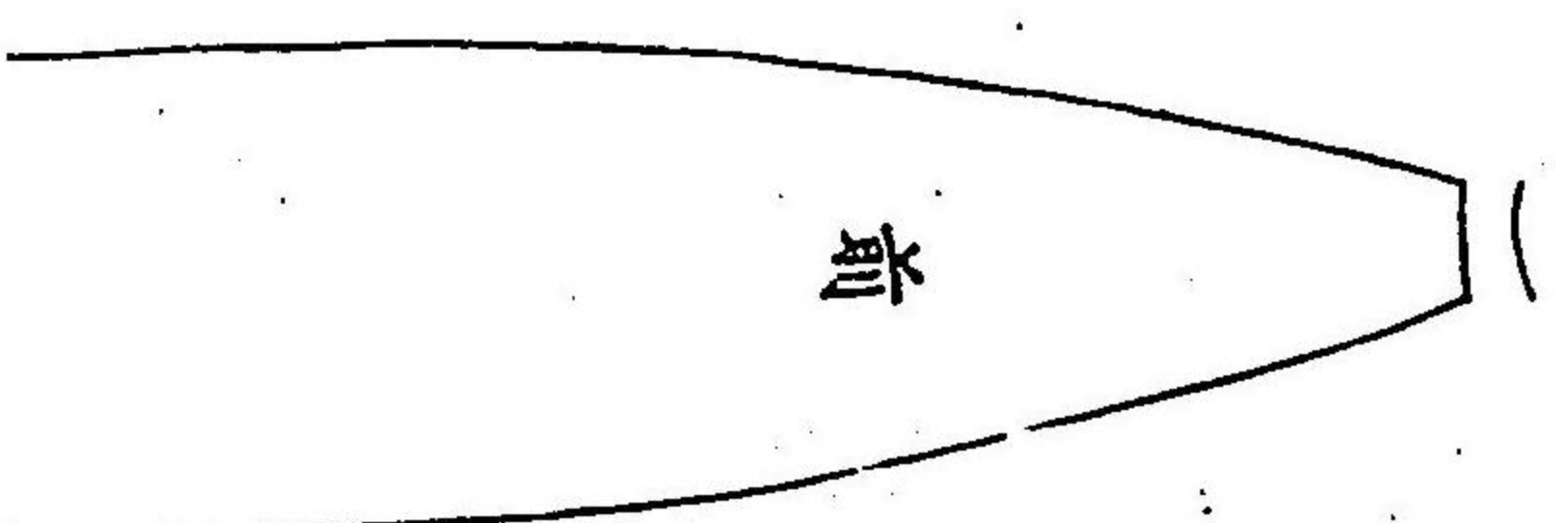
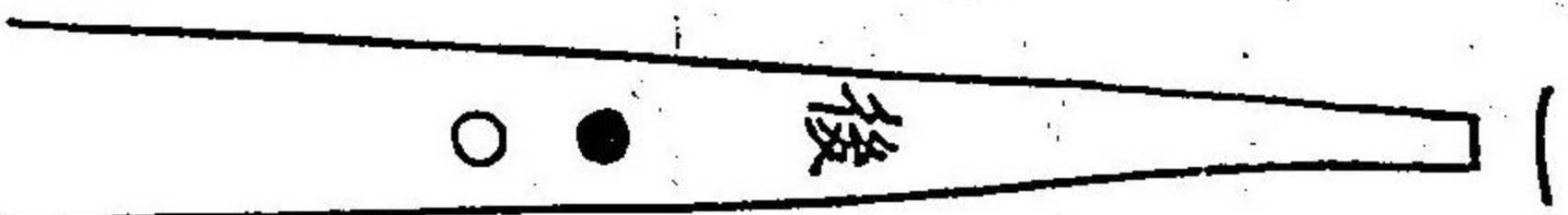
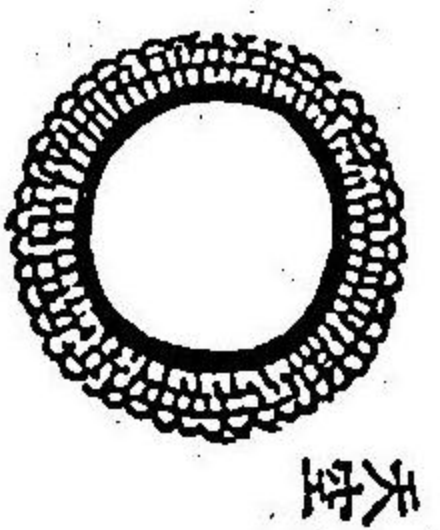
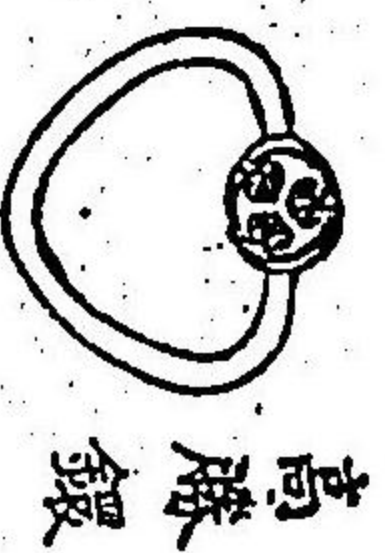
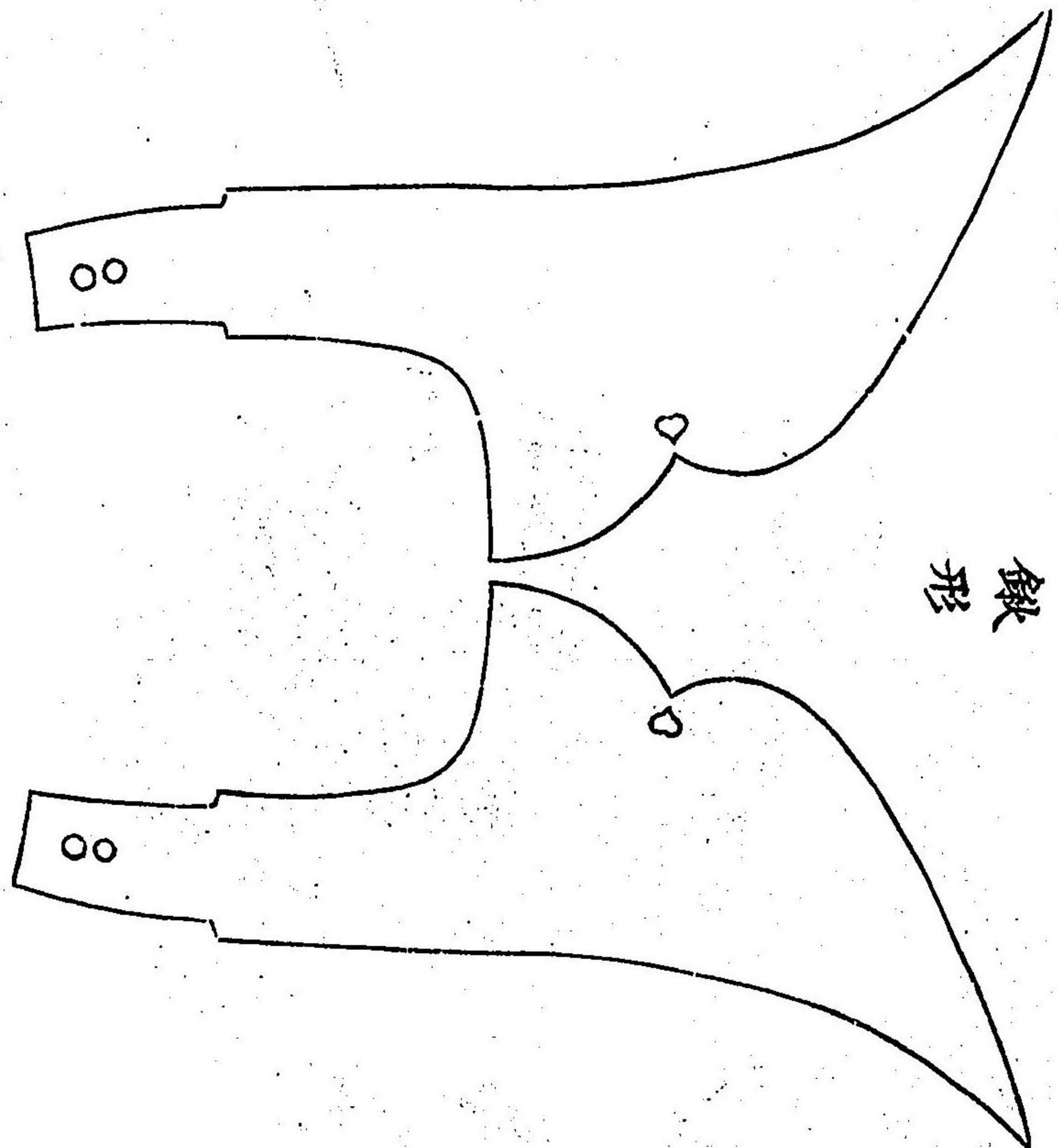

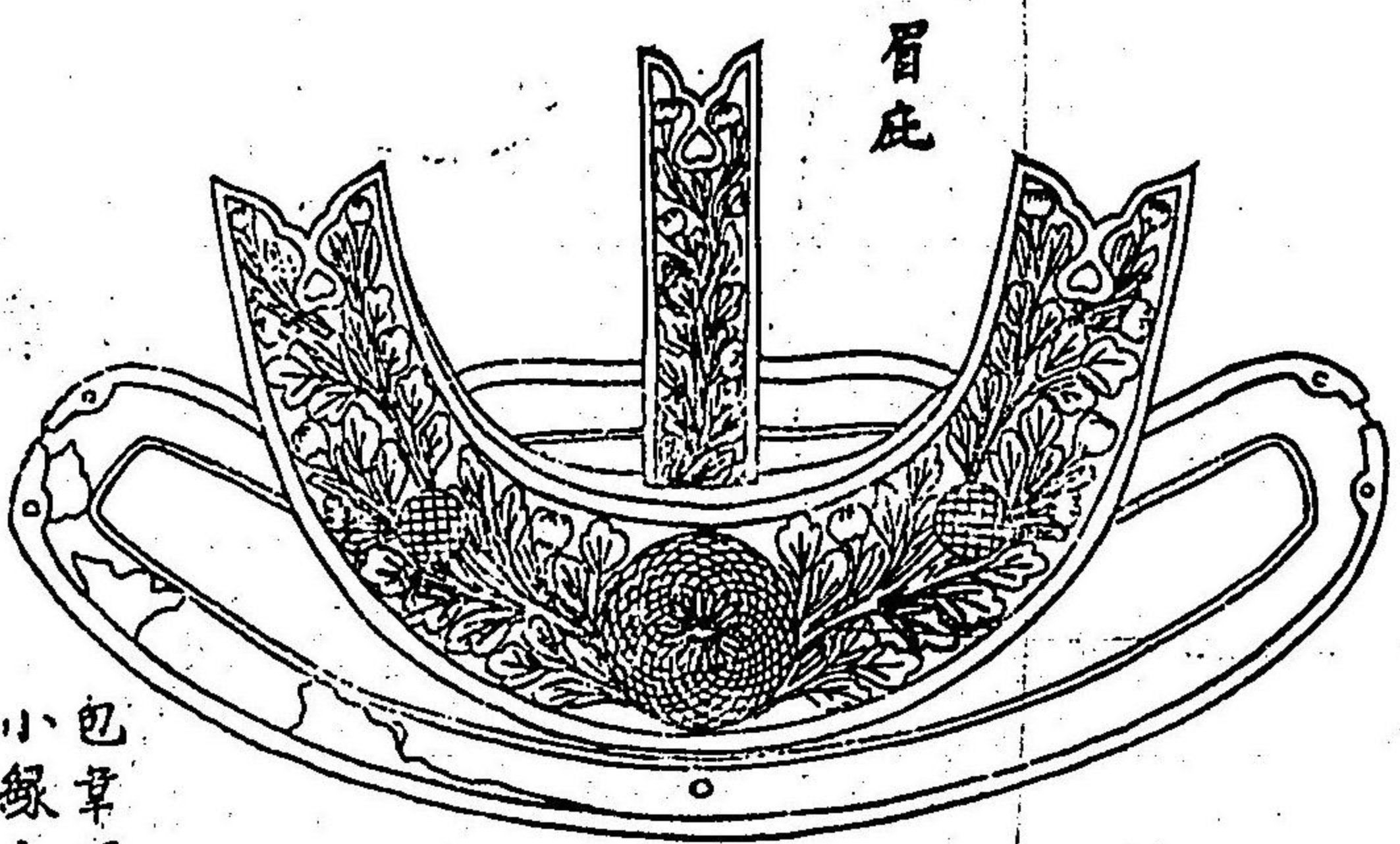

眉庇

包草天平草
小縁五星文不分明



織所真鍮
地奥子

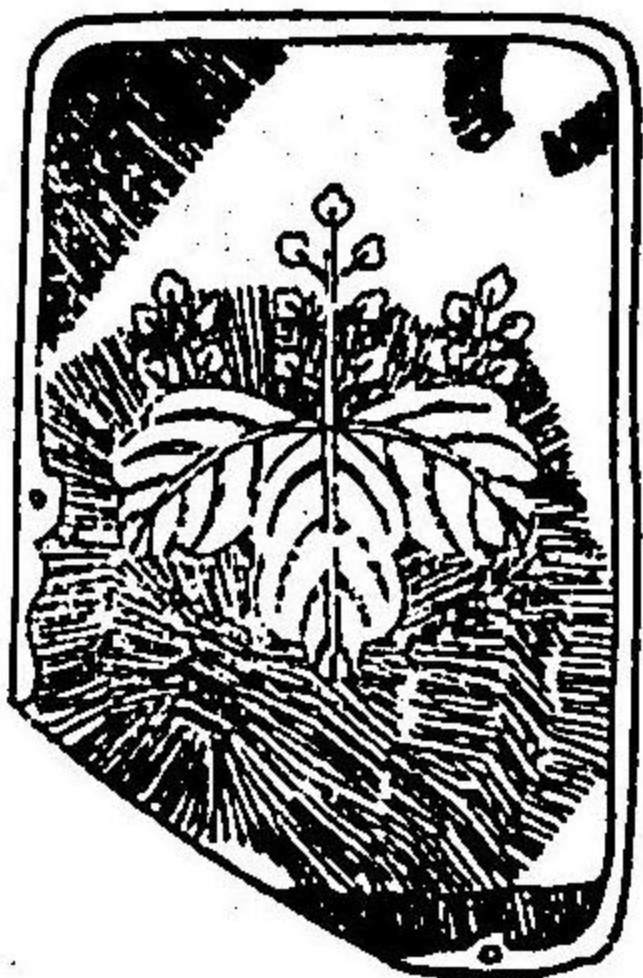

吹返金唐草

眉相草 藍地白文



鉢付鍍金メツキ

安藝國嚴嶋神社藏新羅三郎義光甲冑圖

由月全圖

鉢三十二間黑塗

龜上二段鍍革

一枚交下二段革斗
小札長一寸七分

幅六分

四天缺穴共無

八双金物五所

身糸崩黃紅白

畦目菱共朱漆

甲冑共金物皆

金減金

同威紺韋

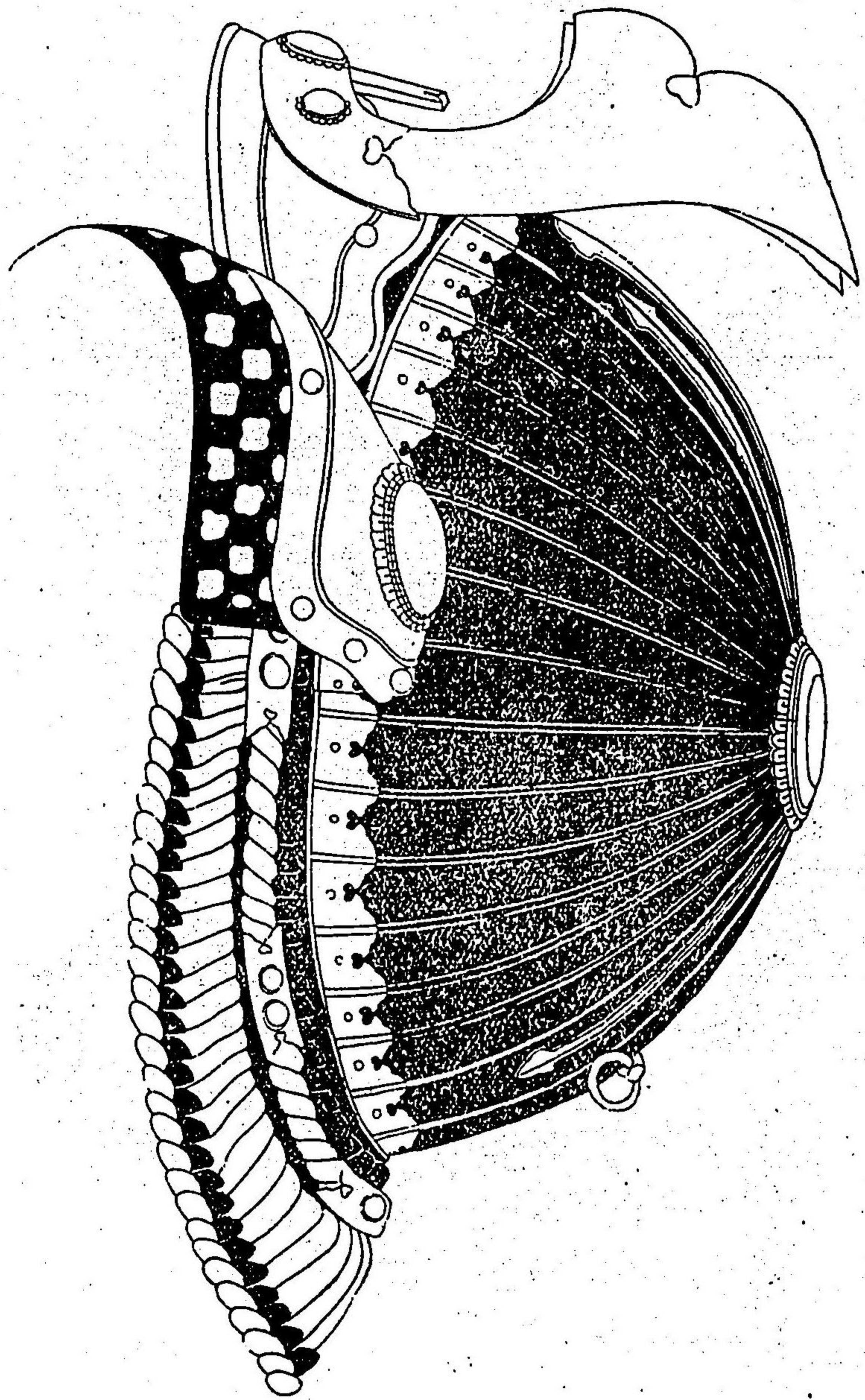
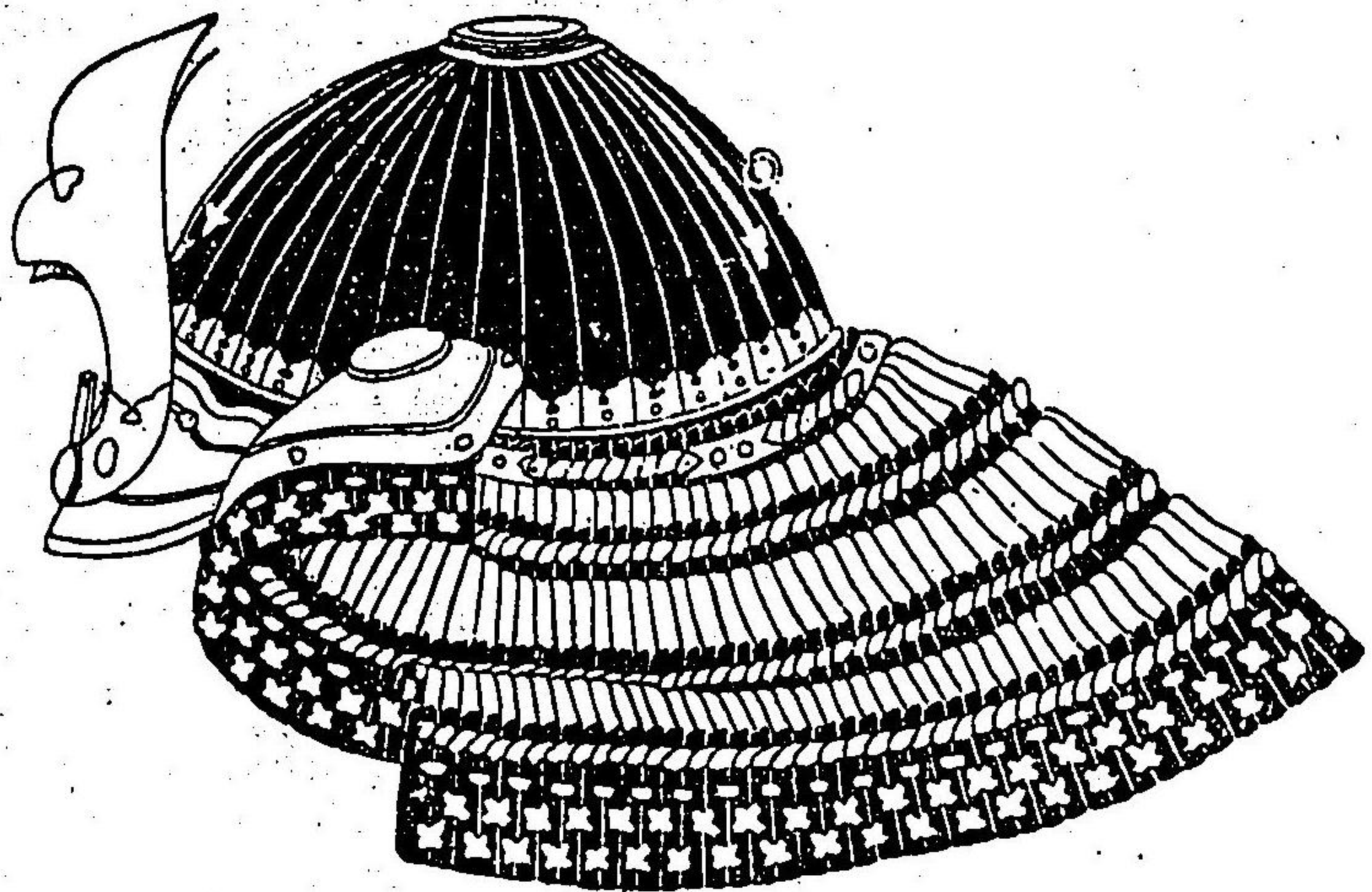

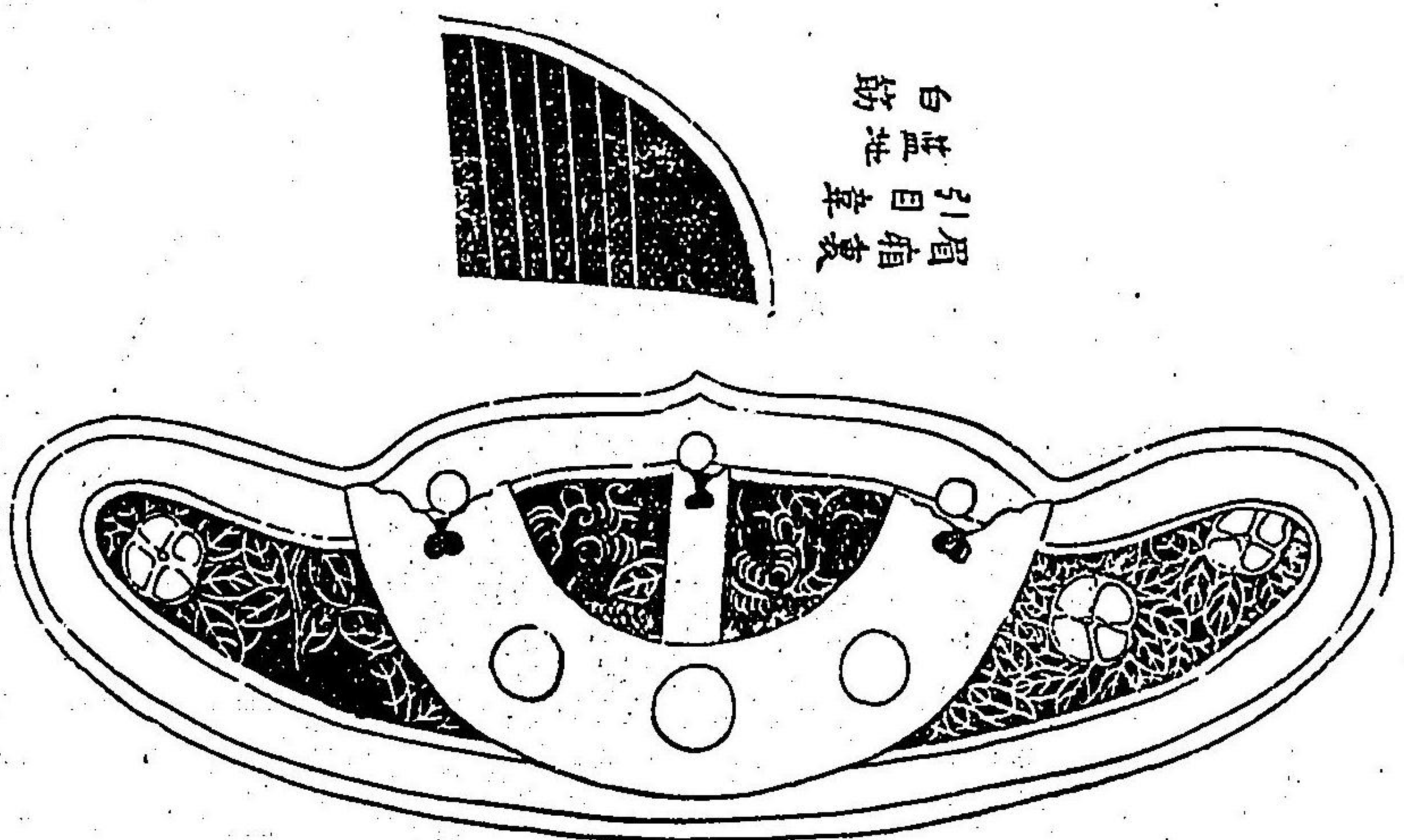

眉箱
引目章
花地
白筋

包草藍地白文托用狀
小翠五星伏組白紅崩黃
皆甲由同

眉箱

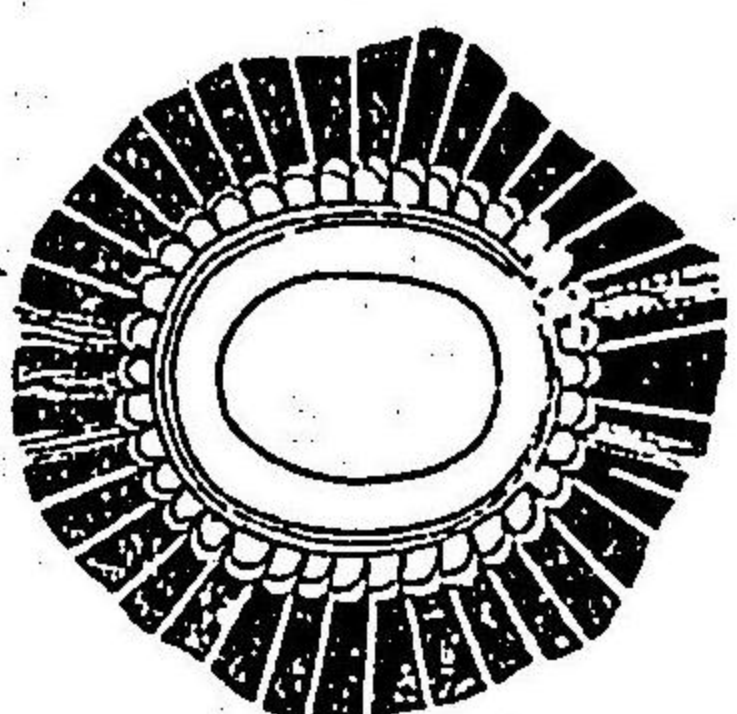

天宮座

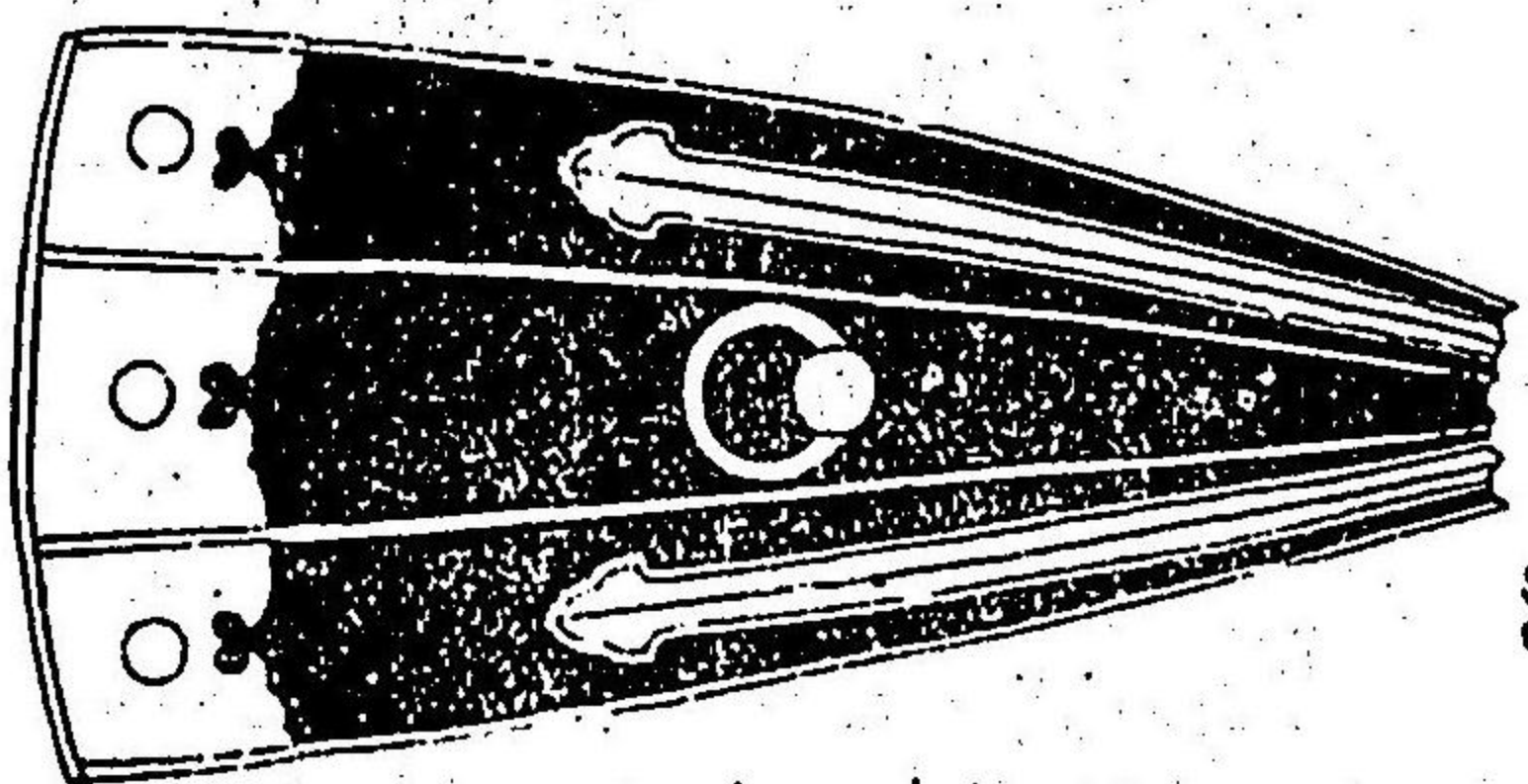

後

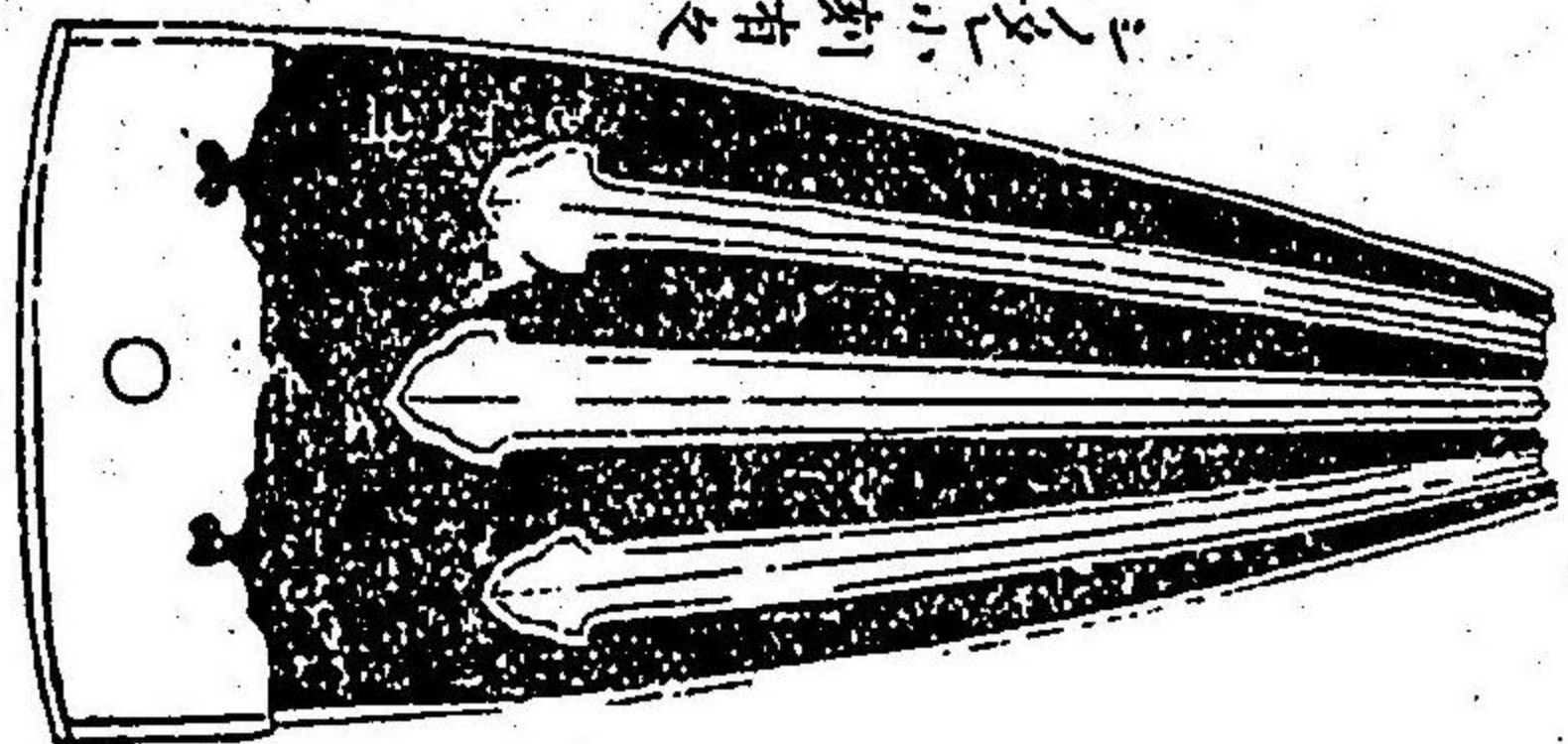

前

鎗

之是小有之
因畧之刺有之

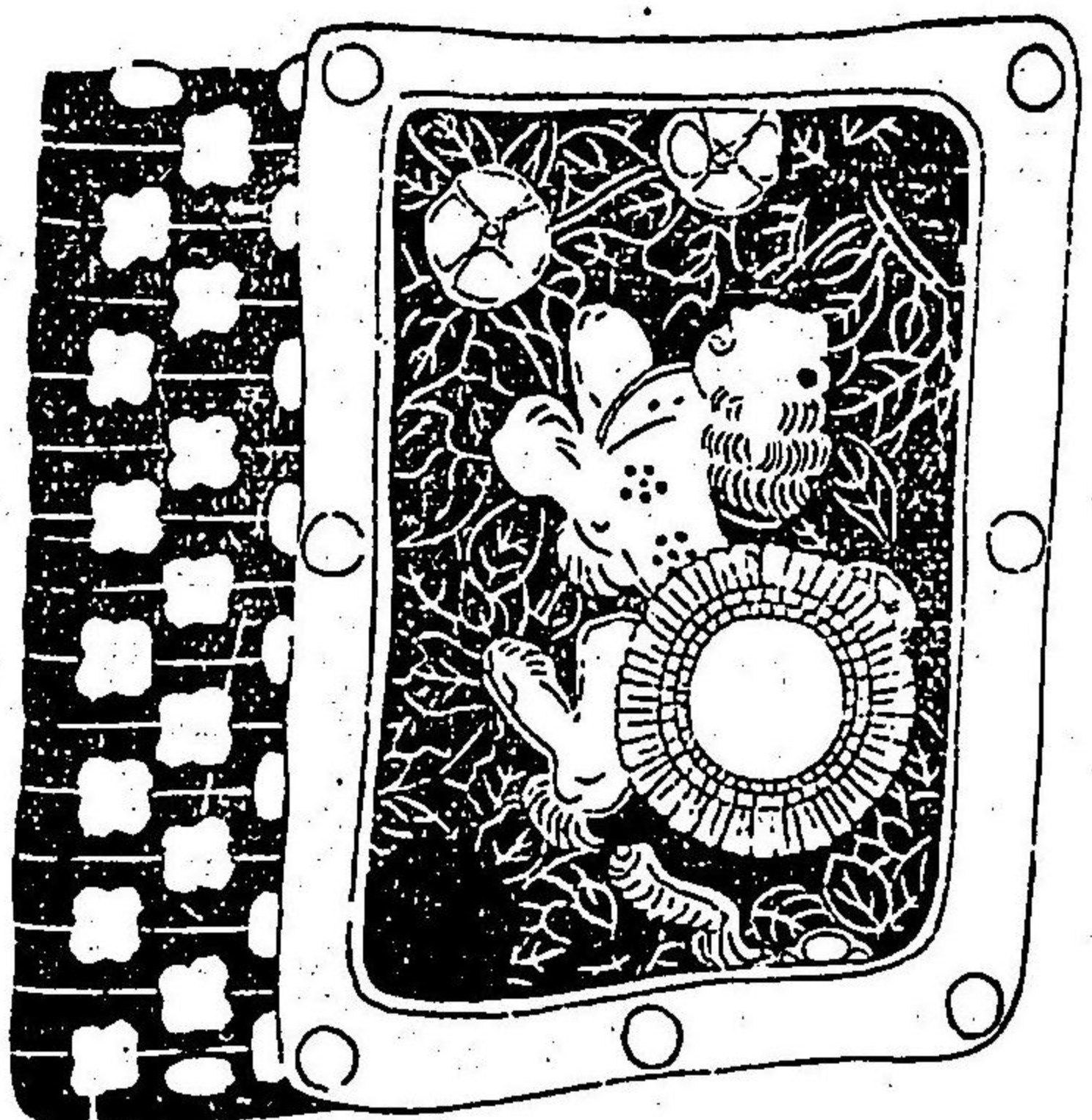

左

吹返

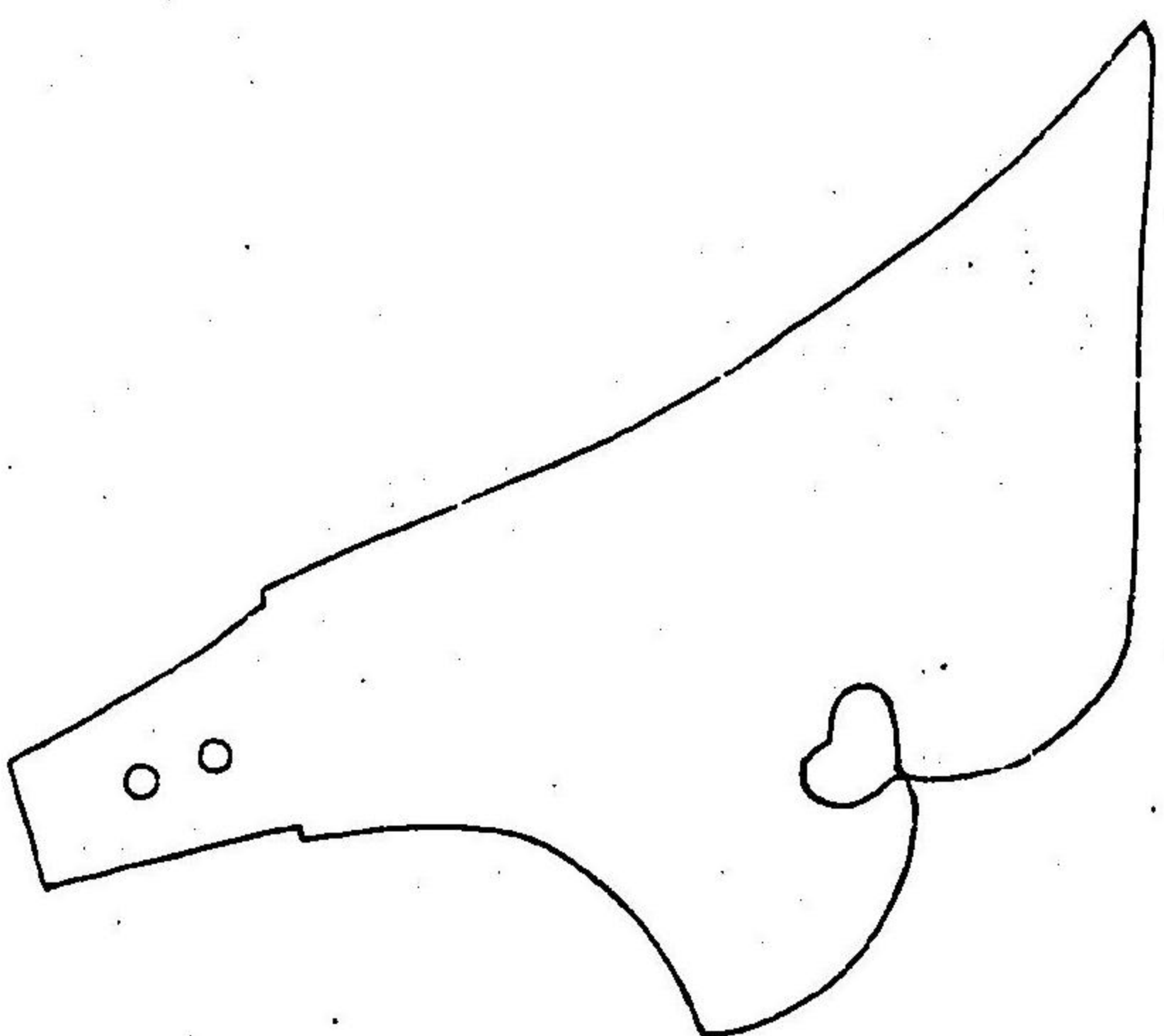

鐵形

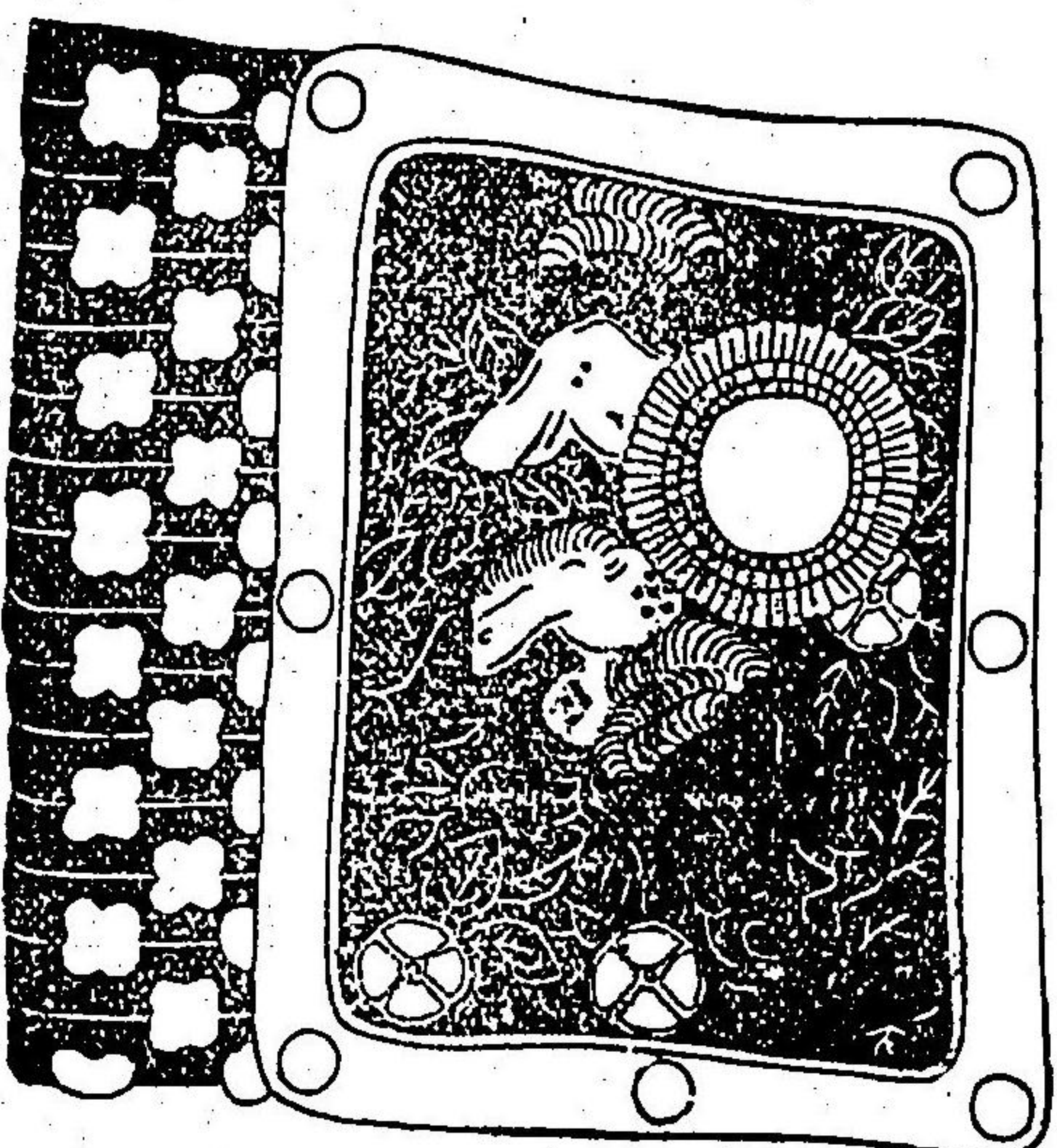
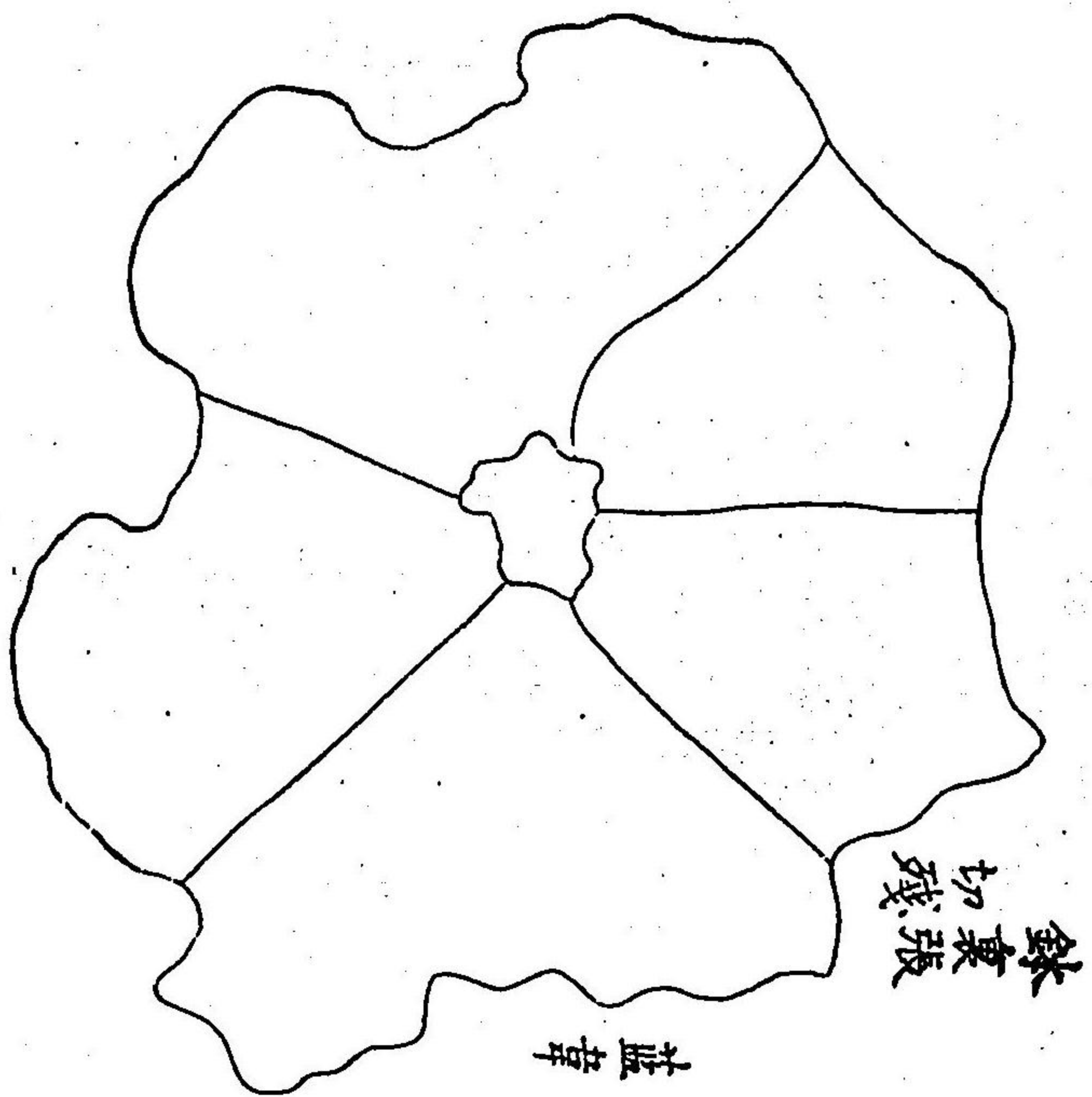

鉢裏

前

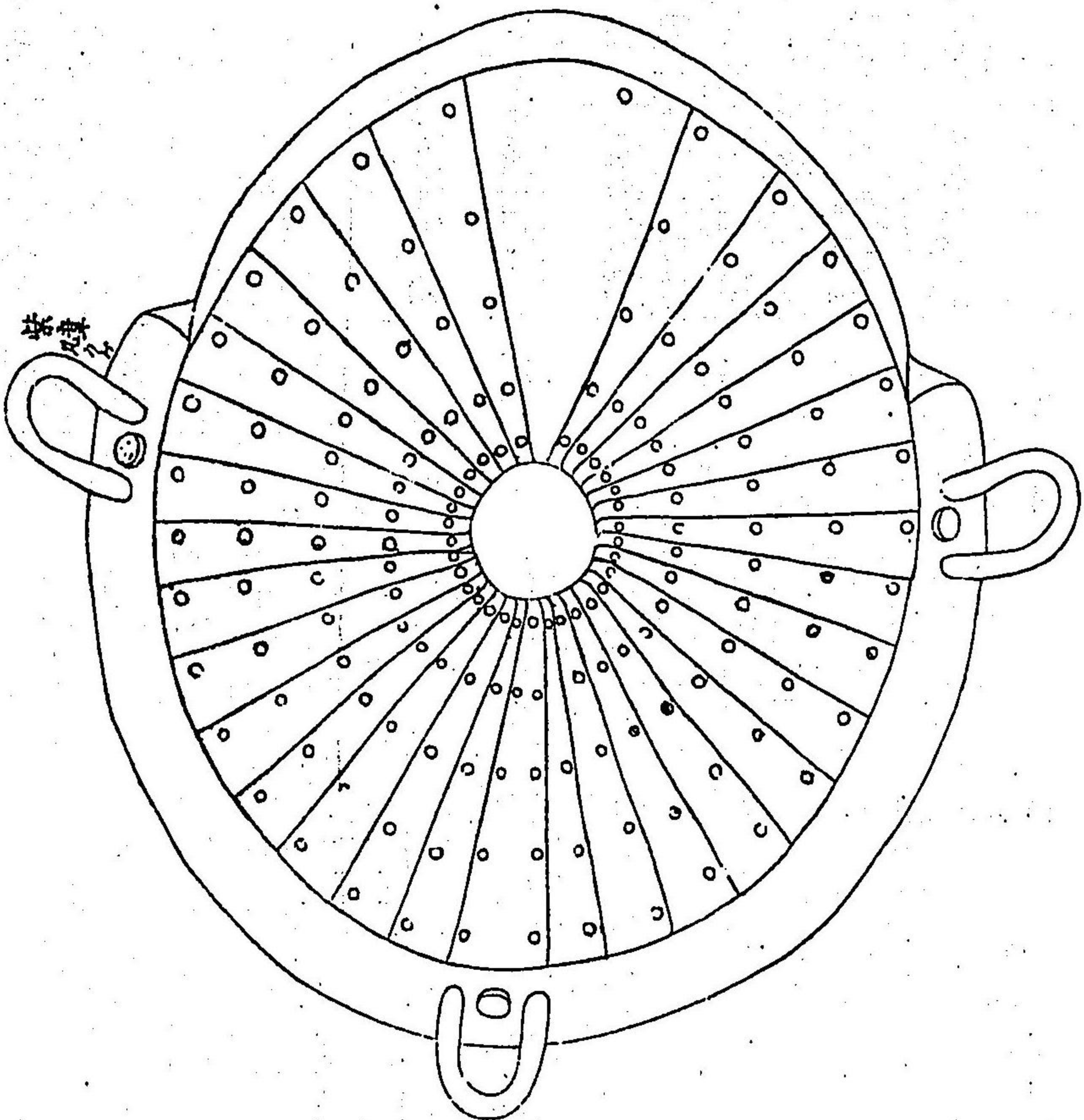

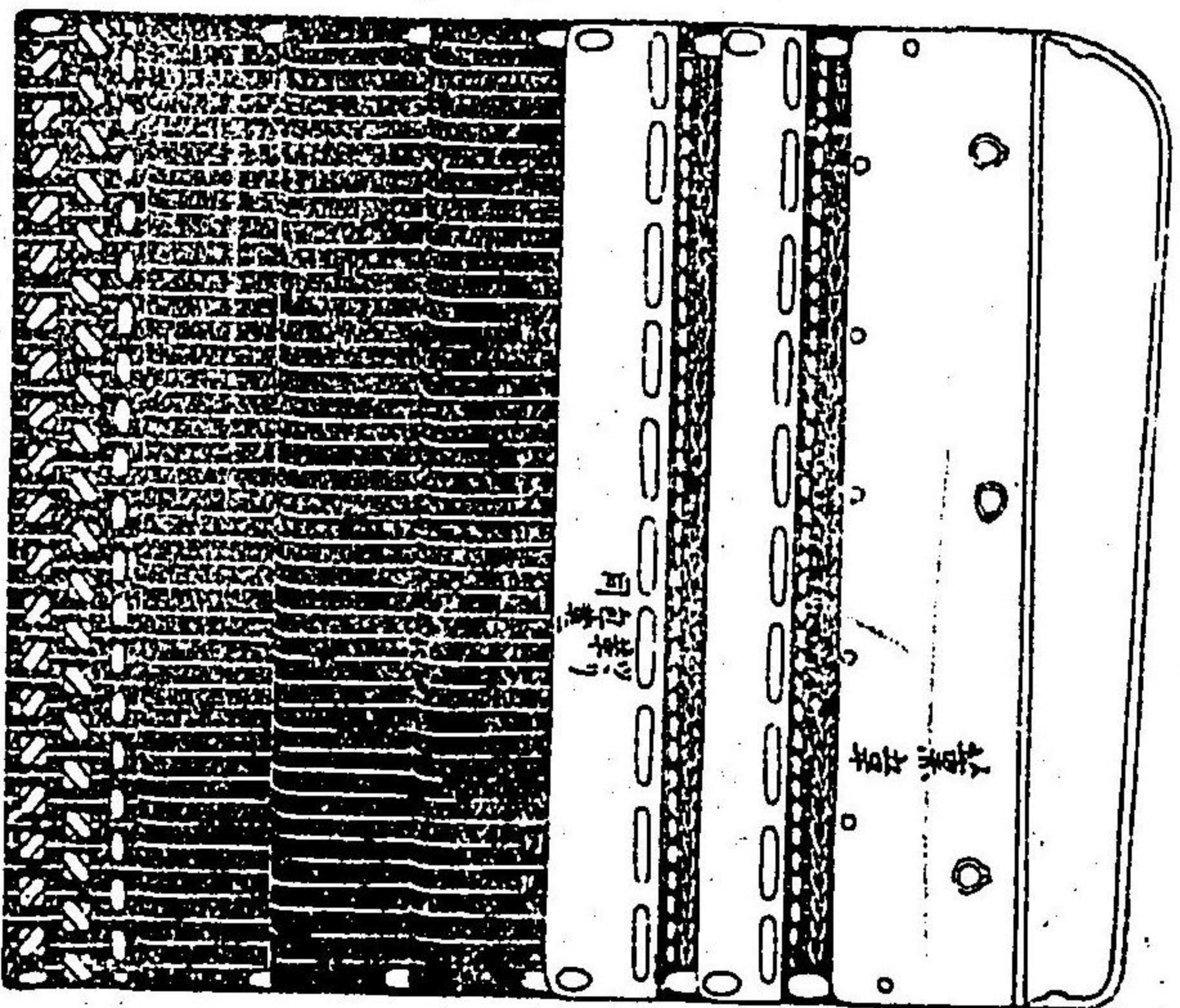

裏圖

此二版之紫華以子包

水引紅白綾
 畦目系白葫黃紫
 此黑星加多
 心每芒又入
 長一尺三寸六分

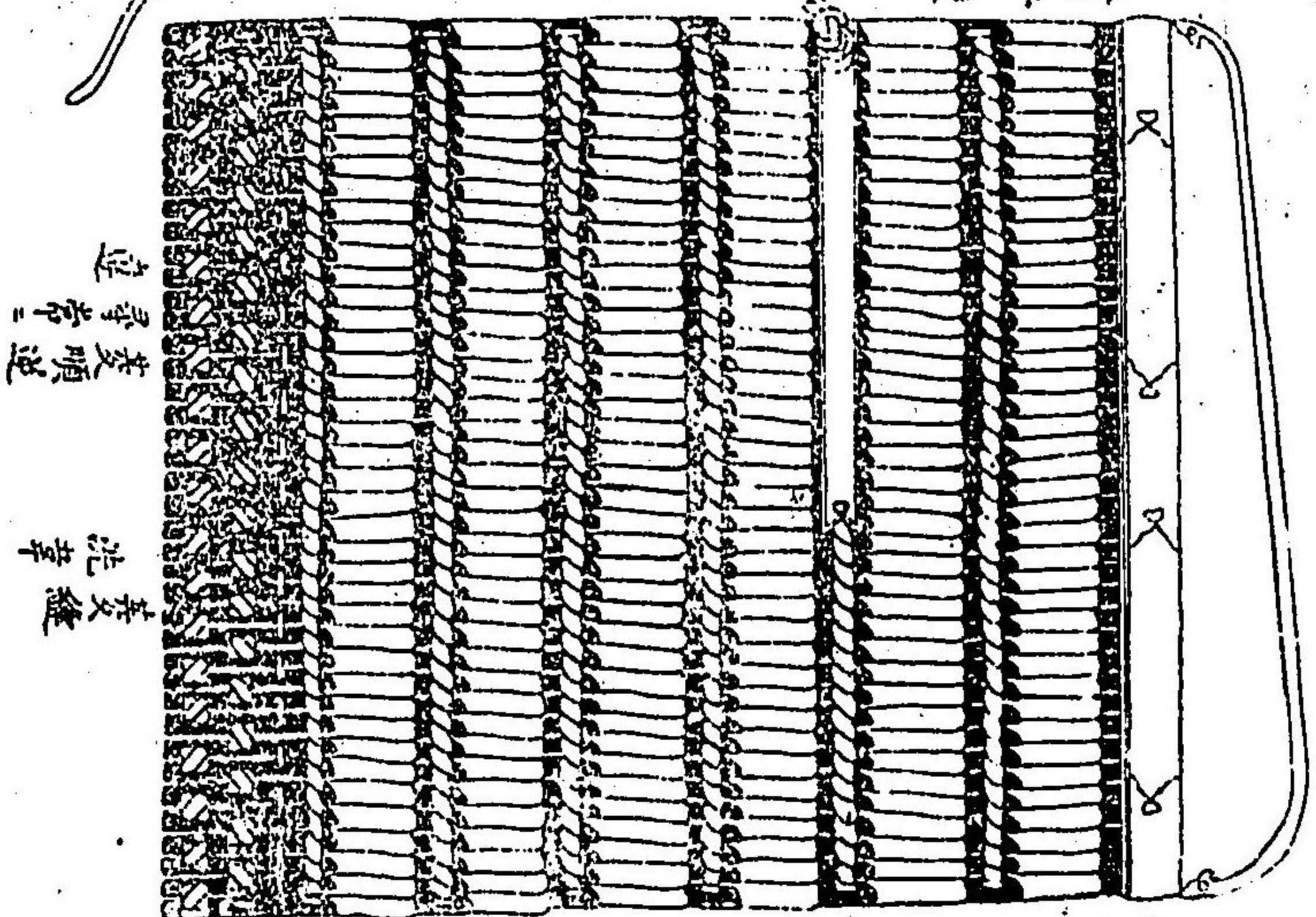

袖全圖
 折恭長一尺三寸五分 上三段鑲華一板文屬七三分
 中札一段四十

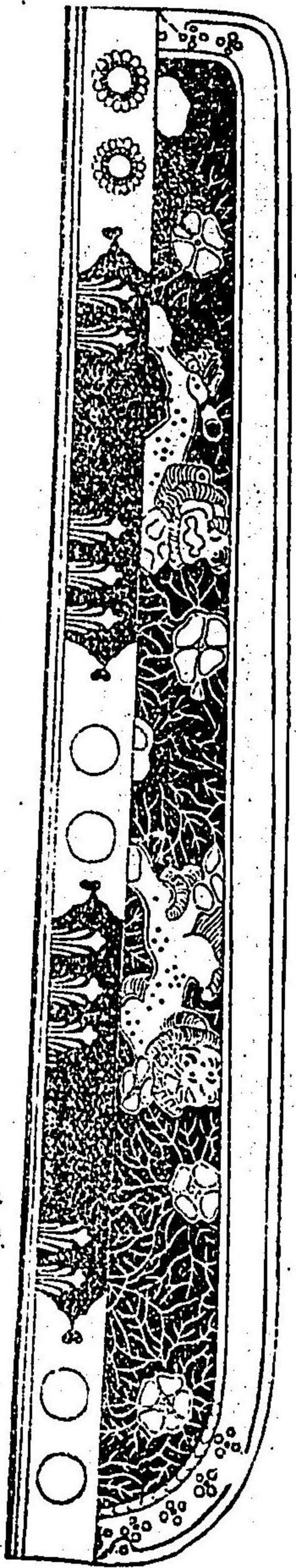

祥金物

品草
 甚地皆大

水引紅
 白綾

袖冠板同裝板
 左袖同

白紫
 月系畦目
 葫黃

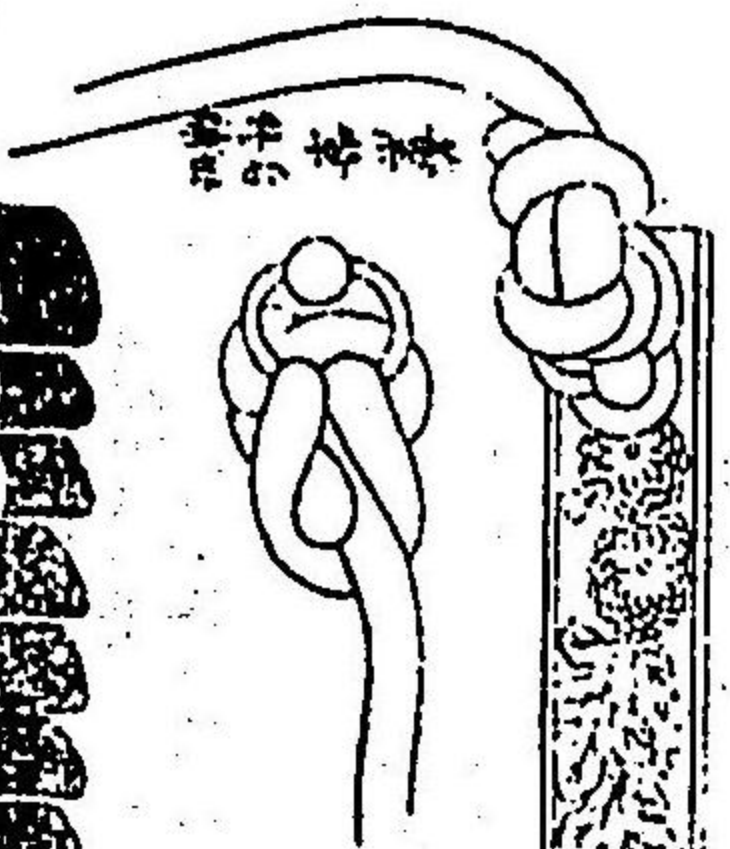

紫華
 林林

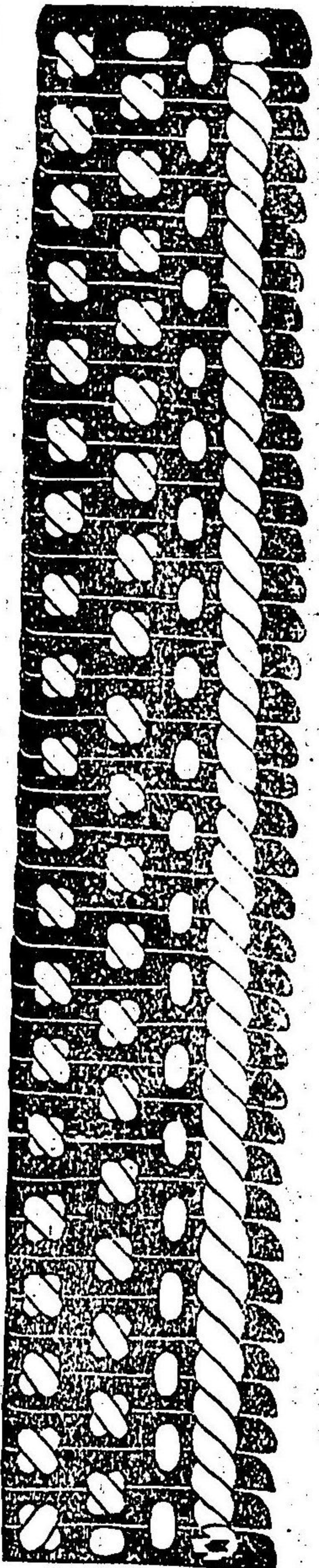

左右掛緒 緋ハッ打後世修補

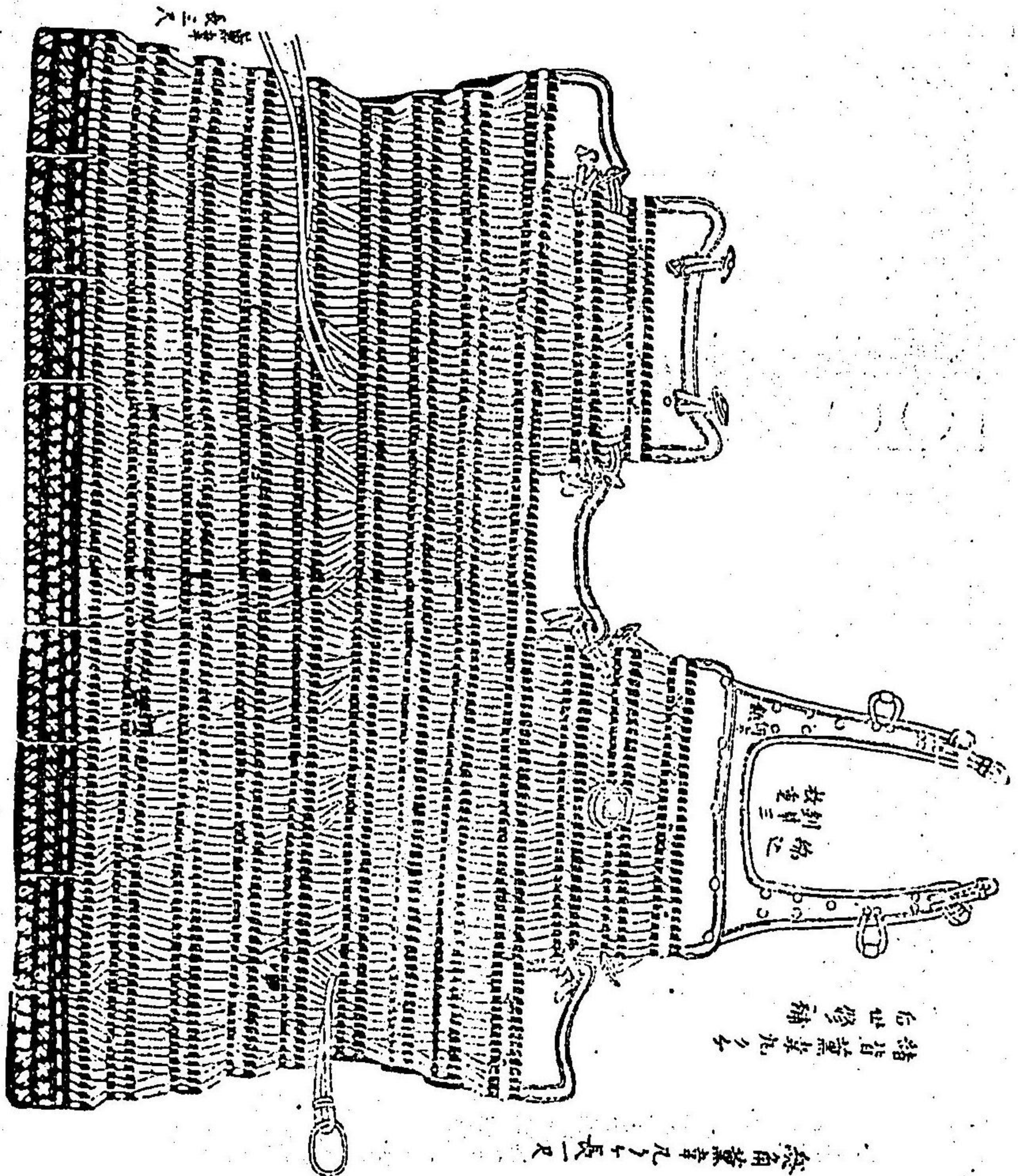
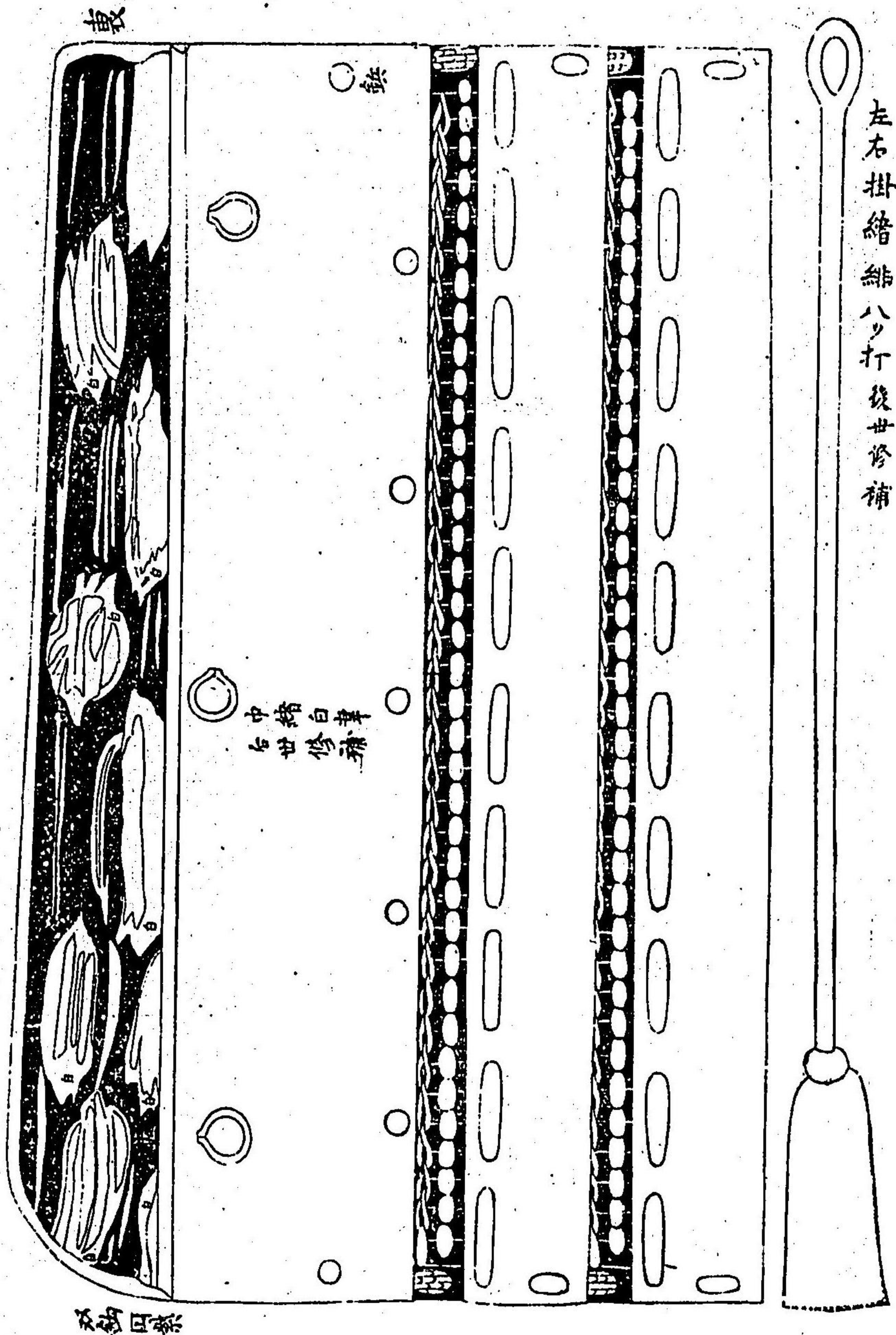

胴全圖

然南條寺凡ノ七長一尺

緒付は黒草九ノ寸
右世修補

蓮草長半

胸板

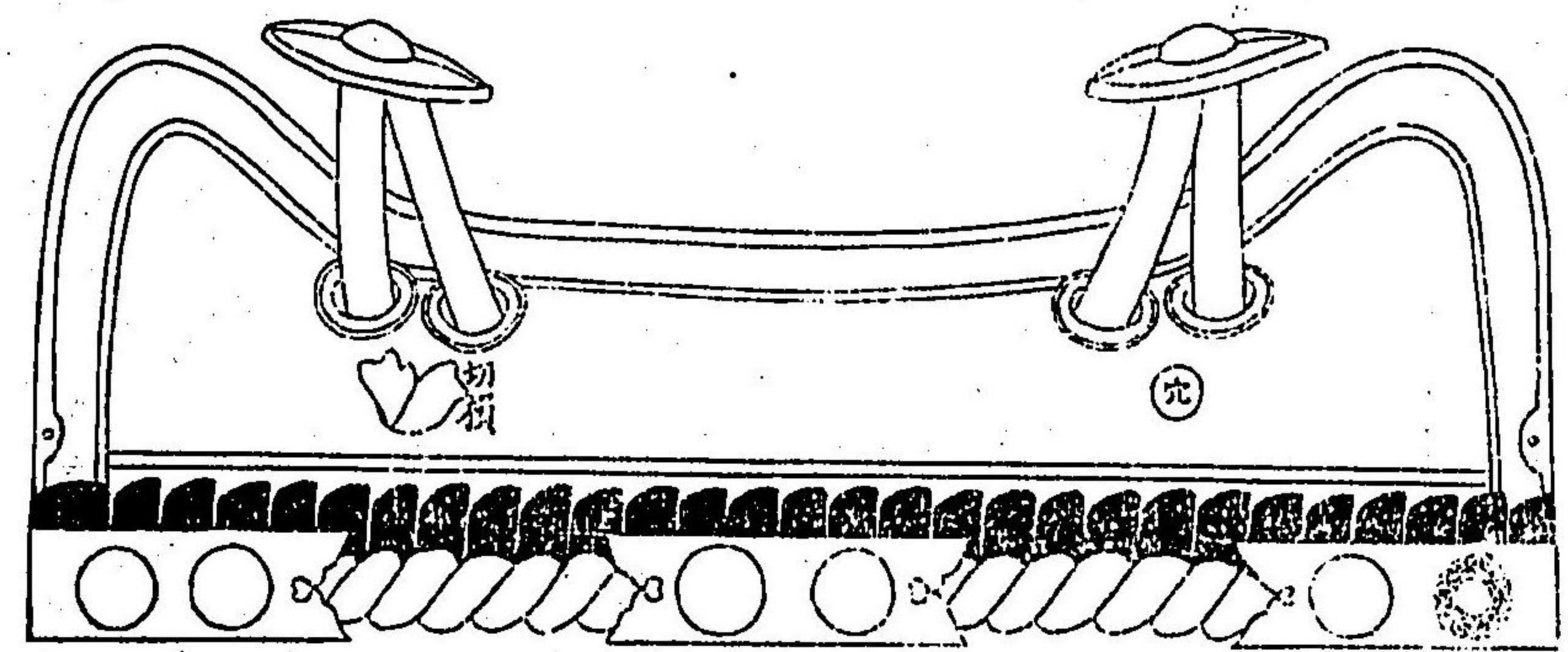

射向

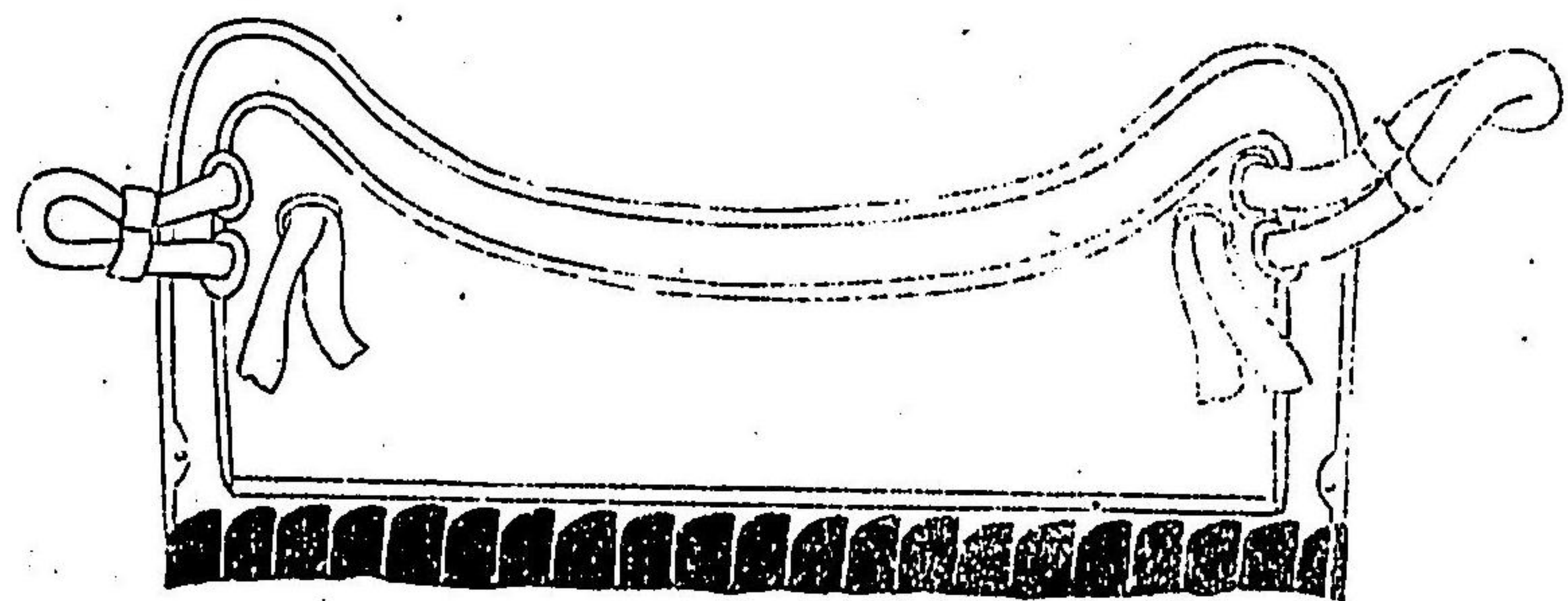

押付約

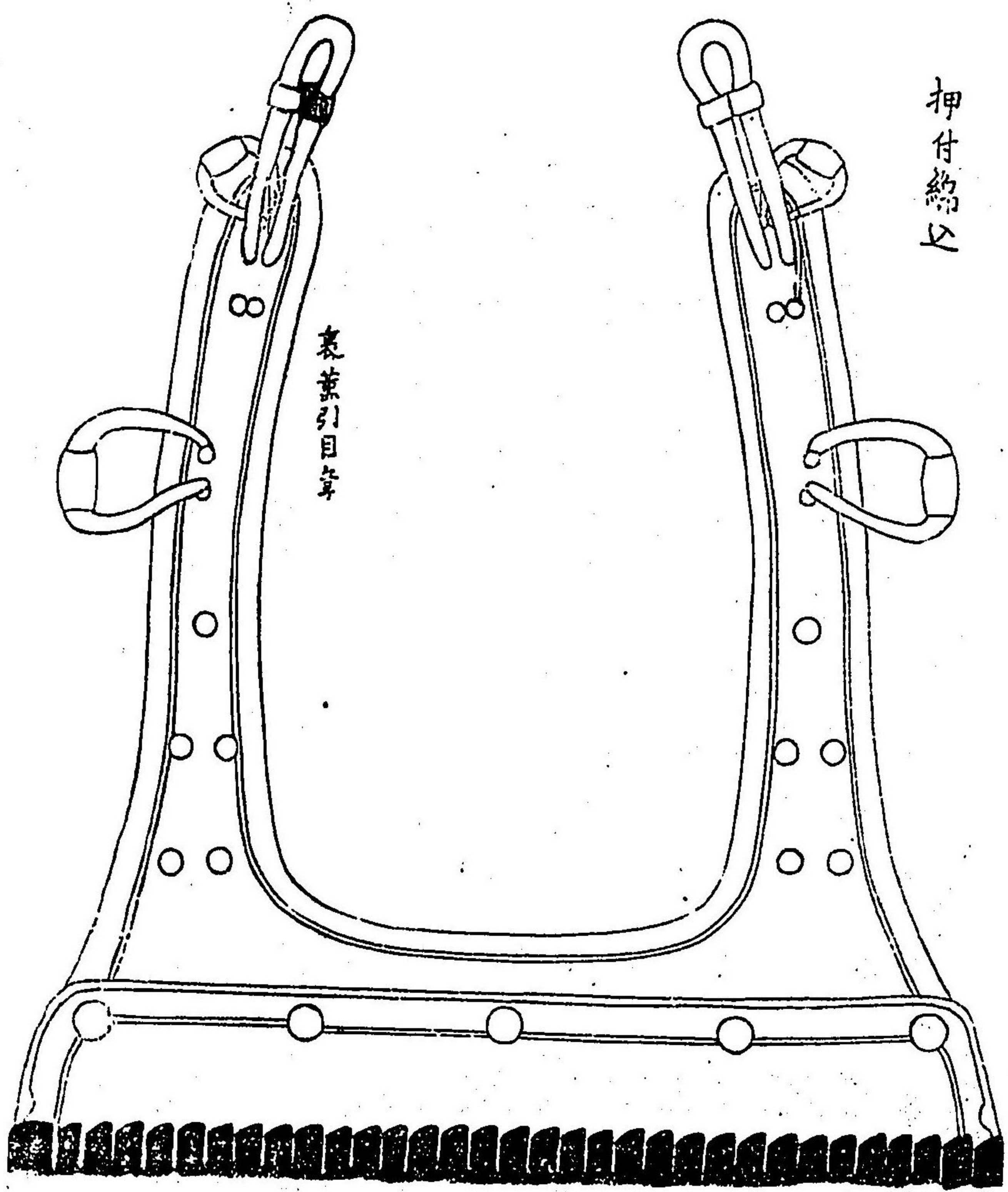

裏葉引目穿

草摺

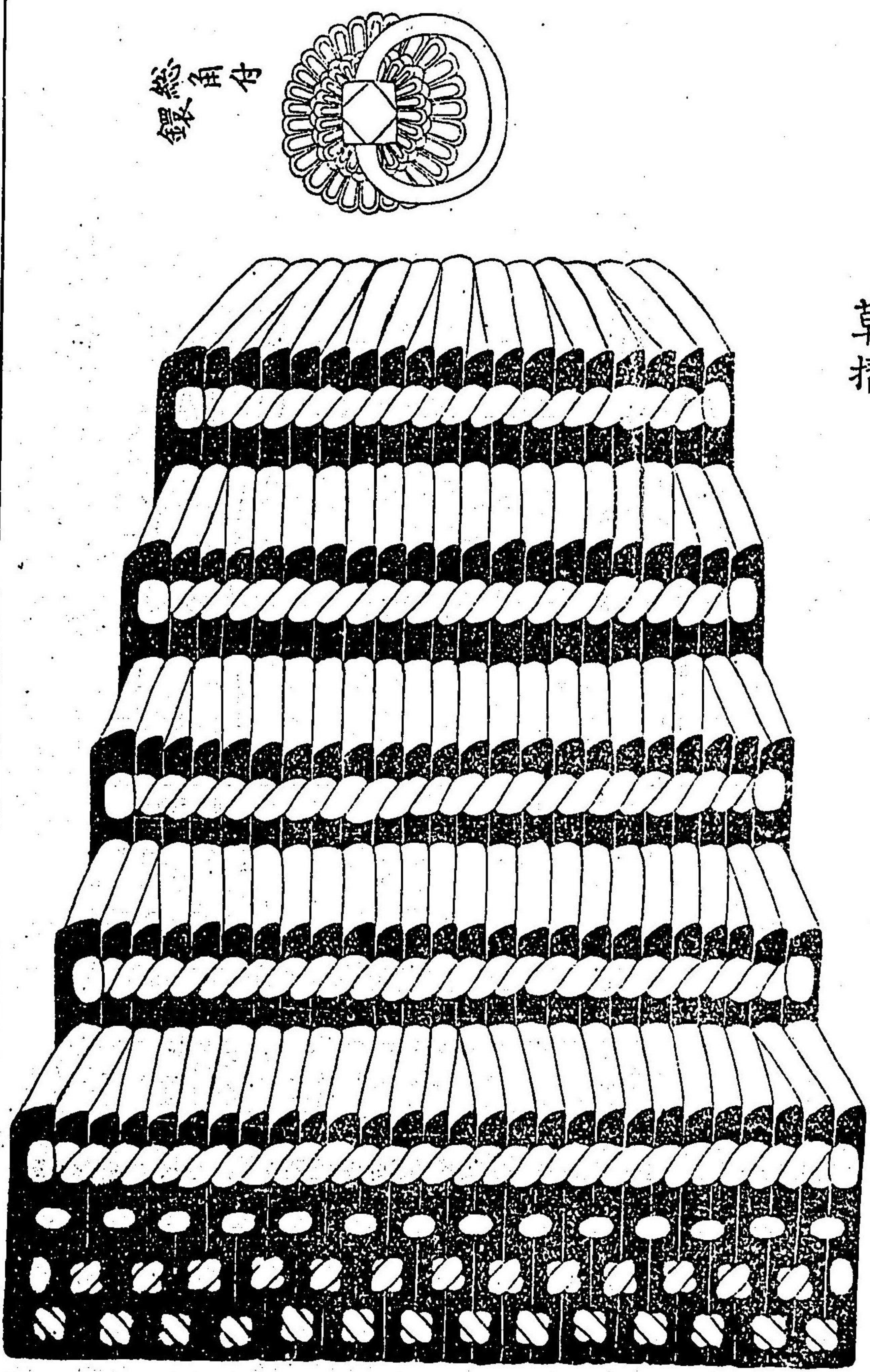

總角付
銀

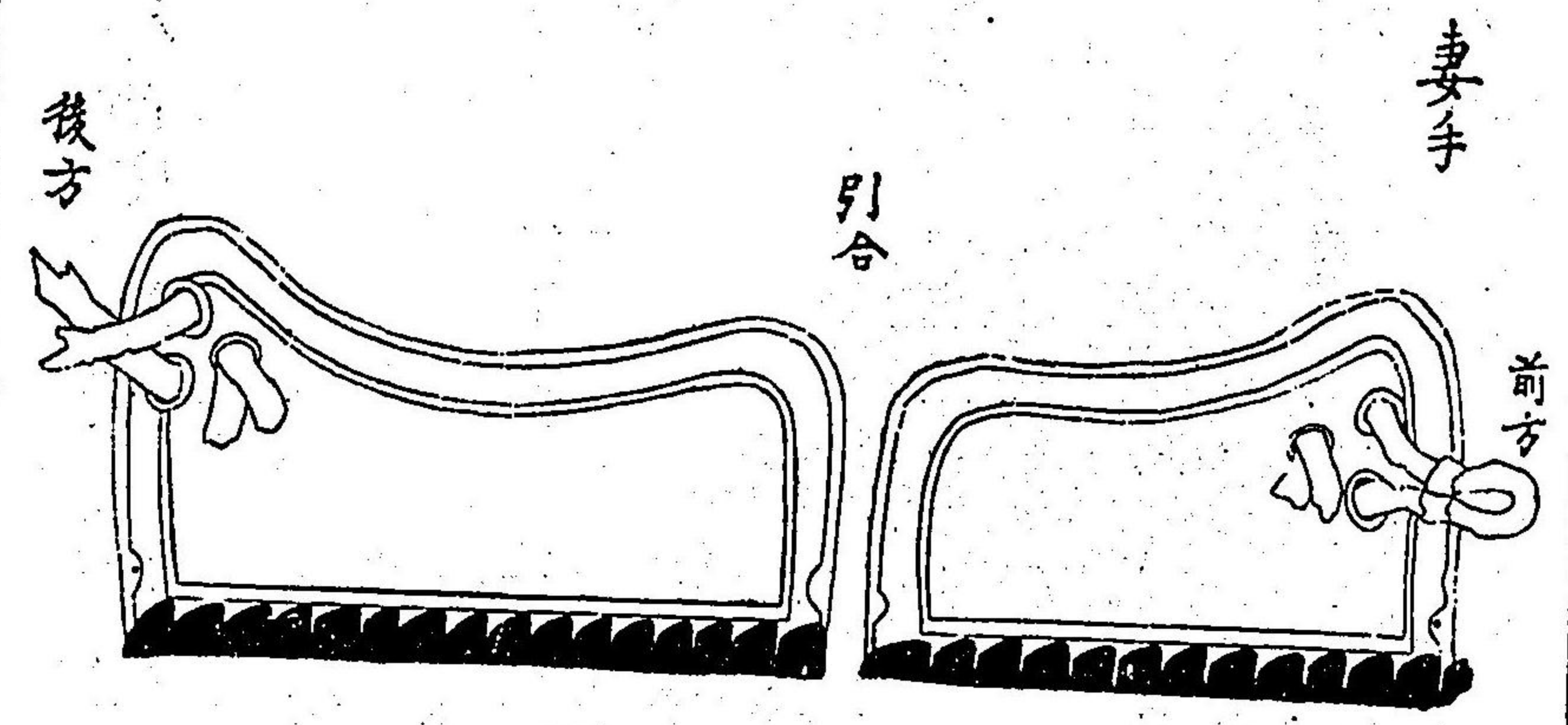

妻手

備前國豊原庄上寺八幡宮藏佐木盛綱
甲冑圖

冑全圖

三十四間 二方白地板金メツキ
 吹返包韋小縁伏組共後世修補
 鞆八双金物五所三打
 無刺九鉄二本宛三
 重坐
 鉢付鉄刻坐一重尤丸鉄三
 四所二打
 威糸淺黄一板斗紫
 甲冑共小縁五星伏組
 紺白紅耳糸花田色菱
 縫紅金物皆金メツキ
 畦目紫白崩木

鎧垂前三本後
 二本二重坐

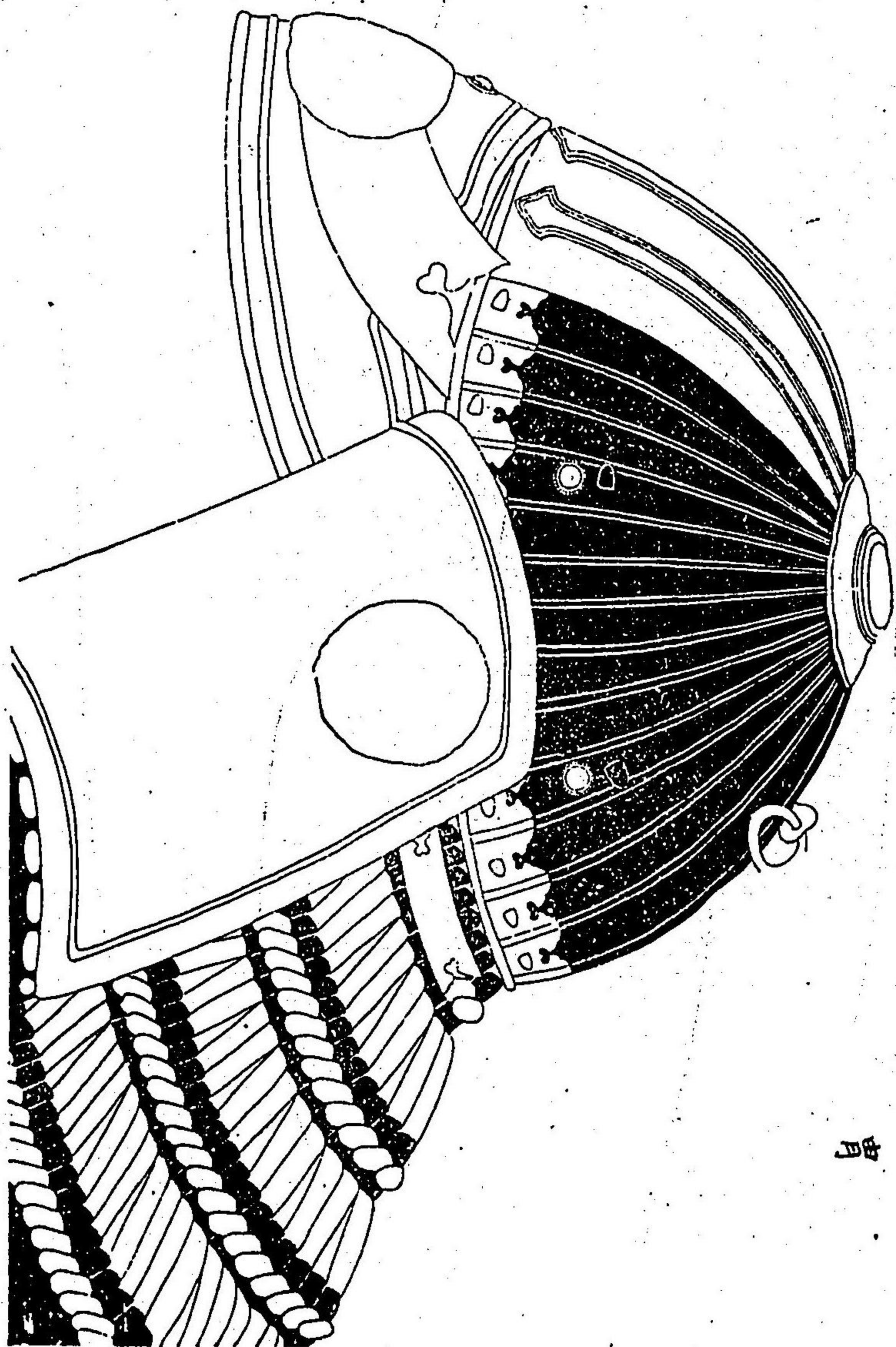
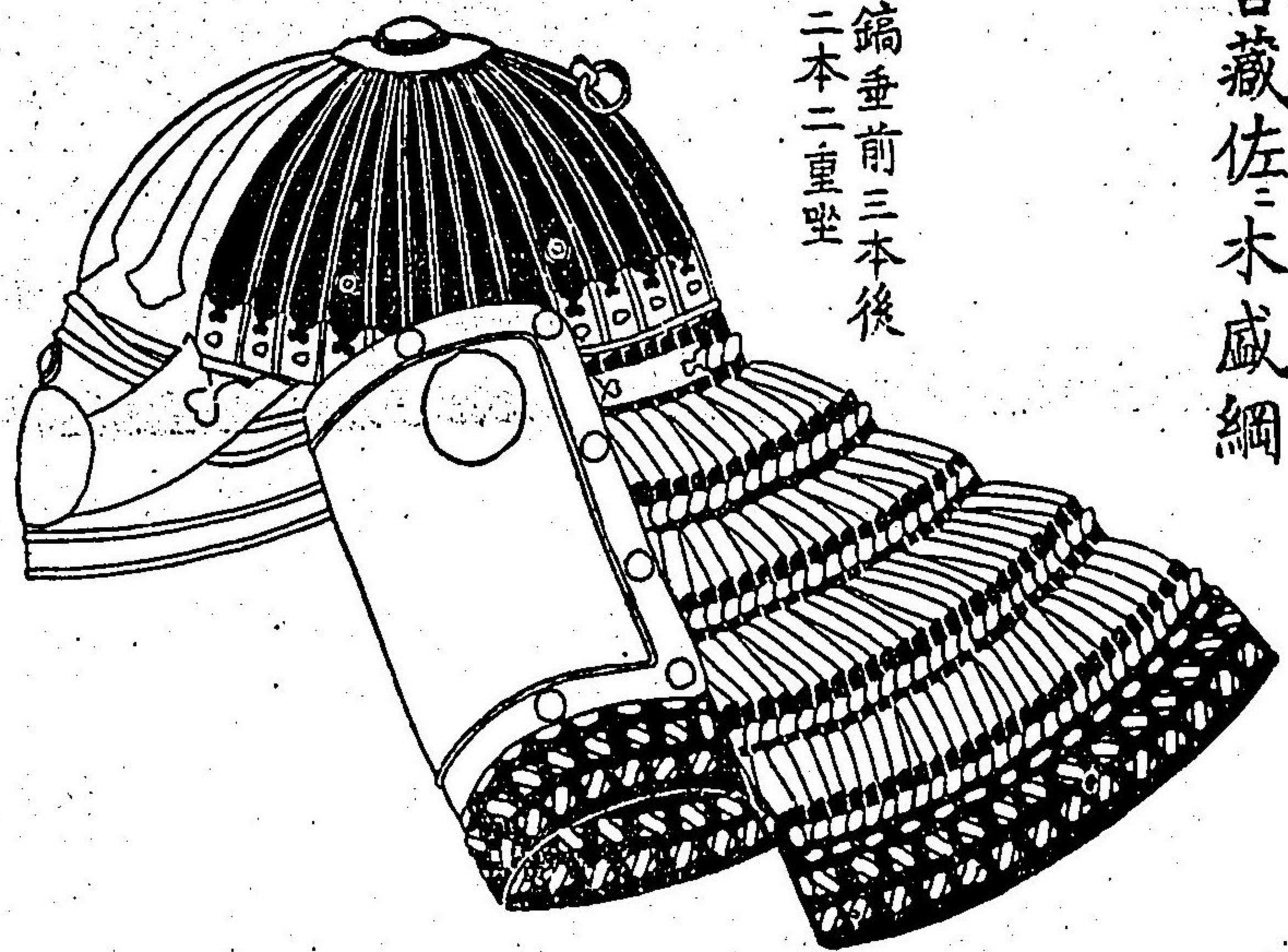

四甲

銀形

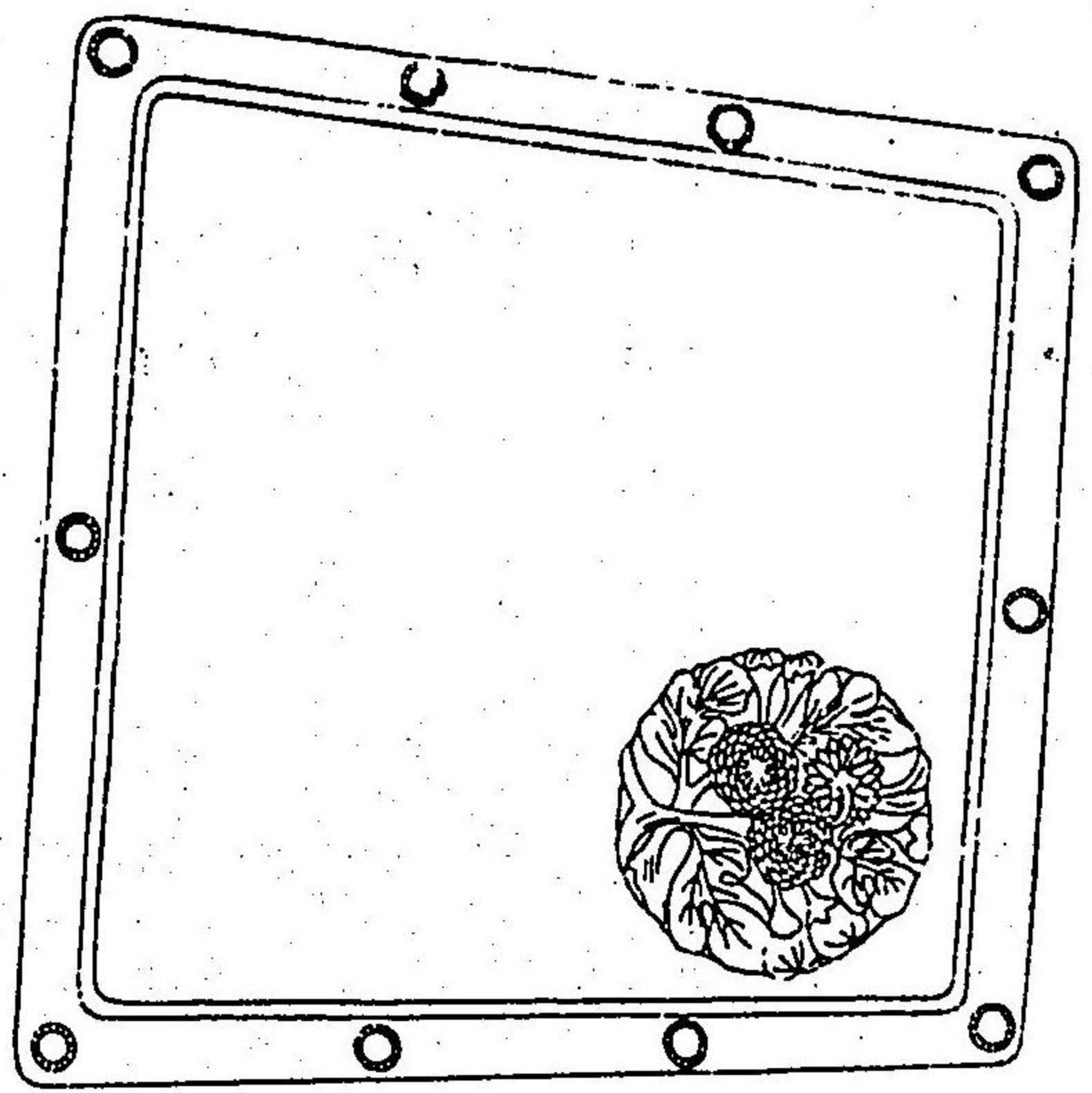
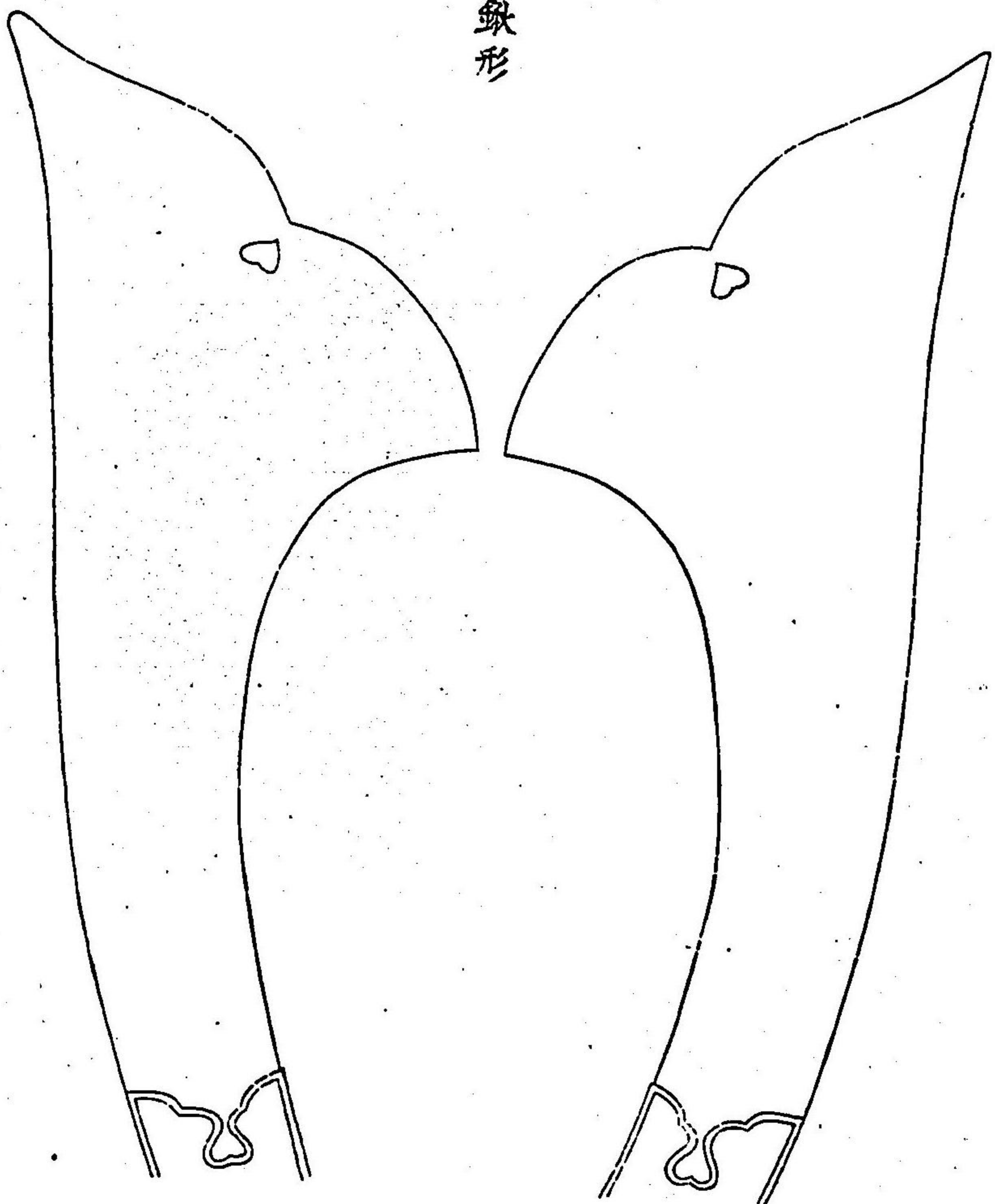

吹透

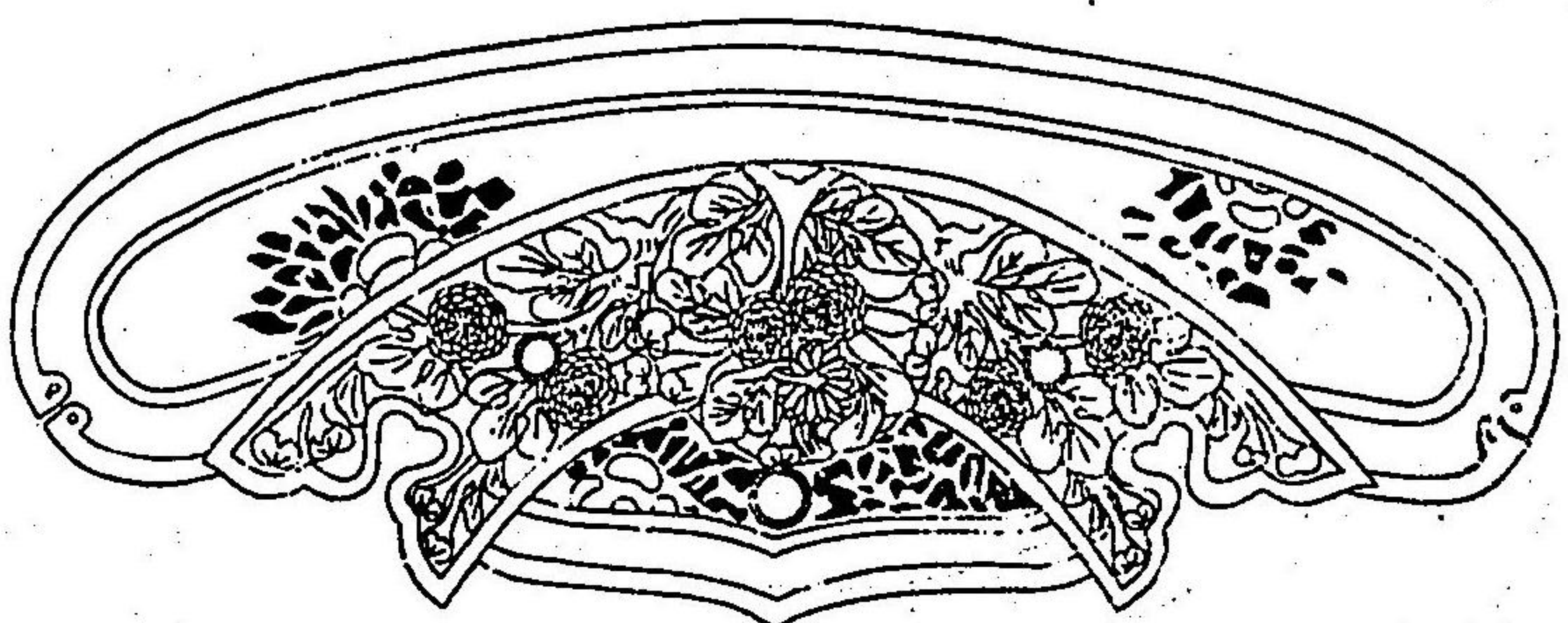

眉虎銀形基

華蓋地白文及鈎之處同禁下皆同



天空井史

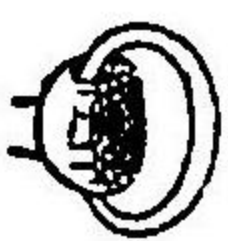

高勝銀



珠有銀



輪八双金物

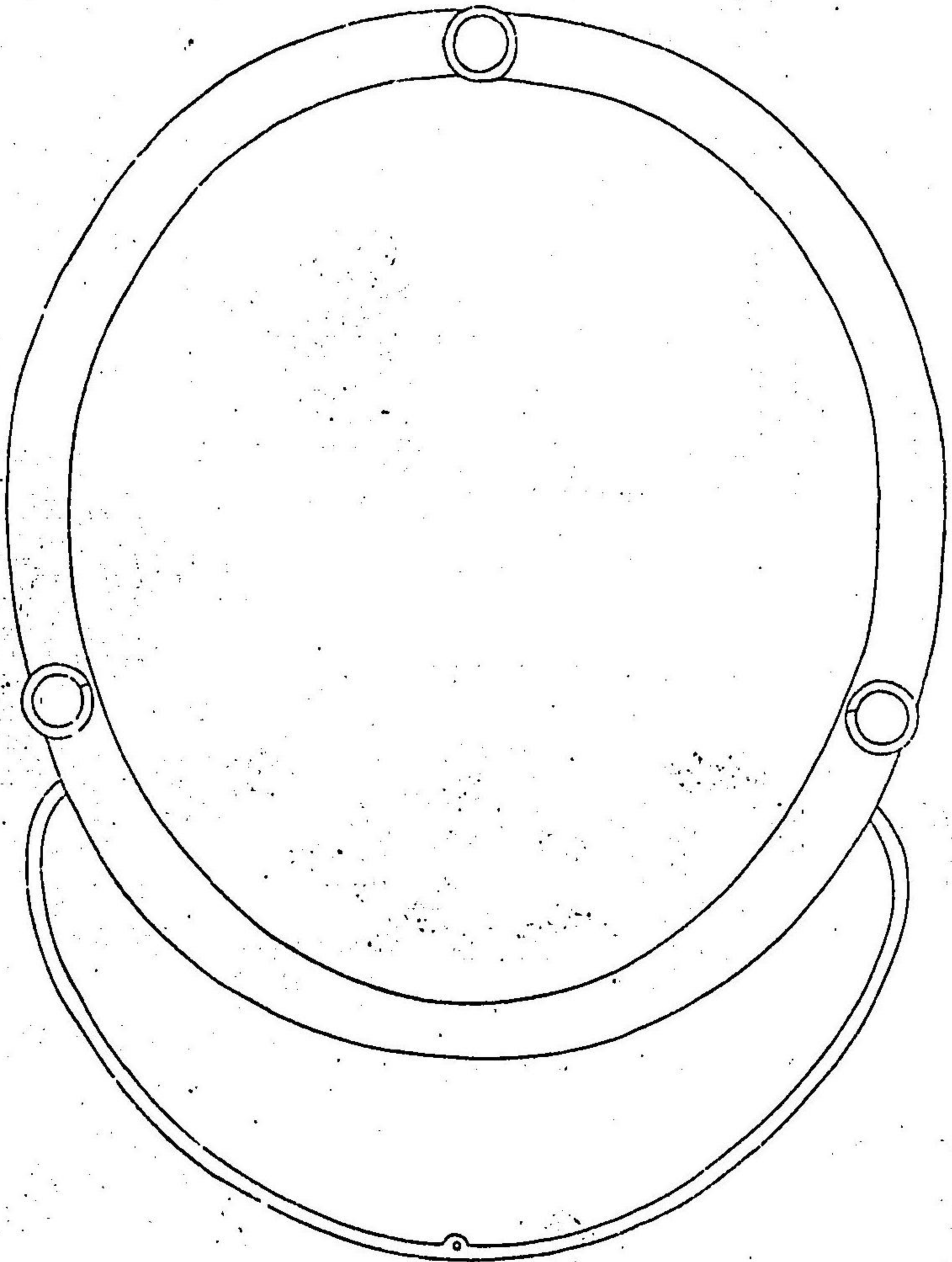

鈔家

袖裏全圖

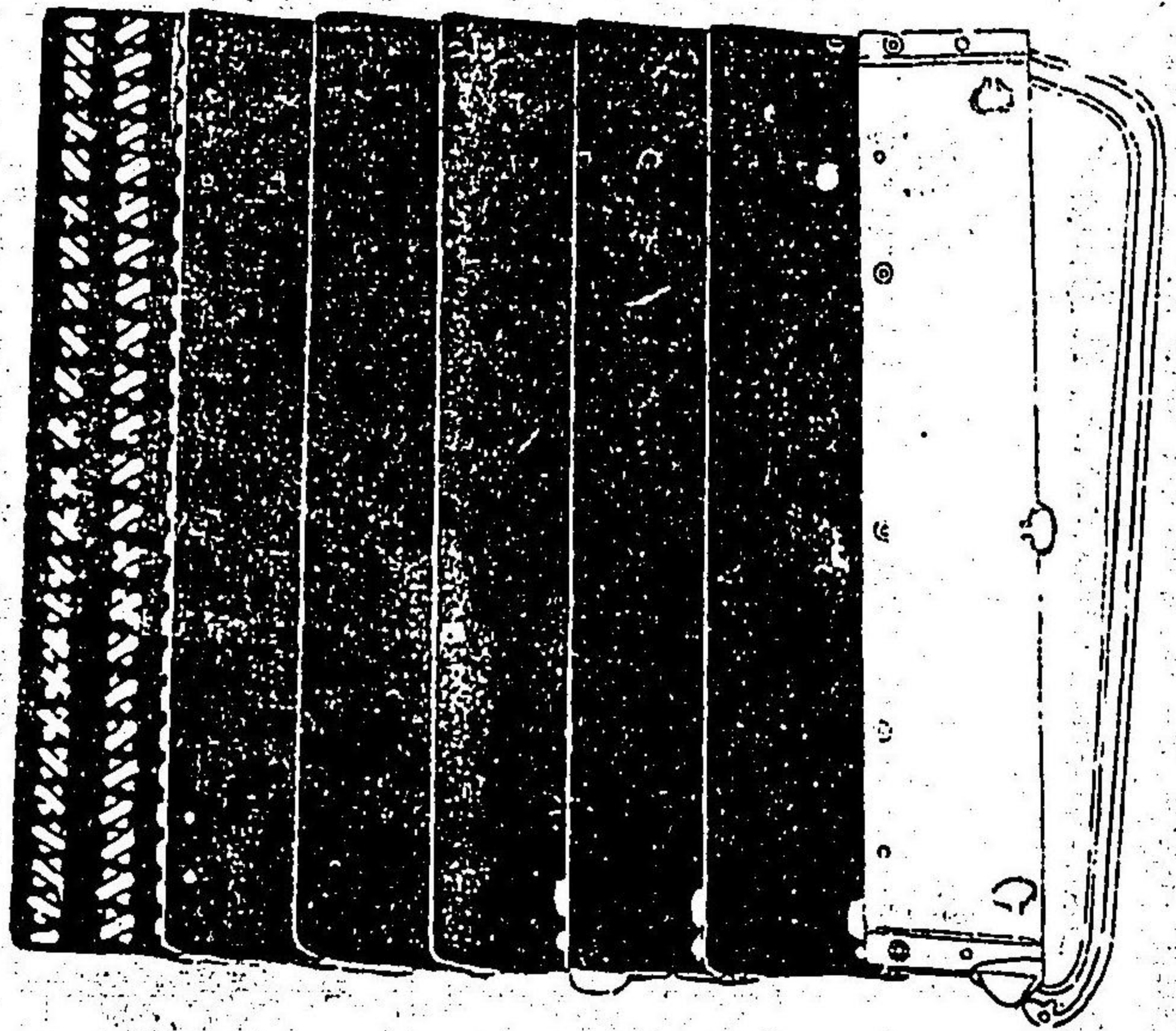

伏組茶臼袖包穿共世世修練

袖全圖

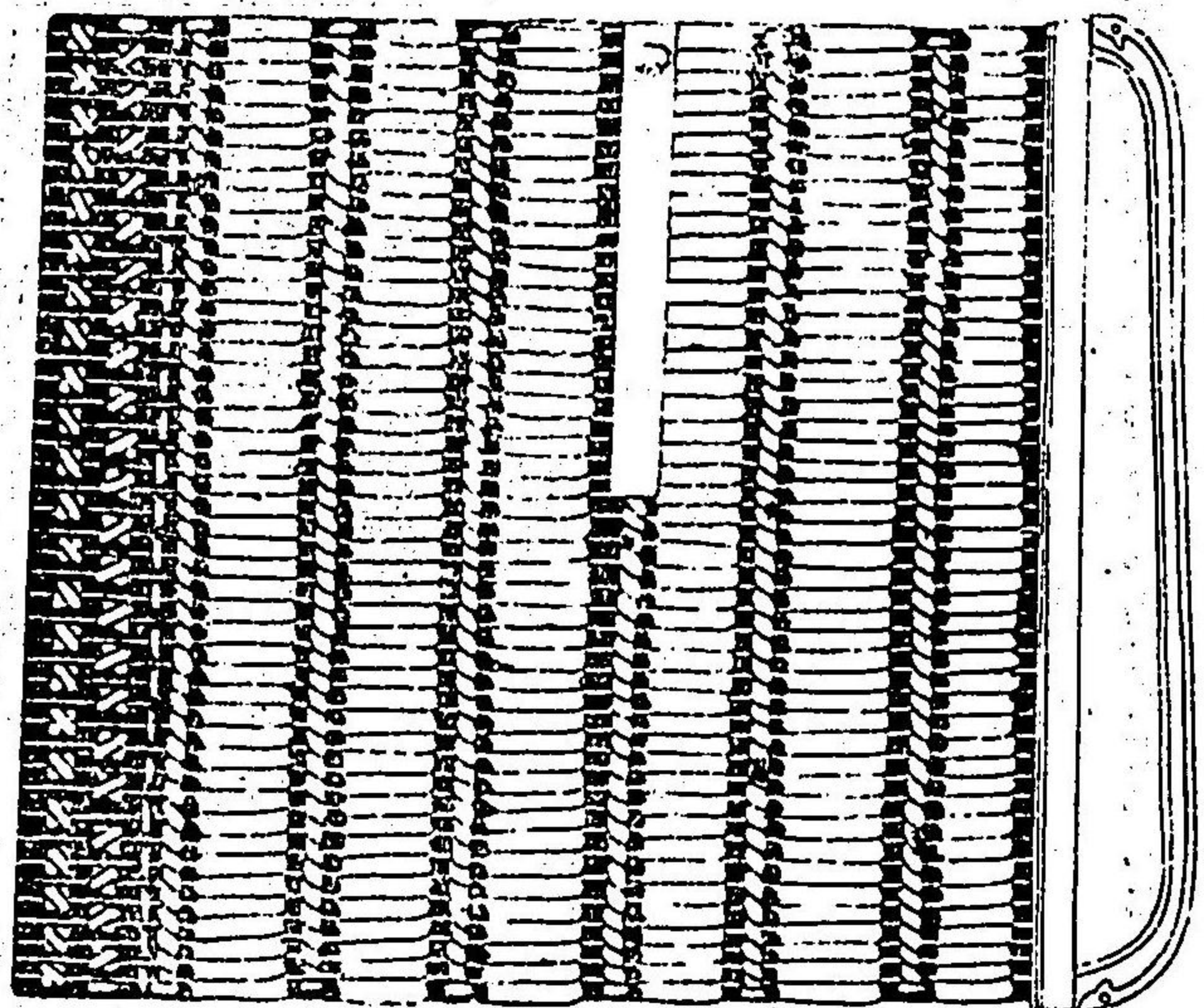

威系凌黄三ノ板敷 月亦睦日後世修補

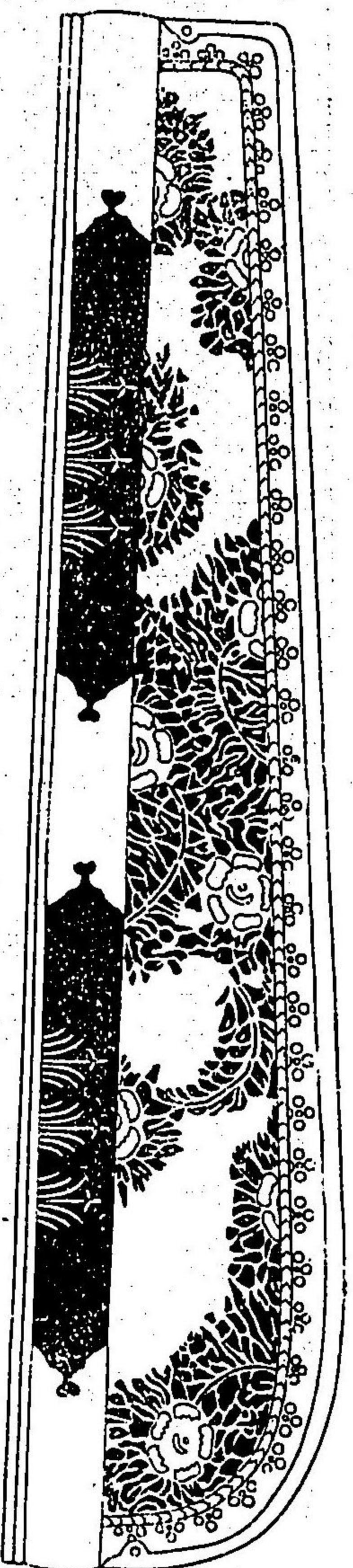

袖冠板 左袖同



并金物



水引
仕掛
袋

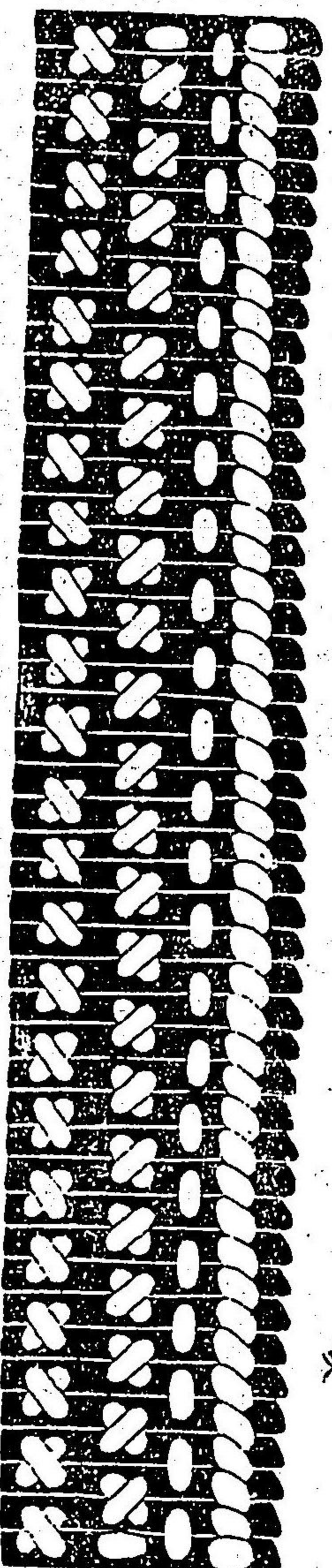

菱縫板

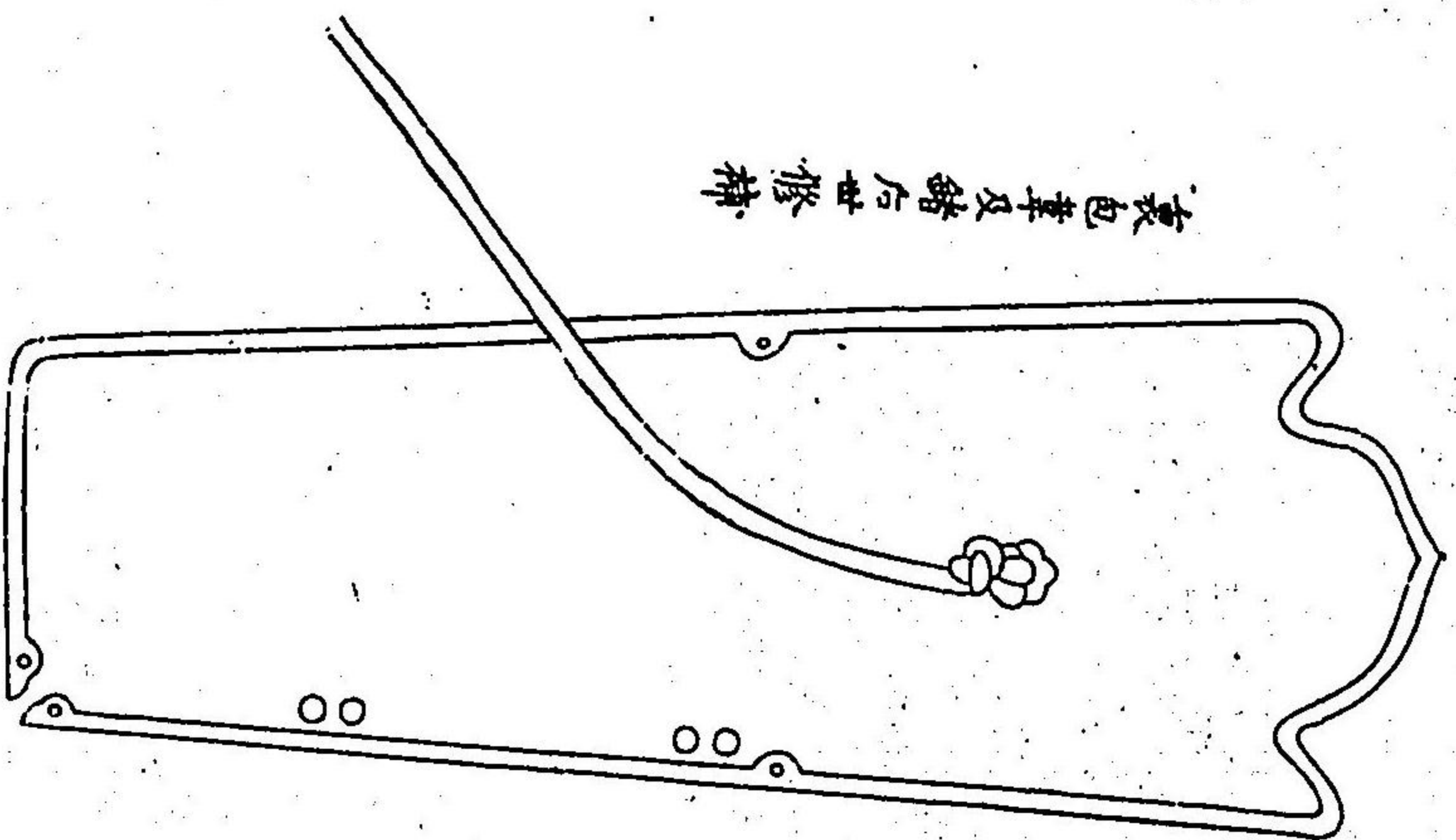

衣包革及緒戶廿修禱

同裏

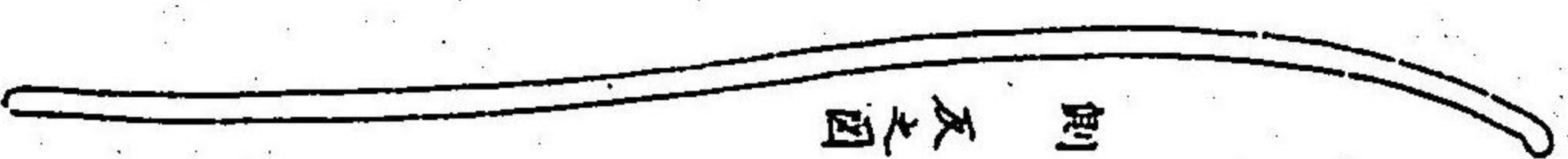

側 及之因

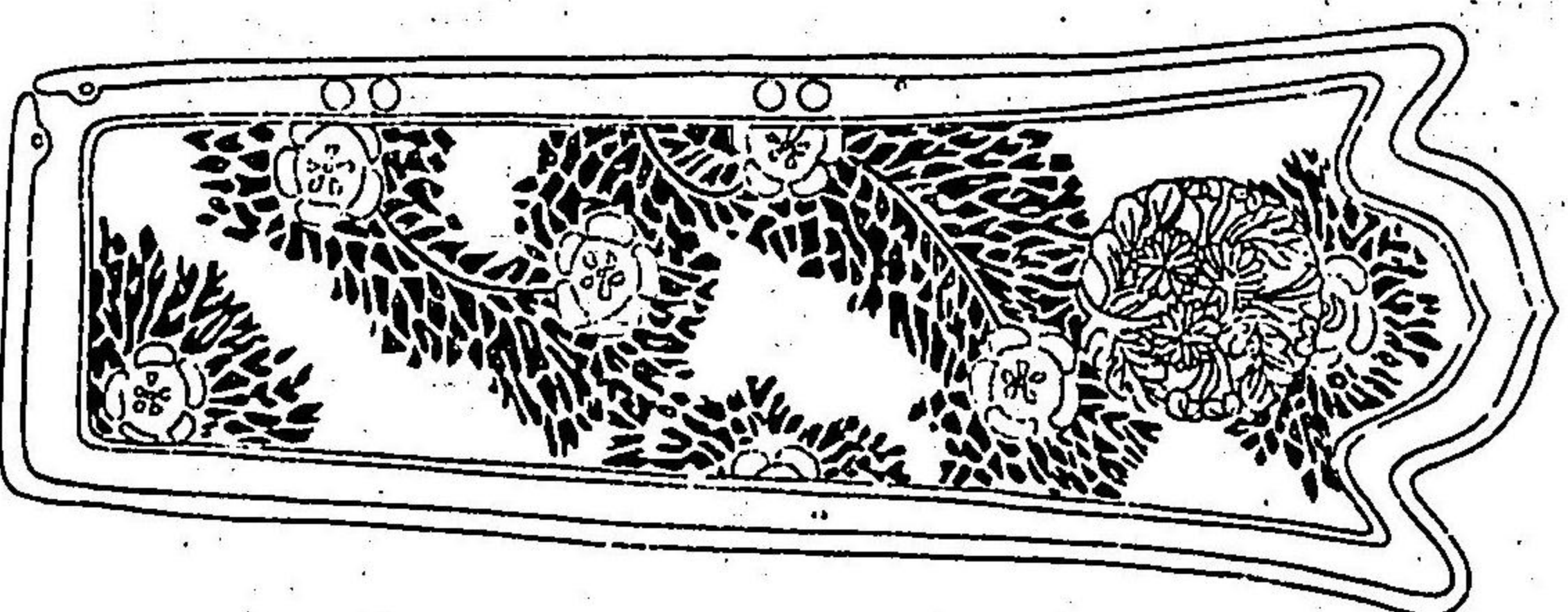

小出輪

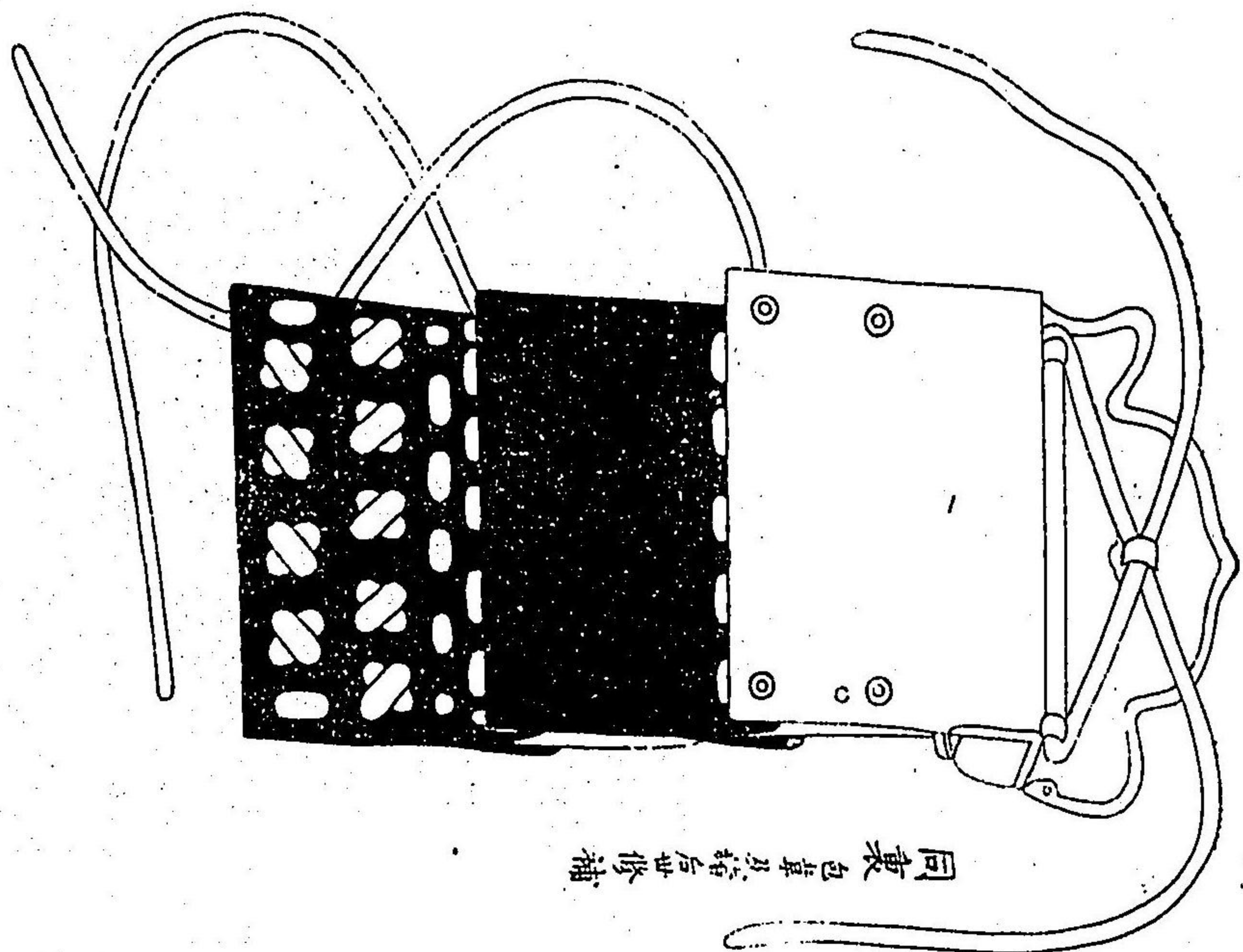

同敷包草及拵后世修補

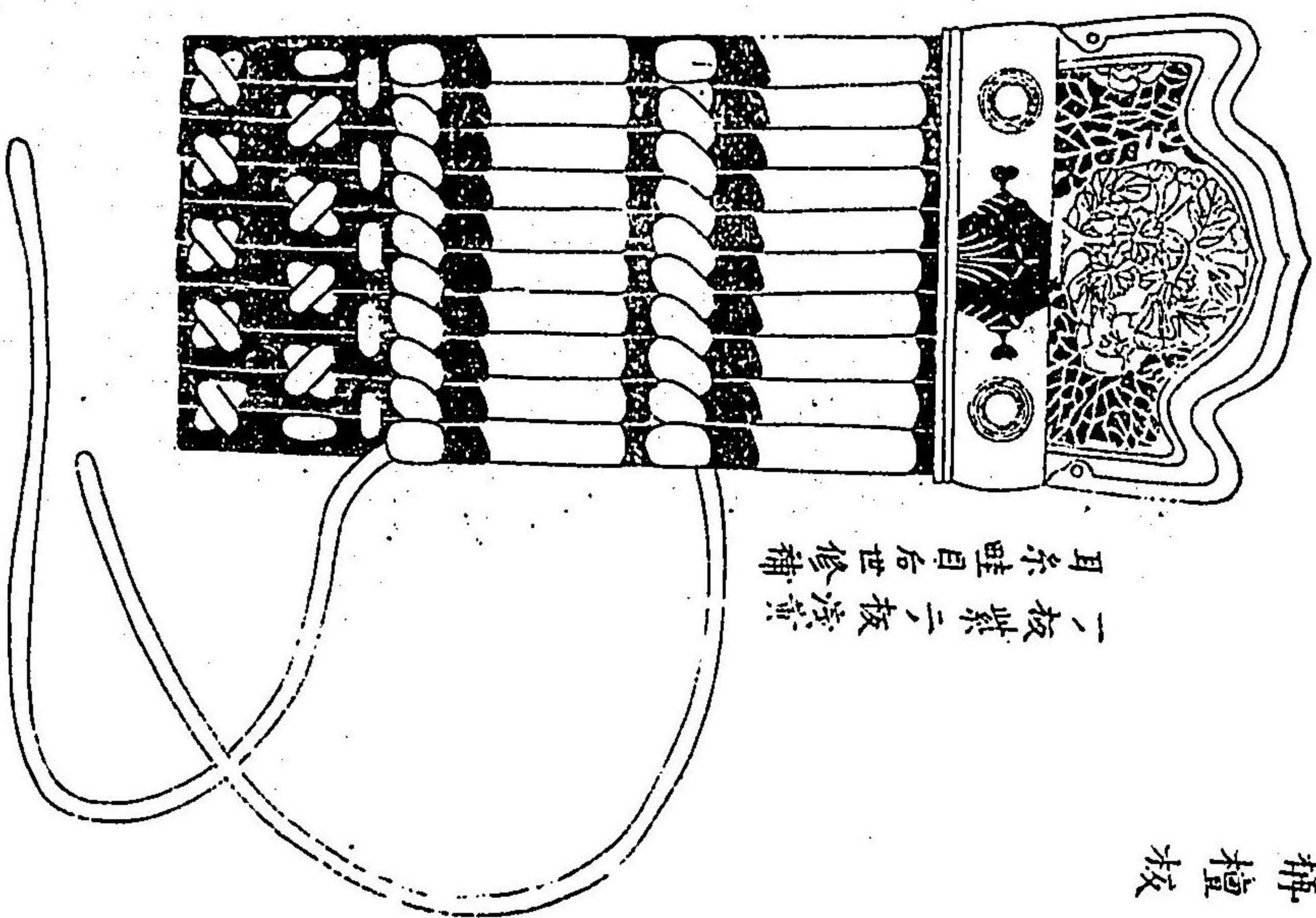

一板紫二板演實
月尔哇目后世修補

稱檀板

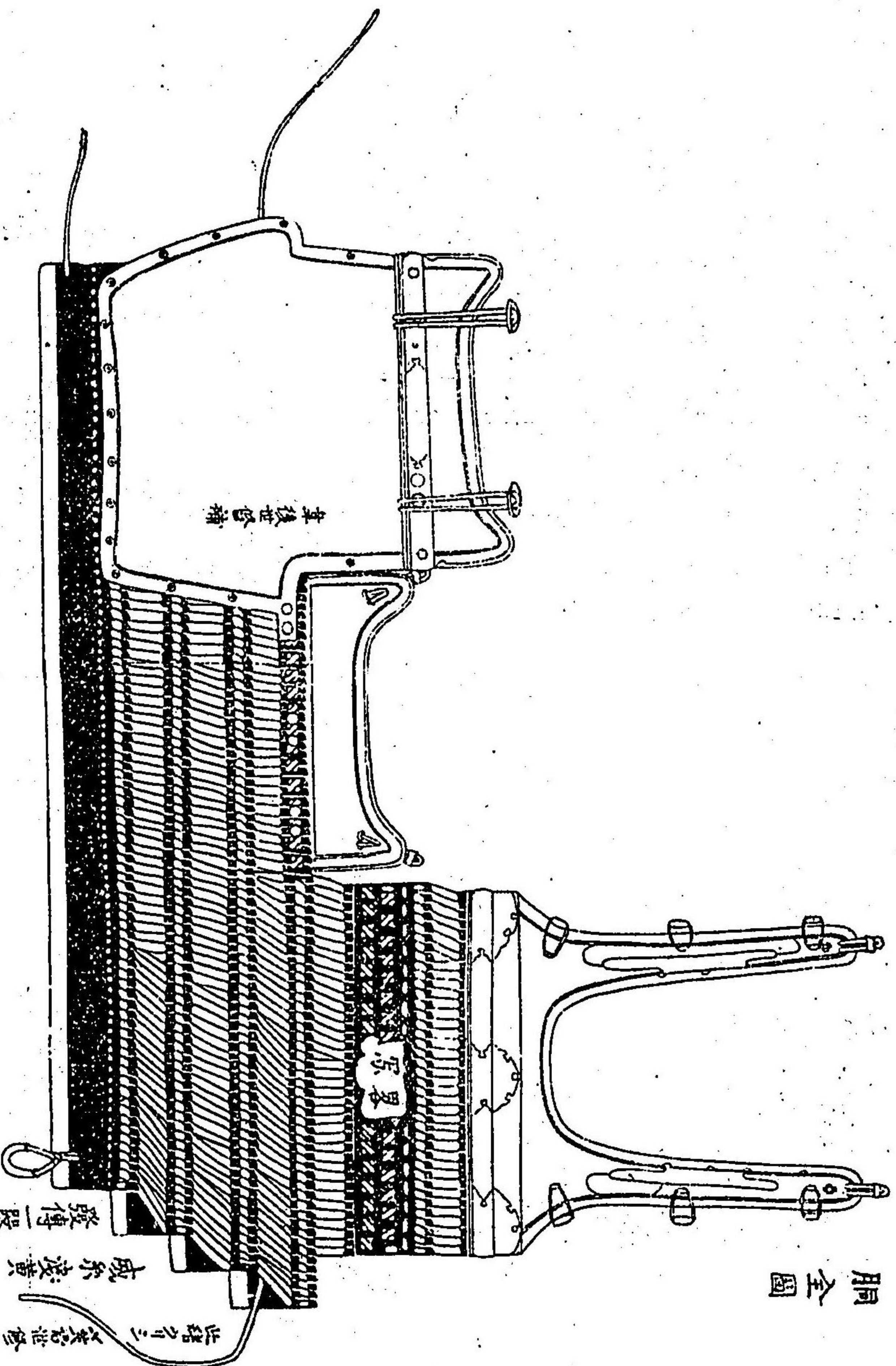

同全圖

此器今以木製成修補

成糸淺黃

發得一段紫

胸板

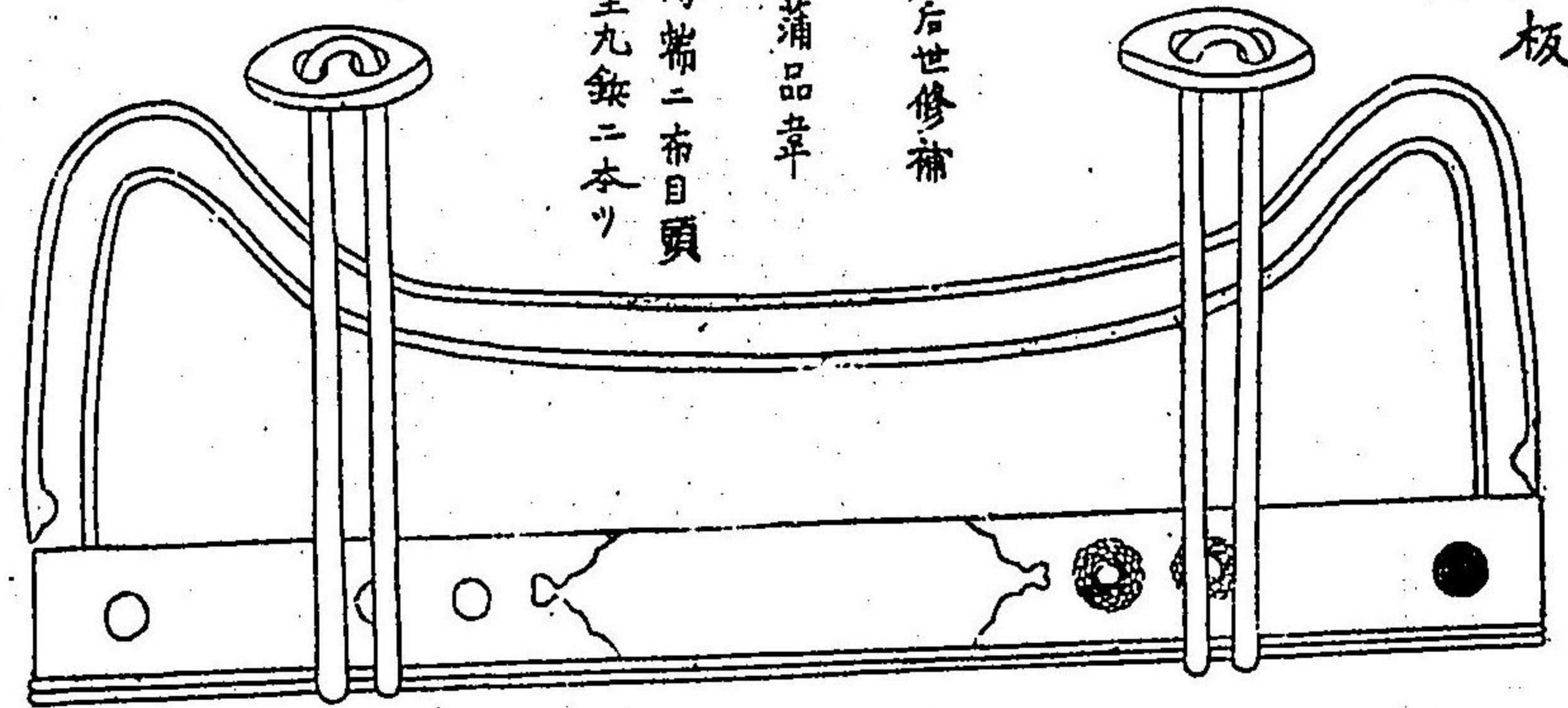

包韋高紐片世修補
袂障菅蒲品韋
八双金物兩端二布目頭
一本ツ、菊聖九鉸二本ツ

射向

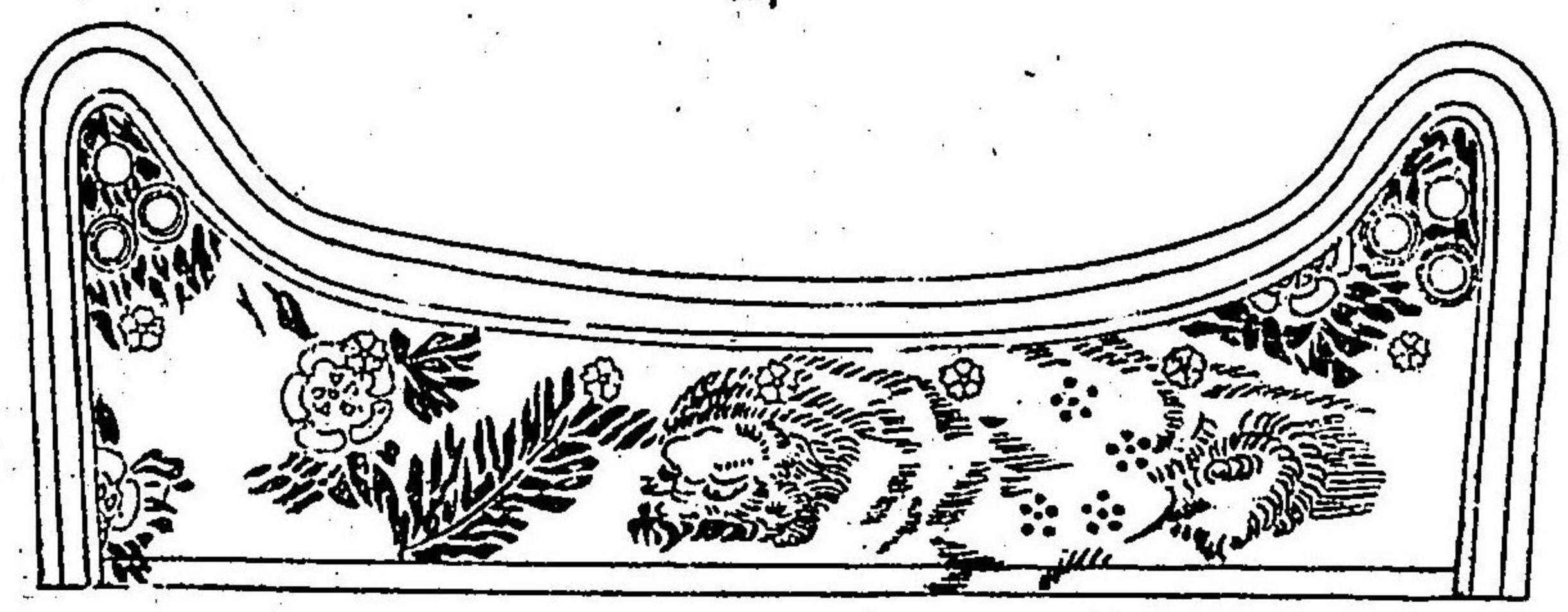

綿噐

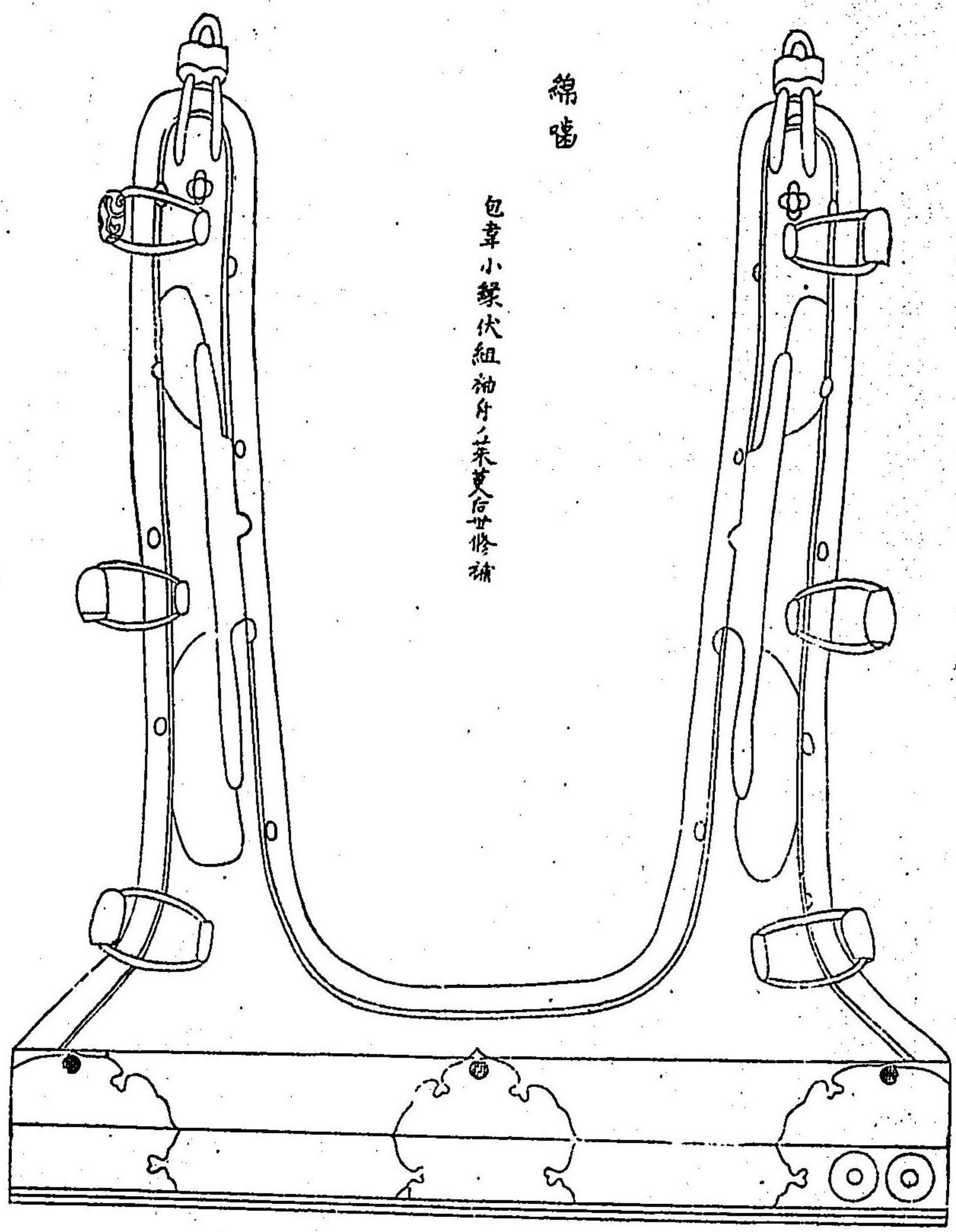

包韋小繫伏組袖片之末更合世修補

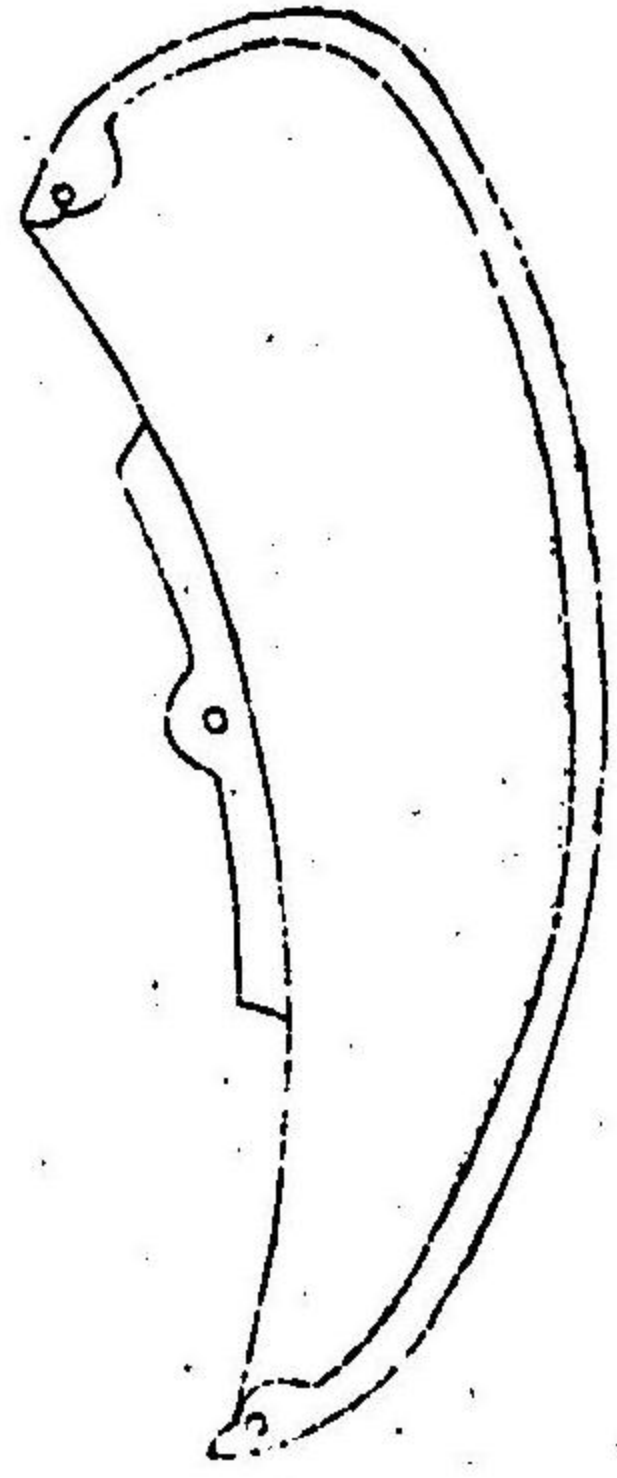

數年石甘修補

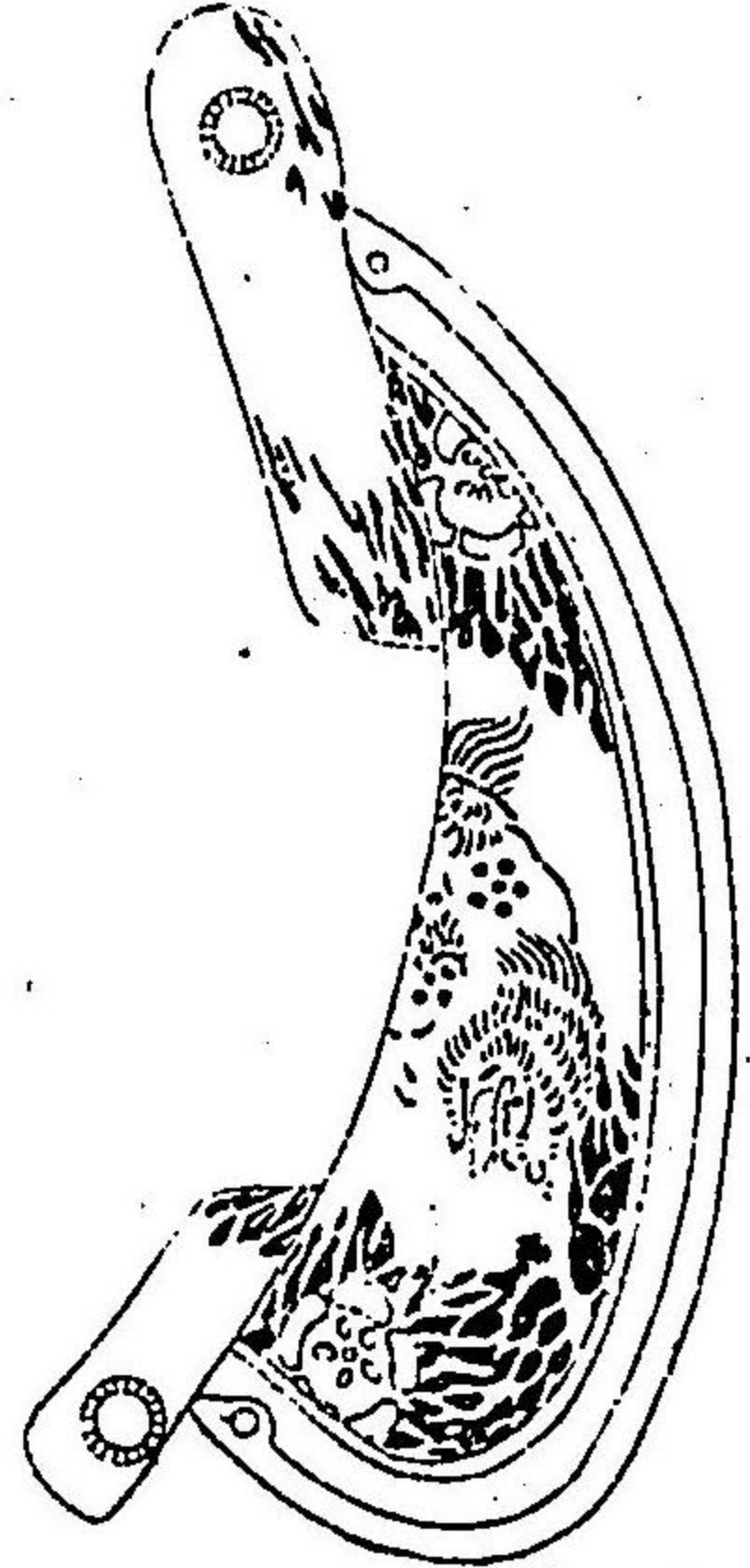

障子板

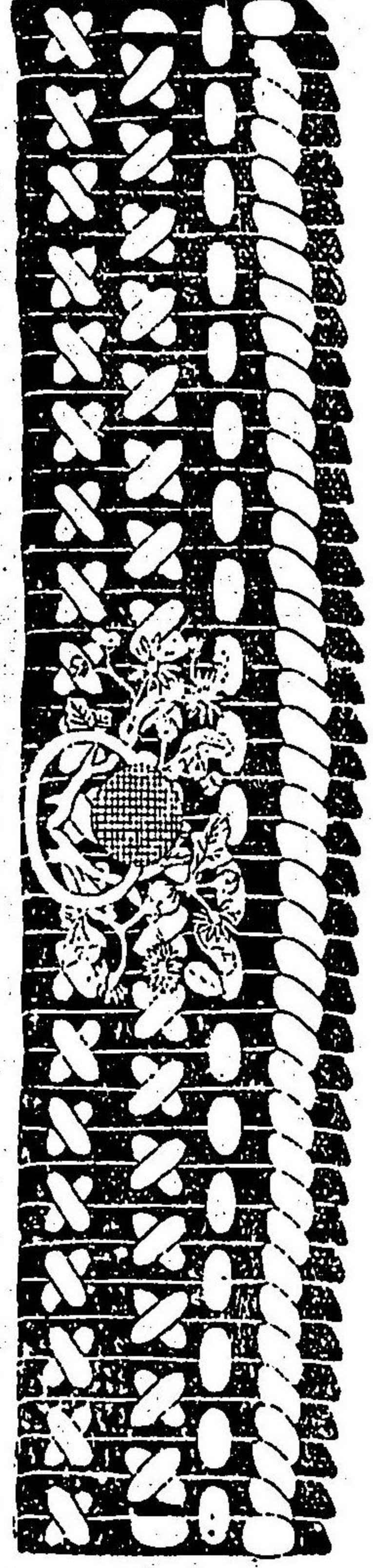

逆板

前草履全圖

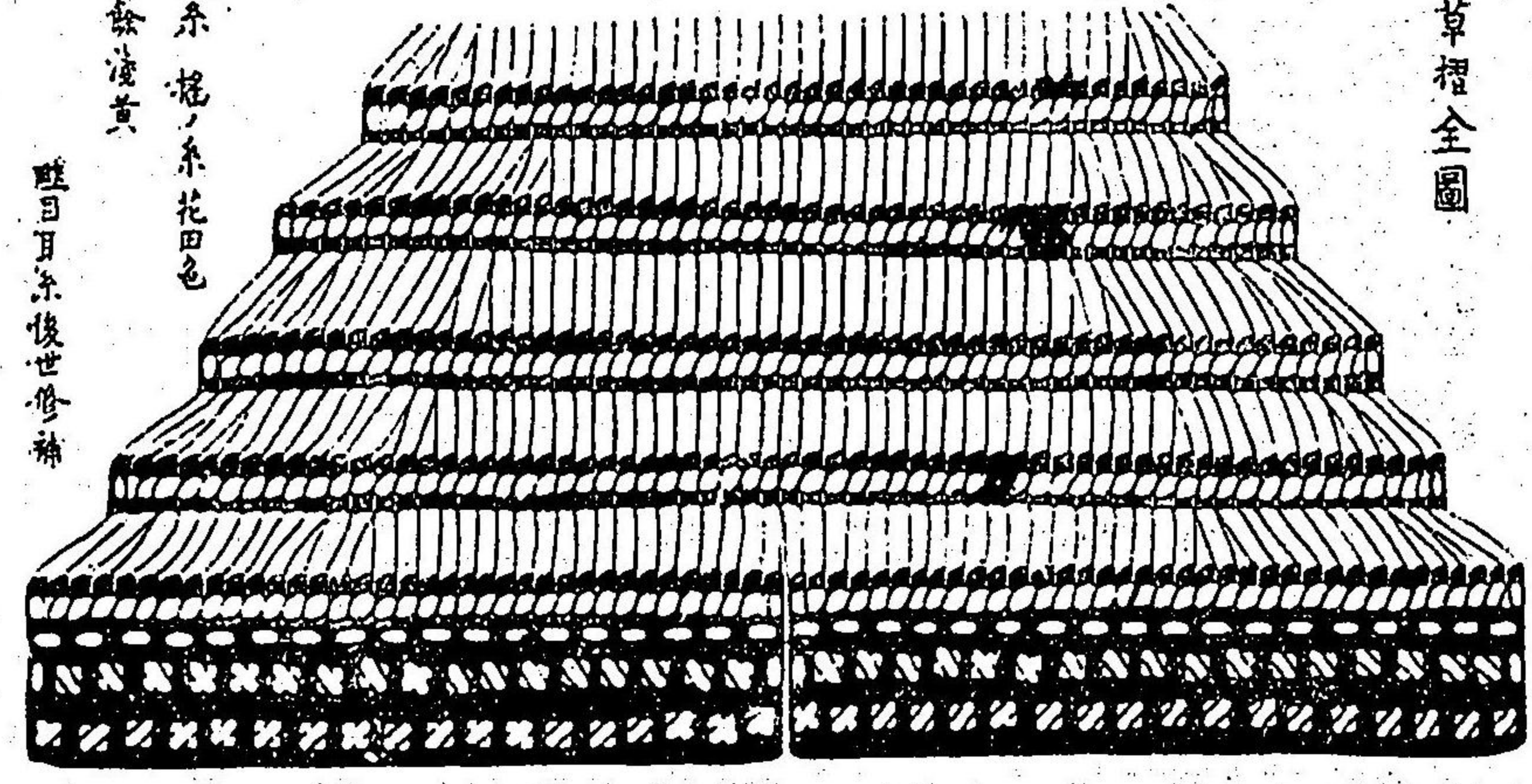

威赤 提ノ糸花田色
其條淺黃

雖百月糸後世修補

同裏全圖

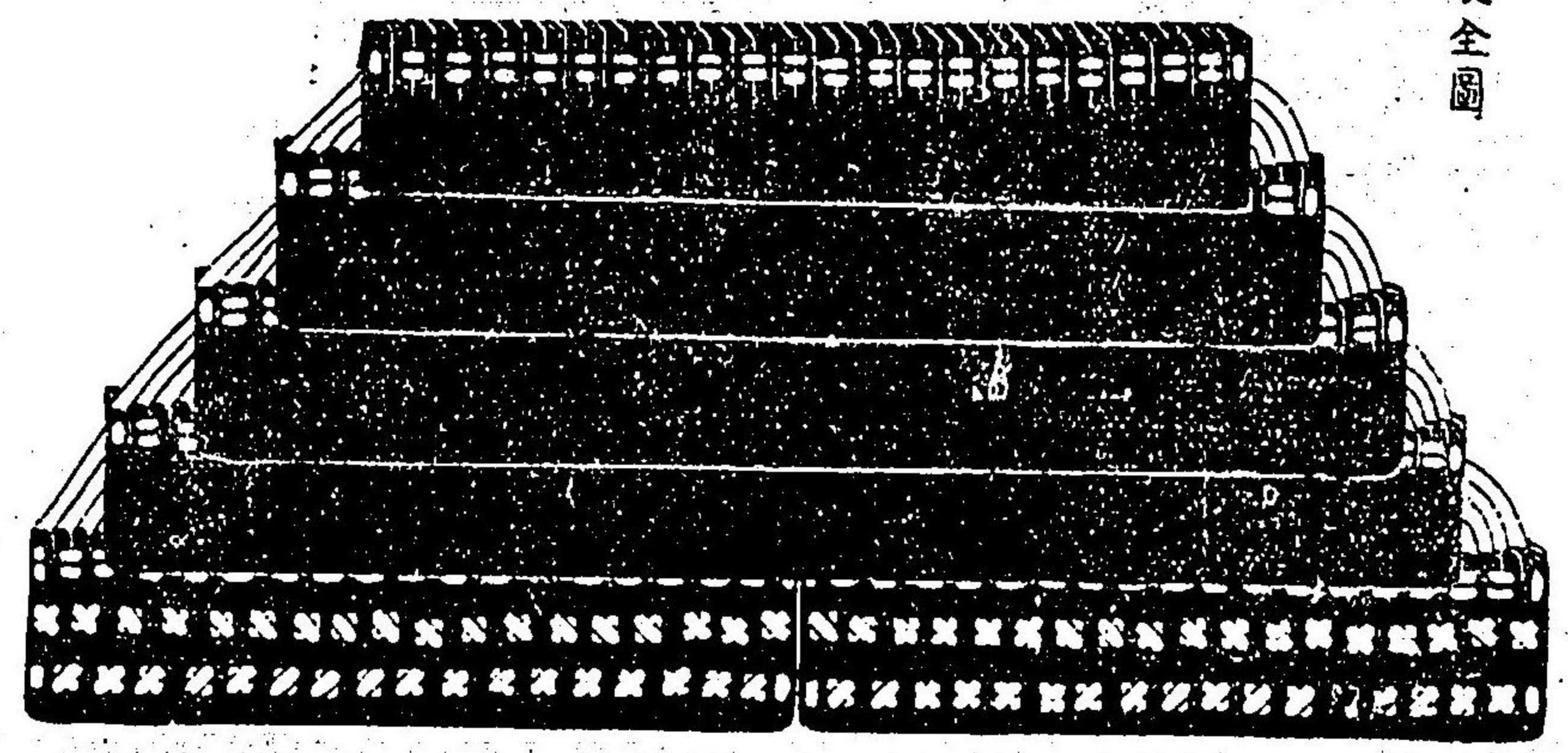

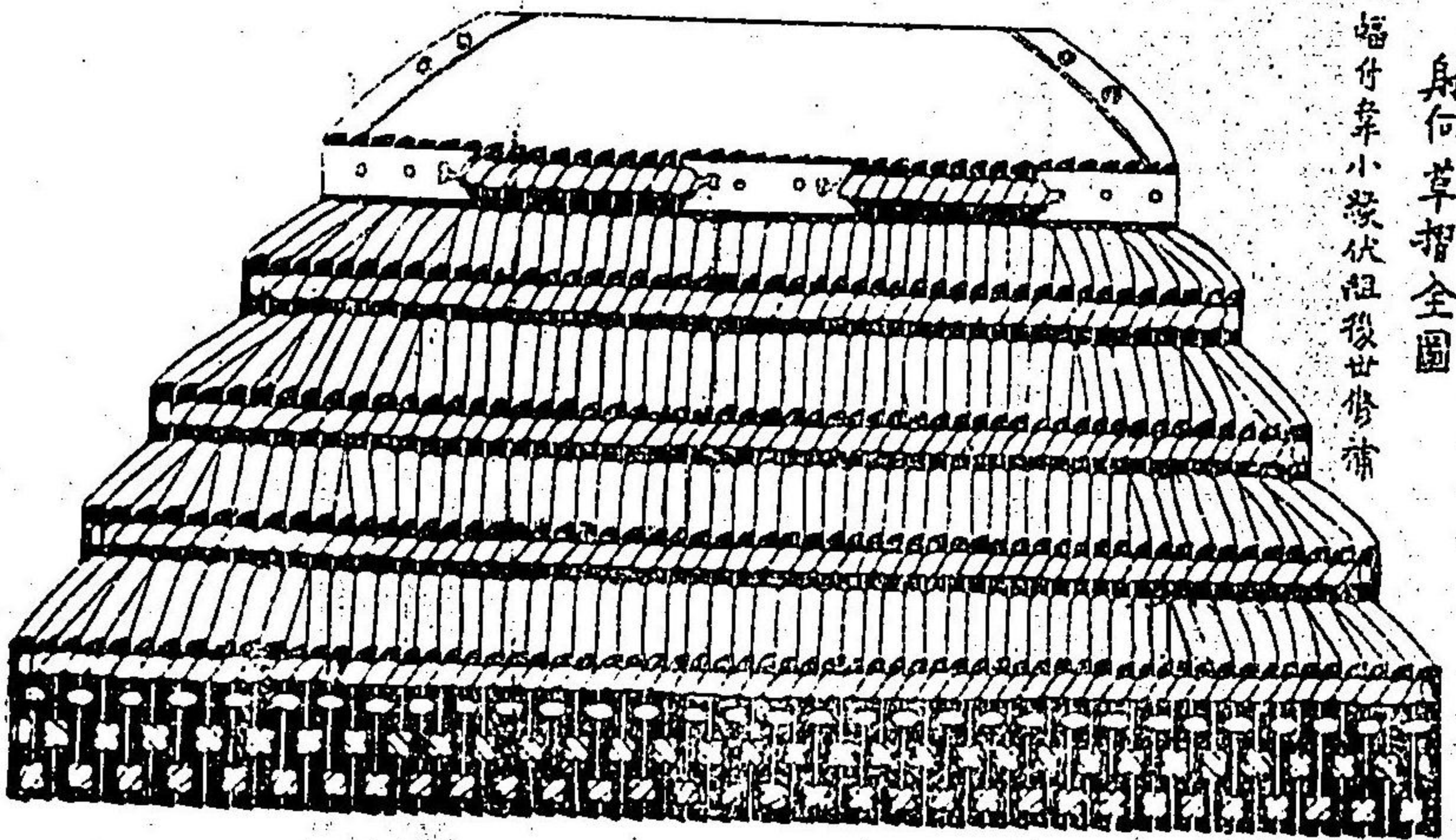

射向草摺全圖
編幅竹韋小段伏組後世修補

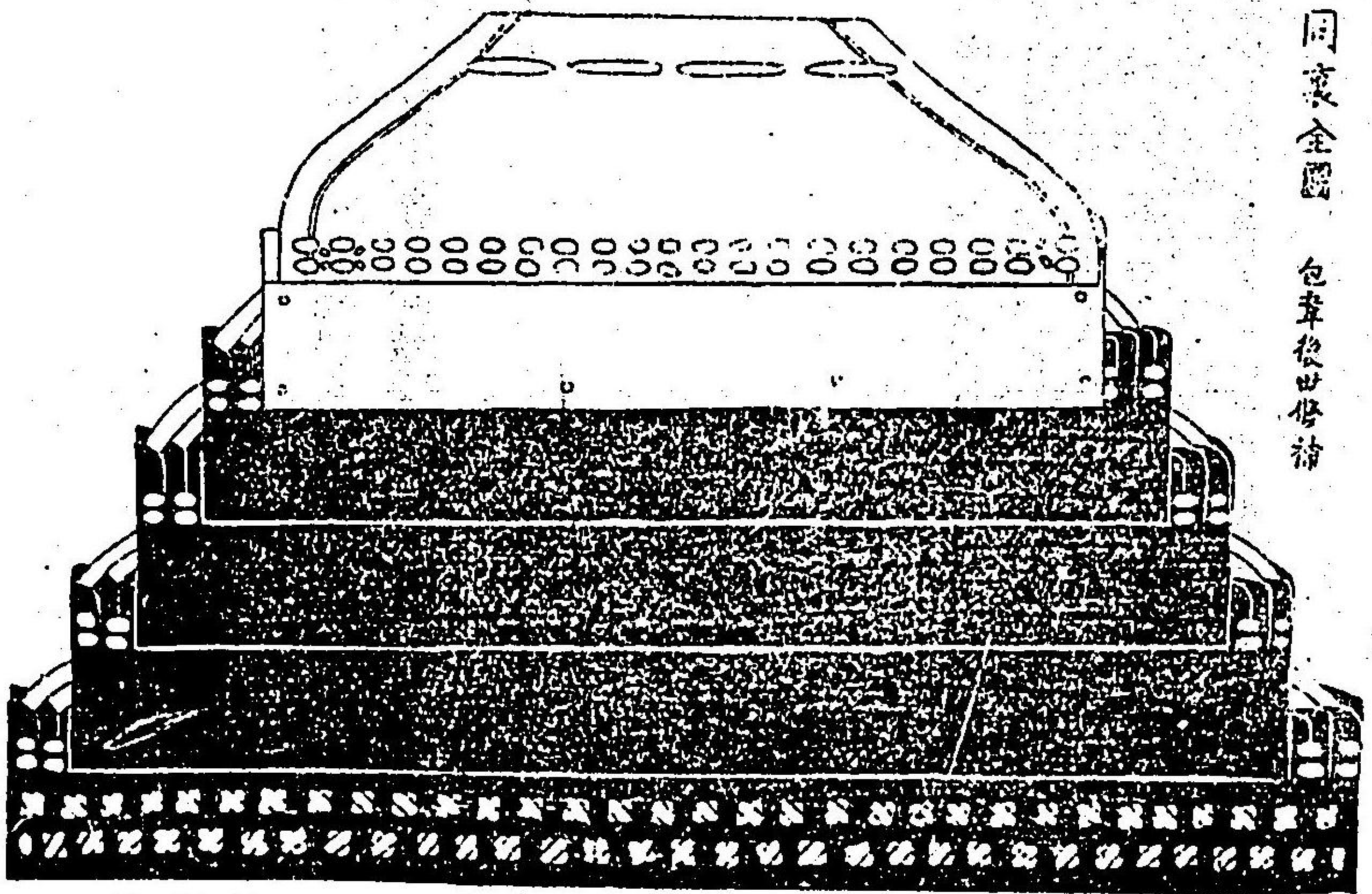

同裝全圖
包韋後世修補



中央

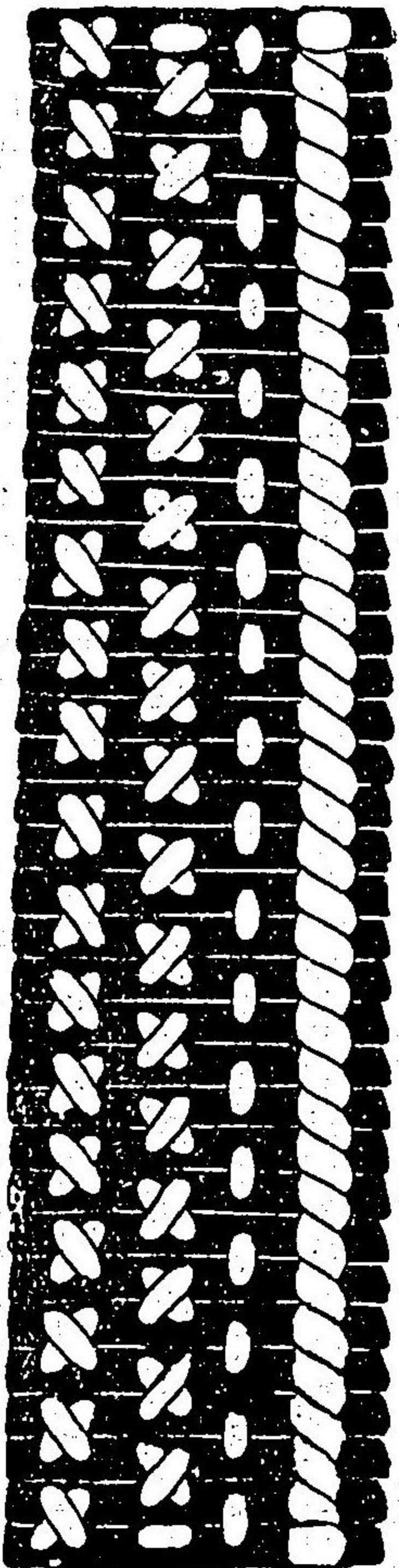

中央

同裝鐵板

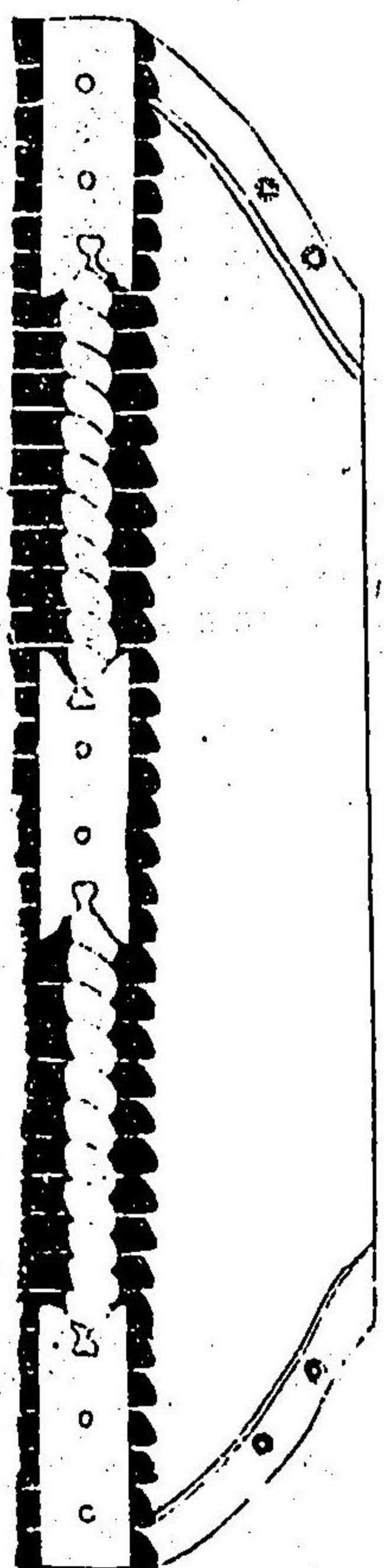

弓矢車摺輪蟬討

同菱鏡板

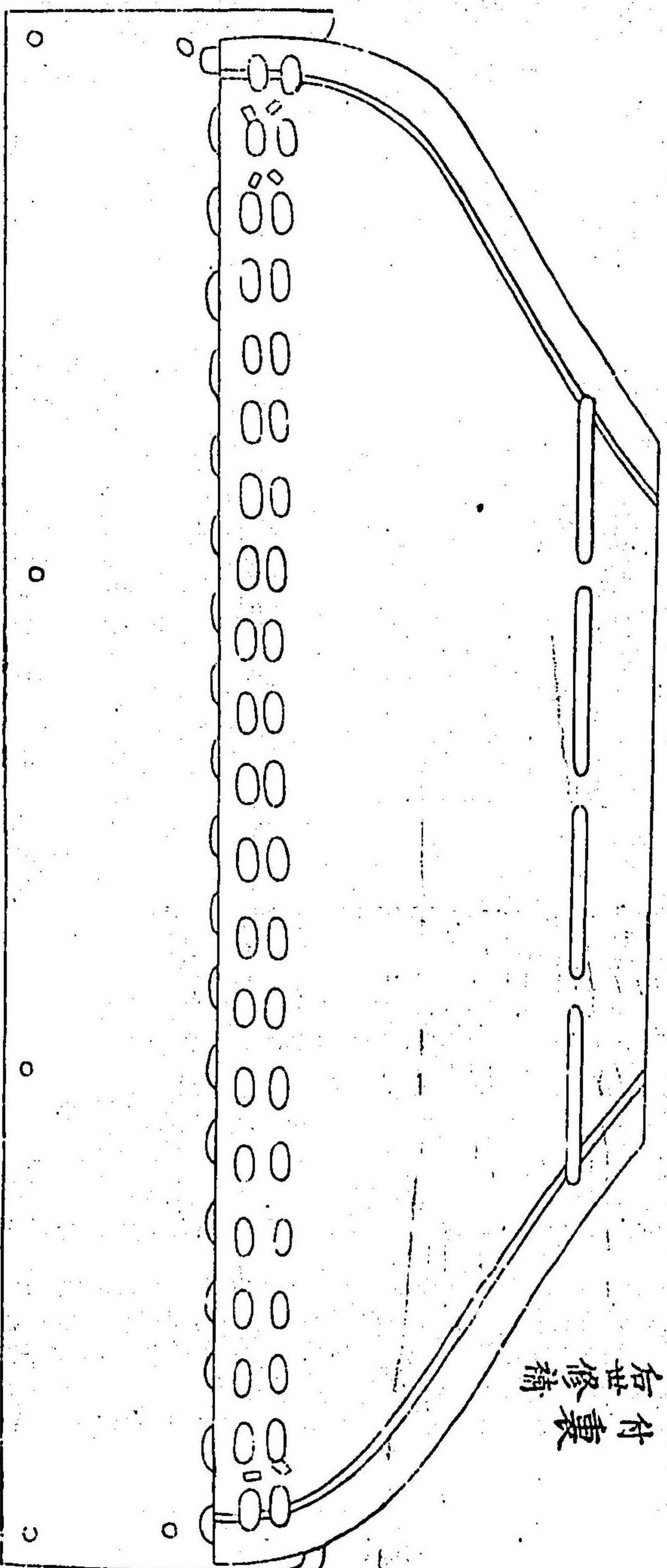
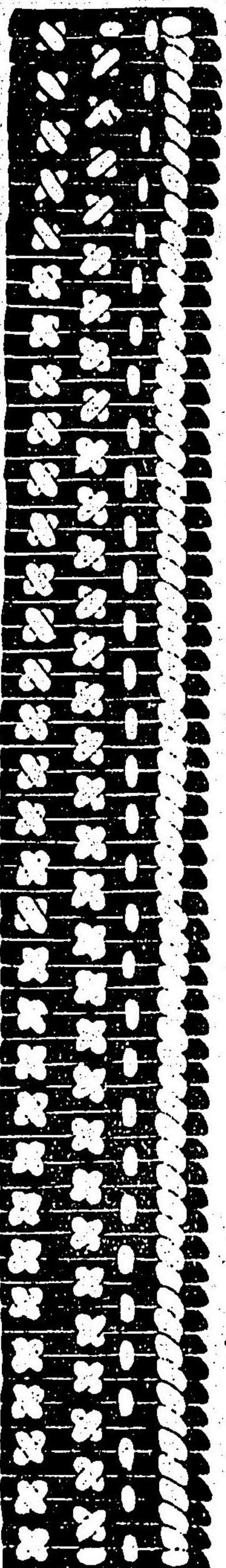

同蟬蝠付裏
右世修補

脇指全圖

一ノ板紫糸其餘淺黄
睦目耳糸後世修補

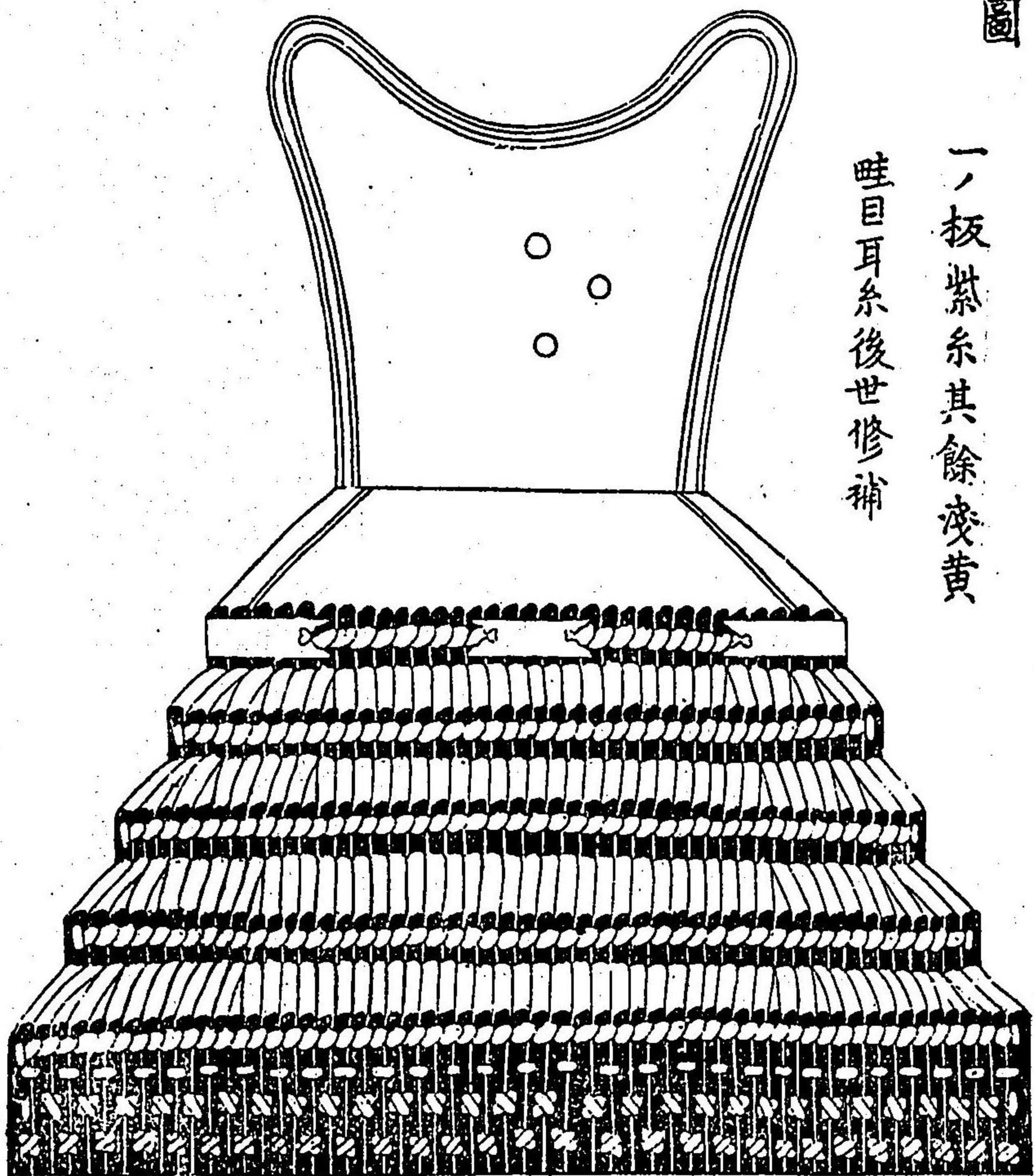

脇指

水銀白刺茶

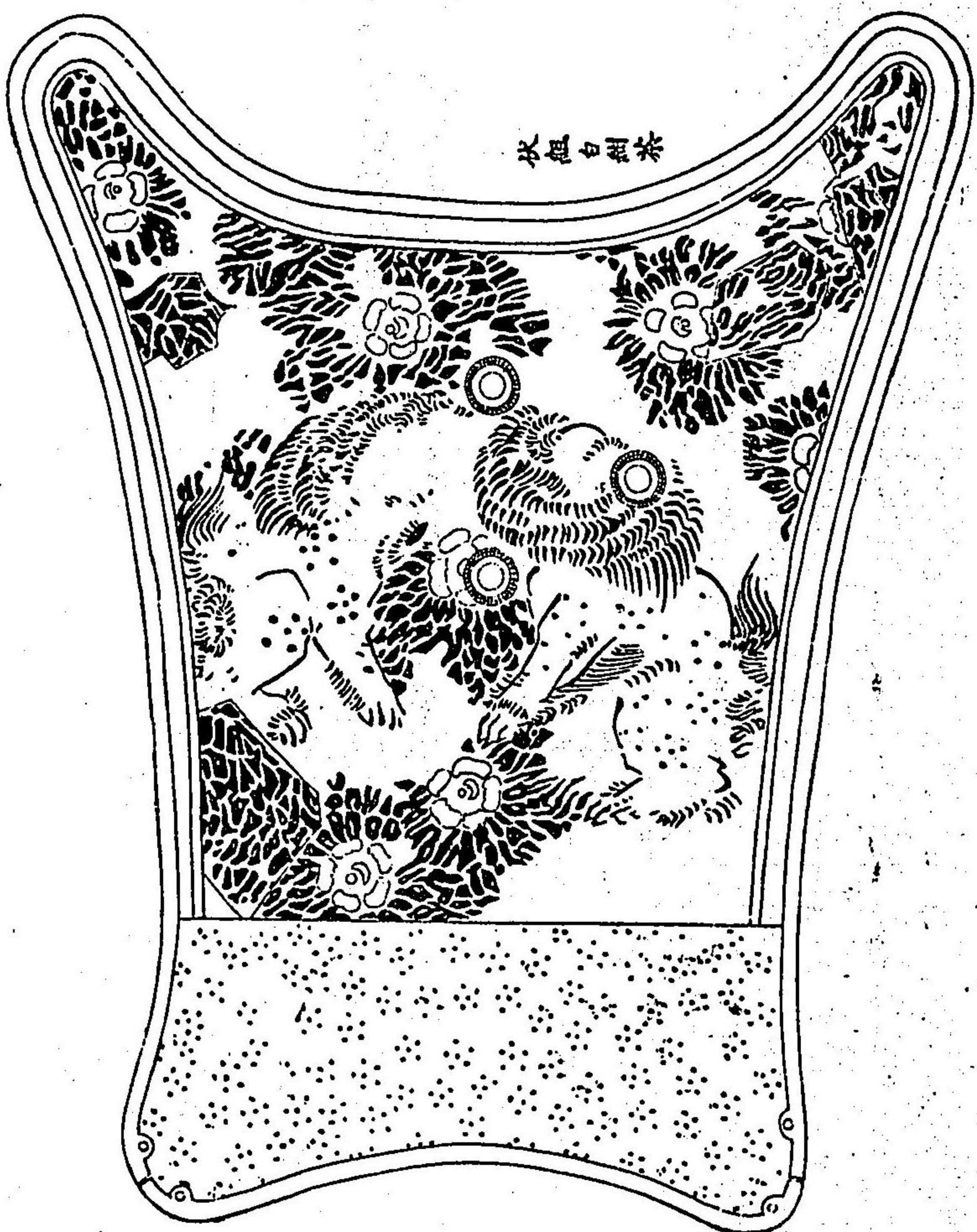

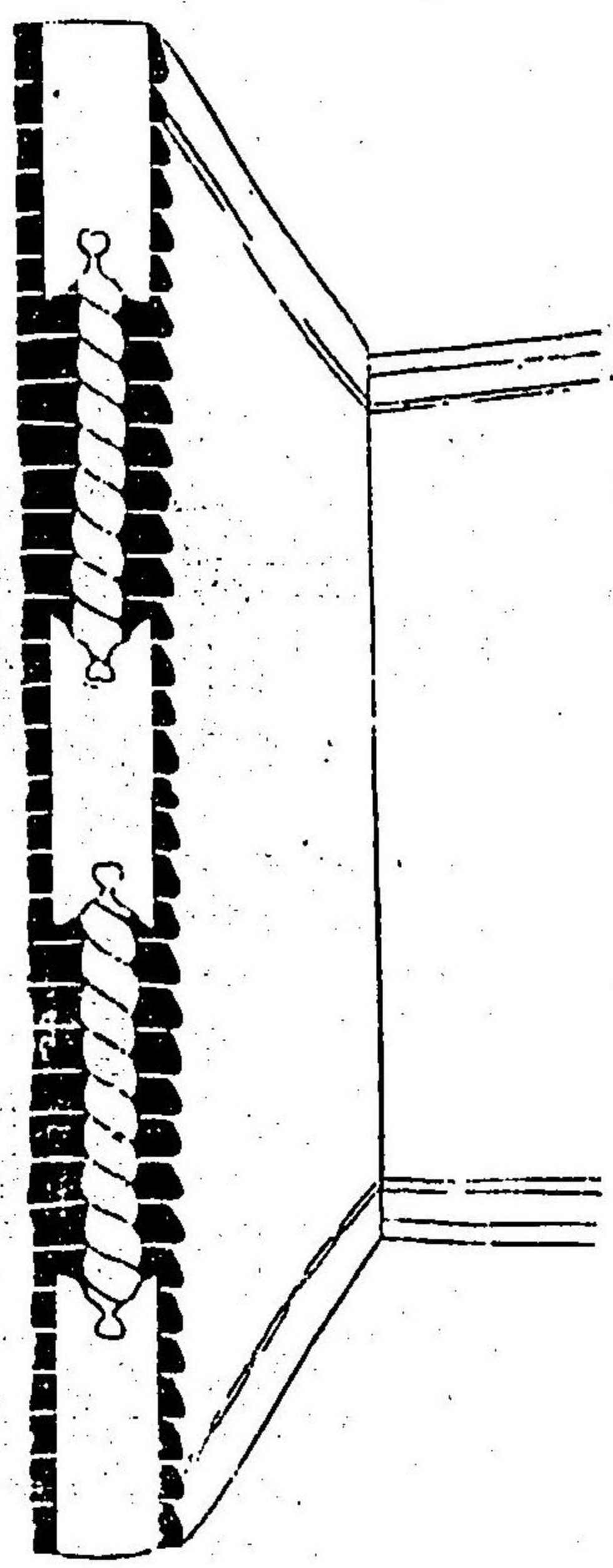

馬首草摺編幅付

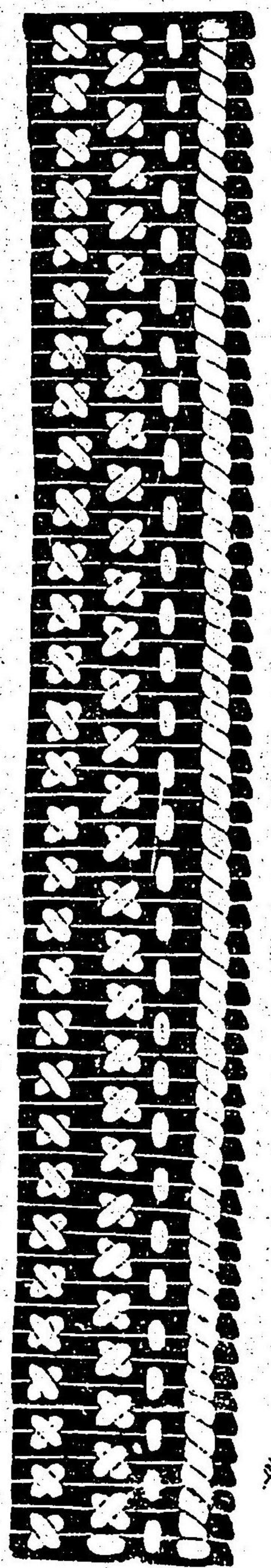

馬首草摺衣捷板

脇楯裏全圖

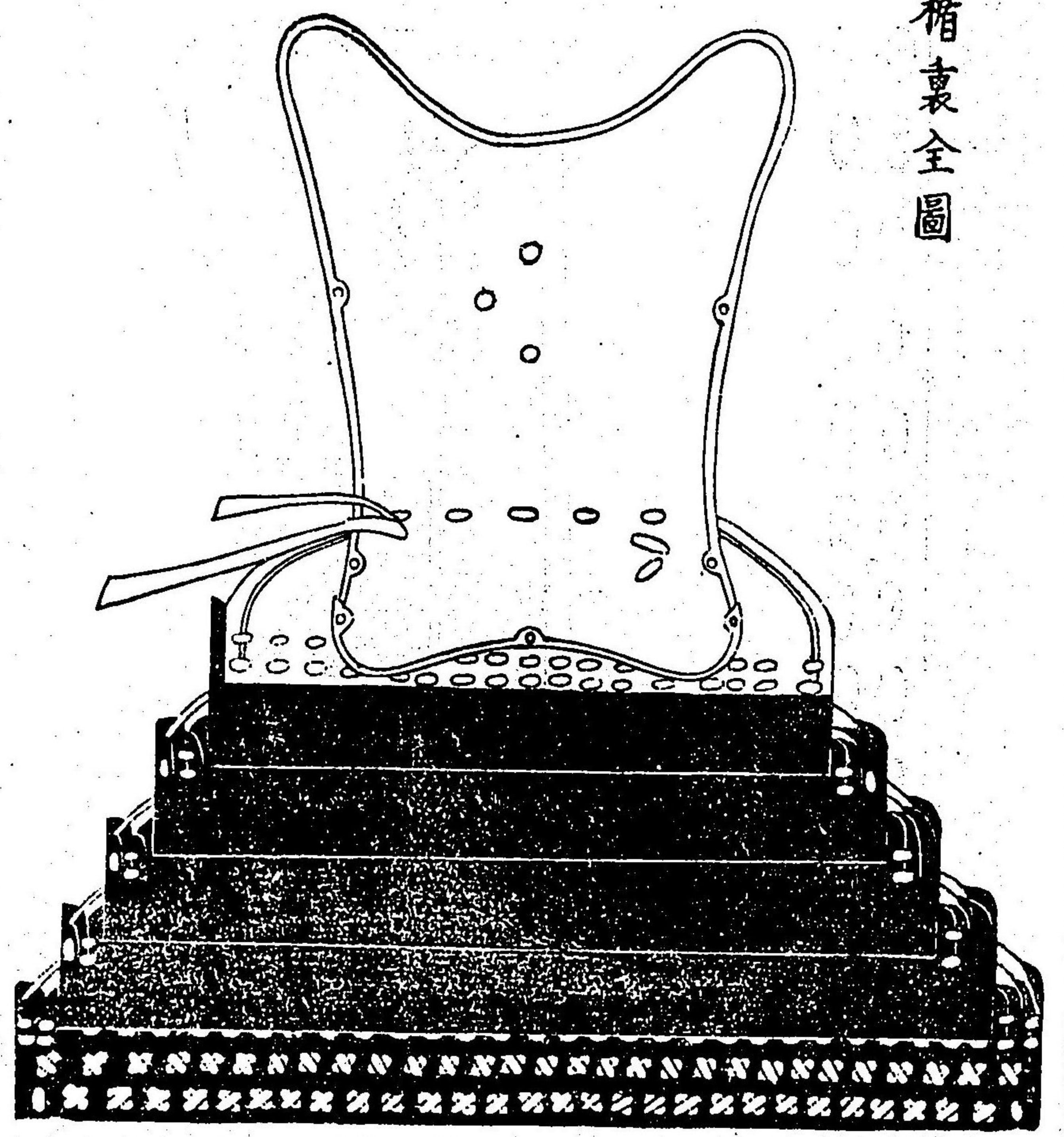

裏弓壺板ノ反シクニ圖

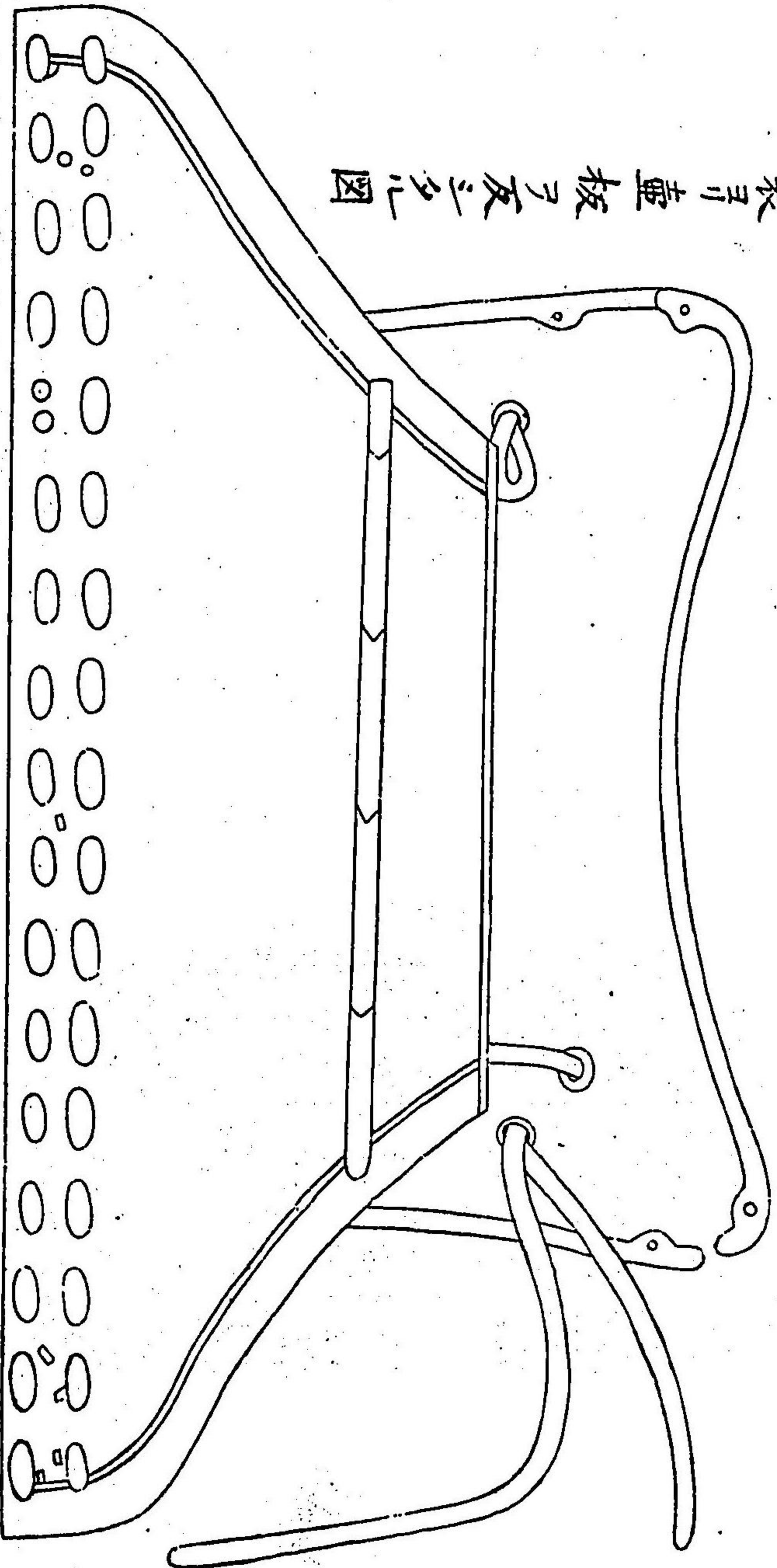

大和國藤原山法貴寺實相院藏腹卷及袖圖

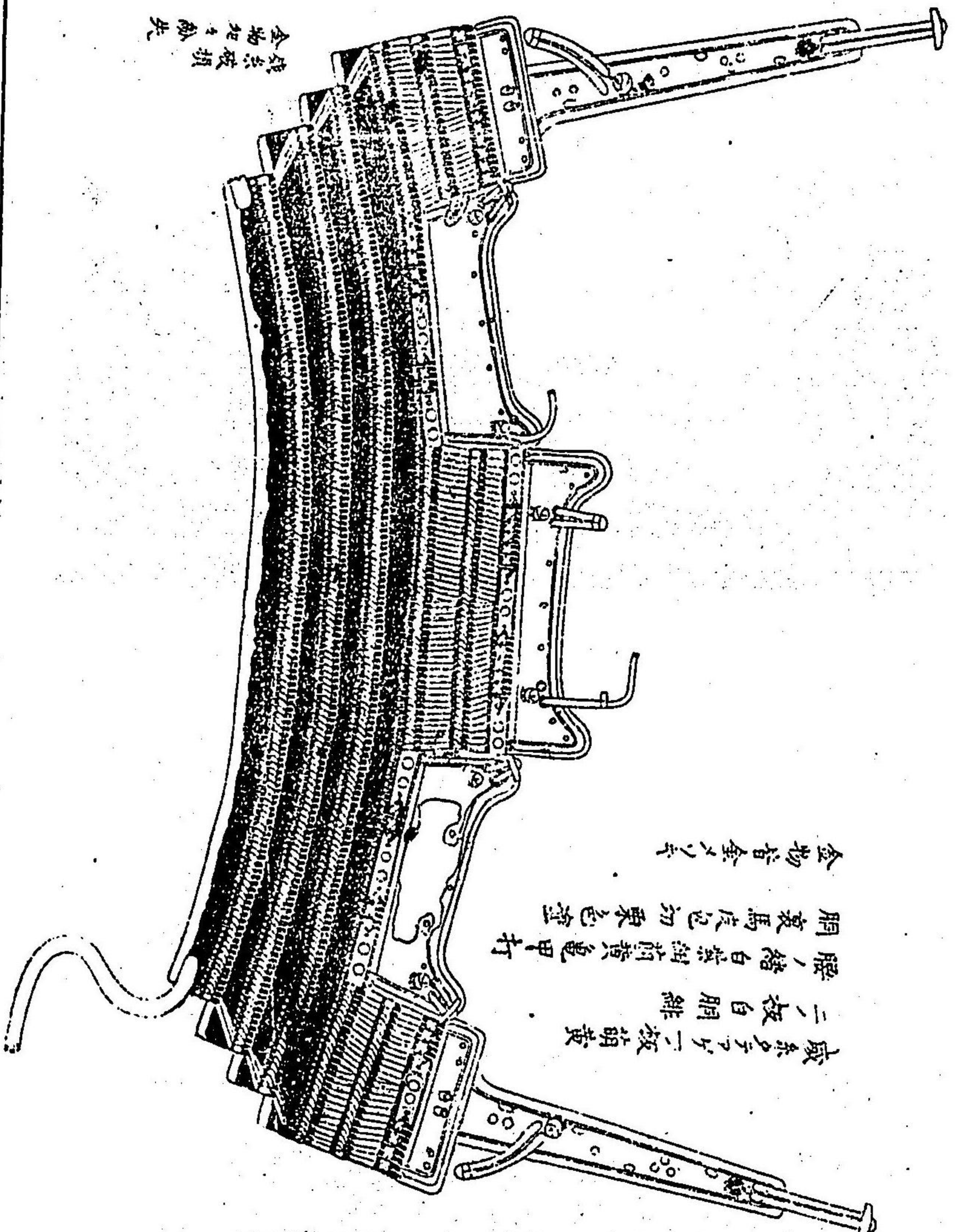

威多クヲ以テ二板明黃
二板白胴 緋
腰ノ緒白紫紺筒黃也甲打
胴裏馬皮也切栗色塗
金物皆金メノキ

錢糸破損
金物短キ餘矢

胸板

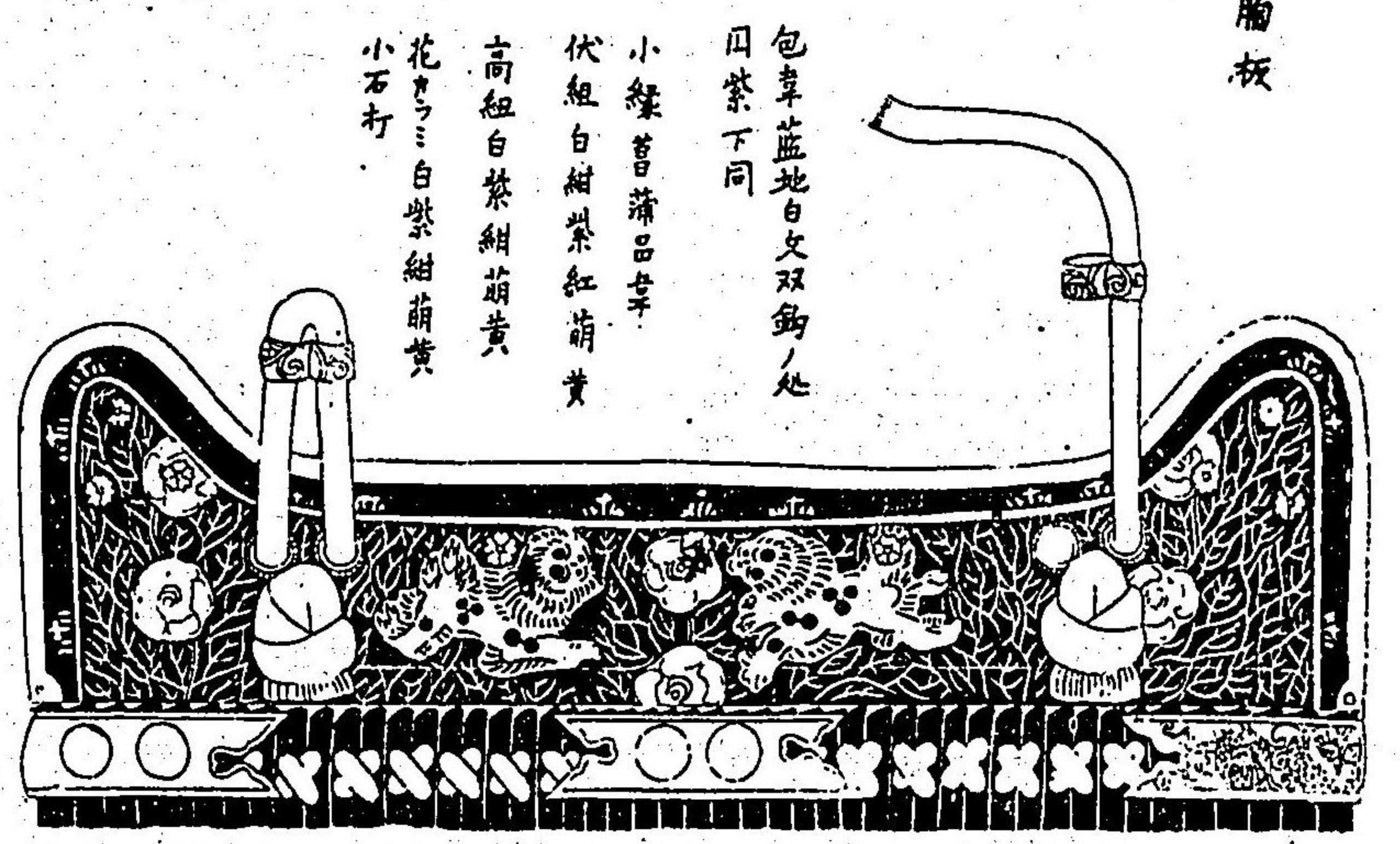

包韋藍地白文双鈎ノ処
同紫下同
小綠菅蒲呂等
伏組白紺紫紅萌黃
高紐白紫紺胡黃
花々々々白紫紺萌黃
小石打

高紐ノ請緒ニ同

射向

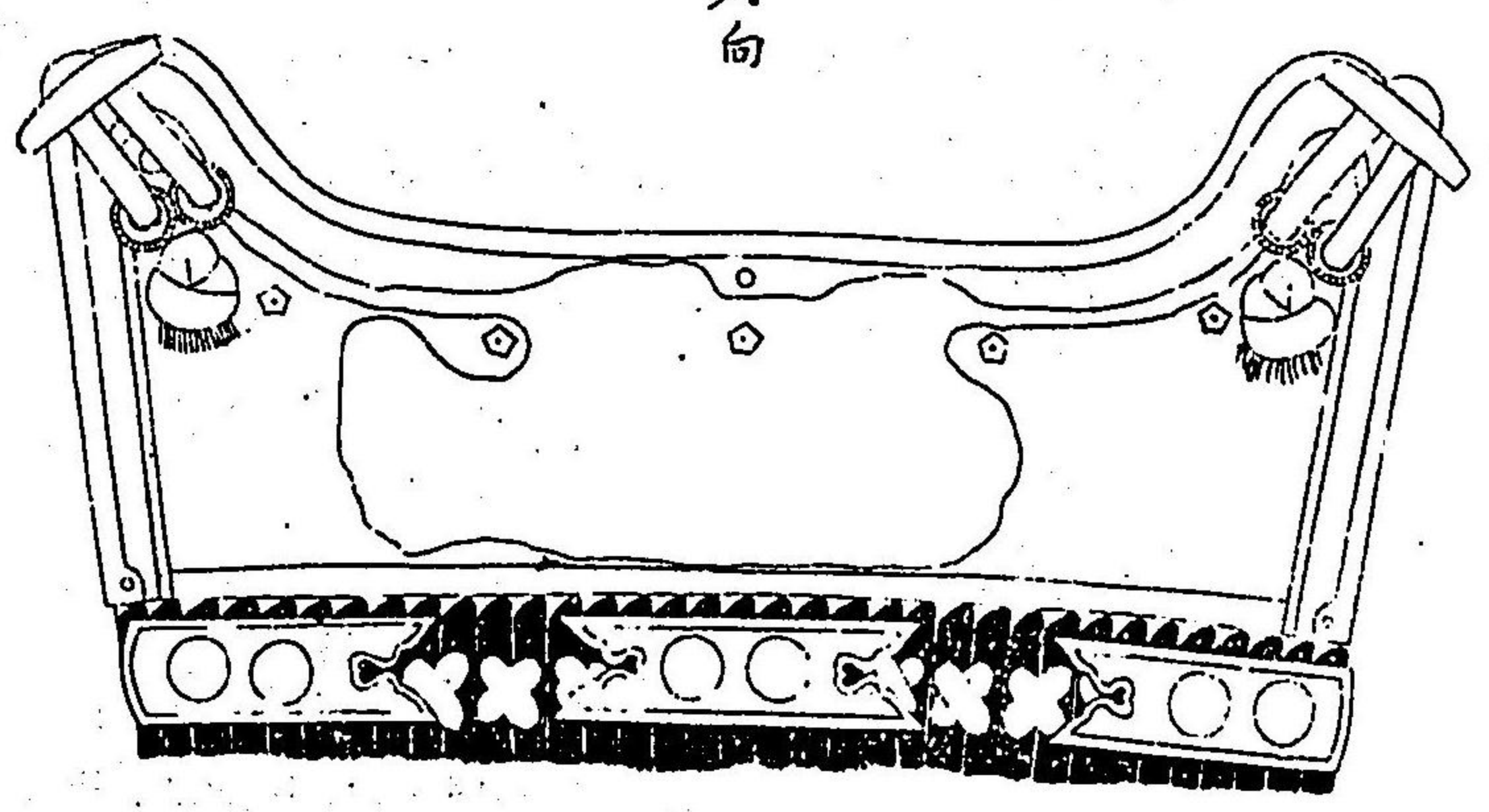

妻手

高紐ノ請緒ニ同



押付左方

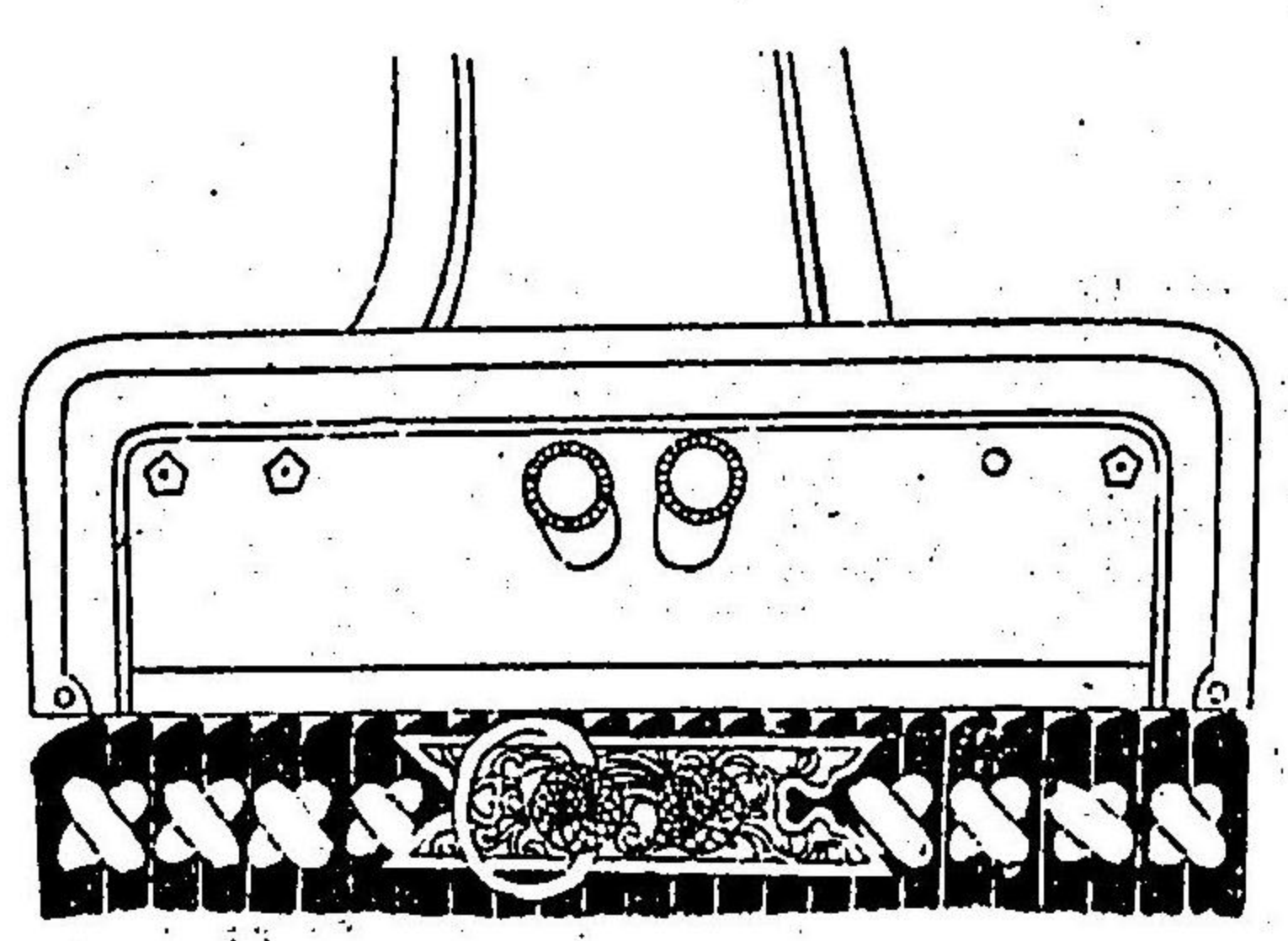

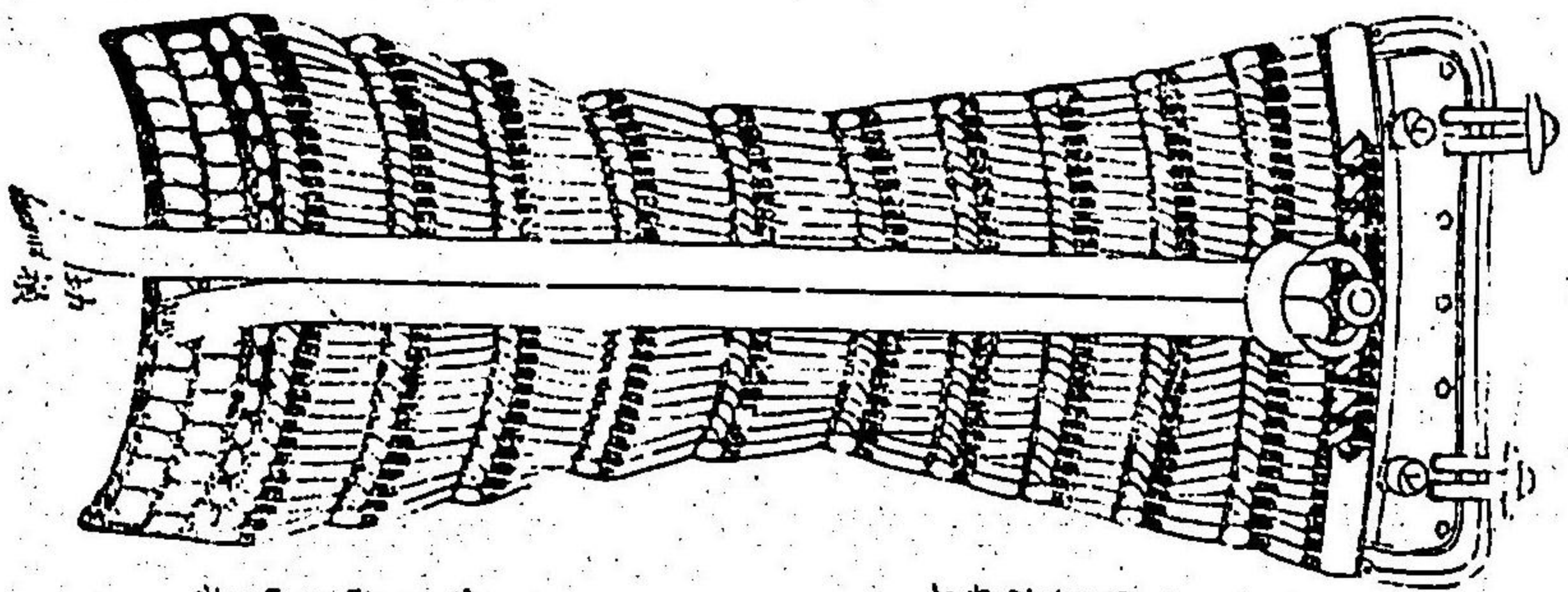

背板全圖

威來一板胡賣二板白三板
引草摺三板子維四ノ板
白
小袋蓋漆參尺
總角維公四ノ打



高起ノ漆板二同

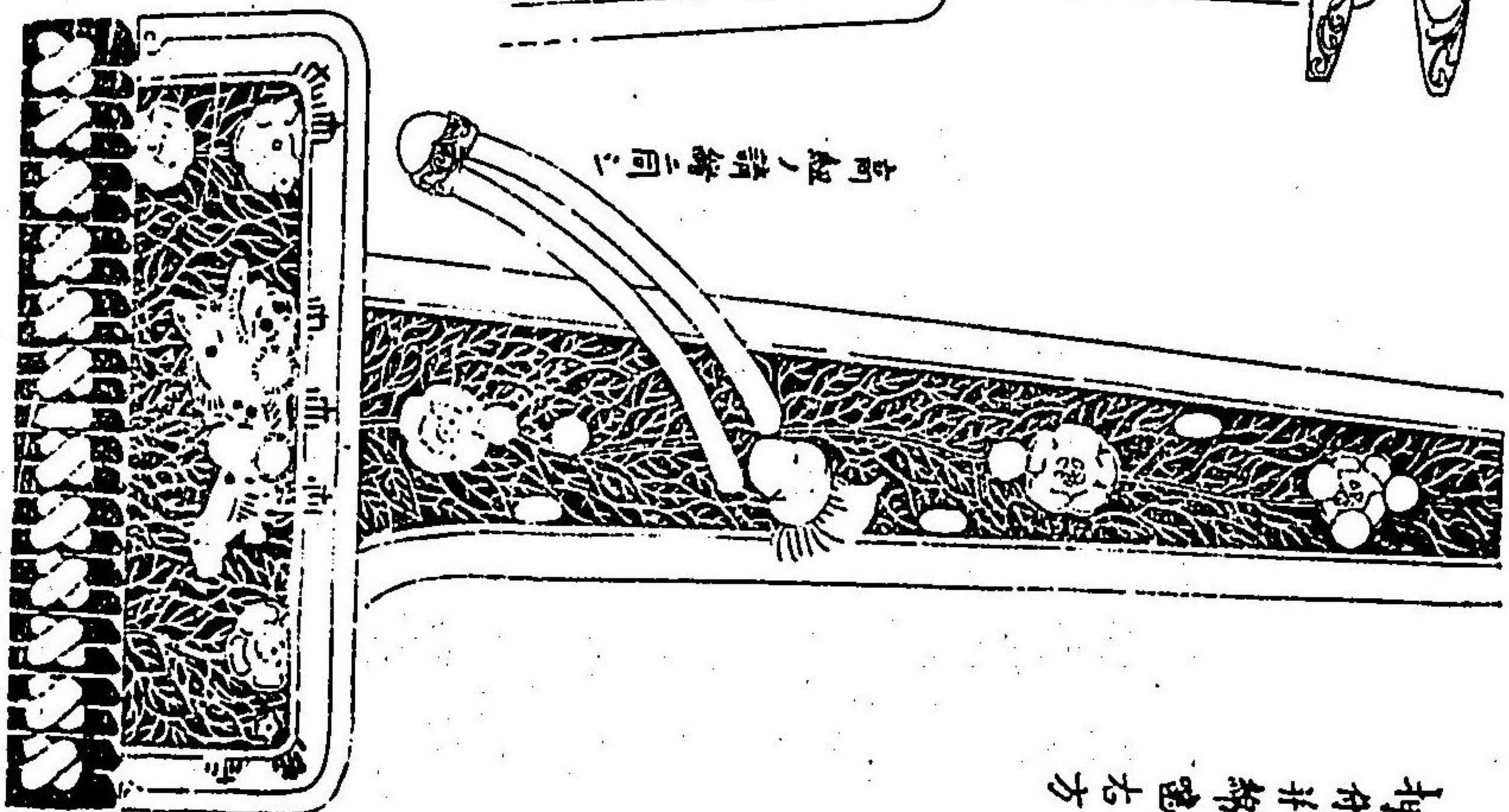

押付并絡龜七方

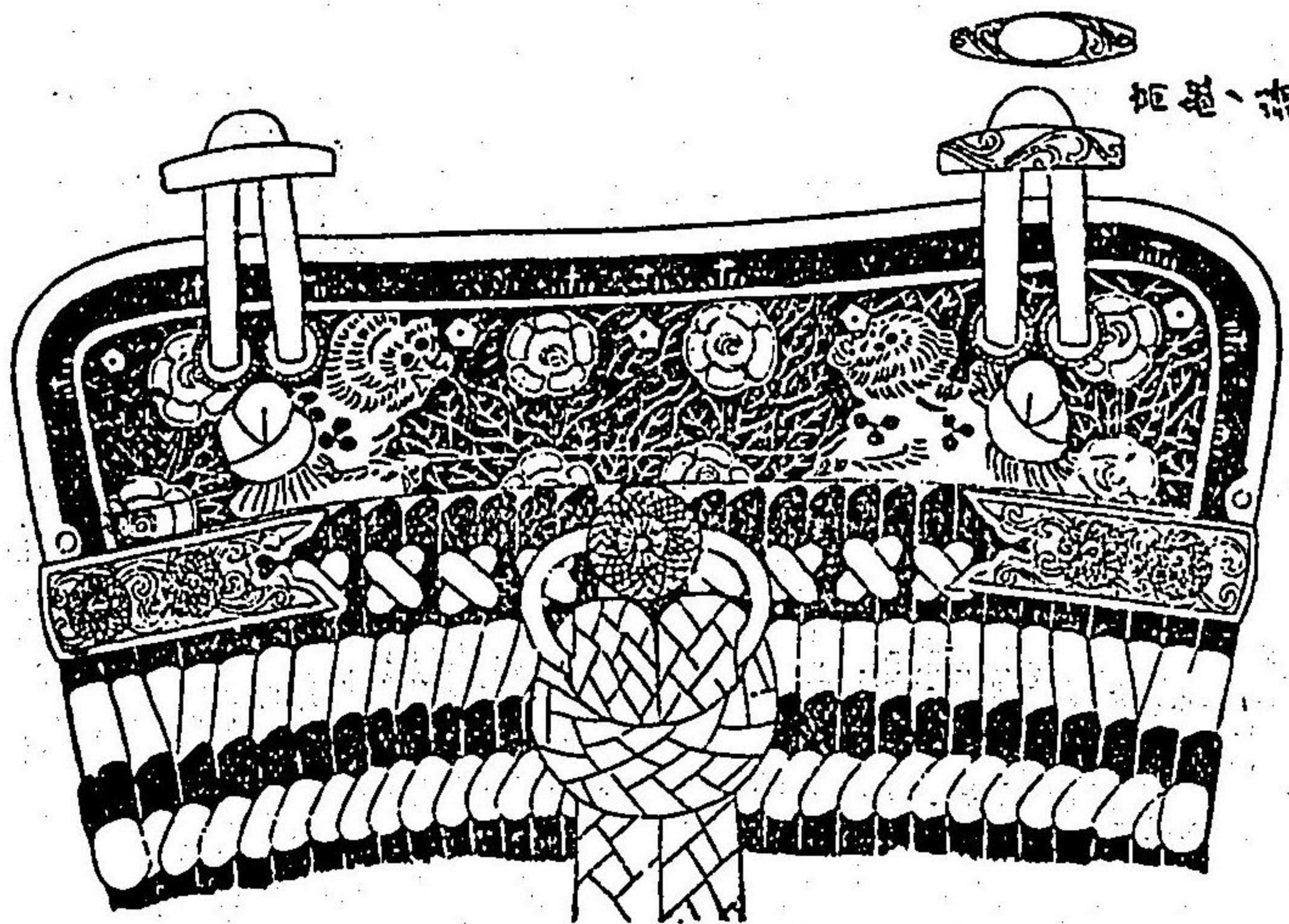

背板

恒物、恒物

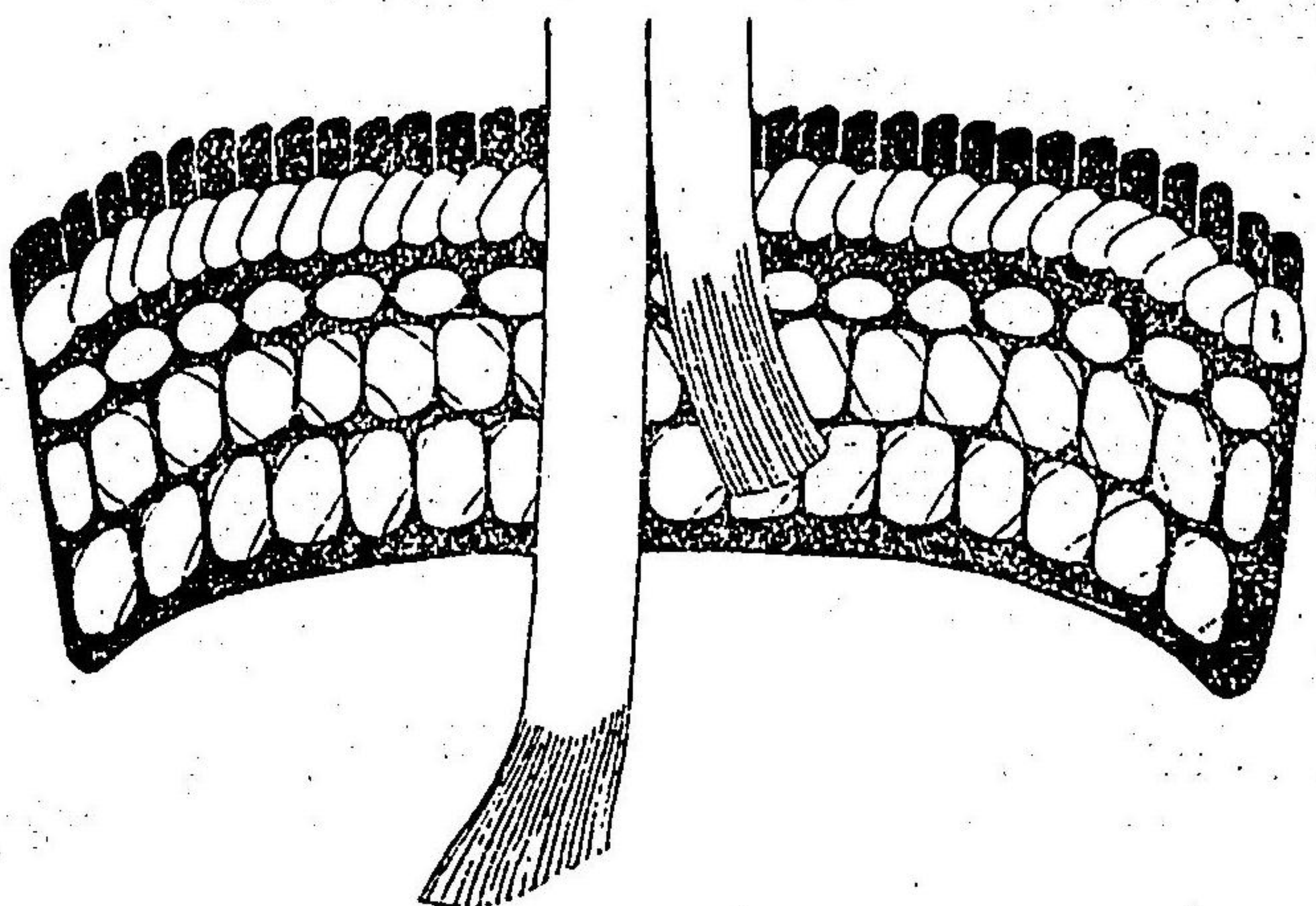

同草摺菱縫板

前中央草摺

一板紛夫

威毛耳糸畦目菱縫皆
皆板二同三

草摺七間、內六間八一板小札
二十二枚下三枚增

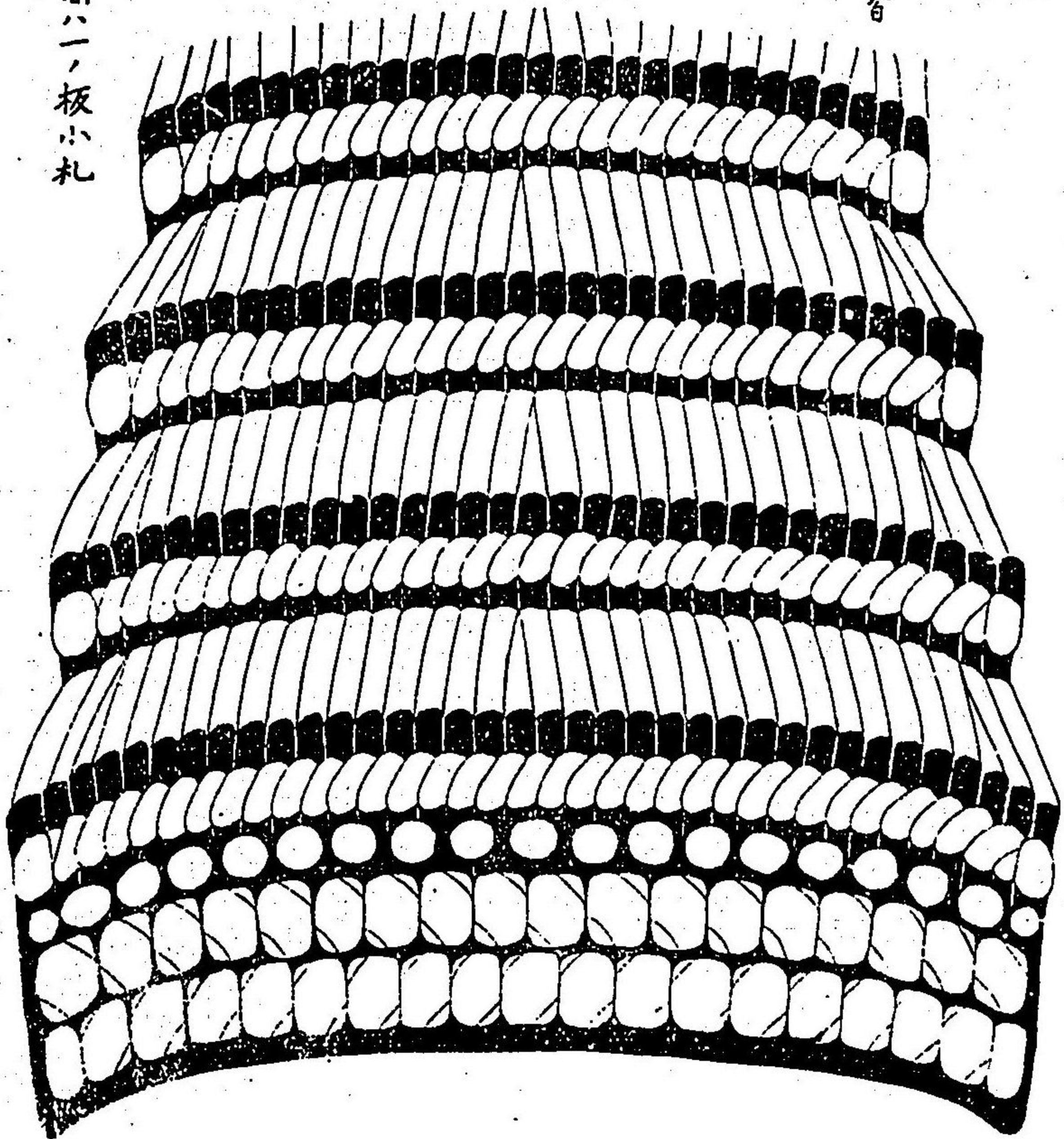

袖冠板

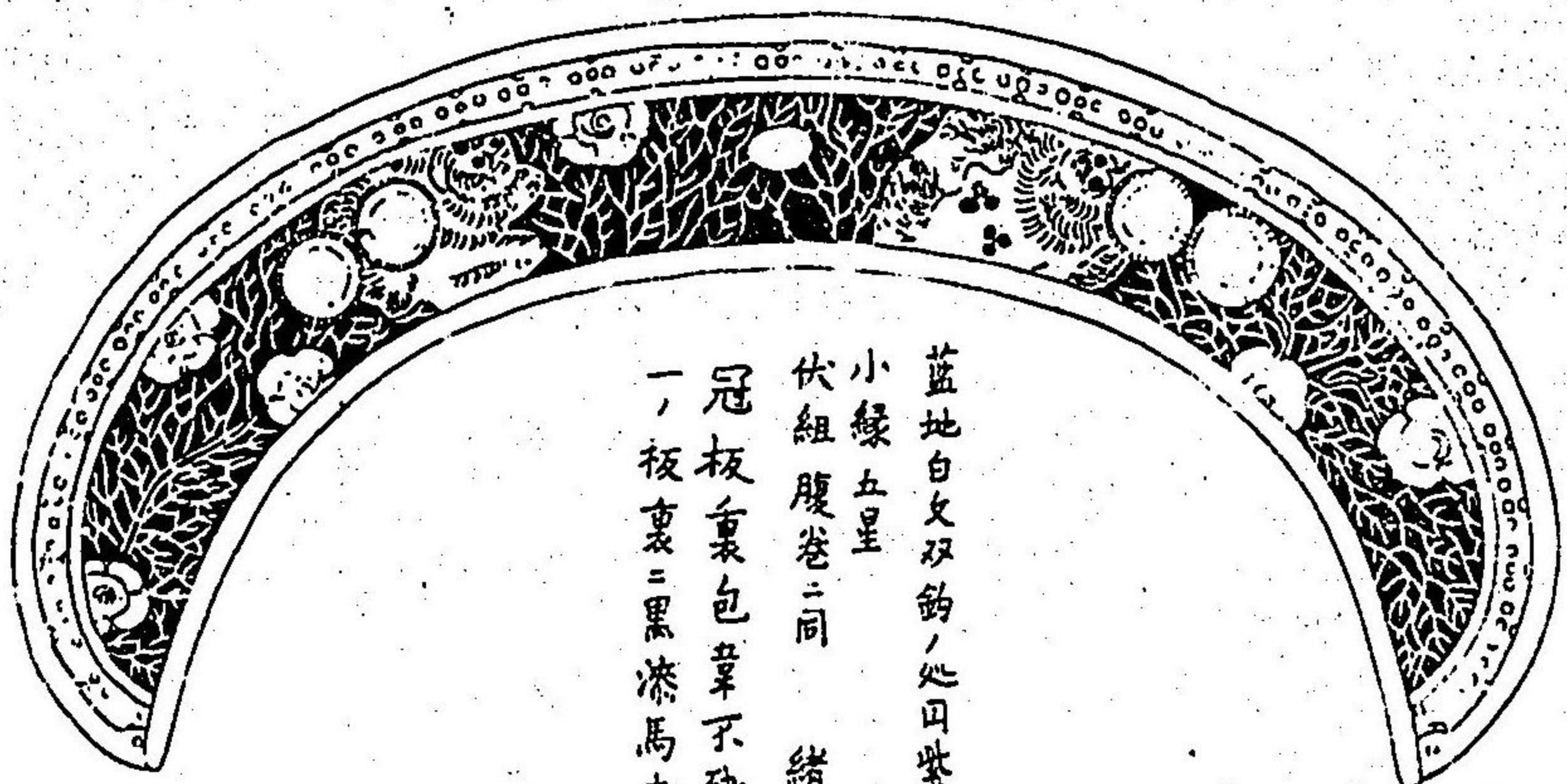

藍地白文双鈎ノ処四紫
小縁五呈
伏組腹巻二同 緒皆損失
冠板裏包草不殘損失
一板裏ニ黒漆馬皮少ニ縫

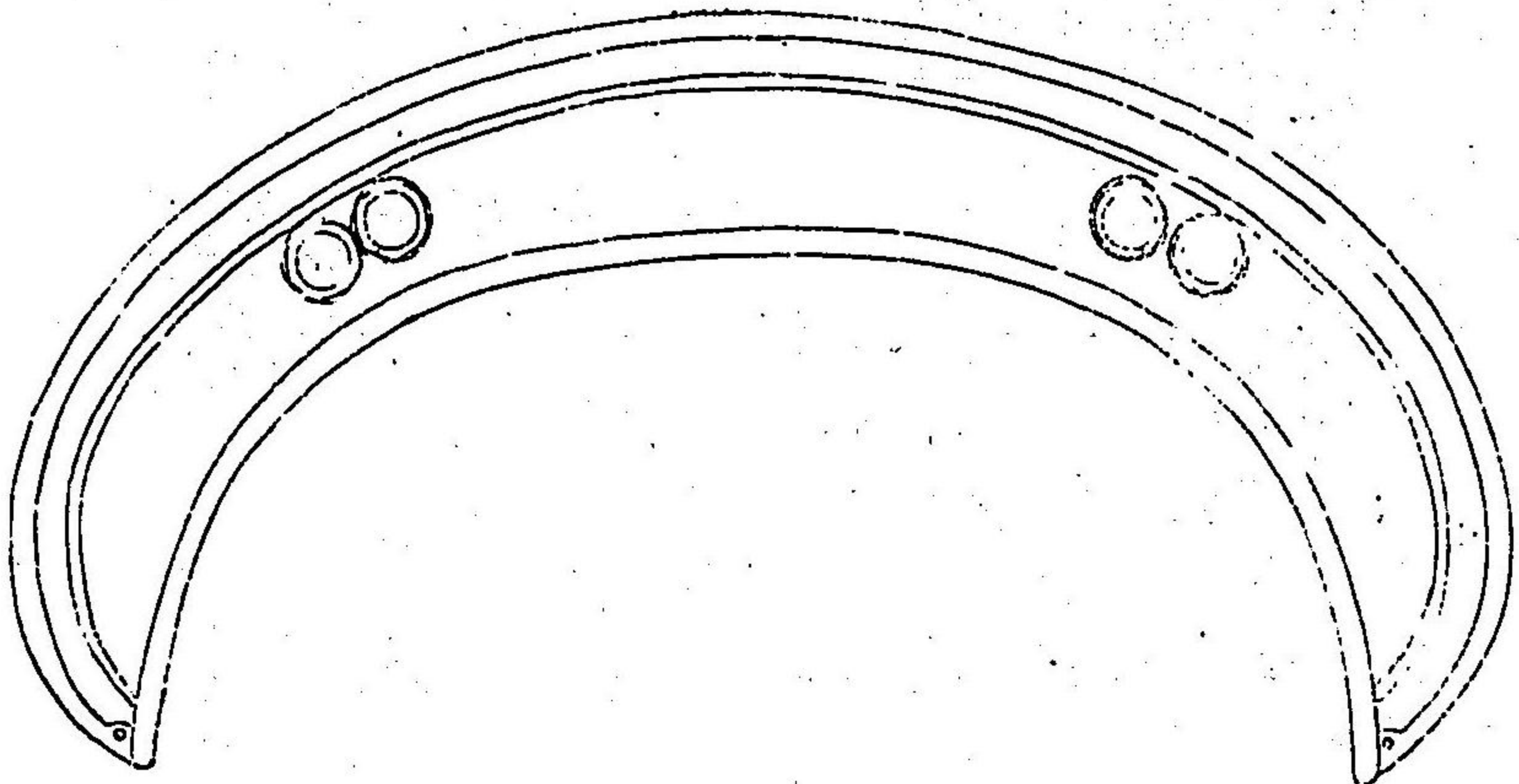

吹降古指品草

袖壺左

水引能白織

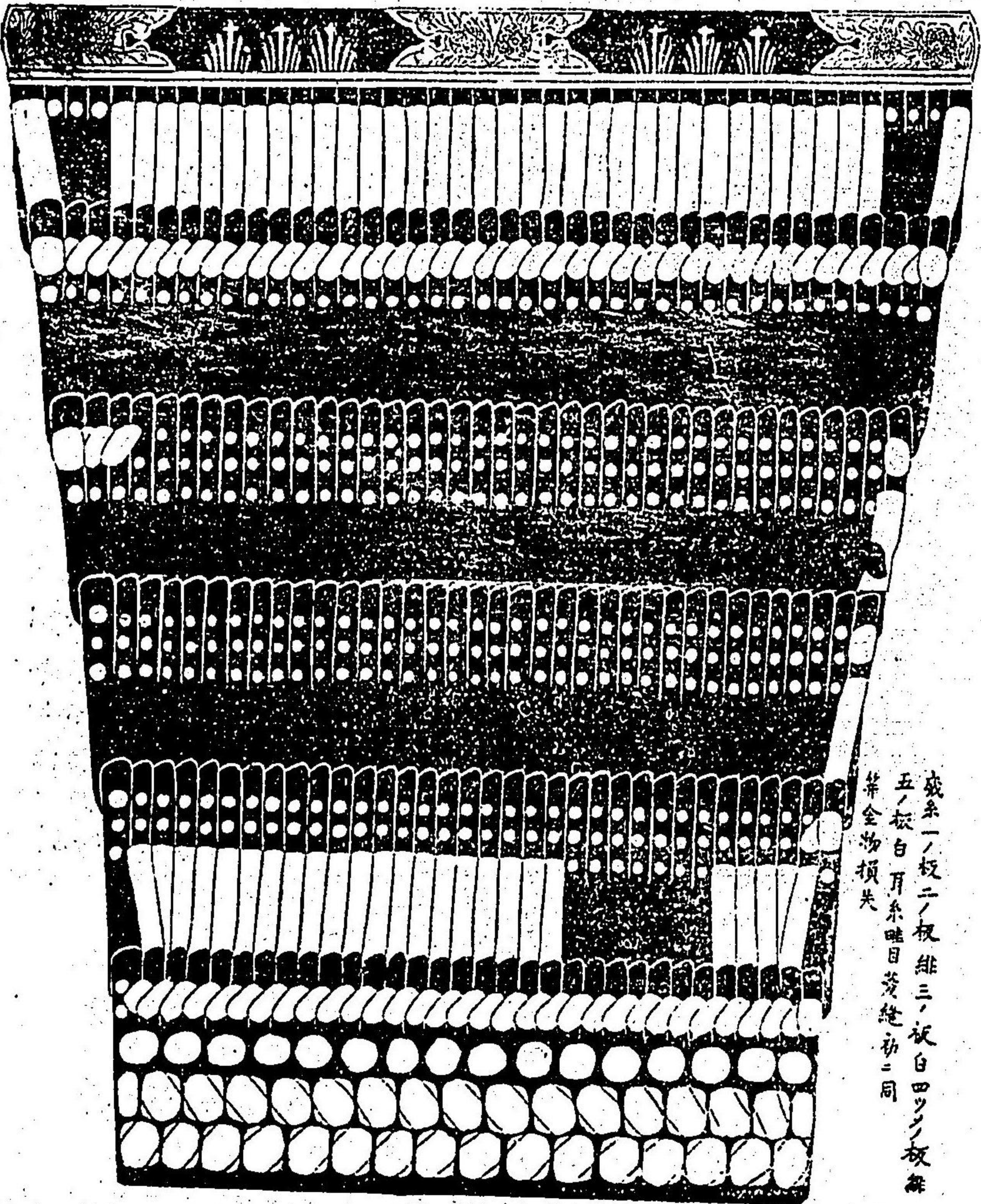

破糸ノ板ニ板維三ノ板白四ツノ板
 五ノ板白月糸唯目發總初ニ同
 并全物損失

袖壺右

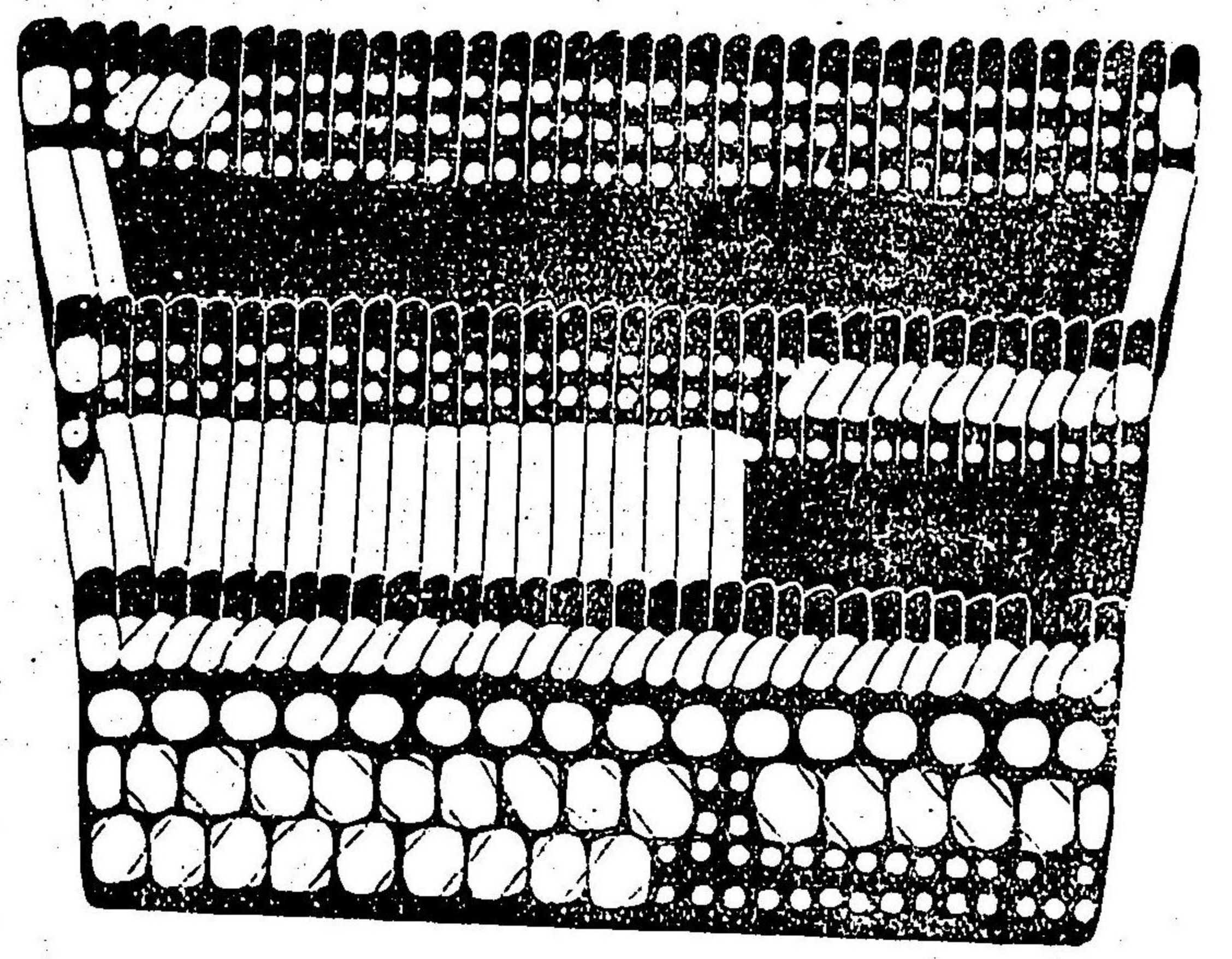
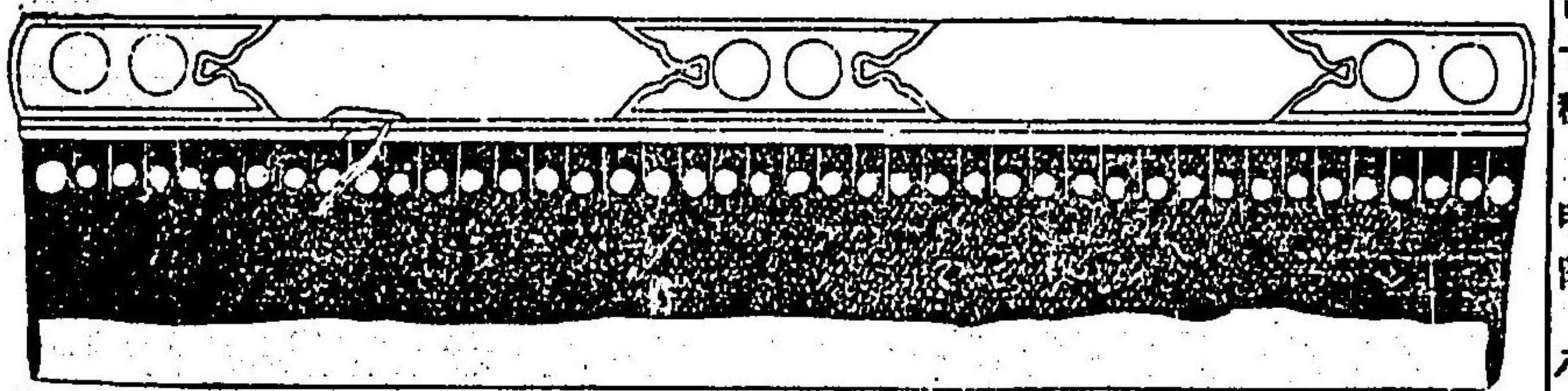

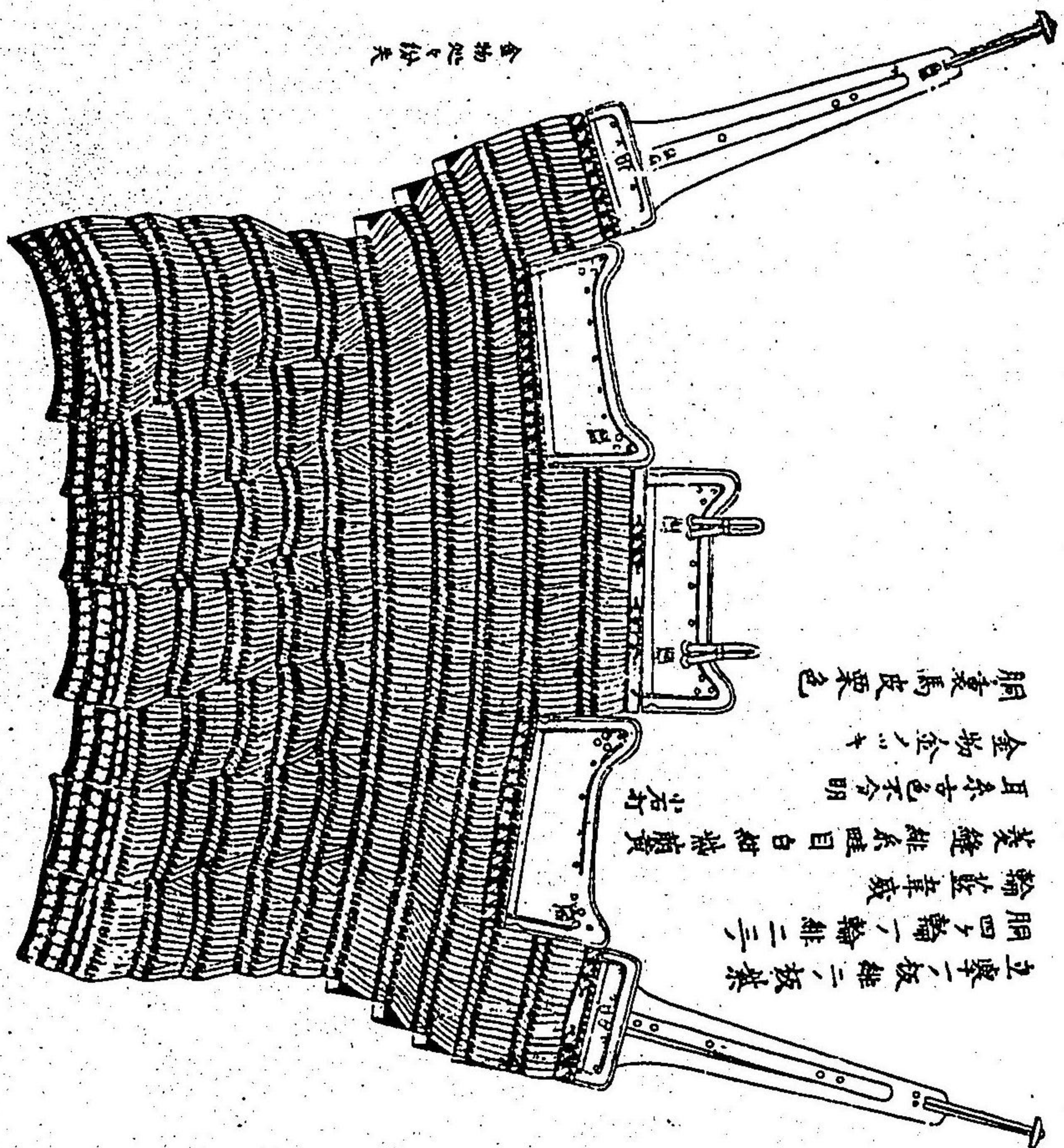

腹卷全圖

立腰二板雜二板葉
 胴四ノ輪ノ輪雜三ノ
 輪並草成
 菱縫 雜系睡目 白細油腹
 耳奈古色不分明
 金物金ノ十
 胴裏馬皮栗色

金物處ノ抄矣

大和國吉野山吉水院藏腹卷及後輪圖

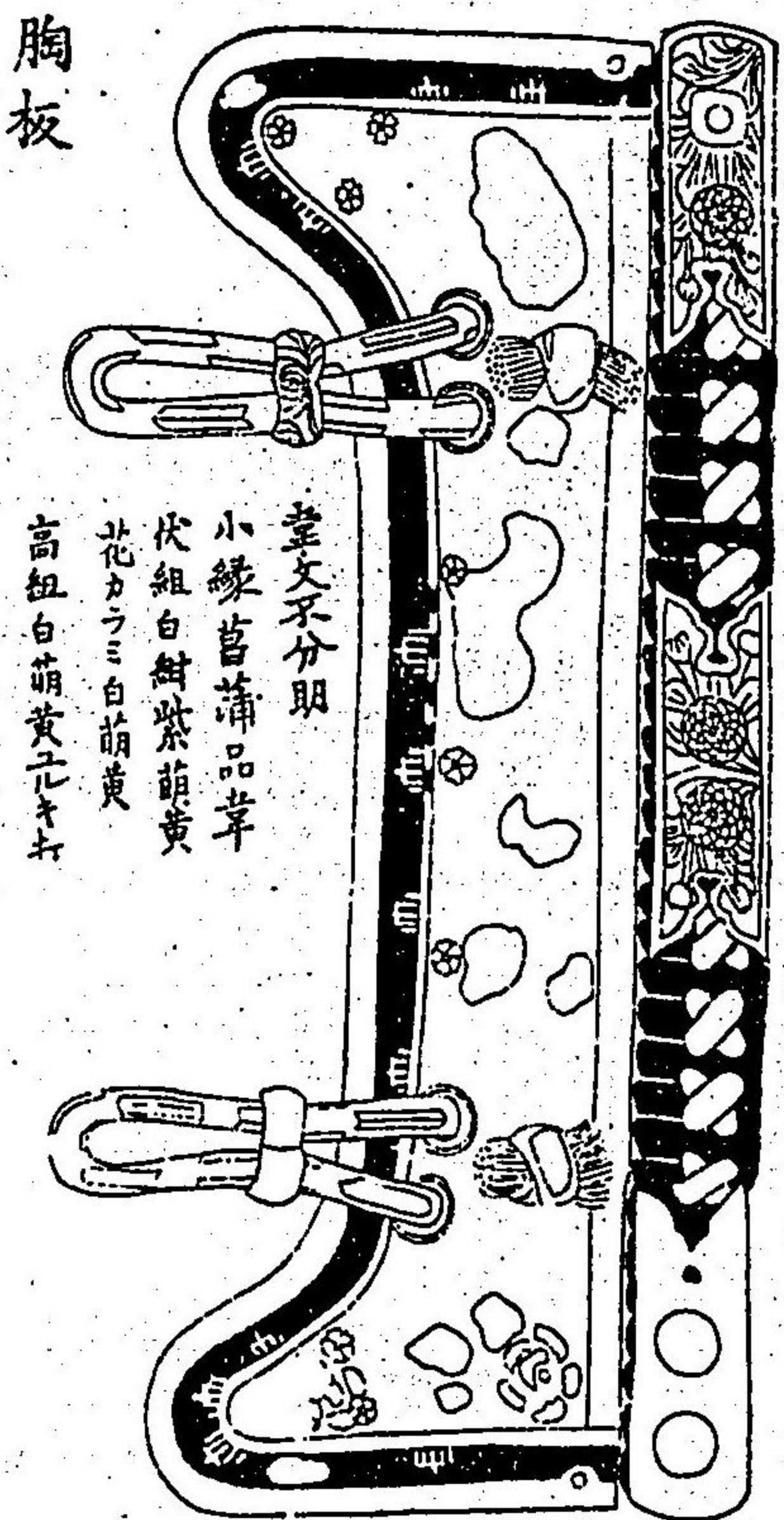

臺文不分明
 小縁首蒲品草
 伏組白紺紫萌黄
 外花カラニ白萌黄
 高紐白萌黄元キナ

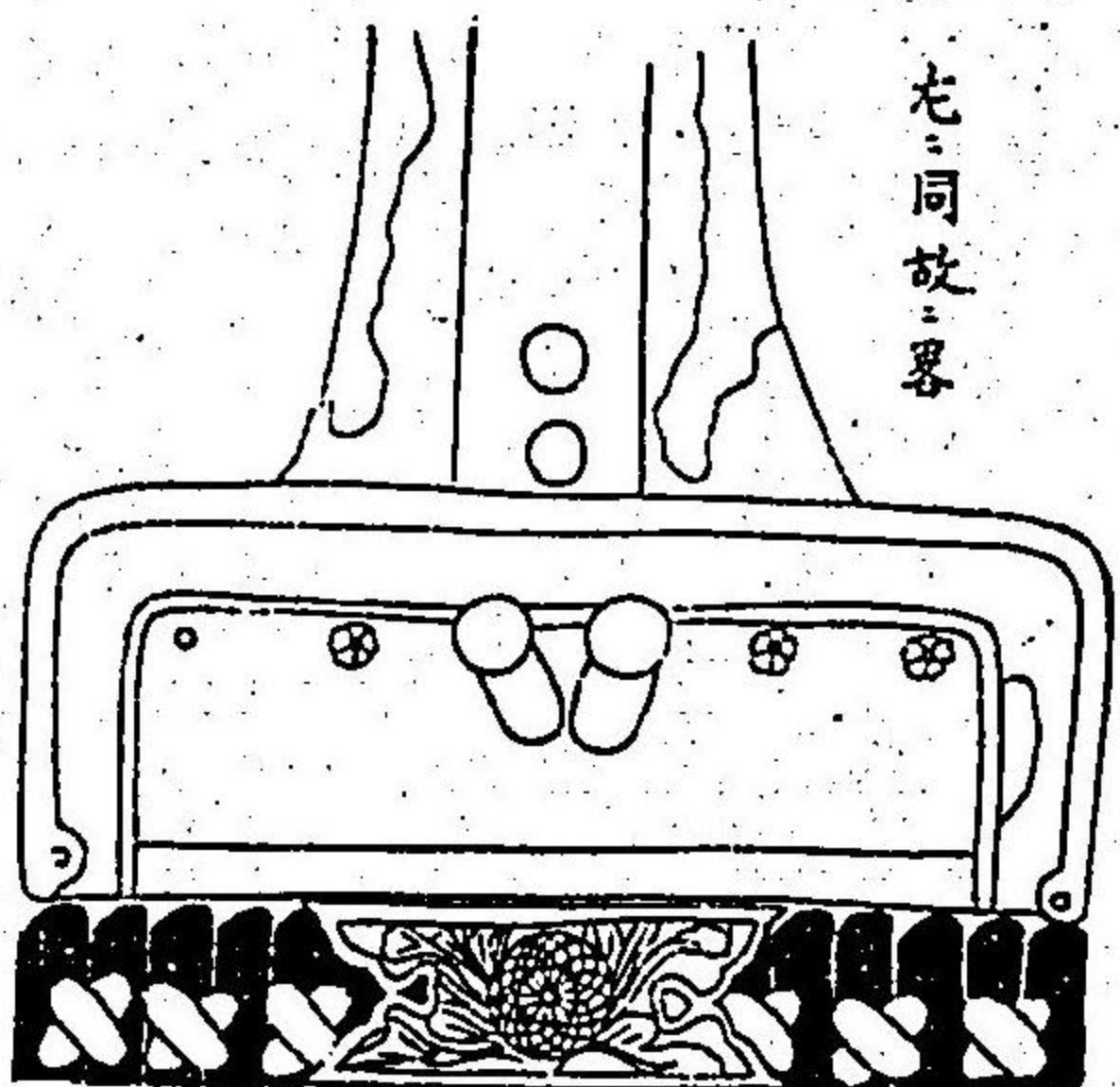

右同故ニ尋

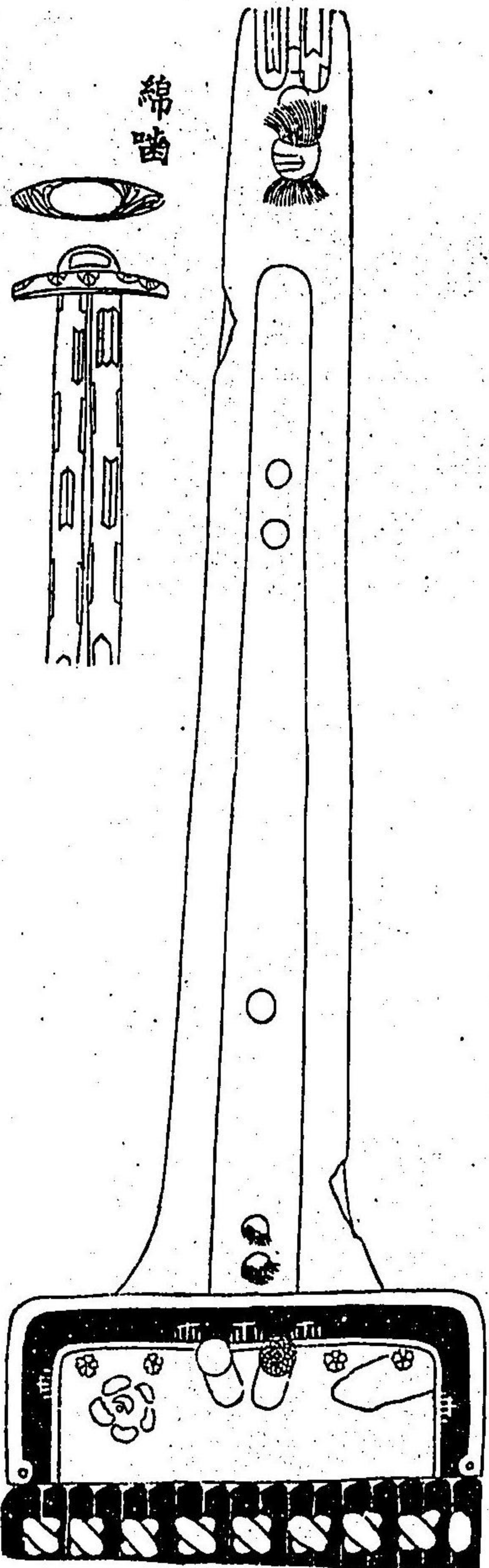

綿置

射向

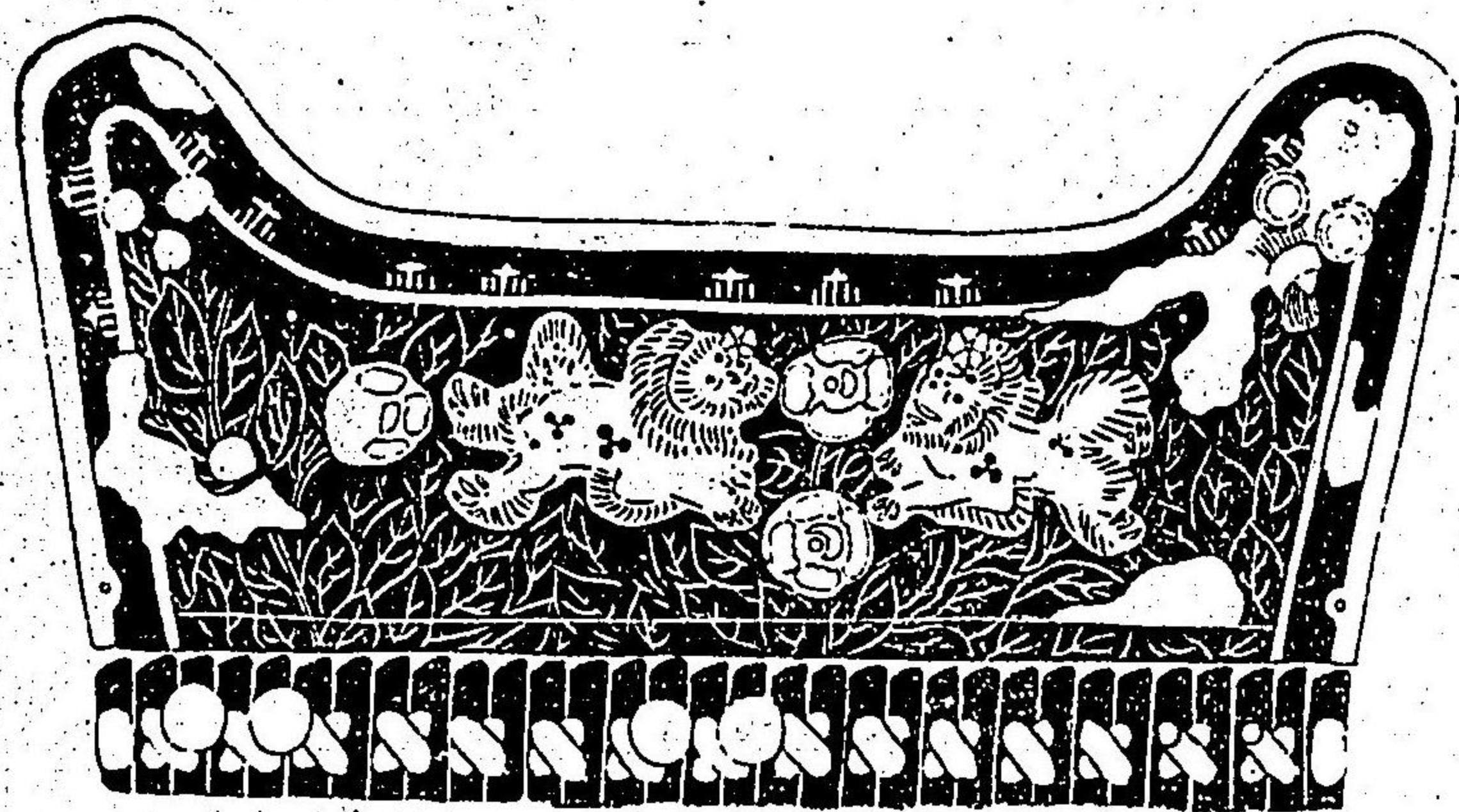

妻手

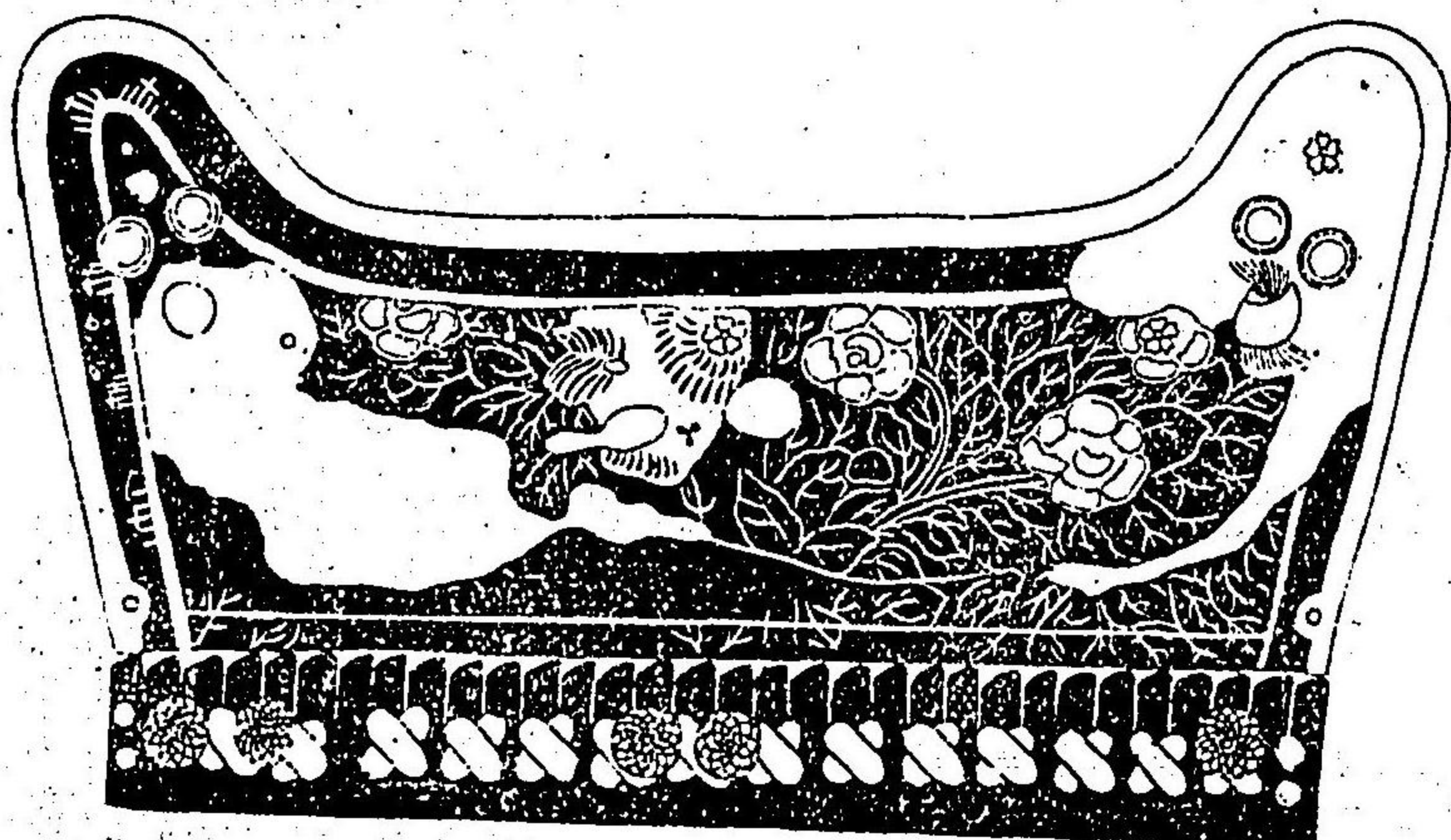

草摺

前中央一ノ板三十二枚下三枚増
搖ノ糸一ニノ板藍韋三ノ板緋糸四ツノ板白糸威
畦目白紺紫萌黄

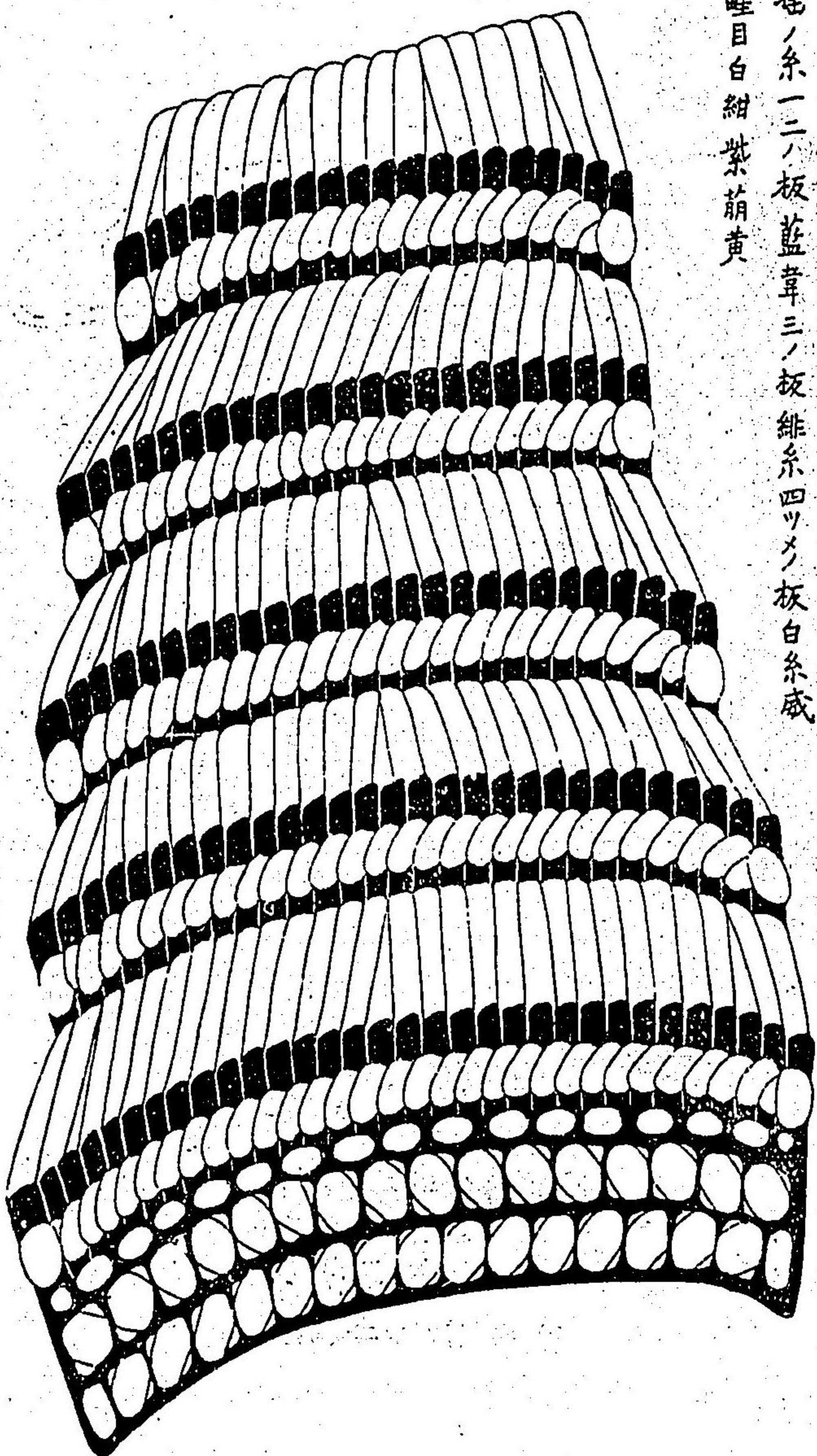

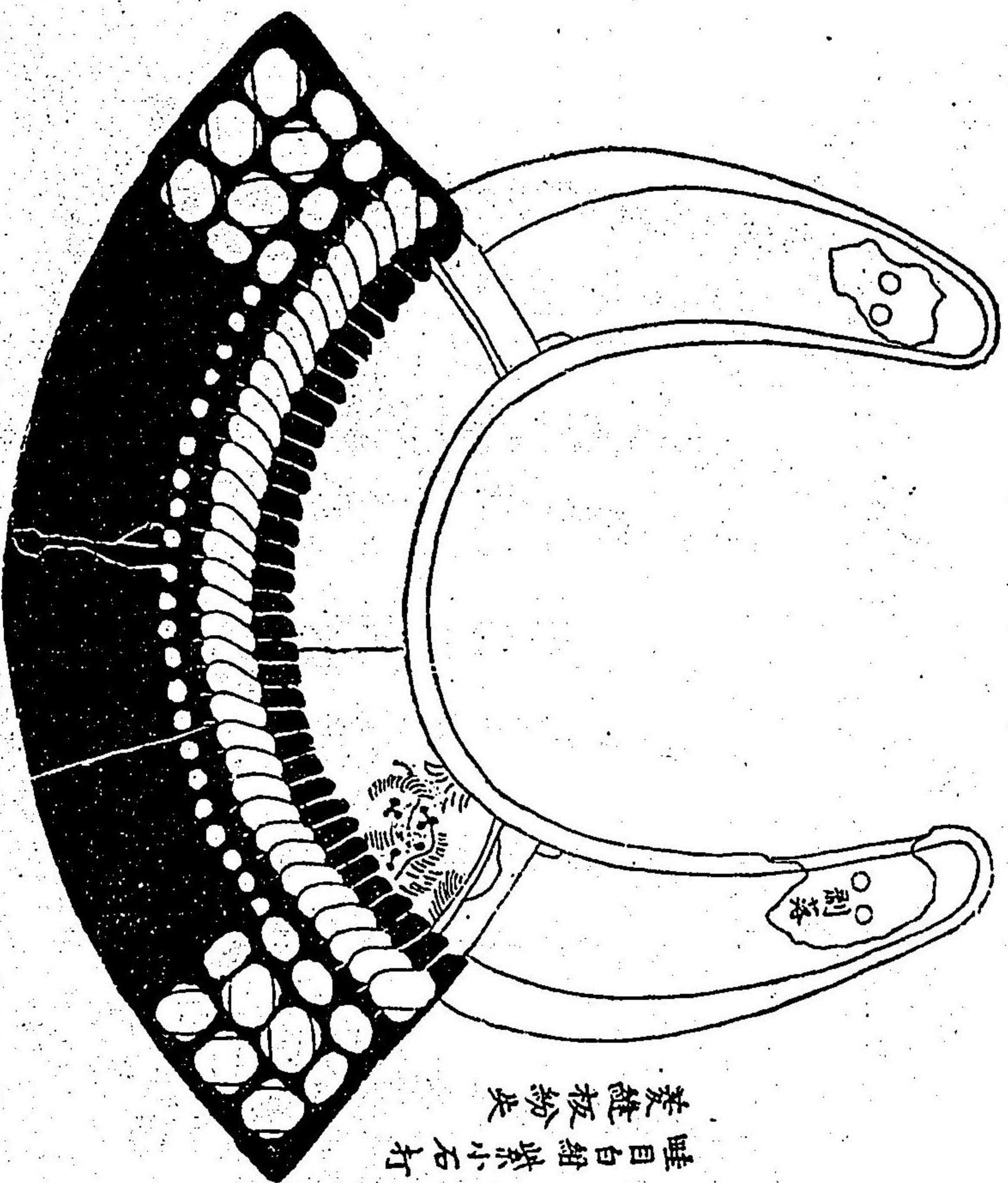

喉輪

蝙蝠付韋文字分明
 小縁唐免鞆
 伏組白紫紺
 蝙蝠付裏栗色馬皮
 一板カ之三菱縫緋糸
 睡目白紺紫小石打
 菱縫板紛灰

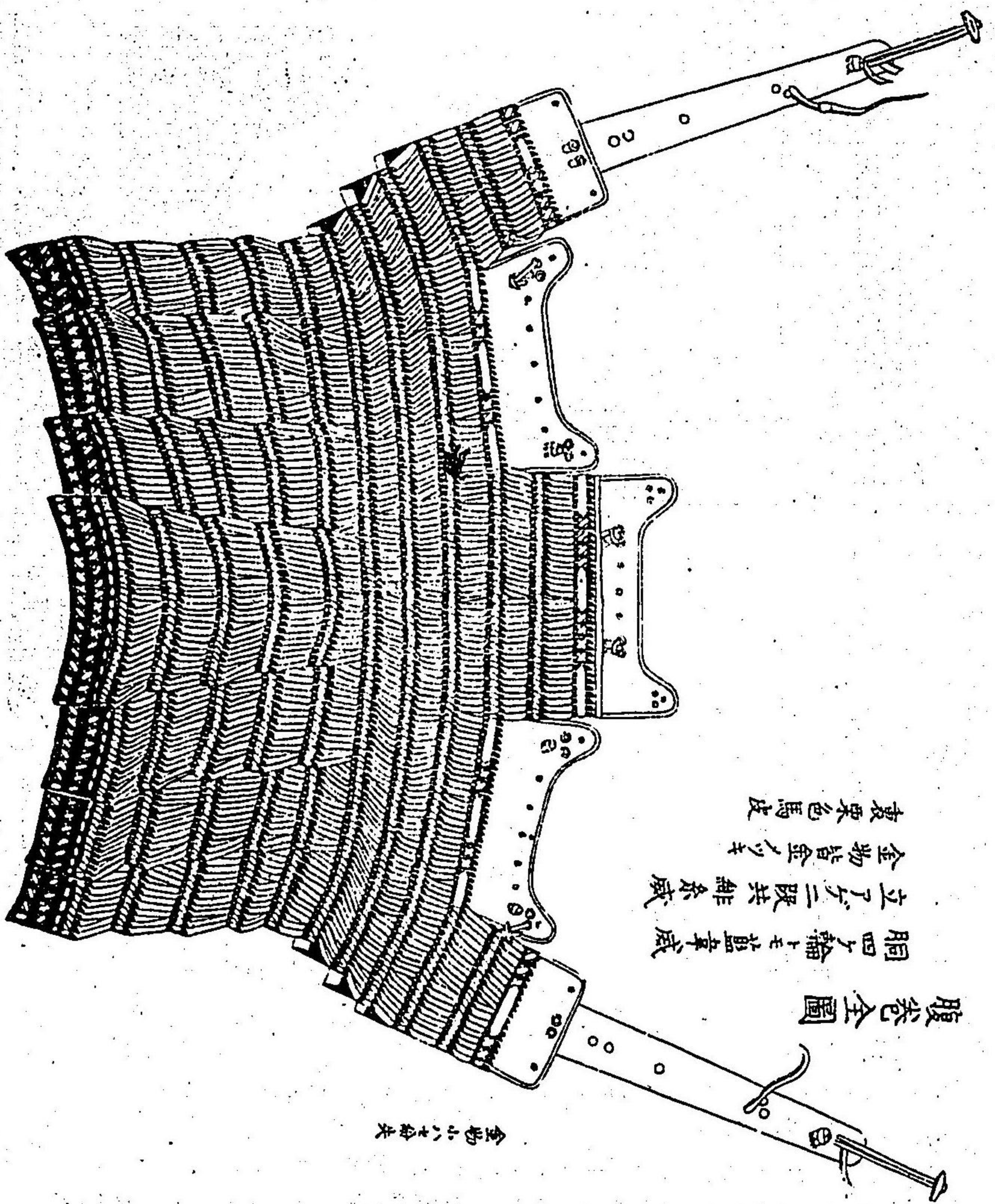

腹卷全圖

胴四ノ輪上ニ藍草威
 立了ノ二段共緋糸威
 金物皆金ノキ
 裏栗色馬皮

金物小ニ指矢

河内國觀心寺藏楠家腹卷及喉輪圖

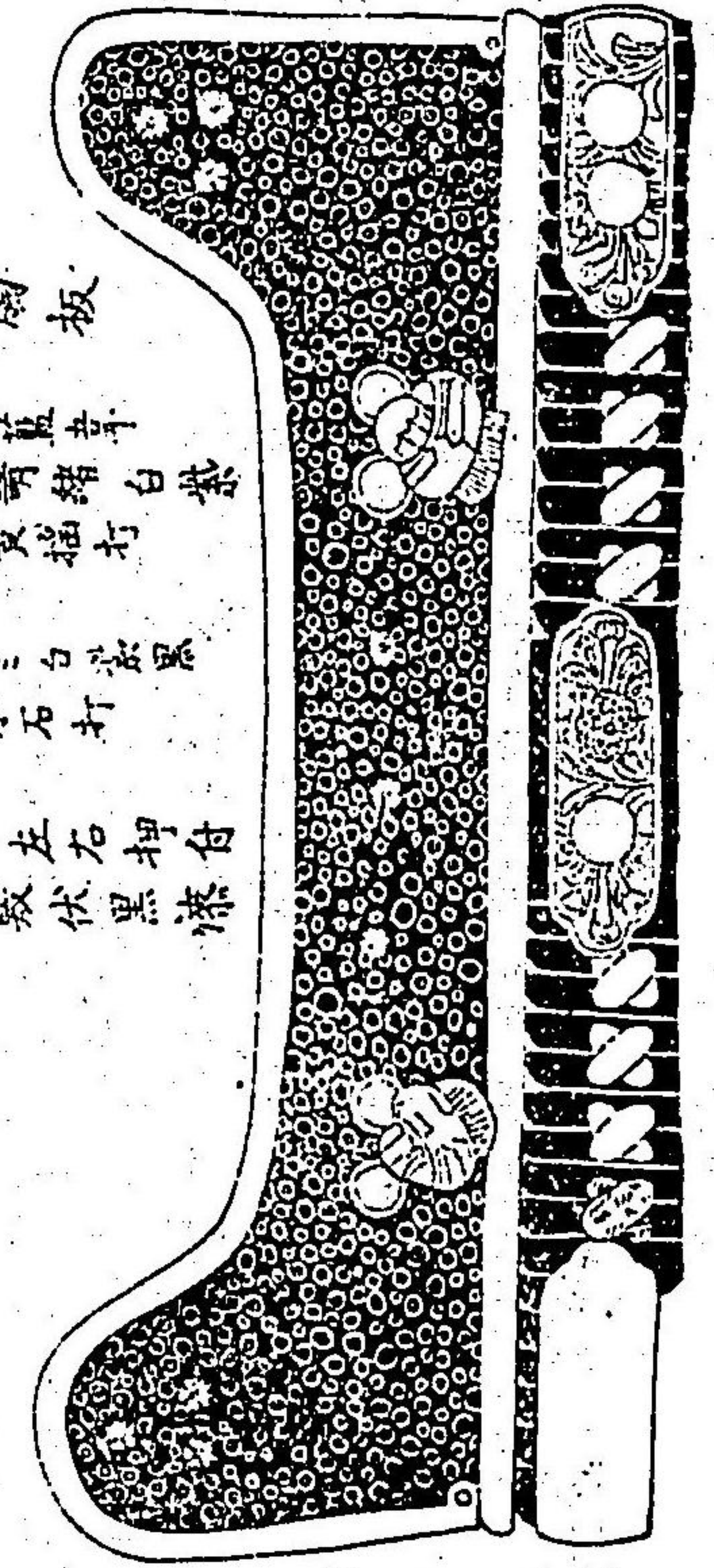

陶板
フノリ直草
高紐請緒白紫
黒請黄打
花カウミ白紫
筒紫小石打
陶板左右押付
板共較伏黒漆

等階

左

右

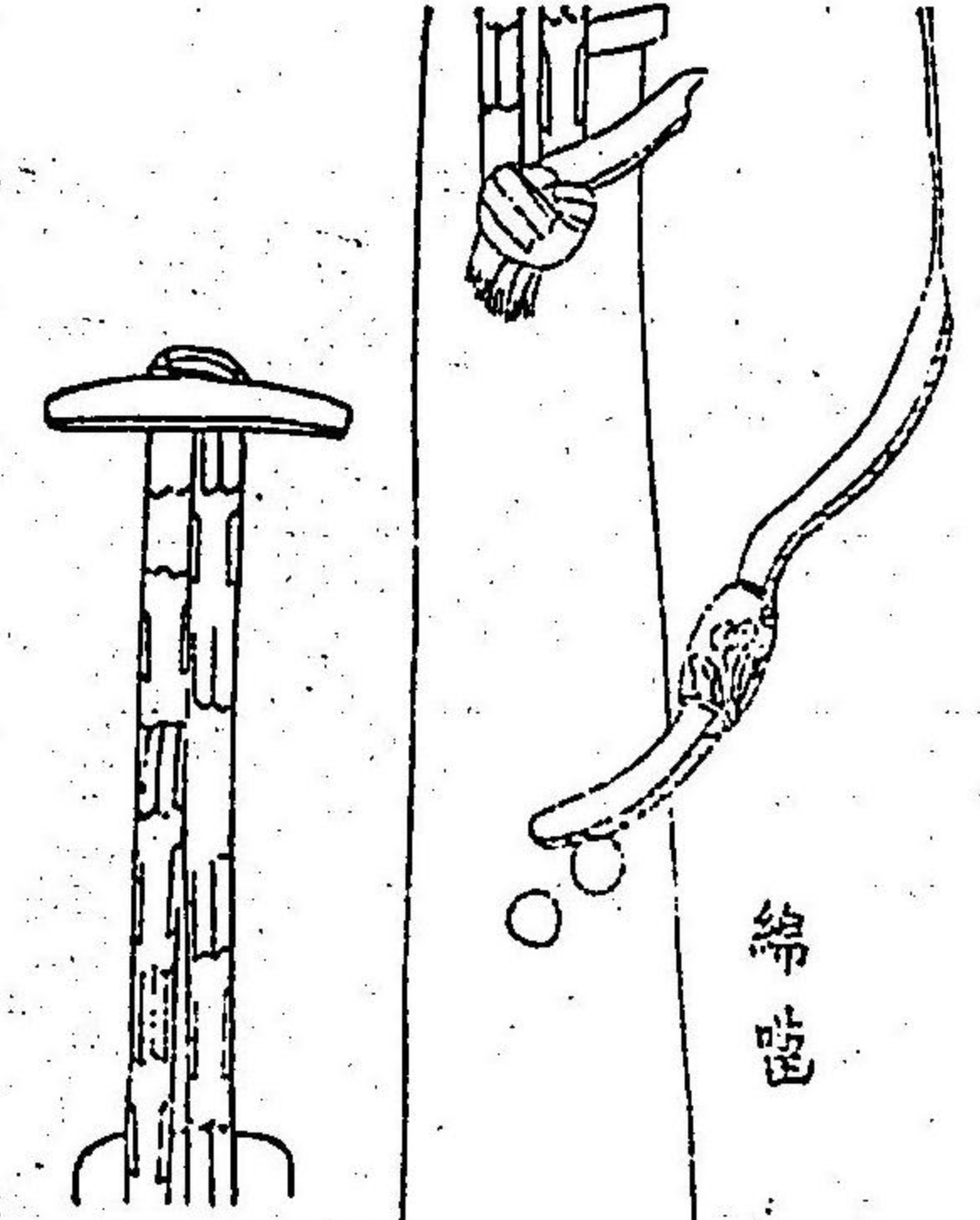

袖付茶黄緒
白紫ノ伏組
蓋草茶萌黄

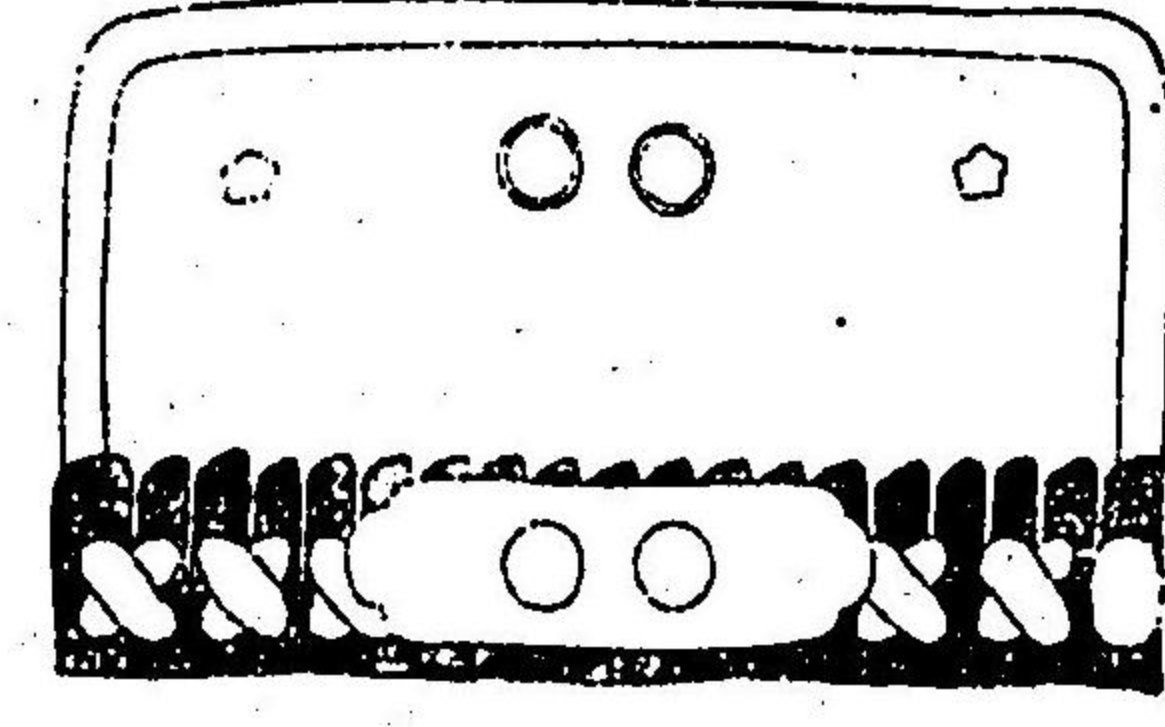
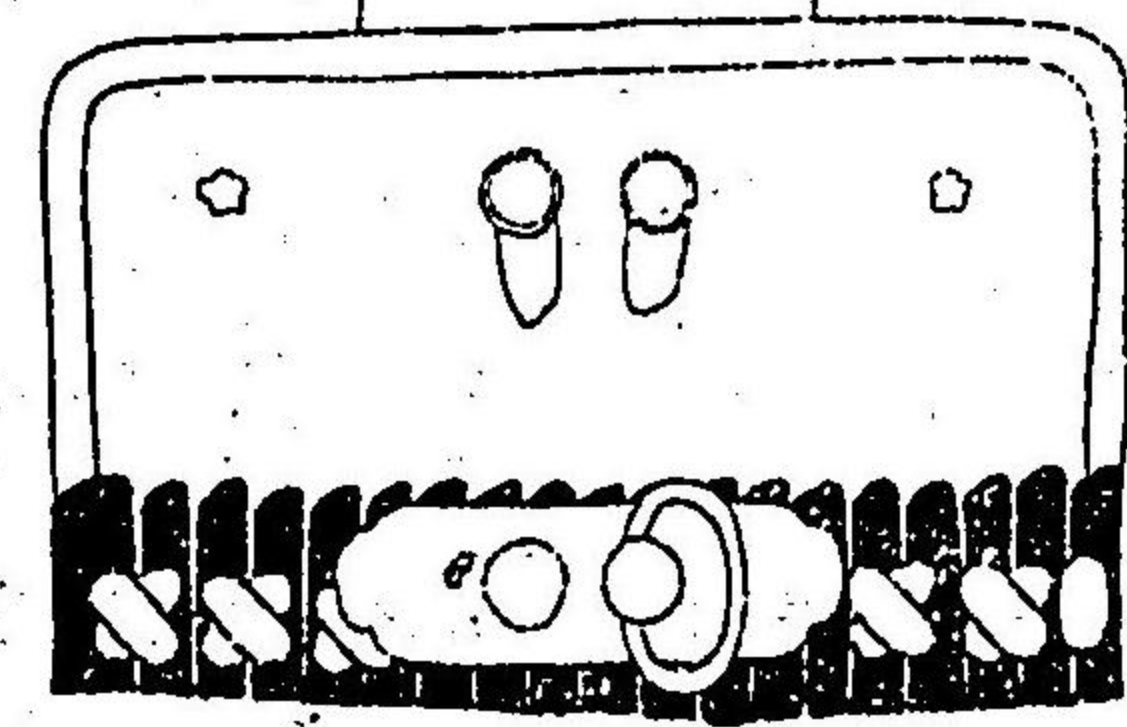

射向

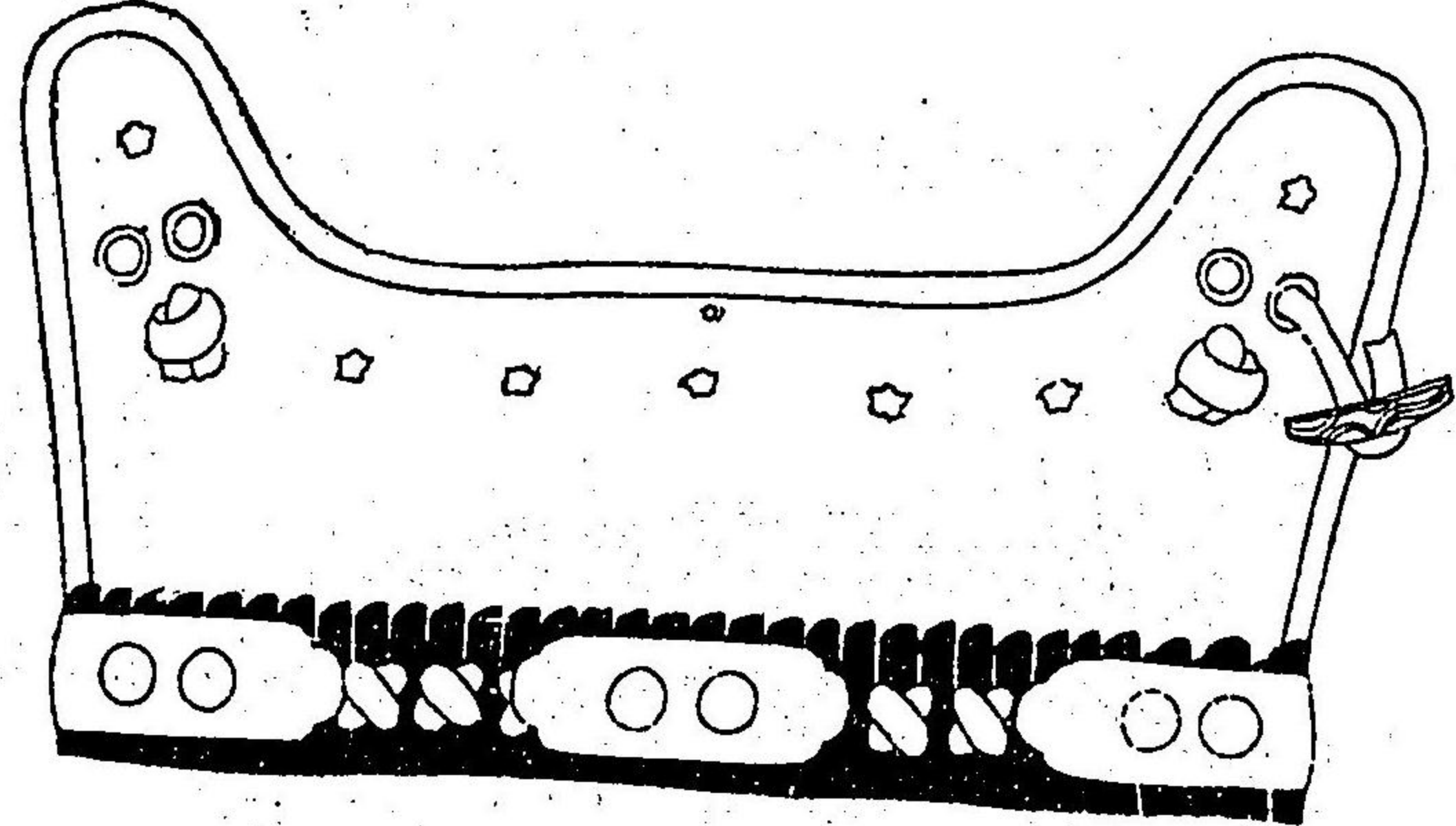

妻手

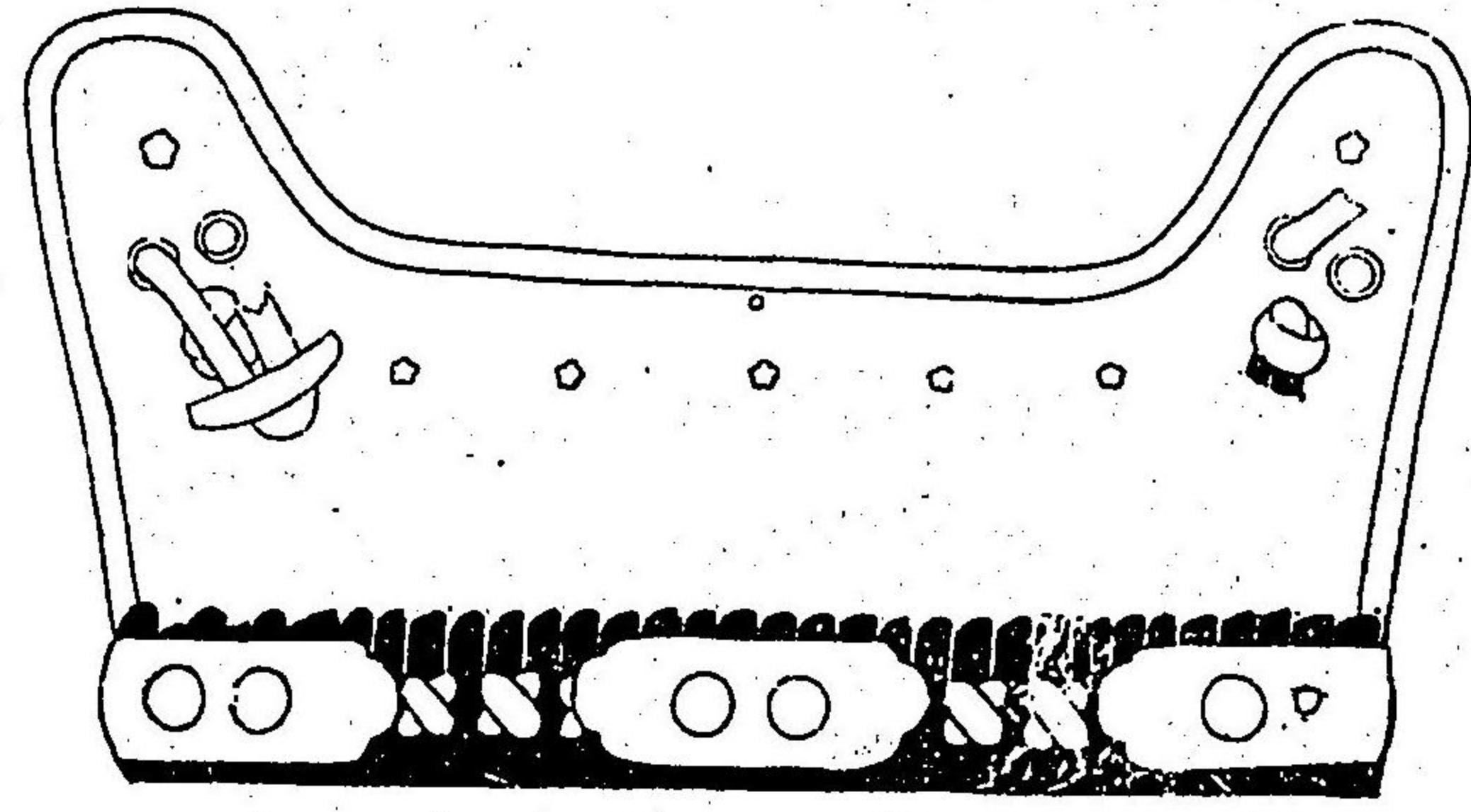

草摺

耳糸白紫黑
前黃龜甲打
畦目同色小石
打菱縫緋糸

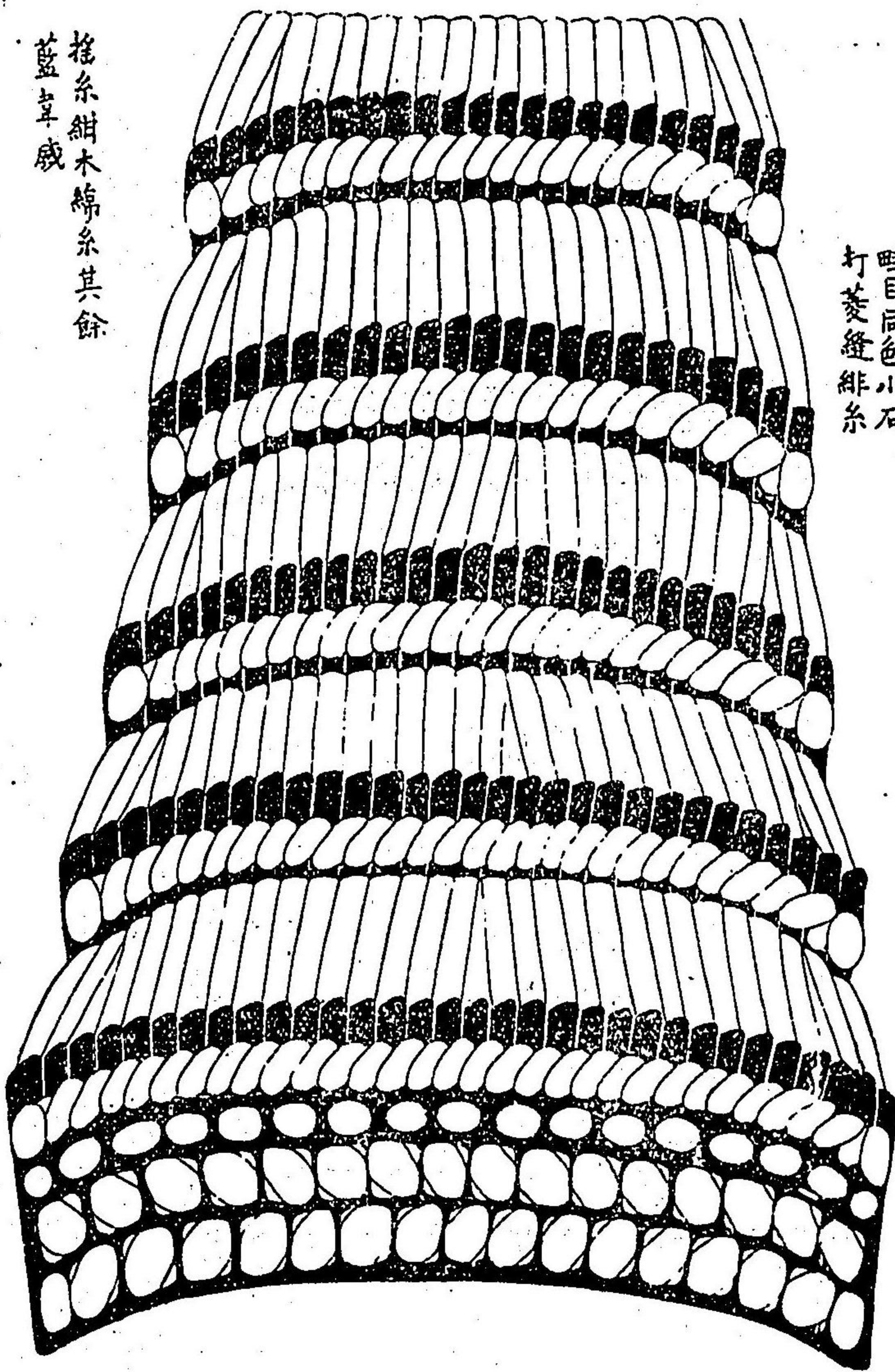

控糸紺木綿糸其餘
藍草威

喉輪

蝙蝠付楊梅皮漆天平韋
文古色不分明
小縁菅蒲草
伏組紅白胡黃
蝙蝠力三緋糸其下茶糸威
畦目茶白黑胡黃小石打
耳糸同色龜甲打菱縫緋糸
蝙蝠裏馬皮黑漆

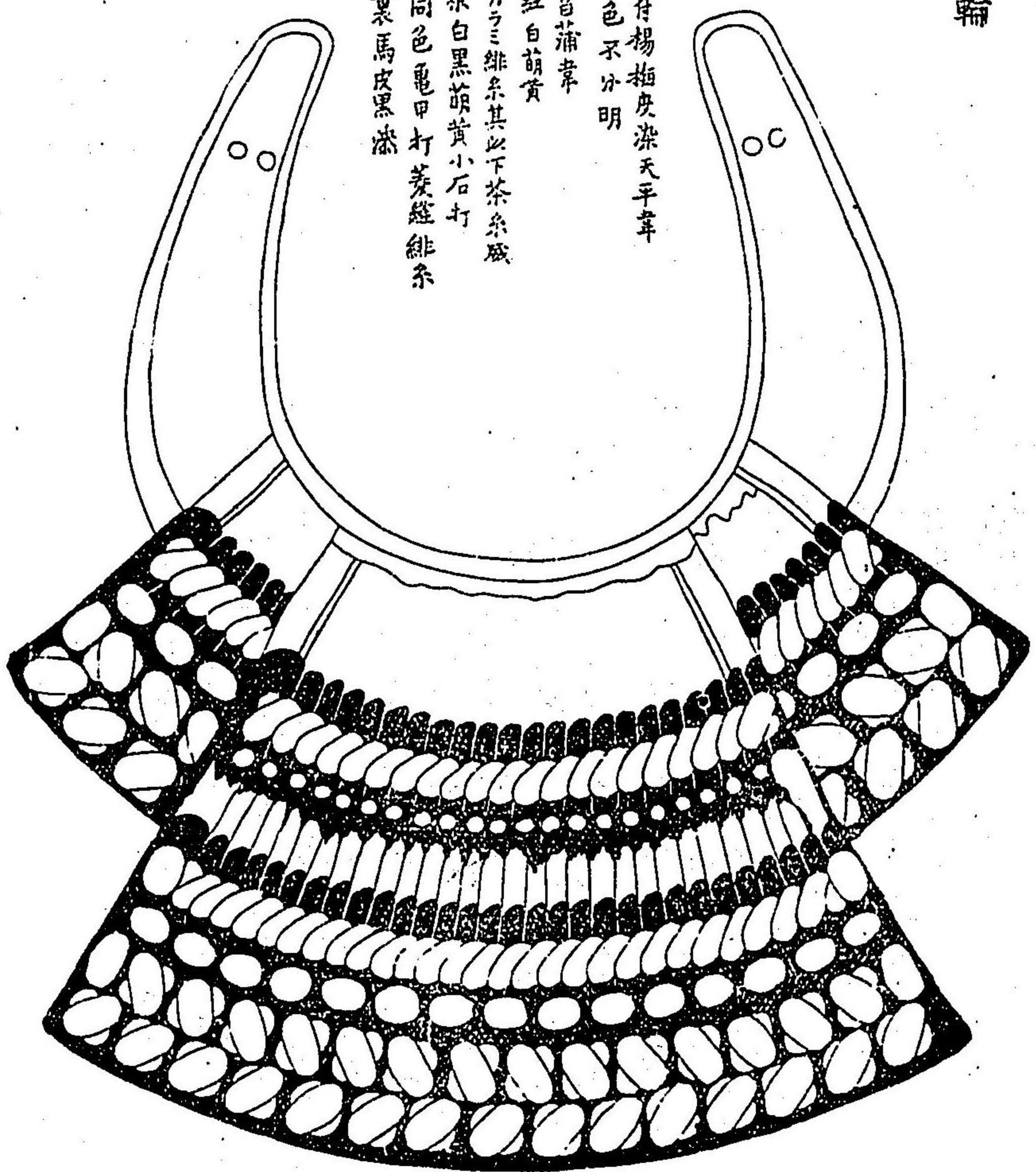

中村弥大夫藏由目圖

高四寸二分
深三寸八分
星一行九
金物金メツキ

四天鎮無之
穴ヲ穿ツ

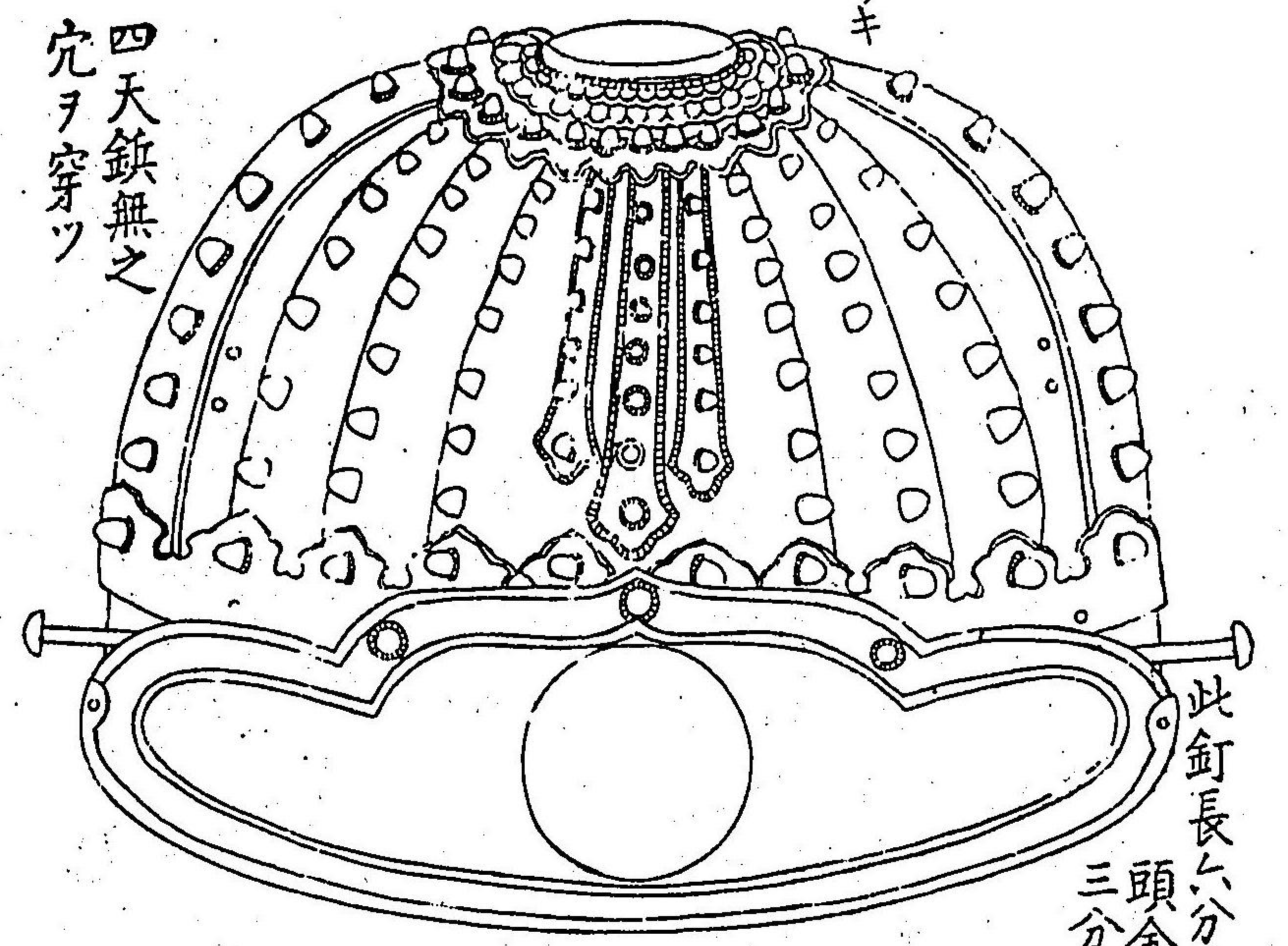

此釘長六分斗鉄釘
頭金メツキ但
三分

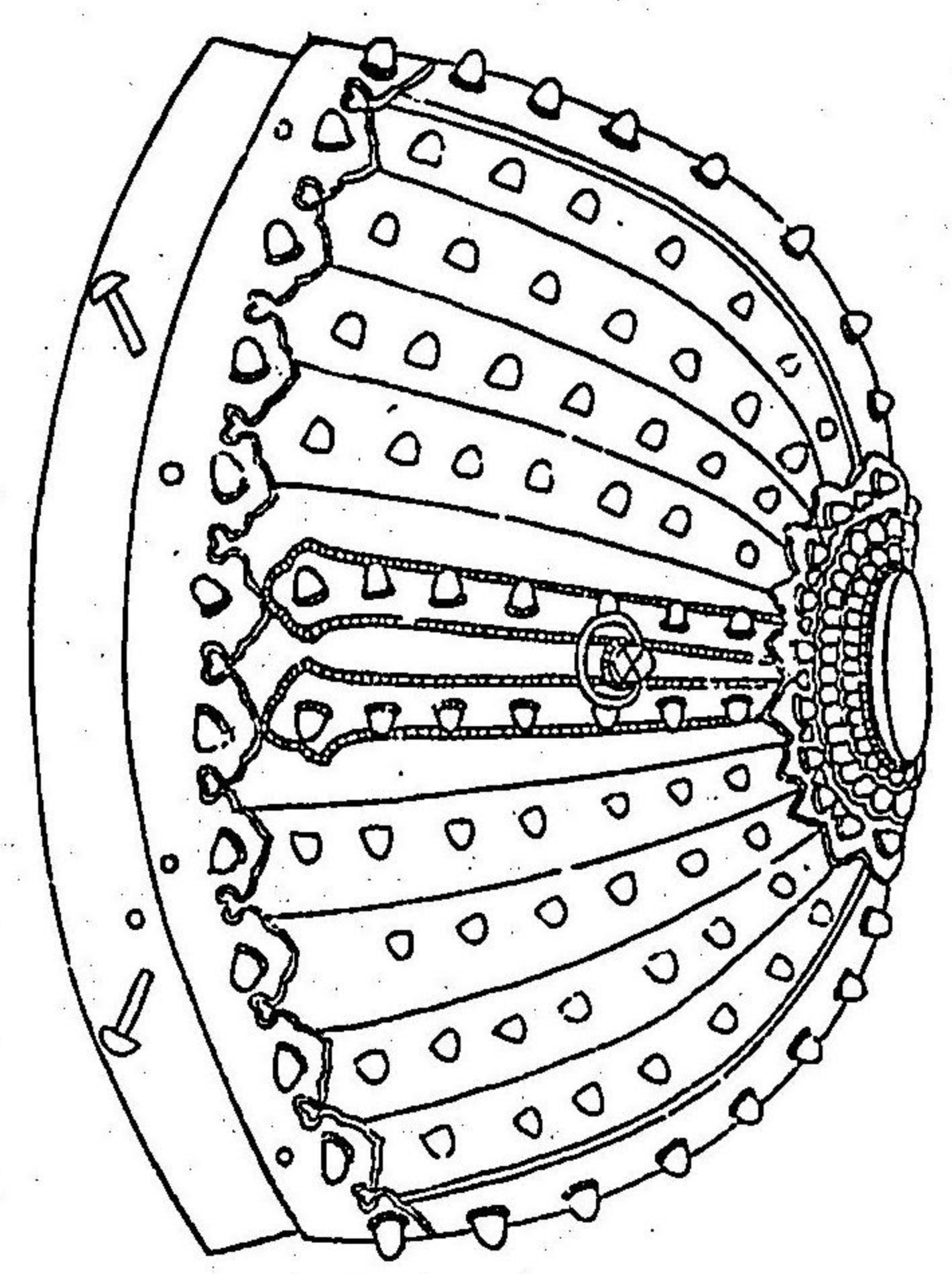

後

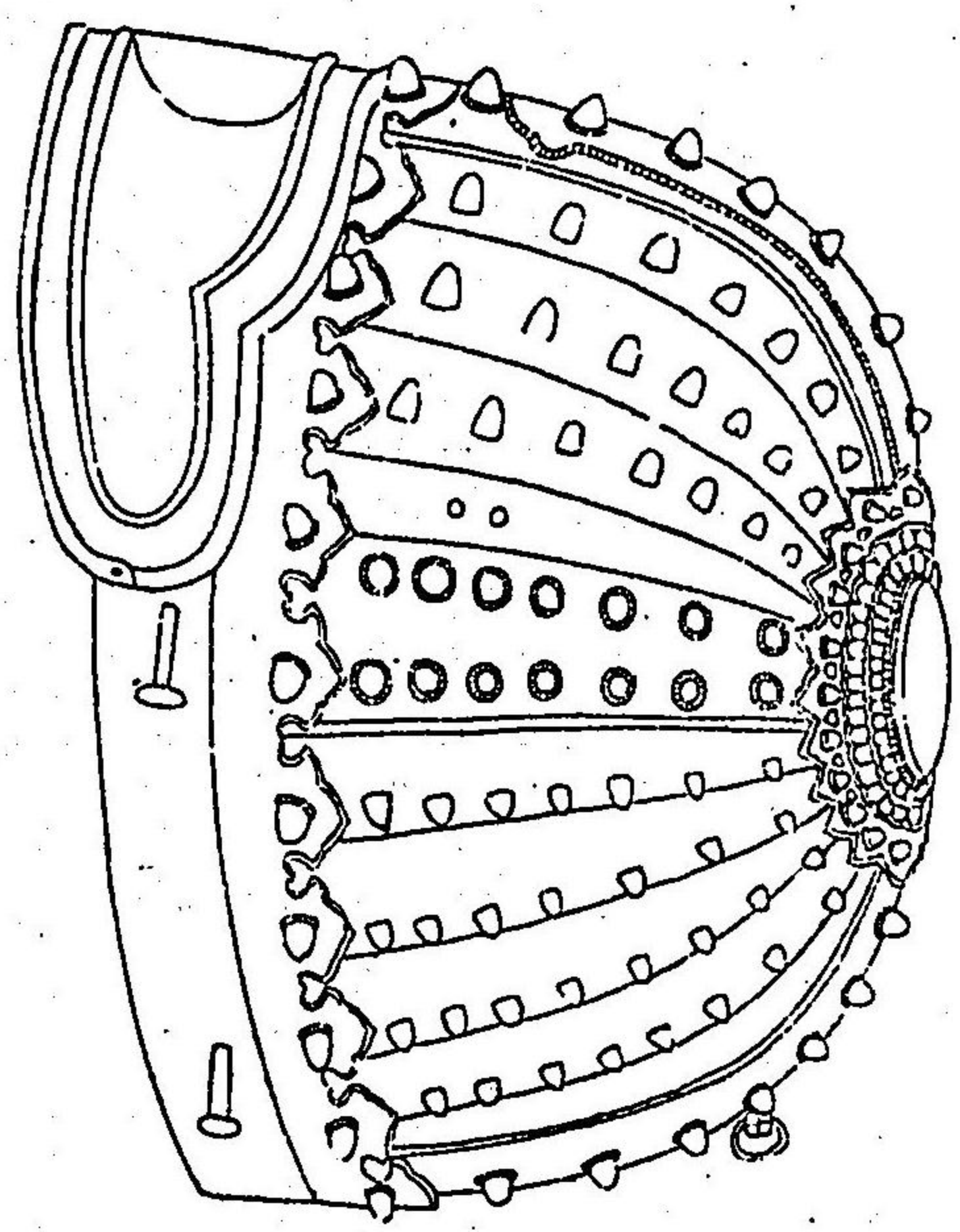

前

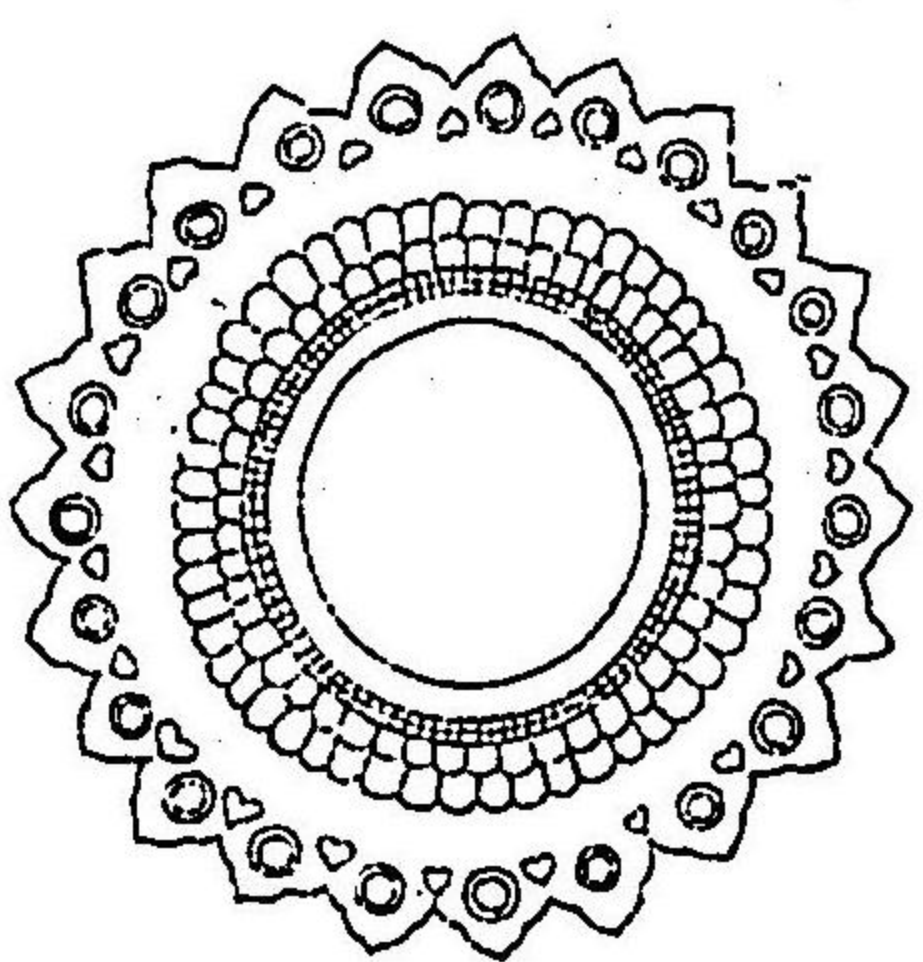
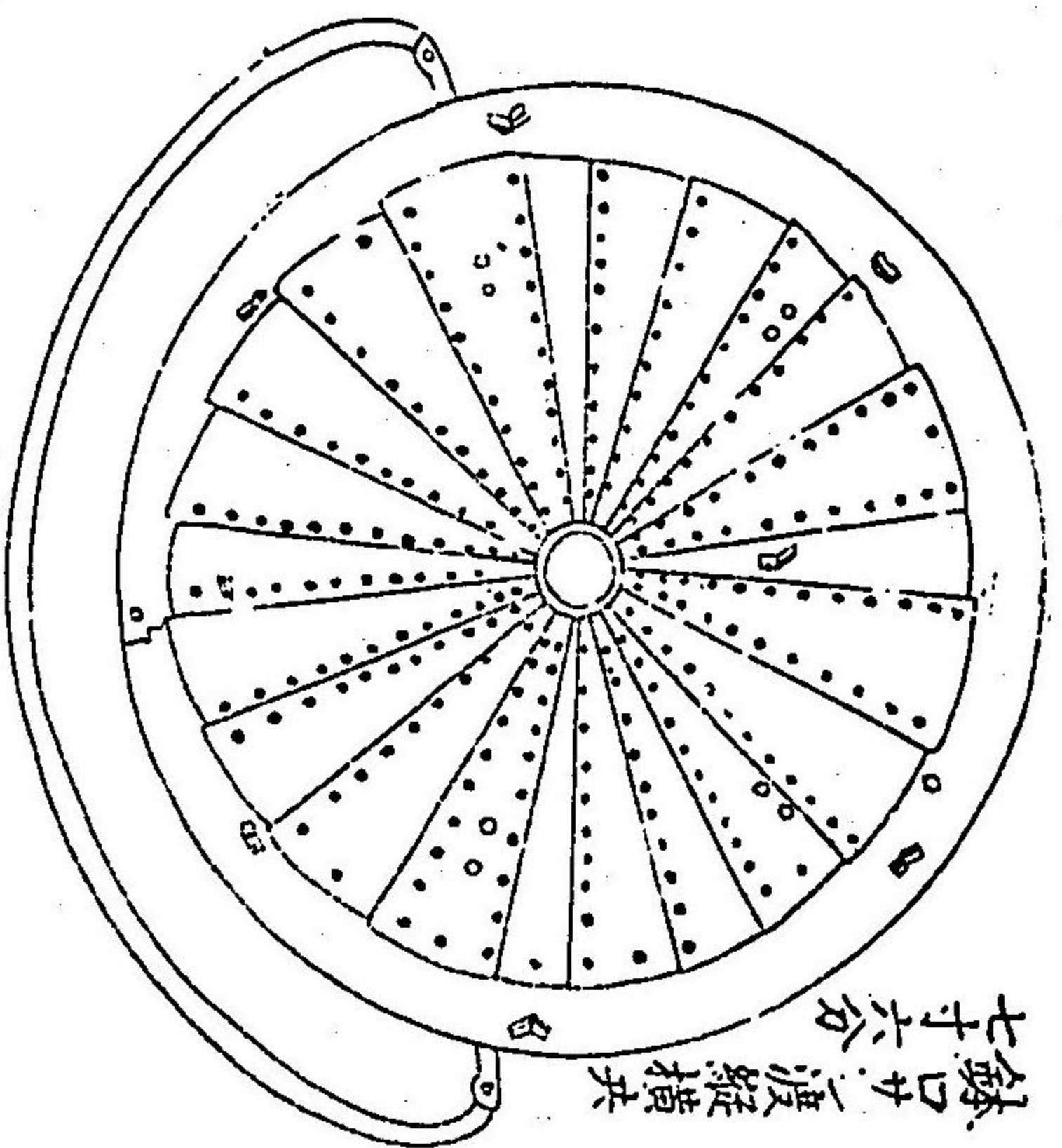

眉盾鉄欠金減金
裏獅子牡丹繪章
又以包
伏組ノ形
九里小縁
皆金ナシキ

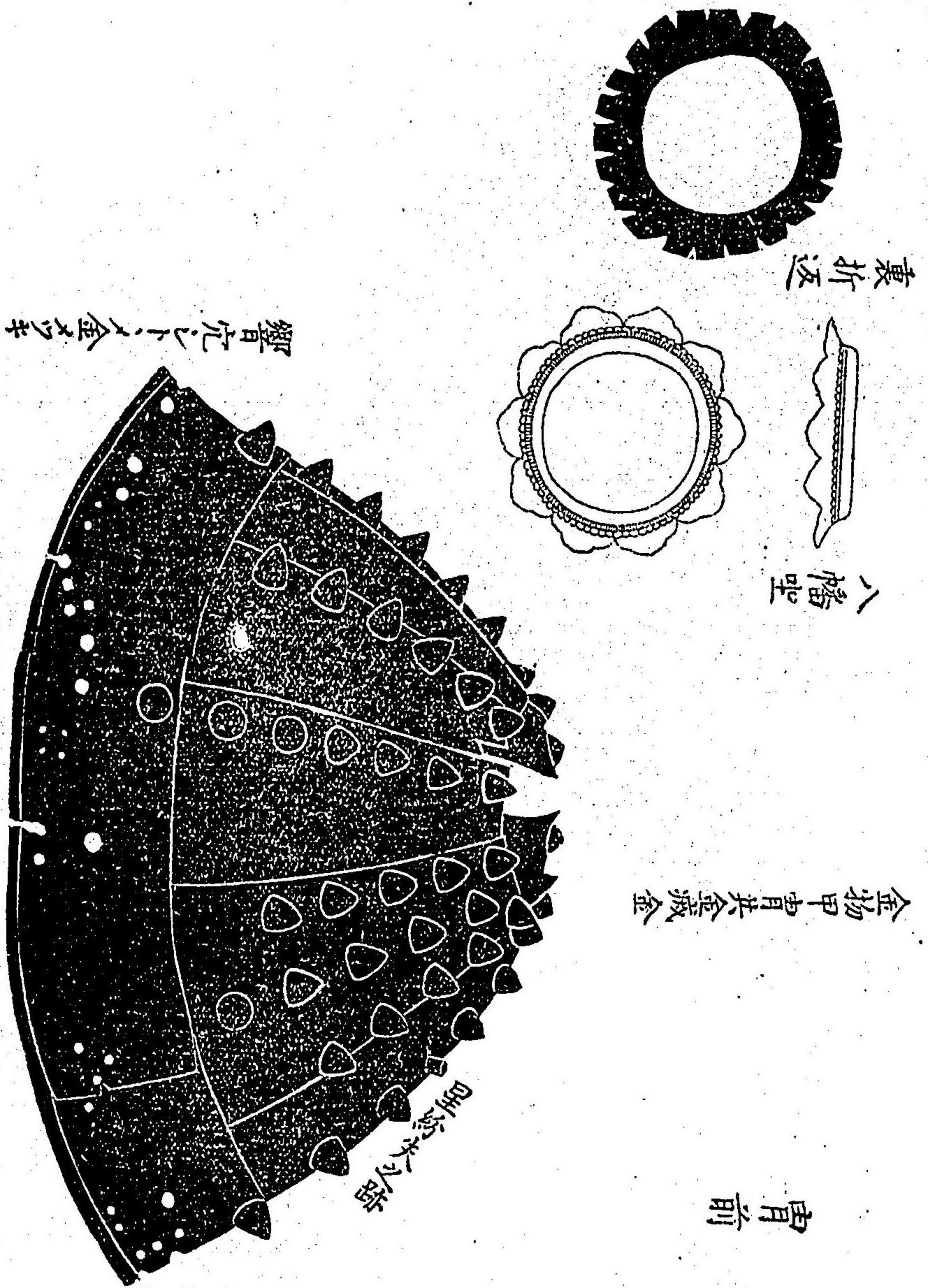
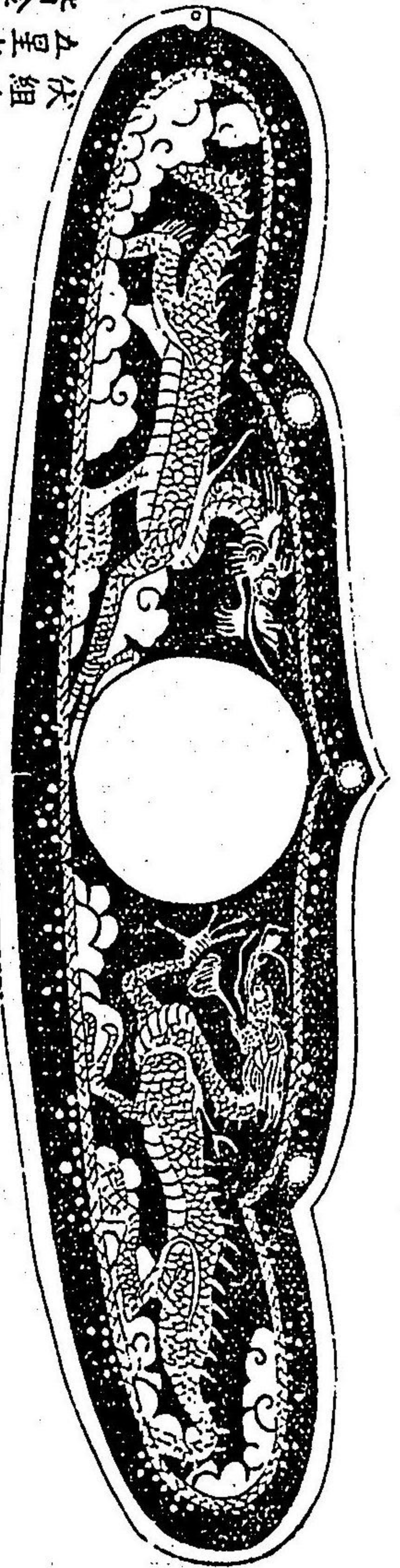

甲斐國菅田天神社藏武田家楯無甲冑圖

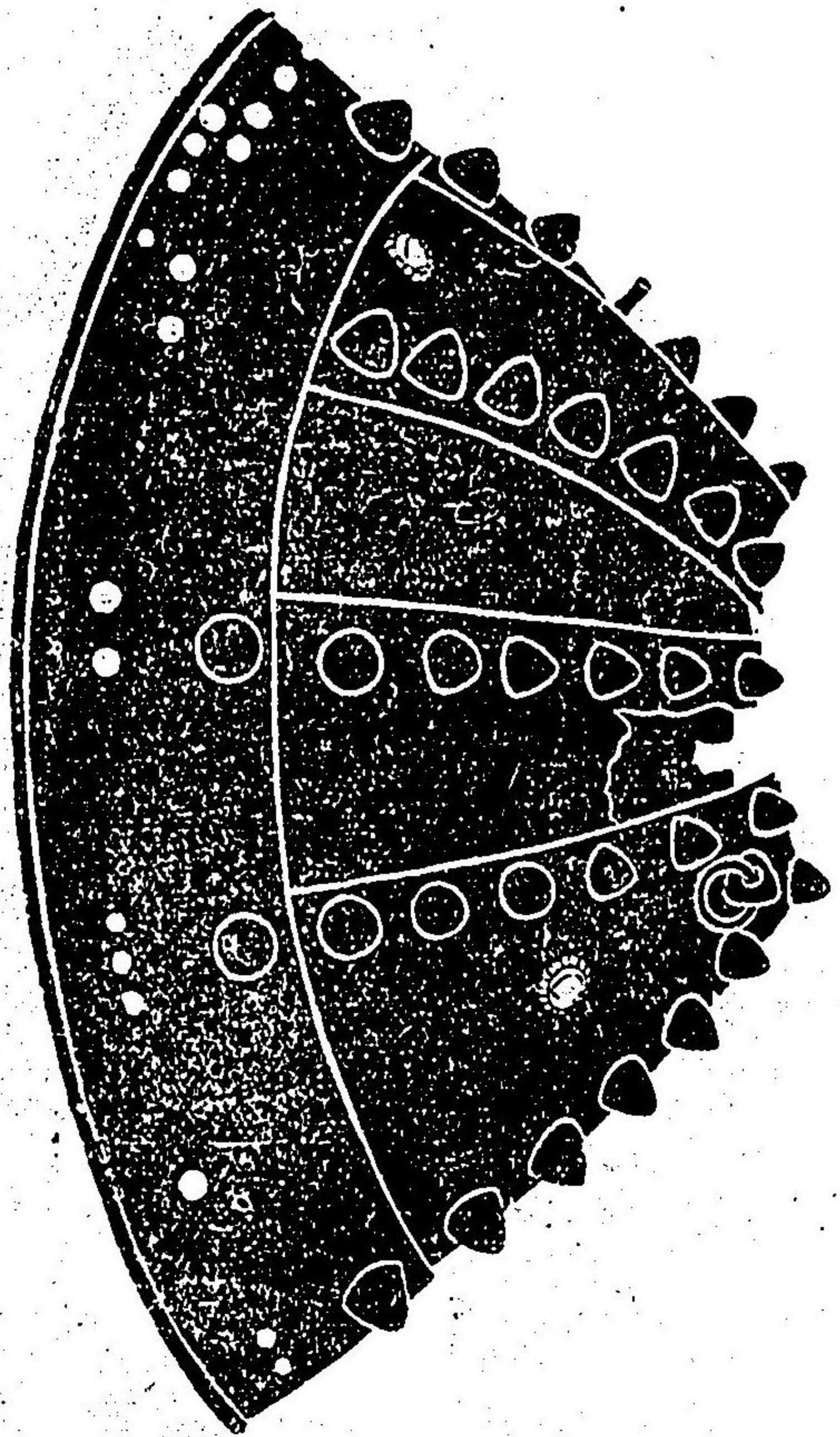

由月後

鍬形終夫

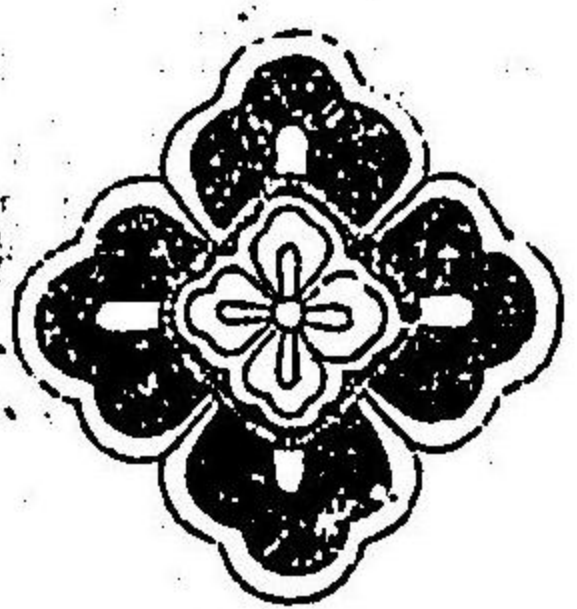
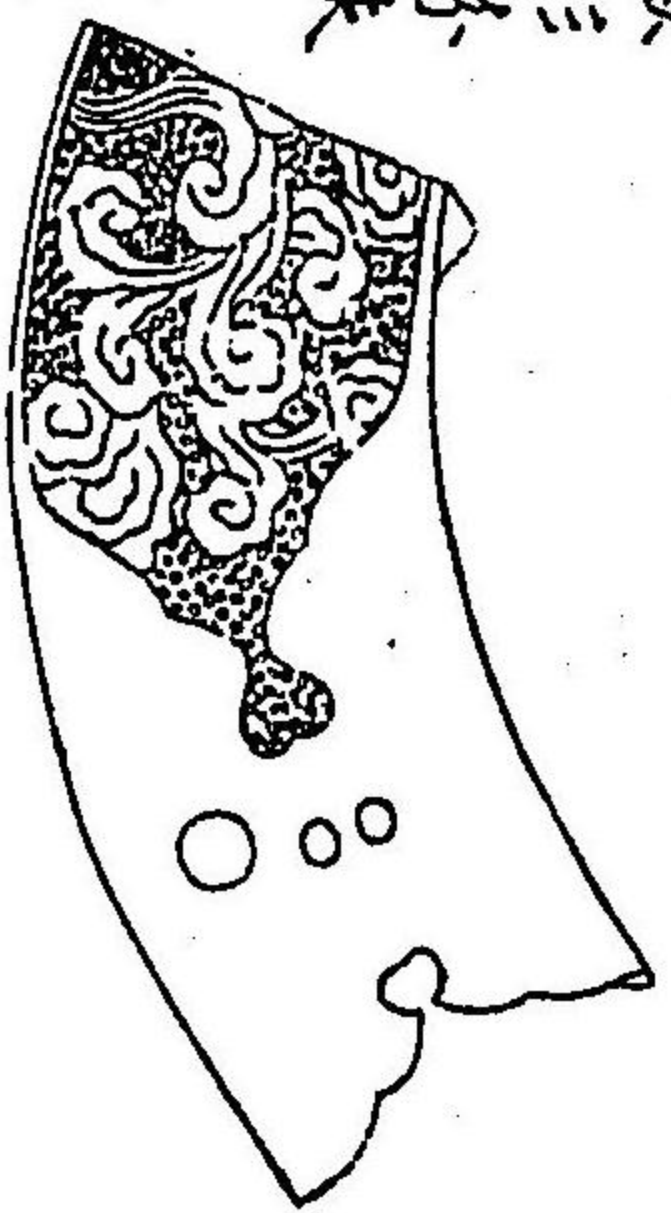

吹返金物二地板銀減金

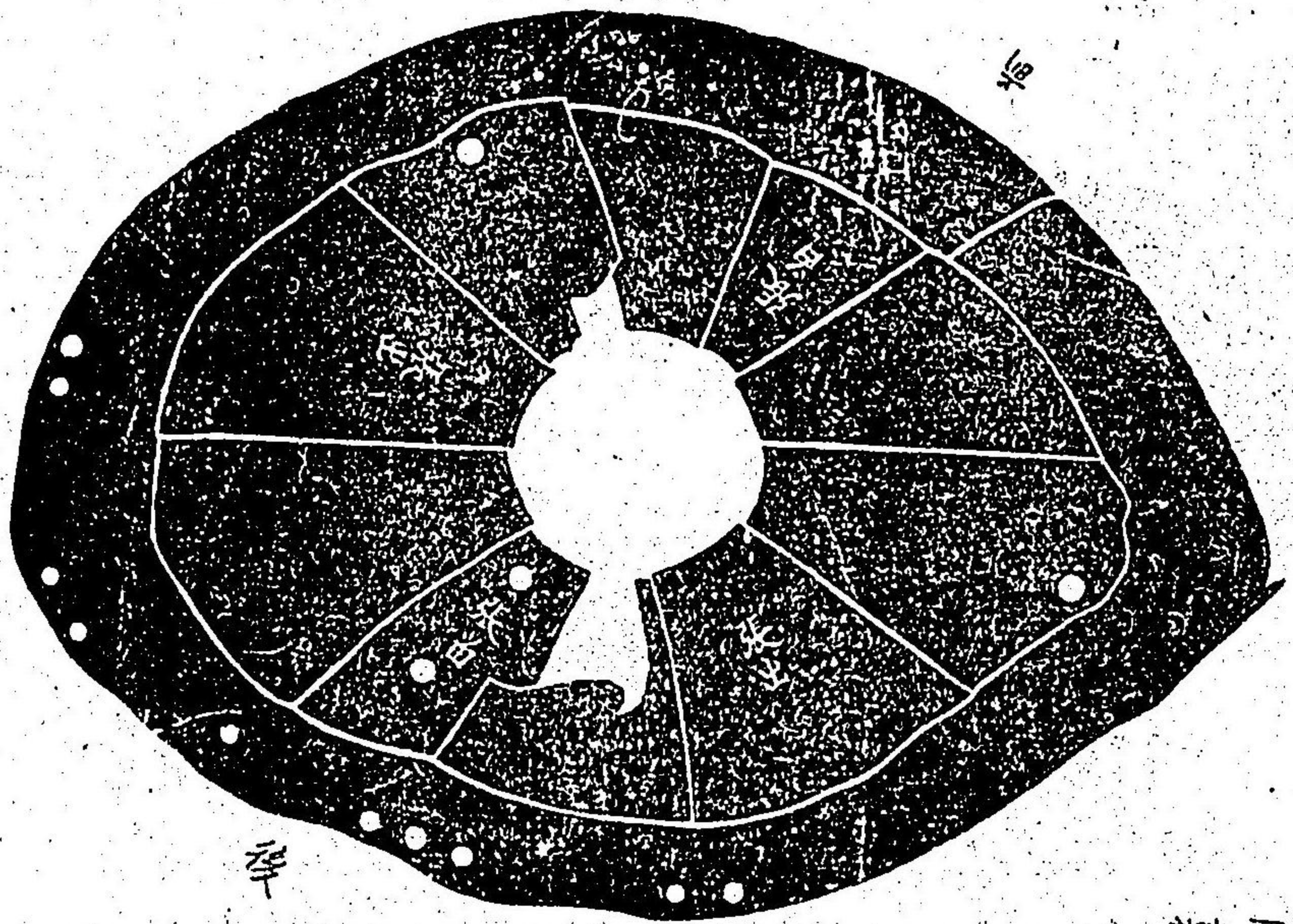

同裏

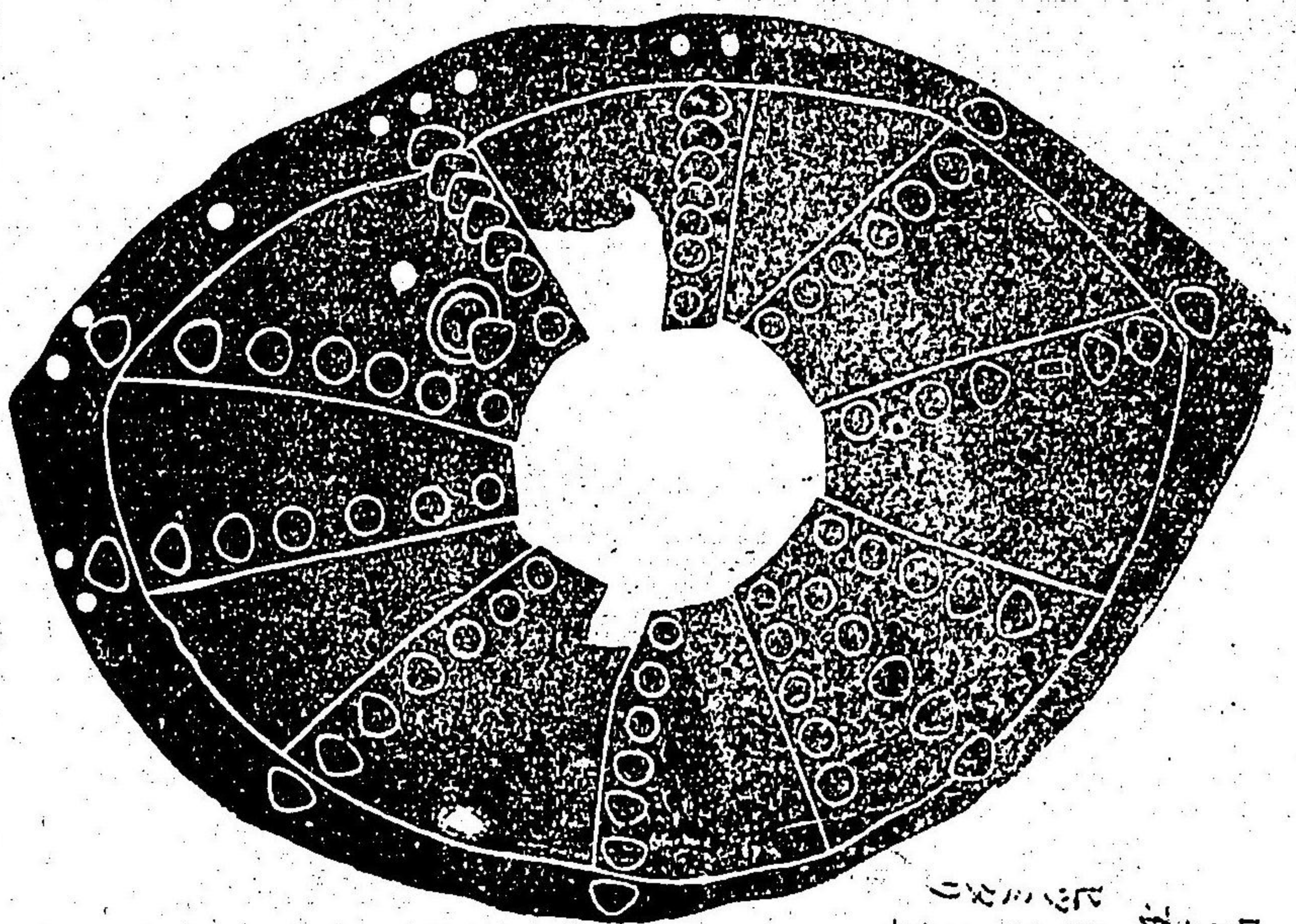

由表 鉢強ノオヒ
ヒツミカリ

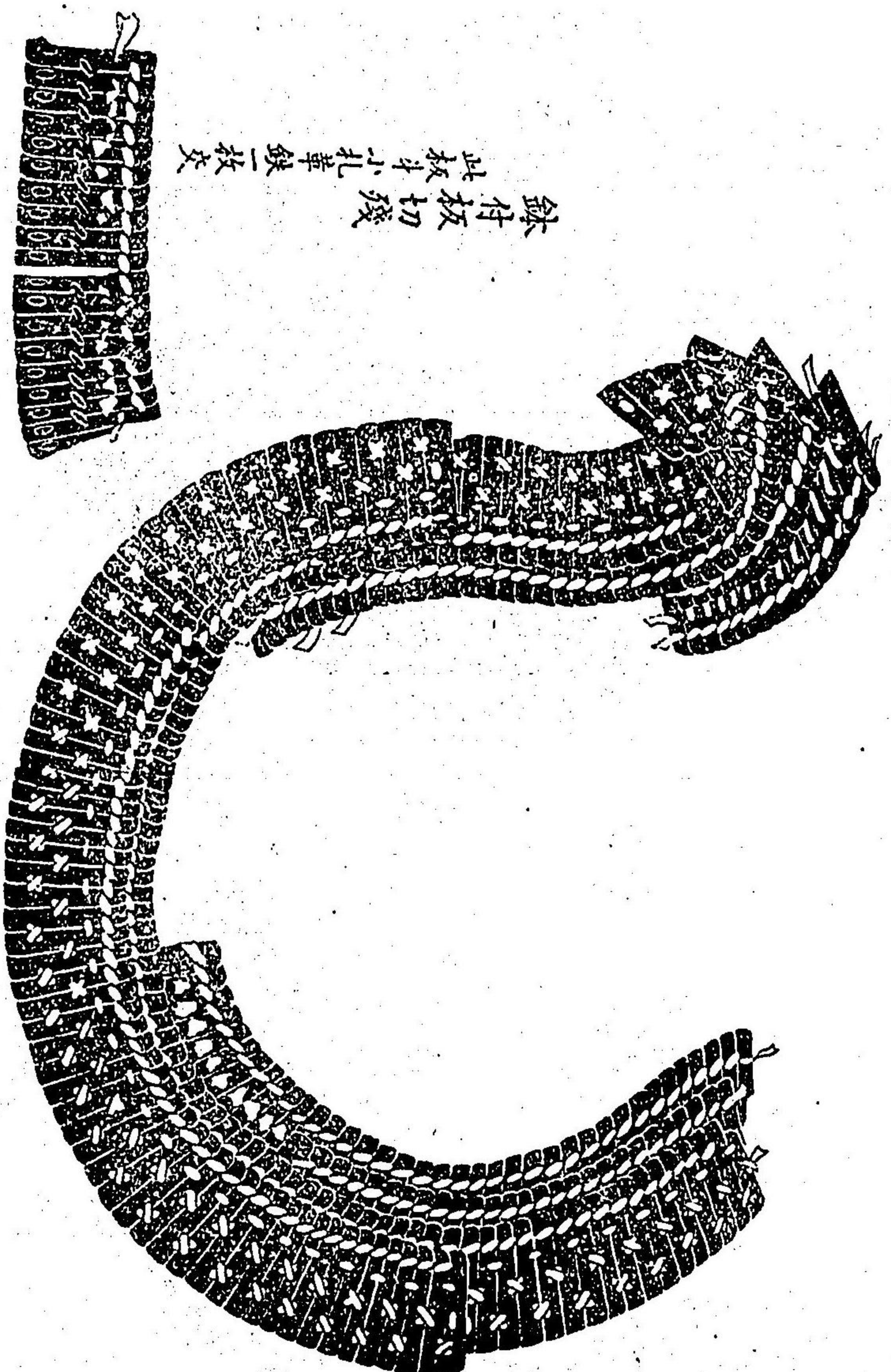

鞞
五枚吹返四枚革小札
菱縫緋

鉢付板切殘

此板牙小札華銀一枚矣

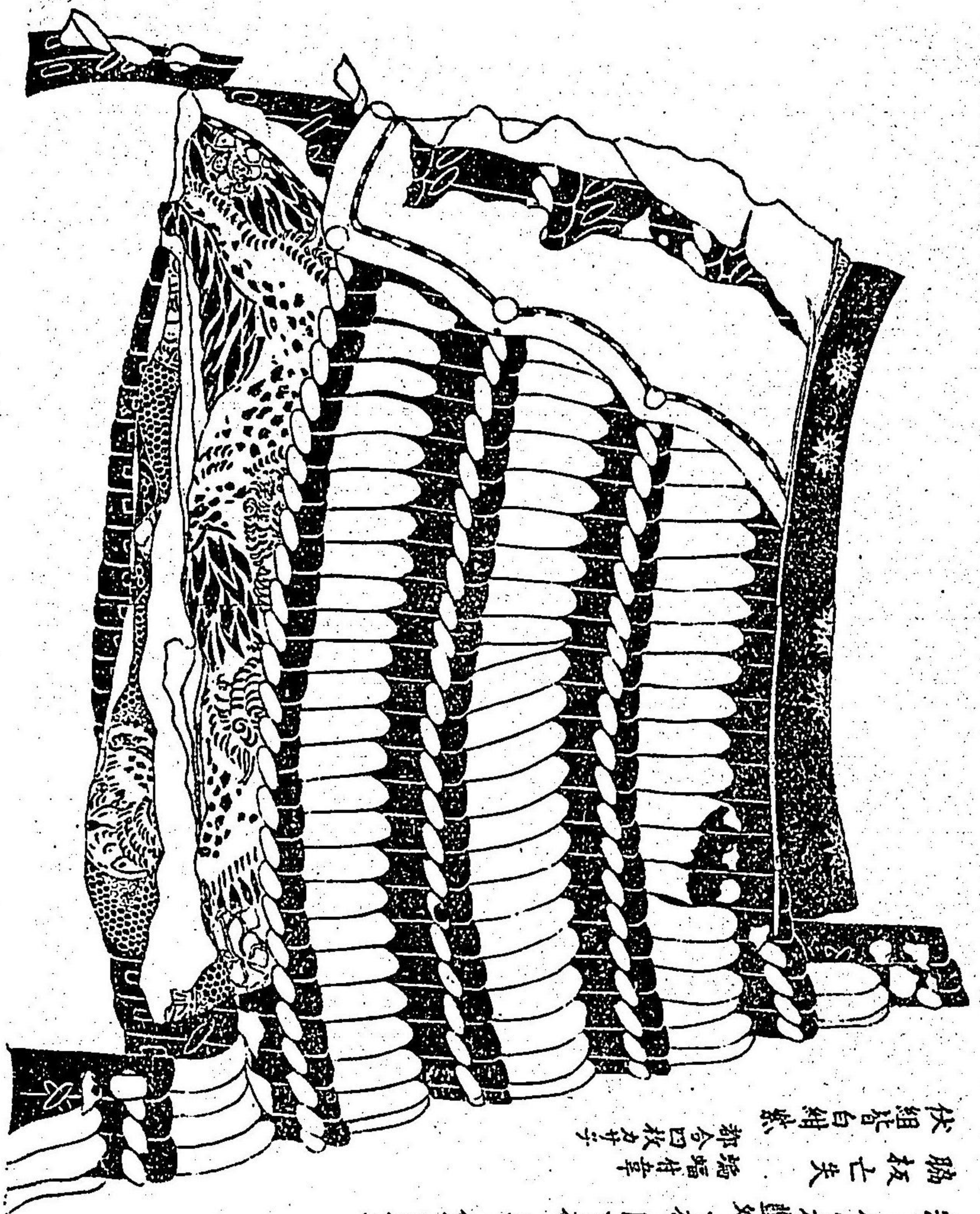

鎧胸射向
惣三威小櫻白地小櫻、圖前板出之餘、墨之

脇板亡失
端幅付韋
都合四枚乃半

伏組皆白緋、然

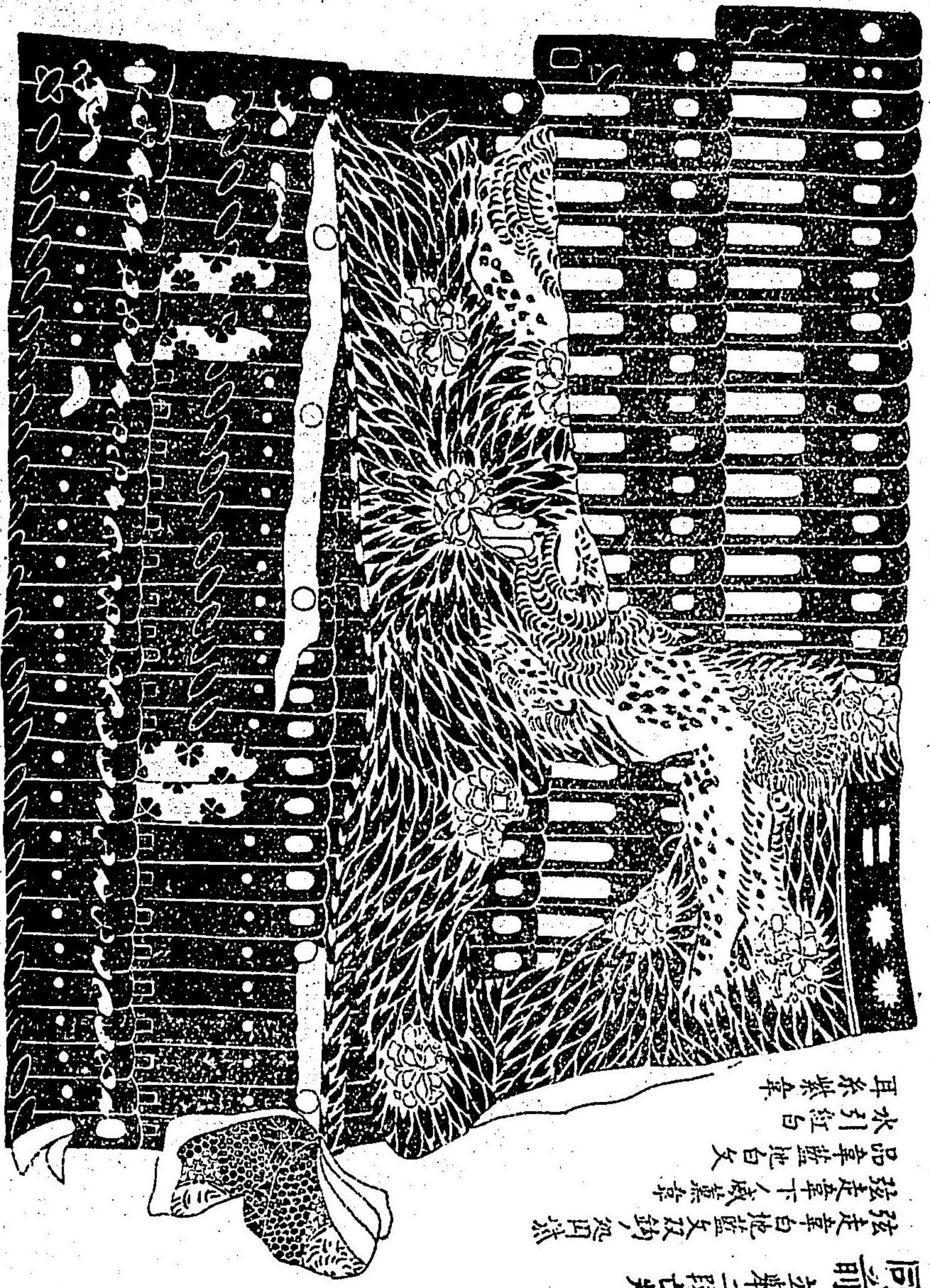

同前之舉二段亡失
 弦走草白地藍文及鈎、從圓珠
 弦走草下、威葉草
 品草藍地白文
 水引紅白
 耳系紫草

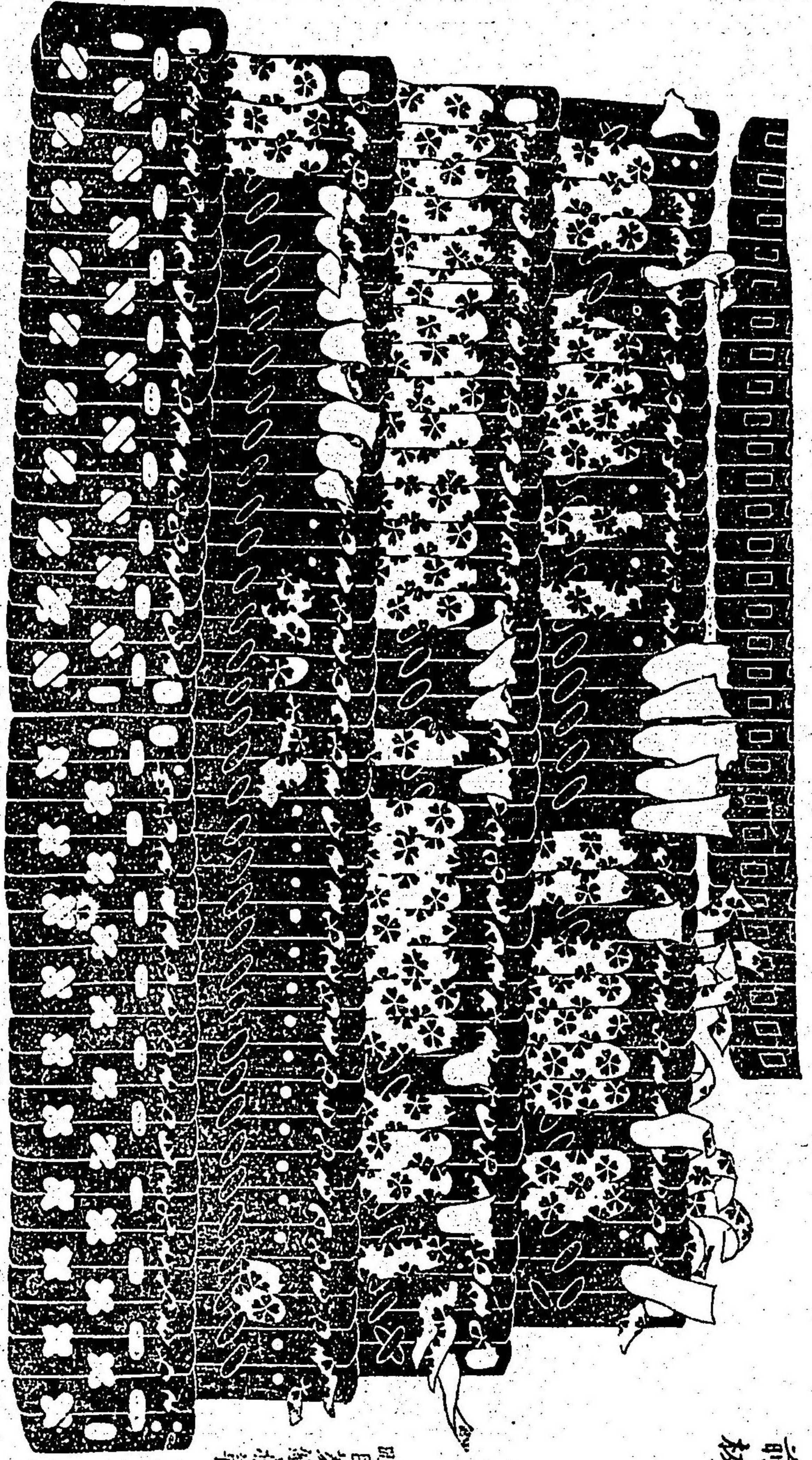

前板
 睦目交變亦草

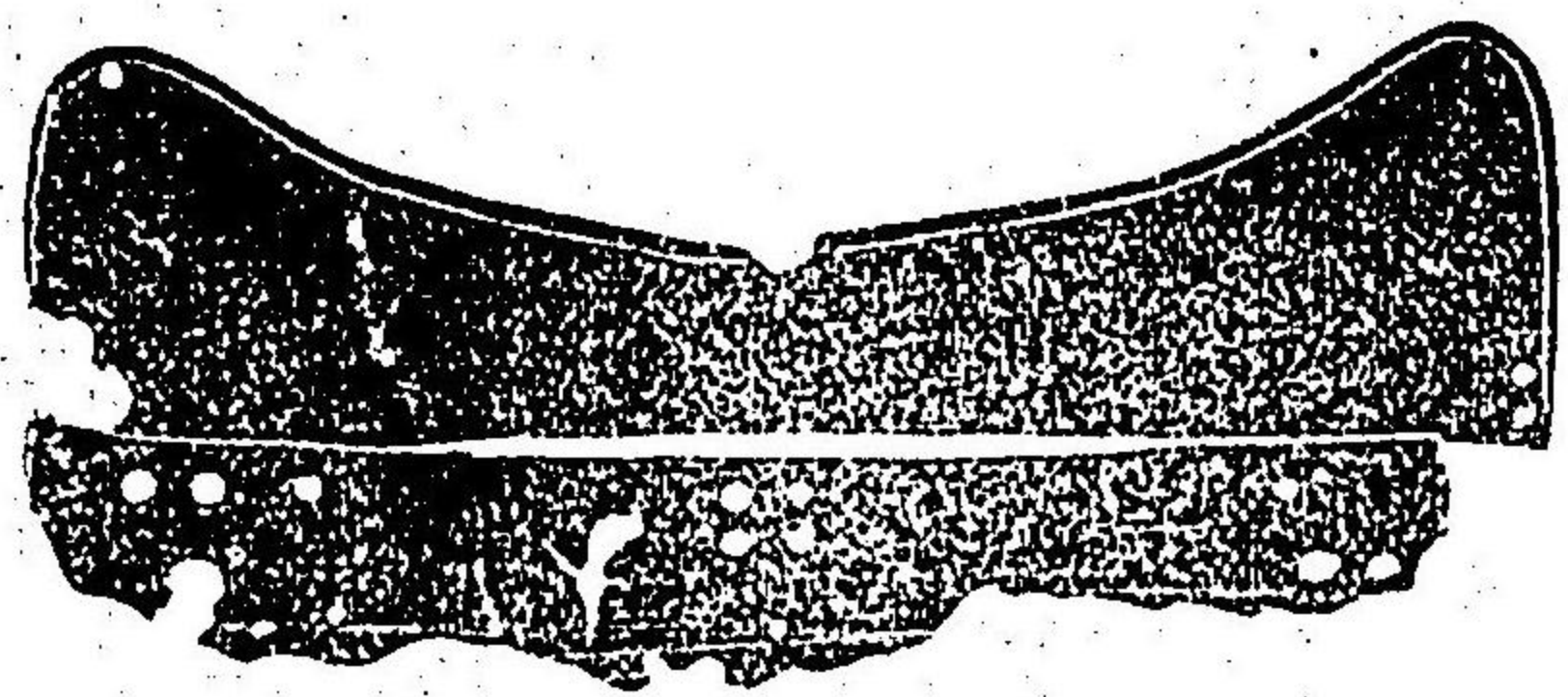

間金物地板銀減金



胸板 損失如圖

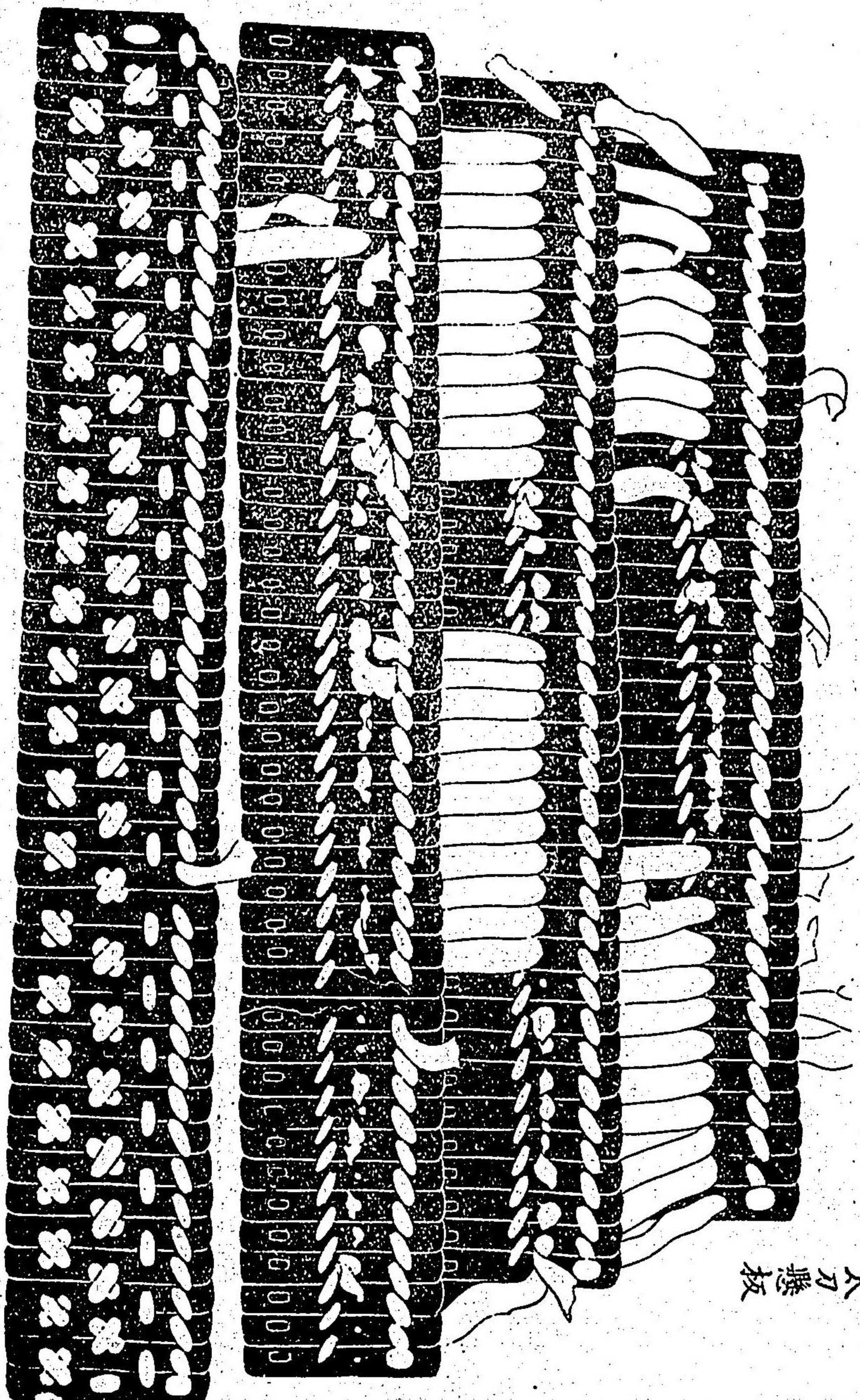

太刀懸板

脇楯
強クイセテ筋違ニ表、方カリヨリ
漆ニテ銷留アリ包章亡夫

ナリ衆ノ

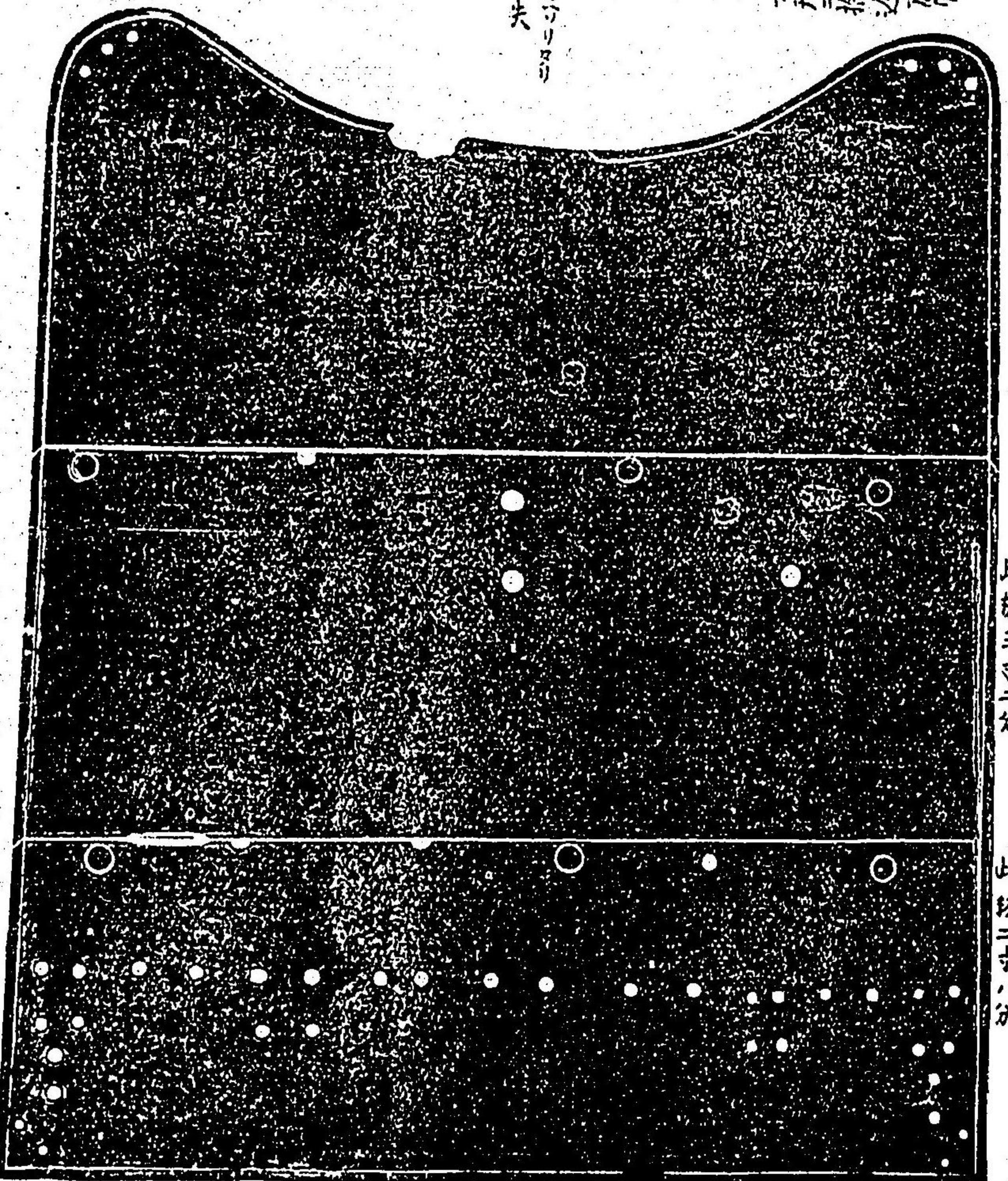

此板三寸五分

此板三寸二分

此板二寸八分

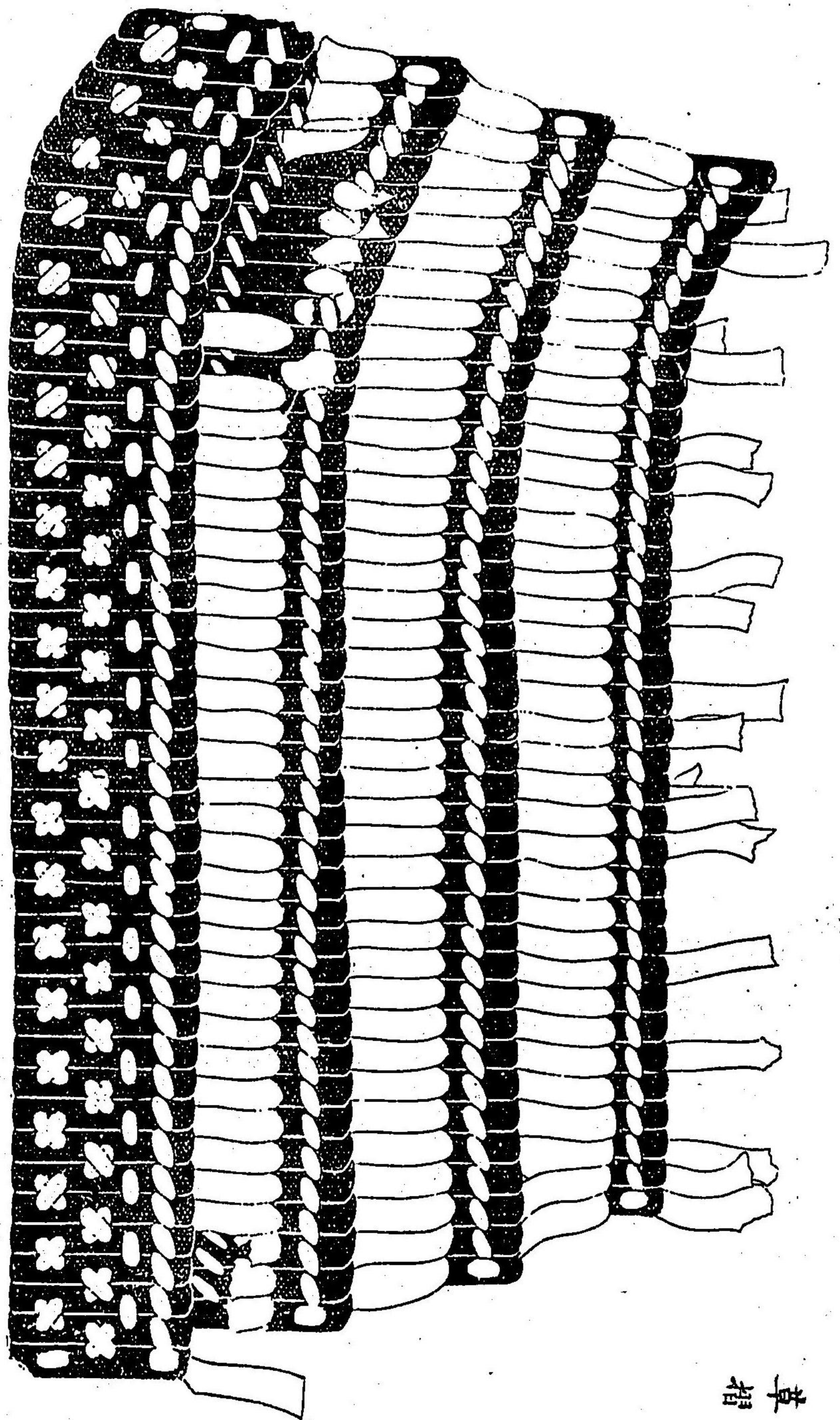

甲冑

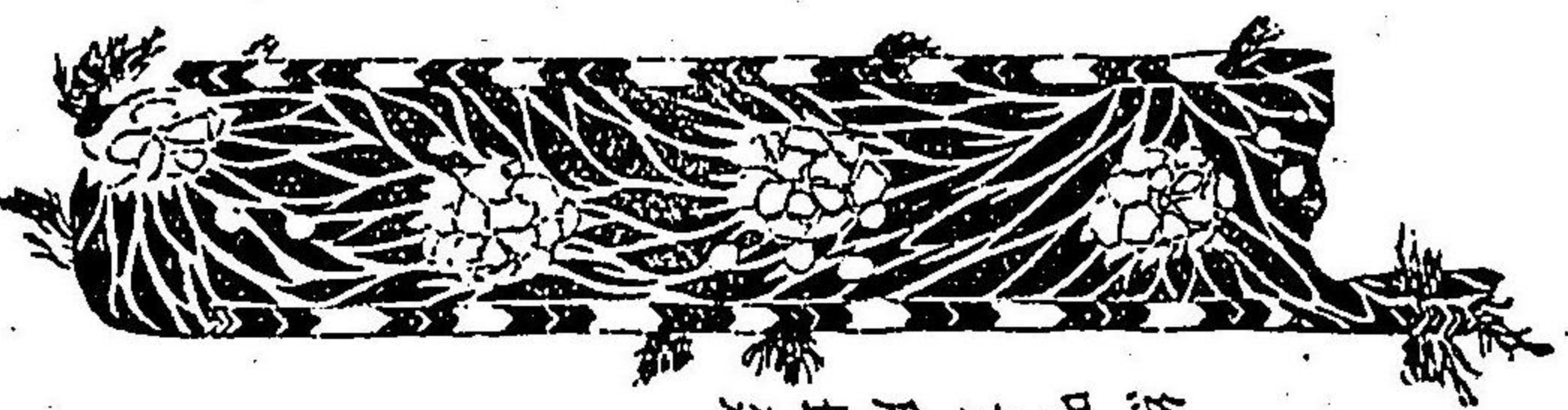

綿嚙草所切殘 年孩之同

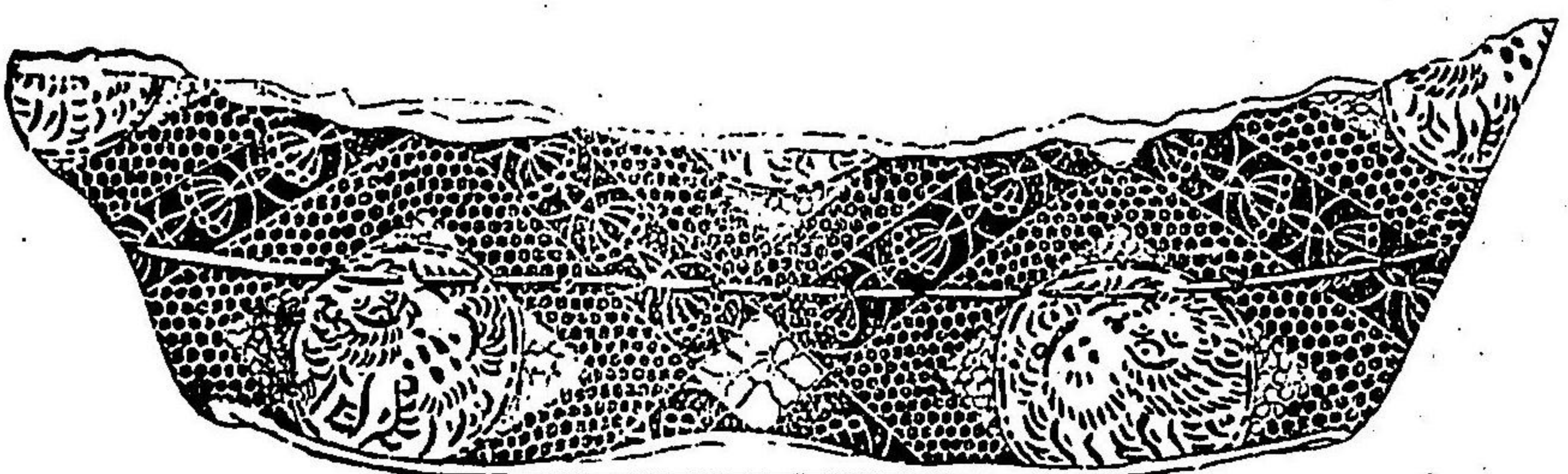

蝙蝠付草ノ裏
藍地白文及鈎ノ所叫紫
中央ノ綴糸白花田二筋

逆板

同裏

耳糸紅絹末

葵赤草

安奈縫ノ重

上下如此

鞆ノ葵三

如此所

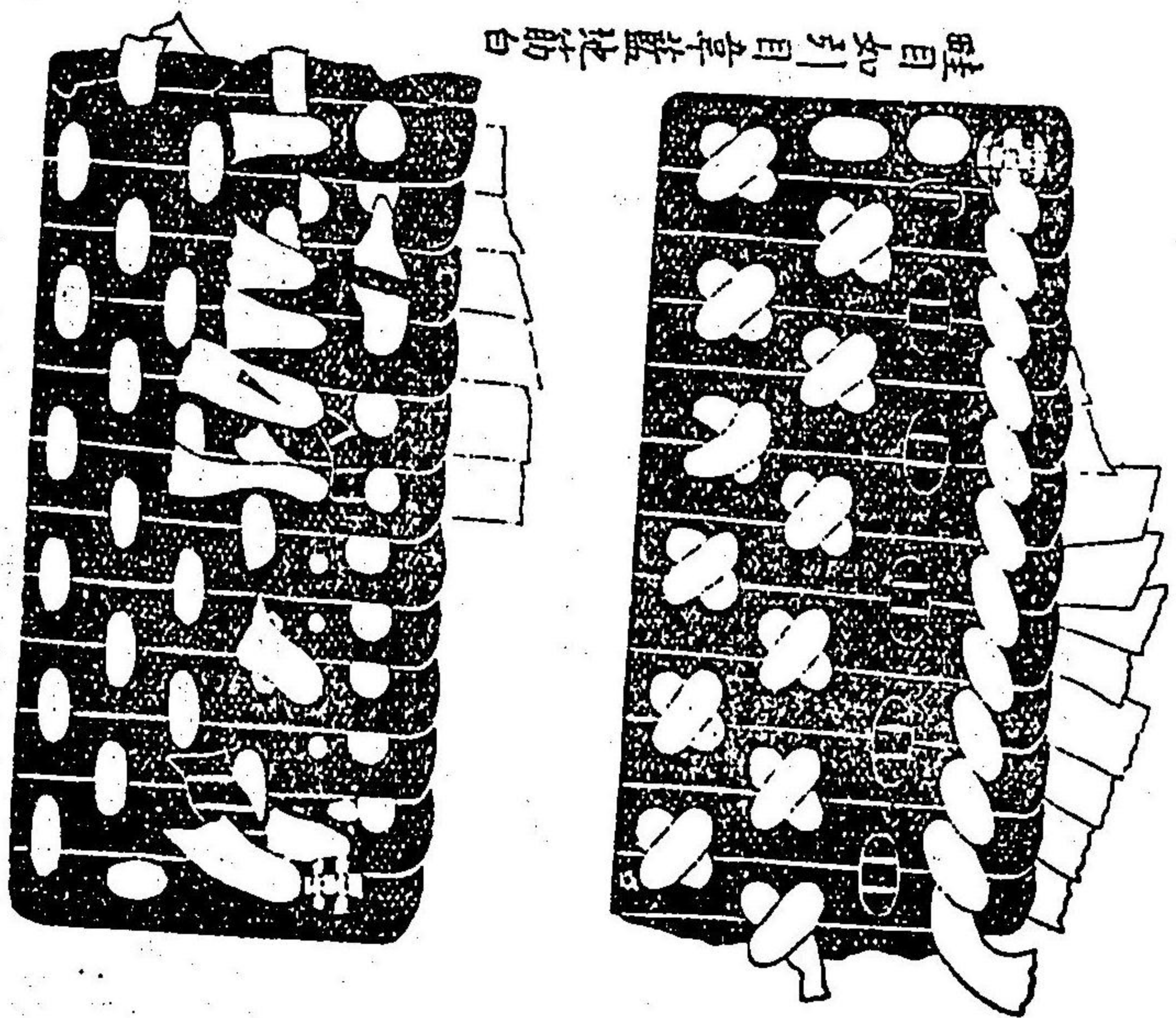
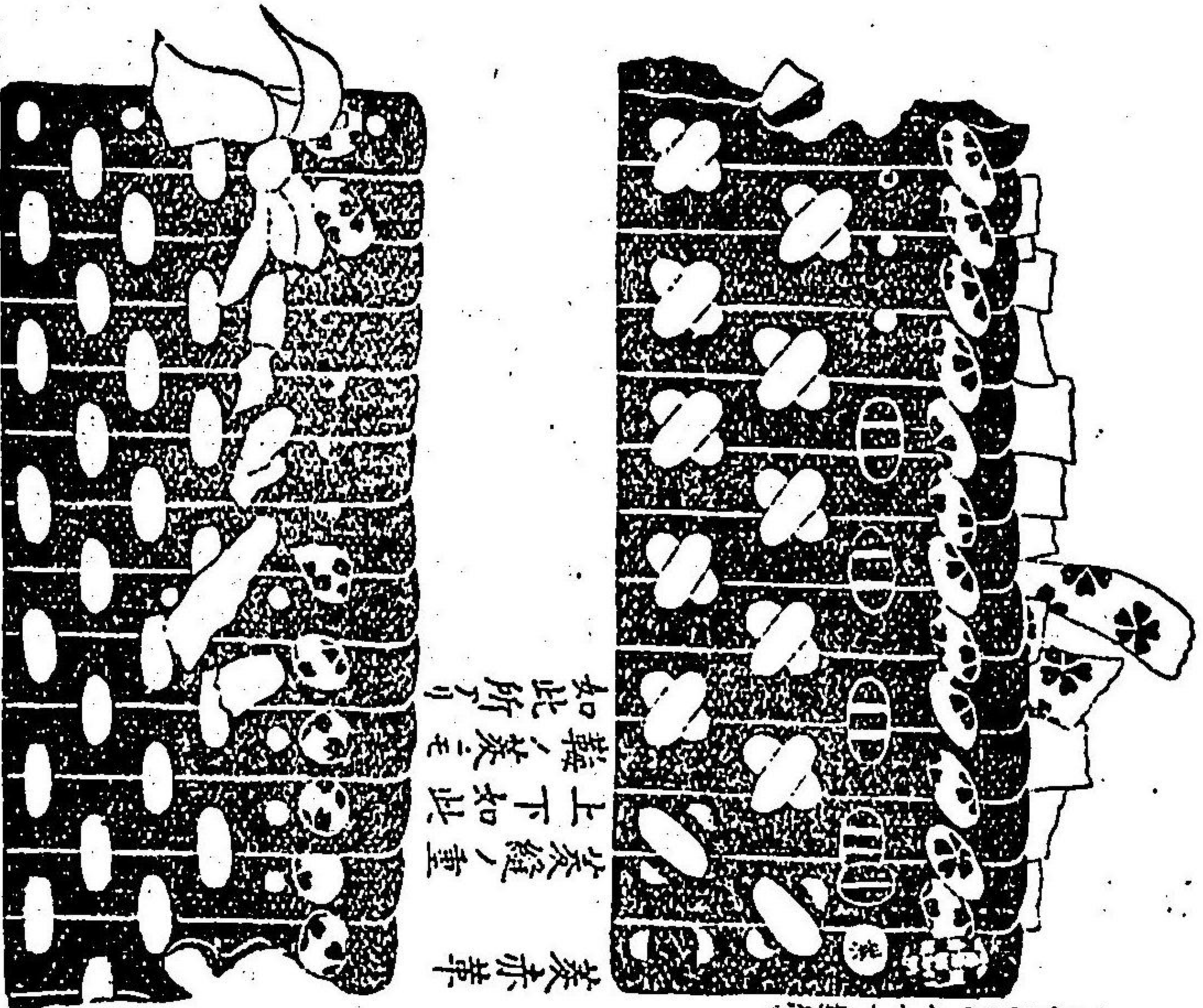

畦目如引自草藍地筋白

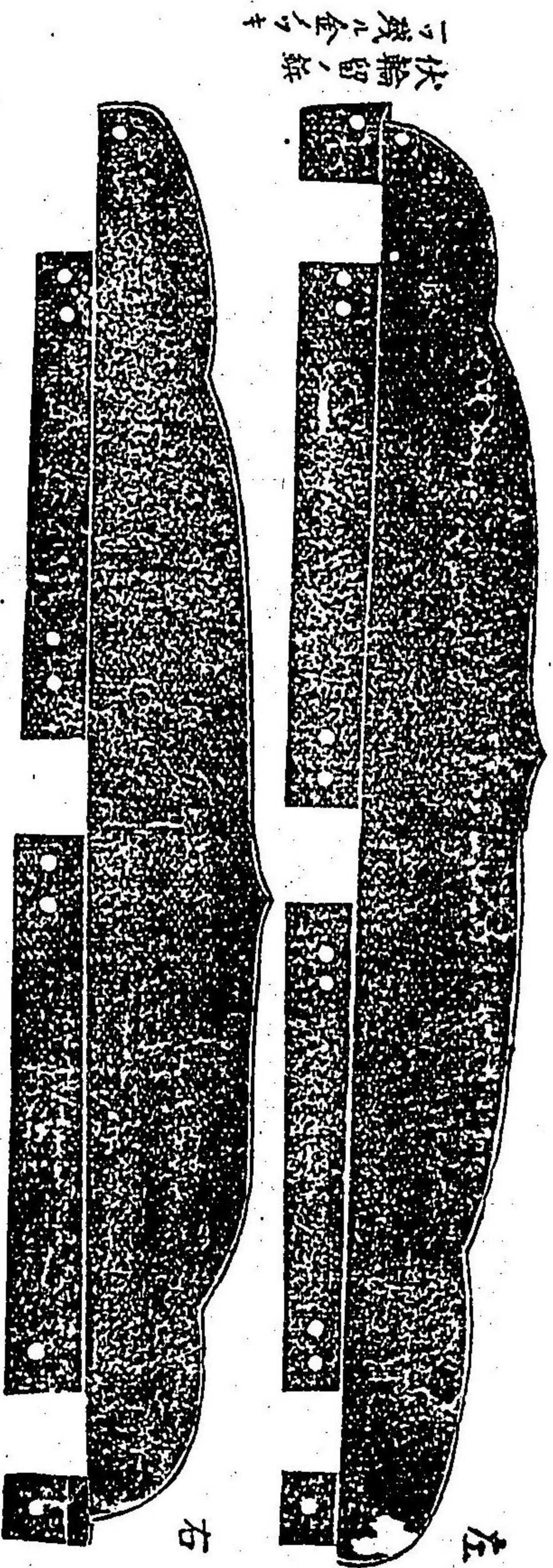

袖冠板
漆ニテ繪留リ縁拾返リ
包卓亡夫
左
右

伏輪留ノ跡
ニ殘ル金ノキ

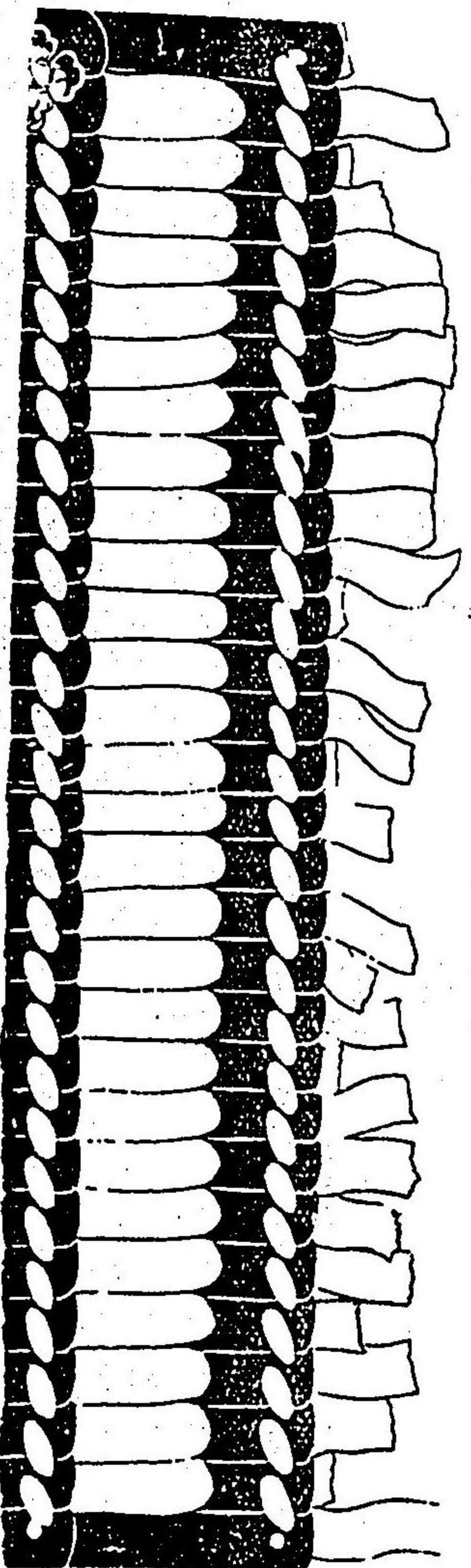

五段小札重三節手
指ノ睡目差縫亦畢

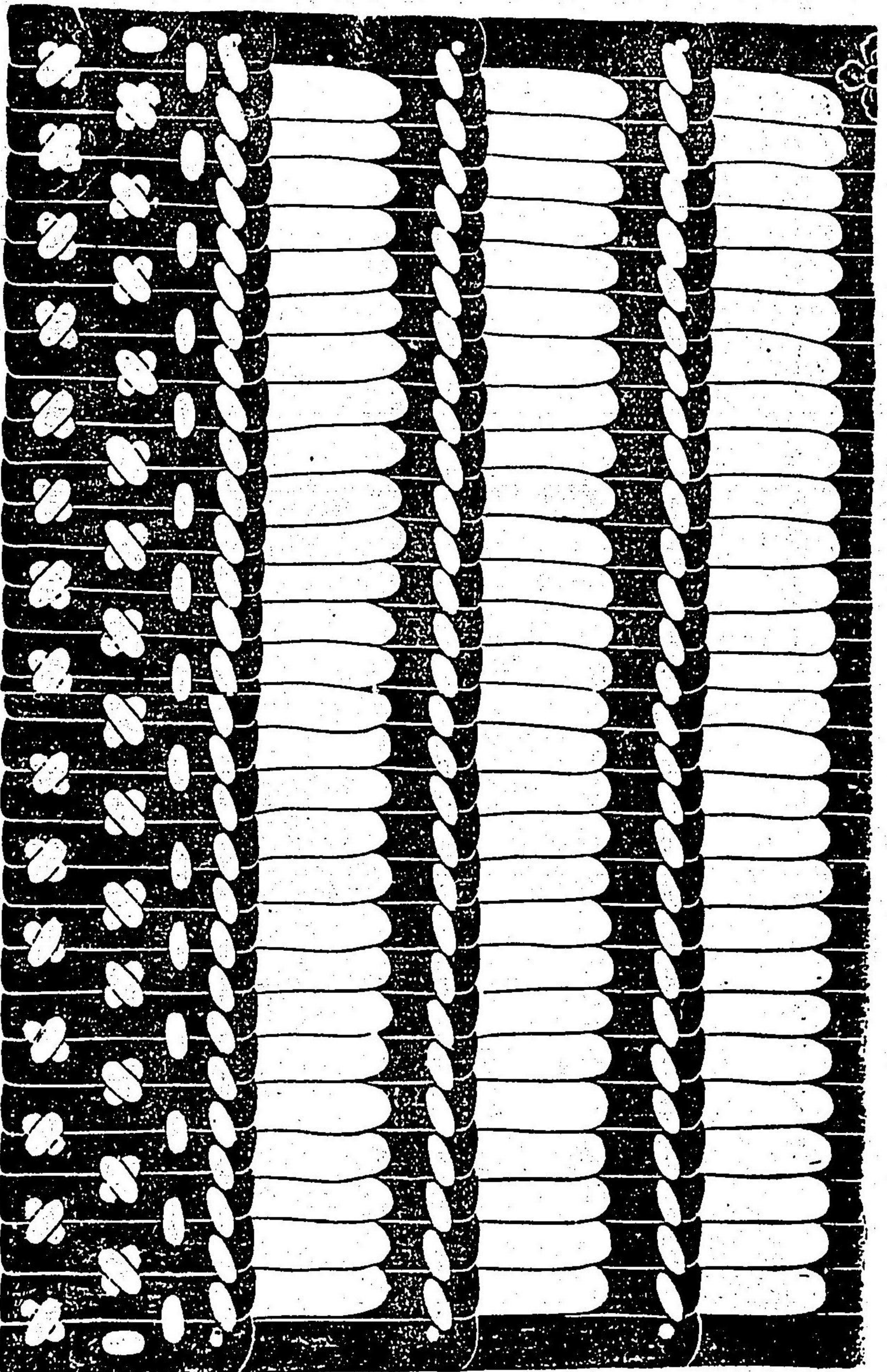

鎧後

綿嘴押付板及小札胸一段亡失胸長下四カワニテ六寸五分程
 胸廻り上ニテ二尺五寸程下ニテ二尺七八寸程小札葦鉄交
 胸形オセヒラミテ寸尺委ク分リカクシ 胸先ノ緒ノ虎小札ニ枚目ニ
 アリ前後共ニ同

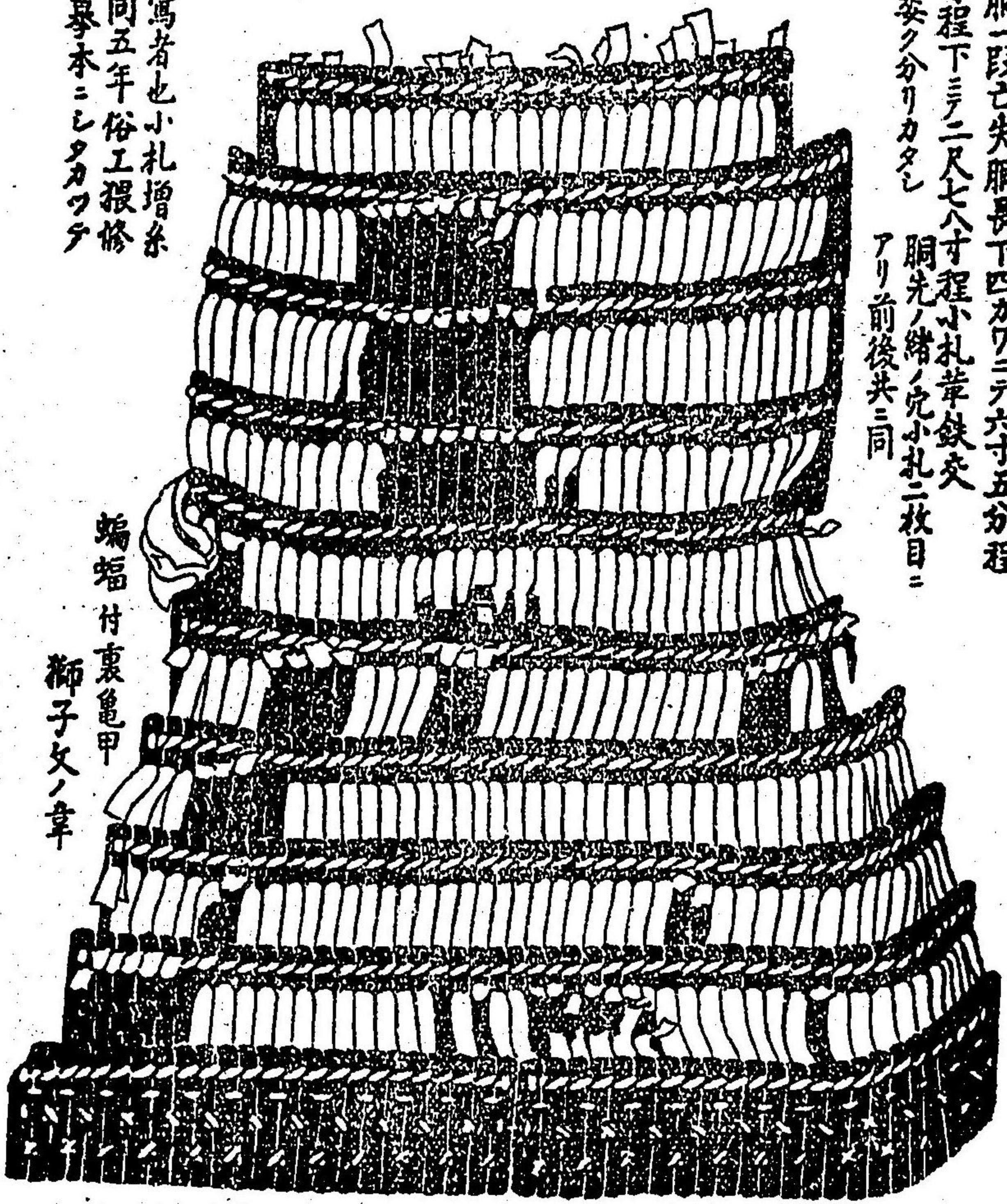

綿嘴付裏龜甲
 獅子文ノ韋

此甲冑寛政四年或所摹寫者也小札増糸
 之類少シノ疑ナキ一不能同五年俗工撥修
 補ヲ加フ故今無后微一ニ摹本ニシテカクテ
 暫出之

家藏楠正成卿胸丸及大袖圖

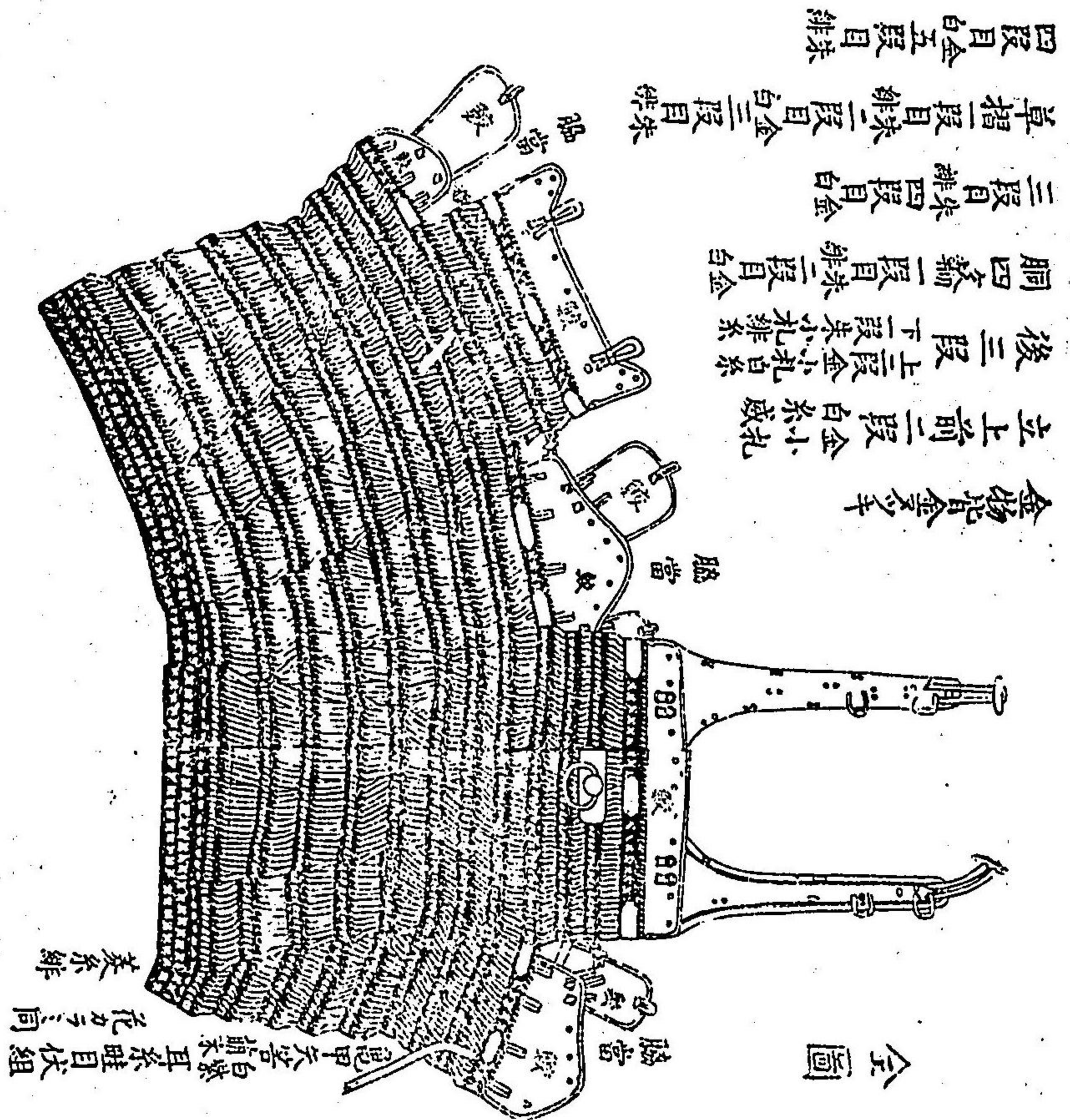

金物糸金分斗
 立上前二段金小札
 後三段上段金小札
 下段糸小札
 胸四輪一段目糸
 三段目糸四段目糸
 草摺一段目糸二段目糸
 三段目糸
 四段目糸五段目糸

全圖
 聽當
 聽當
 花カマ同
 素糸解

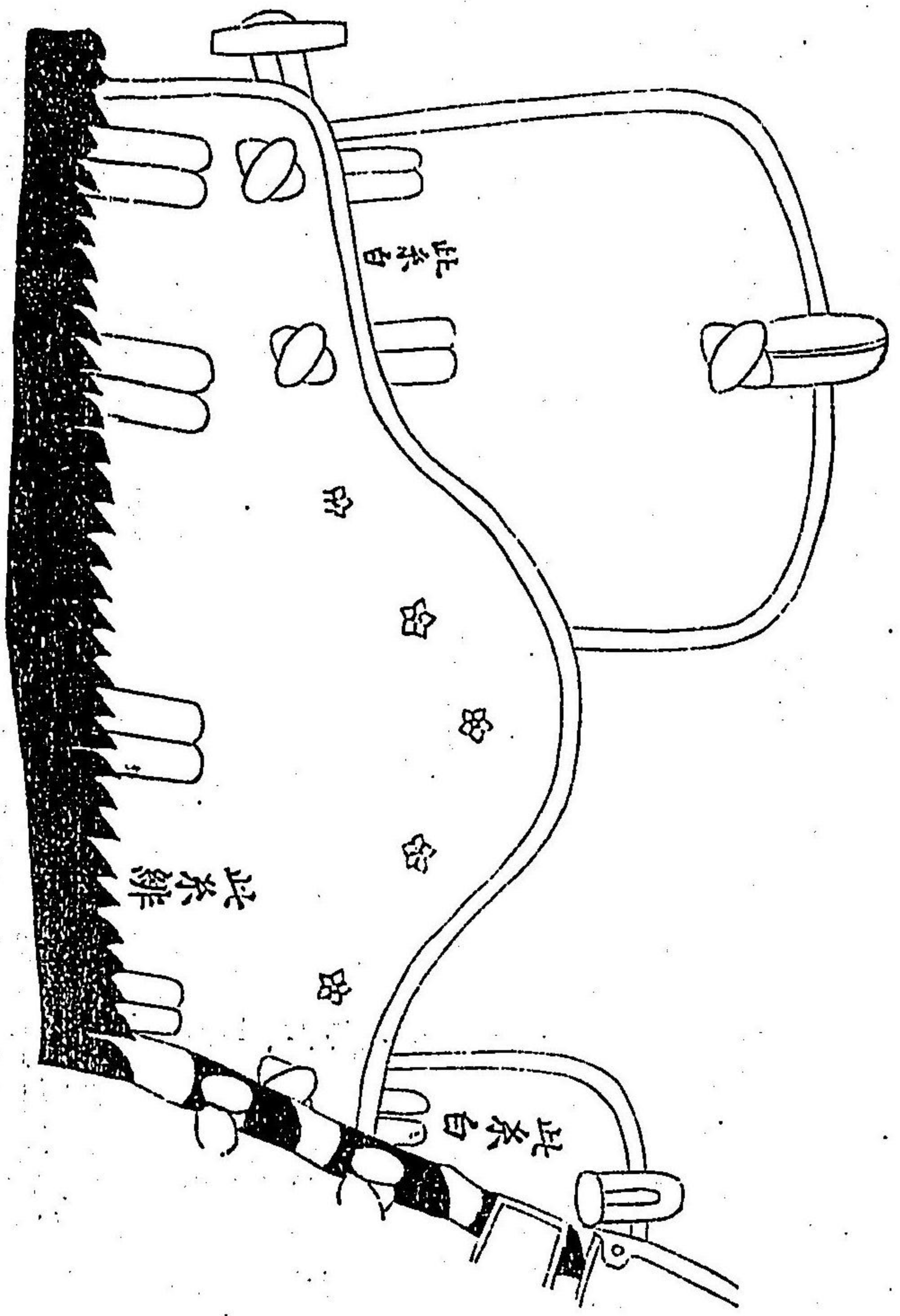
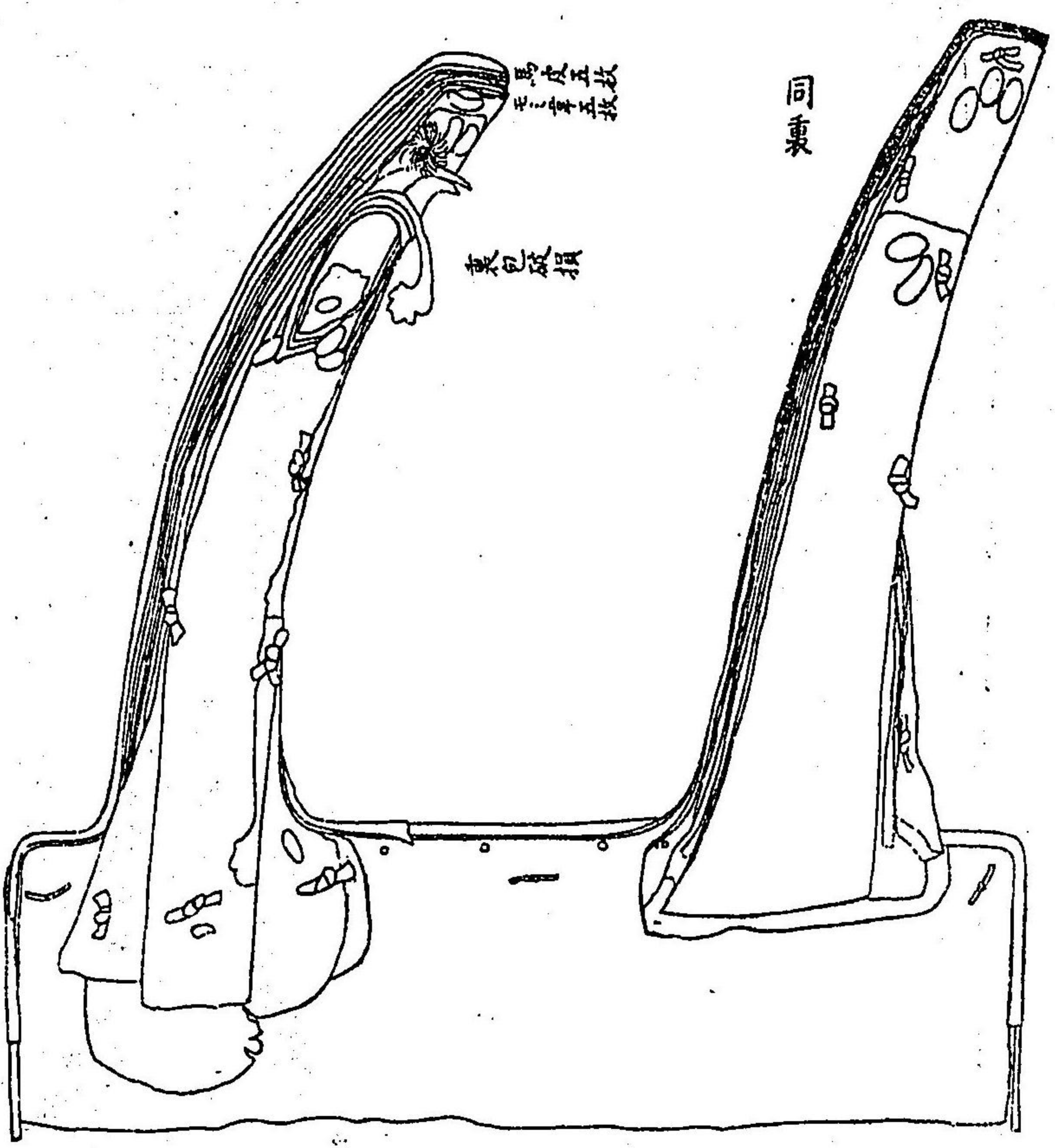

射向 脇當 鯨皮黑漆

圖 四

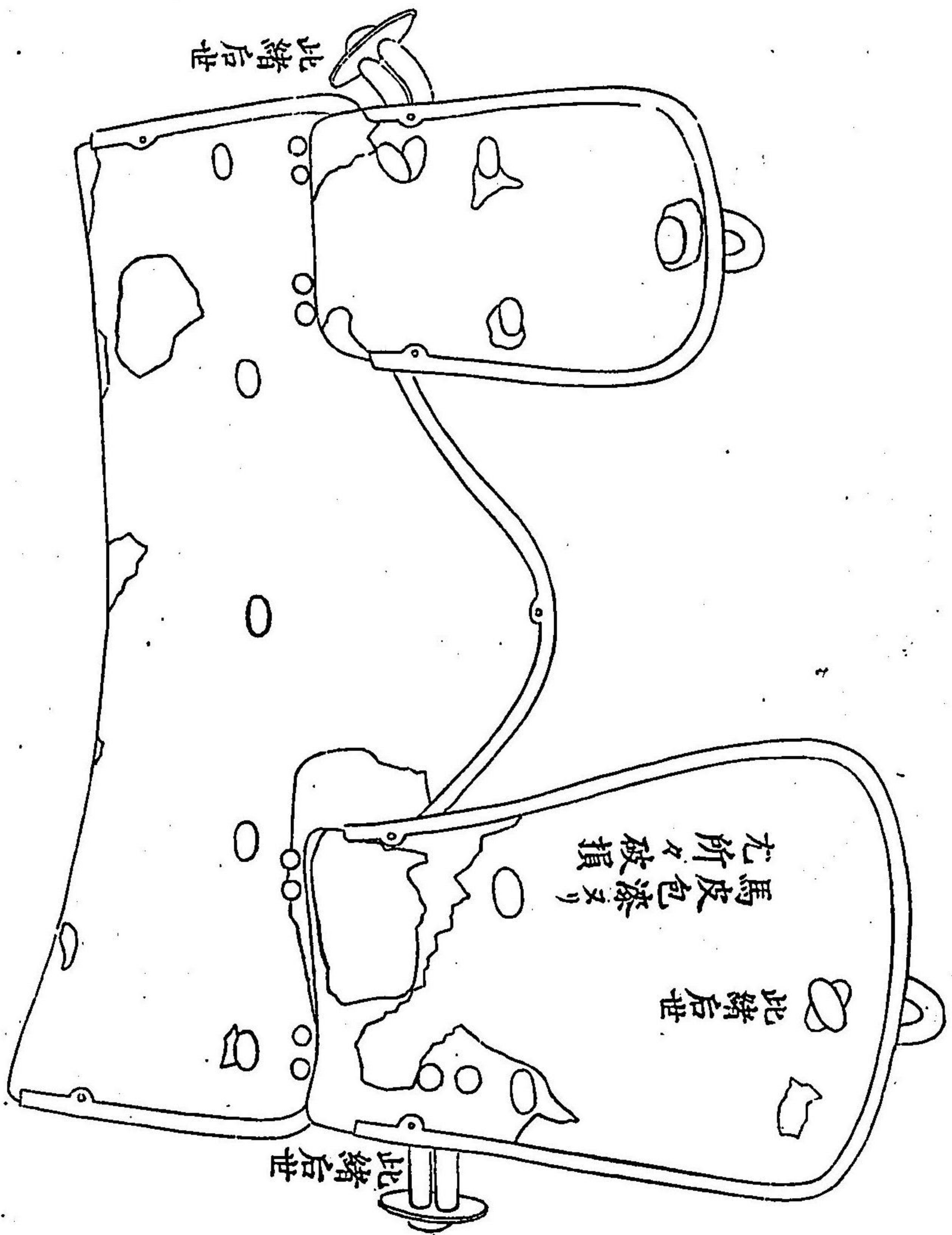

同裏

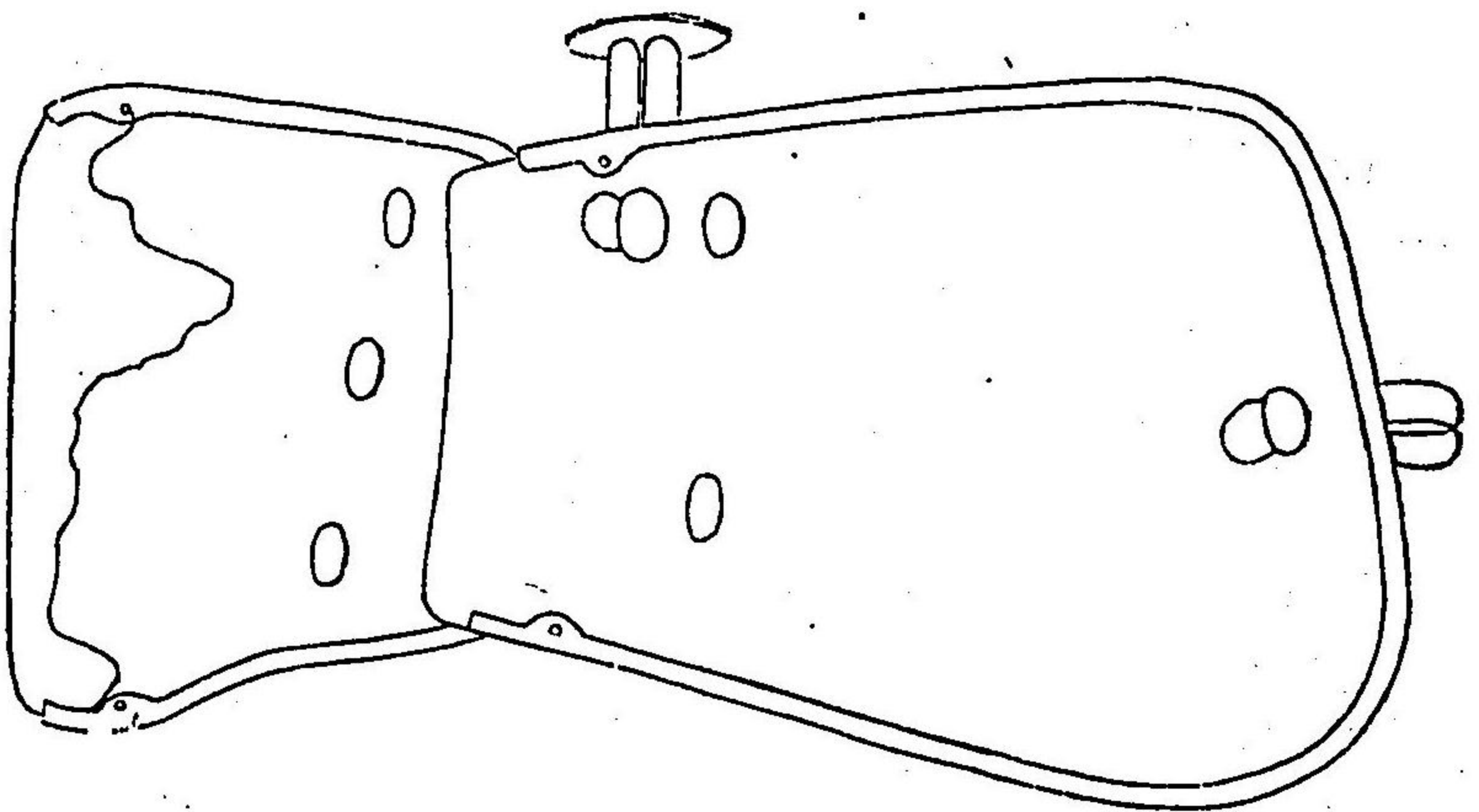

同裏

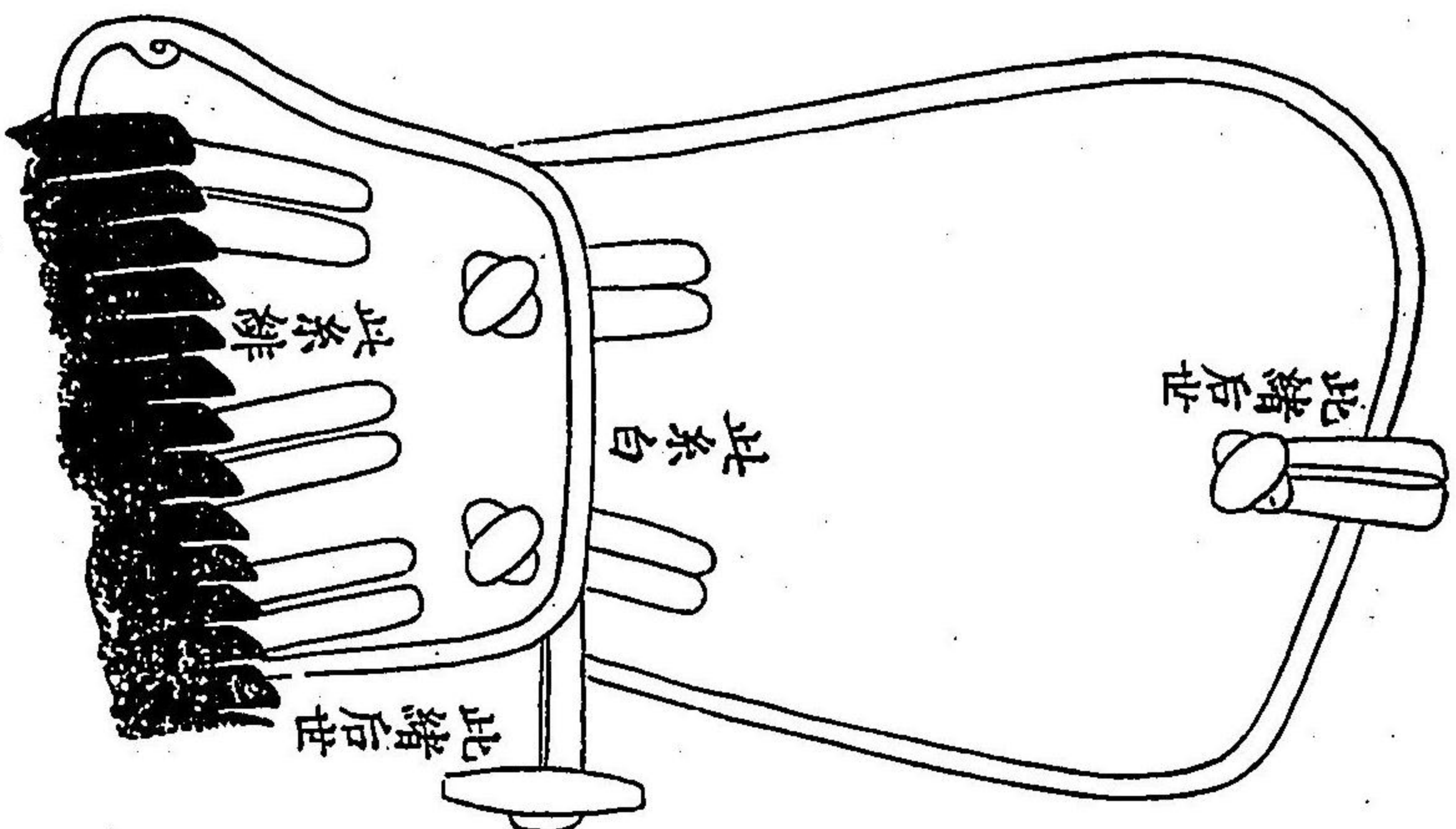

妻手前之方

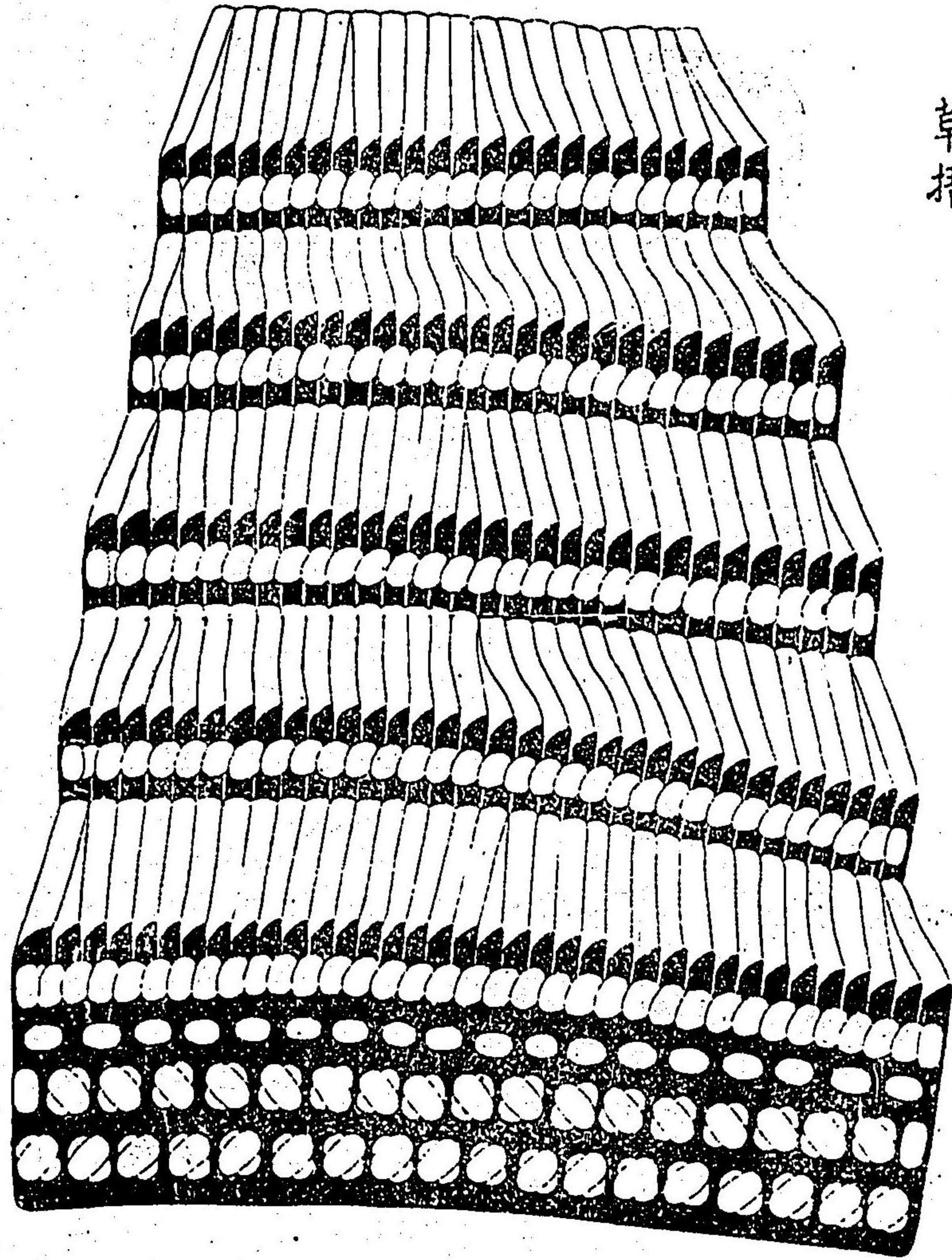

草摺

妻手後之方

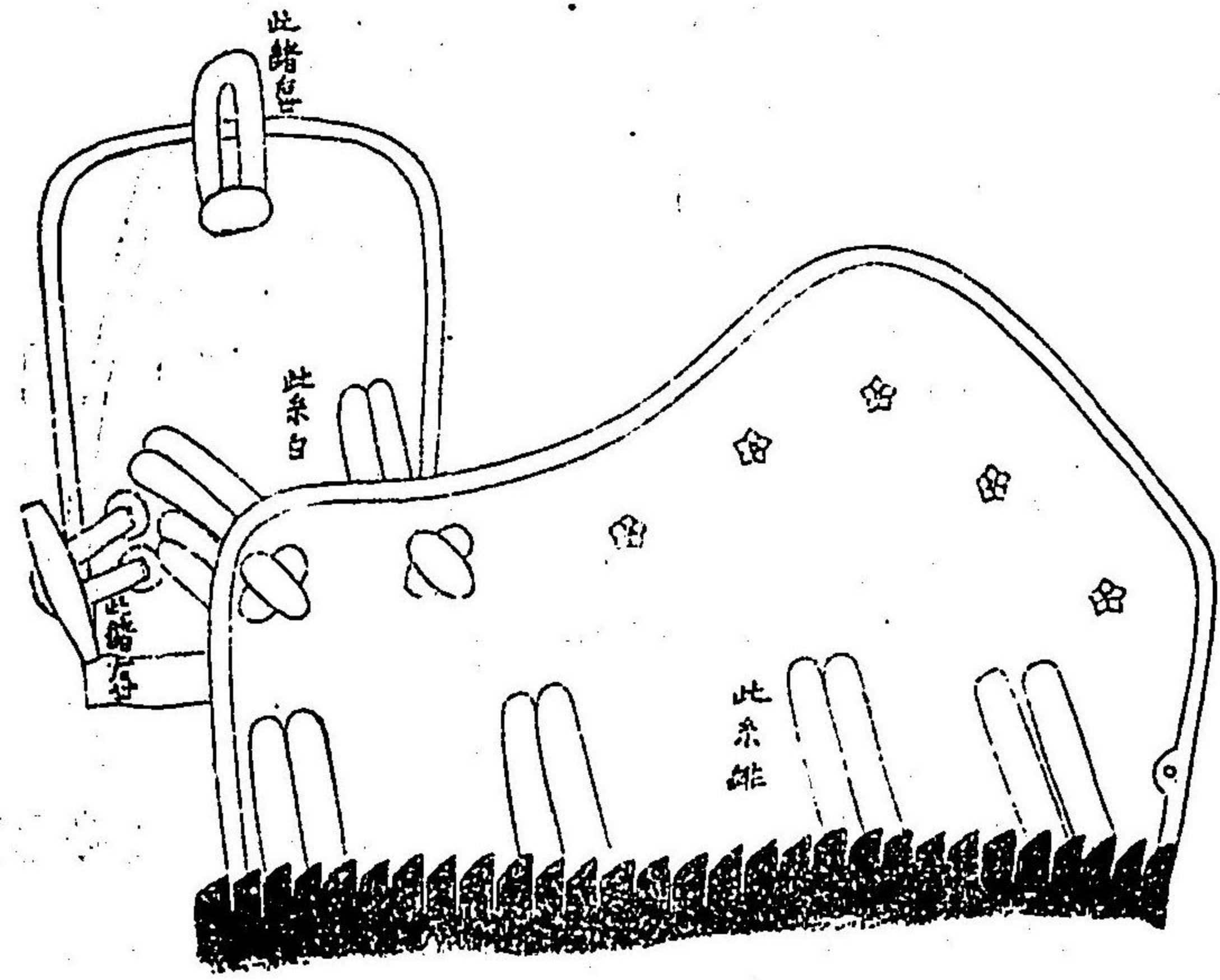

同裏

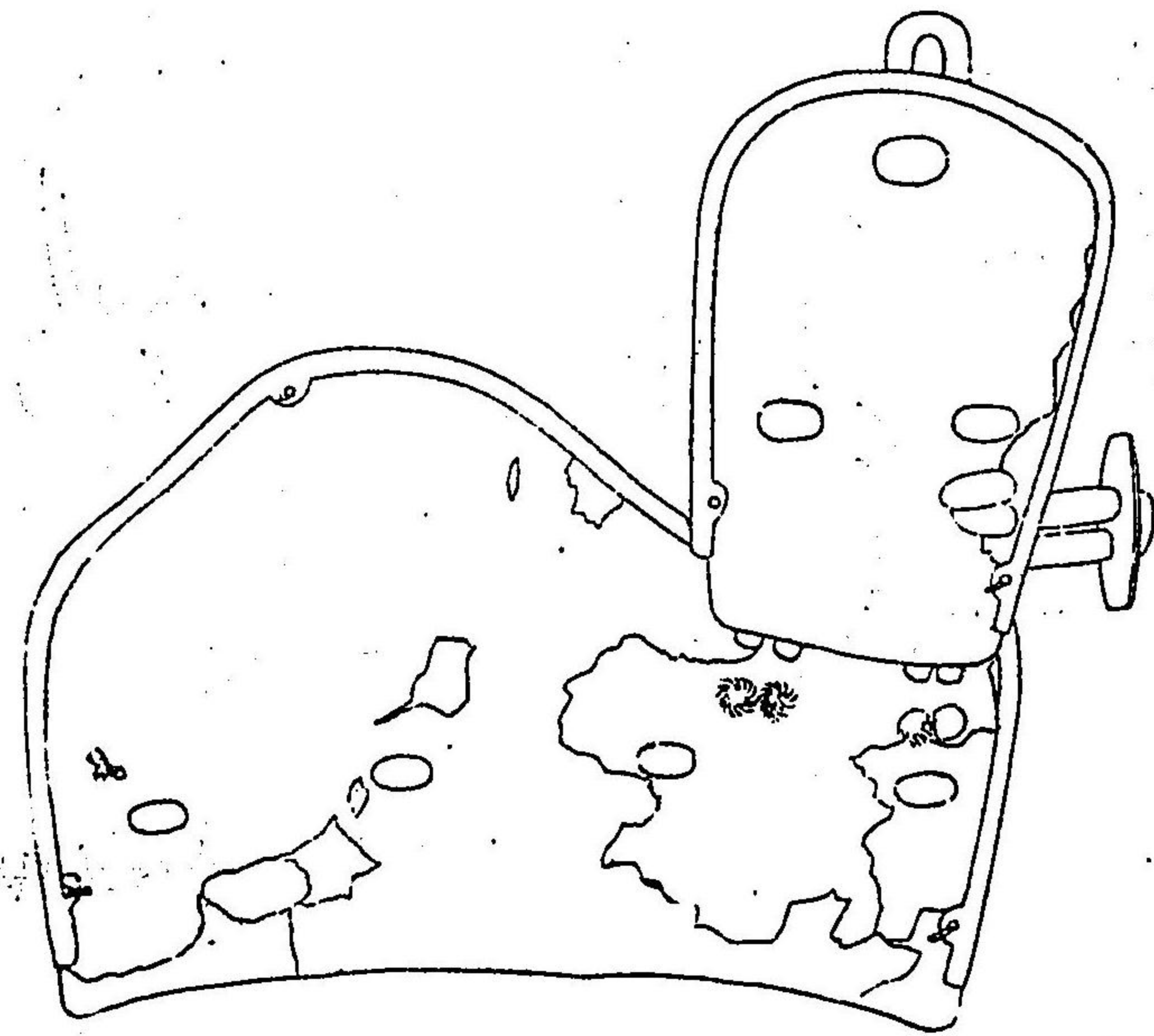

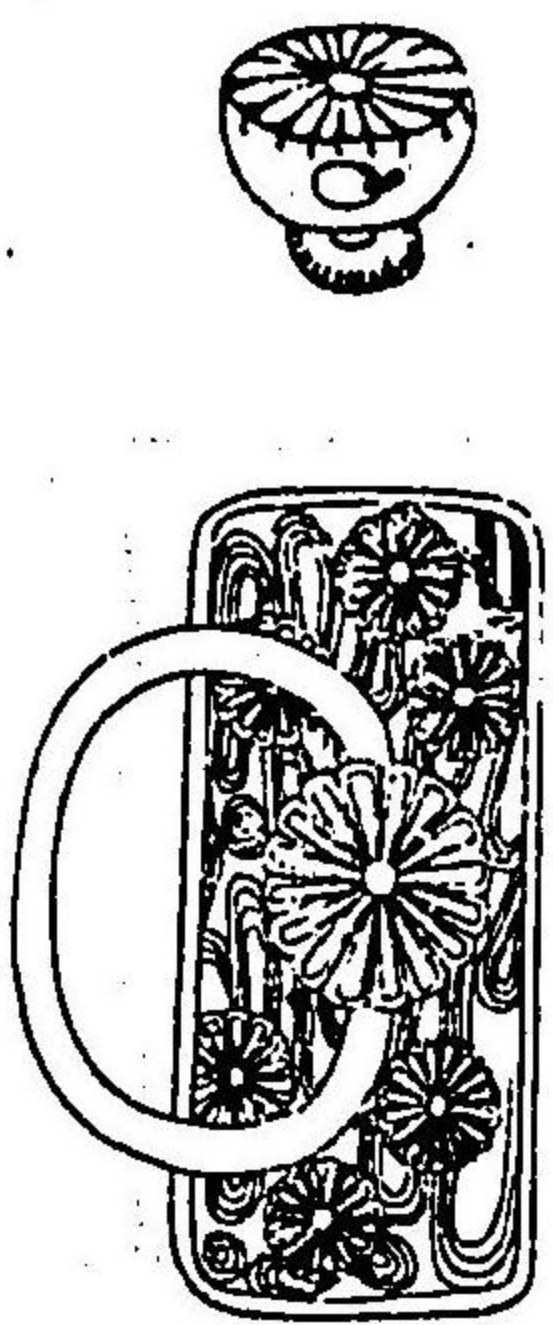

總角銀并坐

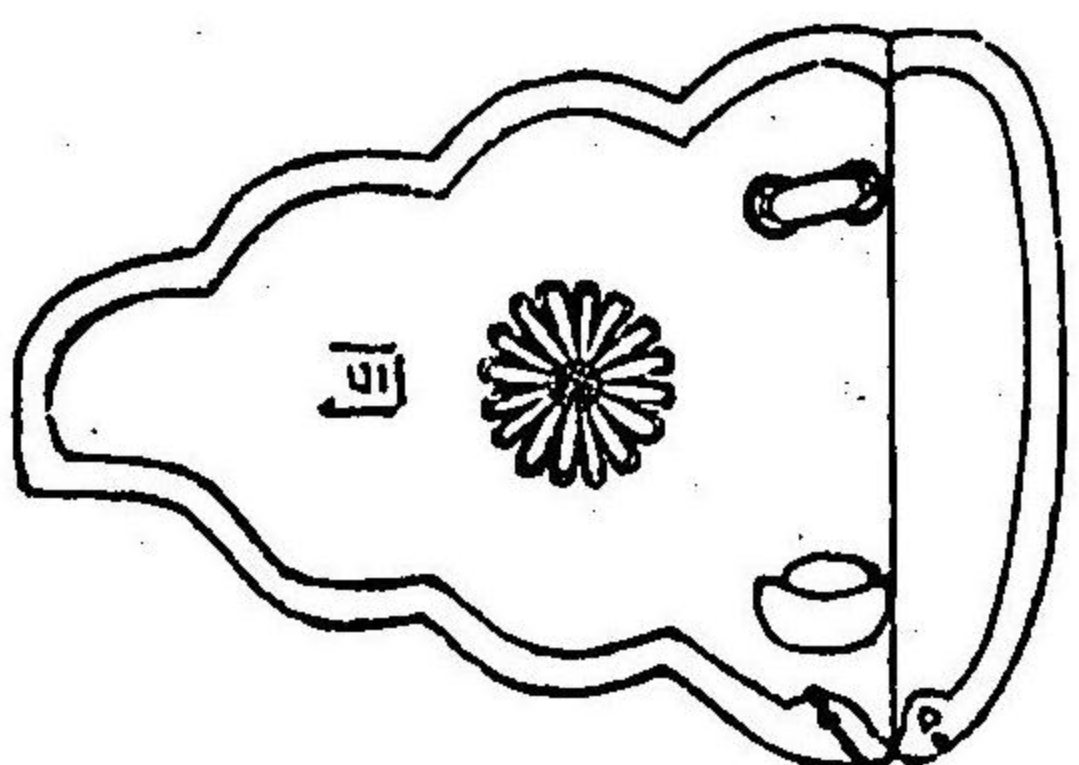

同

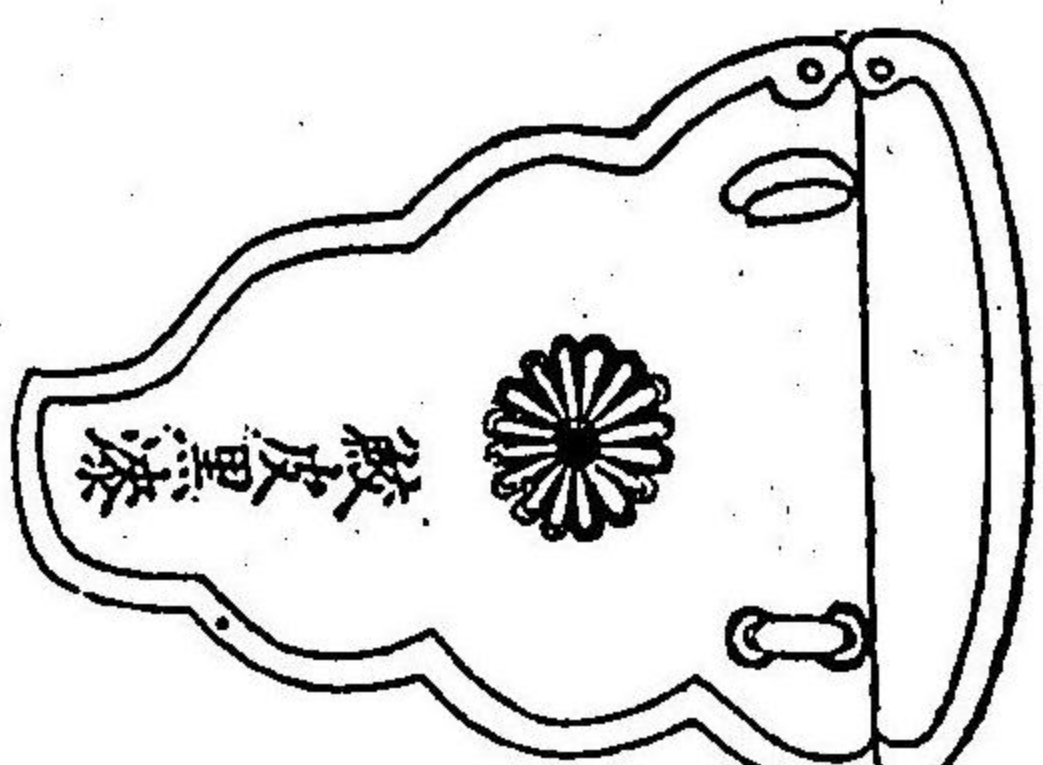

漆皮里

香葉

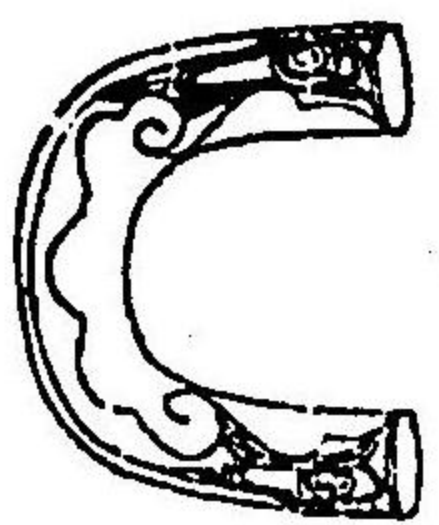

線入之金物

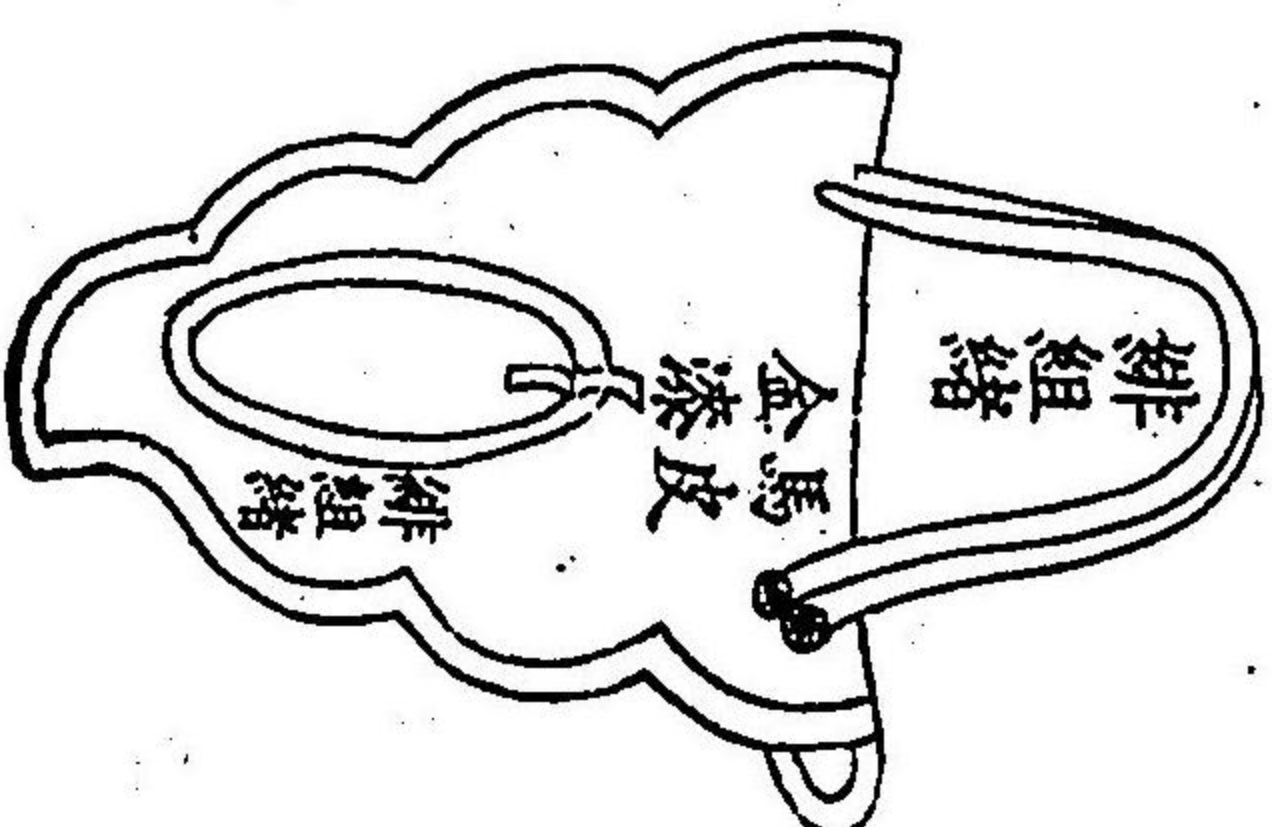

排組緒

馬皮

排組緒

同囊

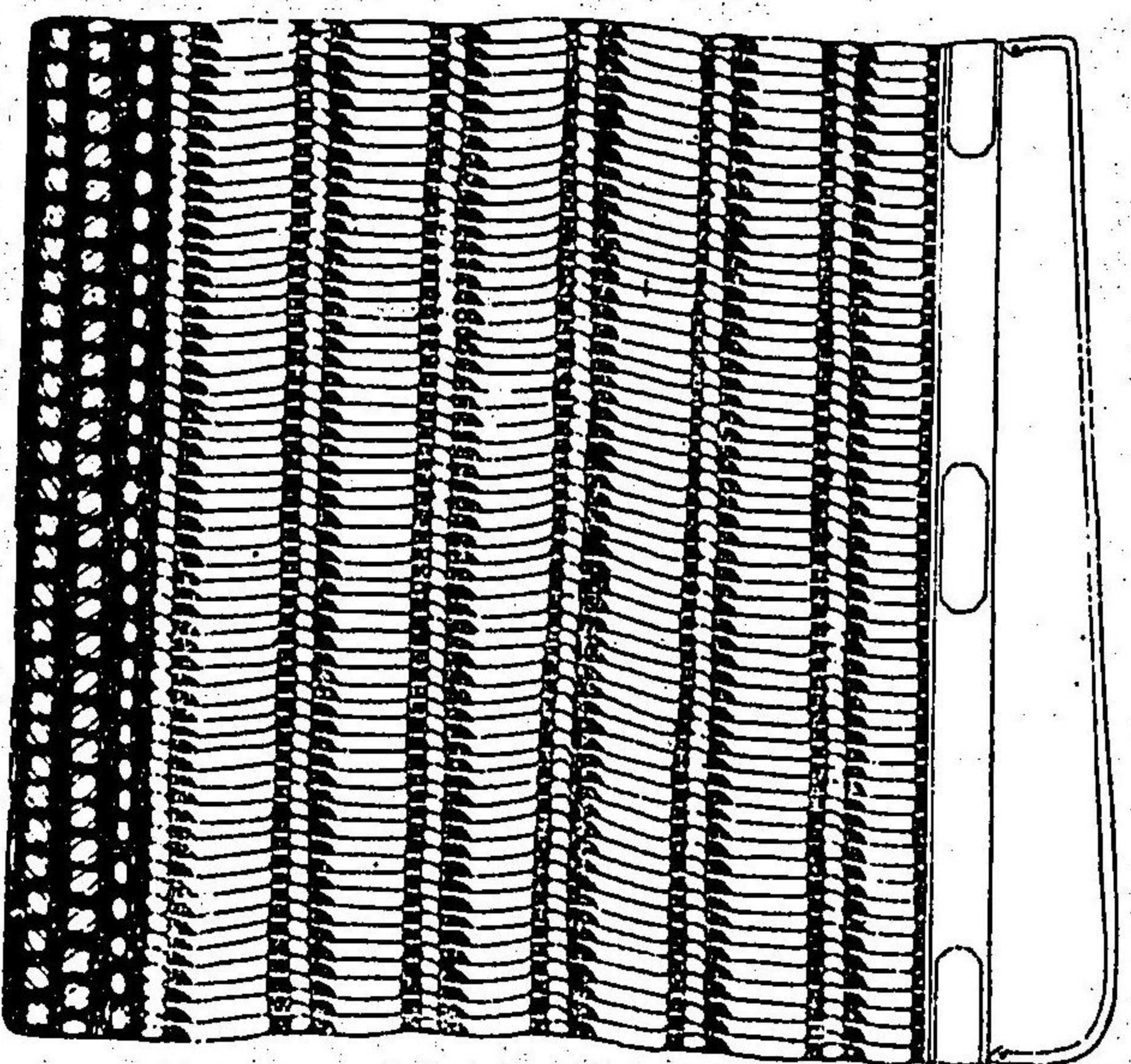

右

左右共筥手摺無之 三股ノ裏穴有之筥金物紛失也力

白金織染白金織染白金織染白金織染末

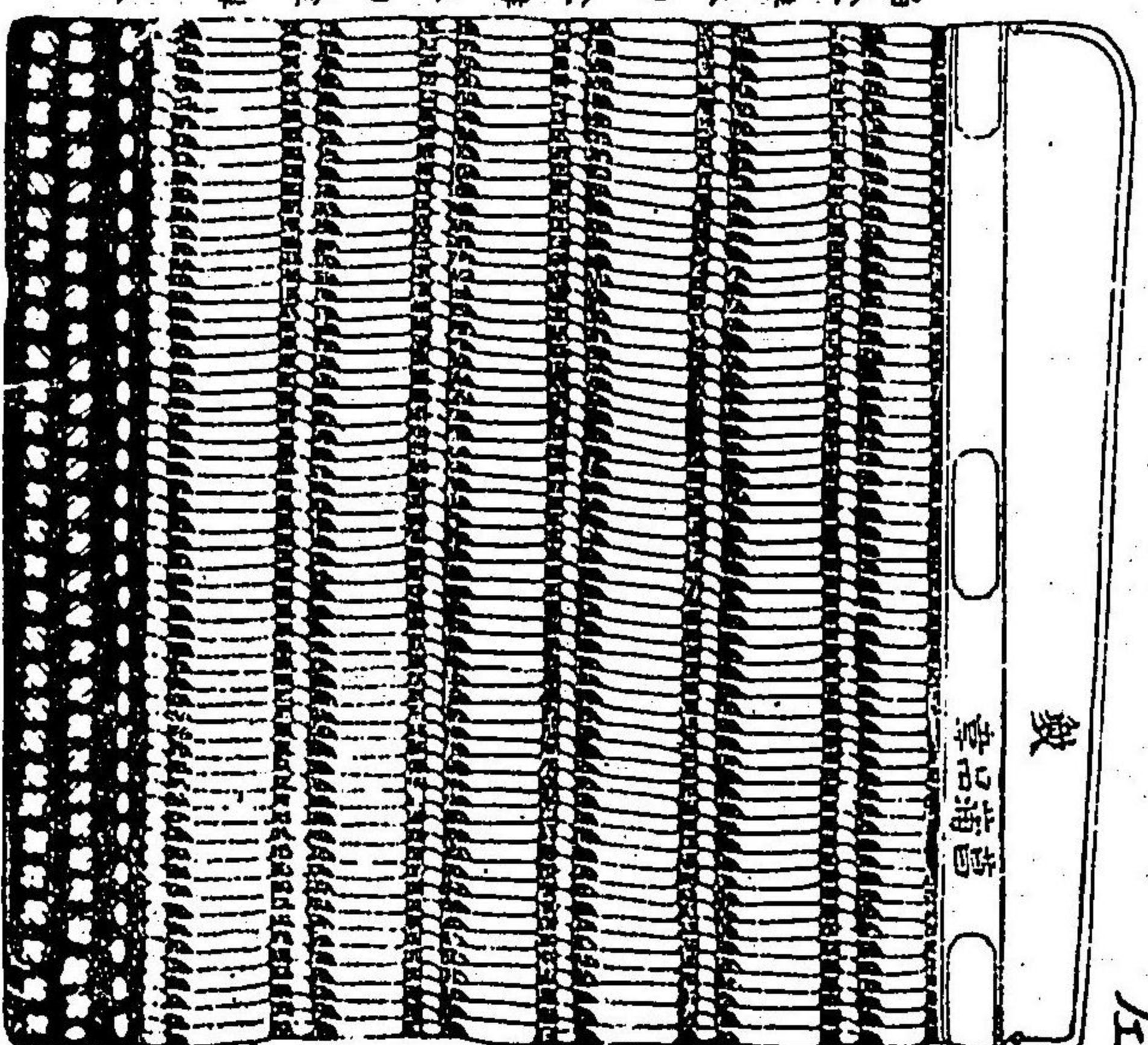

數

幸品蒲葛

左

袖全圖

水引紅白綾 耳糸畦目表糸前同

袖冠板

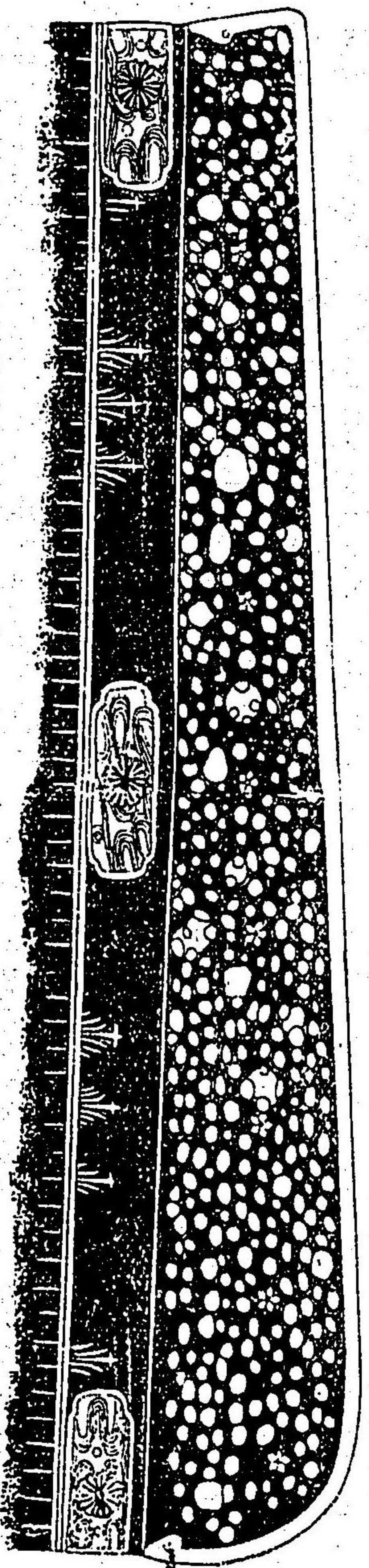

菱縫板

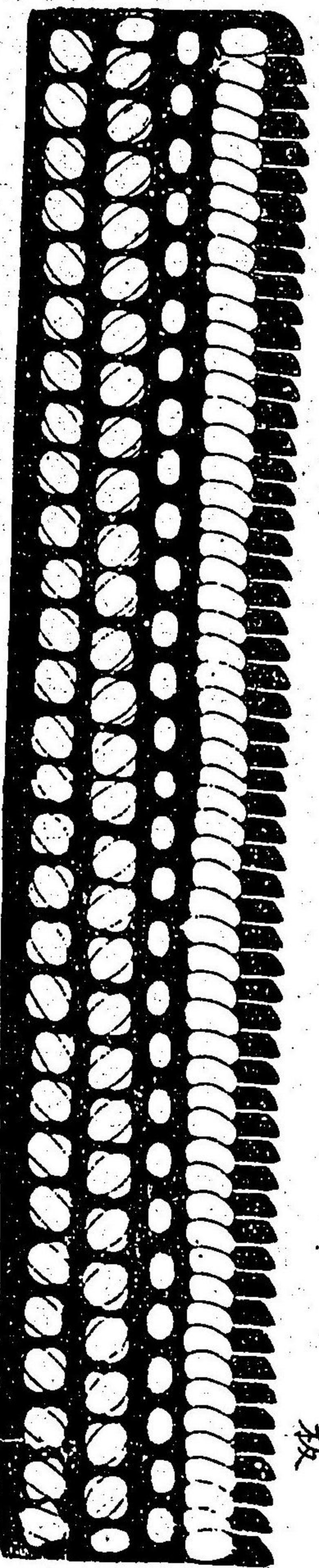

袖冠板裏

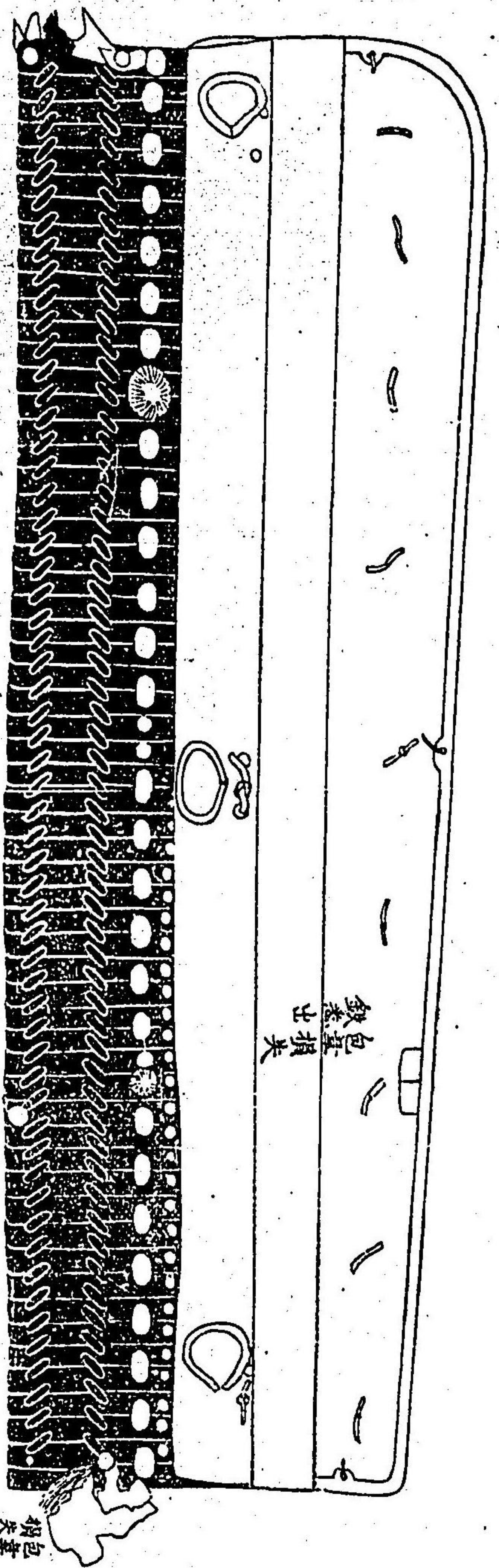

家藏鞞圖 吉野山中
引出所

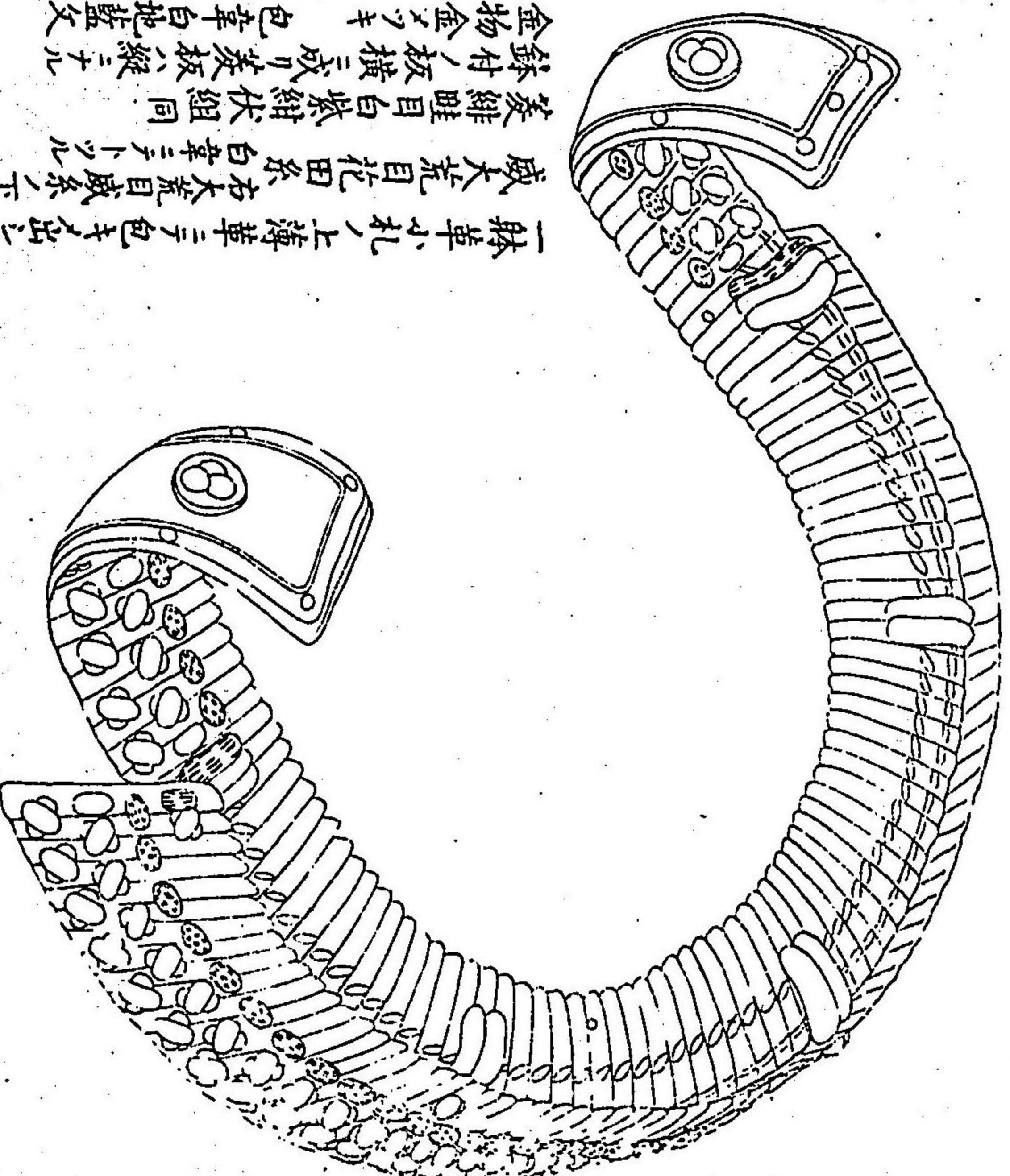

一騎車小札ノ上薄草ニテ包キ出ニ漆又
威大荒目花田糸右大荒目威条ノ下
白草ニテトツル
菱緋雖目白紫緋伏組同
録付ノ板横ニ成リ菱板ハ縦ニル
金物金ノソキ 包草白地藍文
吹返小縁五里

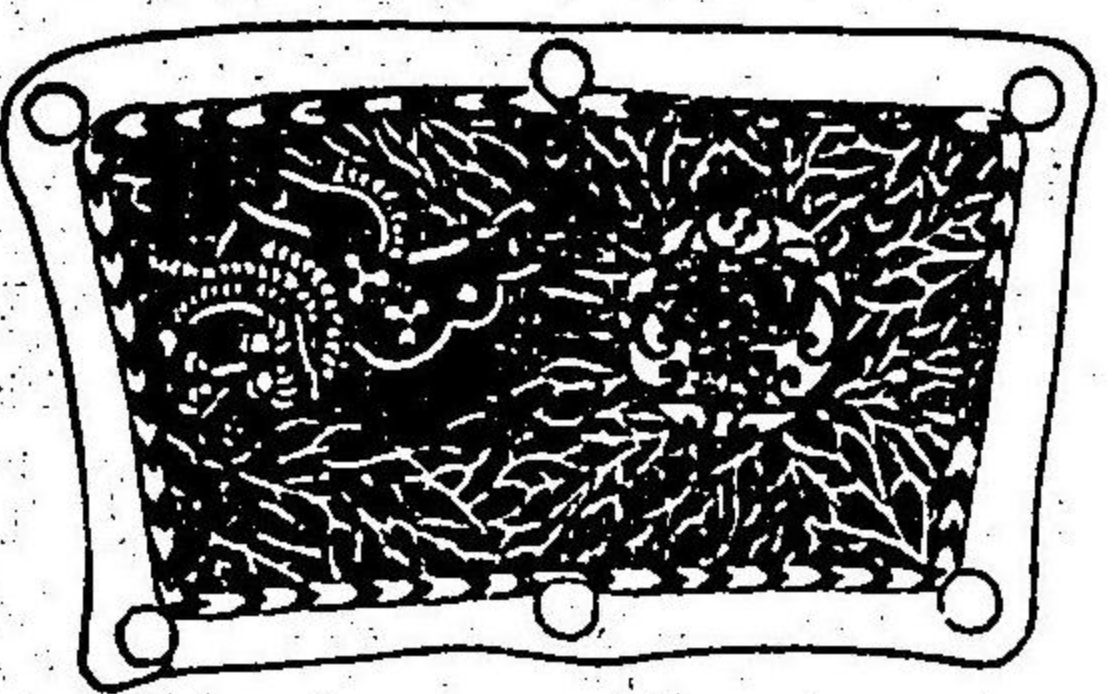
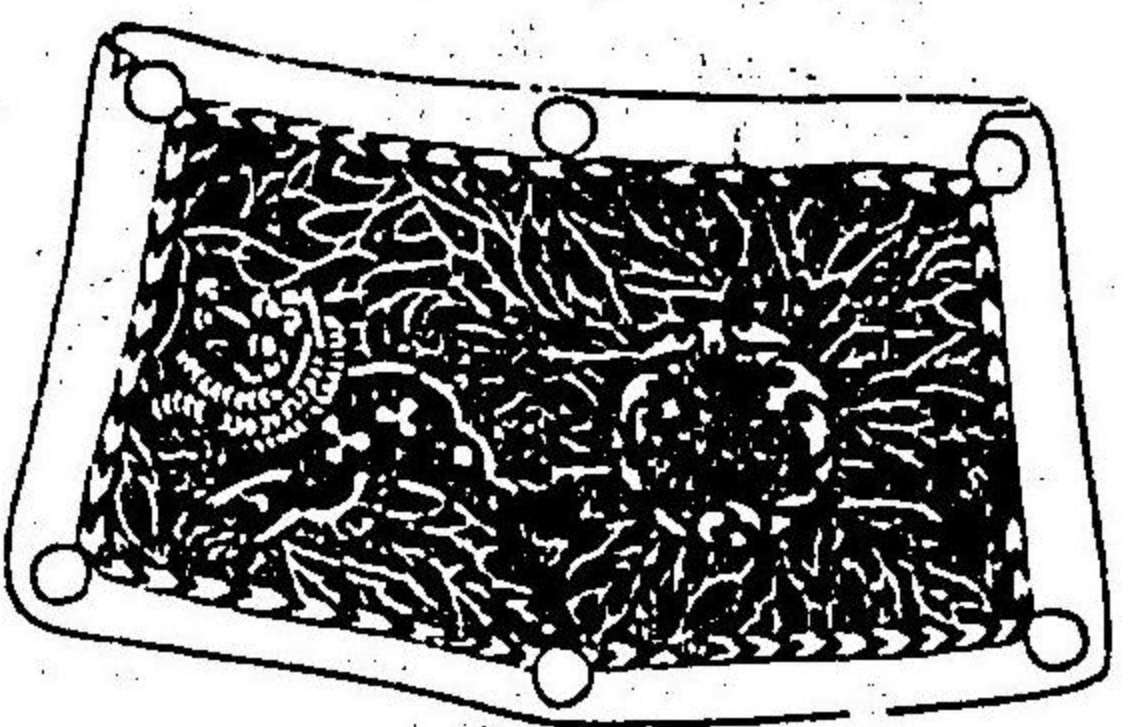

吹返

裏

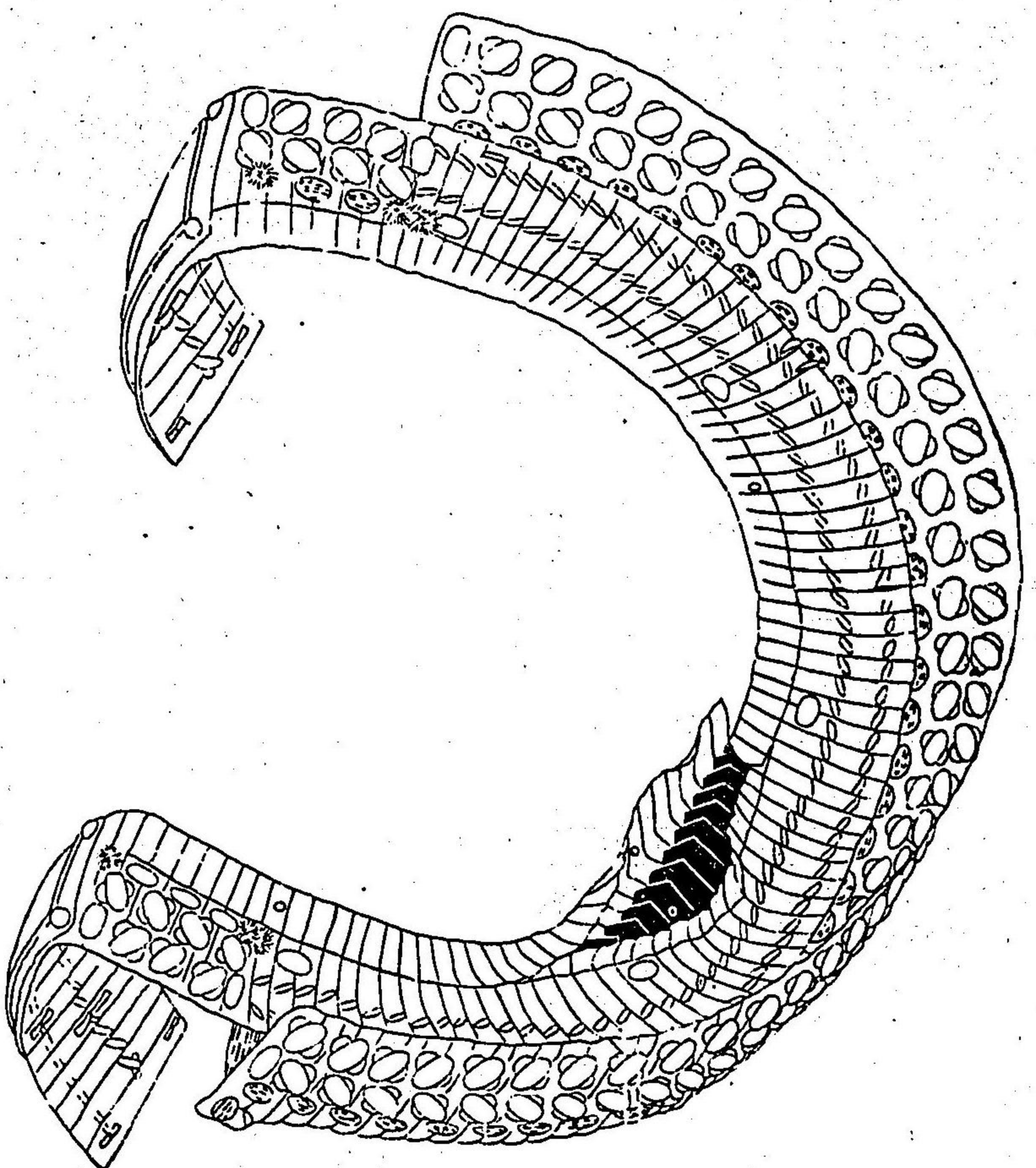

安藝國嚴嶋神社藏義家朝臣甲冑圖

甲冑全圖

三十二間 模本鉢ノ註文ヲ失
 四方白地板 銀ノツキ
 四天穴 四前ニ穴 腰卷ヨリ一寸後ニ穴 一寸一分
 鎧每金ノツキ 前三左右後各ニ
 金物皆金ノツキ 下皆同之
 高勝 鑲ナシ 穴ヨリ 柑子 韋ノ輪ヲ出ス
 腰卷ニ星三十
 鉢介 鑲四本八双 金物五所一ヶ所ニ裏菊ニ宛打
 鞆小札長一寸九分 幅八分上三段 鉄小札下二段 草札
 威淺 黃 紬心ニ淺 黃布ヲハクケテ 威ス タム
 右世以藍草修補
 伏組 紅白紺三色
 耳糸 黑白黃紅 崩木 啄 右世修補
 畦目 黑白花田
 菱縫 緋
 小縁 赤地 白文 五星
 威毛 以下 甲冑 同

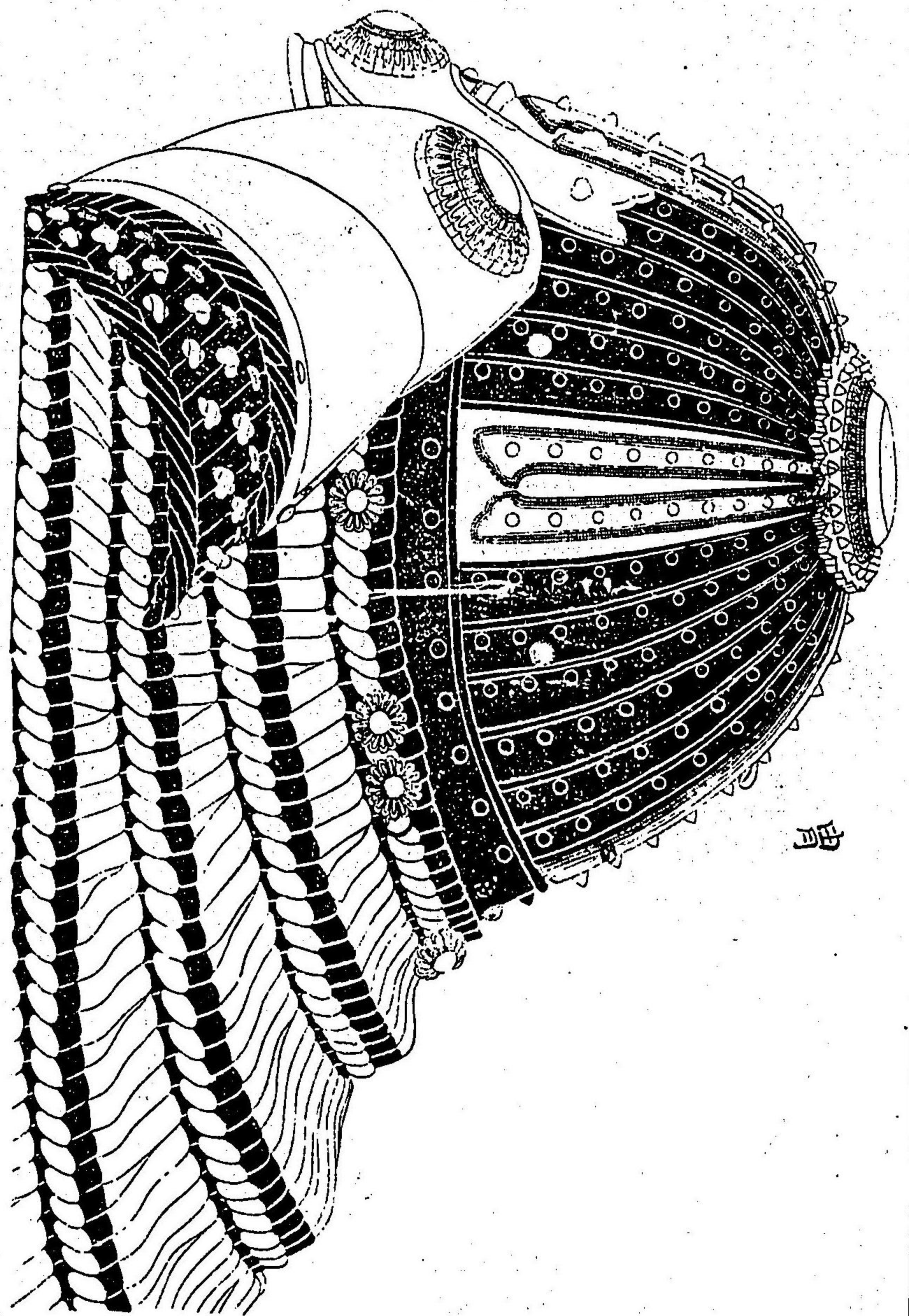
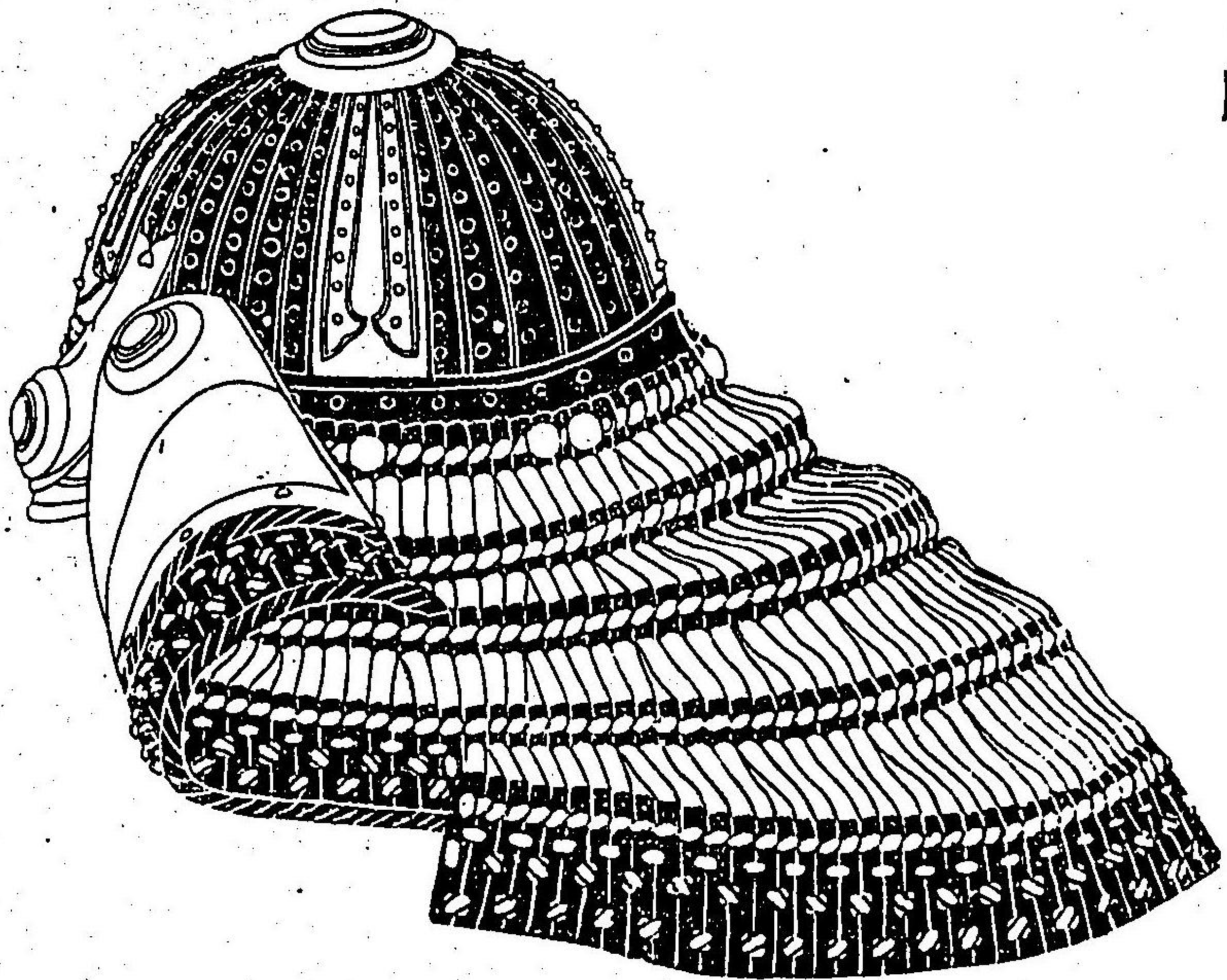

天空及坐

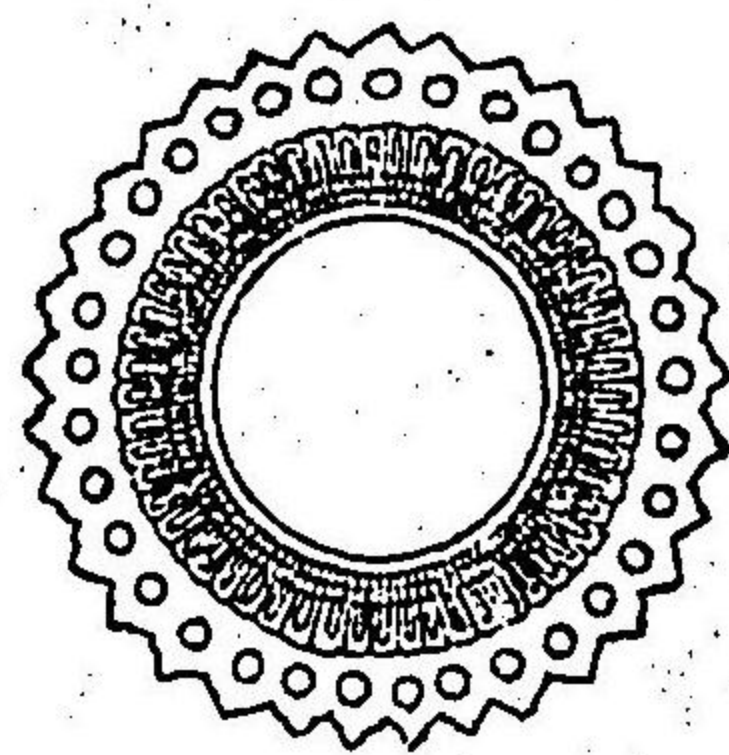

鎬垂

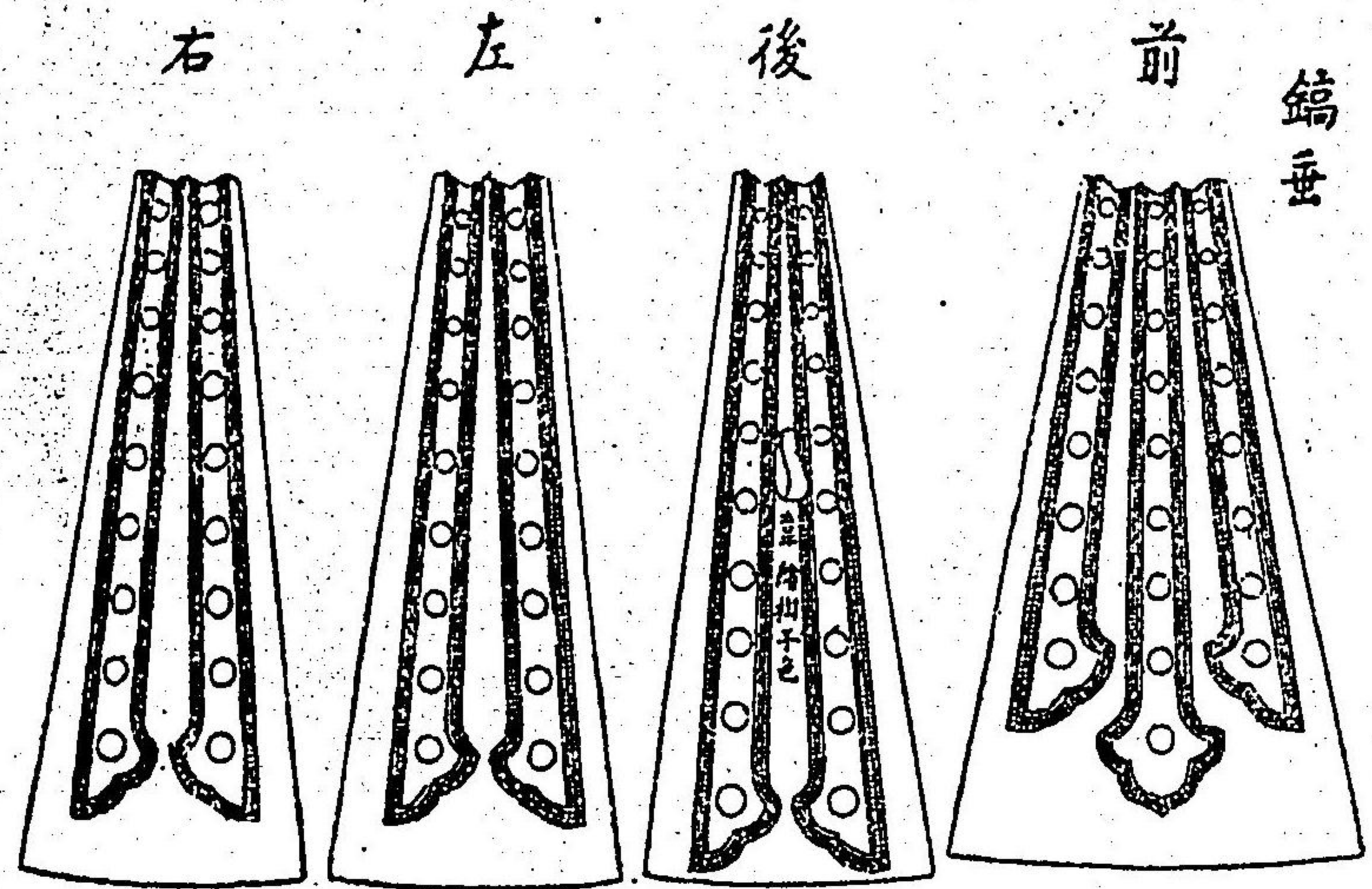

鍬形臺

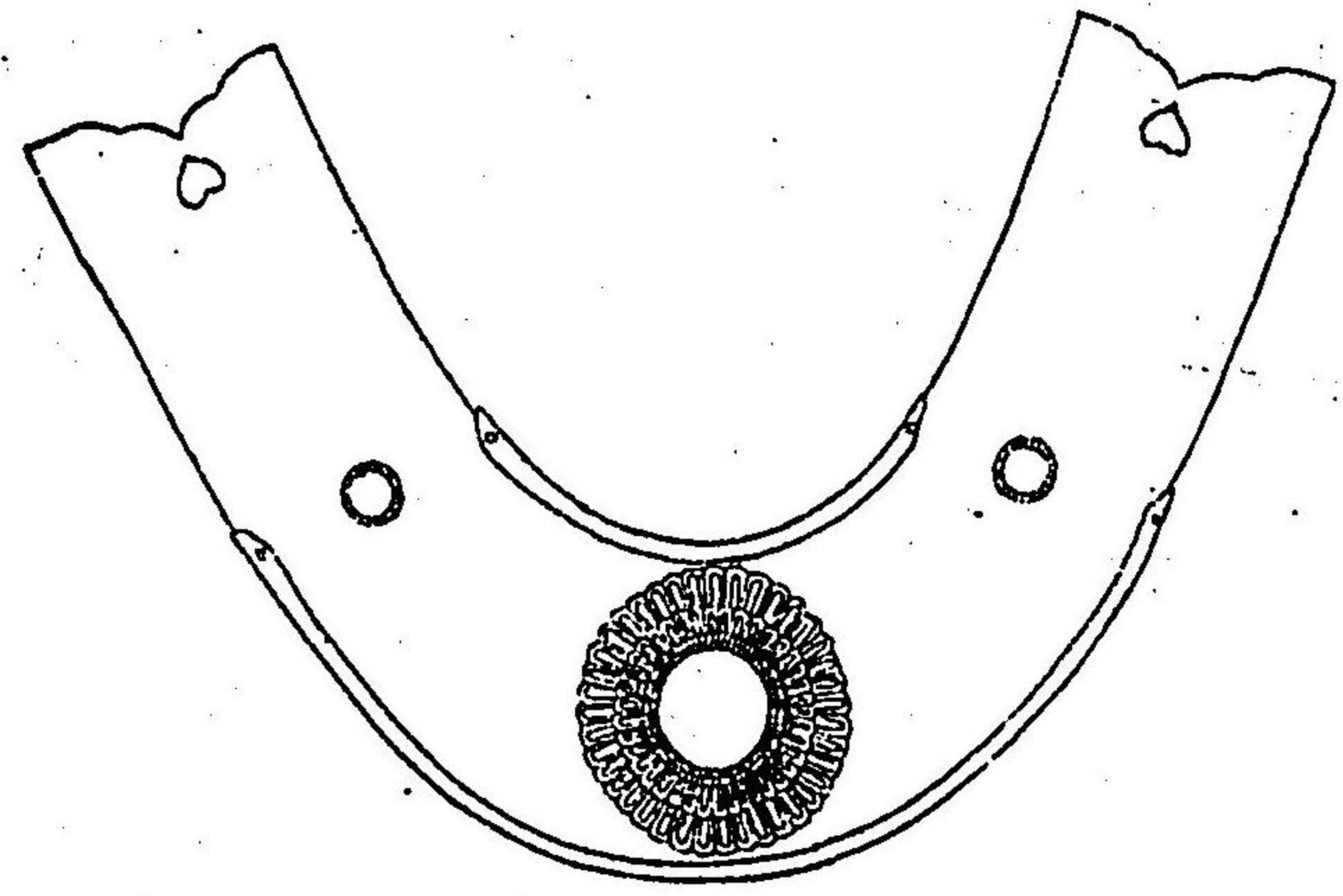

鍬形

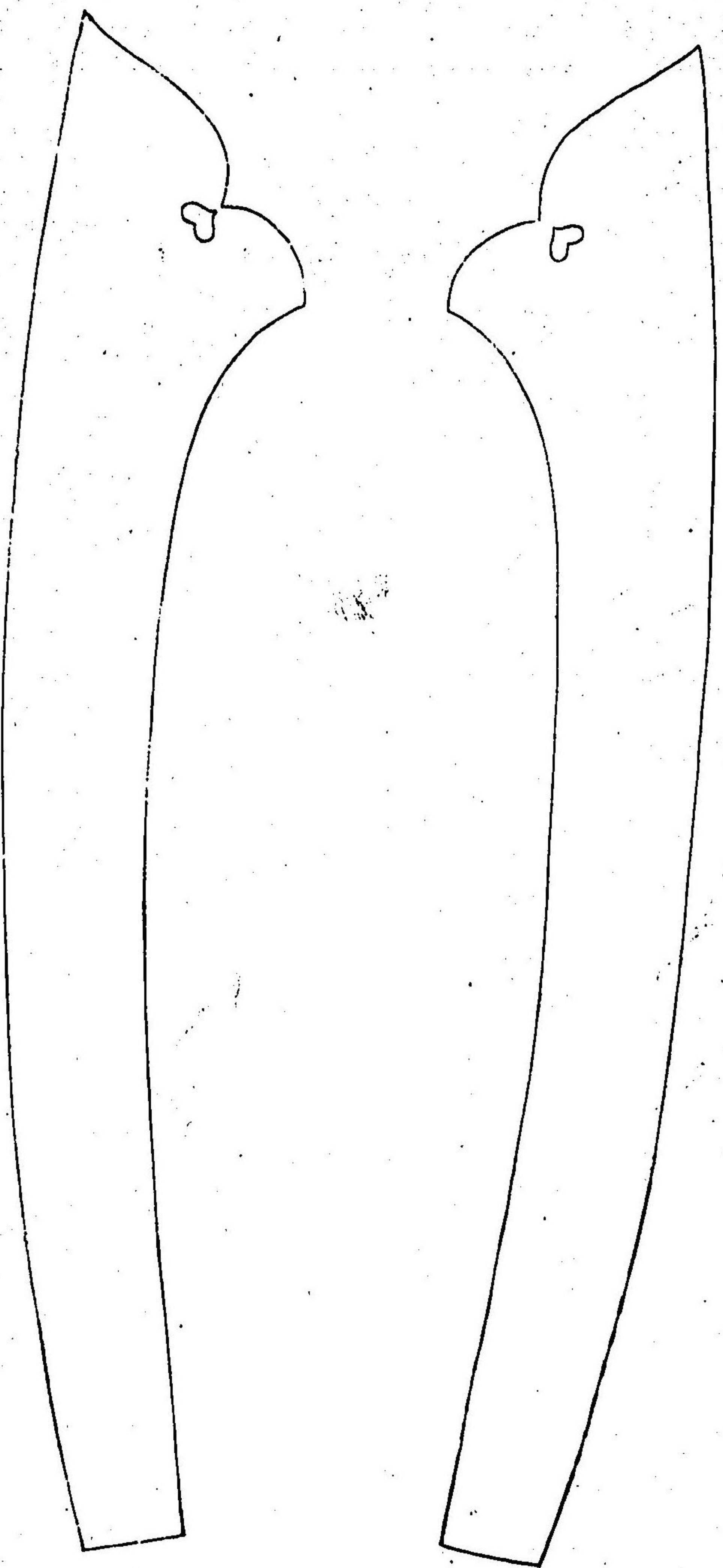

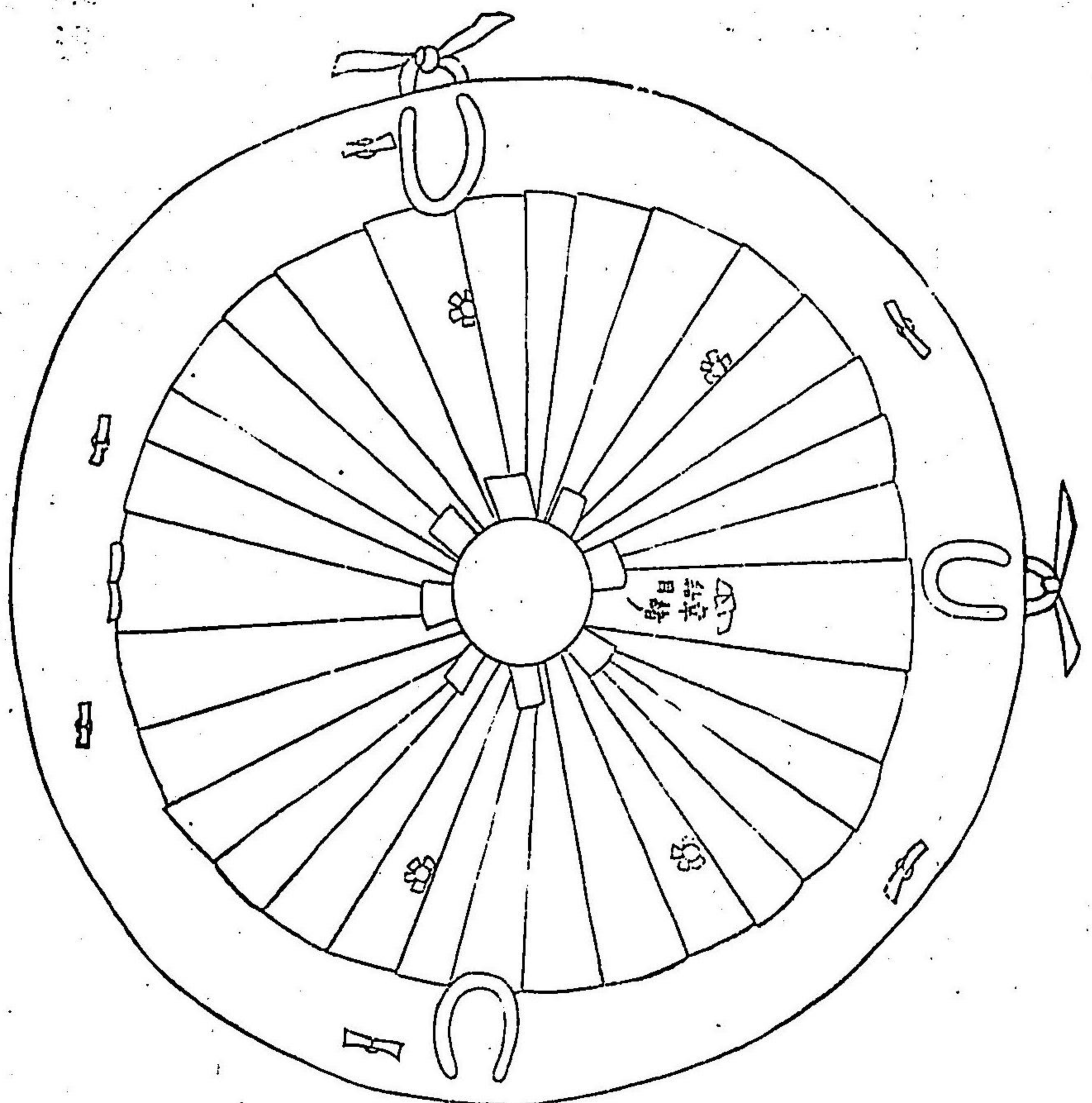

鉢裏

黑草シニ白草又

右

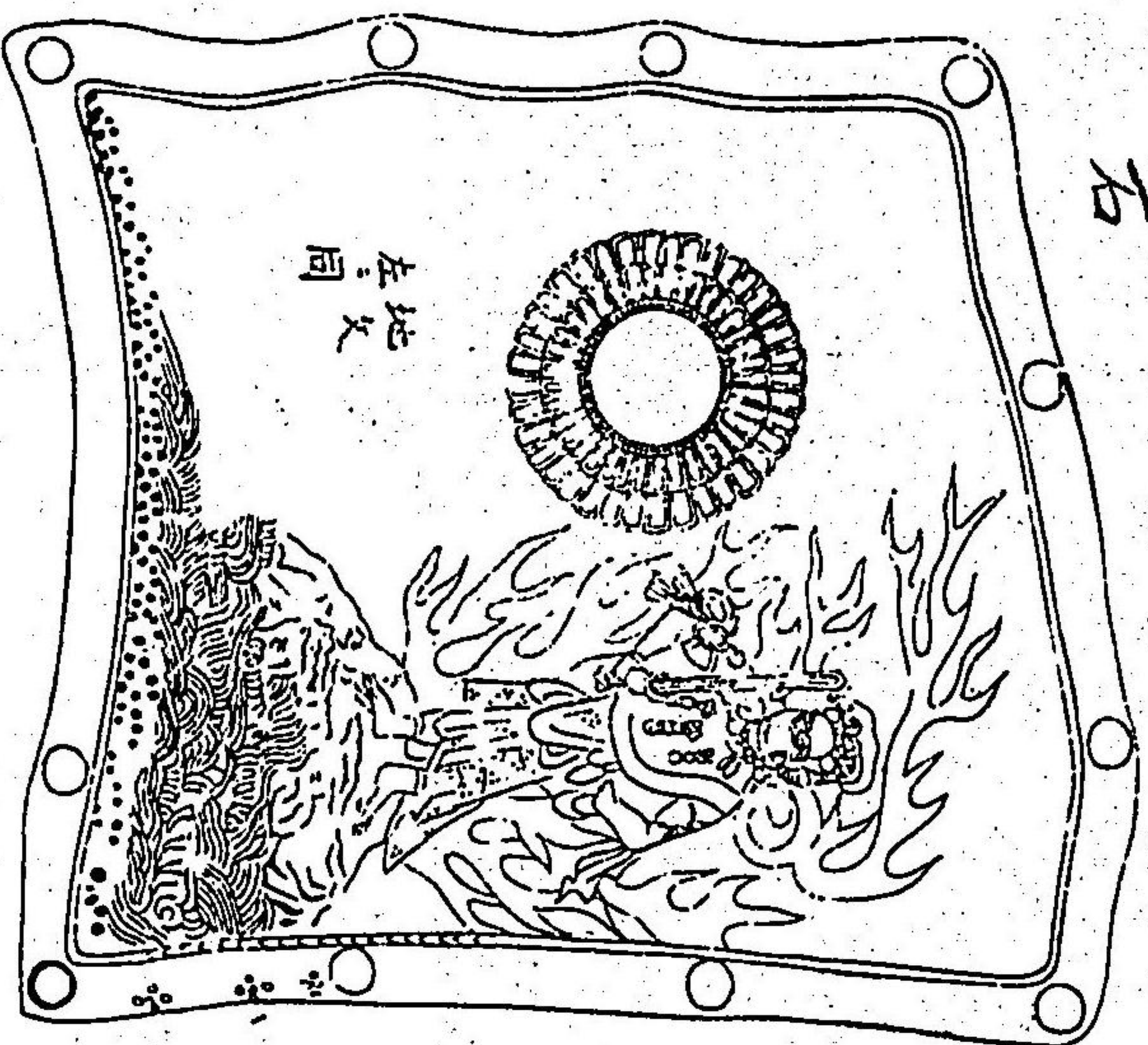

左

吹返包草 白地藍又及鈎ノ所四款

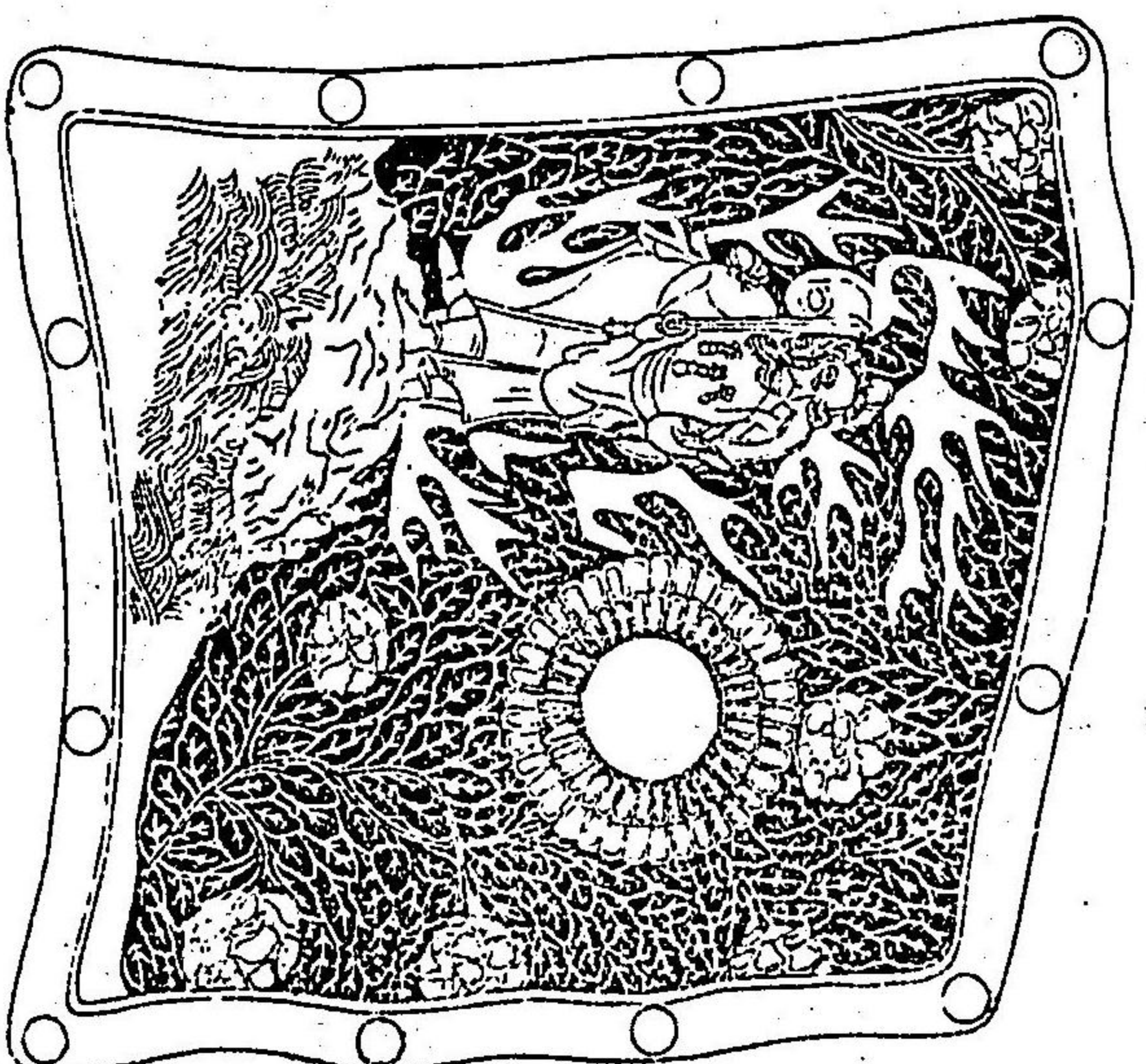

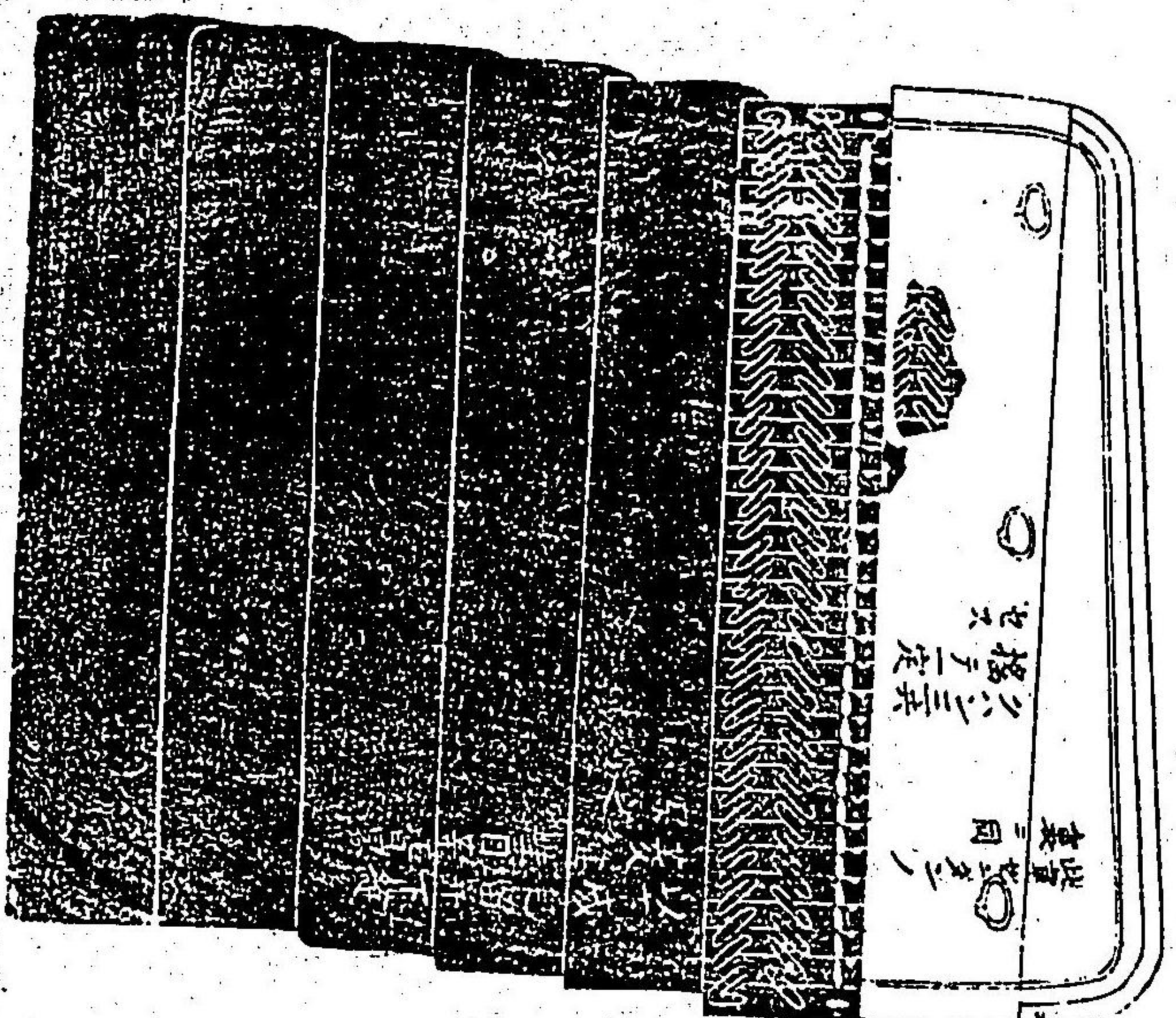

同裏全圖

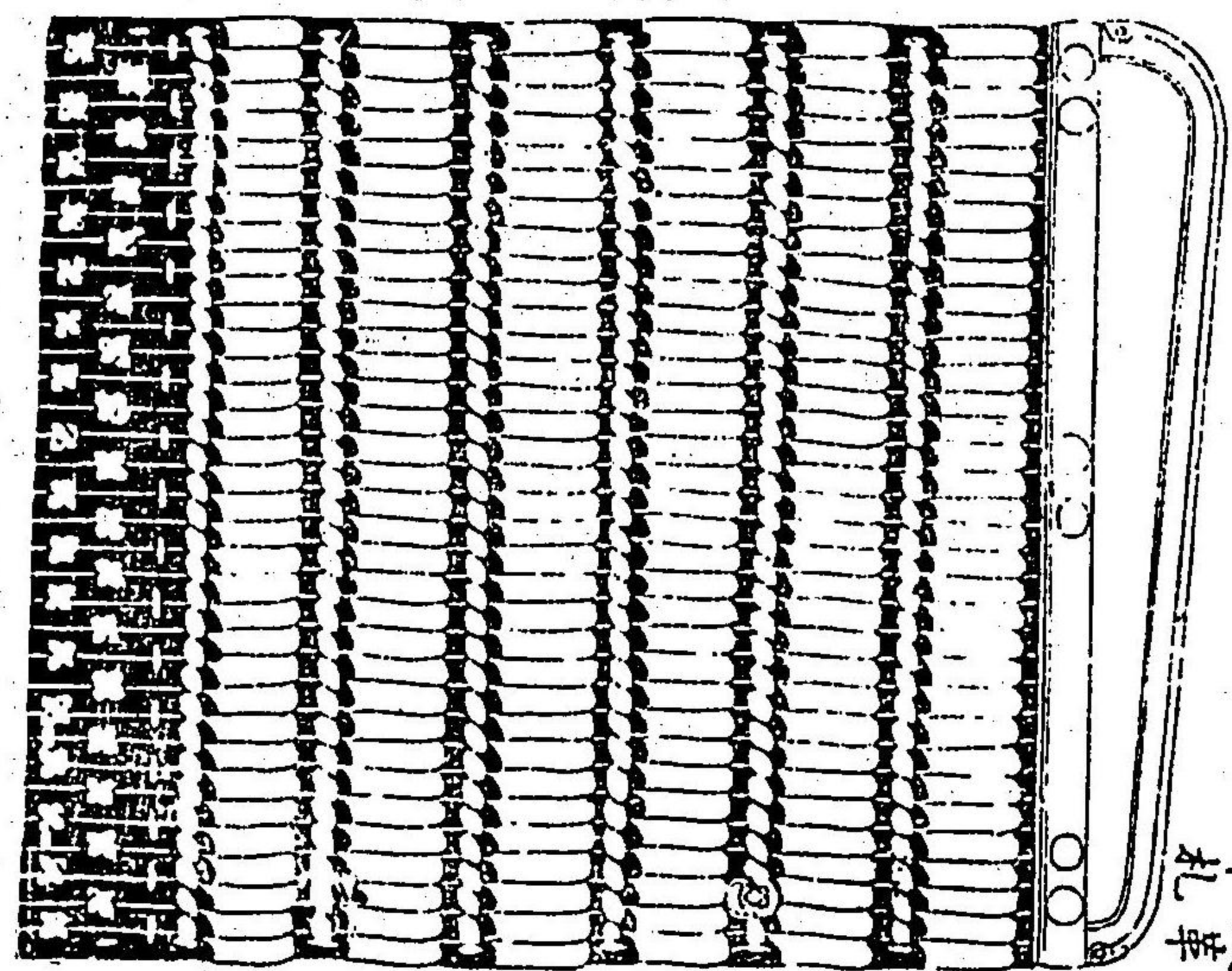

袖全圖 左右共同
水引紅白傘 下水引同
縫目縫損至不
縫馬皮等充

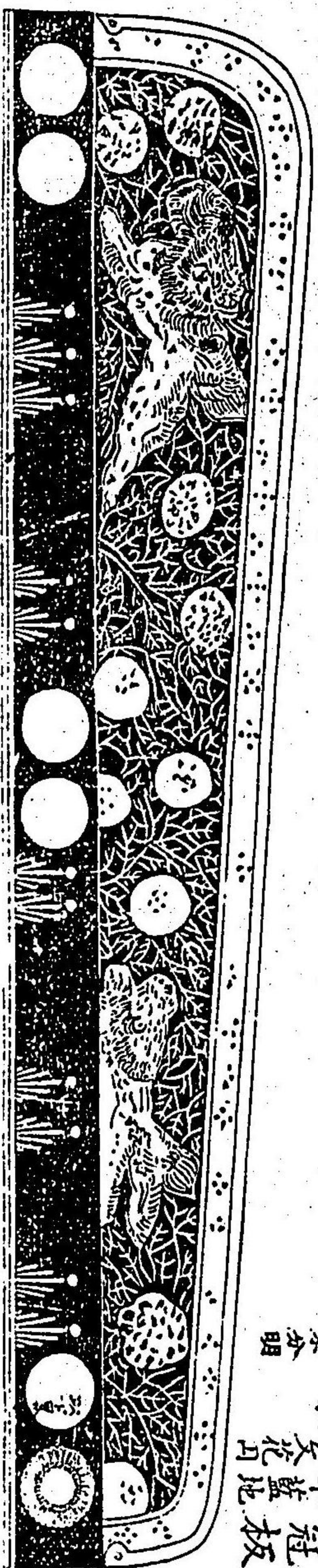

袖冠板
車蓋地
白文花月
紫不分明

袖菱板



水吞緒銀

錯無之



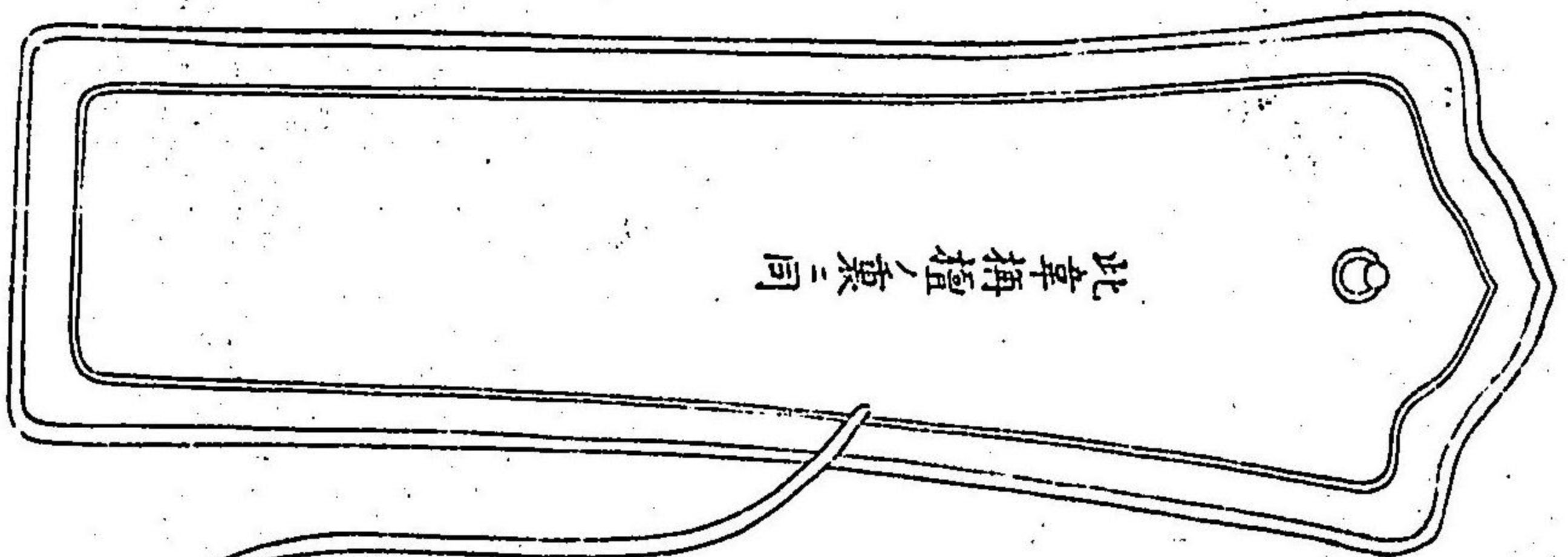

此章梅摺ノ裏同

同裏

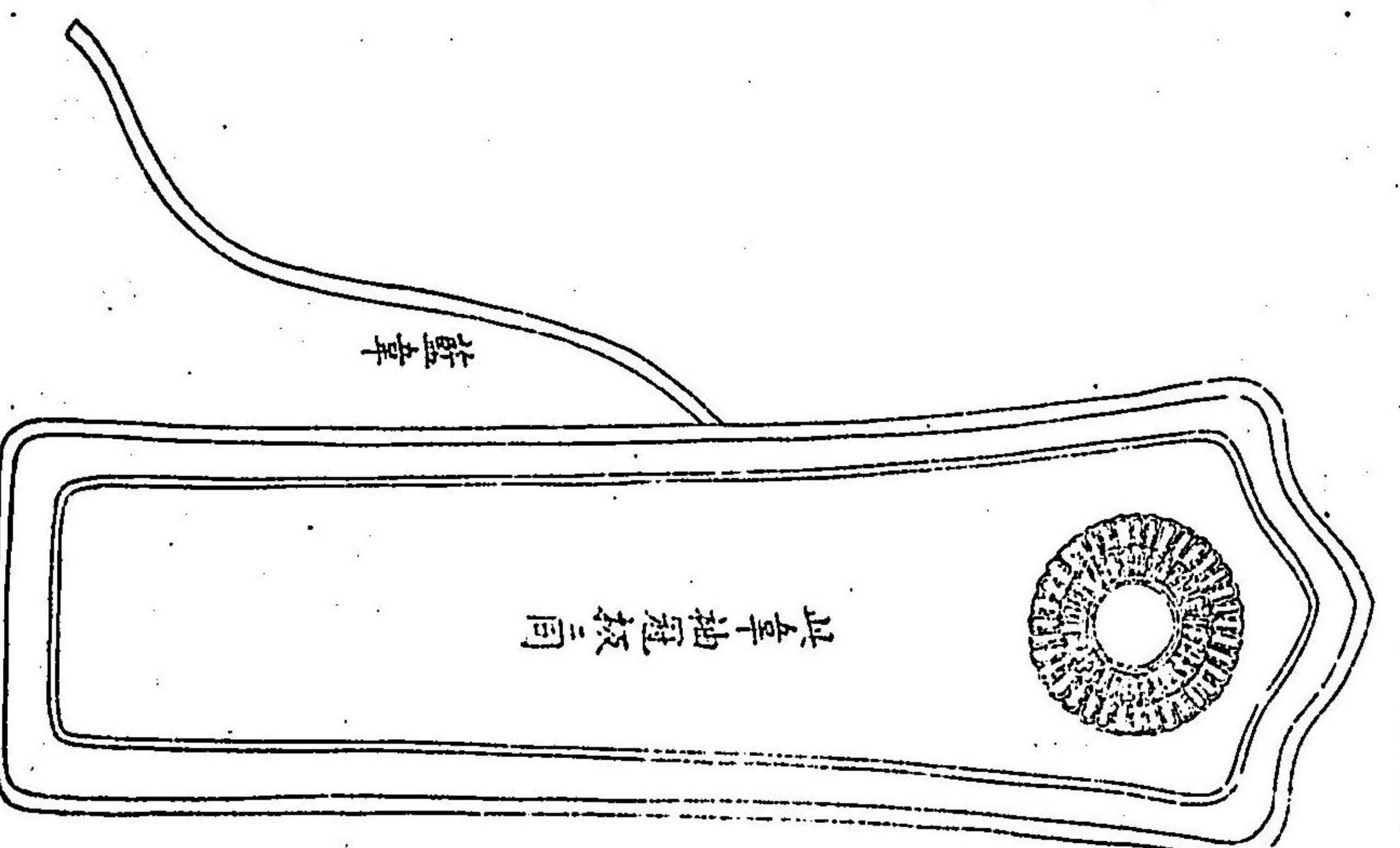

此章抽冠板同

摺尾板

藍章

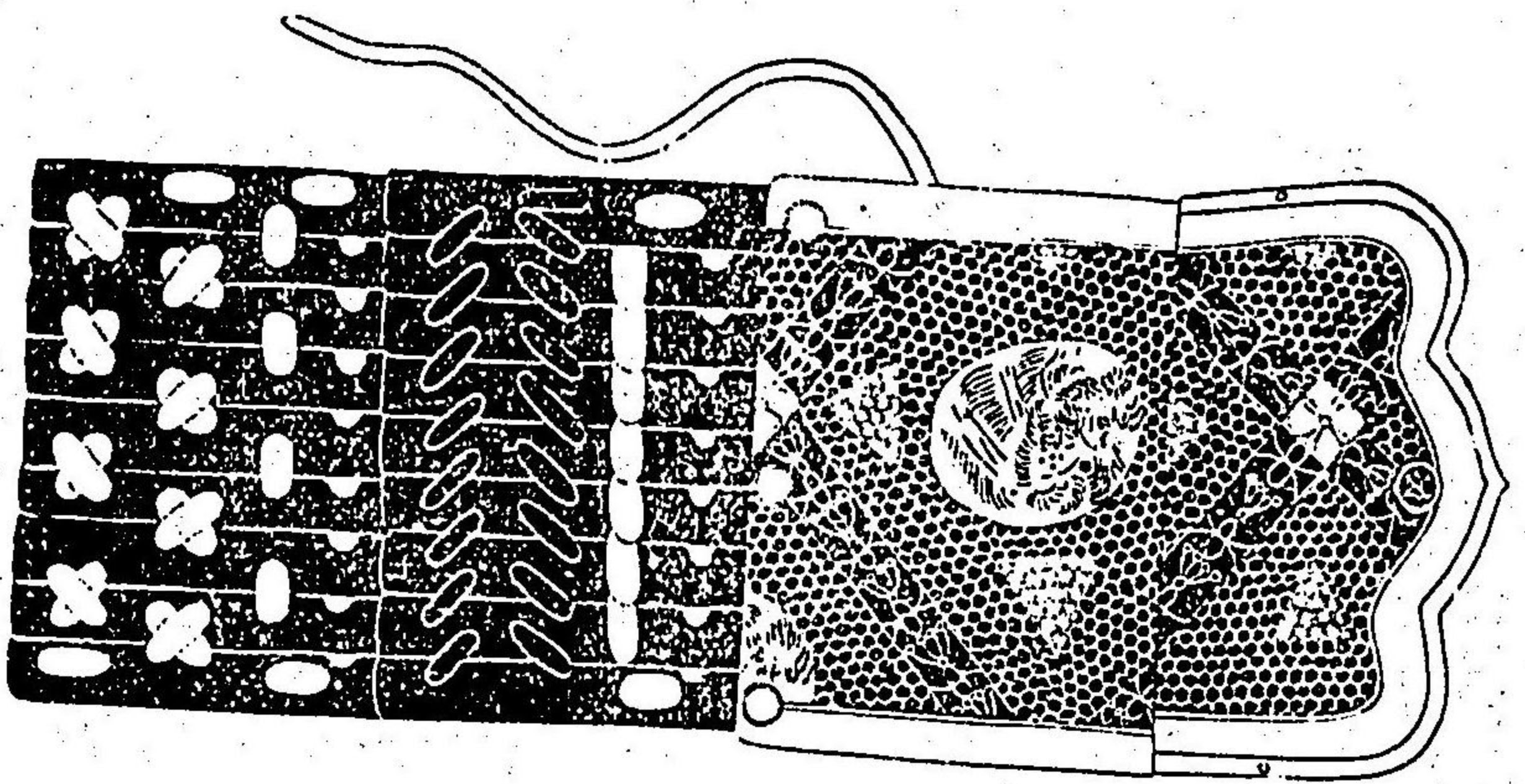

果所藍及鈞所四裝

同裏

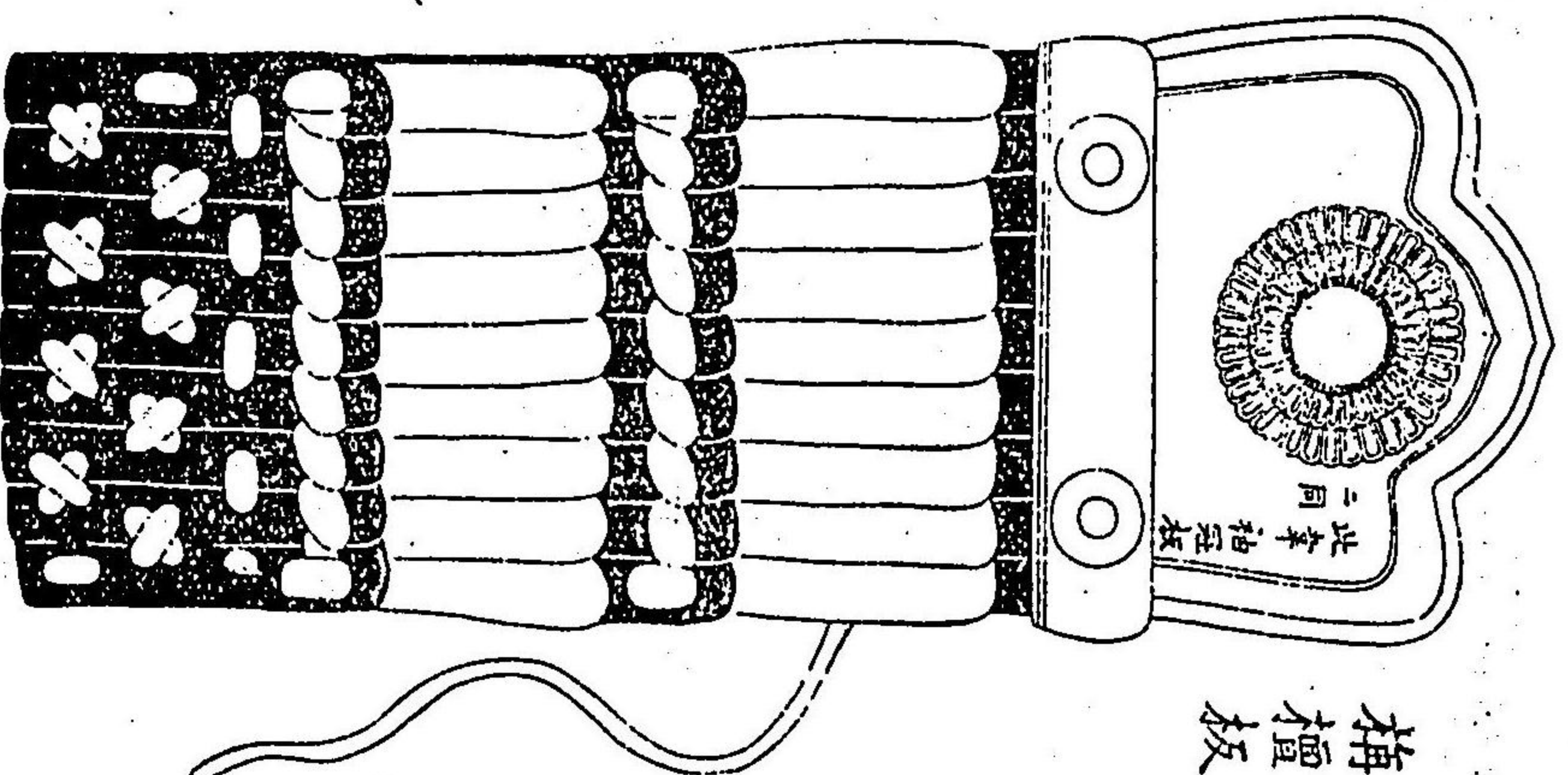

此章抽冠板同

梅摺板

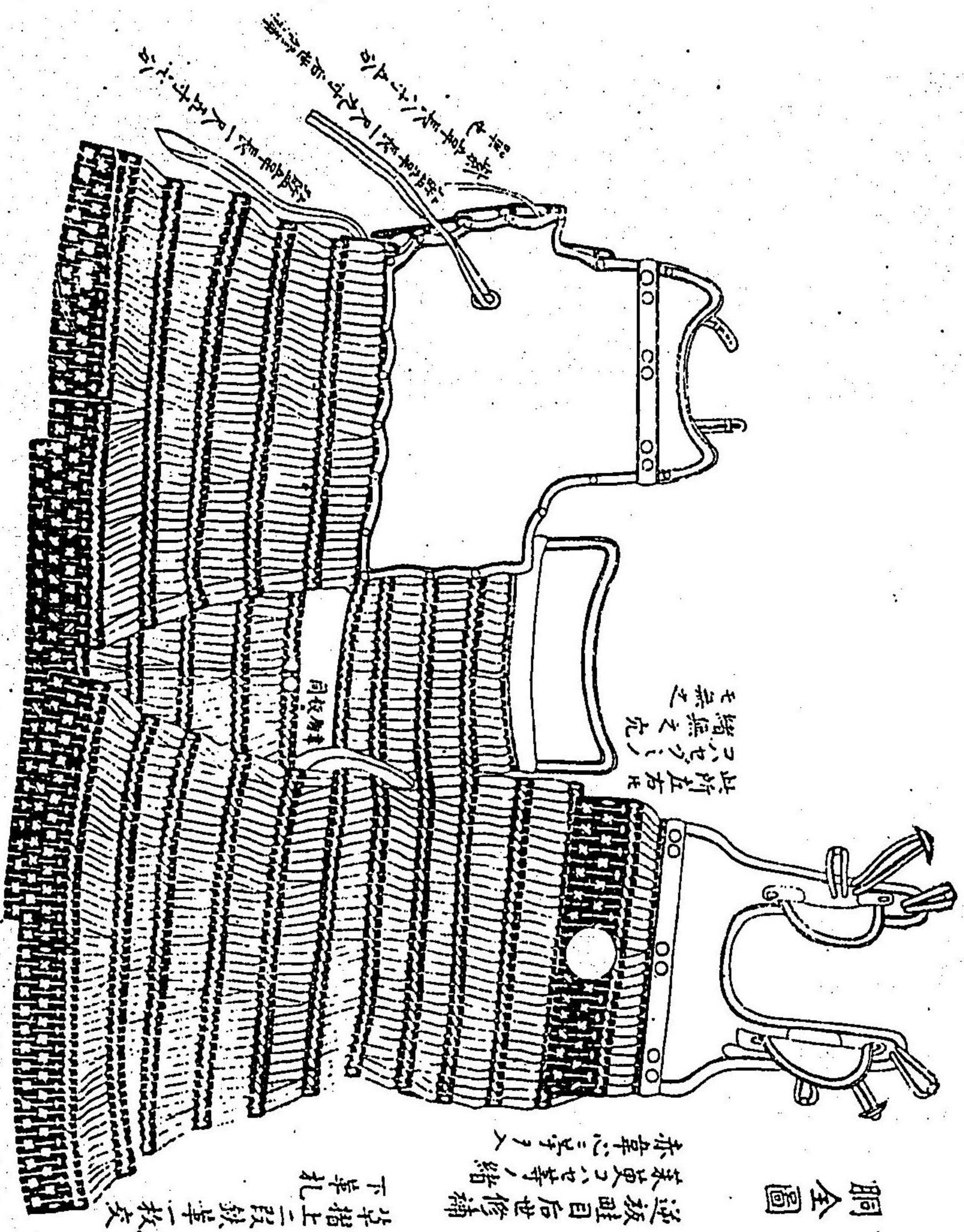

總角
 色苗
 本寸一分八分

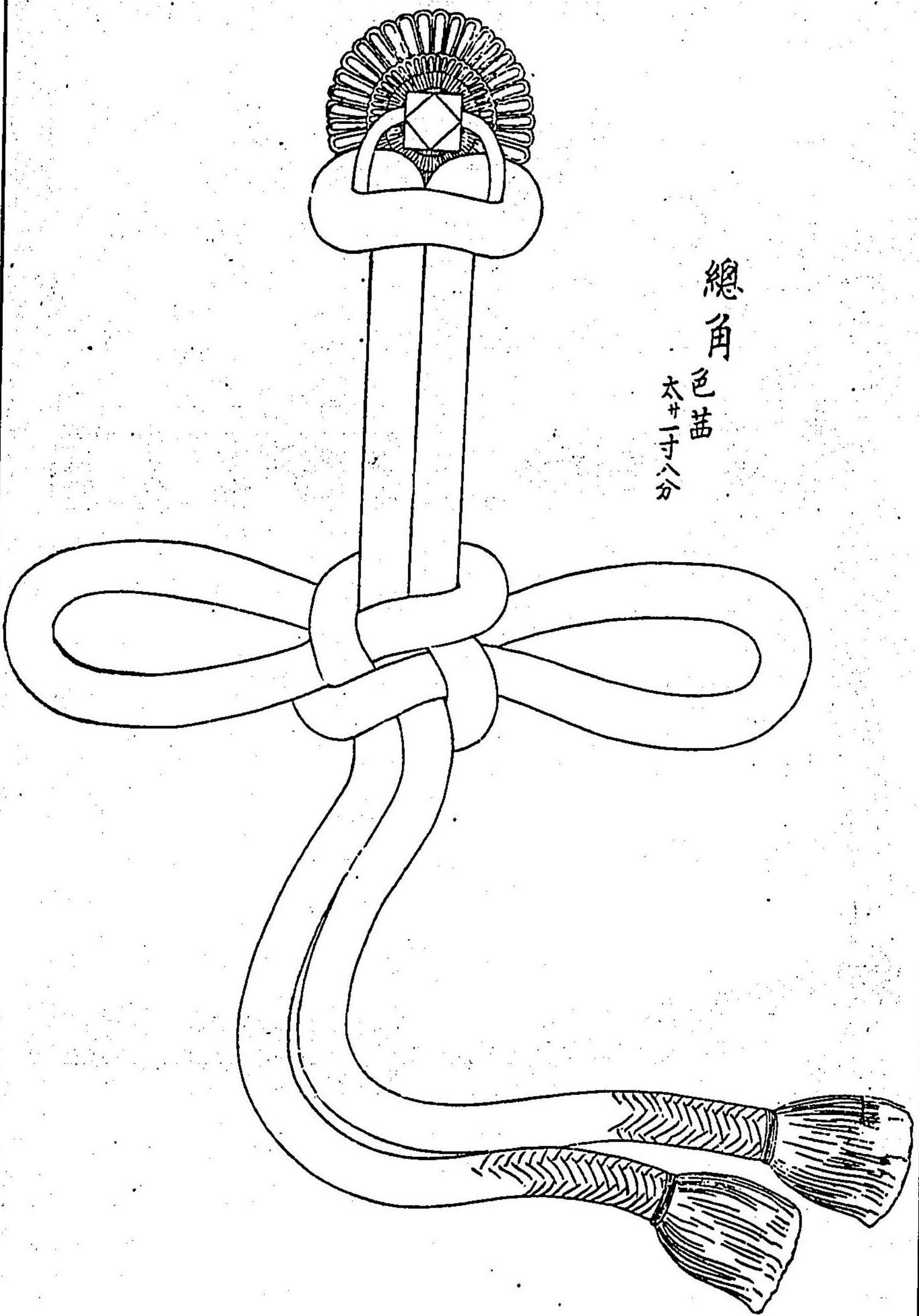

胸板

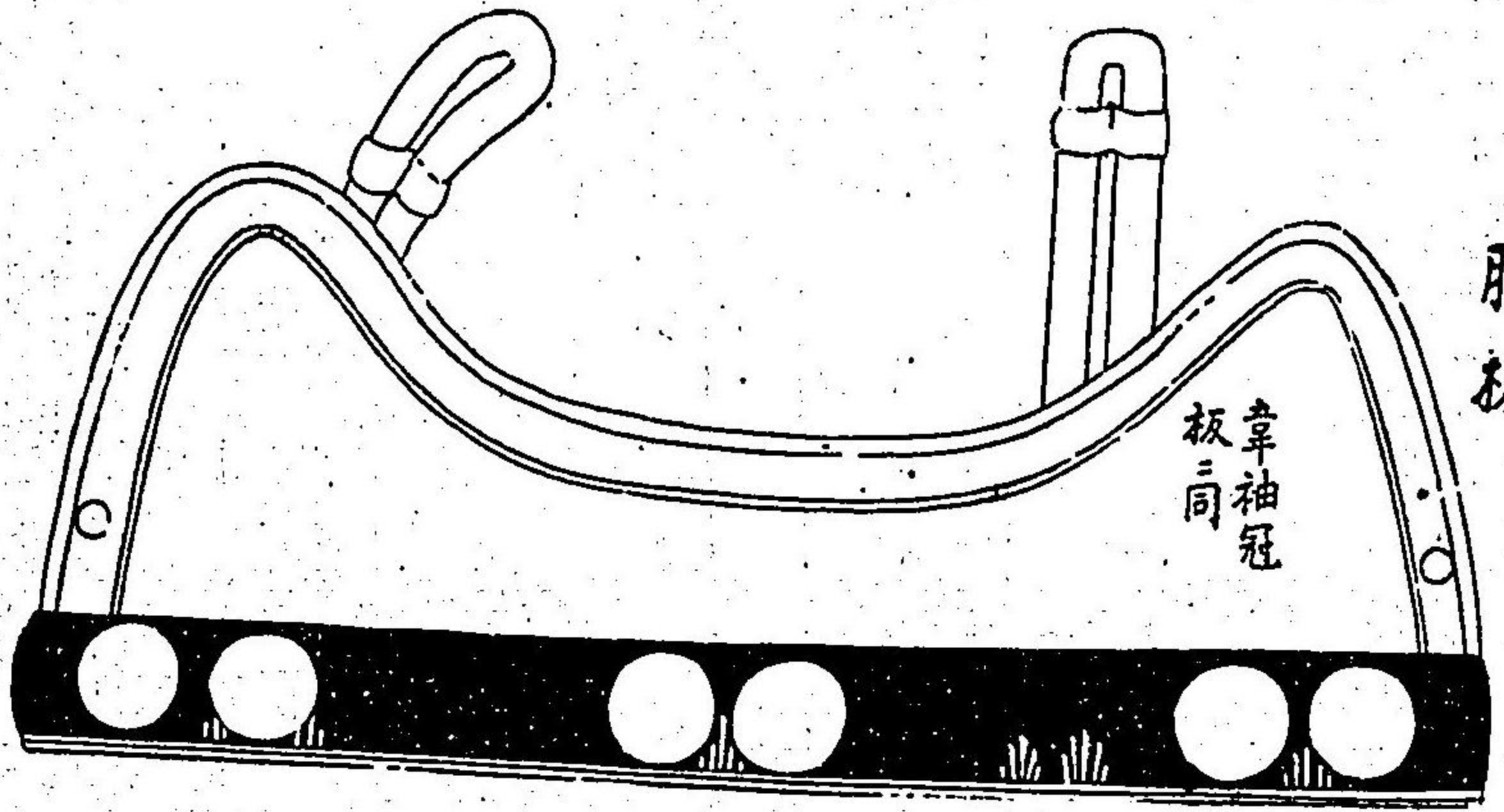

射向



綿嚙

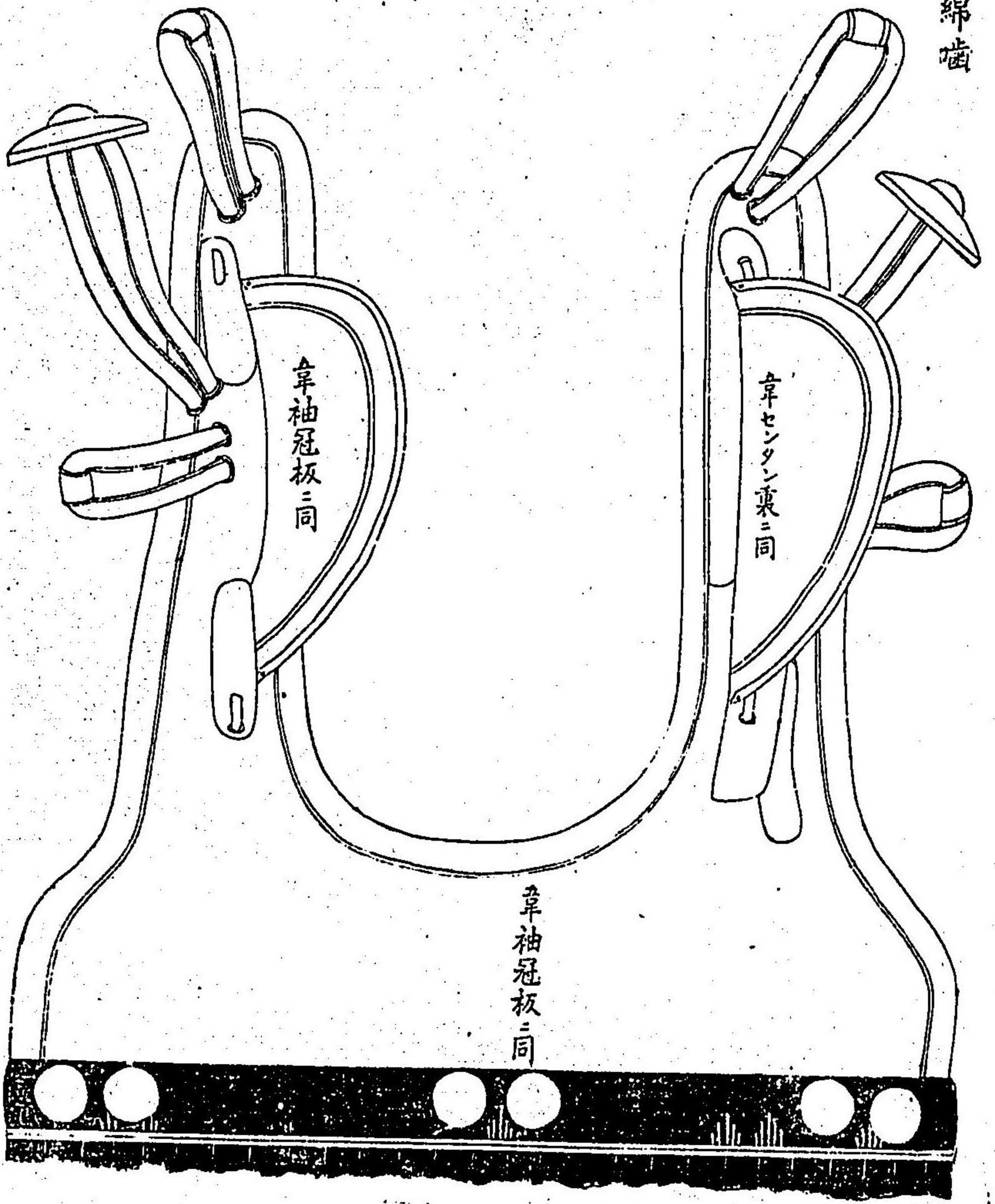

綿嚙裏

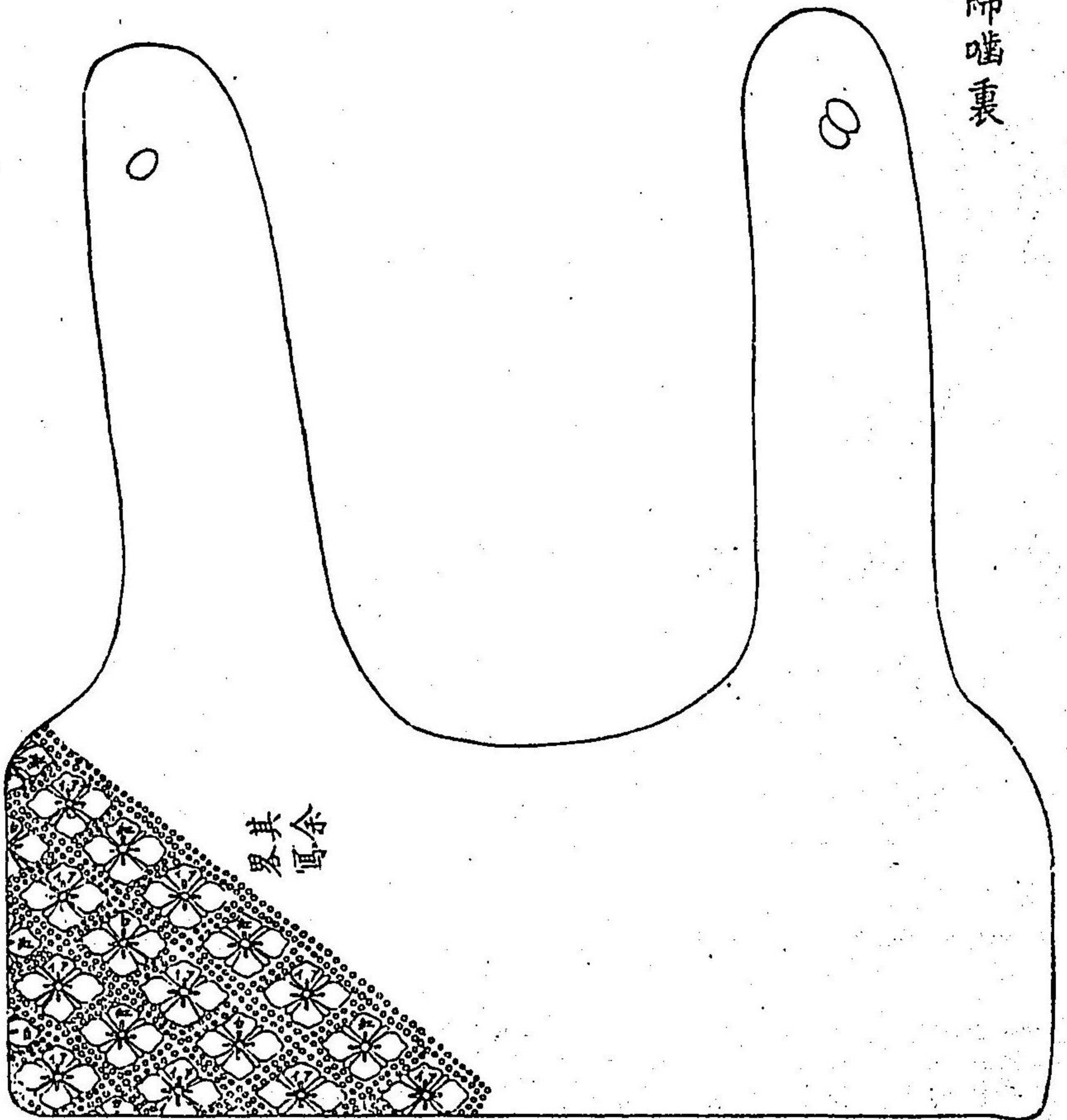

地白
花間
呈藍

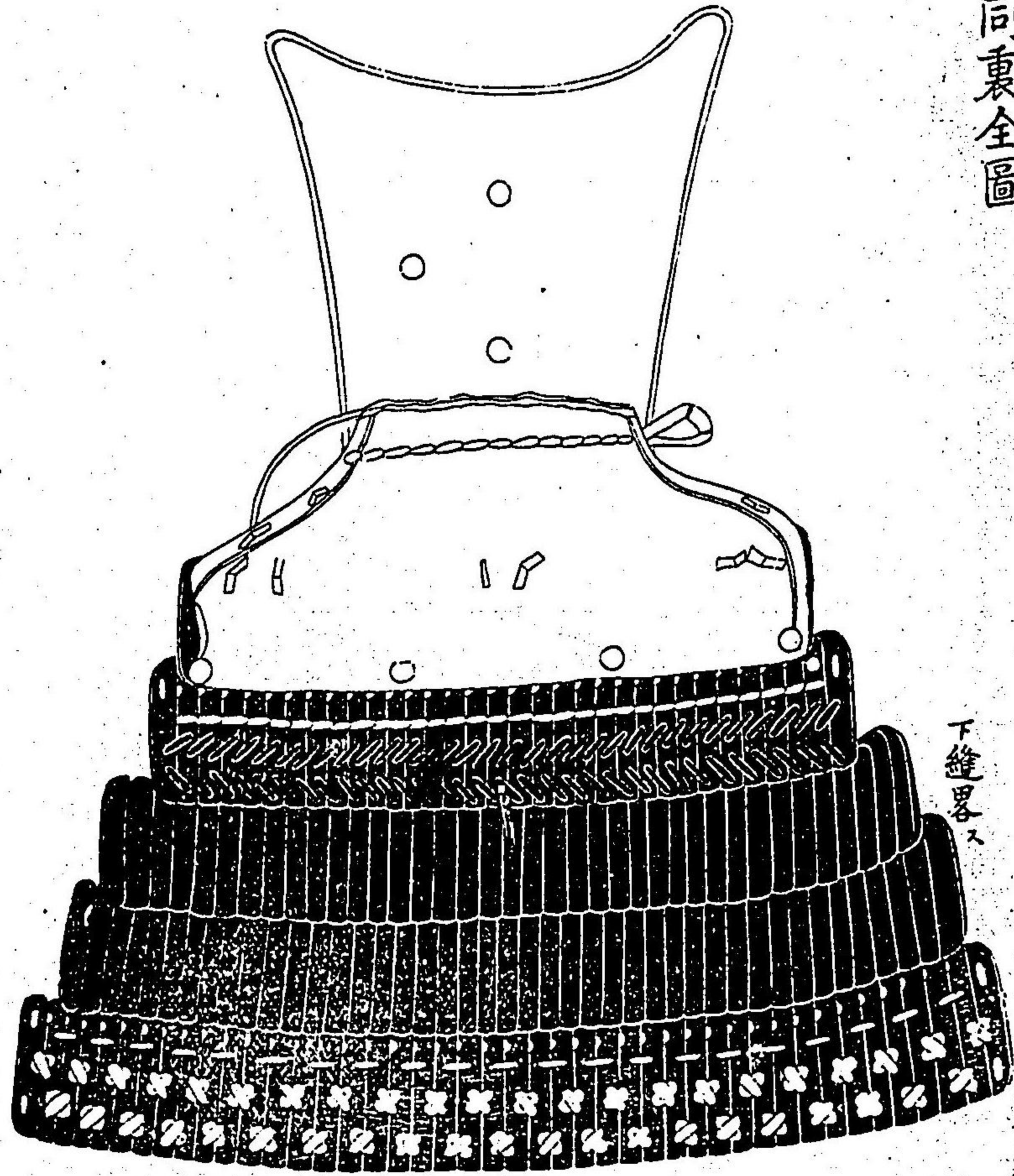

同裏全圖

下縫畧

脇楯全圖

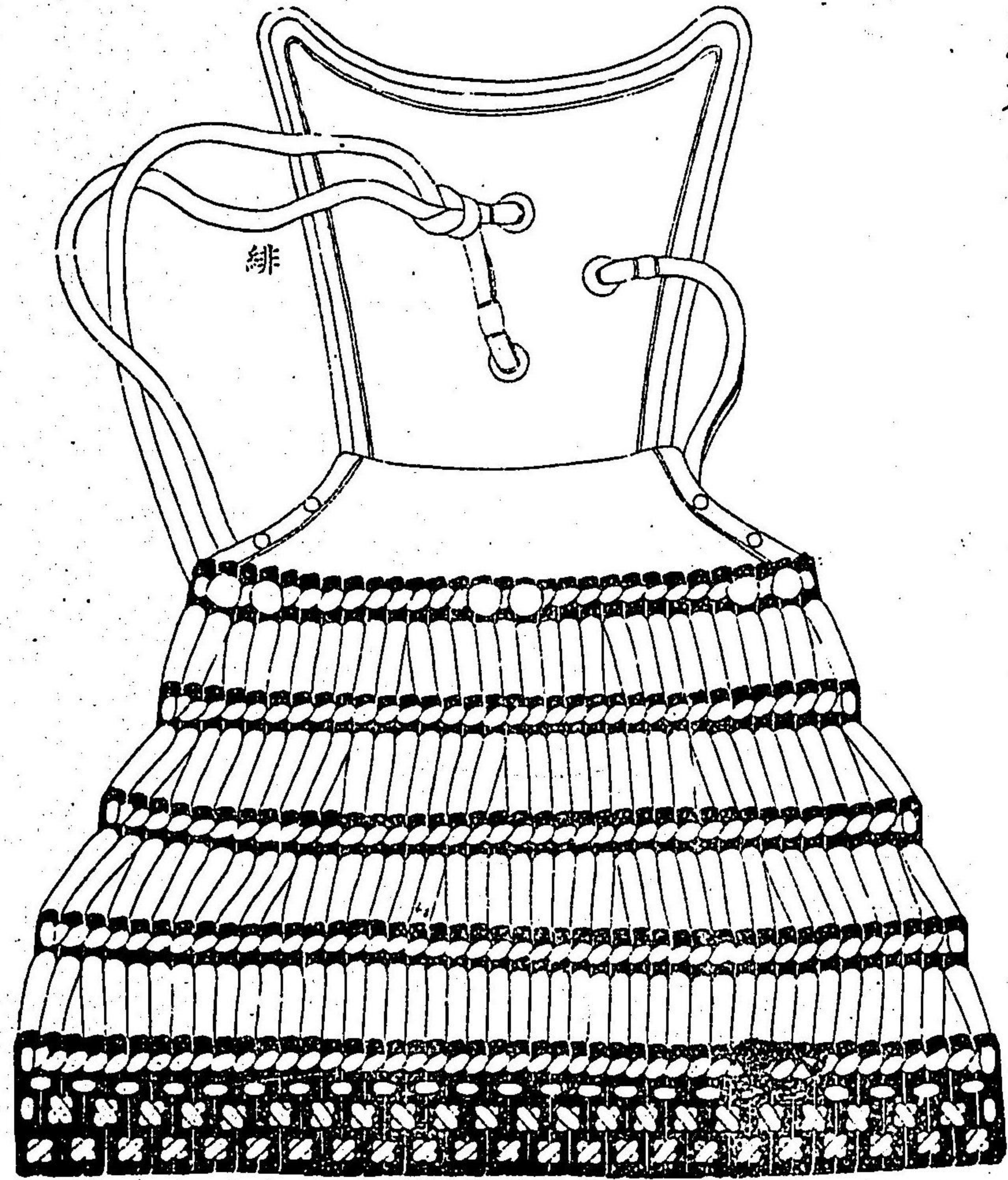

緋

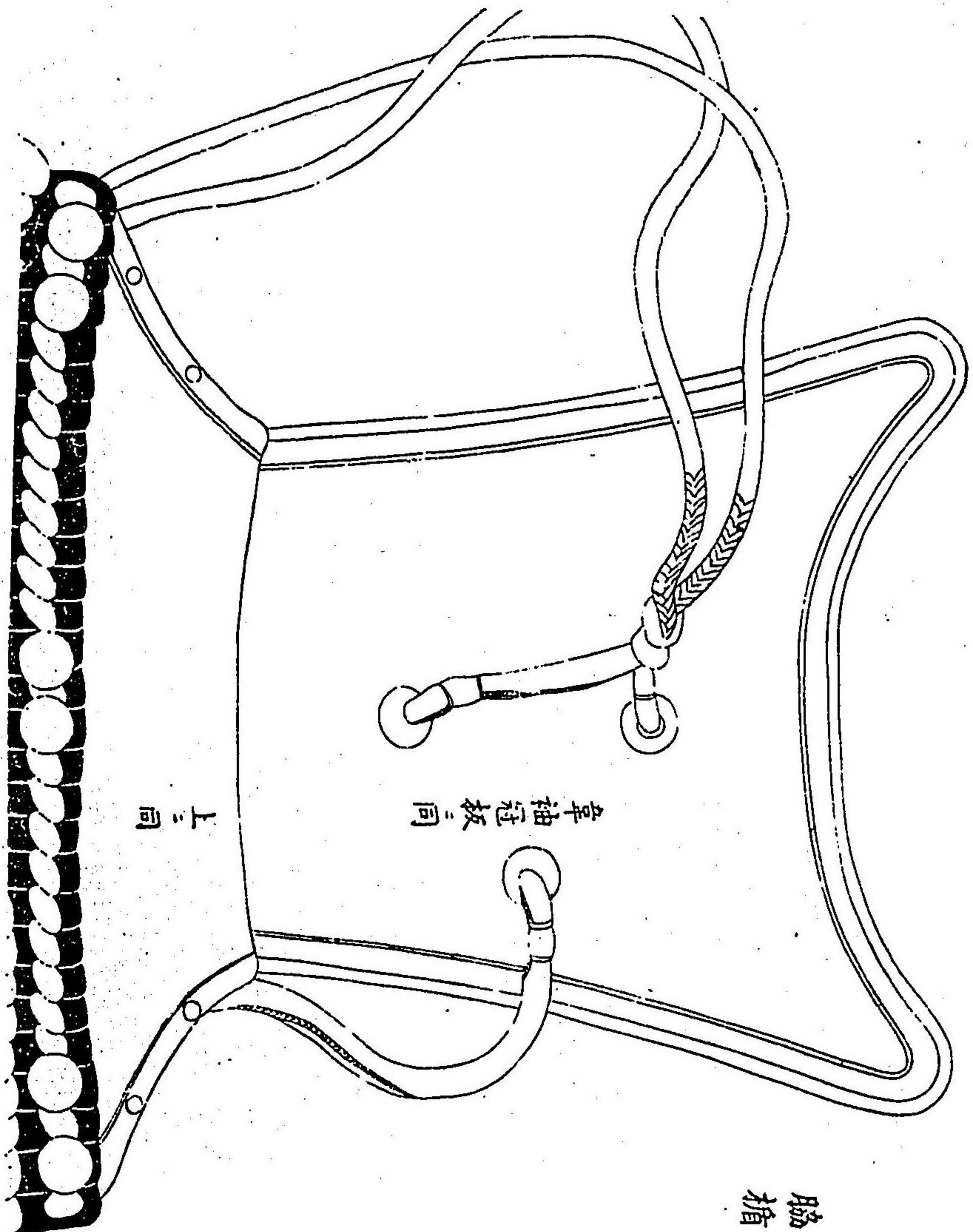

那須家藏甲冑圖

甲冑全圖

鉢黑漆 鉢裏白韋張

甲冑威系花田金物烏銅

紋所及菊花金減金

耳系睦目紺蒔莖紫白

小縁五皇伏組紺蒔莖紫白

小縁吹返眉廂

杏裏右袖裏異文

文不分明

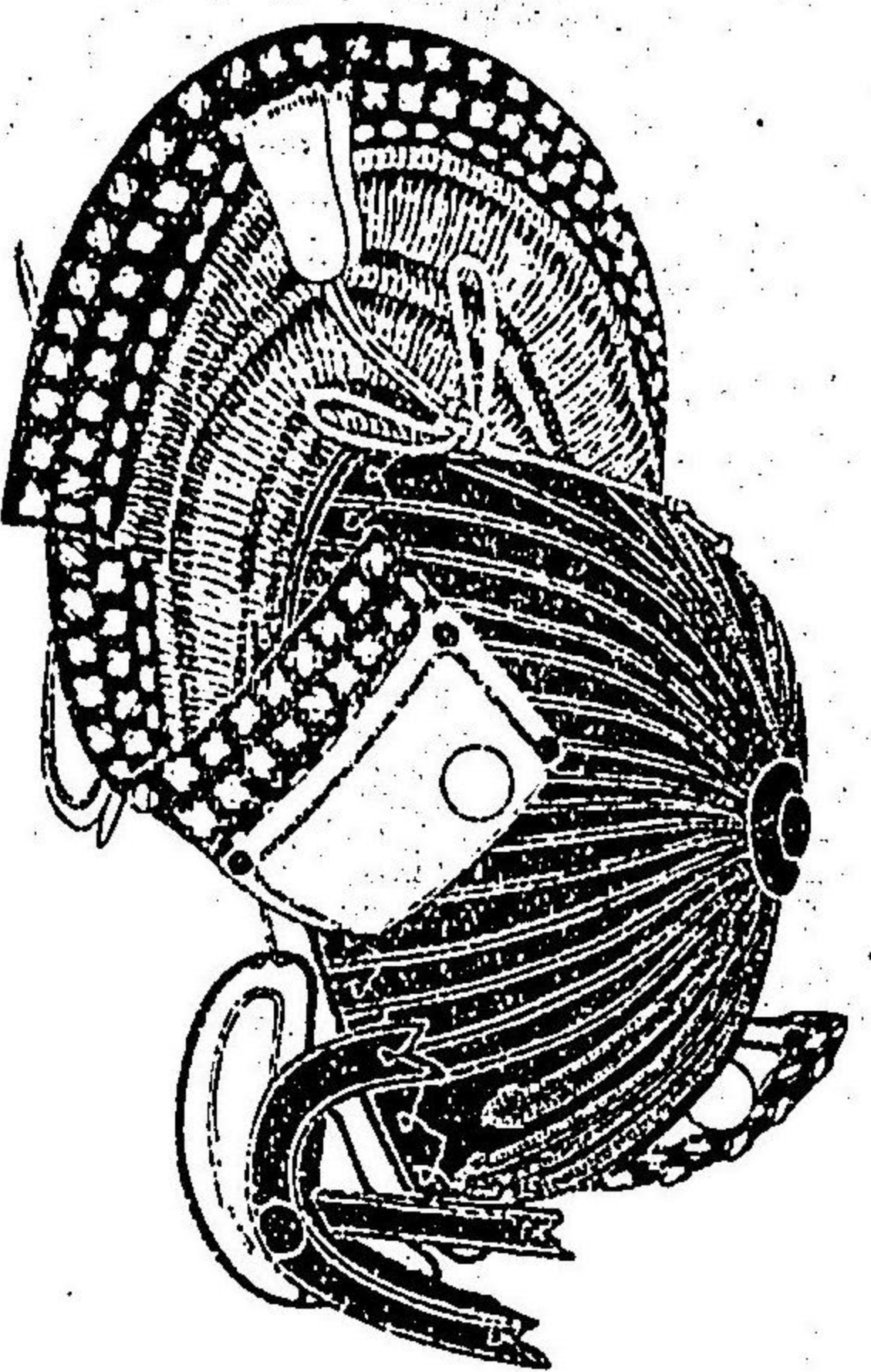

厚

子リ華金箔

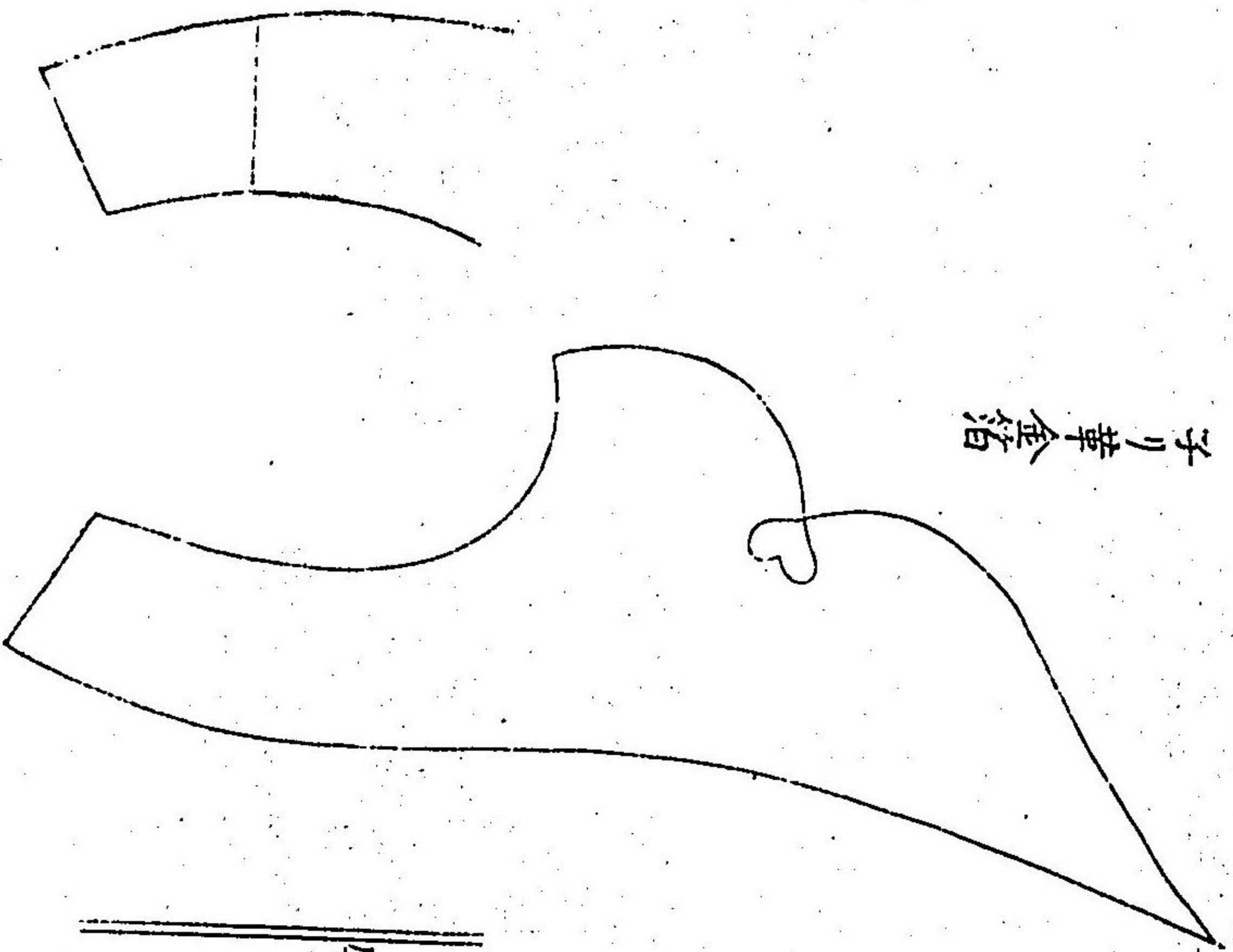

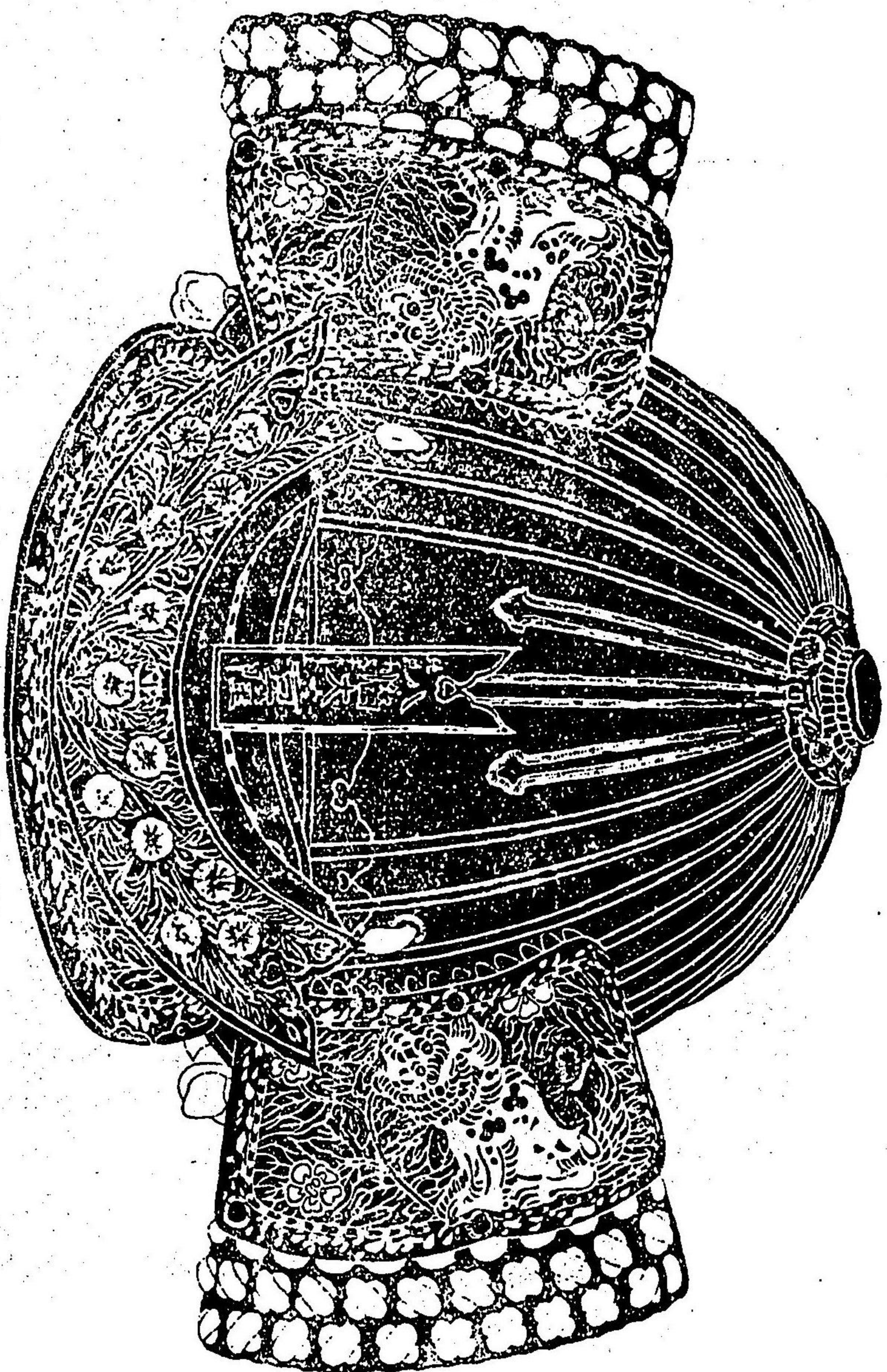

漆牟白地藍文花田紫平同

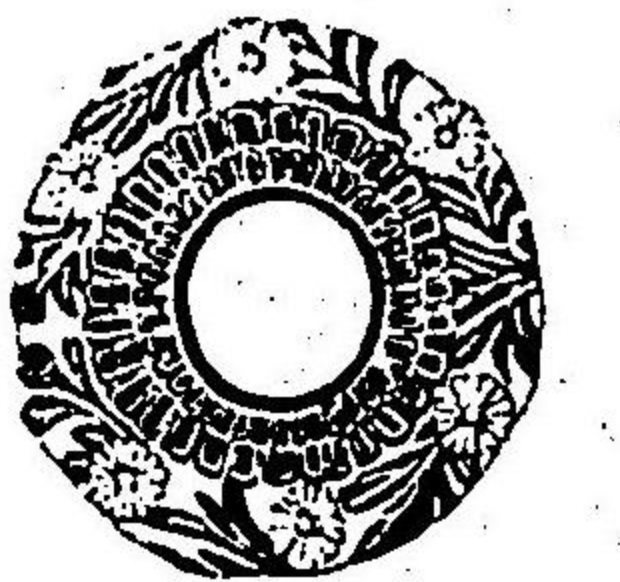

息出坐金

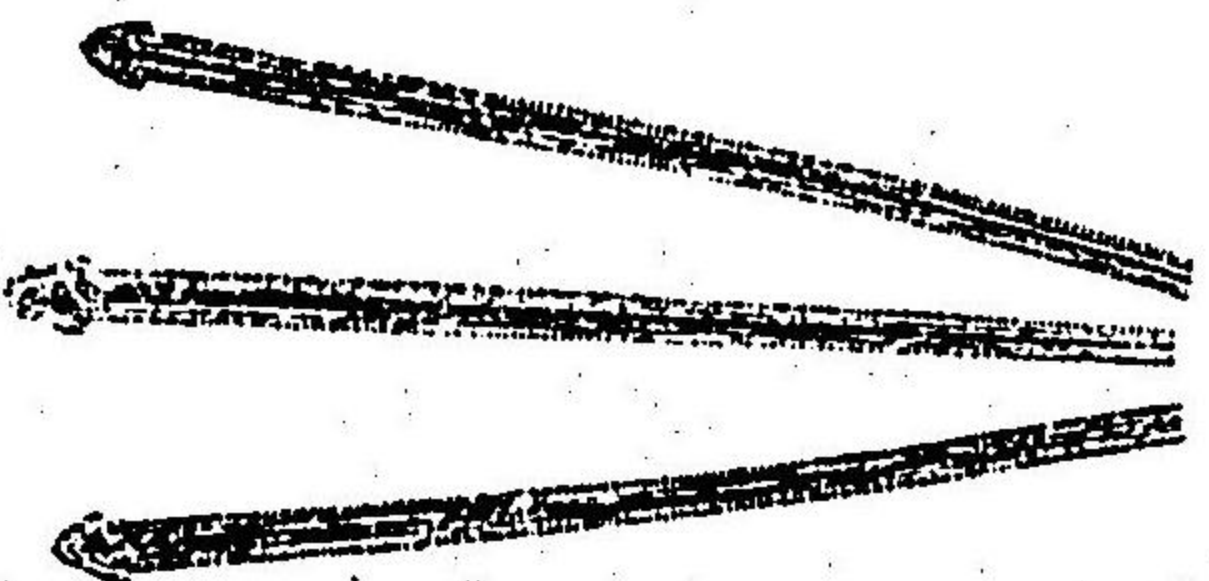

篠母

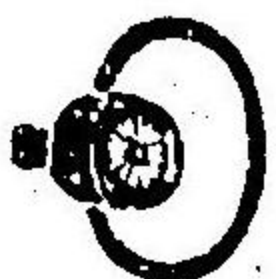

高勝銀



二及金物

前

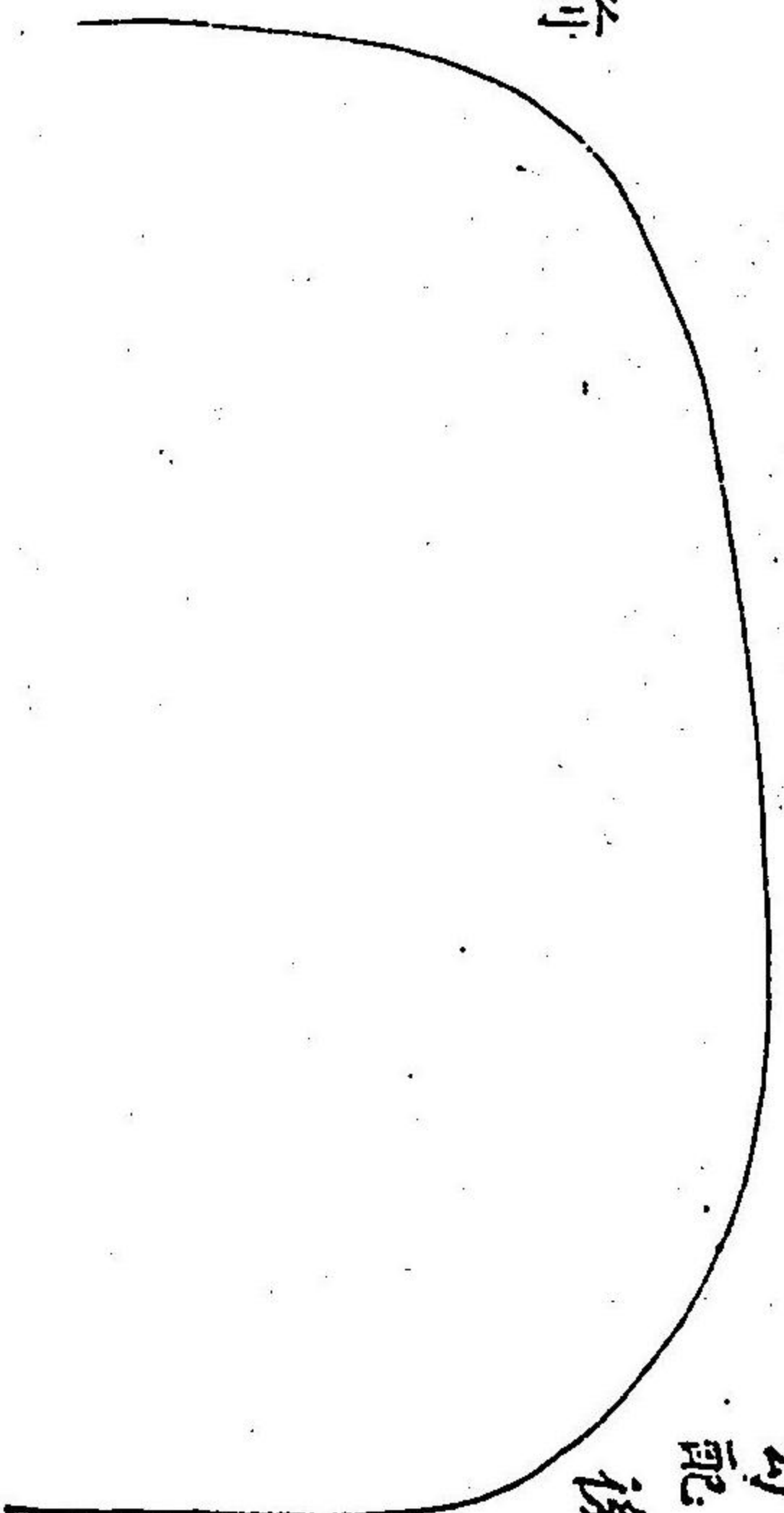

勾配後

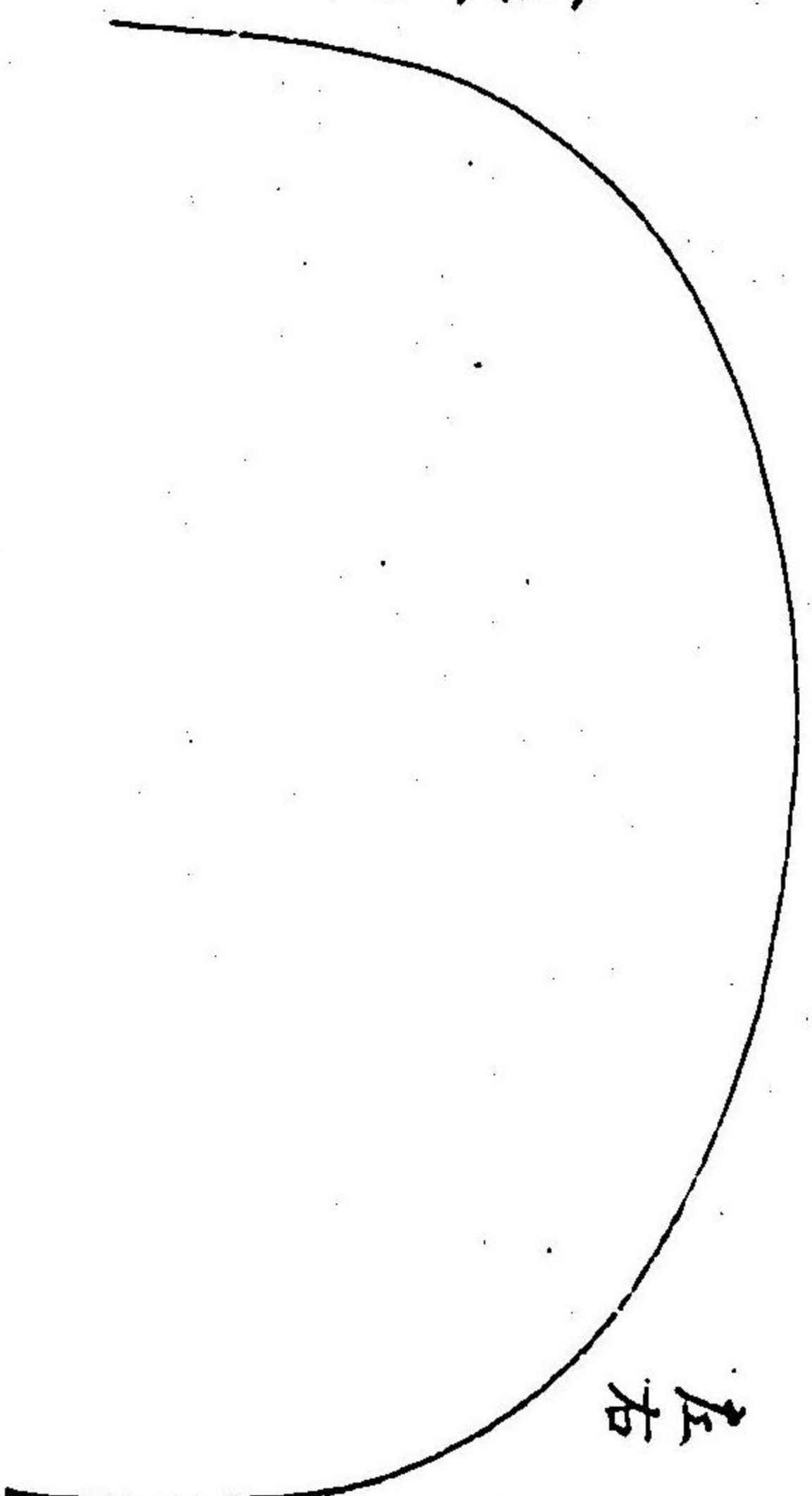

左右

鉢裏
續后世物

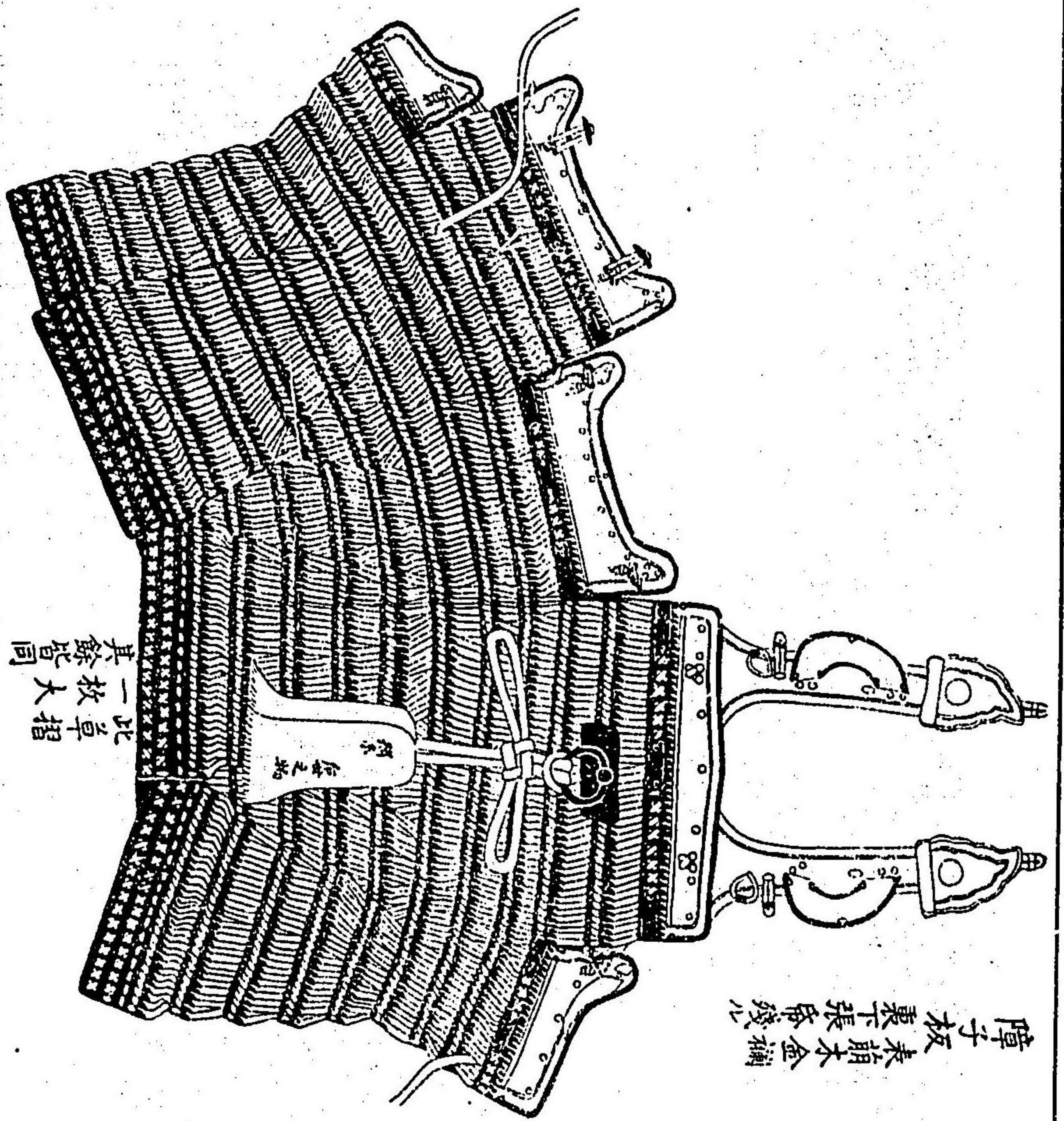
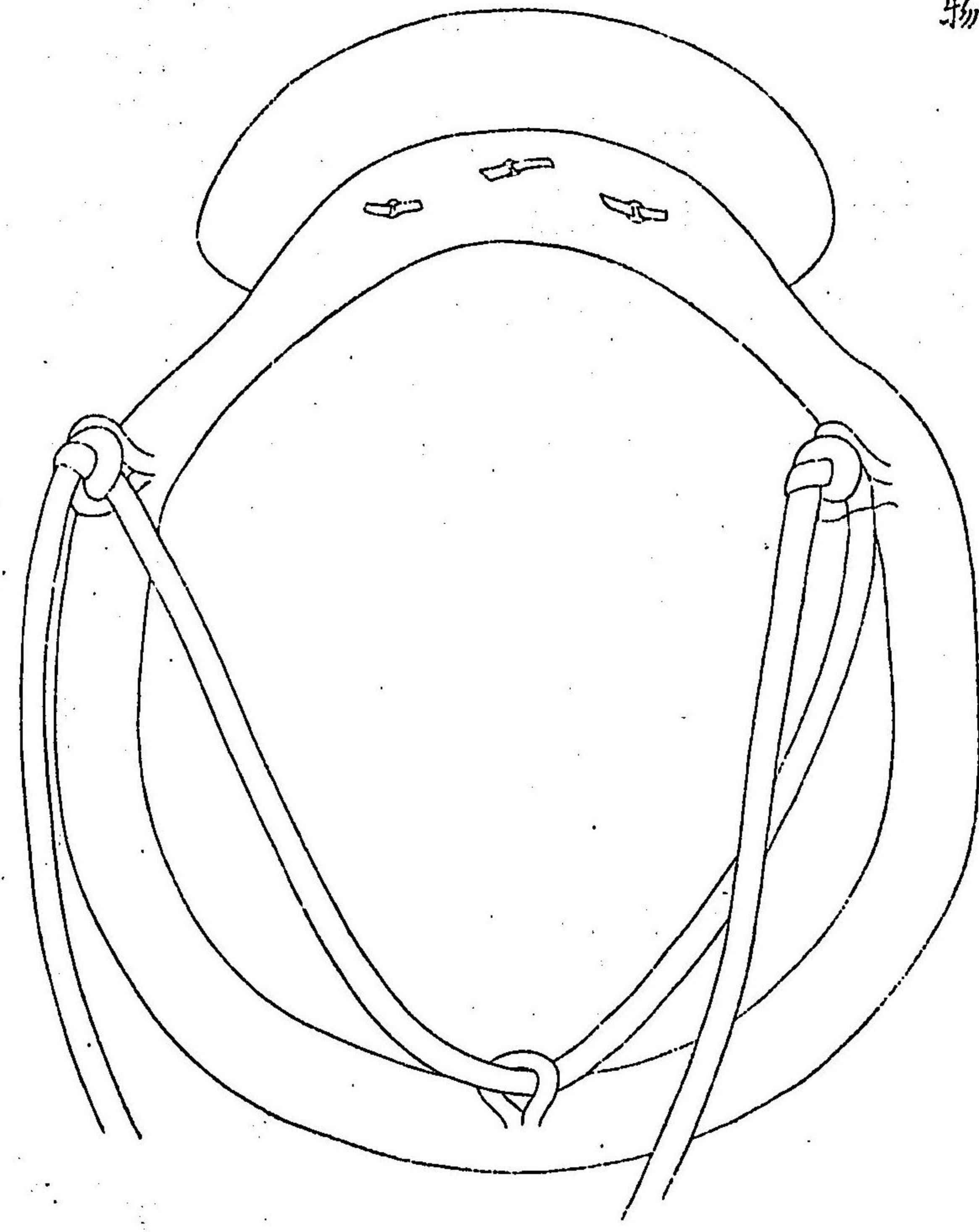

胴丸全圖

引合緒 矢筈 龜甲
色紐 耳糸 二同

障子板 表崩木金襴
裏下張帛殘心

此草摺 一枚大
其餘皆同

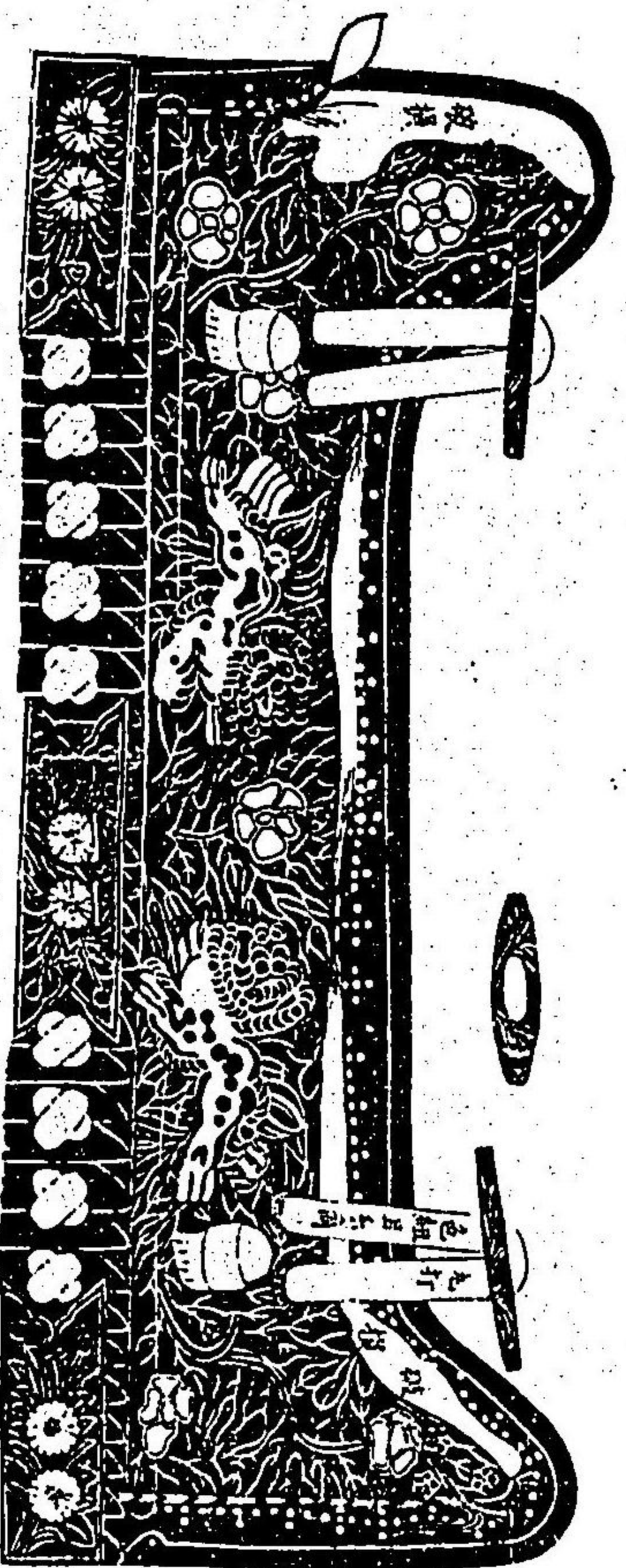

前後



脇

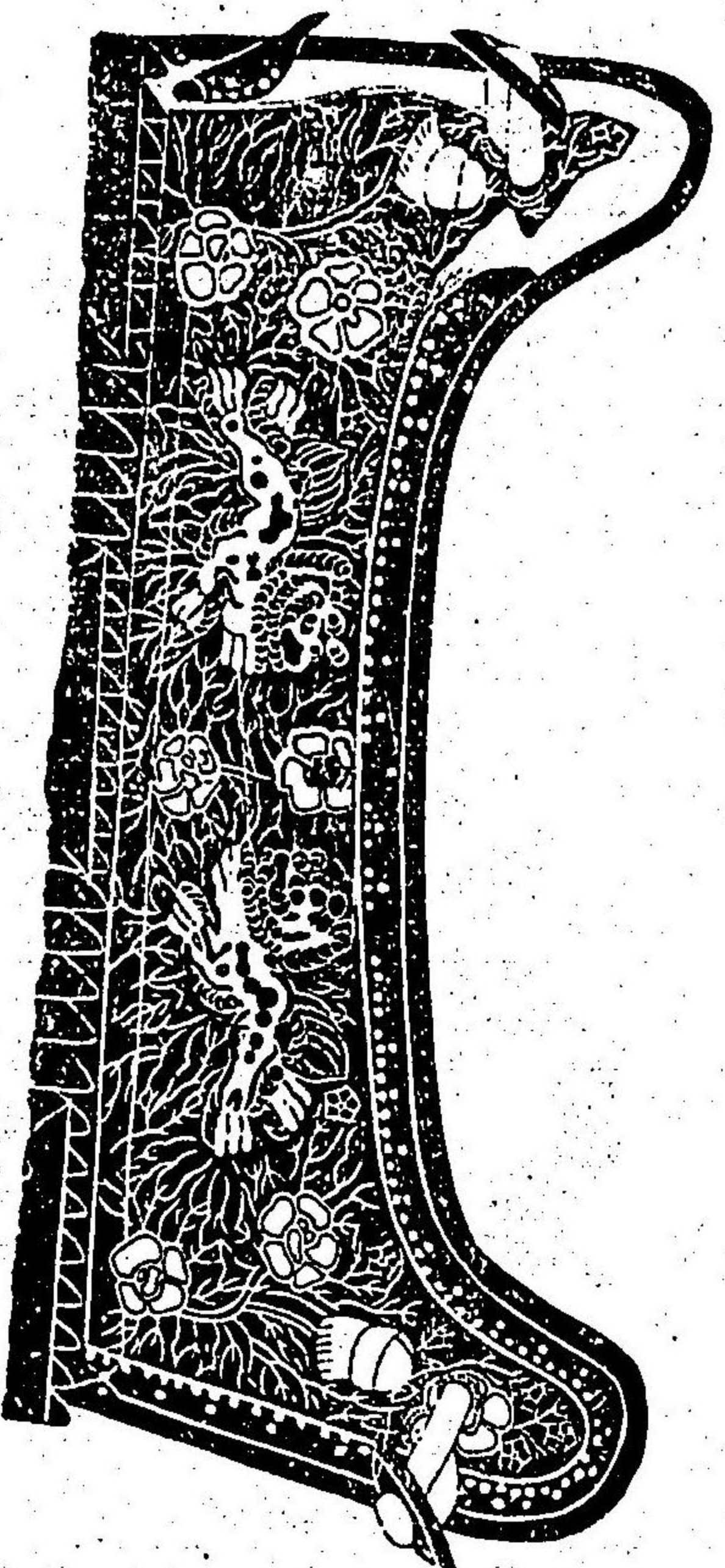

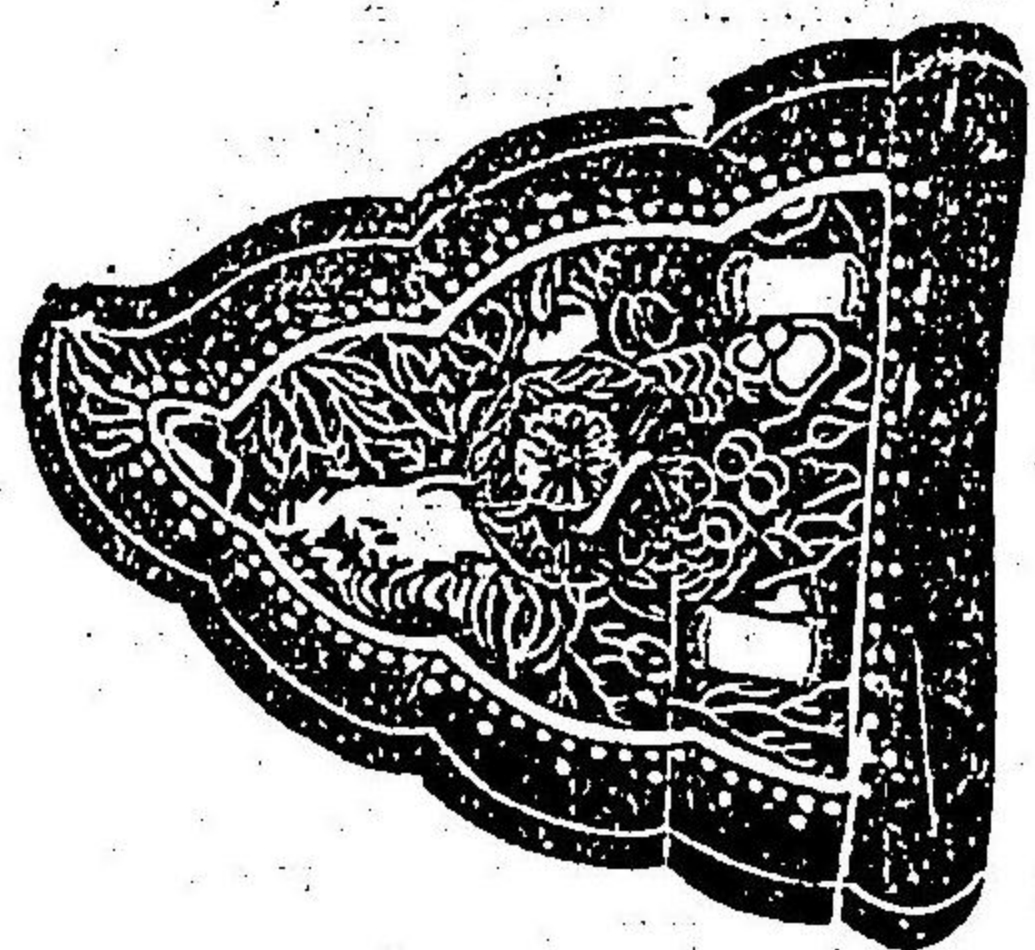
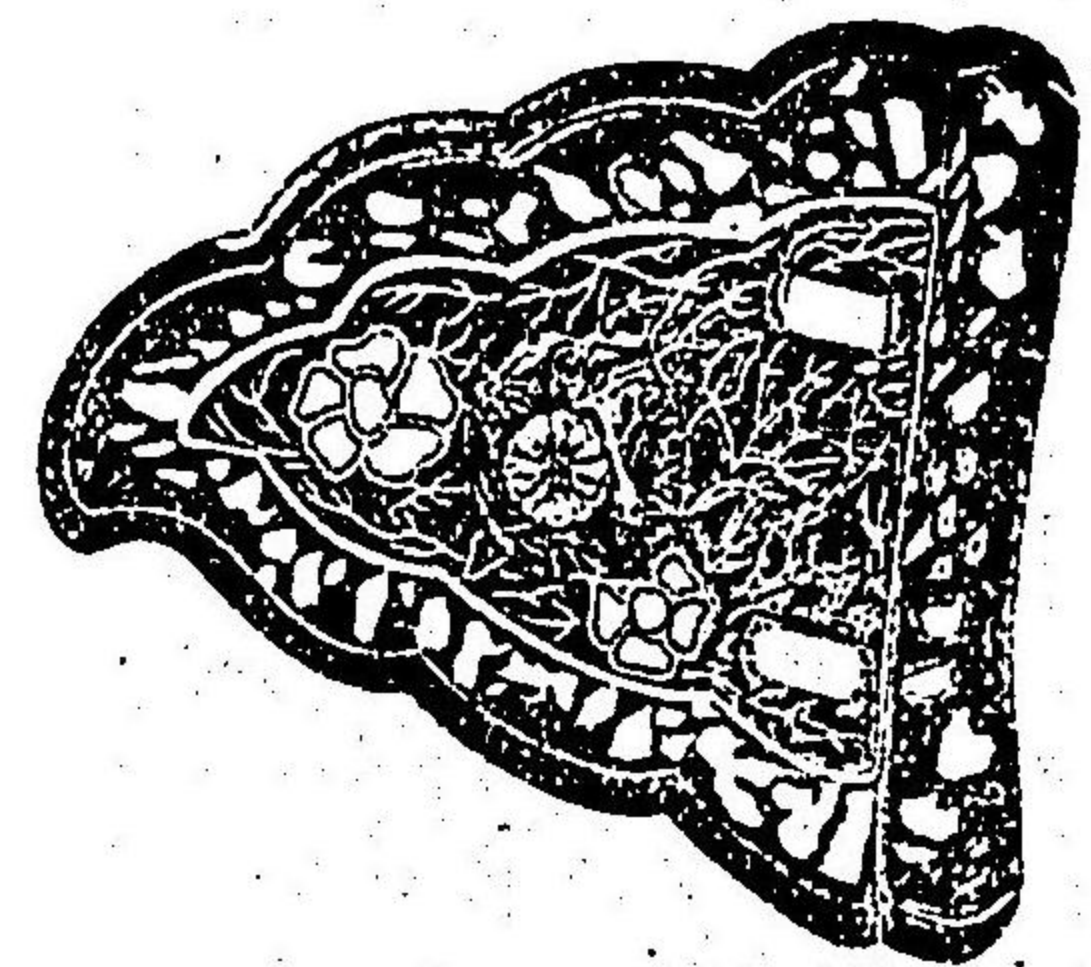

杏葉



紫黃金物



總角付金物

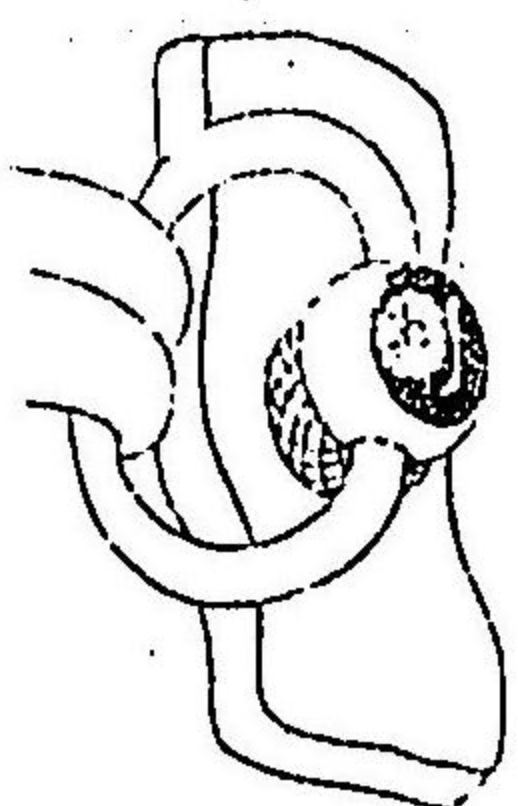

銀頭

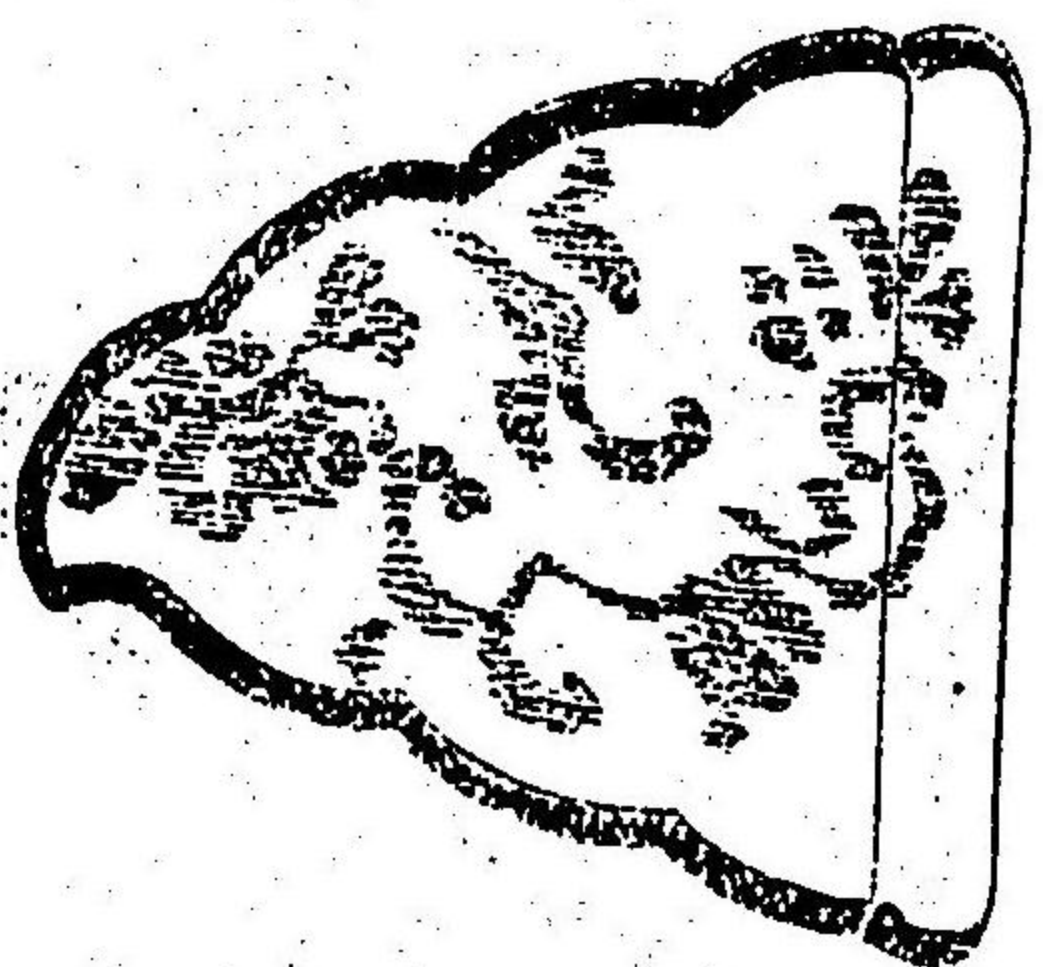

裏以金網
張之萌黃地金文

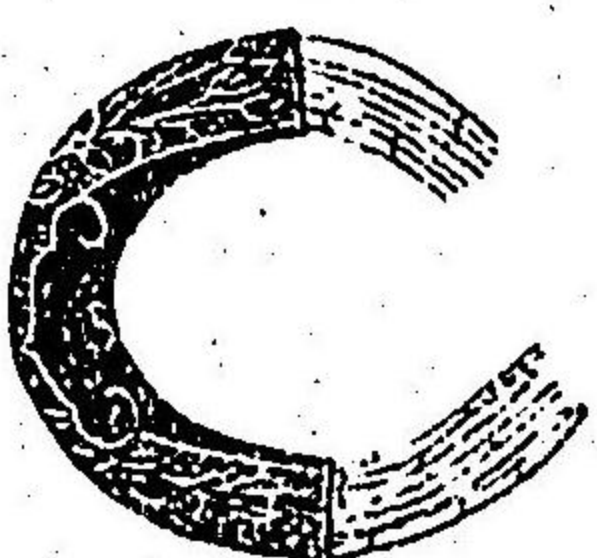

鐐ノ金物

草摺

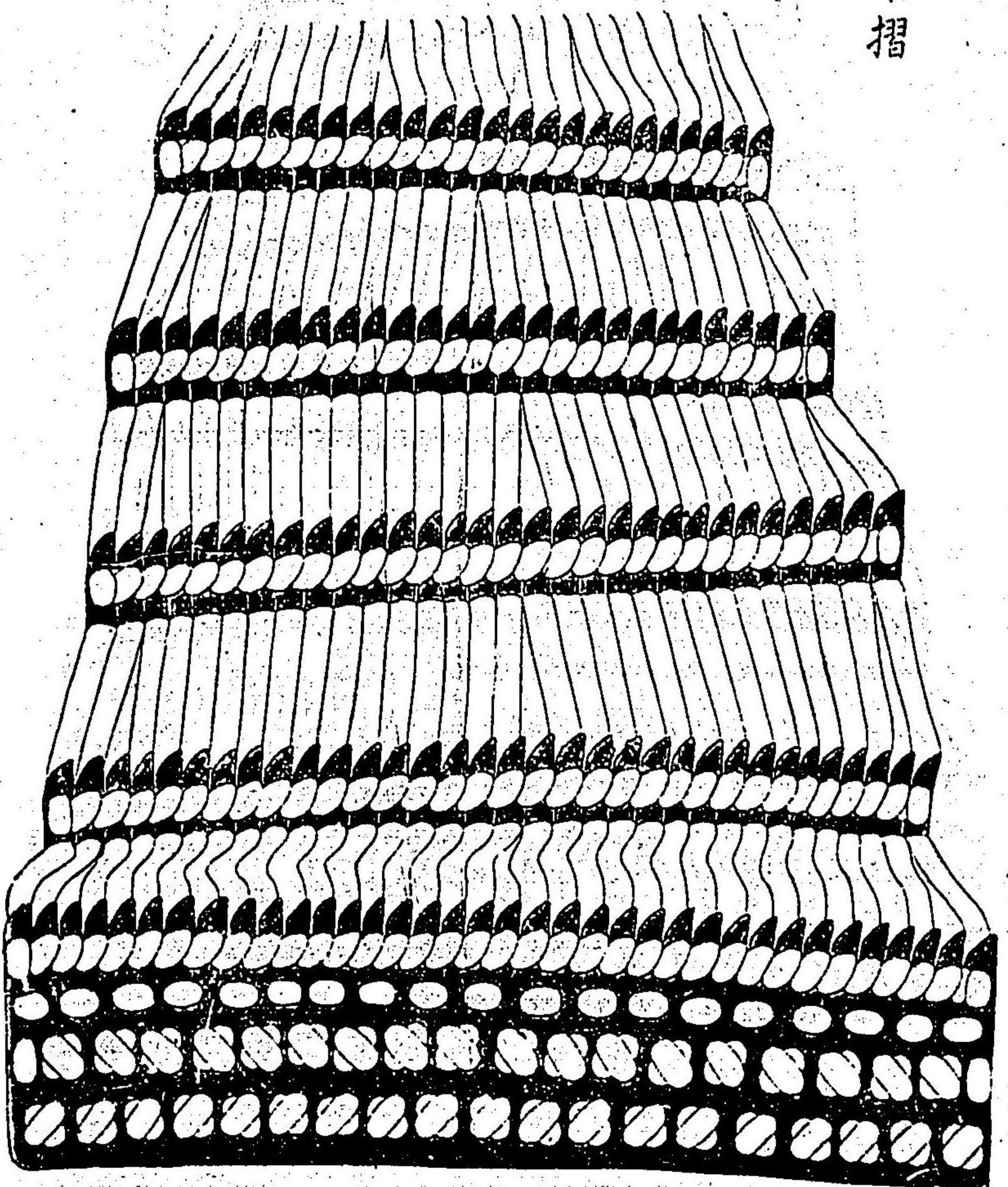

同

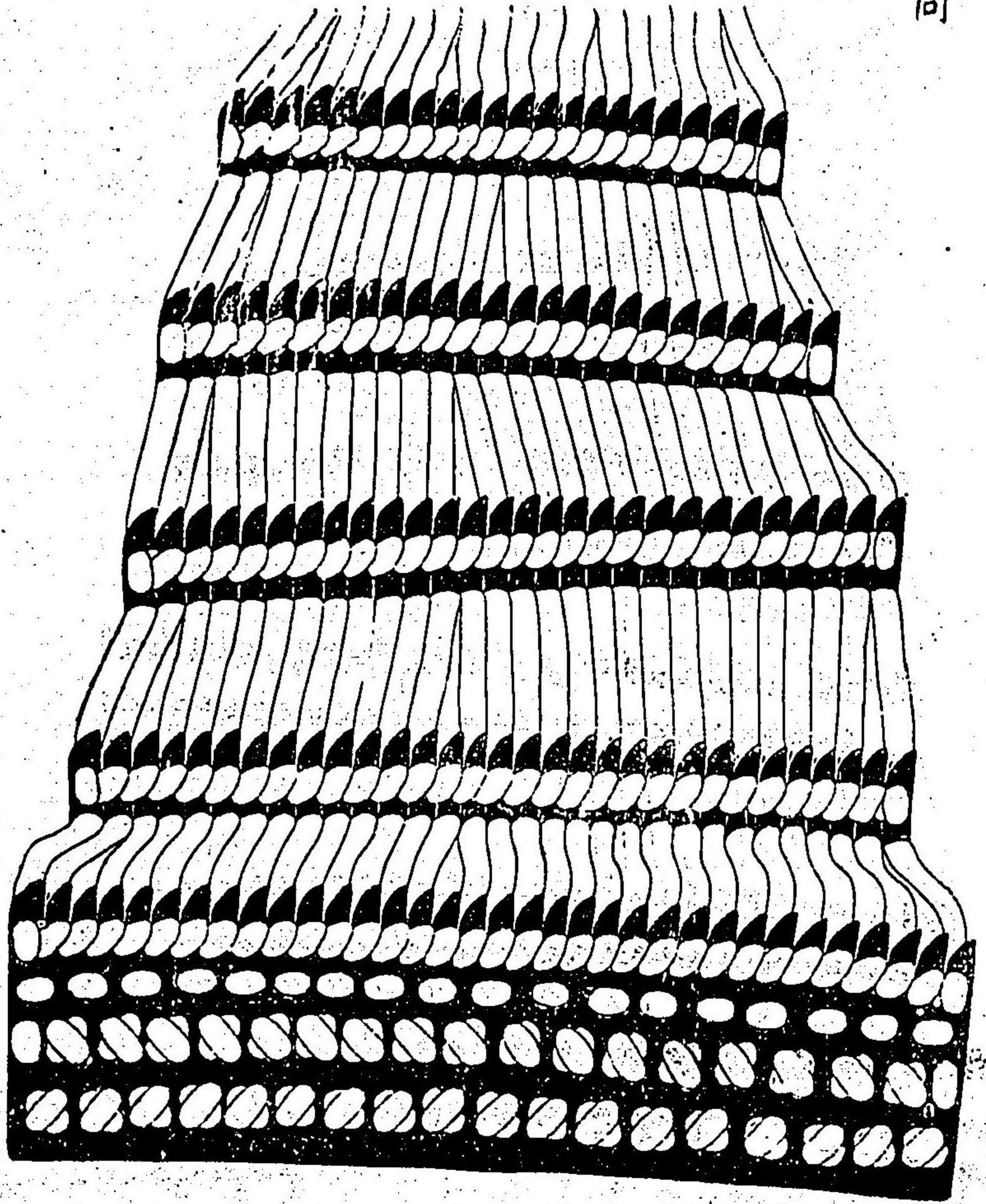

裏

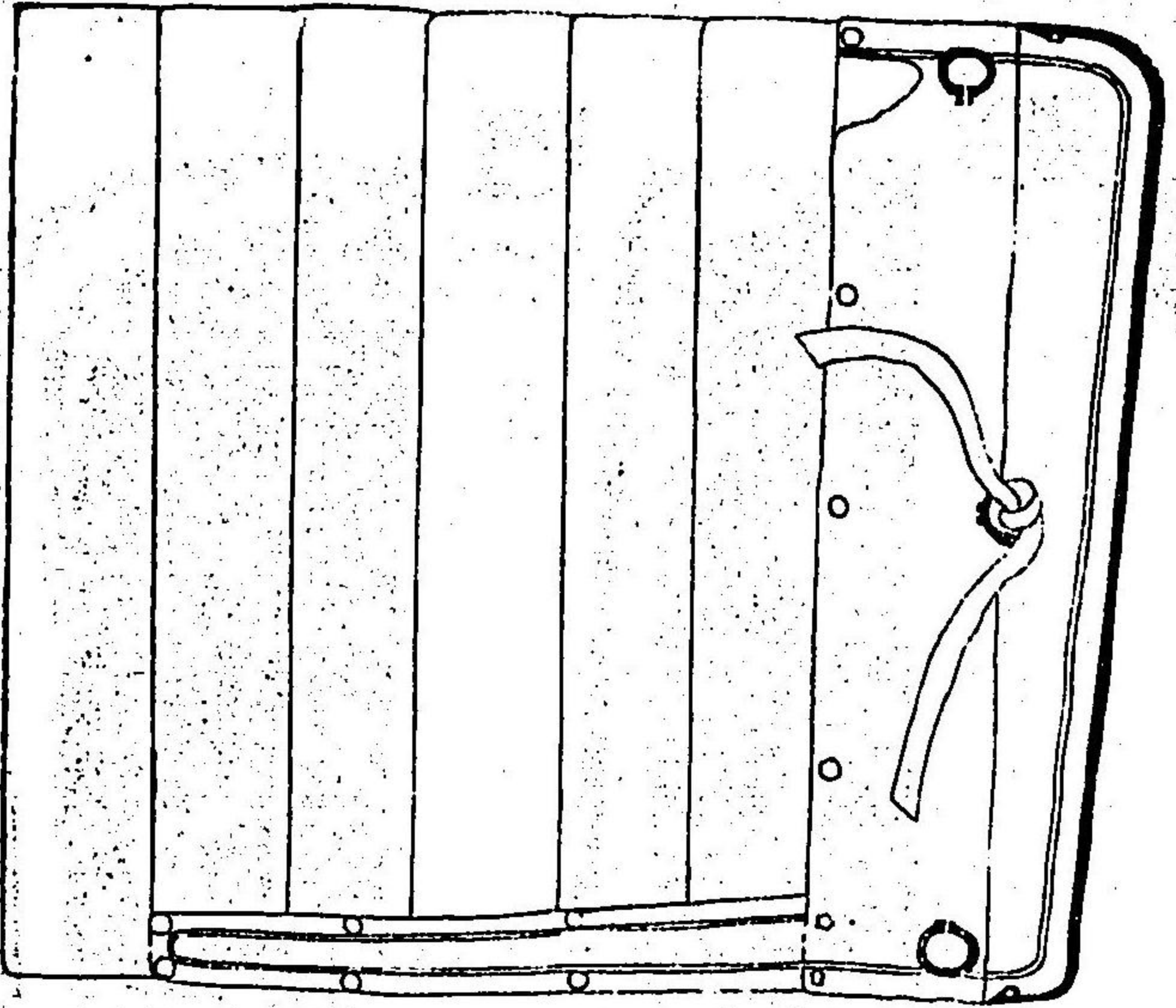

表

袖

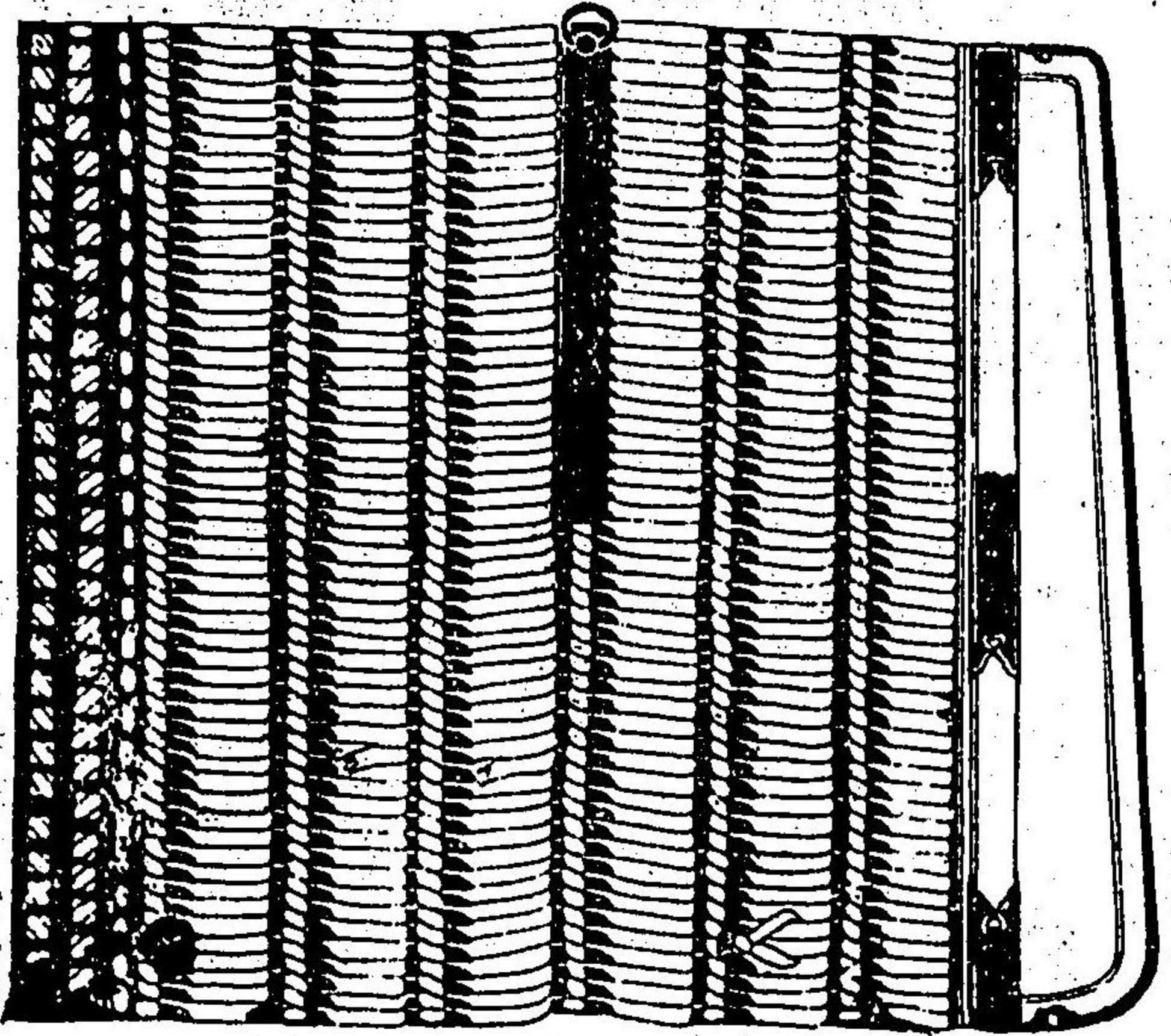

結平緒如圖結用之



板袖冠
五星綠
器屬

紅白
下



笄金物
金物及び木
下切し張地合
色不分明

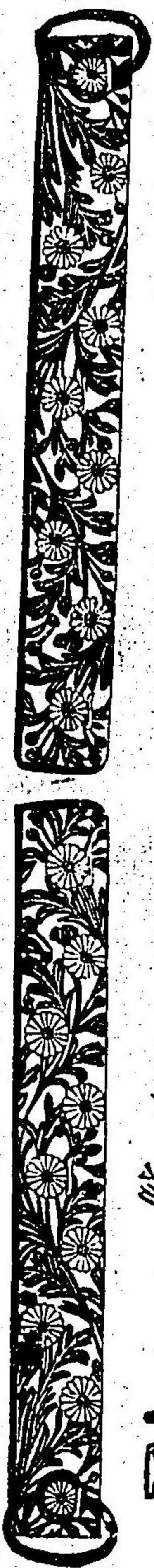

袖裏

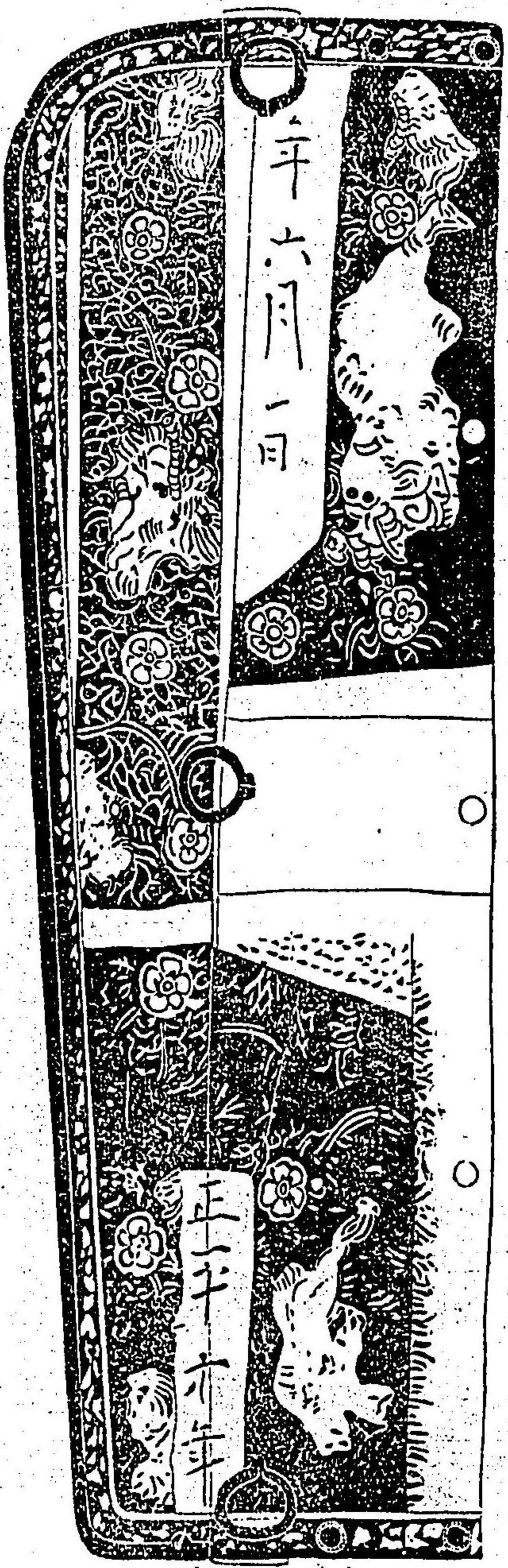

銀鉄



塩子摺敷
赤地金襴

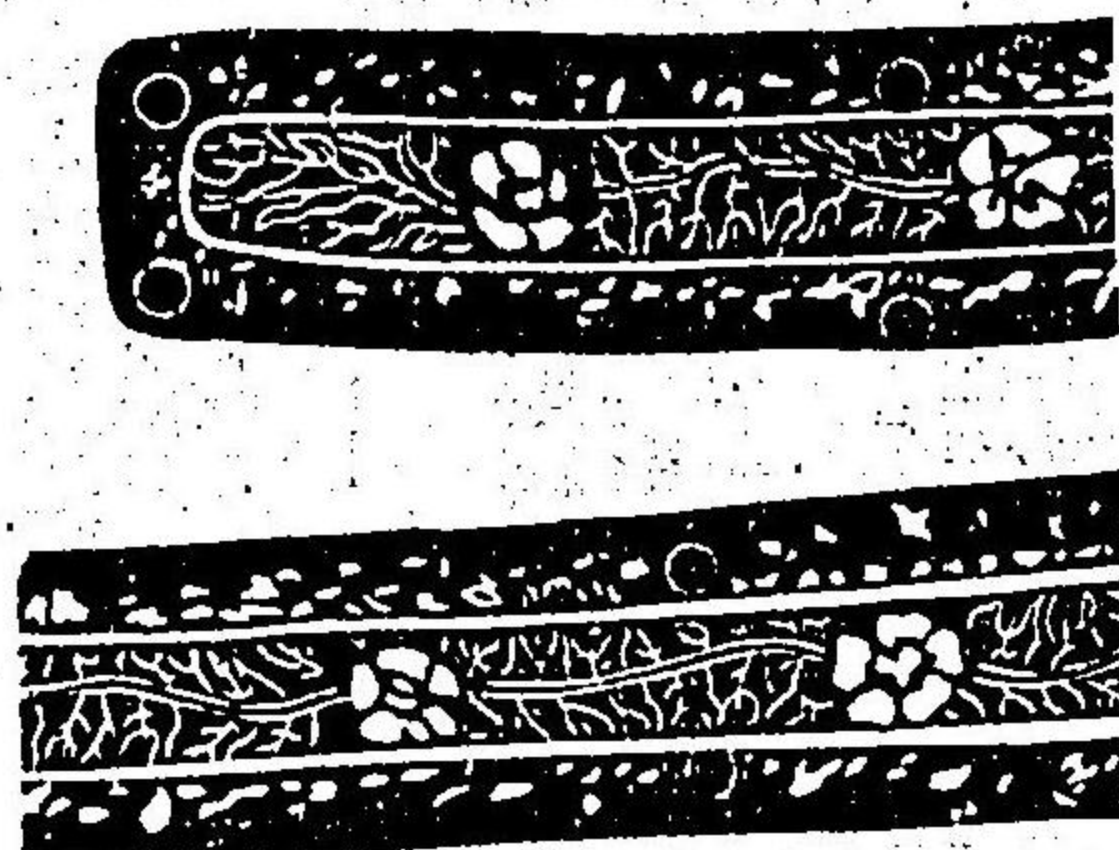

安藝國嚴島社藏小松内府甲冑圖

冑全圖

鞆五枚 腰卷高一寸二分 鉾十四本

二方白地板銀鑄垂同

高勝環紗失

惣テ金物金減金

鉢付鉾四

同威紺糸耳糸紺白鷹

羽打畦目菱縫赤草

同伏組紫白黒

同小縁赤草

鉢黒漆

同小札草

響音穴左右一ツ穴

小札鉢付板廻リ二尺五分小札

六十二枚

菱板廻一尺九寸二分

小札五十五枚



龜平小札

長二寸二分

廣一寸

忍緒付穴三
忍緒紛失

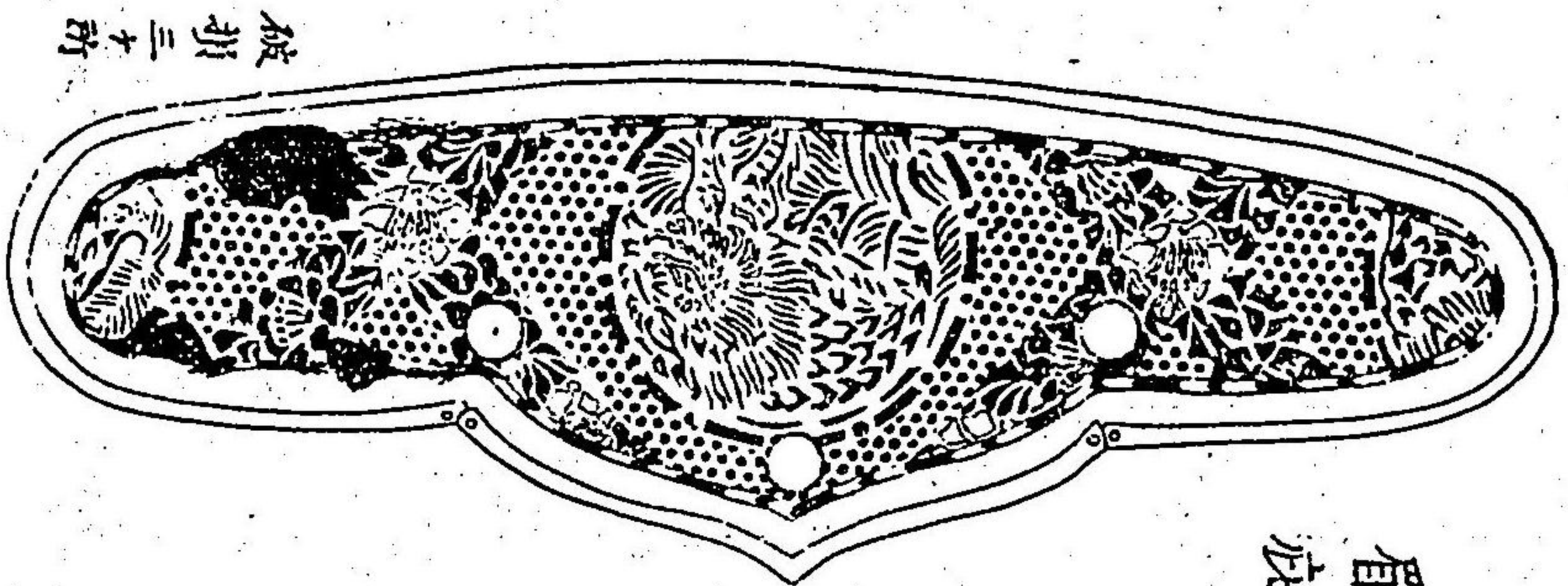

破損三十寸

眉虎

翠何毛白地藍火
双鈞、地回燃

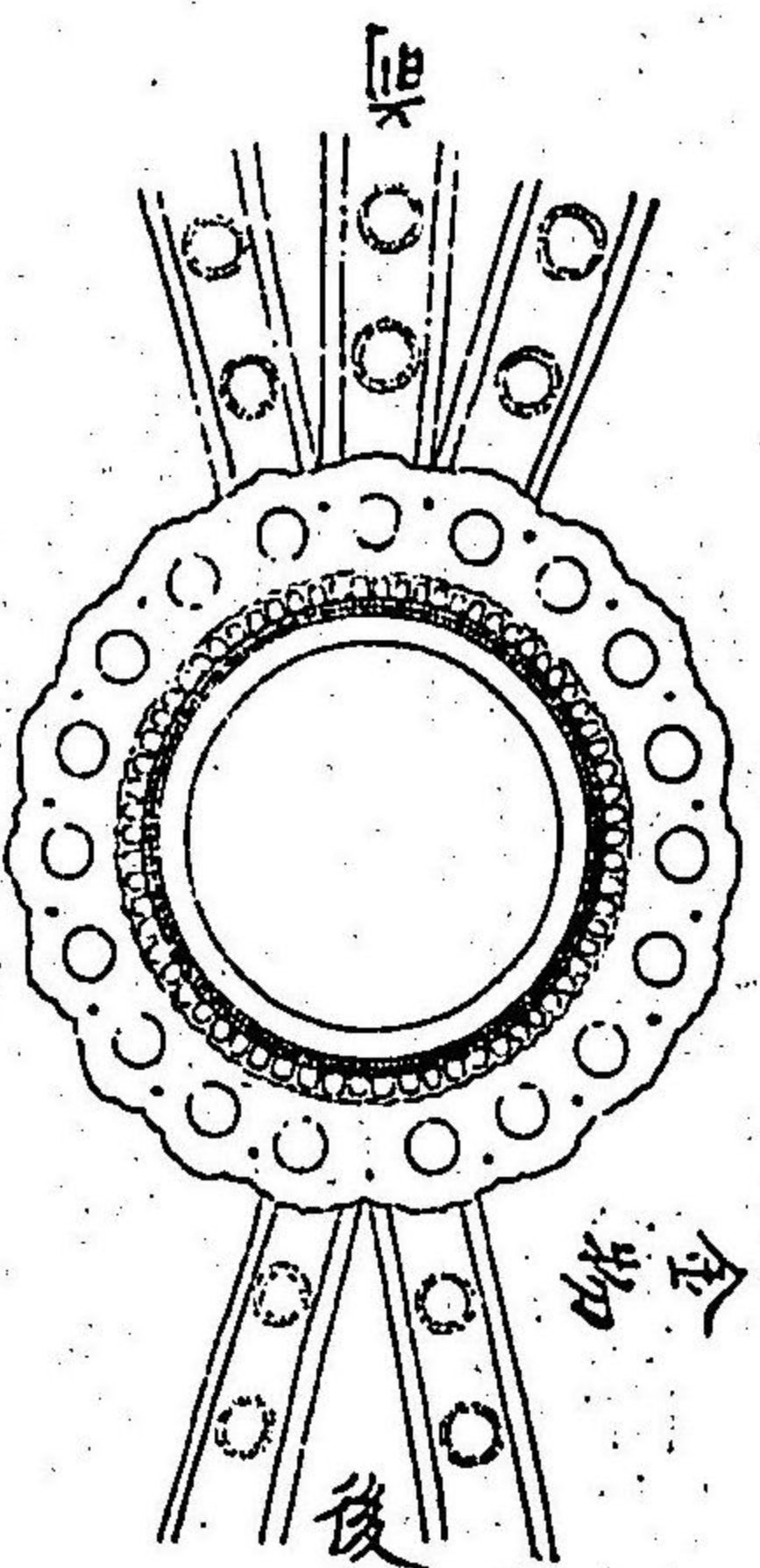

天空金物

後

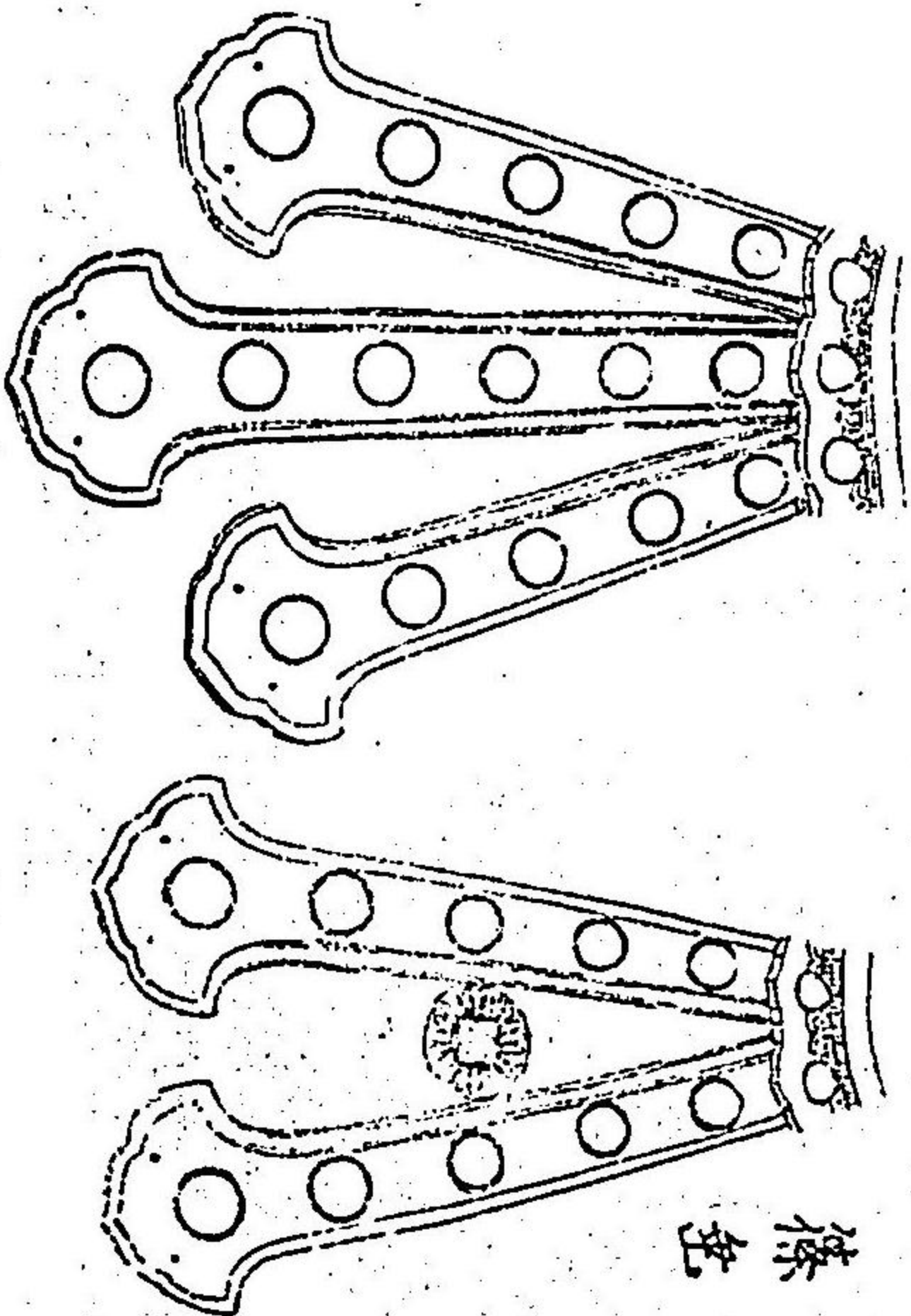

襟垂

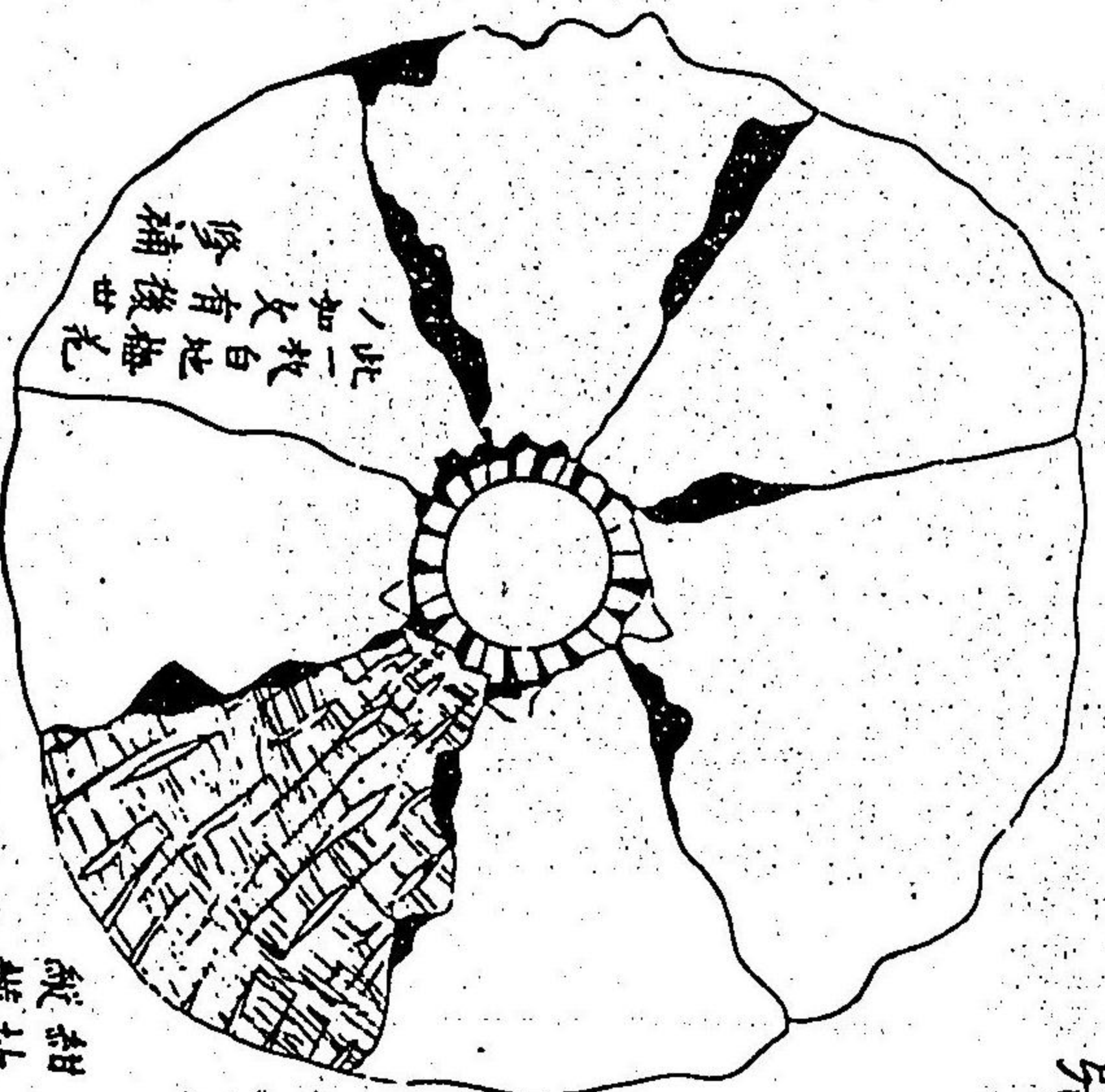

此一枚白地藍花
ノ如又有後世
修補

紺地如圖
縦横文了ノ
又紅白

由更張縮圖 膠ノ如モノニ張付

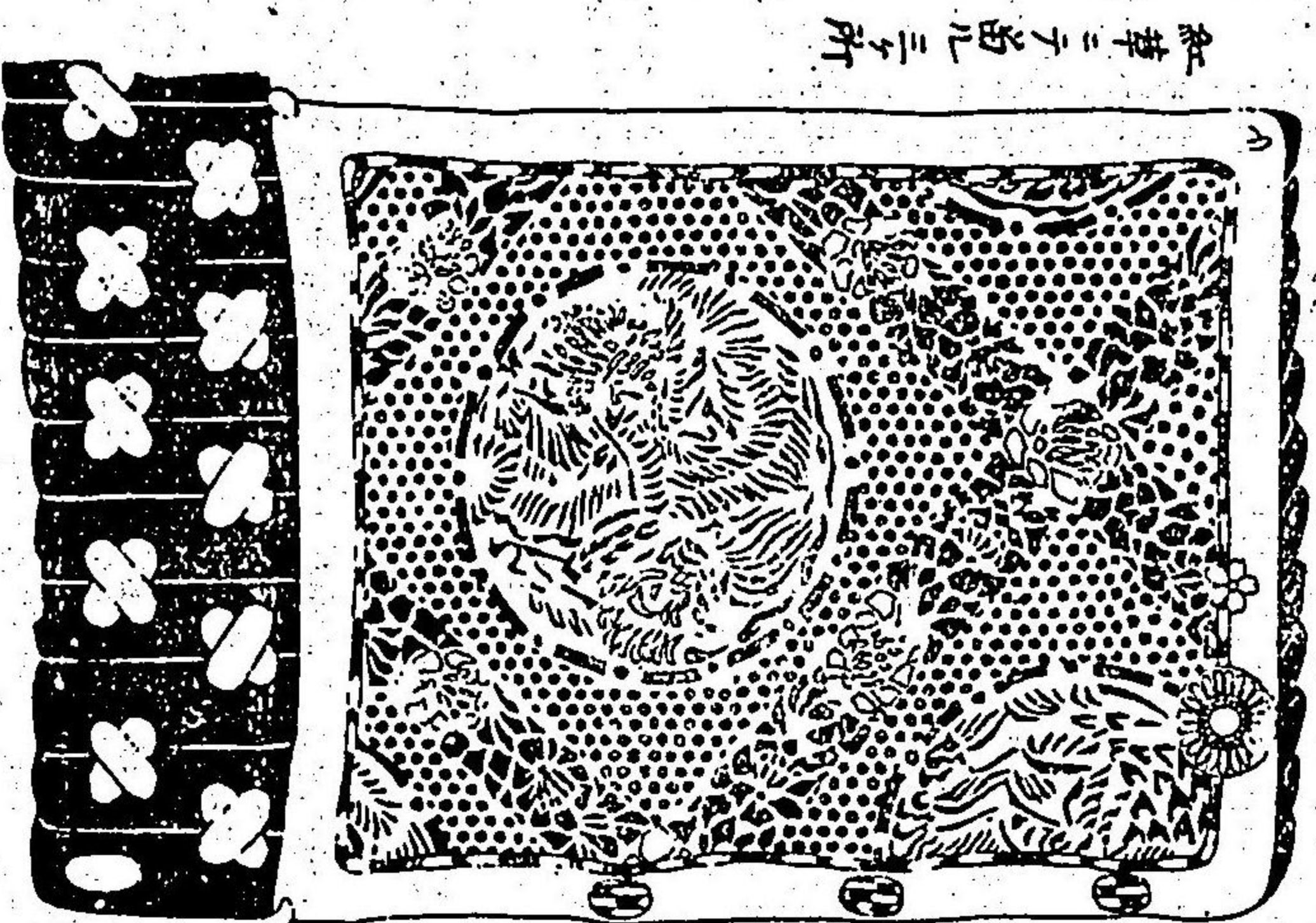

紅草ニテ出ルニ所

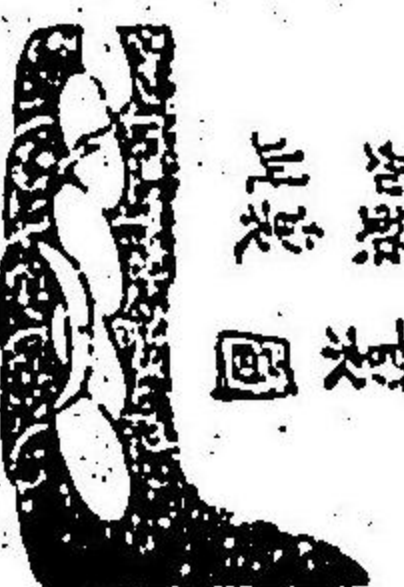

如鉞
製圖

吹返
一木櫛
鉞

袖裏

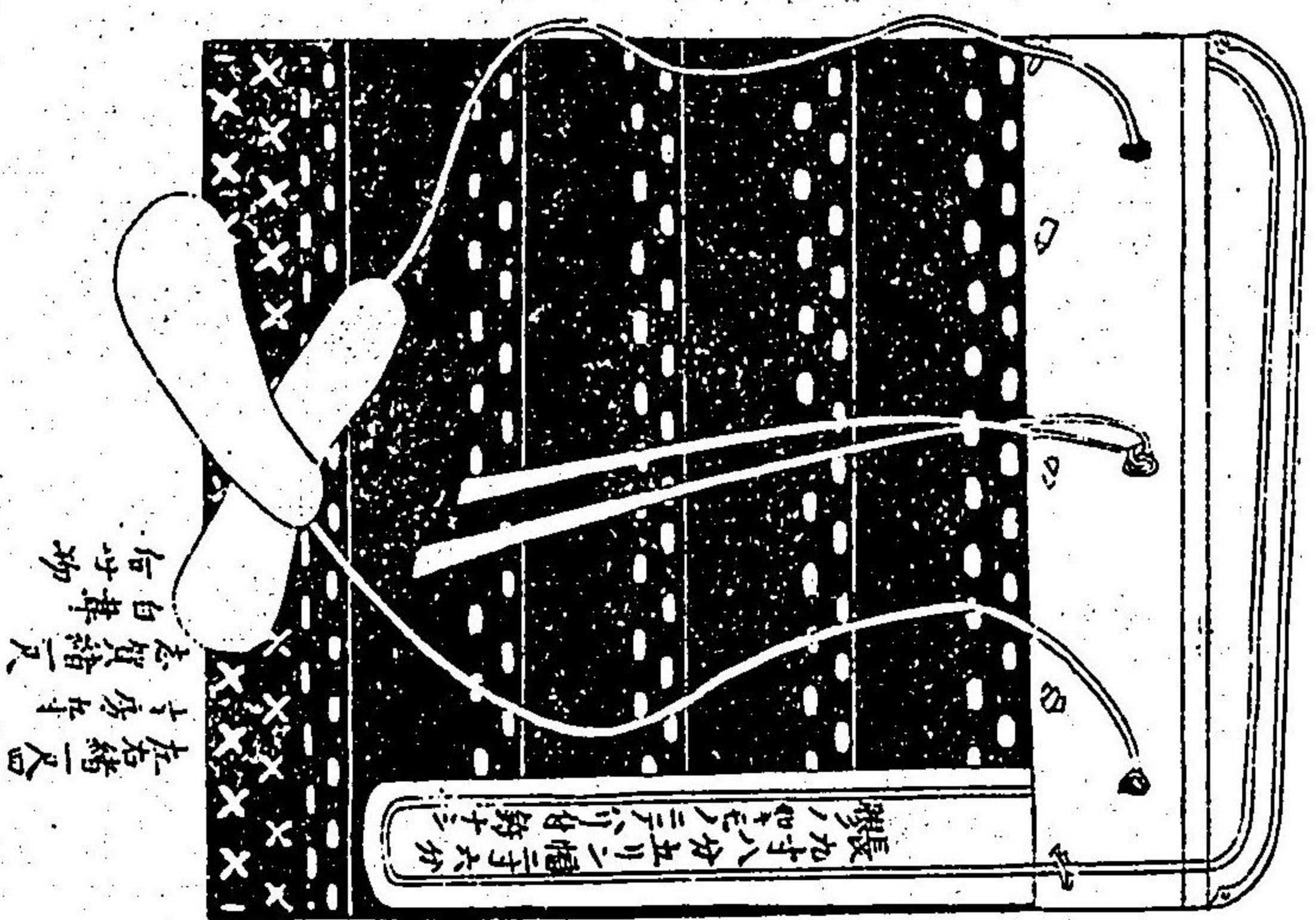

蓮手摺加三有之

一尺七寸八分 蓮手摺及入香 白草物

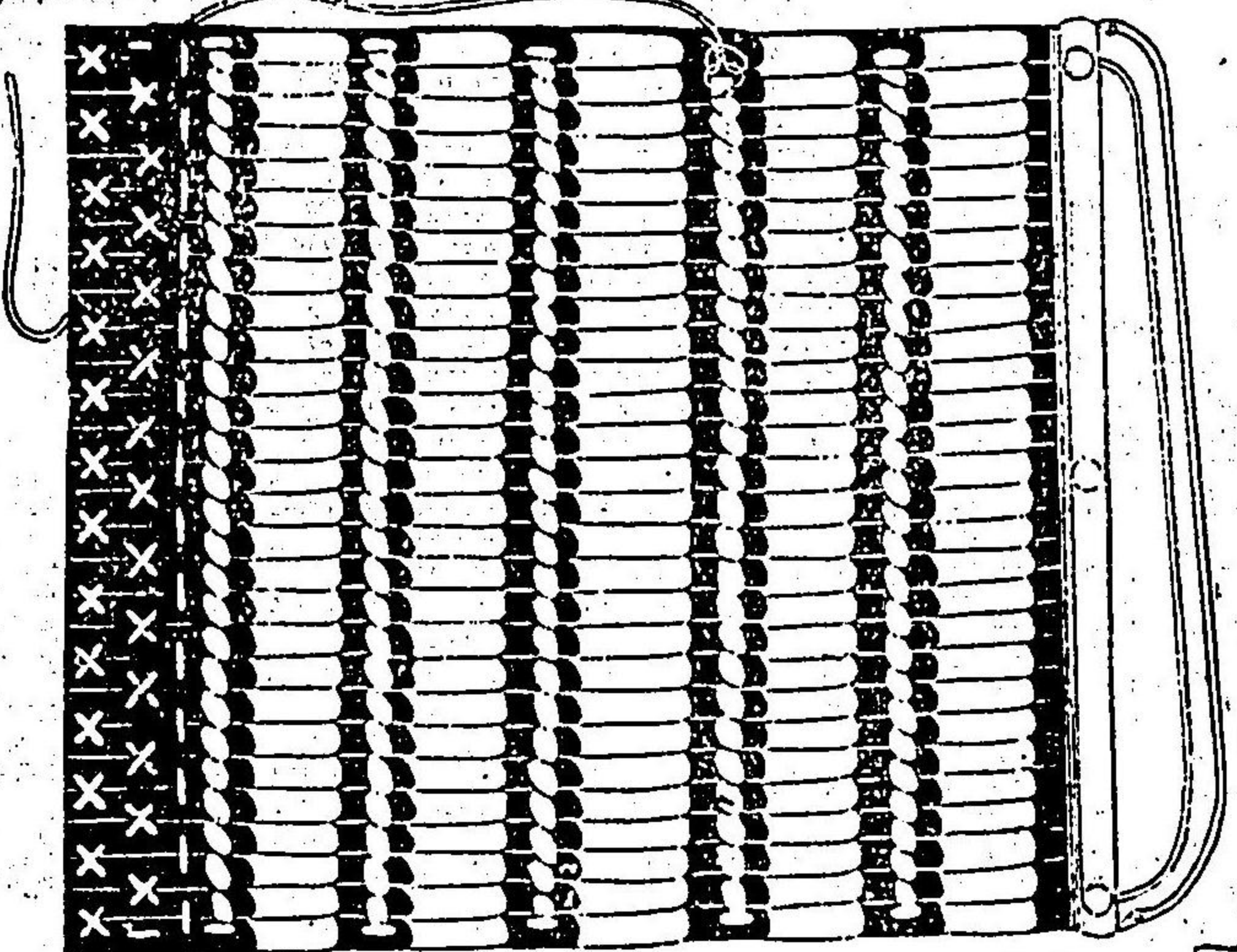

袖全圖 左袖同

水引紐 白
板厚 品草前
板厚 品草前
板厚 品草前

厚二分
札長寸

袖冠板

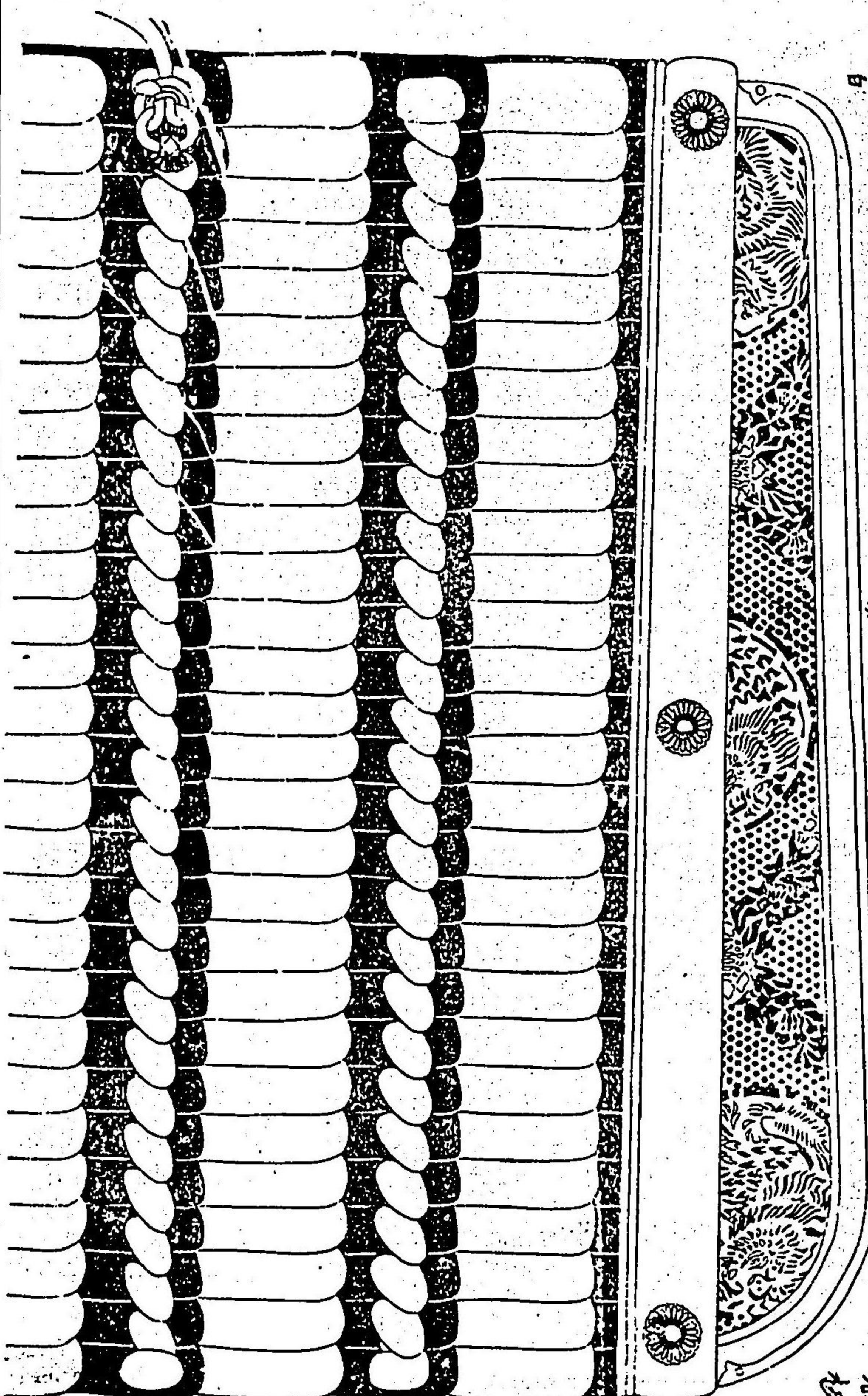

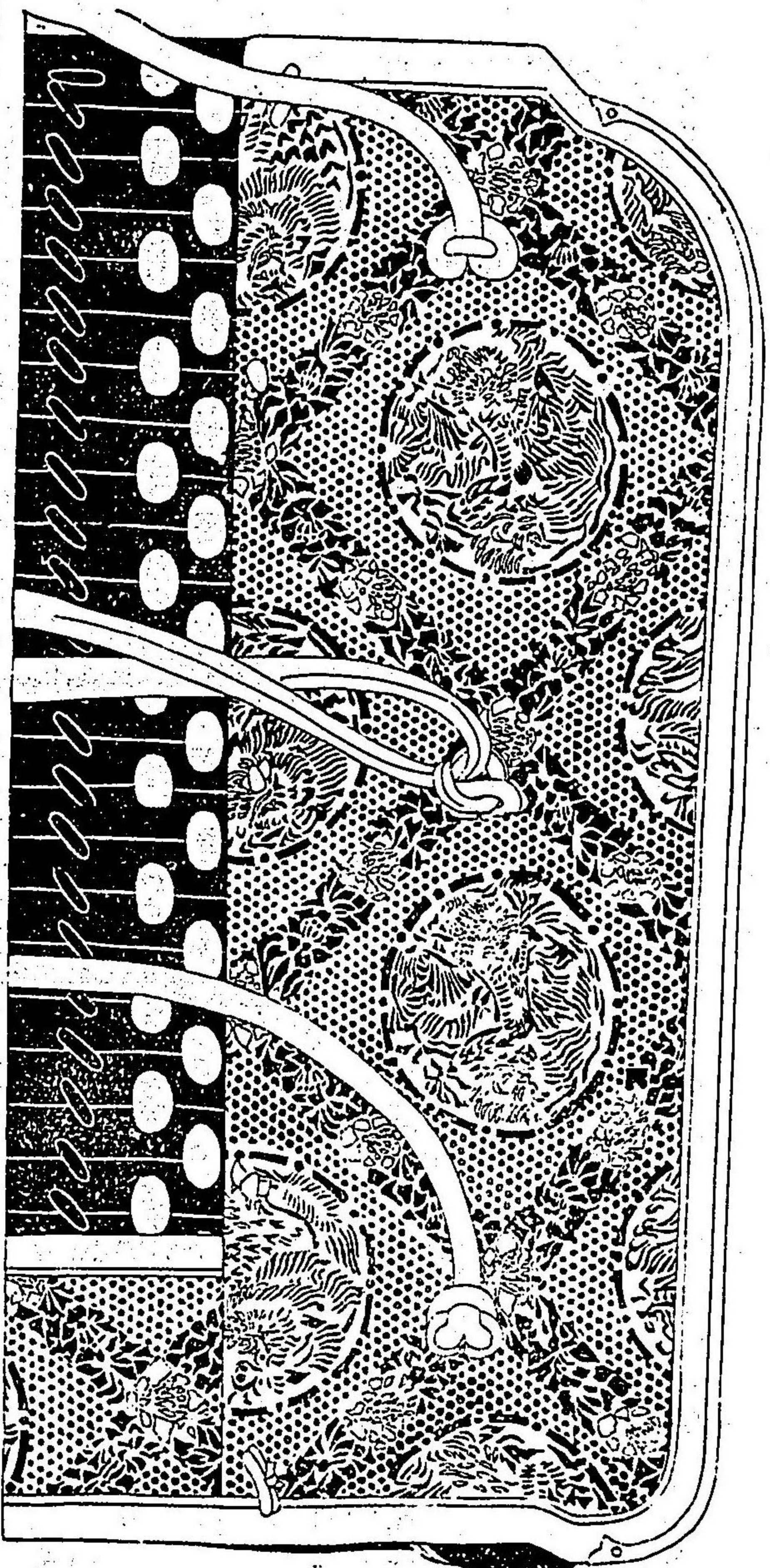

袖敷

左七緒 雄唐打
中央緒 白草
後世修補

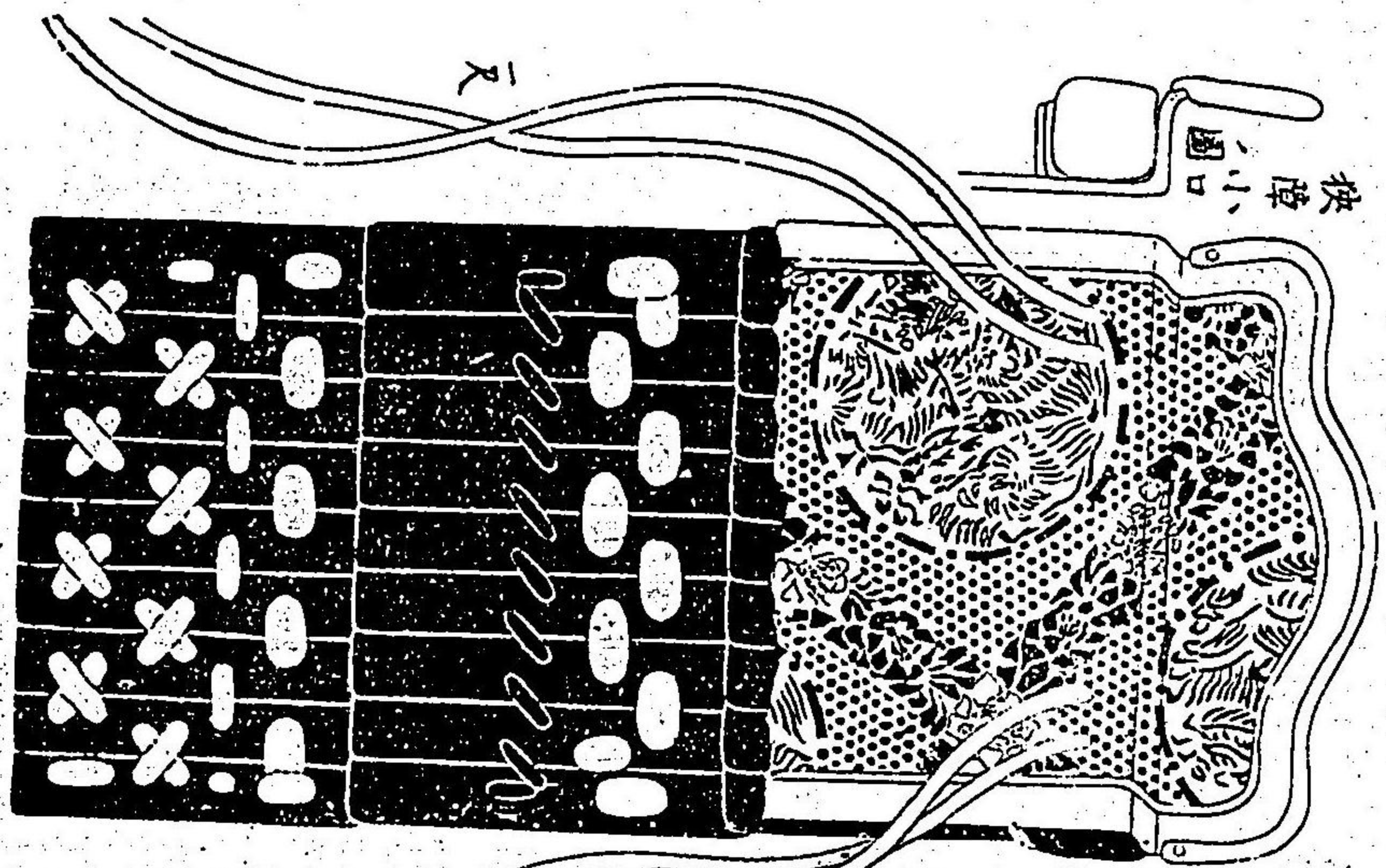

毡打六寸

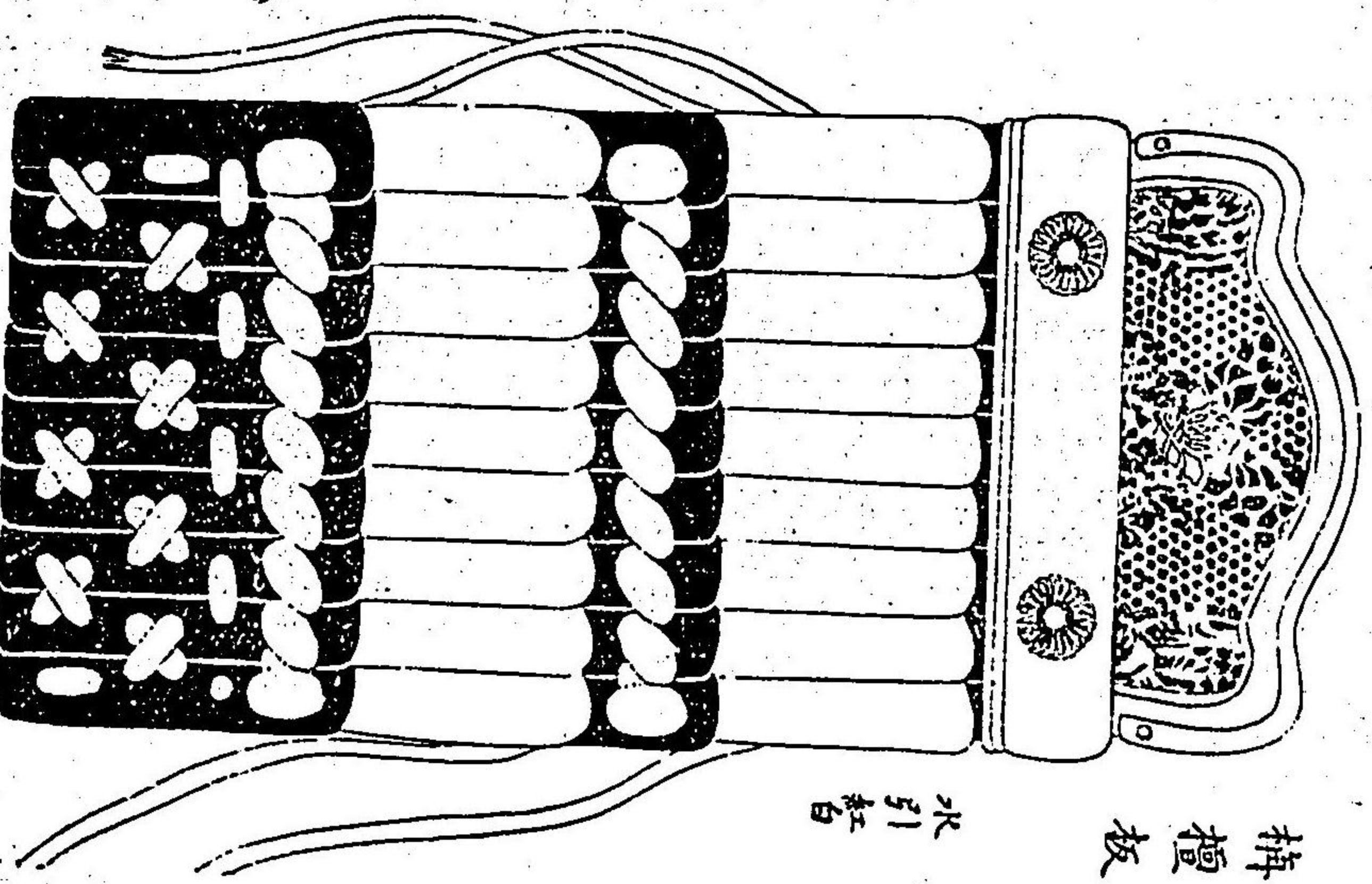

梅檀板
水引紅白

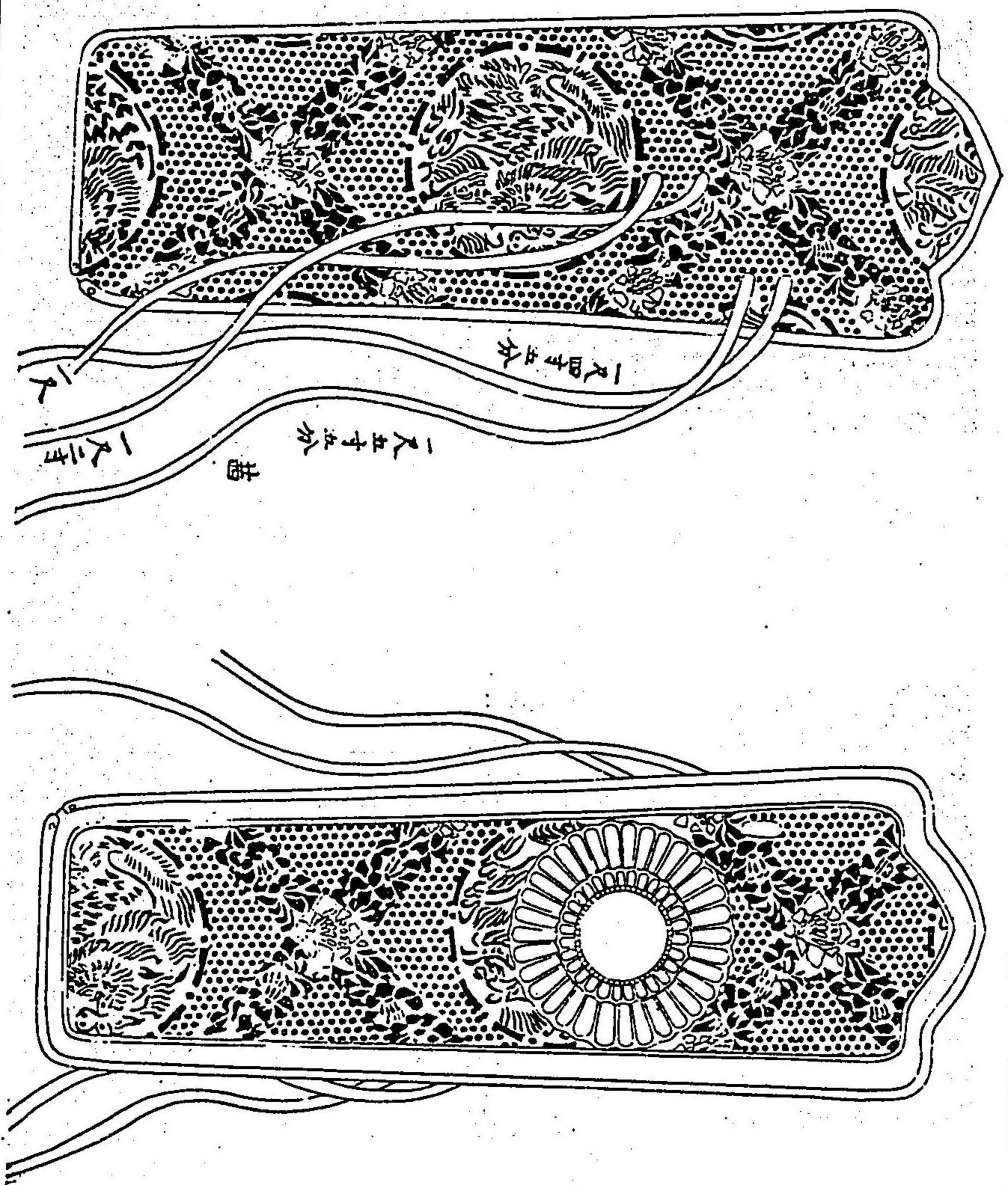

燭尾板

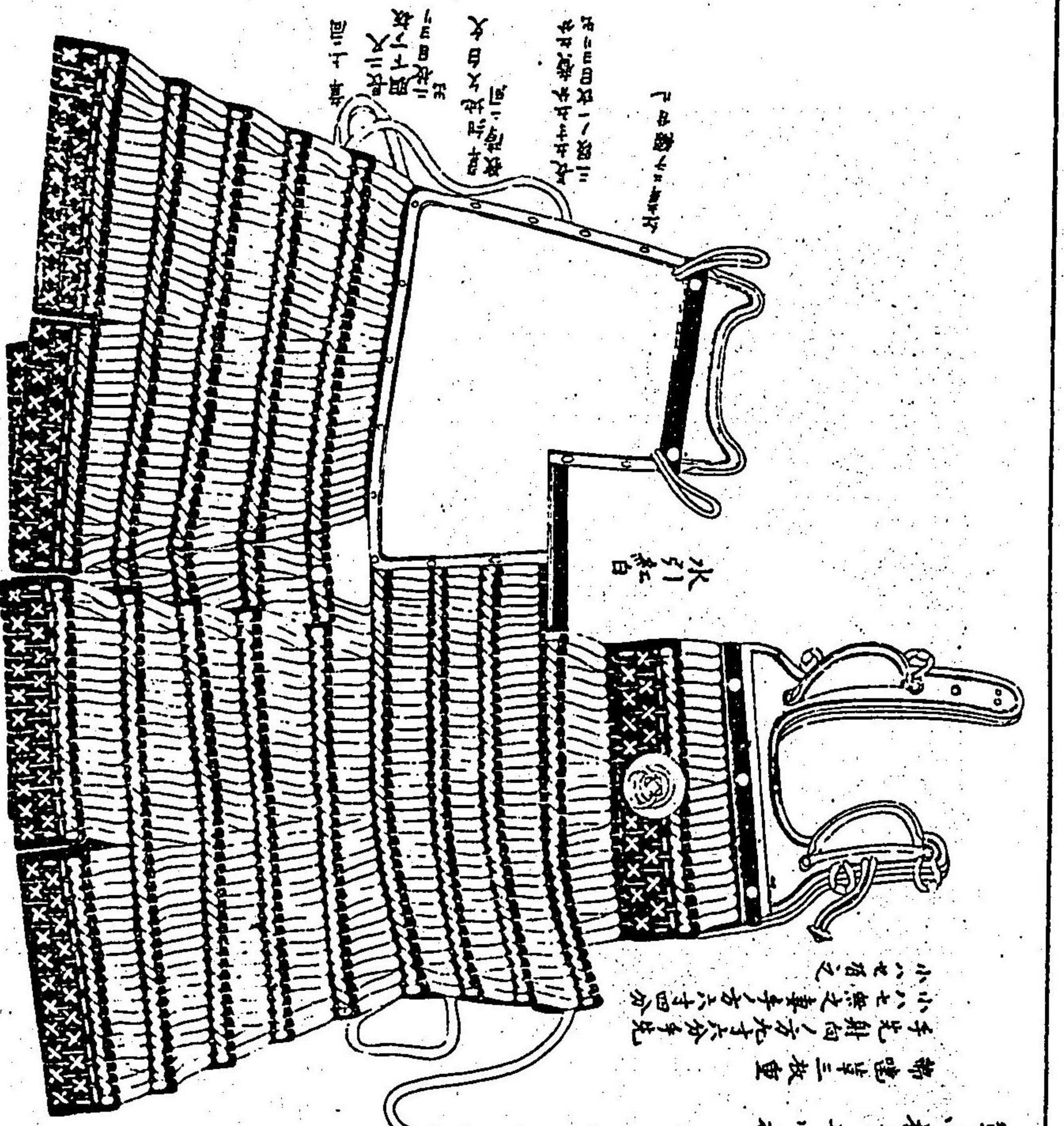

此長二寸五分廣一寸分
 前射向鐵葦一枚交外不發
 帶鐵葦三枚重
 手先射向一方九寸六分手先
 小七寸無之葦手方六寸四分
 小七寸之
 帶鐵葦三枚重
 手先射向一方九寸六分手先
 小七寸無之葦手方六寸四分
 小七寸之

胴全圖

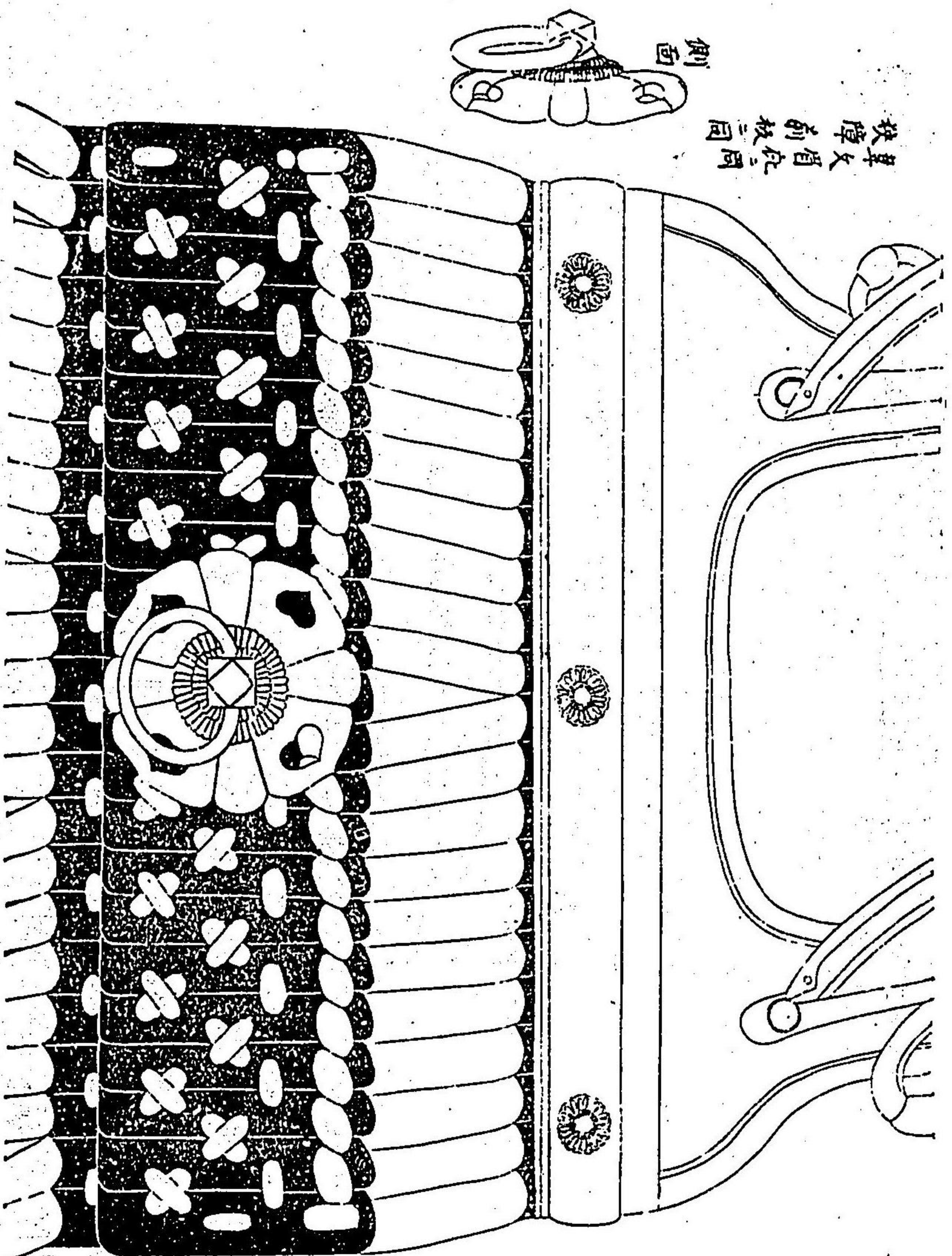

身大甲冑此圖
後牌前板同



後圖

莫縫赤草 曠日雄系後世修補

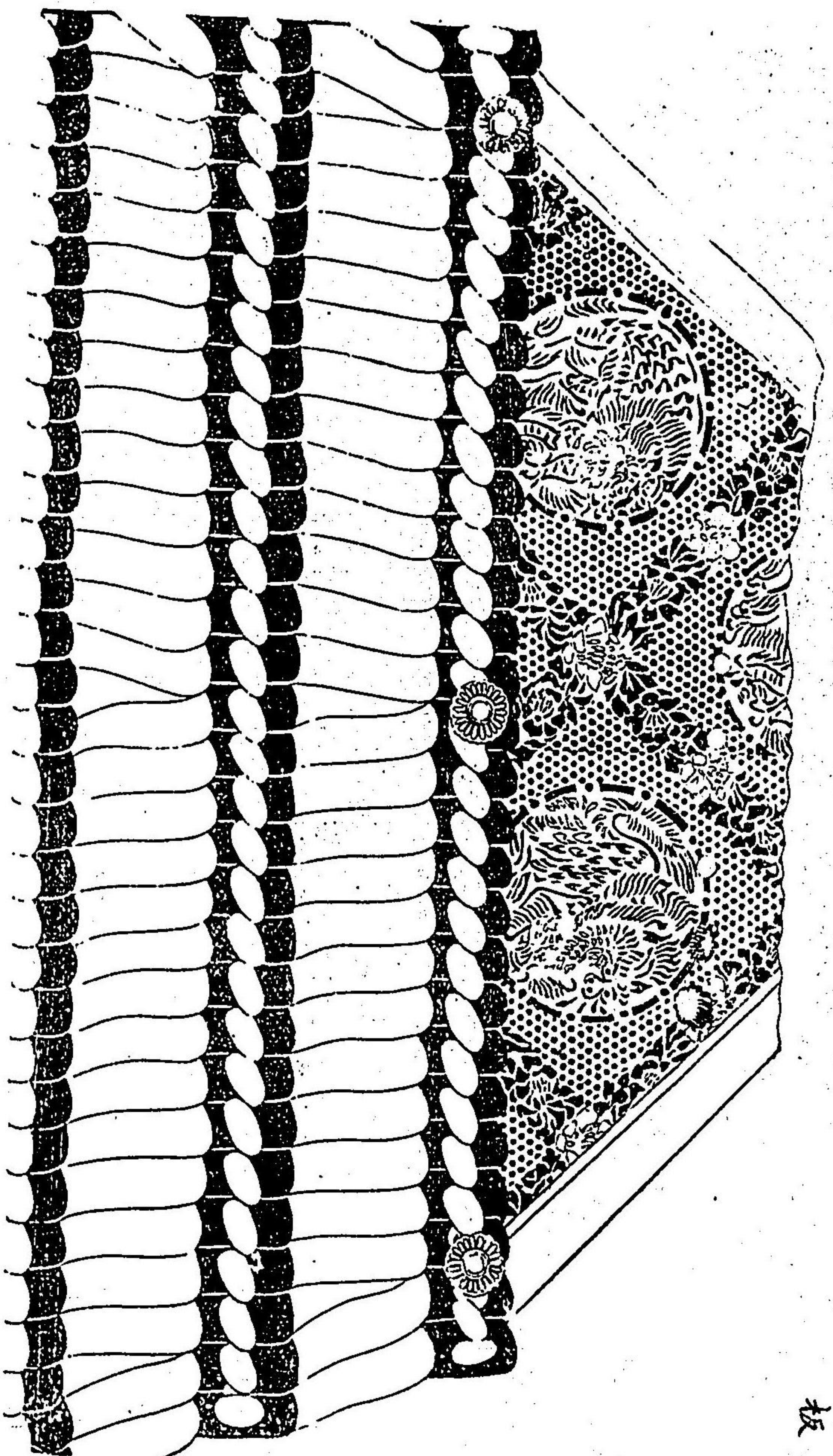

大 刀掛板