

Handy Man's Workshop and Laboratory



SCIENTIFIC AMERICAN
SERIES

THE GETTY CENTER LIBRARY



Why ask for the moon
When we have the stars?

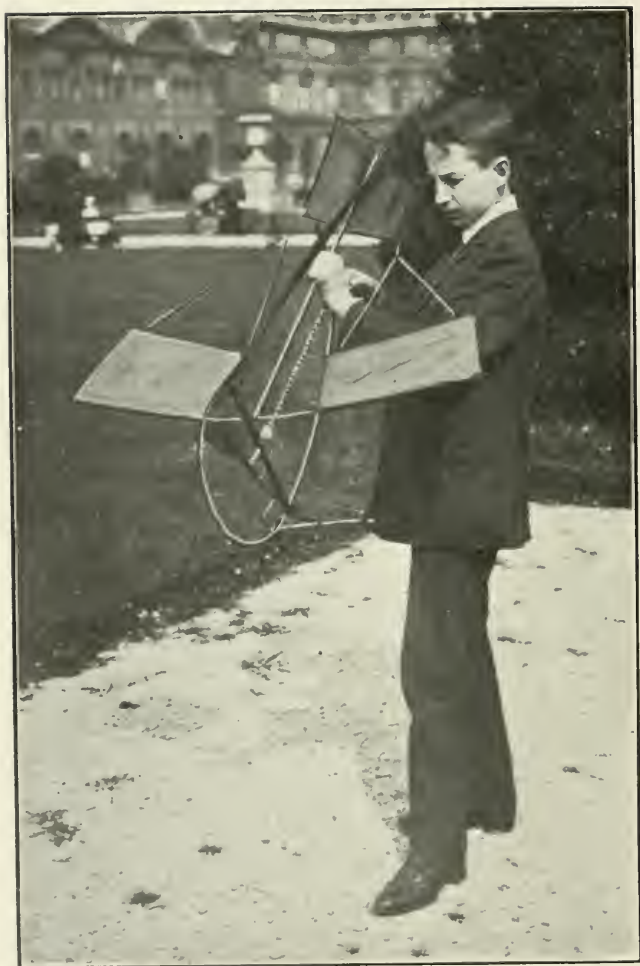

A monoplane flying machine ready for flight. (See page 438)

Handy Man's Workshop and Laboratory

COMPILED AND EDITED

BY

A. RUSSELL BOND

370 ILLUSTRATIONS

NEW YORK

MUNN & CO., Inc.

1910

2015
75
165
63
175

Copyright 1909, by Munn & Co., Inc.

All Rights Reserved.

The right of translation in all languages is reserved including
the Scandinavian.

Entered at Stationer's Hall,
London, England, 1909.

MACGOWAN & SLIPPER, Printers
30 Beckman St.
New York, U. S. A.

PREFACE

EVERY practical mechanic, whether amateur or professional, has been confronted at one time or another with unexpected situations calling for the exercise of considerable ingenuity. The resourceful man who has met an issue of this sort successfully seldom if ever is averse to making public his method of procedure. After all, he has little to gain by keeping the matter to himself and, appreciating the advice of other practical men in the same line of work, he is only too glad to contribute his own suggestions to the general fund of information.

About a year ago, it was decided to open a department in the *Scientific American* devoted to the interests of the handy man. There was an almost immediate response. Hundreds of valuable suggestions poured in from every part of this country and from abroad as well. Not only amateur mechanics, but professional men also were eager to recount their experiences in emergencies and offer useful bits of information, ingenious ideas, wrinkles or "kinks" as they are called. Aside from these, many valuable contributions came from men in other walks of life—resourceful men, who showed their aptness at doing things about the house, in the garden, on the farm. The electrician and the man in the physics and chemical laboratory furnished another tributary to the flood of ideas. Automobiles,

motor cycles, motor boats and the like frequently call for a display of ingenuity among a class of men who otherwise would never touch a tool. These also contributed a large share of the suggestions that poured in upon us. It was apparent from the outset that the Handy Man's Workshop Department in the *Scientific American* would be utterly inadequate for so large a volume of material; but rather than reject any really useful ideas for lack of space, we have collected the worthier suggestions as far as we could judge of their merit, and present them in the following pages.

A. RUSSELL BOND

New York, October, 1909

CONTENTS

CHAPTER I.

FITTING UP A WORKSHOP.....	PAGE 1-63
----------------------------	--------------

Building the Shop. The Workbench. A Solid Joint for the Workbench. A Joint that Can be Tightened. Bench Hook. A Combination Planing and Shooting Board. A Corner Cabinet. A Shoulder Chest. Desk or Drawing Table. The Grindstone. Artificial Grindstone. A Simple Foot-Power Grinder. The Lathe. The Scroll-Saw. A Combined Scroll-Saw, Tool Grinder, Router, and Drill Press. Scroll-Saw Guide. The Home-made Drill Press. Miter Box. Two Handy Clamps. A Carpenter's Clamp. A Quick Clamp. The Saw Clamp. An Improved Saw Clamp. Home-made Saw Filing Vise. The Saw Buck. Trestles, Horses, or Stools. A Roller Jack. A Steam Box. Handy Planing Dog.

CHAPTER II.

SHOP KINKS.....	64-106
-----------------	--------

The Clothespin on the Handy Man's Workbench. A Simple Method of Constructing a Handle. Convenient Holder for Sandpaper. How to File Round Work. Vise for Polished Pipe. Thread Cutting Without a Die. How to Wind a Spaced Coil Spring. Another Method of Making a Coil Spring. Home-made Spring Winder. Substitute for Rod Threader. How to Make a Screw and Nut Without the Aid of a Screw-Cutting Lathe. Substitutes for a Pipe Wrench. An Improvised Pipe Vise. An Emergency Pipe Valve. A Boiler Maker's Tool Bag. A Strong Home-made Turnbuckle. A Universal Joint of Simple Design. A Self-Locking Dovetail Joint. To Replace a Broken Screw in Soft Metal. The Driving of a Nail. To Prevent the Nail from Splitting the Wood. Remedy for Loose Wood Screws. Weatherboard Gage. A Ladder Extension Leg. A Painter's Platform Bracket. Paper Hanger's Adjustable Templet. A Good Substitute for Leather Belting. Gage for

	PAGE
Augers. Holder for Broken Shank Drills. Simple Drill Clearance. Simple Driver for Small Drills. A Guide for Drilling Horizontal Holes. Drilling Holes in Marbles. A Handy Tap Wrench. An Emergency Reamer. How to Drill Through Brick and Soft Stone. The Handy Man's Gage. Grinder and Hold for Small Tools. Device for Punching Holes in Saw Blades, Clock Springs, etc. Device for Sawing Holes in Metal. Device for Finding Centers of Round Work. Handy Method of Finding the Center of a Shaft. How to Support a Shaft When Babbitting. Old Glue Pot as a Metal Pot and Ladle. A Home-made Micrometer. An Improved Dowel Plate. The Turning of a Ball.	

CHAPTER III.

THE SOLDERING OF METALS AND THE PREPARATION OF SOLDERS AND SOLDERING AGENTS.....	107-155
---	---------

Soldering Apparatus. A Heater for Soldering Irons. Hints on Soldering. Home-made Gas Soldering Iron Made of Pipe Fittings. Home-made Blowpipe. Formulas for Solders. Classification of Solders. Soft Solders. Hard Solders. Silver Solders. Gold Solders. Aluminium Solders. How to Solder Aluminium.

CHAPTER IV.

THE HANDY MAN IN THE FACTORY.....	156-177
-----------------------------------	---------

Milling Attachment for the Lathe. Cutting a Groove of 42-inch Pitch on a 1½-inch Shaft. Cutting a Cam Groove with a Lathe. Improved Lathe Chuck. Correct Shape for Lathe Dog. Accurately Setting the Slide Rest for Turning Parallel Work. A Portable Polishing Lathe. Holder for Grinders. Cutting Keyways on a Die Sinker. Screw Slotting Attachment for Lathes. Micrometer Attachment for the Milling Machine. Crankpin Turning Device. Boring Cylinder Bushings for Locomotives. Fans on Machine Tools. A Muffler for Gas Engines. Automatic Lubricating Cup. A Hydraulic Test for the Boiler. Method of Patching a Boiler. Straightening Buckled Castings. Repairing Railroad Picks.

CHAPTER V.

THE HANDY MAN'S EXPERIMENTAL LABORATORY.....178-229

Chemical Flasks from Electric Light Globes. Stopcock of Glass Tubing. Starting Device for Siphons. How to Obtain Fresh Water from Sea Water. An Electrically Controlled Gas Regulator. A Home-made Barometer. Scale for Barometers. A Home-made Air Thermometer. How to Make an Electrical Anemometer. Gyroscope Made from a Bicycle. The Elastic Pendulum. Cutting Wood with Paper. Chemical Puzzles. Some Experiments with Carbon Disulphide. Blue Roses. Home-made Chemical Perfume. Artificial Zincite. Novel Heat Motor. An Ornamental Heat Motor. Rotagons. A Home-made Seismograph.

CHAPTER VI.

THE HANDY MAN'S ELECTRICAL LABORATORY.....230-313

An Unbreakable Leyden Jar. A Substitute for Tinfoil in Leyden Jars. A Home-made Wimshurst Machine. How to Make an Oscillating Static Electric Motor. Electrostatic Illuminations: Interesting Experiments for the Induction Machine. Stratification in Vacuo: Its Production with the Influence Machine. A Simple Experiment in Static Electricity. How to Make a Simple Electric Engine. A Simple Medical Coil. An Easily Made Magneto Machine for Physiological Effects. Machine for Winding Coils. Storage Battery Without Chemicals. Handy Form of Voltaic Battery. How to Make a Simple Dry Battery. Restoring a Dry Battery. A Home-built Alternating-current Motor. Small Transformer for Bell Circuits. An Electrolytic Rectifier for Charging Ignition Batteries. Home-made Adjustable Socket for Tungsten Lamps. A Cheap Lamp Rheostat. Open-circuit Telegraph System. A Test for Telephones. Ways to Brace Poles for Private Telephone Lines. A Simple Wireless Telegraph Detector. An Electrolytic Detector. The Construction of a Magnetic Detector. Experiments with Alternating Current, Using a Small Direct-current Motor. An Electrical Paradox. Construction of a Selenium Cell.

CHAPTER VII.

THE HANDY MAN ABOUT THE HOUSE.....^{PAGE}314-368

A Novel Music Stand or Book Rest. A Tabouret Made from an Onion Crate. Home-made Metal Lamp Shade. Another Method of Making Metal Lamp Shades. Decorations from Paper Pulp. Hero's Fountain as a Table Ornament. Convenient Hanger for the Clothes Closet. An Improved Carpet Stretcher. Rag Carpet Needle. A Cheaply Constructed Fireless Cooker. An Electrical Fireless Cooker. A Home-made Heat-retaining Bottle. Iceless Refrigeration. Electric Coffee Pot. An Improvement for the Broiling Pan. Patch for Kitchen Boilers. How to Mend a Cast-iron Boiler. Mending Cast-iron Boilers, Radiators, and the Like. Gas Fire-lighting Apparatus. Replacing a Fire Pot. Let the Clock Open the Furnace Drafts. Milk Testing Without Apparatus. Simple Method of Pulling a Cork. Waterproof Matches. Unscrewing a Jar Top. An Improved Shoe Stretcher. How to Mend a Hammock. Mending a Cracked Bottle. A Tin Can Leader. Ejector Made Out of Pipe Fittings. Home-made Vacuum Cleaner. Anti-freezing Outside Faucet. The Hose Reel on a Hydrant. A Home-made Lawn Sprinkler. How to Mend Garden Hose. How to Repair a Leak in the Garden Hose. To Make Paper Flower Pots.

CHAPTER VIII.

THE HANDY SPORTSMAN.....369-433

A Portable Automobile House. How to Convert a Horse-drawn Buggy into a Motor Buggy for Less than \$300. Getting Home with a Weak Battery. The Handy Man's Spark Plug. Scraping Carbon from the Piston Heads. Cleaning the Spark Plug. Straightening an Automobile Axle. Taking Up the Engine Bearings. Temporary Repairs to Broken Springs. Putting on a New Clutch Leather. Relining the Brake Shoes. The Motorist's Accident Preventer. When a Lost Nut Cannot be Replaced. How to Construct and Operate a One-man Airship. How to Build a Chanute-type Glider. An Inexpensive Ice Yacht. How to Build a Scooter. A Simple Method of

	PAGE
Taking Spilings. Forging a Mast-head or Boom Ring. To Install a Motor in a Small Boat. Simple Support for Bicycle. Handy Method for Repairing a Punctured Tire. Bicycle Coasting Sled. Coasting Skates. Two Ways of Improving a Sled. Reducing the Range of a Rifle. Another Method of Reducing the Range of a Springfield Rifle.	

CHAPTER IX.

MODEL TOY FLYING MACHINES.....	434-455
A Simple Monoplane. Divided Monoplane. "Wright" Biplane. The Aeroplane Kite. A Novel Monoplane Model. "Diabolo" Flying Machine.	
INDEX	456-465
AUTHORS' INDEX.....	466-467

HANDY MAN'S WORKSHOP AND LABORATORY

CHAPTER I.

FITTING UP A WORKSHOP

BUILDING THE SHOP

The interest taken by a man or boy in a shop that he himself has built will amply repay the small outlay of the first cost.

Fig. 1 shows the inside view of a workshop good enough for any amateur, no matter what his station in life may be. The framework was put up by a first-class mechanic, but the furnishings are all home-made, such as even a boy will be able to construct. Such a shop as this is hardly necessary for the average young mechanic, the object of the sketch being more to show how a shop can be fitted up inside. The lathe, and also a jig saw, not shown, will be described later, as will also the bench, drawing table, and other accessories.

A shop about 9 feet by 12, inside dimensions, will be ample enough, and if it is made as an addition to the house, but three extra sides will be necessary, or if built in a corner, as is sometimes convenient, then but two extra sides will be needed.

The ground must be leveled, and prepared for the six piers, which can be of concrete, brickwork, or timber. If of timber, let them be 6 to 9 inches square by 2 feet long, buried in the ground about 18 inches. Holes should be dug of suitable depth and the stumps dropped in, care being taken to get them the proper distance apart, 9 feet by 12, out to out, so that the sides of the building, when erected, will be flush, and not have to be cut around the piers, or offset in an unworkmanlike manner. The first pier, can be permanently set by ramming broken bricks and earth into

the hole with a piece of heavy timber brought down on end. The remaining piers are leveled up from this one, by means of a builder's level.

Since it is a very important matter that these piers should be

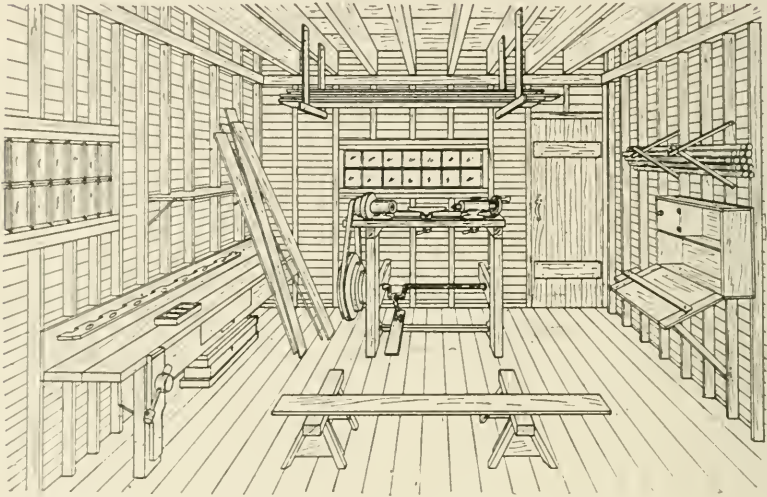

Fig. 1—A model workshop for the amateur

true and level with each other, it will be well to make a suitable straight-edge, or leveling board, for this purpose. This can be 12 or 16 feet in length, cut from a 1-inch board, and shaped as shown in Fig. 2. A hand-hole is formed in the center, at the

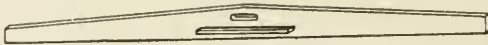

Fig. 2—A builder's level

top, and a small shelf, upon which is placed the spirit level, is nailed to one side, immediately below. The leveling edge must be planed very true, while the small shelf on the side must be made exactly parallel with it. Place the level upon the shelf,

and, holding the leveling board on the tops of each pair of piers successively, commencing with the permanent one, level them all by raising or lowering them in their respective holes, when they should be permanently set, as was the first.

The wall plates or bottom framing are made from 4 x 6 timber, half jointed at each corner, and secured to each pier with tennenny nails driven in from either side. The four corner piers being 9 x 12 feet out to out, one pair of the 4 x 6 timbers will be 12 feet in length, and the other 9 feet. The framework must form a perfect right angle at each pier, which can be tested by means of the carpenter's square or laid out in the following manner:

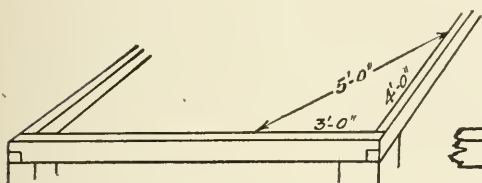

Fig. 3—Laying out a square corner

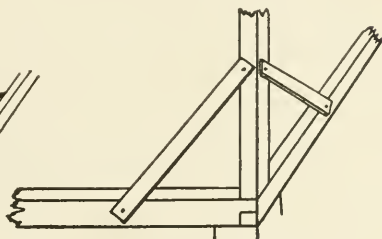

Fig. 4—Temporary bracing for corner posts

Along the inside edge of the framework lay off a line 3 feet in length on one timber and 4 feet on the other, when the two timbers must be closed, or opened, until the distance between these two points measures exactly 5 feet, as shown in Fig. 3.

The posts, or studding as they are sometimes called, are made from 3 x 4-inch timbers. Two are cut 10 feet 6 inches in length, and three are made 7 feet 6 inches long. The ends are cut true and square, to get a good bearing, when the posts are set up. The rear posts can be secured to the side of the house, after being trued with a plumb bob, or level, and can be secured to the bottom plate or framing by toe-nailing; but the two front corner posts, after being erected plumb, and secured to the framing, must be held temporarily, in the manner illustrated in Fig. 4. The top

plates and rails are next put up. Make a half joint at the front, and nail the other ends to the rear posts with nails driven through either side. The other door-post is erected, then the intermediate rails and the door lintel. Rails and door lintel are 2 x 3 inches.

The rafters are made of 2 x 4-inch timber, notched where they rest upon the plates, which are 2 inches by 3. One rafter can be cut to the proper length and notched, using it for a templet, or as

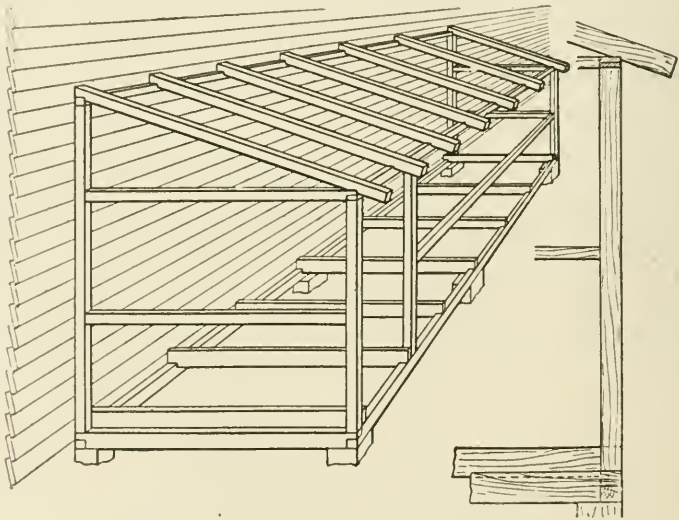

Fig. 5—Setting up the frame of the shop

a guide for cutting the others. The two end rafters should be secured to the plates first, by driving in tenpenny nails through the sides, as in the case of the floor joists, then the others may be evenly spaced from end to end, about 2 feet apart.

The framework of the building is now complete, as shown in Fig. 5. A detail of construction is shown at the right. Rough boards, with a space between them of about one inch, are laid across the joists for the roof, and secured with eightpenny nails. The sides can either be made of tongue-and-groove boards, or

ordinary boards like the roof, only built close, with narrow strips of wood nailed over the joints as in Fig. 6.

Space must be left in the sides for the windows and doorway; the latter should measure 2 feet 6 inches by 6 feet 6 inches. The

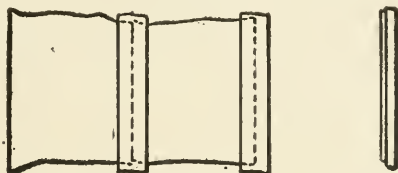

Fig. 6—Cracks in the siding covered by narrow strips

windows had better be double sliding, on three sides of the building, to get a good light. If 10 x 8 glass is used, the framework or sash will be about 2 feet $4\frac{3}{4}$ inches by 1 foot $11\frac{5}{8}$ inches high. The window openings in the sides of the building, therefore, should be 1 foot 11 inches high by 4 feet 8 inches long for a

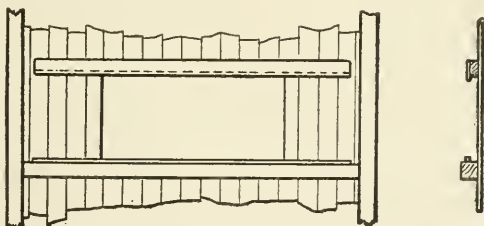

Fig. 7—A window opening, showing grooves for sash

double sash. They should be centrally located in the sides and front, the boards being cut flush with the top of the middle rails, to which they are nailed. The boards at the top of the opening are nailed to an inside strip, $2\frac{1}{2}$ by $1\frac{1}{4}$ inches, detailed in Fig. 7, which sketch also shows the grooves in which the sash moves. A tongue-and-groove connection should be made where the two sashes meet, or a strip of wood should be nailed on either, to overlap the other, and keep out the wind and rain.

The flooring, which can be made of ordinary boards or a cheaper grade of tongue-and-groove boards, planed on one side only, are cut to fit close up to the sides, and around the studding or posts, and nailed to the joists with eightpenny nails. The joists are 2 x 4, notched 1 inch, as shown.

It will be noticed that the first board of the sides, nearest the house, is notched all the way down, to fit up snugly against the weather boards. This is done by means of a pencil and a small stick, held as in Fig. 8. The stick is traced along the outline of the weather boarding, while the pencil, being held against the upright board of the shop, makes an exact copy of the outline, as a guide for the saw. Narrow boards, sometimes called plates,



Fig. 8—Tracing a profile of the weather boards

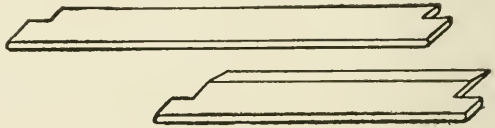

Fig. 9—Sills for the door and windows

are nailed all around the top of the sides, under the eaves of the roof, notching them out where the joists of the roof come through.

The door can be made of the same stuff as the sides, strengthened with battens as shown in Fig. 1. A diagonal batten can be put on also, letting it bear top and bottom against the horizontal battens, and taking care to let it slope in the right direction, the lower end being near the hinges. Hinges and a latch, also a draw-bolt, are all the furnishings necessary for the inside, and a padlock for the outside. A plain narrow frame can be put around the outside of the windows, and a sill made (Fig. 9) from 1-inch stuff, for the door and windows, will improve the appearance. A door-step can be made from the same stuff as the sides, or from 1-inch boards, nailed to the front of the shop, before the tread is put on. The ground should be made level, and a large stone, or bricks, put under the bearing edge.

The roof is covered with tar paper, which can be made of sheets of brown paper covered with pitch and sanded, or it can be purchased already prepared. Commence at the eaves, allowing enough to tuck under the eaves on both sides and in front. The next layers are allowed to lap over by about 2 inches, and the last one is tucked under the weather boarding, on the side of

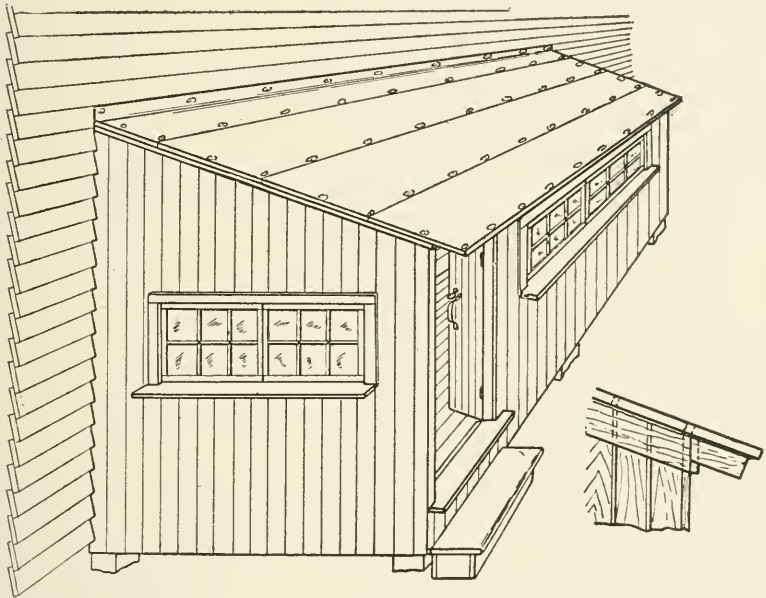

Fig. 10—Exterior view of the finished building

the house. Large-headed galvanized nails are used to hold the tar paper or felt covering to the roof; or barbed wire-nails with tin caps will do. Space them not less than 2 or 3 inches apart, all along the edges of the laps, and under the eaves of the roof. (See Fig. 10.)

The shop should be given two coats of paint on the outside to match the house or surrounding buildings. A small stove, either

oil, gas, or coal, will nicely heat the shop in cold weather, a chimney connection being made in the roof or one of the sides if a coal stove is used.—3*

THE WORKBENCH

The workbench shown in Fig. 1 is attached to the wall, thus saving time and labor in making it; but a stationary workbench is not always desirable, especially if there is no permanent shop for it. The standard size of a joiner's bench is 12 feet in length and 2 feet 9 inches in height and width. This size is altogether unnecessary for home purposes. From 8 to 9 feet in length, and

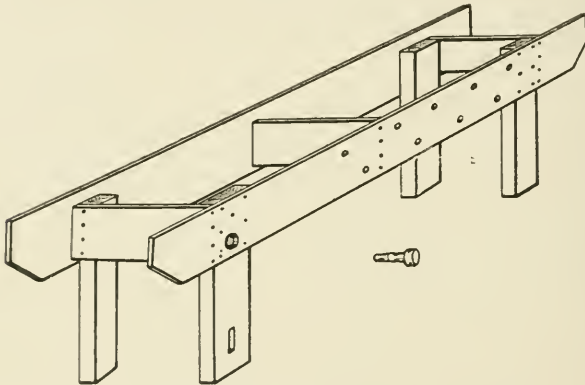

Fig. 11—The skeleton framework of the bench

about 32 inches high is a convenient size. Mechanics sometimes test the height by sitting on the front edge of the bench sideways, with one foot dangling over the side, which should just touch the floor.

If the planking and supports are made of yellow pine, a sound solid bench will be the result. In any case, the top front plank should be of this material, the rest can be of white pine or hemlock. The vise should be of oak, the screw being purchased at any hardware store for about fifty cents.

Referring to Fig. 11, three of the supports are made of 3 by

* Figures refer to authors' names. See Index of Authors at end of book.

4-inch timber, 30 inches high. The one at the vise is 3 inches by 6, of the same length. Care should be taken that the bearing surfaces are true, and the posts are set up level. The slotted hole, or mortise, at the bottom of the vise post, should be cut before the post is set up, but the round hole for the screw can be made when the bench is complete. The mortise is made by boring two $\frac{7}{8}$ -inch holes 2 inches apart, vertically, and cutting out the wood between with a flat chisel. The ends, top, and bottom can be left round, or may be squared up with the chisel, as illustrated.

Cut three short lengths of 1 by 10-inch boards, 23 inches long, and nail two of them across the tops of the posts or supports as shown. Set them up on end, and nail the front board, or apron, which is 9 feet in length, to the forward posts, spacing the latter 1 foot from each end. The top edges of the front board and the three cross pieces are brought up exactly level with each other, but the back board, which is 12 inches deep, is nailed to the posts, with the top edge 2 inches above. The top of the bench consists of two planks, 12 inches wide by 9 feet in length. The front plank is 2 inches in thickness, and should bear evenly along the top edge of the front board, or apron, which supports it. The board at the back is only 1 inch thick, and like the rest of the bench, can be made of cheaper and lighter timber. With the exception of the tool rack, the bench can be put together with eightpenny or $2\frac{1}{2}$ -inch wire nails. The 2-inch thick plank should be nailed down with ten-penny flooring nails, or nails having finished heads, which must be driven in below the surface with a nail set or punch.

The tool rack can be made from $\frac{1}{2}$ -inch stuff, about 2 inches wide, running the full length of the bench, or cut off within a foot or so of each end. Partitions can be made of the same wood, spaced from 1 to 3 inches apart, to suit various sized tools. A strip of wood nailed across the top edge of the back, and furnished with a number of different-sized, bored holes, will answer the purpose just as well.

While there are many different kinds of vises on the market, it is safe to say the old style, as shown in Fig. 12, is very gen-

erally used, and it has the advantage of being easily rigged up and inexpensive. Procure a piece of oak, $1\frac{1}{2}$ inches thick, $7\frac{1}{2}$ inches wide, and about 30 inches in length, for the movable jaw

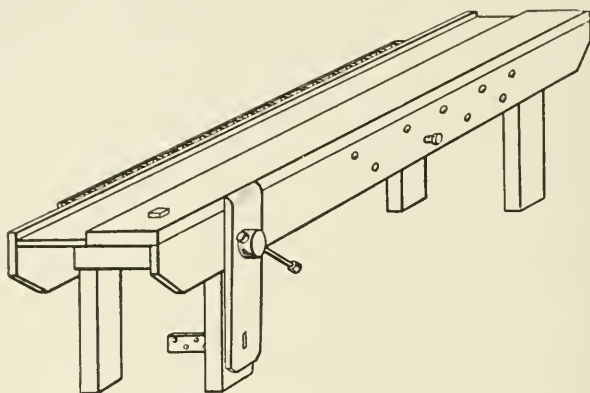

Fig. 12—The bench complete with vise and tool rack

of the vise. A hole for the screw is bored in the middle, 9 inches from the top, and a mortise for the guide is made in the lower end, after being marked off from the one in the 3 by 6-inch post of the bench. Corresponding holes for the vise screw are to be

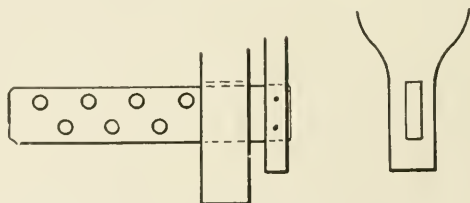

Fig. 13—Details of the heel of the vise

bored through the apron and the post, a trifle larger than the screw. The guide is made from hard wood, 18 inches in length, cut to fit easily the hole in the bench post, but having a driving fit in the vise jaw, to which it is secured by toe-nailing. Sometimes the jaw of the vise is tapered at the lower end, as shown

in the detail view, Fig. 13, when the guide can be secured by driving nails through the sides. The guide is furnished with holes evenly spaced, as shown, and a peg is provided, similar to the one shown in Fig. 11, for the apron or front board of the bench.

The apron is provided with holes and a peg, to rest the free end of a long plank upon, when being worked in the vise. A suitable bench stop is put in the planing board of the workbench. Various designs are on the market, which can be easily attached, but a very good one can be made by using a 2 by 2-inch piece of oak, a foot in length. A hole is cut about 9 inches from the end of the bench, and the stop must have a driving fit, being raised or lowered by hitting it with a hammer. This is much better than the metal stops, since there is no possible chance of injuring the tools. The nut of the vise screw is secured to the inside face of the 3-inch by 6-inch post, to prevent its revolving when adjusting the vise.

When the vise is set up, the top can be planed true and level with the working face of the bench, slightly rounding off the corners. The 2-inch plank should be planed up true, and no work done upon it which will break up the surface. Any rough work should be done on a board placed on top of the bench.

The workbench is now complete. It is a convenient size, and can be easily taken out through an ordinary door, and when it comes to moving, there will be no necessity of leaving it behind, or knocking it to pieces to get it out of the shop.—3

A SOLID JOINT FOR THE WORKBENCH

When constructing the bench for the Handy Man's Workshop, and it is desired to use the old but efficient screw-and-heel pattern woodworker's vise, the question of a suitable joint for the upper end of the front leg must be considered. The pressure applied to narrow work, reaching not farther below the bench top than its own thickness, tends to draw the front leg from position, and one soon finds he has a loose and "rickety" joint.

None of the usual mortise or dovetail joints are satisfactory,

but the one shown below is very powerful and cannot be drawn from place. The detail drawing, Fig. 14, shows its construction and proper proportions. After the glue has set, two $\frac{3}{4}$ -inch wooden pins should be driven into the holes.—72

A JOINT THAT CAN BE TIGHTENED

The joints of a workbench are quite sure to work loose in time, and it is important that they be constructed in such a way

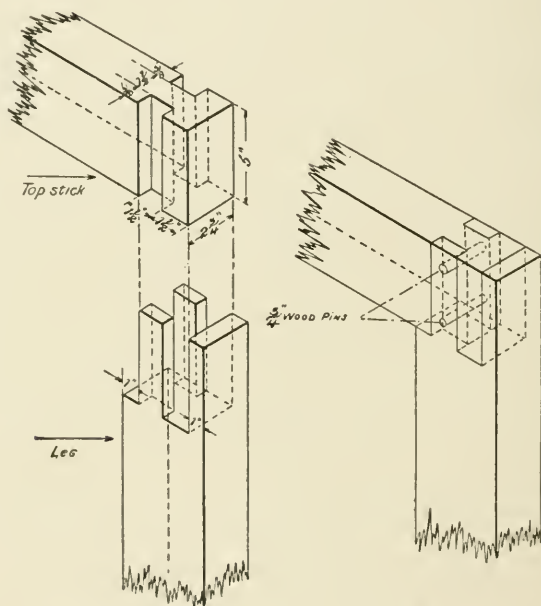

Fig. 14—Solid joint for handy man's workbench

that they may be tightened from time to time. The construction shown in Fig. 15 is one that the writer has used with perfect satisfaction for years. The frame of the bench is made of 2 by 3-inch sticks. Sockets are cut in two adjoining faces of the post to receive the tongues formed on the horizontal sticks of the frame. The sockets are made deeper than the tongues, so as to

permit of adjustment. A hole is bored through the post and endwise into one of the horizontal sticks through the tongue. A bolt is fitted into this bore and is screwed into a nut which is introduced into the stick through a transverse hole. In the same way the other stick is secured to the post, care being taken to have the second bolt hole at a different level so that it will clear the first one. The bolts can be drawn up very tightly, so as to make a firm joint. When the joint works loose it can be tightened up with a wrench in a moment's time.—51

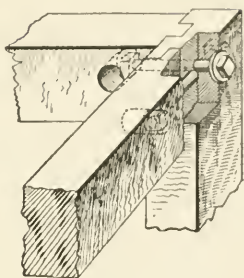

Fig. 15—A joint that can be tightened

BENCH HOOK

A bench hook can be made from a piece of beech wood 3 by 2 by 9 inches in length. Cut out the hook as shown in dotted

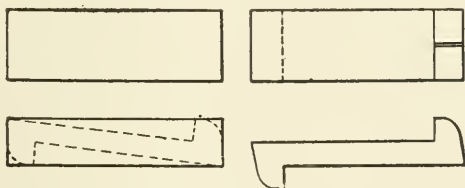

Fig. 16—The bench hook

lines, in Fig. 16, and round the ends. The saw cut should be vertical and at right angles to the cross piece. When one side of the hook is worn, it can be turned over, and the other side be used.—3

A COMBINATION PLANING AND SHOOTING BOARD

It is sometimes necessary to put a long straight or bevel edge upon a board; and while this can be done by the aid of the try square or bevel square, the board being held in the vise, the

accuracy of the work depends largely upon the skill of the mechanic, and requires much practice. For the amateur, and even the professional, a board such as illustrated in Fig. 17 is desirable.

All that is necessary for planing square edges only is a board about 9 inches wide, secured to one underneath, 15 inches in width, each $\frac{7}{8}$ of an inch thick, and as long as the bench. The

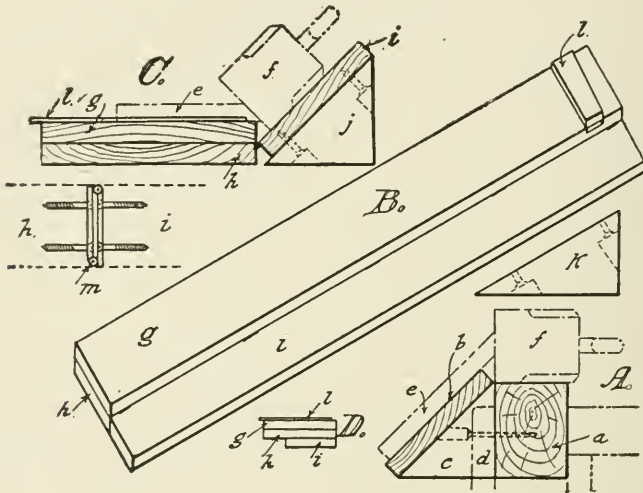

Fig. 17--Combination planing and shooting board

boards must be planed perfectly true, the working edge in particular, and a stop of some kind should be furnished at one end.

Sometimes it is necessary to plane a long miter edge on a board, in which case an ordinary shooting board, such as described, will not do.

One arrangement of shooting board for long miter joints is shown in the cross-sectional view *A*, in which *a* is a length of 3 by 4-inch timber, to which is secured a board *b*, at an angle of 45 degrees, by means of triangular blocks *c*, spaced about 2 feet apart, commencing near the ends. One end of the shooting board

is held in the vise *d*, the other end resting upon pegs in the apron of the bench. The board *e*, whose edge is to be planed, is clamped to the board *b*, and the plane *f* shot along the 3 by 4-inch piece *a*.

At *B* is shown another scheme, where two 9-inch boards, *g* and *h*, are secured together by means of screws, driven in from the underside of the lower board *h*, which in turn is hinged to a board *i*, in the same plane, 6 inches wide. By means of blocks, *j* or *k*, secured to the board *i*, bevel or miter edges of 45, 60, and 30 degrees can be planed along the edge of any board *e*, as detailed at *C*. A wedge stop *l*, of hard wood, is furnished at the far end of the plank *g*, several being made of various thicknesses, to suit the work in hand.

Before using the board, the workbench should be swept down, and it is very necessary to have it level.

Ordinary hinges for holding together the boards *h* and *i*, are perhaps best, being steadier; but for convenience when the board is out of use, if the double swing hinges *m* are used, the 6-inch board *i* can be folded under the others, as shown at *D*, the blocks of course having first been removed.

Care must be taken to place the hinges a trifle below the surface, or the edge of the plane will wear over them, as it is shot from one end of the board to the other.—3

A CORNER CABINET

The large heavy tool chests which were at one time so much in use are very awkward to get at, injurious to the tools, and in other ways inconvenient and out of date. A cabinet secured to the wall, within easy reach, is more convenient, and each tool can be seen at a glance, having its appointed place, hung either vertically or horizontally on a peg or shelf or in a drawer within the cabinet. A tool cabinet is cheaper, and is made more easily than a chest. By referring to any tool catalogue, it will be seen that it is simply a flat oblong box with a recessed lid. The latter can be made from a box procured at a hardware store or box factory at little expense. But to have something different is generally the desire of most "handy men."

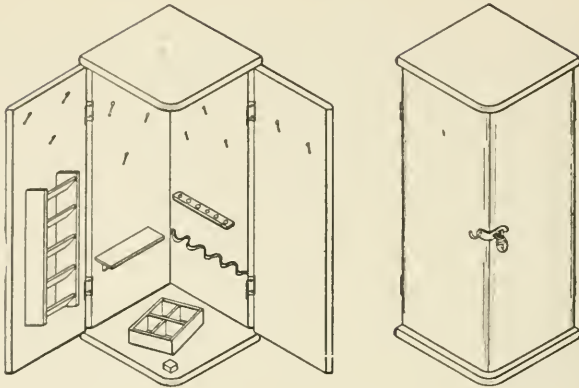

Fig. 18—The corner cabinet open and closed

The corner cabinet, or cupboard, shown in Fig. 18, and detailed in Fig. 19, is not only original, but more easily made than any of the foregoing tool chests or cabinets.

The top and bottom consist of two boards, 13 inches square by 1 inch thick. The projecting corner is rounded off to a radius of $1\frac{1}{2}$ inches, and the adjacent sides have their edges slightly rounded, as shown at *A* in Fig. 19. Four sides, *B*, are cut from

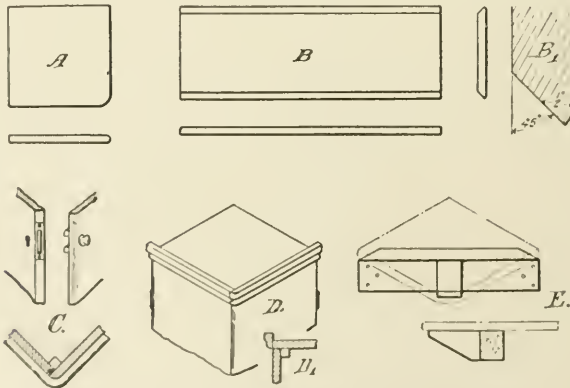

Fig. 19—Constructional details of the cabinet

1-inch boards, 2 feet 9 inches in length and 12 inches wide. The edges are chamfered at an angle of 45 degrees, and the corners rounded off to a radius of $\frac{1}{2}$ inch, as detailed at B_1 . Two of the sides, B , are secured together with nails and glue, and the top and bottom nailed in position, flush with the outside edges, which are square, allowing the cabinet to fit close against the corner of the shop. The other two edges, which are rounded off to give a neat finish, project 1 inch, as clearly seen in Fig. 18.

Either a padlock, with strap, can be used to lock the cabinet, or a flush lock, as shown at C in Fig. 19. Two blocks of wood,

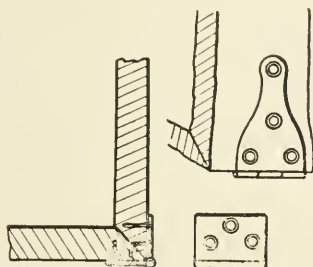

Fig. 20—How the hinges are applied

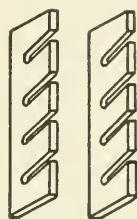

Fig. 21—Rack for chisels

for the doors to bear against when closed, are secured to the bottom and underside of the top, 2 inches from the edges. These are shown in Fig. 18, and at C and D_1 in Fig. 19. If desired, the top and bottom can be made 12 inches square, and finished off with a cornice, as shown at D and D_1 .

The cabinet can be supported on a bracket, made from a piece of 3 x 4-inch timber, as detailed at E . Spikes driven into the wall, through the sides of the cabinet, will further secure it.

Two hinges should be used on each door, either made flush, as shown in the general view, Fig. 18, or on the outside, as shown in the detail view, Fig. 20.

The furnishing of the cabinet is a matter of choice and depends to a certain extent on how many tools are placed in it. The saws

and lighter tools should be hung upon the doors, the heavier tools inside. Shelves and racks of wood or leather, for the bits and handle tools, can be easily made. A rack constructed as shown, hung upon the door, will be found very useful for small tools. Chisels, etc., can be supported on vertical strips of board, notched as shown in Fig. 21. Either a plain oil finish or the natural wood is all the cabinet requires to complete it.—3

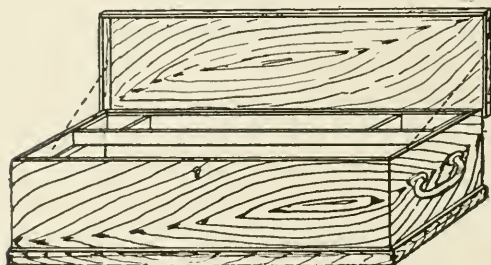
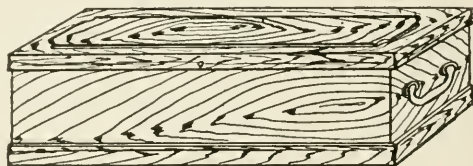

Fig. 22—The shoulder chest.

A SHOULDER CHEST

When called to do outside jobs, it is very necessary to have some suitable box or chest in which to carry a few tools, either in the hand, on the shoulder, or on the back if a bicycle is used. The writer is acquainted with a mechanic who took more interest in making his shoulder chest than any other furnishings of his shop, claiming that it would be an advertisement of what he could do if called upon.

The chest is illustrated in Fig. 22, and detailed in Fig. 23. A trunk strap was put through the handles and thrown over the

shoulders, when he mounted a wheel to go to his job, or the strap shortened to make a comfortable handle, if within walking distance of his employment.

The chest should be made from half-inch stuff; chestnut being a good wood, because the grain shows off to an advantage when the finished article is given an oil polish.

Select a prettily-grained piece of board, sufficiently large to cut the whole box. The sides are to be marked out in such a way

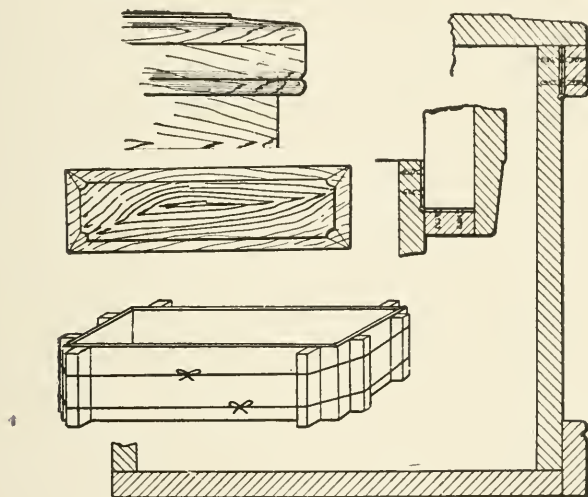

Fig. 23—Construction of the chest

that when the chest is put together, the markings of the grain will match all round, as seen in Fig. 22.

The detail view, Fig. 23, gives a general idea of the construction, and needs but little explanation. The board from which the sides and ends are cut is 8 inches wide by 7 feet in length, accurately divided into four parts, 9 inches and 2 feet 9 inches long, and the edges chamfered 45 deg., when they should be nailed together with long fine nails, and glued. The beaded finishing strips, top and bottom, are cut in the same manner. The

top strip is 1 inch deep, and the bottom $1\frac{1}{2}$ inches. The strips of wood from which they are cut are 7 feet 4 inches long. Allowance must be made for the saw cuts, both in the sides and the strips. The bottom is made from a plain board, 9 inches wide by 2 feet 9 inches long. The top is $\frac{5}{8}$ inch thick, $10\frac{1}{8}$ inches wide, and 2 feet $10\frac{1}{8}$ inches long with a panel $\frac{1}{8}$ inch deep, gouged at the corners and chamfered down to $\frac{3}{8}$ inch all round, $1\frac{1}{2}$ inch from the edge, as shown in the illustrations. When the mitered edges of the sides and the finishing strips are glued, they can be held until perfectly dry, by an arrangement of blocks and cords, as shown in Fig. 23. There should be a clearance space between the lid and the box, all around, of about $1/16$ of an inch. The corners throughout should be nicely rounded, so that there will be no sharp edges to annoy one when carrying the chest.

Hinges and a flush lock should be nicely let in the front and back, as shown in detail in two of the views. The hinges must be attached to the box first, and then to the lid, when open full. A neat brass chain will prevent the lid from accidentally opening too far. The handles should be fairly strong, and attached very securely to the ends of the chest. A neat tray, 3 inches wide by $1\frac{1}{2}$ inches deep, of $\frac{1}{4}$ or $3/16$ -inch stuff, is made to fit the chest.—3

DESK OR DRAWING TABLE

A shop should be furnished with some kind of a writing shelf or desk, and since it is often necessary to make sketches or accurate drawings of details, a drawing board and desk combined will answer well. Very often an old drawing board can be obtained, which can easily be trimmed up, and made into a drop-leaf arrangement secured to the wall. A good size is 23 by 31 inches, which will accommodate a standard-size sheet of paper, but on account of the construction in this case, the width had better be $24\frac{1}{2}$ inches.

Soft pine, free from knots and well seasoned, should be procured, and accurately planed and glued together along the joints. Two battens running across the grain of the board should be

secured to the underside, by means of round-headed screws, sunk in below the surface, and bearing upon iron washers. (See Fig. 24.) The holes should be bored larger than the screws, the hole in the washer being the same size. This will prevent the

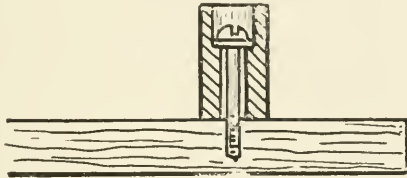

Fig. 24—How the battens are secured to drawing board

board warping, and it is very easily constructed. Make the board 1 inch thick; the battens and braces also; the cupboard from $\frac{3}{4}$ -inch stuff; and the shelves, pigeon-hole partitions, and small cupboard of $\frac{1}{2}$ -inch material.

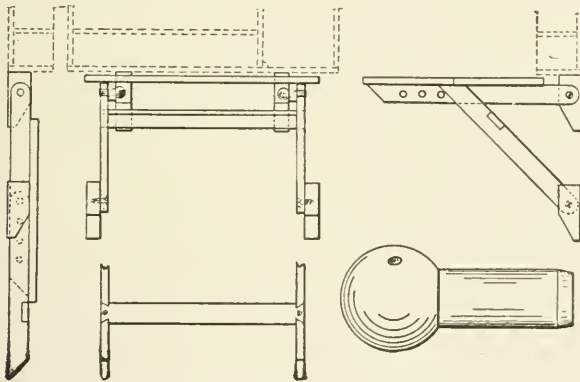

Fig. 25—Details of the drawing board

Fig. 25 is drawn to scale, showing the front and side views. The cupboard (see Fig. 26) is 6 inches deep outside measurement, and 3 feet in length. The shelves are $4\frac{1}{2}$ inches apart, making the total height 16 inches. The small cupboard is $9\frac{1}{2}$ inches square inside. It should be furnished with hinges and

lock. A small block of wood, tacked in the corners, will prevent the door closing too far inside. The pigeonholes can be either plain or furnished with drawers, and the general design altered to suit individual tastes, but an arrangement of some kind in which to keep pens, ink, pencils, writing material, smaller and finer grades of tools, notes, sketches, books, and clippings from the press or magazines. Nothing can be more useful than a place to keep all such things, for accumulate they will.

The brackets upon which the cupboard rests, and to which the

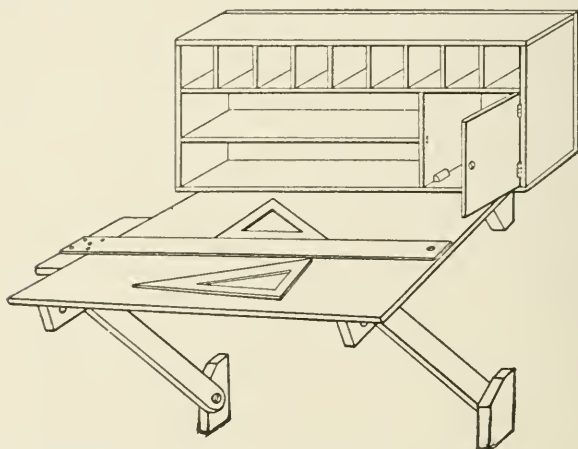

Fig. 26—General view of the drawing board and cupboard

battens are connected, and also the brackets at the foot of the braces, can be made from 2 by 3 stuff cut $7\frac{1}{2}$ inches in length, and secured firmly to the wall of the shop. Make the battens and braces 1 inch by $2\frac{1}{2}$, of hard wood, secured to the brackets with large screws, the holes being a trifle large in the battens, and the screws not driven all the way home. The cross-brace is dovetailed into the supporting braces, as shown in Fig. 25. The length of the battens and braces is 2 feet 4 inches and 2 feet 1 inch, out to out, beveled to an angle of 45 degrees at one end and rounded at the other. Care must be taken to secure the fixed

ends not more than $1\frac{1}{4}$ inches from the near edge of the wall brackets, or the board will not close up properly when folded against the wall, as shown at the left in Fig. 25.

Three holes for adjusting the board at several angles are bored $2\frac{1}{2}$ inches apart, the first one being $4\frac{1}{2}$ inches from the end. A round peg, shown in larger detail in Fig. 25, is made to fit the holes, and kept from getting lost when the board is down, by a short length of wire attached to a staple in the underside of the board. Make the bottom of the cupboard about 3 feet 6 inches from the floor, which will give about an inch clearance for the braces when the board is down, out of use.

The working edge of the drawing board should be trued up for the butt end or head of the T-square to work against. In selecting a T-square, sight along the working edge, to see that there are no imperfections, and select one where the blade is on top of the head, so that the triangles will slide over it. A T-square, two triangles, triangular scale, and a small set of instruments can be purchased at a very reasonable cost.

Fig. 26 gives a fairly good idea of how the board and cupboard will look when complete. If much sketching or laying out is to be done, a high stool will be found convenient.—3

THE GRINDSTONE

The grindstone is generally purchased with frame complete as shown. The frame is usually 24 inches high by 38 inches in length, out to out of handles, which are made of $2\frac{1}{2}$ by $1\frac{3}{8}$ inch stuff, shaped at the ends to $1\frac{1}{2}$ inch diameter by 4 inches long. The legs are $1\frac{3}{4}$ by $1\frac{1}{2}$ inches, spread at the base 33 inches one way and $11\frac{1}{2}$ inches at the ends, inside dimensions. The handles are spaced 9 inches apart outside dimensions. A piece of timber $1\frac{1}{4}$ inches thick by 10 inches deep is bolted to the legs at each end. The treadle rod and guides are made of $\frac{1}{4}$ -inch round iron. The stone can be turned by hand or foot power, the handle being easily removed. The bearings are shown with the dust cap removed, to show the rollers. Under the stone is shown, in broken lines, a wooden water trough resting upon a 1-inch board,

which in turn rests upon two strips nailed to the legs. Some mechanics object to this manner of wetting the stone, claiming that it washes off all the powdered stone necessary for the grinding process. Instead they put an ordinary tin can, with a small hole punched in the bottom, just above the stone, allowing the water to drop on the stone instead of washing it.—3

ARTIFICIAL GRINDSTONE

A grindstone made from one-half best Portland cement and one-half silica sand may be used in grinding glass to take the

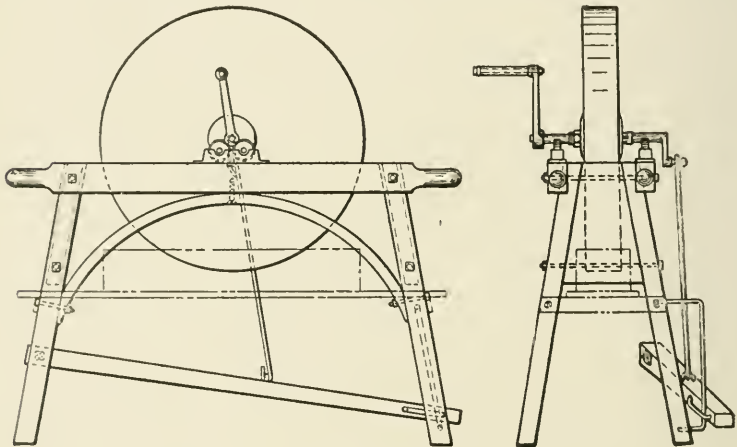

Fig. 27—Frame construction for grindstones

place of the wheel caster. The materials must be thoroughly mixed and evenly tamped. The advantage of this stone is that when properly made there will be no hard and soft spots, and it will grind glass without scratching. The cost is about ten per cent of that of the common grindstone.

A SIMPLE FOOT-POWER GRINDER

The accompanying description and illustration of a grinding and polishing machine made by the writer in about an hour's time and at practically no expense, may be of interest. The cheapness and ease with which it can be made are due to the

utilization of certain parts of a bicycle (which is usually available or can be obtained for a small sum second hand) for the driving mechanism, and to the employment of a convenient workbench or strong table as a stand. The bicycle should have as high a gear as possible (it is not injured, and can be reassembled and used on the road again) and should have its front wheel, forks, handle bar, and back tire removed. In order to support the remaining parts, two boards about $1\frac{1}{4} \times 4$ inches, reaching from the floor to the top of the bench, should be provided, and these should each be drilled 16 inches from the bottom with a hole of

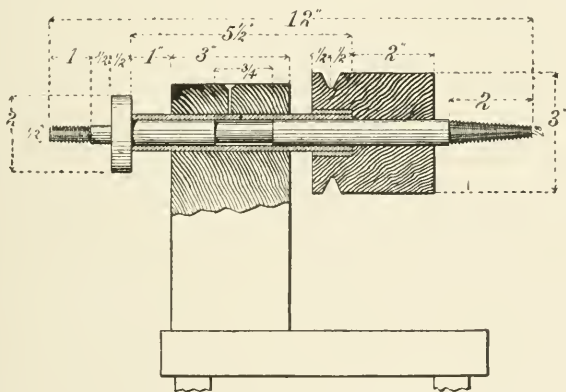

Fig. 28—Dimensions of the grinder head

a size to fit tightly on the nuts on the ends of the rear axle. These boards should be nailed to the floor on each side of the rear wheel, and nailed to a board at the top, so as to clamp the bicycle frame tightly between them, with the axle in the holes previously mentioned. This board should be firmly fastened to the top of the bench, and should be long enough to bring the grinding wheel in a convenient position, while its width should be sufficient to cover the tops of the axle supports. An upright board should support the head of the frame, so that the pedals will clear the floor by about 2 inches.

The grinder head, used with this foot-power device, consists of a block of wood (see Fig. 28) about 3 x 3 inches fastened firmly on to the top board by nails or screws, and of sufficient height to bring the grinding spindle to the desired position, a brass bushing which is of about $\frac{1}{2}$ -inch iron pipe size tightly fitted in a hole in the top of the block, a grinding spindle, and a grooved wood



Fig. 29—A simple foot-power grinder

pulley. The spindle is the only piece requiring lathe work, and even this may be eliminated by using a straight rod (the bushing tube being of a size selected to fit it) and very carefully threading it with a $\frac{1}{2}$ -inch 12 die for the collar and clamping nut. It is, however, much more satisfactory to have a turned spindle, as it can then be made a better fit in the bushing, and the inner collar and part carrying the wheel can be turned true with this bearing

surface. The part of the spindle that goes into the inner collar should be made a drive fit in the collar, and the latter should be turned while in place on the spindle. A nut and large washer should be provided for clamping the grinding wheel on the spindle. The other end of the spindle is formed with a threaded taper for polishing and buffing wheels, although it would be cheaper to leave it blank. It could also be arranged to carry a second grinding wheel if desired. The pulley which goes on this spindle is cut (if possible turned) out of a piece of hard wood, and is bored so as to make a tight fit on spindle. If it should show any tendency to slip, a set screw can be run through it and against the spindle. This completes the machine with the exception of a $\frac{3}{8}$ -inch leather belt, a grinding wheel ($\frac{3}{4} \times 6$ inches is a good size) and, if desired, a tool rest which can be rigged up around the wheel.—63

THE LATHE

A substantial lathe such as shown in Fig. 30 may be built as follows:

The legs, *A*, are made from 2 x 4-inch timber, 3 feet 3 inches in length. They are spread 5 inches at the top, and 1 foot 6 inches at the bottom: the 4 x 6-inch pieces, *B*, being cut to fit between each pair.

The lathe-bed, *C*, is 5 feet 6 inches long, made of 3-inch by 7½-inch lumber. A 2-inch-wide slot is cut out of the center, running the length of the pieces, to within 2 inches of each end, as shown in the general view of the lathe, and in larger detail in Fig. 31. A more accurate job will be the result, if a slot is cut in a solid piece of timber, instead of using two lengths, joined together at each end, with distance pieces.

The right-hand pair of legs shown in general view, Fig. 30, is 6 inches from the end of lathe-bed, while the other pair is 9 inches, on account of the head-stock which overhangs them. The half joints for these legs are marked 1 in Fig. 31, a section being given, bearing the same number.

The joints, marked 2, are for the head-stock, *D*. There is need for only one of these, on the belt side of the lathe, but two are

shown in case the lathe should be turned into a foot-power machine. A section is given marked 2, to correspond with the plan, in which it will be seen that the slope of the cuts is about $\frac{1}{2}$ or $\frac{3}{4}$ of an inch from the edges of the 2-inch groove, or slot, at the top, and the same distance from the outside edge at the bottom.

Fig. 32 shows the details of the head-stock, *D*, and Fig. 33 the

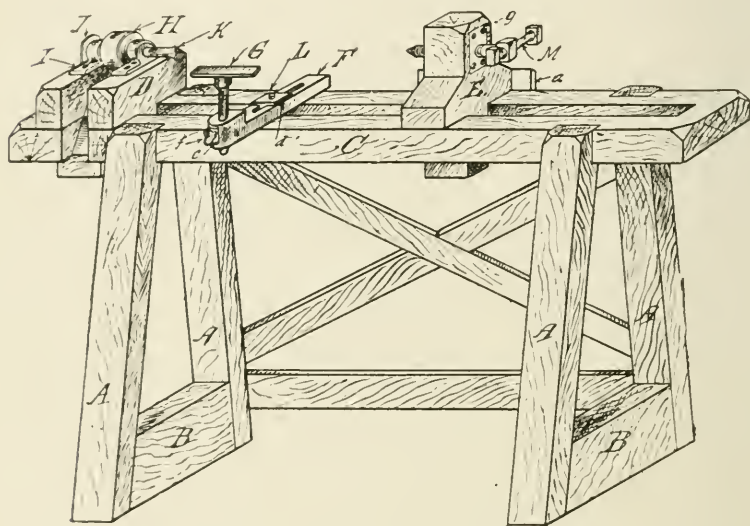

Fig. 30—The lathe without the treadle mechanism

tail-stock, *E*. The tongue of the latter must have a sliding fit, so that when the wedges are taken out, the stock can be adjusted to suit the various lengths of material to be turned. The tongue of the head-stock, *D*, can be a tight fit, and when once set up accurately, need not again be moved.

The height of the head-stock is 10 inches, including the tongue, which is 6 inches. The running length is $6\frac{1}{2}$ inches, the width being the same as the bed of the lathe, namely, $7\frac{1}{2}$ inches. The V-shaped opening for the belt is $2\frac{1}{2}$ inches wide, being a con-

tinuation of the section marked 2, in Fig. 31. The mortises for the wedges are spaced $1\frac{1}{2}$ inches from the ends and should be cut $2\frac{3}{4}$ inches from the bearing face of the head-stock, so that when the wedges are driven home the stock will be drawn up tight. The wedges are made from hard wood, rounded along the edges and ends. They are about 6 inches long, and should have a taper of about $\frac{1}{2}$ inch, likewise the mortises.

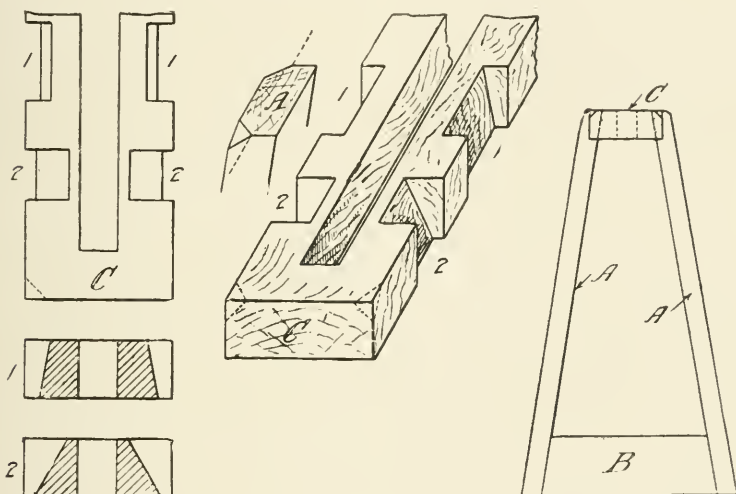

Fig. 31—Construction of frame

The tail-stock, *E*, is $7\frac{1}{2}$ inches wide, to suit the width of the lathe-bed. The guide, *a*, is 1 inch thick by $7\frac{1}{2}$ inches long. It is secured to the stock with screws, allowance being made for enabling the stock to slide, as stated above. It is 4 inches wide, there being but one wedge. The full height, including the tongue, which is the same as that of the head-stock, is 13 inches. The location of the plates, *g*, referred to elsewhere, will depend upon the size of the bearings, *I*, shown in detail in Fig. 34.

The tool rest and clamp *F*, *G*, and *L*, Fig. 35, can be made of either hard wood, or metal. The length of the clamp *F* is 9

inches, width 2 inches, and thickness 1 inch, the body for the rest being $2\frac{1}{4}$ inches deep. A small plate *c* is tapped for a thumb-screw *f*, about $\frac{7}{16}$ inch diameter. *L* is an ordinary square-

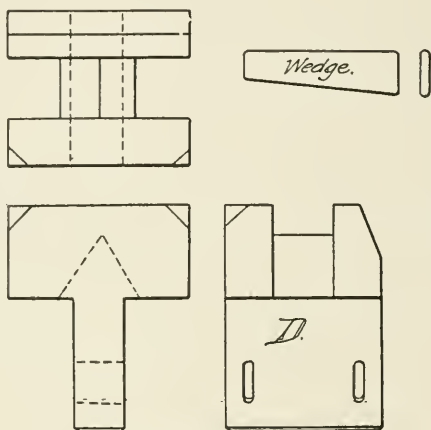

Fig. 32—Details of head-stock

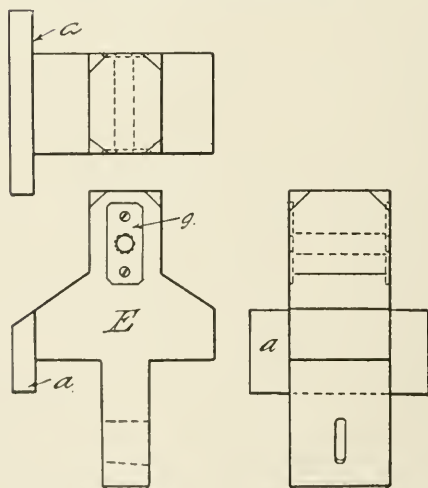

Fig. 33—The tail-stock

headed bolt of suitable length, $\frac{5}{8}$ inch diameter, furnished with a cruciform claw, 4 inches square, outside dimensions. A metal nut, *d*, $1\frac{1}{4}$ inches square, shaped to fit the groove in the clamp *F*, is threaded to take the bolt, *L*. The rest, *G*, can be made of either metal or wood. The pulley, *H*, has a 2-inch face, and is $3\frac{1}{2}$ inches diameter. It is made of hard wood, and is secured to the spindle, *K*, described in the previous article. A plate, *J*, is secured to the outside edge of the head-stock, to take the thrust coming upon the spindle, or chuck, *K*, when work is being turned in the lathe. At *M* is shown a $\frac{5}{8}$ -inch adjusting screw, with the end brought to a cone-shaped point. The plates, *g*, are tapped to suit, and are secured to the stock, flush with the outside face, with wood screws. The corners throughout the job are chamfered, and the surfaces made smooth.

The pulley *H* is belted to a driving pulley on a counter-shaft. Should it be desired to make a foot-power lathe, a couple of bearings can be secured to the blocks *B*, and a crank shaft run through. The fly-wheel should be heavy, and a light guard should be placed around, as it will have to be on the outside to come under the head-stock pulley, *H*.

Almost any kind of wood will do for the general construction, but yellow pine will be found serviceable, and give weight to the lathe, otherwise it may be found necessary to anchor it down to the shop floor, if driven by power from the saw.

In Fig. 36 are given the changes necessary for a foot-power lathe. A blacksmith will make the crank shaft for a small sum.

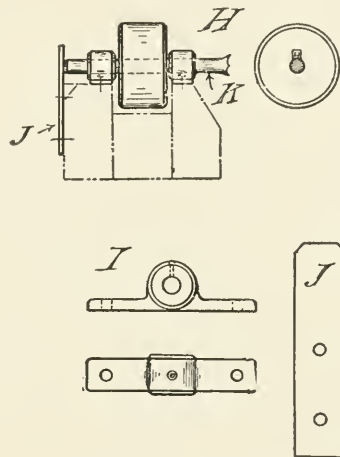

Fig. 34—The spindle

The wheel can be procured from almost any junk dealer. The treadle is made from two 1-inch by 4-inch strips, hinged to the back stay, and a distance piece. An ordinary staple, clinched on

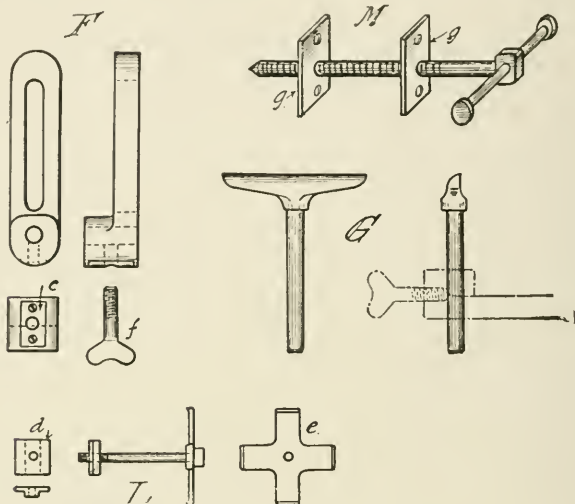

Fig. 35—The tool rest and tail screw

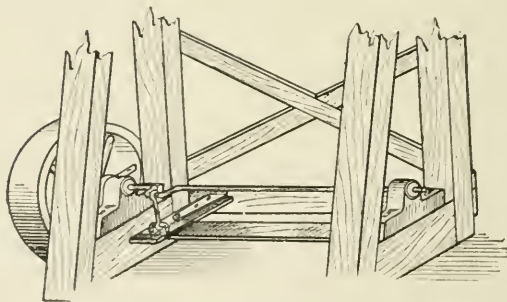

Fig. 36—The treadle mechanism

the underside, will do for holding the eye end of the connecting-rod, a hook being formed at the other end to slip over the crank.

EXTENSION FOR SPEED LATHE BEDS

When it is desired to turn a piece of work which is longer than the bed of your lathe the scheme illustrated in the accompanying photograph will be found useful. Take two strips of wood equal in width to the depth of the lathe bed, letting them extend out as far as desired. Screw a block the width of the lathe bed across the ends of the side strips, so as to hold the end firm, and in alinement. Also screw two strips inside of the side strips at the closed end, of a length equal to the poppet head, leaving a slot of the same width as the slot in top of lathe bed

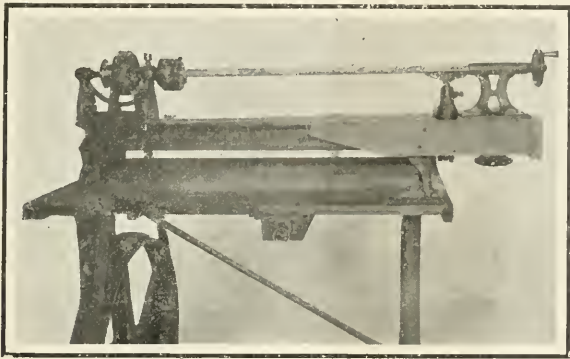

Fig. 37—Extension for speed lathes

and flush with side strips, which will hold the poppet head in alinement with chuck.

Screw a piece of bar iron across the side strips at the front. Bore a hole in the center of the bar for a bolt which should run through same and also through a similar iron strip beneath lathe bed parallel with upper strip. This will clamp the front end of side strips firmly to the bed. Also fasten another strip near the end of the lathe bed and resting on bed to support the extension and keep it in alinement with upper face of bed. A series of holes may be drilled through the side strips so that a bolt may pass through same close to rear end of lathe bed which will

clamp the side strips rigidly to the sides of the lathe bed. The construction makes it possible to draw out the extension to any desired degree. The writer has found this to be a very useful attachment.—60

THE SCROLL-SAW

The following description of a scroll-saw was given to the writer by a first-class mechanic, who assured him that it was one of the most useful articles he had in his shop; and judging by the number of times it was borrowed for cutting many shapes of ornamental woodwork, which can generally be found in almost any kind of house building, it spoke well for the mechanic and the efficiency of the saw. Brackets up to 3 inches in thickness.

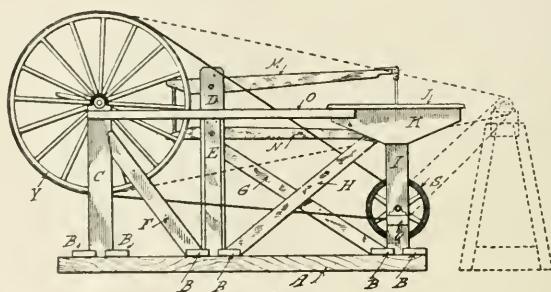

Fig. 38—General side view of the scroll-saw

were easily cut out, and all the ornamental scroll work on the outside of his beautiful frame house.

A general side view of the saw is given in Fig. 38, while the lathe described in a foregoing article, page 27, is shown in dotted lines attached to the saw. The other illustrations, Figs. 39 to 44, give various details and sections. The reference letters, from A to Z, are duplicated on each figure, and tend rather to make an otherwise very simply constructed mechanism appear complicated.

While the proper sizes of lumber will be given, there is no

reason why every part of the saw cannot be made from such material as may be found around almost any house.

It will be noticed that the framework consists of but three different sections of timber and 1-inch boards. The bottom framework is 2 feet 6 inches wide and 8 feet in length over all. The height from the floor to the top of the table, *J*, is 3 feet 7½ inches. A list of material follows, with allowance for cutting where necessary:

Pieces.		In. In.	Ft. In.
2.....	(A)	3 x 4	x 8 0
2.....	(D)	2 x 6	x 4 4½
2.....	(C)	2 x 6	x 3 4½
2.....	(I)	2 x 6	x 3 4½
6.....	(B)	2 x 6	x 2 6½
1.....	(P)	2 x 6	x 1 0
1.....	(G)	2 x 3½	x 4 6
2.....	(H)	2 x 3½	x 4 6
1.....	(E)	2 x 3½	x 3 3
2.....	(F)	2 x 3½	x 3 3
1.....	(Z)	2 x 3½	x 2 7½
1.....	(Q)	2 x 3½	x 0 6
2.....	(U)	2 x 2	x 1 0
1.....	(X)	2 x 2	x 0 8
1.....	(J)	1 x 36	x 3 0
2.....	(K)	1 x 9	x 2 9
1.....	(N)	1 x 3	x 5 1½
1.....	(M)	1 x 3	x 4 10½
1.....	(O)	1 x 2	x 5 9
2.....	(L)	1 x 2	x 2 0
2.....	(V)	1 x 2	x 1 0
1.....	(W)	1 x 2	x 0 7½
1.....	(T)	1 x 1½	x 1 9

The upright *D* can be made from a 4 x 6-inch instead of two pieces as given in list, and the guides *U* with the block *X* can be made from 1-inch stuff.

When level, the saw frames *M* and *N* are $15\frac{1}{2}$ inches apart, out to out. Pieces are secured to the ends, 1-inch by 8-inch, cut to the same shape, and provided with holes for an adjusting bolt,

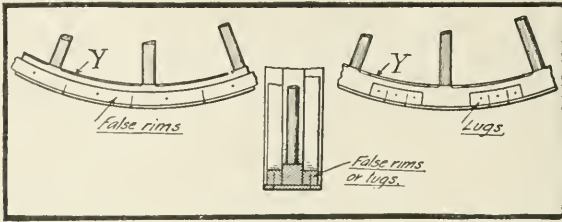

Fig. 39—Extending the rim of the wheel

with washers top and bottom. The holes should be of such a shape to give ample room for this bolt. Mortises are cut in *D*

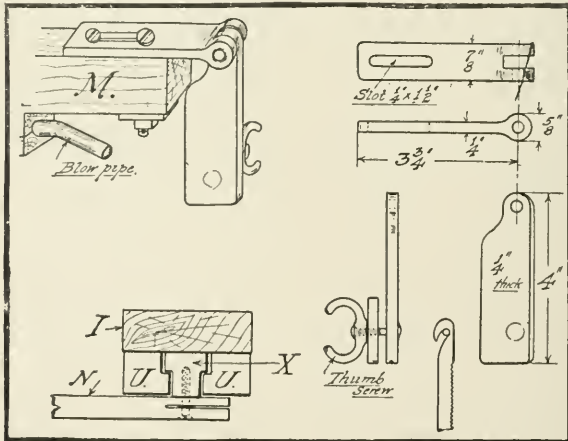

Fig. 40—Details of the saw frame

for the saw frame, $1\frac{1}{8}$ inches wide by $4\frac{1}{2}$ inches deep. They are centrally located with the frames, and the top edge of the first mortise is 3 inches from the top of upright *D*.

All the uprights and braces are cut where they come in contact with the bottom framework *A* and *B*; some of them being further secured to the inside face of the 3-inch by 4-inch sills with

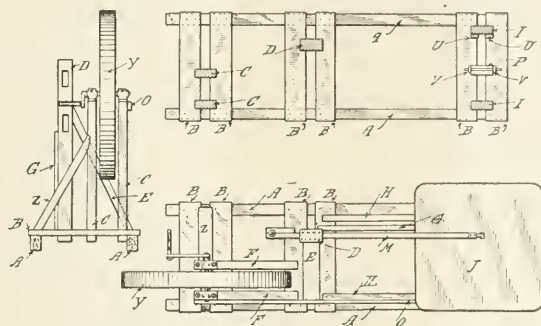

Fig. 41—Plan view of the machine

nails or screws. While nails will be permissible, if clunched, it will make a more satisfactory job to use screws throughout the construction. The bearings can be made of hard wood, if there

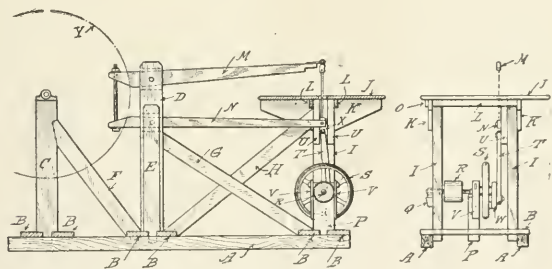

Fig. 42—Vertical section of the machine

is any difficulty in procuring suitable ones made of brass or iron.

An ordinary light buggy wheel, *Y*, is provided with 4½-inch rim, made of ¼-inch oak or pine, bent into shape by steaming or

soaking in water, and secured to the tire of the wheel, *Y*, by means of two false rims, or lugs, as detailed in Fig. 39.

The saw blades are generally provided with a small hole at either end. By means of an ordinary wood screw or a bolt, one end of the saw blade can be connected to the arm *N* and the block *X*. The arm *M*, however, has a different attachment, to allow for the necessary alignment of the saw blade, and in all probability this will necessitate the aid of a blacksmith, so a detail sketch is given (Fig. 40). The hole at this end of the saw blade is filed open to form a hook. Details of the guides *U* and the block *X* are also given in Fig. 40.

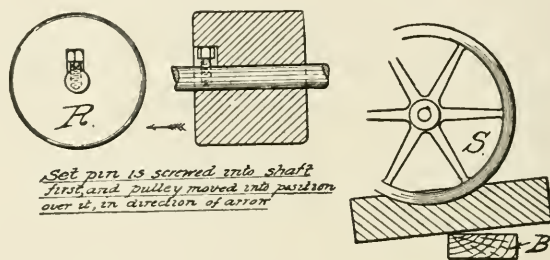

Fig. 43—A simple foot-brake

The balance wheel *S* was purchased from a junk dealer. It was found insufficient in weight, when heavy stuff was to be cut, so an extra wheel was put on the end of the shaft beyond the out-bearing *Q*. A strip of wood *W* was secured to the vacant holes left by the spindle and crankpin of the old wheel, and a new center made for the end of the connecting rod *T*, giving a stroke of $3\frac{1}{2}$ inches to the saw. The two strips *I*, secured to the upright *P*, are used to hold down the bearing by means of a hardwood wedge driven over the top, as indicated in Figs. 41 and 42.

The hardwood pulley *R* is 6 inches diameter and 5 inches face. It is secured to the shaft in the manner shown in Fig. 43. A

simple brake, made from a piece of 3-inch by 4-inch timber, shaped on one edge to fit the rim of the wheel, and operated by the foot, is shown in Fig. 43, it having been omitted in the general views. The connecting rod *T* is made from hardwood, 21 inches long, 18 inches center to center of holes for two ordinary wood screws, to connect the ends to the block *X* and crank *W*.

Ordinary jig-saws are usually provided with bellows, so an arrangement similar in construction is given in Fig. 44. The bellows are of sheepskin or soft leather. The head is to be secured to the under side of the table *J*, and the bottom furnished with a leather flap valve on the inside. The opening must of course clear the arm *N*; so also must the tube connection.

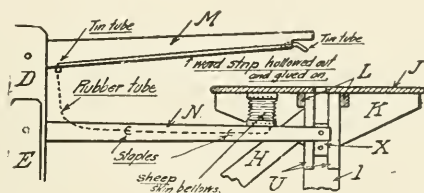

Fig. 44—How the bellows is arranged

The motive power of this scroll saw is of course someone at the crank end of the driving wheel *Y*, but there is no reason why the wheel and its supports should not be taken off, and a small gas or oil engine connected direct to the pulley *R* with a belt. When the saw is not in service the wheel may be taken off and the framework placed against the end wall, or even hung up.—3

A COMBINED SCROLL SAW, TOOL GRINDER, ROUTER, AND DRILL PRESS

Perhaps many an amateur is looking around for something to turn his lathe or to drive his emery wheel, or may be he is thinking of making a jig saw that will compare favorably with the best; not a mere toy, but a saw of practical value; a saw that one man can operate, and that is capable of cutting through a 2-inch

oak plank if necessary. Of course the amateur will take more pride and pleasure in a machine made by his own hands, and

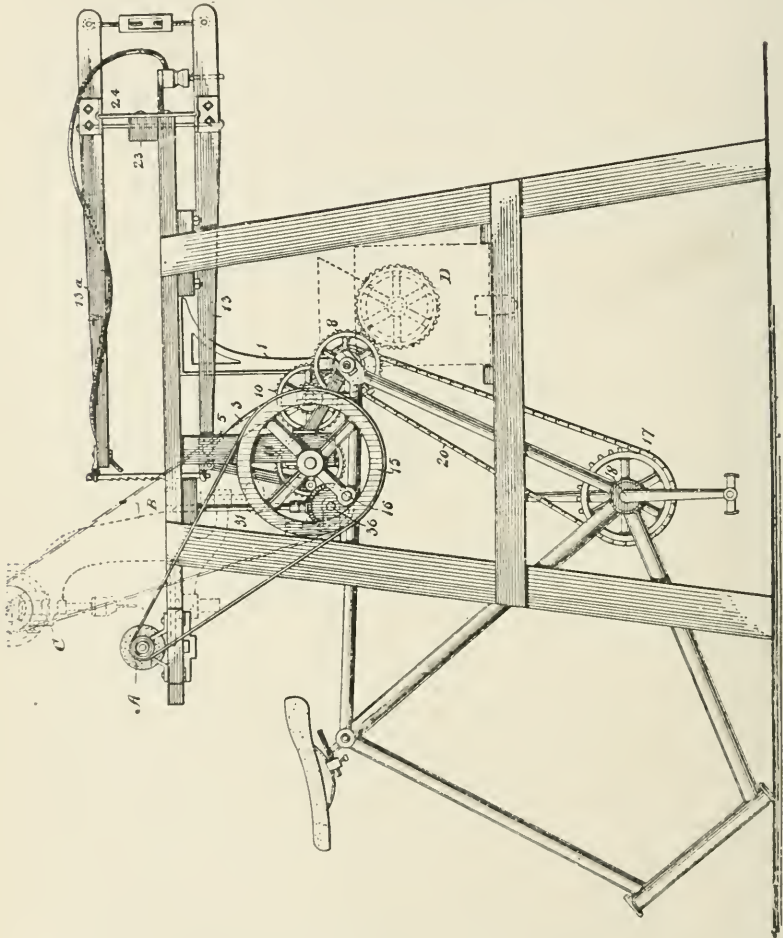

Fig. 45—Combined scroll saw, tool grinder, router and drill press

will strive to have it much better in many respects than anything on the market.

The accompanying illustrations are intended to show just how a practical machine of the kind can be built, and it will enable

him to bring into active service, again, the old and forgotten bicycle he stored away in the attic some years ago. No attempt has been made to show any details of the driving mechanism, as of course that will largely depend upon the gear and make of the bicycle to be used, and on such old gearwheels and pinions as the amateur may have on hand, or is able to purchase. Almost anything will do, as long as the proper speed of the saw is obtained, which should be six to seven strokes to one revolution of the pedals. The arms with their fastenings are detailed very

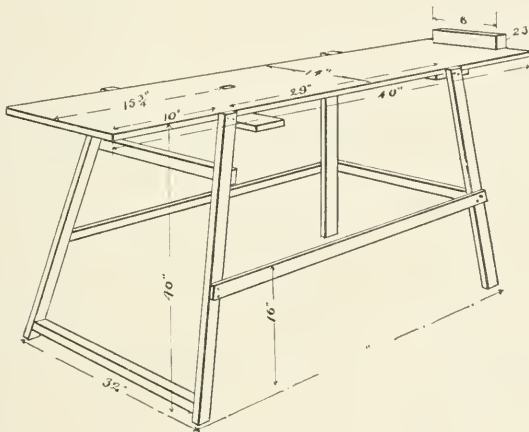

Fig. 46—The scroll-saw table

carefully, and if the dimensions are closely adhered to there will be no trouble in assembling them. The mountings as well as the saw blades, in different widths, may be bought in the market.

Fig. 45 represents a side elevation of the scroll saw with its accessories, which consist of a tool grinder *A*, molder *B*, and drill press *C*. A grater mill, such as used for grinding apples for cider and the like, may be added as shown in dotted lines.

The Scroll Saw.—A table, supported on suitable legs, shown in Fig. 46, is made first. To this the bicycle is securely fastened at the front and rear ends. The rear hub is secured on one side to

an ordinary shelf bracket 1, depending from the table, and on the other to a small brace 2, which is better shown in the plan view, Fig. 47. The front forks, 3, are cut off and with front hub 4 are fastened to a block of wood, 5, depending from the under side of the table. This block also forms a support for the crankshaft, 6.

It will be noticed that the rims as well as the spokes of the

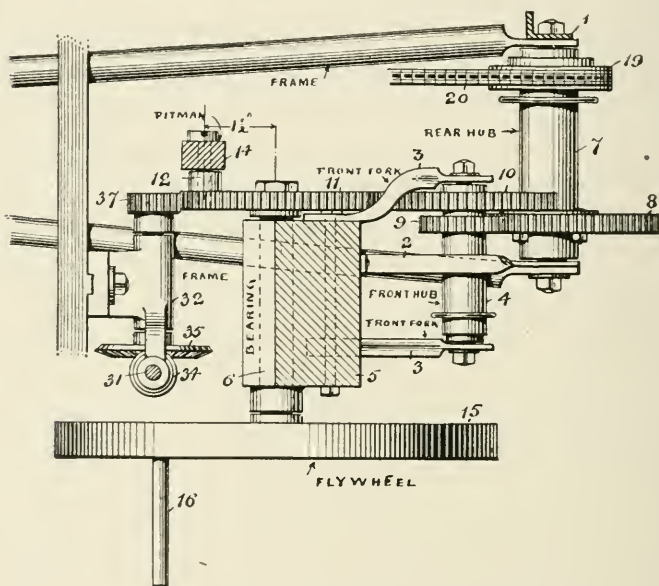

Fig. 47—Plan view of the gearing

wheels are removed, also the steering post is taken out and the saddle is turned end for end. To the flange of the rear hub, 7, is bolted a large gear wheel, 8, meshing with a pinion, 9, on the front hub, 4, which also carries another large gear, 10, meshing into another gear, 11, fastened to crankshaft, 6. The latter gear carries a wrist pin, 12, and is connected to the lower arm, 13, of the saw frame by means of a pitman, 14. One of the flanges of

the front hub, 4, is cut off, and the gears 9 and 10 are slipped on and soldered fast to the barrel of the hub. The gear train from the sprocket chain to the saw frame is shown in Fig. 48. At the opposite end of crankshaft 6 is fastened a small flywheel, 15, with a handle, 16; its purpose to be explained later. It is now evident that when the operator works the pedals the crankshaft 18 will revolve and the saw-carrying arms, 13 and 13a, owing to their connection therewith will be moved up and down. The arms 13 and 13a are made of hard wood, such as maple or hickory. They are fulcrumed at the rear end of the table and are

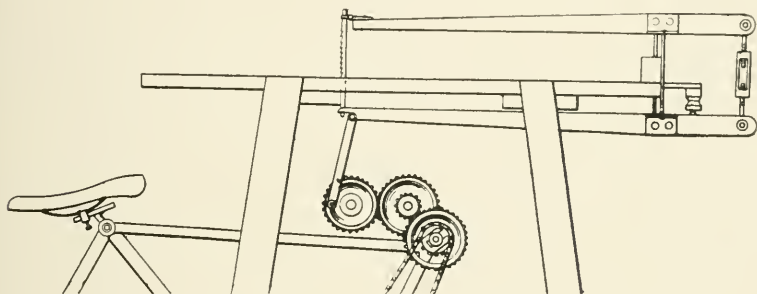

Fig. 48—Gear train from sprocket chain to saw frame

provided with suitable fastenings at their forward ends to receive the saw blade, while their rear ends are connected by a suitable turnbuckle to regulate the tension of the saw blade. To the arms are bolted small brackets, 21 (see Fig. 49), made of sheet steel about $\frac{1}{8}$ inch thick, which have at their outer ends small half-round recesses, 22, made by a very blunt chisel on top of a piece of hard endwood.

To the rear end of the table is fastened a short block of wood, 23, say 8 inches long, and on this block is fastened a small steel plate, 24, with projecting ends, 25, which fit into the recesses, 22, of the brackets, 21, on which the arms 13 and 13a rock. In close proximity to this plate is an iron rod passing through said arms riveted at each end, with a leather washer between, which serves

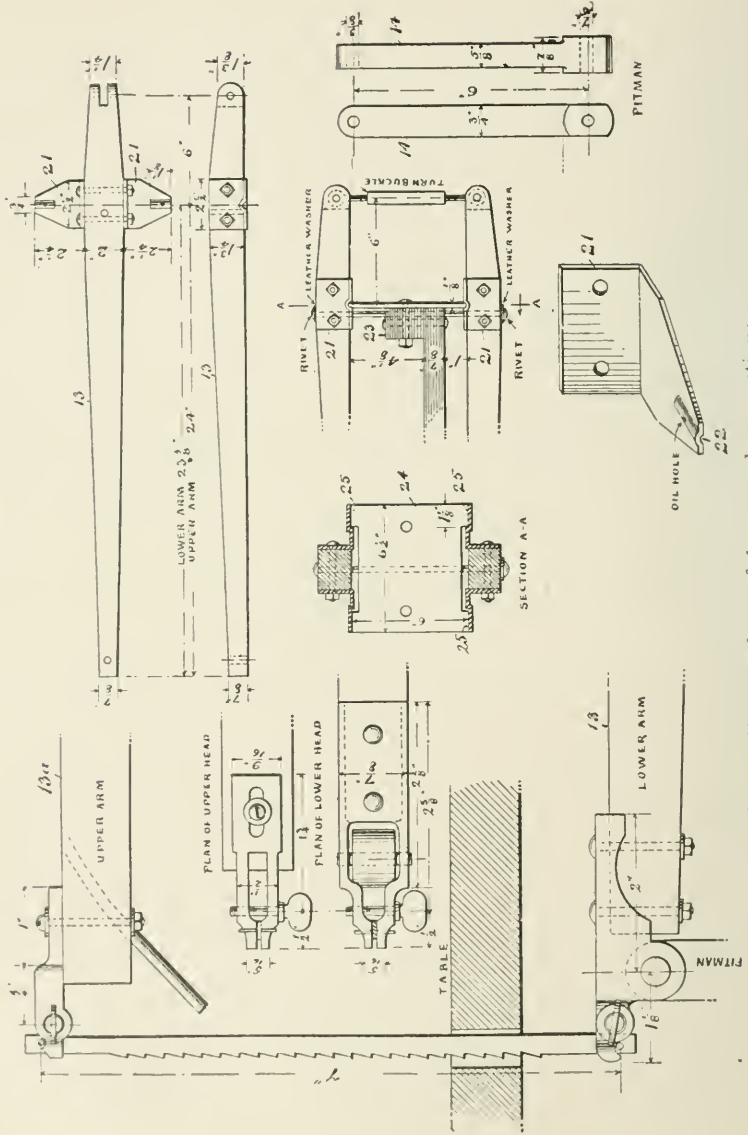

Fig. 49—The saw-frame fulcrum and connections

as a cushion and allows sufficient flexibility to enable the arms to swing on their fulcrum. The clamping devices for the saw are made of wrought iron or steel. The lower clamp has downwardly extending lugs for connection with the pitman. It will be noticed there is a small recess at the top and bottom to receive a cross pin or nail, which passes through the saw blade and serves to keep the blade from slipping through the clamp. The lower bracket is securely bolted to the arm, whereas the upper one is adjustable forward or rearward, according to the width of the saw blade used. The pitman is made of hard wood.

A small pneumatic or bellows is secured to the table, and is operated by the movement of the lower arm 13. It is connected with a small rubber hose terminating in close proximity to the saw blade so that the sawdust will be blown away from the line or mark which the cut is to follow.

Now for ordinary work the operator is seated on the saddle, and treads the pedals, having his hands free to manipulate the work, but in case the work should be so large that the operator could not use the saddle, he may stand at one side of the machine and operate the saw with the hand by using the handle 16 on the flywheel, while with the other hand he can guide the work under the saw. A suitable guide may be attached to the table for straight work.

Tool Grinder.—The tool grinder consists of an old bicycle hub, 26 (Fig. 50), to which is soldered a suitable leg or support, 27, made of say $1\frac{1}{2} \times \frac{1}{8}$ -inch iron, which is fastened to a hinged block, 28, with wood screws. To the central rod of the bearing is fastened a small pulley on one side, and an emery wheel on the other. The block is hinged to the main table, and held in upright position with a sliding bolt 29, which is pushed under the block, when the emery wheel is in use.

When the wheel is not in use the bolt 29 is withdrawn, allowing grinder to swing downward, as indicated by dotted lines in Fig. 50. In this position it will not interfere with the free movement of the work on top of the table. The emery wheel is driven by a small belt from the flywheel 15. The wheel should run

about 1,000 revolutions per minute, but of course that is governed by the rate of pedaling.

Drill-Press.—Fig. 45 shows in dotted lines a portion of a small drill-press clamped to a rail, fastened to the under side of the table, and driven by a belt from the flywheel 15. The tool is shown to better advantage in Fig. 51. This makes a very handy

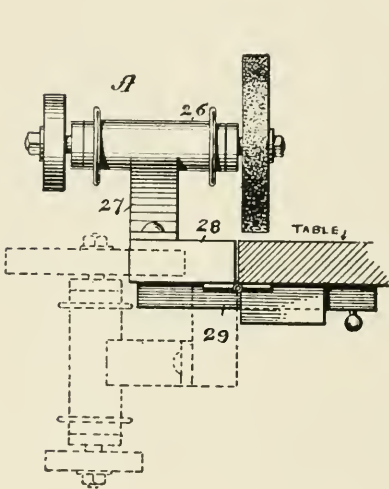

Fig. 50—Hinged mounting of the tool grinder

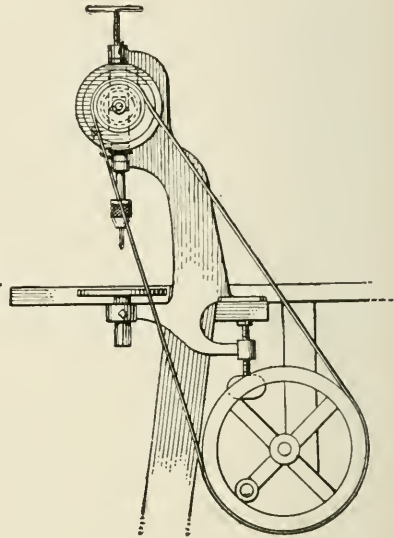

Fig. 51—The drill-press

and a convenient way to operate the drill. The drill-presses on the market generally have an arrangement for changing the speed, and almost any speed on the drill may be obtained.

Router.—The router or molder consists of a small cutter head, 30 (Fig. 52), fastened with a set-screw to shaft 31, mounted in suitable bearings 32 and 33. To the lower end of the shaft is fastened a small bevel gear, 34, meshing with another, 35, mounted on a shaft, 36. The latter revolves in a bracket, 32 (see Fig. 47). At the opposite end of the shaft 36 is a small pinion, 37,

meshing with the gear wheel 11. The bracket 32 is made to slide up and down a short rail, 38, fastened to the legs of the table, and it may be held in position by a bolt, 39. Fig. 52 shows the train of gears in mesh and ready for operation. By unscrewing the nut of said bolt, the bracket may be moved downward, and will cause the gears 11 and 37 to separate, thereby throwing the device out of operation. The cutter head 30 should of course first be removed. It is now evident that by using different-shaped

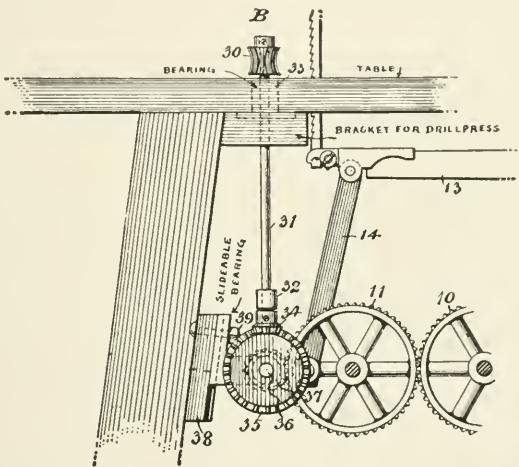

Fig. 52—The router or molder

cutter heads different moldings may be cut out. Of course a suitable guide must be used on the table to guide the work.

Grater.—The grater, shown in dotted lines at the lower right-hand corner of Fig. 45, consists of a box, in which is mounted to revolve in suitable bearings a shaft carrying on four extending arms two ordinary half round graters, soldered together, making a perfect circle. At the inner end of the shaft is fastened a gear-wheel, which meshes into the gear-wheel 8 on the rear hub 7. A suitable hopper is arranged at the top. This whole contrivance

may be slid out and in horizontally and removed when not in use. A photograph of the machine in use is shown herewith.—5

SCROLL-SAW GUIDE

The object of the device illustrated in Fig. 54 is to enable one to obtain a true edge with a scroll saw.

On the saw plate is clamped a semicircular guide, by means of two thumbscrews. The guide plate should be raised from the

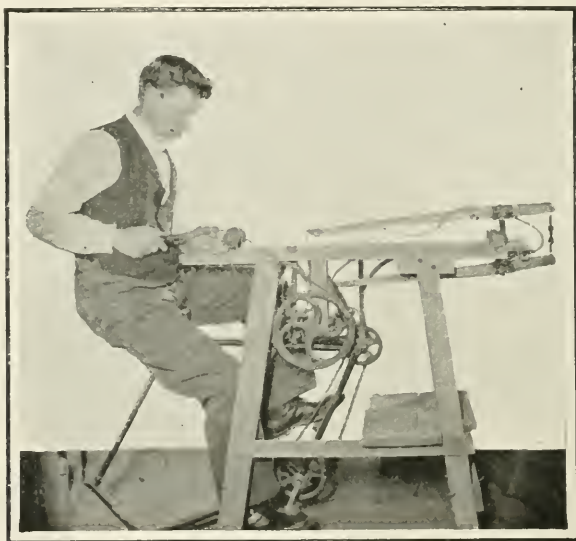

Fig 53—The complete machine in use

saw plate about $\frac{1}{8}$ of an inch by running several washers on the screws between the two plates, so that the article to be cut may be slid under the guide, as is hereafter explained. Two slots about 3 inches long should be made in the guide to receive the screws and permit adjustment of the plate.

A strip of $\frac{1}{4}$ -inch walnut about two feet long and one inch wide is procured and a quarter inch slot is cut in it, extending

nearly its entire length. A thumbscrew is fitted to run in this groove and engages a block which is adapted to slide along the under side of the strip. At one end of the strip a permanent block is fastened.

To make a straight cut in a board at any prescribed angle with one of its edges the walnut strip is fitted to it parallel to the line of the desired cut and so that the two opposite extremities of the

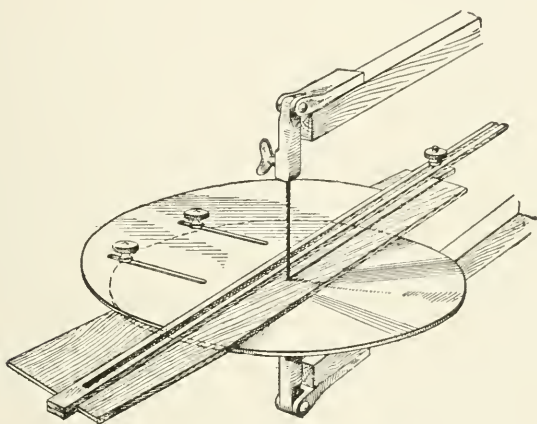

Fig. 54—Scroll-saw guide

board are clamped⁶ between the permanent block and the adjustable block. The guide plate is then clamped in position, its edge parallel to the plane of the saw, at such a distance that when the strip is placed against the edge of the guide, the saw will exactly coincide with the line to be sawed.—67

THE HOME-MADE DRILL-PRESS

Next to the lathe in importance comes the drill-press. While it does not cost nearly as much as a lathe, still its price would put a large hole in the average amateur's capital. Below is the description of a small drill-press made by the writer out of a cheap breast drill.

The breast drill *A* (Fig. 55) is fastened to a block *B* of 1-inch pine with two iron bands. The block in turn is fastened to a heavy round pole *D*, such as portieres are hung on, about 5 feet long, with 2-inch screws. This pole runs through two guides *CC*, which have holes bored in them to receive it. In order to prevent the pole from turning, a $\frac{1}{2}$ -inch dowel pin is split in two, and one half is fastened to the pole, as indicated at *D*.

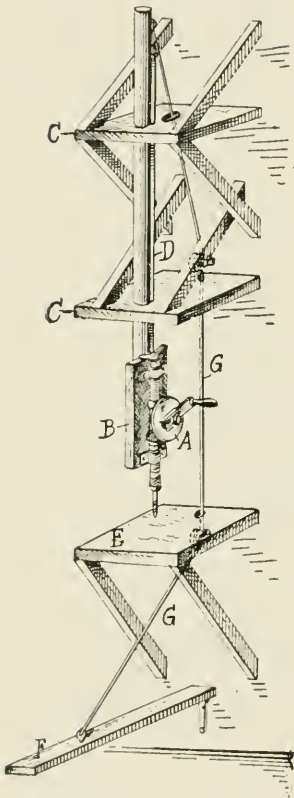

Fig. 55—The handy man's drill-press

The hole in each guide *C* for the dowel to slide in is bored before the larger hole is cut and has its center on the circumference of the large hole. The guides *CC* are strongly braced to keep the drill true. The face plate *E* is made of a pine block $1\frac{1}{2}$ inch thick.

The drill is held down to its work by pressing on the pedal *F*. This pedal is hinged to the wall. It is connected to the top of the drill part by a rope *G*, which runs through two pulleys, as indicated in the illustration.

The drill-press, breast drill and all, was built for about two dollars and gave very good service.—57

The drill-press, breast drill and all, was built for about two dollars and gave very good service.—57

MITER BOX

Beech, a strong and durable close-grained wood, should be used in making a miter box. Make the box of 1-inch stuff, planed down to $\frac{7}{8}$. The length will vary according to whether the 60-degree miter cuts are used, in addition to the 45-degree and the right-angle cuts, in which case the box should be about 30 inches in length.

One of the sides and the bottom are made of 6-inch wide material, the other side being 7 inches wide, so that it will project below the bottom of the box 1 inch, forming a ridge to bear against the workbench when sawing.

The positions of saw cuts should be laid out very accurately in pencil first, and when sawing them care must be taken to keep the saw over the pencil lines in the horizontal and vertical lines. The

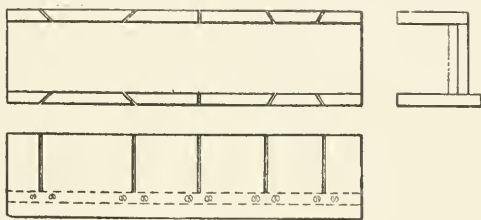

Fig. 56—Construction of the miter box

sides should be secured to the bottom with screws or nails at points each side the saw cuts. It is a very good plan to lightly tack a narrow board to the bottom of the box, as indicated by the broken line, to protect it from the wear of the saw.—3

A CARPENTER'S CLAMP

For holding work together while being glued or nailed, a

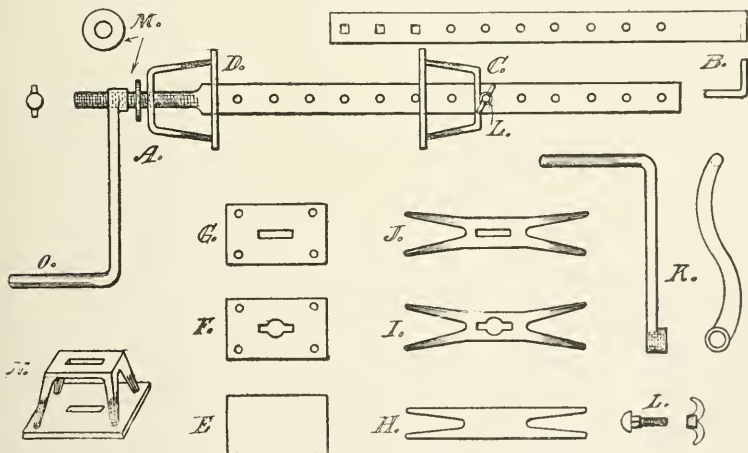

Fig. 57—Details of the carpenter's clamp

clamp of some description is indispensable. The one herewith illustrated has the advantage of being easily made by a blacksmith or the mechanic himself.

In Fig. 57, *A*, with the extension *B*, shows the clamp complete. The extension *B* is used on large work, such as door frames. It is about 20 inches in length, after the end has been turned up, as shown, $1\frac{1}{2}$ inches. The first three holes are made square, to bite the thumbscrew *L*, by which it is connected to the body *A*. The clamp is made of $1\frac{1}{2}$ by $\frac{5}{16}$ -inch wrought iron. *A* is 30 inches long, including the threaded end, which is $\frac{3}{4}$ inch diameter by 6 inches long. The holes are made to suit the thumbscrew *L*, $\frac{3}{8}$ inch diameter. The stops *D* and *C* are identical, except that *D* has the slots rounded out to pass over the threaded end of the clamp, as shown in detail at *I* and *F*. Two plates are cut out as shown at *E*, 5 by 3 by $\frac{1}{4}$ inch, and four holes bored in the corners, $\frac{1}{4}$ inch diameter. A slot is cut in the center, large enough to slip easily over the body of the clamp. As already stated, in one case this slot must be rounded out in the center to pass over the threaded end of the clamp. Two pieces *H*, 3 by $\frac{1}{4}$ by 9 inches, are cut out as shown, the legs being 3 inches long, and tapered down to $\frac{1}{4}$ inch diameter. The legs are spread to suit the holes in the plates *F* and *G*, into which they are riveted, after being bent into shape as indicated in the sketch marked *N*.

The crank *O*, detailed at *K*, is made from a $\frac{5}{8}$ -inch diameter bar about 15 inches in length; the part forming the handle being $4\frac{1}{2}$ inches long. A boss one inch long is formed at one end, and threaded to suit the end of the clamp *A*. A washer *M*, to take up the wear, and a thumbscrew *L* complete the list.—3

TWO HANDY CLAMPS

The small clamps illustrated in Fig. 58, being of exactly the same size and shape, are a very handy thing to have in the workshop.

To make them, select two pieces of machine steel just large enough to finish to the size of the U frame of the clamp as shown, namely, $2\frac{1}{4}$ by $1\frac{1}{2}$ by $\frac{1}{2}$ inches. The two broad faces of each piece must be filed to as nearly a plane surface as it is possible to

get them, having each piece $\frac{1}{2}$ inch thick. Test the surfaces by placing the pieces together, and carefully mark the two faces which fit the best with a small file cut on one edge of each surface.

The two pieces are now to be sweated or soldered together,

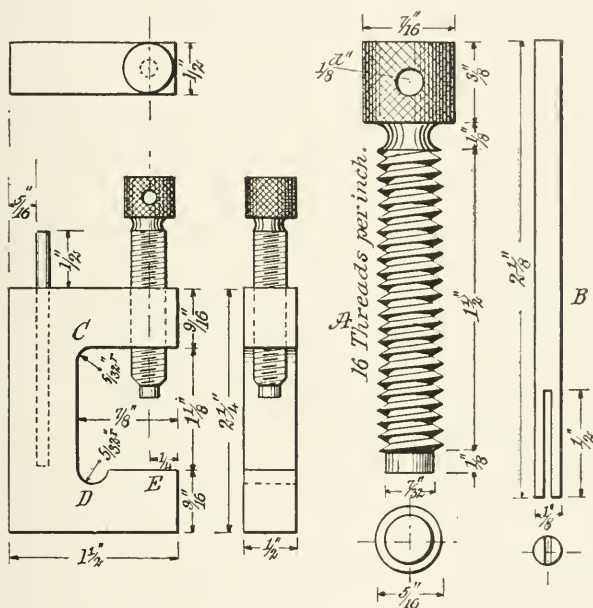

Fig. 58—Two handy clamps

having these two marked surfaces next to each other. This is done in the following manner: Heat the pieces until solder will melt upon them, then cover each of the marked surfaces with soldering acid and rub on a coating of solder. Place the two pieces with the solder-covered faces together, and clamp them firmly. Heat again until the solder runs together, then allow them to cool slowly. Upon removing the clamp you will find that the two blocks of steel are firmly fastened together, making one solid block.

Next true up the edges of the block, making all angles right

angles. This gives you a neat block of steel $2\frac{1}{4}$ by $1\frac{1}{2}$ by 1 inches. Be sure to make the angle between the sides which will form the back and the bottom of the clamp a right angle, so that holes at exactly right angles may be drilled in a piece of work without removing it from the clamps by first drilling with the clamps in an upright position, and then turning them so that they rest upon their backs, and drilling the second hole.

Now we come to cutting out the inside of the clamps. Lay off the shape of the clamp as shown in Fig. 58, and drill a series of $5/16$ -inch holes extending from *C* to *D*, locating the two end ones as shown in the drawing. Make two hack-saw cuts from the front edge, one to *C* and one to *D*. File the surfaces thus formed to the guide lines, making sure that the surface at *E* is parallel to the bottom.

The next thing is to drill and tap the holes for the screws. These holes are located in the center of each clamp, that is, $\frac{1}{4}$ inch from each of the broad faces and $\frac{1}{4}$ inch from the front face. These holes must be drilled and tapped for a $5/16$ -inch screw. Drill the hole in the back of the clamp to hold the pin *B*. This hole should be $\frac{1}{8}$ inch in diameter, and located in the middle of the top face of each clamp, $5/16$ inch from the back edge. Drill to a depth of $1\frac{5}{8}$ inches.

Separate the two clamps by heating until the solder holding them together melts.

The bodies of the clamp are completed now, except that they may be polished by rubbing with emery cloth and oil. In polishing, great care should be used not to get the angle between the back and bottom faces out of true.

The screws are turned from a piece of $7/16$ -inch steel rod. The shape and all dimensions are given in the drawing (*A*, Fig. 58.) United States standard threads are the best to use, as their edges are less liable to break under strain.

The round top of the screw is knurled, and a $\frac{1}{8}$ -inch hole drilled through it for the clamping bar to fit into. This clamping bar is made from a $\frac{1}{8}$ -inch bar, and is $2\frac{1}{8}$ inches long. A hack-saw cut is made in one end to a depth of $\frac{1}{2}$ inch. This bar

must be rubbed down with emery cloth until it will fit loosely into the hole drilled for it in the back of the clamp. When a sliding fit is obtained, the bottom of the bar must be sprung a little by forcing the sides of the hack-saw cut apart. This will prevent the bar from slipping out of the socket when placed in it.

If a good grade of steel is used, the screws may be hardened by heating evenly to a cherry red and cooling in water.—22

A QUICK CLAMP

A quick method of clamping a piece of work to the drill press or any table in which there are the usual holes for such a purpose is often a time saver.

The accompanying illustration shows a quick clamp, which can be made of metal for machine-shop use or of wood for the carpenter's bench.

The piece *B* is made L-shaped and is pivoted on the point *F*. The piece *C* is provided with a set screw, which rests against the heel of *B*. The shank of *B* is dropped through the hole in the bench, and the work placed under *C*, care being taken to have the piece *B* sloping back out of the vertical. Pressure on the set screw *D* locks the work under *C* in a very short time, and unscrewing releases it at once.—22

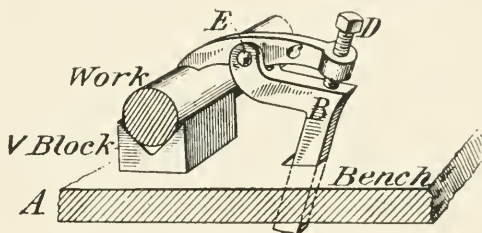

Fig. 59—A quick clamp

THE SAW CLAMP

The majority of saw clamps on the market are either secured to the workbench by means of a thumbscrew clamp or other adjustment, or they are held in the vise—an arrangement having several bad features, which are overcome by the clamp here described. With this clamp it is unnecessary to take out the saw, or unscrew the vise, when changing off to file the other edge of the teeth. Instead, the clamp and framework is turned around

bodily. It can be moved from place to place, to a good light, or wherever most convenient, since it is not dependent upon a vise or bench for its support. The clamp being longer than the width of the vise, takes a better grip upon the saw; and the simplicity of clamping it (without the usual adjustment by means of a screw or pin) recommends it.

The framework may be made of light wood; the 4 by $\frac{3}{4}$ -inch pieces being let in flush with the face of the $1\frac{3}{4}$ by $3\frac{1}{2}$ -inch side bars, to stiffen it. To prevent the 4-inch slot for the saw split-

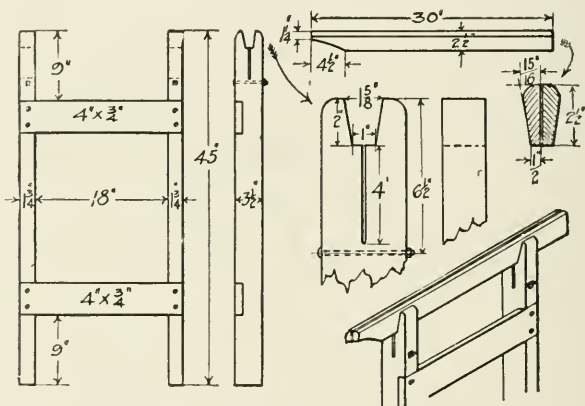

Fig. 60—Convenient clamp for saws

ting down when the clamps are driven in, a bolt is put through $6\frac{1}{2}$ inches from the top, as indicated in Fig. 60.

The clamps should be hard wood, 30 inches long, shaped out as detailed. The $4\frac{1}{2}$ -inch recess, to allow for the saw handle, should be cut when the two clamps are together, since this makes them right and left handed. When making the two clamps, the taper should be obtained before the edges are rounded off, as shown in broken lines.

The lower right-hand corner sketch shows the clamp in the framework without the saw. When necessary to set a saw, it is dropped in the 4-inch deep slot, teeth up, the two clamps wedged

into place on each side of it being driven home with a mallet or hammer.—3

AN IMPROVED SAW CLAMP

The saw clamp described above is of service in the workshop, but the following is a modification used by carpenters and others when the facilities at hand are limited.

Oftentimes when one wishes to file a saw while away from the shop and has no filing clamp at hand, he is at a loss to know how to hold the tool during the operation. A handy expedient is to take a board or joist and turning it on edge, end on,

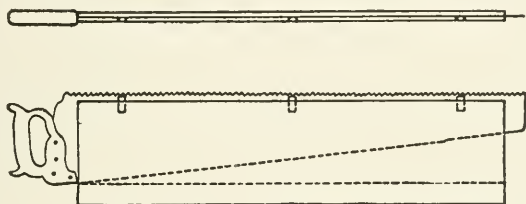

Fig. 61—Handy saw filing clamp

make a cut with the saw to almost its depth. Then place the saw in the cut, teeth uppermost, and drive in several small wedges along one side. This always holds the saw nicely, and the whole may be nailed to a step, sill, or part of the framing, or may be placed in a carpenter's vise. To loosen the saw, strike the top of its handle with the hand.—72

HOME-MADE SAW FILING VISE

Desiring a saw-filing vise that would allow an ordinary saw to be filed or set from end to end without change and without chattering, to hold the saw rigidly and yet so that it could be instantly released, the writer made a device as follows: In the barn loft there was a south window with a good light. To the 3 by 4 studding at each side of the window and at right angles to it, at a convenient height, two pieces of wood 1 by 12 by 12 inches were firmly nailed, thus forming two brackets. Two pieces of straight 2 by $\frac{1}{4}$ -inch flat iron, long enough to go across these

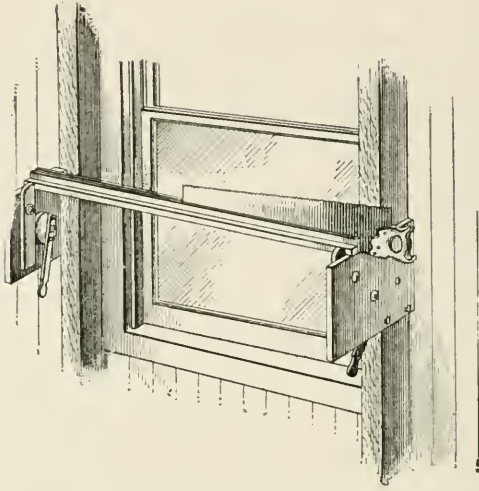

Fig. 62—The saw vise attached to a window frame

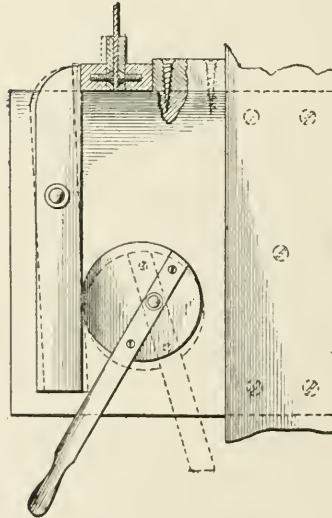

Fig. 63—Cross-section showing the cam

brackets, were found, also two straight pieces of 1 by 1-inch iron (discarded square-bed carriage axles with stubs off). The latter pieces were faced with the flat iron by means of a couple of countersunk-head stove bolts. Two pieces of 2 by 2-inch angle iron would have done as well. These made the two jaws of the vise, and they were placed across brackets in front of window, with a wooden strip between the inside jaw and the studding to take the file thrust. On the inner side of each bracket a lever of $1\frac{1}{4}$ -inch square hardwood was pivoted, with the upper end bearing against the outer jaw. Two circles of wood were cut and

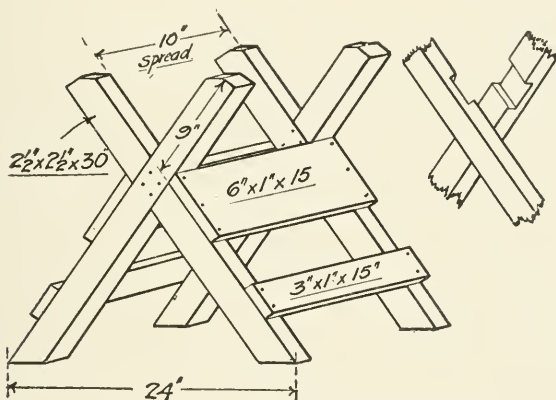

Fig. 64—The handy man's saw buck

mounted on bolts in the brackets, but an inch off center, so that they could be used as cams to press against the lower ends of the lever and force the upper ends firmly against outer jaw, thus clamping the saw firmly in place. A handle was secured to each cam, with which to tighten and release the vise.—61

THE SAW BUCK

The handy man's saw buck may be made from $2\frac{1}{2}$ or 3-inch stuff, 30 inches long, half-jointed, 9 inches from one end, as shown, the feet being spread 24 inches out to out. Battens, 6 inches by 1 inch, with the top edges bearing squarely against the

legs, secure the latter together, 10 inches apart inside measurement. A 3 by 1-inch strip at the bottom on each side serves as a foot rest.—3

TRESTLES, HORSES, OR STOOLS

They go by either of these names. Though simple enough, and at first thought almost unnecessary to refer to, it will be found by observation that few mechanics have a perfectly-built trestle.

The length should be twice the height. The 3 by 4 piece should be on edge, and it should bear squarely upon the end boards, which in turn should be secured to the legs with screws or nails. The

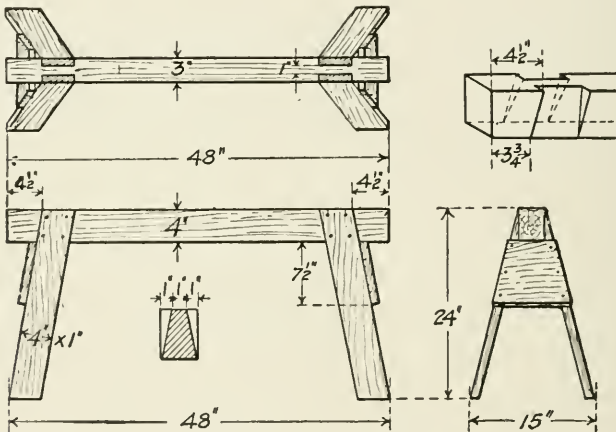

Fig. 65—A well-built trestle

legs should slant in two directions; their bearing location longitudinally being in line with the ends of the 3 by 4 piece, as shown in Fig. 65, so that the trestle will not tilt. Full dimensions for construction are given on the various views, and need not be repeated in the text. The notches for the legs are shown in larger scale views, and are dimensioned in such a manner that no trouble need be experienced in cutting them out.—3

A ROLLER JACK

For moving heavy timber and other uses, a roller jack will be

found very handy. It is easily constructed, any amateur being able to do the blacksmithing required. The framework should be made of oak or heavy tough wood; the roller of pepperidge or sour gum, a wood which will not easily split. The bottom face of

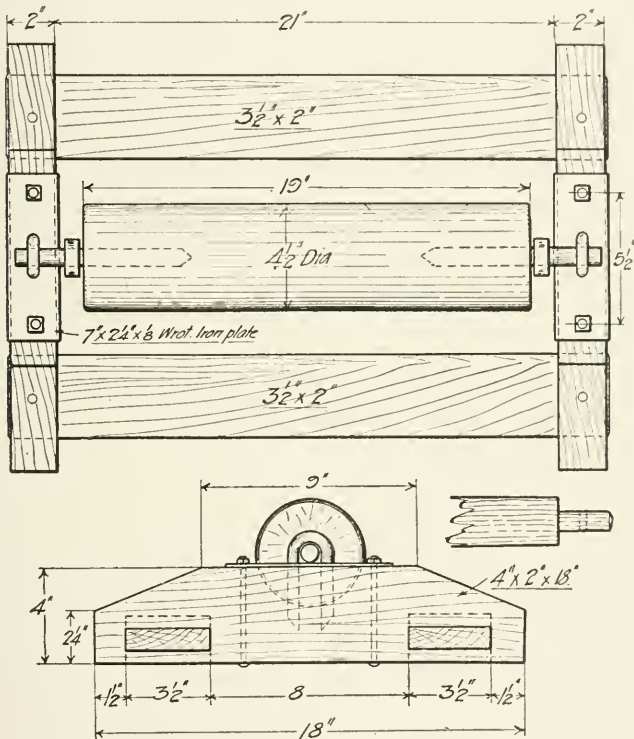

Fig. 66—Plan and end views of the roller jack

the framework is in the same plane, in other words lies flat on the ground at all points.

The general dimensions are given in Fig. 66. The 3 1/2 by 2-inch braces should be connected to the side pieces with mortise and tenon joints, and secured in place with wooden drift pins.

Wrought-iron plates are bolted to the upper face of the sides, for the roller axles to wear on. These plates should project over the sides a little as shown, to take the wear of the washers on the axles. These washers are made from staples bent around the axles, which are three-quarters of an inch diameter, round iron. The axles are round at one end and square at the other; the square end being driven into the roller with a driving fit. The bearing ends of the axles are $\frac{3}{4}$ inch in diameter.—3

A STEAM BOX

It is sometimes necessary to bend or twist wood into various shapes to suit certain work. Long or short strips, and even planks,

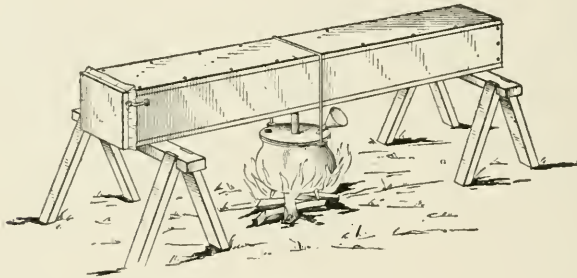

Fig. 67—The steam box in use

can be made very pliable by steaming them from half an hour to an hour in a cheaply-constructed box, like the one illustrated. The size of the box will naturally depend upon the class of work to be operated upon. Boxes all the way to 35 feet in length by 3 feet square have been made for bending planks in boat building. For ordinary work, however, a box 10 to 12 inches square by 8 to 12 feet in length will be ample.

The box is made of inch boards, nailed together with ten-penny nails, about 6 or 8 inches apart, with one end closed permanently, and the other either furnished with a hinged lid and two side catches, or left open entirely. When the latter scheme is resorted to, either an old piece of carpet, burlap, or hay can be used to close up the end. Even when the hinged lid is used, it is well to use

a piece of burlap as indicated. An ample-sized pot is furnished with a wooden lid, which is made to fit the opening tightly. A hole is cut in the lid of the kettle, and the bottom of the steam box, with a compass saw, large enough to take a piece of pipe $1\frac{1}{2}$ to 2 inches in diameter.

The pipe must fit very tightly. It must be of sufficient length to prevent the box from coming too near the fire; say 4 feet from the ground.

The kettle is suspended from the middle of the box by means of a strong wire or chain over a fire. The wooden lid is furnished with an opening for a funnel to supply the kettle with water. The opening is closed with a tight-fitting cork when the

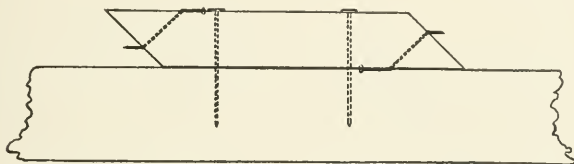

Fig. 68—Handy planing dog

funnel is not used. The box is generally placed outside the shop, within convenient reach, upon a couple of trestles or horses.—3

HANDY PLANING DOG

When away from the shop, and wishing to plane a stick which has beveled ends, and having no means at hand of resting the bevel against anything without crushing the point, simply cut a short piece, slightly thinner than the work, to approximately the same bevel. Drive a nail at right angles to the bevel till it protrudes one-fourth or three-eighths, bend this parallel with the edges of the piece, and then bend the head of the nail down flush with the stick. This last bend prevents the nail turning. Nail this piece to a step, sill, or floor, rest the end of the piece to be planed against the nail point, which acts precisely like a bench dog, and the piece may be firmly held.—72

CHAPTER II. SHOP KINKS

THE CLOTHESPIN ON THE HANDY MAN'S WORKBENCH

Even so commonplace an article as a clothespin can be put to use in the workshop of the resourceful amateur. The accompanying illustrations show how. Fig. 69 illustrates a clothespin compass. A large pin is passed through the head to form the

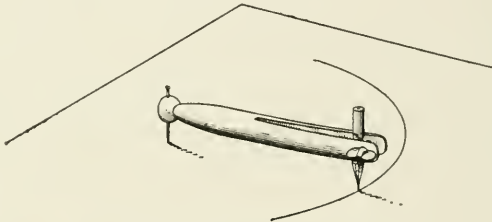

Fig. 69—A clothespin compass

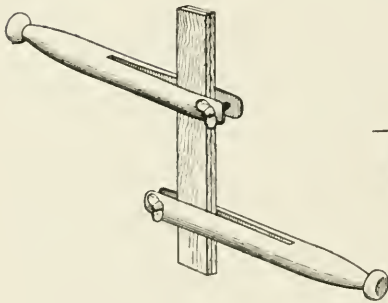

Fig. 70—Clothespin clamp

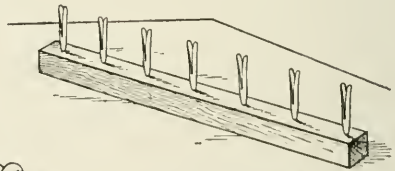

Fig. 71—Tool rack made of clothespins

pinion. A pencil slightly flattened is inserted in slot of clothespin and is clamped in place by a setscrew. One side of the clothespin may also be graduated so as to enable one to set the compass for any size of circle without the use of a rule.

Clothespins make very good clamps to hold small work to-

gether for matching holes, etc. The ends are drawn together by thumbscrews, as shown in Fig. 70.

By fitting a number of clothespins in a wooden block as in Fig. 71 a convenient tool rack or file for order blanks, cards, etc., is made.—14

A SIMPLE METHOD OF CONSTRUCTING A HANDLE

The accompanying illustration shows a simple method of constructing a neat and strong handle for a box, or a drawer. The handle is fashioned from two similar shade roller brackets which are fastened in place by means of screws at the points where the handle is needed. A piece of pipe or tubing is posi-

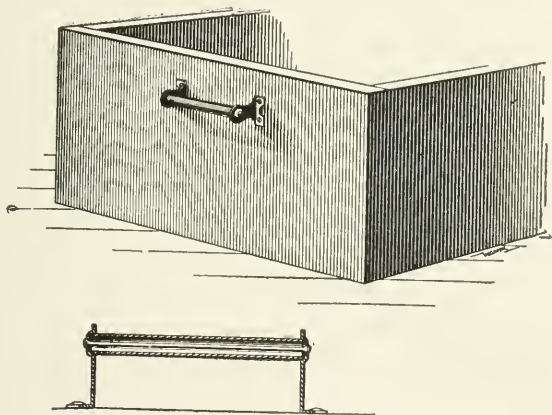

Fig. 72—Handle made of shade roller brackets

tioned between the brackets and is held in place by a stiff wire or other rod which passes through the tubing and the openings in the brackets, having the ends hammered down or riveted at the outside of the bracket. The tubing may be of brass or any other suitable material adapted for the purpose, and preferably tending to add to the appearance of the handle. The ends of the tube should be inserted in the concavities of the brackets, as is shown most clearly in the sectional view.—55

CONVENIENT HOLDER FOR SANDPAPER

In sandpapering woodwork of irregular shape the paper is laid over a stick of wood and used practically as a file. For holding the paper the writer has often used a simple holder for different kinds of work with satisfactory results. The holder consists of a stick, preferably of pine wood, of the required shape and size and tapering slightly toward one end. Into the narrow end saw a slot in the center to about two-thirds its length. Cut off a piece of sandpaper wide enough to go around the stick,

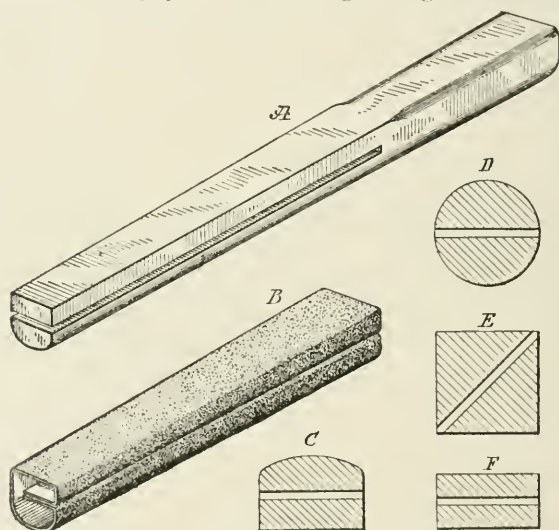

Fig. 73—Convenient holder for sandpaper

allowing a liberal margin to fit into the slot. Fold the paper so it can be slipped into the slot and around the holder from the end; pull it down until it fits snugly, when it is ready for use. Emery cloth can be used in the same way for polishing parts of machines and the like.

In Fig. 73 the holder is shown at *A*, and the paper folded ready to apply at *B*. The sections *C* to *F* suggest some shapes that may be used.—91

HOW TO FILE ROUND WORK

It is an easy matter to file the ends of round rods if a piece of wood with a notch cut in the top is placed in the vise, as shown in the cut, and the rod revolved toward you as the file is run over it. The file will make a steady, smooth cut, and will not chatter if the notch is of the right depth. This simple trick seems to be but little known. Usually the mechanic tries to rest the rod he is filing between the partly open jaws of the vise, but this makes

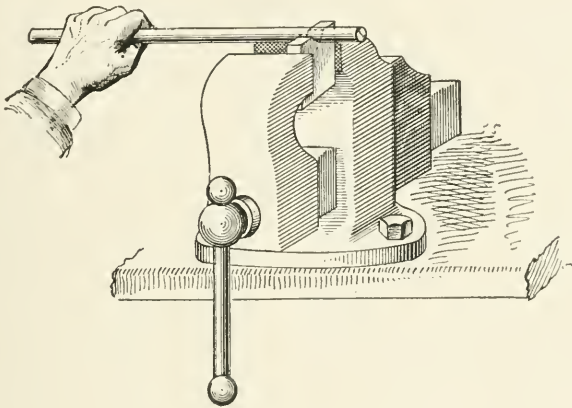

Fig. 74—How to file round work

a very unsatisfactory, chattering support, which is quite sure to mar the work.—82

VICE FOR POLISHED PIPE

A very good way to hold pipe or rods that have a polished surface is to sprinkle dry plaster of Paris on heavy paper and roll the article to be held in the paper, taking care that there is plenty of the plaster between the paper and the pipe or rod. Place the roll between blocks of wood having a hollow face, and clamp firmly in an ordinary bench vise. If upon removing the paper the plaster is found to adhere to the pipe in hard cakes, do not try to scrape it off, but wash the pipe in clean water, which will loosen

the plaster and leave the surface in a perfect condition. Another

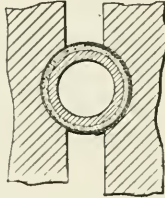
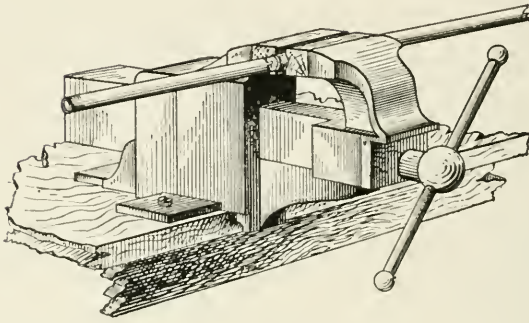

Fig. 75—Vise for polished pipe

method is to place the pipe between pieces of lead sprinkled with plaster, and use a pipe vise for a clamp.—82

THREAD CUTTING WITHOUT A DIE

It sometimes happens that the threads of a bolt or a pipe break off and must be cut without the aid of a screw-cutting die. This can be accomplished very easily with the aid of an ordinary half-round file and a little patience.

Take a block of wood and fasten it in a vise. Make a V groove in the block deep enough for the center of the pipe to come a little below the surface. If the pipe is long, it will be better to make two of these blocks, so as to keep it steady. Now into this groove place a pipe with thread same as wanted, and on one side of the block drive a nail. Place the flat side of a half-round

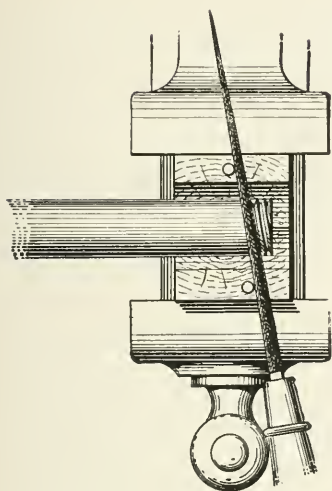

Fig. 76—Thread cutting without a die

file against this nail and see that it forms the same angle with the pipe as the thread does. Then drive in another nail on the opposite side of the block, so that it will touch the flat side of the file. Now remove the pipe and replace with the one to be threaded. Hold the file with the smooth side against the nails and while filing keep turning the pipe. The pipe should be rocked backward and forward. That is to say, on the forward stroke of the file turn the pipe in the opposite direction, thereby insuring a much better thread.—5

HOW TO WIND A SPACED COIL SPRING

When it is desired to wind a spring with the coils spaced a uniform distance apart, a simple method is to use a former or guide, made of wire which is as thick as the space desired, between the coils. The accompanying cut shows how this is done. The guide consists of a few coils which are spaced the requisite distance apart, and one end of the wire projects outward tangentially. The spring is then wound on the arbor between the turns of the guide. As the wire is fed on the arbor it is crossed over the extending end of the

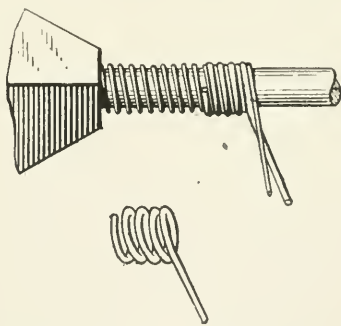

Fig. 77—How to wind a spaced coil spring

guide, in the manner shown, so that it presses inward against the coils of the former. As the arbor is turned the guide is automatically fed along the arbor, and the coils of the spring are uniformly spaced by the coils of the former.—51

ANOTHER METHOD OF MAKING A COIL SPRING

Get a metal rod the same diameter as the spring desired; drill

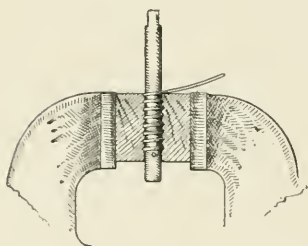

Fig. 78—A simple method for making a coiled spring

a hole near the end to admit the end of the wire. Give the wire two or three turns around rod, spacing the turns according to the desired pitch. Clamp it between two blocks of hard wood in a vise, having the rod in the direction of the grain of the wood. Revolve the rod by means of a monkey wrench fitted on the flattened end of the rod. The wire will follow in and wind a spring as true and perfect as though it had been wound with a lathe.—26

HOME-MADE SPRING WINDER

Not long ago the writer was called upon to replace a broken spring in a machine. It had to be done at a moment's notice, as the work could not be held up. The supply of springs was exhausted. The writer was given a piece of No. 60 wire, but no one had such a thing as a winder, so he was obliged to make one, and had a spring within a half hour.

In a junk pile was found a piece of soft steel, 4 by 1½ by ½ inch wide, with a ½-inch hole in one end. A ½-inch lag screw was placed in a brace, a pinhole was drilled in the gimlet end of the screw, then putting the screw through the hole in the steel, which was held in a vise, the spring was easily wound.

This suggested the construction of the spring winder illustrated herewith. A piece of soft steel, 4 by 1¼ by ¼ inch, forms the body. A ½-inch shank, fitted with a chuck taking from 0

to $\frac{1}{2}$ inch, was run through the hole at the top and provided with a crank handle.

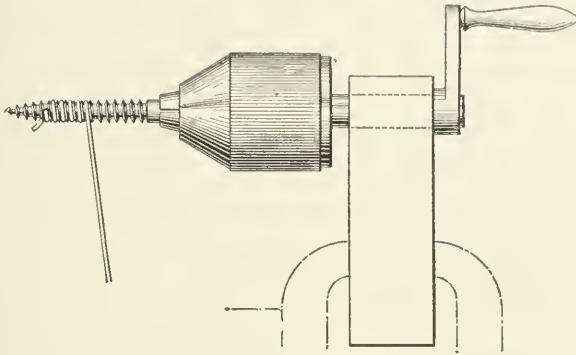

Fig. 79—Home-made spring winder

An assorted lot of lag screws serves for the open springs, and rods are used for the close springs and springs of oval or odd shapes.—14

SUBSTITUTE FOR ROD THREADER

For a rod threader for quick and accurate work on rods from $\frac{1}{16}$ to $\frac{3}{8}$ inch in diameter, all one needs is a bench or blacksmith's drill, with a three-jawed chuck. Clamp the rod to be threaded in the chuck of the drill. Place the die in the holder as usual, hold the die against the end of the rod to be threaded, and turn the drill at slow speed. Those who try this method will find it a much quicker and better way than threading by hand in the usual manner.

HOW TO MAKE A SCREW AND NUT WITHOUT THE AID OF A SCREW-CUTTING LATHE

When the nut and screw in the handy man's hand vise are worn out he can repair them as follows without using a screw-cutting lathe: First file the old spindle smooth. Then take two pieces of soft square iron, *a* and *b*, the size of the thread, and pin them to the spindle, as shown in Fig. 80. Now wind these iron bars around the spindle as tightly as possible. Under the bar *b* place

a small wire *c*, and wind it between the spindle and the bar, thereby raising bar *b* above bar *a*. As the bar *b* is to form the thread

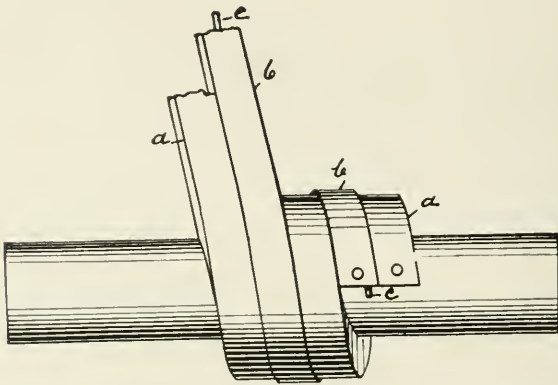

Fig. 80—Wrapping the spindle with soft iron

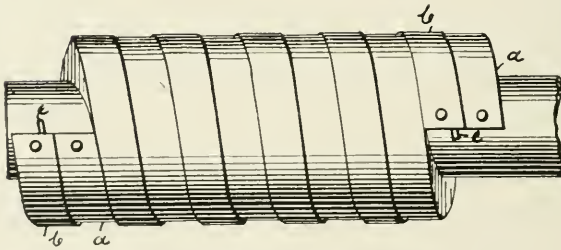

Fig. 81—The two threads coiled on the spindle

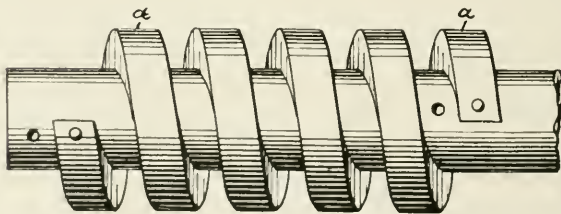

Fig. 82—The finished spindle

in the nut, it allows for some fitting, for it is to be attached to the inside of the hollow cylinder. When the required length is wound around the spindle, the ends should be pinned to the spindle, thereby holding the bars securely. (See Fig. 81.)

The inside of the cylinder should be painted with black lead. Now, when the screw is forced into the hollow cylinder, the black lead will adhere to the outside of same, and will show just where they touch each other. Now take the screw out and file off all these marks, and repeat the operation until a good bearing is

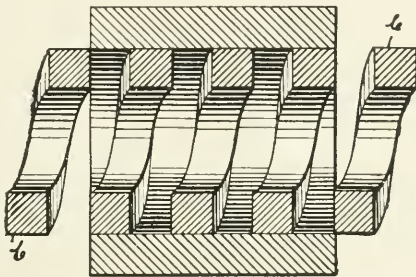

Fig. 83—Section showing thread in nut

obtained all around the screw, that is to say, until the screw touches all around the cylinder. The threads and the hollow cylinder should both be marked so that the threads can be replaced in exactly the same position each time.

Now remove the two pins in bar *b* and insert the screw as before, but drive it in tightly with a hammer. Then unscrew the spindle with the thread pinned to same (see Fig. 82) and it will be found that bar *b* has stuck to the inside of the hollow cylinder, as in Fig. 83. With a hack saw cut off the projecting ends. A couple of small pins may be driven through the cylinder and thread, thereby keeping the thread from shifting. Also a pin here and there may be put in the thread in the spindle. The screw and the nut must now be brazed with copper, as it is stronger than ordinary spelter.—5

SUBSTITUTES FOR A PIPE WRENCH

The accompanying illustration represents an improvised pipe wrench, very simple, yet effective, one that will fit the largest or smallest pipe. It may be used on brass or iron pipe, without marking or defacing the same.

A sling or a short piece of rope is passed around the pipe three or four times, as shown in the illustration, leaving a short loop in the middle. Into this loop is inserted a short piece of pipe or a stick far enough to pass the center of the pipe. The loose ends of the rope are held tight with one hand, while the short

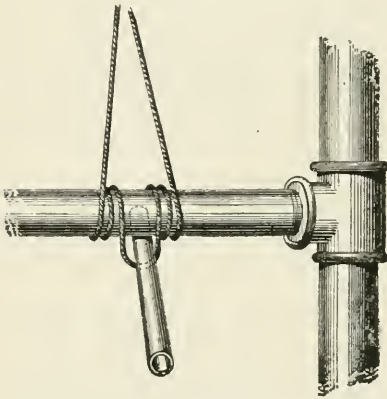

Fig. 84—Pipe wrench which will not mar the pipe

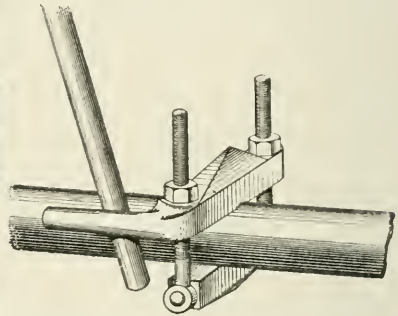

Fig. 85—A lathe dog as a substitute for a pipe wrench

piece of pipe or stick is held in the other. Now the tighter the loose ends are pulled, the tighter the rope will hug the pipe, and it will be possible to exert quite as much pressure on the pipe with this arrangement as with an ordinary pipe wrench, although this will depend largely upon the strength of the rope. The rope may of course be doubled or trebled, according to the size of pipe to be screwed home. When working on polished brass or steel pipes, a little resin may be put on the rope, which will increase the friction, or one or more turns around the pipe will answer the same purpose.

Another improvised pipe wrench consists of an ordinary lathe dog secured to the pipe. The turning of the pipe may be done with a monkey wrench or a short piece of pipe or a stick inserted between the shank of the lathe dog and the pipe.

In close quarters, of course, the dog will have to be opened and turned on the pipe little by little.—5

AN IMPROVISED PIPE VISE

Fig. 86 shows how a pipe or the like may be held in an ordinary vise while being threaded. An ordinary pair of pipe pliers are used to hold the pipe and these in turn are held between the

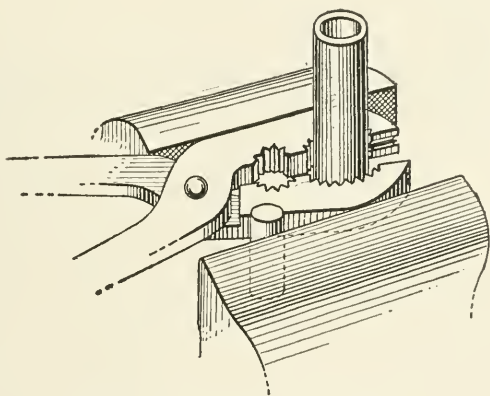

Fig. 86—An improvised pipe vise

jaws of an ordinary vise. On large pipes a vise with swivel jaws would be preferable, but an ordinary vise will answer the purpose by putting on one end of the pliers a small rod or the like to conform with the angle of the pliers and the jaws of the vise. This, of course, is done to relieve the rivet in the pliers from unnecessary strain.—5

AN EMERGENCY PIPE VALVE

The following may be of use to the handy man in an emergency. It is a simply-constructed pipe valve:

Take a piece of pipe *A* of the required size and bore a hole *B* in it at right angles. This hole must be of the same size as the internal diameter of the pipe *A*. Take a round piece of iron or brass the same size as the hole *B*, and cut threads on one end. File it to a flat diamond shape at *D*, and file the top square for a wrench as at *E*. Put a pin through it at *F*, letting it project on both sides. Put a washer on just below the pin, and run the

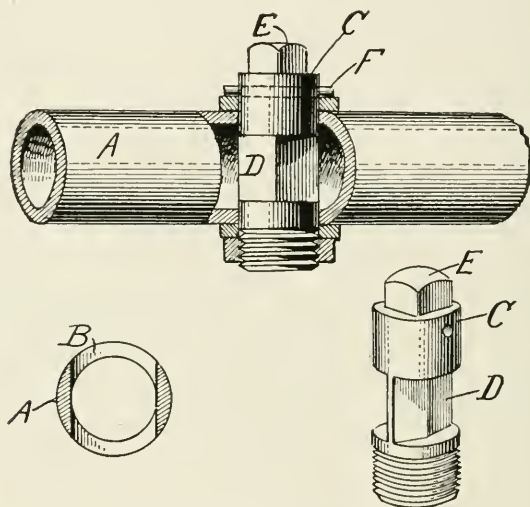

Fig. 87—An emergency pipe valve

rod through the hole. Put on another washer on the projecting end, and screw a nut on it. This will answer very well in an emergency, and will be found very durable.—92

A BOILER MAKER'S TOOL BAG

When the boiler maker gets a rush order for repairing a boiler he gets busy. Quickly converting his overalls into a tool bag, he drops in half a dozen chisels, expander, hammer, etc., and then he is ready for action. In making the bag he places the overalls full length on the floor, folds one leg up and lays it

on the seat of the overalls, then rolls the two very tightly together, criss-crosses the suspenders and ties them on the part which appears in illustration. He then puts his hand inside the leg left full length and grasps the roll and turns the whole thing inside out. This completes the bag, which is ready to receive the tools.

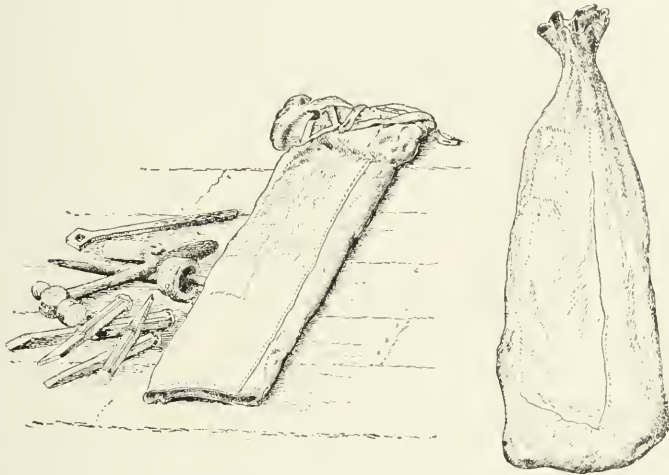

Fig. 88—How to convert a pair of overalls into a tool bag

These, of course, come against the outside of the overalls, leaving the side that comes next to the garments as clean as ever.—(6)

A STRONG HOME-MADE TURNBUCKLE

Requiring some small turnbuckles which would stand a sudden strain, the writer hunted through the hardware stores of New York without success. None small enough could be obtained having the left and right hand bolts cast in one piece to the rings at their ends. A buckle with bolts made of wire threaded at one end and bent into a ring at the other opened the moment a load was applied. Those with a swivel at one end were not better, for in every case the riveted neck of the swivel pulled out.

Finally the buckles were made at home. As small left-hand

taps and dies were only to be obtained, and not promptly, from the factory, the following method was pursued: A dozen turnbuckles were required, and so two feet of $\frac{3}{8}$ -inch Shelby steel tubing, No. 13 gage, and one foot of $\frac{1}{2}$ -inch No. 11 gage was bought, also one dozen $\frac{1}{4}$ -inch bolts and nuts, and one dozen $\frac{1}{4}$ -inch nails with heads $\frac{1}{8}$ inch thick. The material cost seventy-five cents.

The material was cut into required lengths and each piece *B* was counterbored with a $\frac{3}{8}$ -inch drill to slip over the end of *A*. The head of the nail *C* was filed to fit the counterbore, and after inserting it in *B*, its end was flattened and a hole drilled as shown. *B* was then riveted to *A* at *D*, using a $\frac{5}{32}$ -inch wire nail. The other end of *A* was tapped for the right-hand bolt *F*, the end of

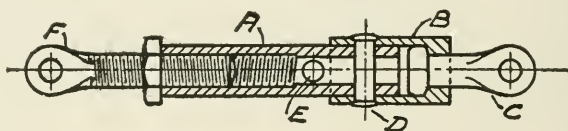

Fig. 89—A strong home-made turnbuckle

which was flattened and drilled like the nail *C*. A $\frac{5}{32}$ -inch hole *E* was drilled for a pin or nail for tightening the buckle.

The whole twelve were made, entirely by hand, in nine hours, or forty-five minutes each.—52

A UNIVERSAL JOINT OF SIMPLE DESIGN

Most universal joints on the market have at least a dozen different parts. One which has a big sale at present has no fewer than seventeen distinct parts, not including the shafts or feather keys for adjustment.

The universal joint illustrated in Fig. 90, which was designed on account of the high price asked by some of the standard makers, and which has given every satisfaction for the rough purpose for which it was intended, has but two jaws, two pins, and one washer or distance piece, shown in plan and elevation on the right.

It will be noticed, however, that this design is imperfect, in that the two pins, which cross each other at right angles, are not in the same plane. To improve upon this, and also to reduce

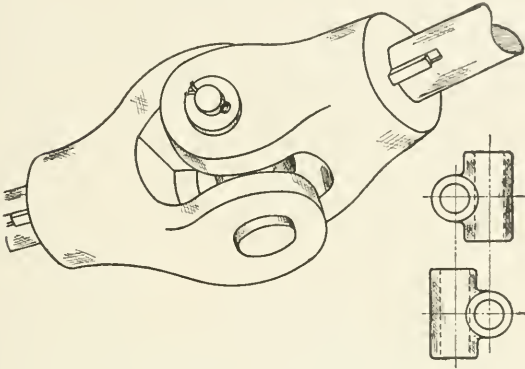

Fig. 90—A two-pin universal joint

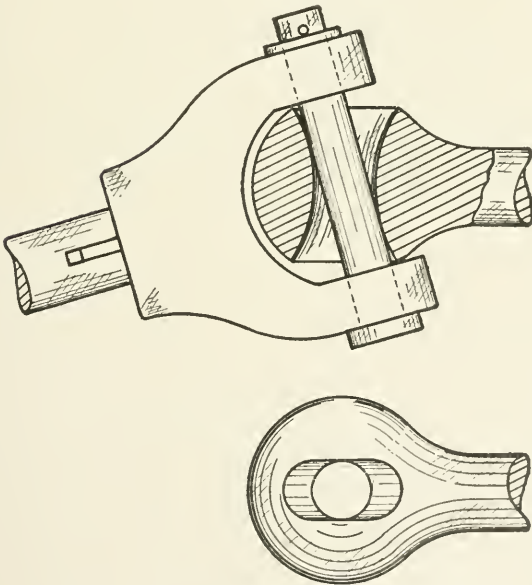

Fig. 91—Universal joint with round pin and slot

still more the number of parts, the writer designed a joint as shown in Fig. 91. A model was made and so far it seemed successful.

The model was shown to a well-known engineer, who, while commending the idea of reducing the number of parts, pointed

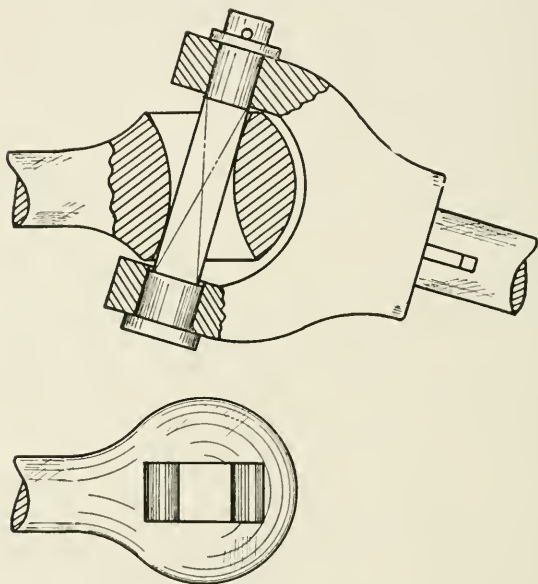

Fig. 92—The square pin universal joint

out the bad feature of the design, in having a round pin wearing on a flat surface.

The writer tried to rectify this by having a square slotted hole instead of a round one, and a square shaft or pin with a round hole through, for the main pin. This he found would require so much fitting that the cost would bring it up to the standard price.

In Fig. 92 a design is shown which has not been put to a practical test, but is open to criticism. The slotted round hole shown in Fig. 91 has been changed to a slotted square hole.

One end of the pin is the same in diameter as the diagonal of

the square body. The other end of the pin is the same in diameter as the side of the square.

There is no reason, however, why the square body of the pin could not be continued to the end, and fitted into a collar or bushing, the inside hole of which is a square tight fit, and the outside a loose round fit, to enable it to revolve as the other end of the pin.—3

A SELF-LOCKING DOVETAIL JOINT

The accompanying engraving illustrates a self-locking double dovetail which cannot be pulled off in either direction. On one

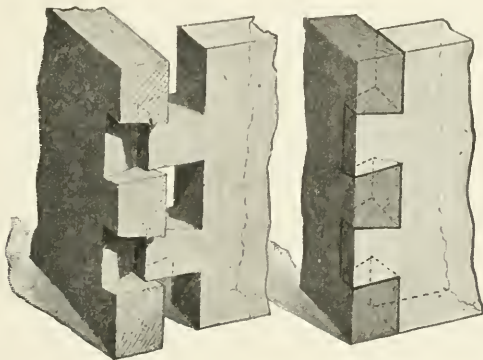

Fig. 93—The self-locking dovetail joint

of the pieces the tenons are chamfered at the inside while the grooves on the other piece are formed with a correspondingly chamfered inner wall. The corners are joined not by forcing one side piece at right angles to the other, but by placing the side pieces within the ends of the end pieces and then bringing the corner joints into place by moving the side pieces diagonally outward. A box thus constructed cannot pull apart without first crushing in the sides, as this is the only direction in which the tenons of the side pieces may be moved out of engagement with those of the end pieces.—18

TO REPLACE A BROKEN SCREW IN SOFT METAL

When a screw breaks off in a brass or other soft-metal plate, dig it out in the usual manner, and, whether the thread in the hole is injured or not, a screw a trifle larger can be quite easily fitted, without the use of a tap, in the following manner: Leave just enough of the thread intact to tap the hole. Harden the point of this improvised tap by heating it over a gas jet and dipping it in water. Now work the screw in the hole like a tap, and when the desired fit has been reached cut off the tap end, and you have a good screw left. The writer has fitted several screws in this way, two being in a brass plate over $\frac{1}{8}$ inch thick.—14

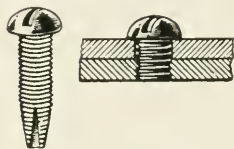

Fig. 94—Improvvised tap

THE DRIVING OF A NAIL

The driving of a nail is deemed so simple a matter, that inability to do the job is often spoken of as though typifying entire lack of mechanical ability; yet it may be that some skilled mechanics have something to learn in regard to this elementary operation. It usually takes a woodworker's apprentice a year or more to learn that he doesn't know how.

A fledgling mechanic, who spoke sneeringly of a man whom he heard using several blows of the hammer to drive a single nail, was somewhat crestfallen when told that the nail would hold better when driven "home" by several light taps, than when driven by one heavy one.

"Why?" he asked, in surprise.

"Because," said the other, "when you drive a nail home with a heavy blow, it is apt to rebound a trifle, loosening the grip of the wood fibers on it. Drive it *almost* down, if you will, with as hard blows as you wish, but finish the job with several light blows."

One who thinks that the driving of a nail simply consists in getting the whole length of it out of sight, has little conception of the real nature of the operation. A nail driven by an expert

will often hold several times as much as one ill driven; while, too, it is often made to draw the parts into place. If you have ever watched a mechanic driving nails, you have doubtless noted that he rarely drives one at right angles with the face of the work. There is a reason for this. Suppose that he is nailing the "sheeting" on the frame of a building, and desires to draw the board down tightly against the one below it; he points the

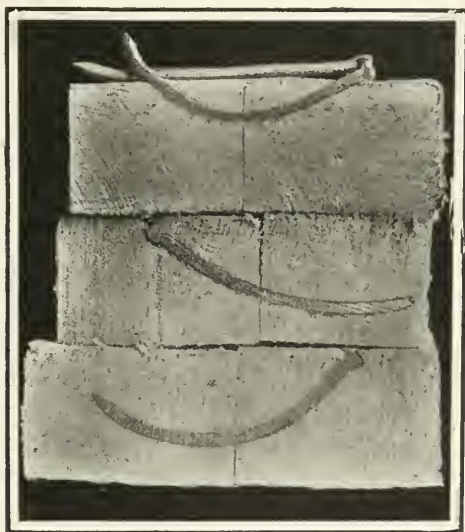

Fig. 95—Nailing a butt joint

nail downward, and a few well-considered blows at the last produce the desired effect. If the board is bent edgewise, so that much force is required, probably he will start the nail in the upper edge, pointing very sharply downward. Again, two nails driven in a board at different angles will hold it in place much more firmly than the same nails would if they were driven in at right angles with the face of the board.

Did you ever notice that, in driving a nail in very hard wood, one man will do it successfully, while another succeeds only in doubling the nail up before the point has fairly entered the wood? The difference lies in the fact that the expert strikes the nail fairly, and not too hard, "coaxing" it in; while the other strikes too hard and with indirection. It may be mentioned, right here, that in driving a nail into very hard wood, it is usually profitable to dip the end into oil or grease. This will not sensibly interfere with the holding qualities of the nail, while it will very materially facilitate its driving.

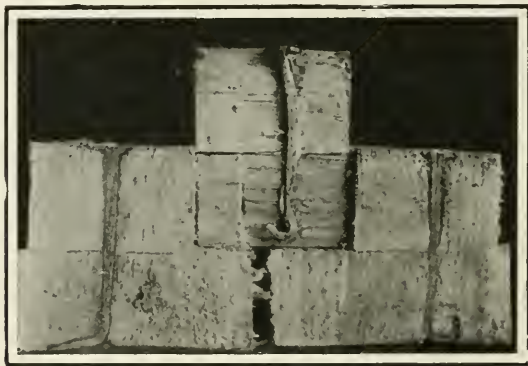

Fig. 96—Methods of clinching a nail

In order that a nail may hold its best, it is necessary that the pieces it penetrates should be in close contact. A few well-judged taps of the hammer at the finish will serve to bring about this contact; while a heavy, ill-judged blow often destroys it, on account of the rebound.

So, too, the direction in which a nail goes is governed, not merely by the direction in which it is started, but very largely by the shape of the point. You have doubtless noticed how a horseshoe nail, by having a chisel point, is made to swerve and

to come out of the hoof but little above the shoe. By filing the point of a nail off on one side, it may readily be made to take a curved course in driving, or the same result may be attained by bending the point slightly with the claws of the hammer. The photograph, Fig. 95, shows how two boards may be secured, edge to edge, by nails bent in this way.

In driving a clinch nail, there is room for the exercise of some skill. In Fig. 96 the central figure is that of a clinch nail driven down onto a hard surface, thus being driven and clinched at the same operation. It will be noted that it is bent in the middle, "crippled," thus loosened in the wood and deprived of much of its holding capacity. At the left and right are nails which were first driven through the wood, and had the points bent over afterward, while a heavy hammer, or the like, was held against the head. The one on the left was carelessly bent, leaving a clinch which will straighten easily; while the one at the right was first bent over a trifle at the extreme point, then hammered firmly down. By the latter method, it will be seen, the point is driven into the wood, and thus more securely held in place—30

TO PREVENT THE NAIL FROM SPLITTING THE WOOD

All who have had occasion to drive a nail through a thin or narrow strip of wood, especially near the end of the piece, have encountered the difficulty of preventing the wood from splitting, which will invariably occur unless a hole is bored, or the piece sufficiently clamped.

Fig. 97 shows a nail prepared to overcome this difficulty. As can be readily seen, the point of nail is clipped off with a pair of cutting pliers, leaving a straight edge the full width of the nail. Then, by applying the nail across the grain of the wood, as shown, a safe drive is assured.—50

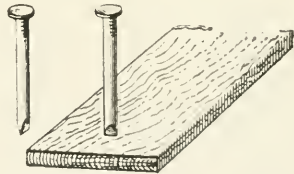

Fig. 97—A chisel point prevents wood from splitting

REMEDY FOR LOOSE WOOD SCREWS

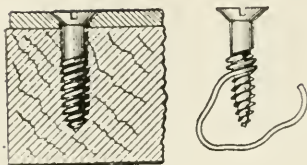

Fig. 98—Remedy for loose wood screws

A convenient method of making a loose screw hold is illustrated herewith. Take a soft piece of copper wire, and wind it around the threads of the screw as shown, thus in effect increasing the diameter of the threaded part. This will save plugging or using a larger screw.—60

WEATHERBOARD GAGE

It is customary, when cutting off weatherboarding, to fit up against the corner strips of a frame house, to use the long square or carpenter's rule. The square is sometimes held along the edge of the weatherboard, or down the side of the corner strip. Either method necessitates carrying the square along, or fetching it from where it was laid down.

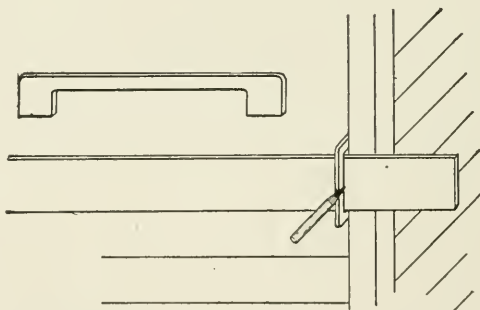

Fig. 99—Gage for cutting weatherboards

One-quarter the time can be saved, saying nothing of the convenience gained, by making a little gage, as illustrated in Fig. 99, from a piece of board about 9 inches long and 2 inches wide, which can be carried in the nail or apron pocket. The notch in the piece is $6\frac{1}{2}$ or 7 inches in length and about 2 inches deep.

The weatherboard is held in position, the end not shown being set up firm against the last board in the same row, the other end extending beyond the corner strips. The gage is slipped over this end of the board, and held firmly against the inside face of the corner strip, while a pencil line is quickly drawn across the board as it is held against the gage. The saw cut is made a little inside the pencil mark.—3

A LADDER EXTENSION LEG

A painter or any other mechanic is sometimes called upon to paint or repair work which is very unhandy to reach. Perhaps a ladder is to be supported in some manner upon a slanting roof of a shed, or other building. Such a case happened very recently, when the following scheme was adopted by a mechanic with success:

A ladder, *A*, was supported from the peak of the shed roof by means of a plate, *B*, bent in the shape of a hook. Two painter's hooks would do just as well. The plate, *B*, was about 8 or 10 inches wide and 3 feet 6 inches long before being bent. The grip on the roof peak should not be less than 6 or 8 inches. The second or working lad-

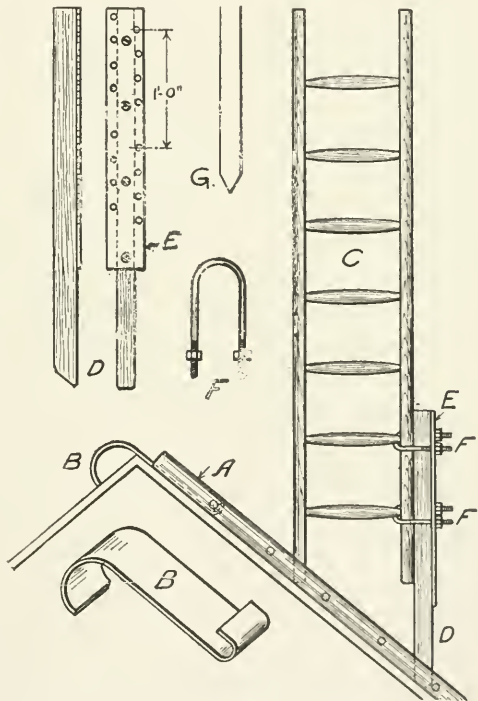

Fig. 100—How to support a ladder on a roof

der, *C*, was supported on the first ladder, *A*, by an extension leg, *D*, made of 4 by 3 timber of tough quality. The foot of this leg, *D*, was shaped as shown in detail to fit against the rounds of the ladder on the roof. A plate, *E*, furnished with a number of holes for a couple of U bolts, *F*, was screwed down to the leg, *D*. The holes were staggered, and spaced $2\frac{1}{2}$ inches apart on each side, allowing adjustment of $1\frac{1}{4}$ inches each way, to accommodate different pitch of roofs. The distance apart of each group of holes in the plate, *E*, should equal the distance apart of rounds of the ladder, usually 1 foot, so that the rounds of the ladder will bear on the U bolts, which should be drawn up tight when the proper adjustment has been made.

If the extension leg were made of steel, of smaller dimension than the timber one, furnished with a sharp point, *G*, to stick in the shingles of the roof, the ladder, *A*, and hook, *B*, could be dispensed with.—3

A PAINTER'S PLATFORM BRACKET

When painting the side of a house or a building, it is not always convenient to rig up a platform, supported from the eaves or roof. It may also be a one-man job, in which case a platform of that nature would be inconvenient anyway.

The following contrivance has been used with every satisfaction. In Fig. 101 is a view looking at the under side of the ladder, to show the bracket in use. The plank stretches across to a similar contrivance, attached to a second ladder, not shown. One end of a plate is cut as

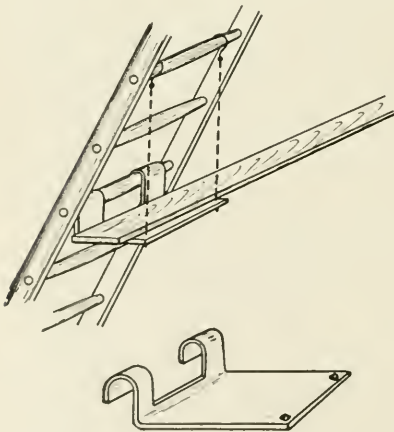

Fig. 101—A simple support for a light scaffold

shown in the detail view, and bent into the shape of a hook, to fit over the rounds of the ladder. Two holes are made in the opposite corners for the chains. The other ends of the chain are furnished with hooks, to reach the round of the ladder above the level of the platform.—3

PAPER HANGER'S ADJUSTABLE TEMPLET

This handy tool will be found useful, and will save considerable time, in cutting wall paper up the rake of a stairway or where

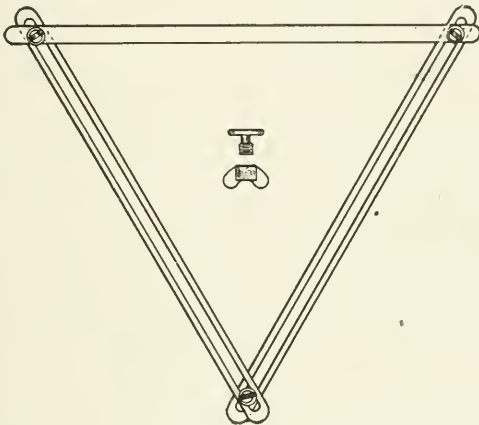

Fig. 102—Adjustable templet for paper hangers

any ceiling slants, allowing the paper hanger to cut a number of lengths of paper on the paste board at once, where at present it is customary to cut one only at a time.

The tool can be made of wood, and satisfaction obtained, although a better tool can be made from saw steel. Each blade is about three feet in length, two of them being furnished with slots, running almost the full length. Three thumbscrews, detailed on a larger scale, will be necessary to hold the frame together after the proper adjustment is obtained. The paper should be hung in position on the wall, and one side of the tool held along

the perpendicular edge of the paper, while one of the other sides of the tool is adjusted to suit the angle of the stairway or slanting ceiling, when the screws are tightened up, and the frame permanently set.—3

A GOOD SUBSTITUTE FOR LEATHER BELTING

An excellent substitute for leather belting can be made from a piece of ordinary fire hose, splitting it up the middle into two parts, i. e., two belts can be made from one piece of hose. The writer has seen this done on more than one occasion, with perfect satisfaction.

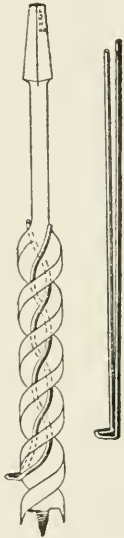

Fig. 103—Gage for augers

GAGE FOR AUGERS

When boring a number of holes to the same depth, it is of considerable advantage to have some means for marking positively the extent to which the bit should penetrate the wood. The accompanying engraving illustrates a very simple attachment for this purpose. It consists of a piece of soft iron or copper wire about 8 inches long, bent double and formed with a foot at the top end. Wind the free ends tightly about the auger as shown. The gage will be adjustable. When using be careful not to bring the foot into actual contact with the edge of the hole.—33

HOLDER FOR BROKEN SHANK DRILLS

A convenient drill holder that may be fitted to an ordinary carpenter's boring brace can be made as follows: Take a piece of soft steel about two inches long. File it tapered to fit the brace. Bore a hole in the larger end to a convenient depth and to size of drill to be held. File slot in side and to the center of the holder as shown, with the



Fig. 104—Holder for broken shank drills.

front edge of the slot flush with the end of the drill hole. Grind the end of drill flat at one side as far as the center, so that when the drill is placed in the holder the flattened end will project beyond the drilled hole and engage the bottom of the slot. With this device broken shank drills may be utilized to advantage.—26

SIMPLE DRILL CLEARANCE

When the drill pinches and squeals on drilling through pieces of wrought iron and copper, and is liable to twist off before you get the job done, why don't you swedge it? Use a small hammer, and be careful not to chip the corner, as the drill is swedged cold.

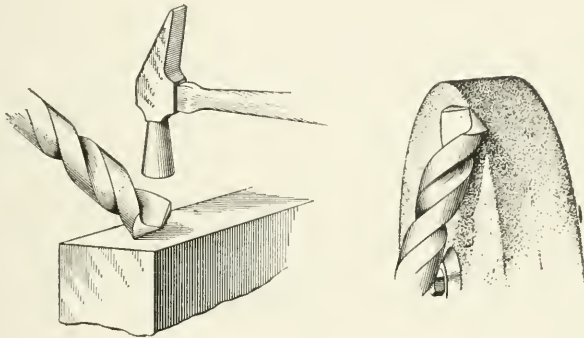

Fig. 105—A simple drill clearance

Just touch the fluted part lightly on the emery wheel, bringing back a nice cutting edge and leaving the swedged corner projecting a little. The writer has used this little wrinkle for a number of years, and masters those stubborn pieces with ease.—6

SIMPLE DRIVER FOR SMALL DRILLS

In an emergency the writer made a drill driver as follows: A piece of 3/16-inch square brass wire about 10 inches long was slit at one end with a hack saw, as at 2. The opposite end was filed to a blunt point 3. About 1/2 inch from this end a round section 4 was filed. From a piece of sheet brass a swivel 5 and the slide 6 were formed. The swivel was made with a socket 7

to receive the point. Notches 8 were filed to fit the round section. The slide was formed with a square hole to fit loosely on the wire. The lugs of the slide were slightly concaved, as shown. By holding one end of the wire in a vise and gripping the other

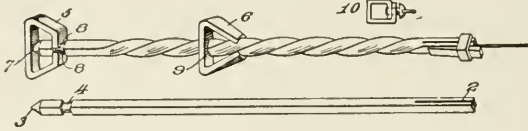

Fig. 106—Driver for small drills

with a wrench, the wire was twisted. A ring and wedge, as illustrated, formed an effective grip for the drill. A more practical grip might be made, as shown at 10. The two ends of this ring should be soldered. A slot might be filed in opposite sides of the twisted wire to receive the ring and prevent it from dropping off. This driver has done good service for nearly two years.—33

A GUIDE FOR DRILLING HORIZONTAL HOLES

A large washer makes a good level for drills, to show whether the hole is being drilled horizontally. Place the washer on the

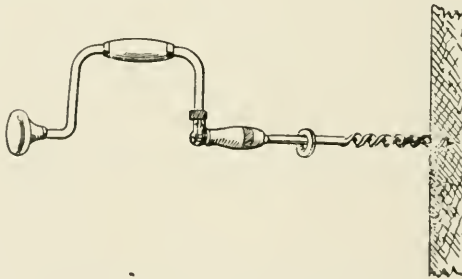

Fig. 107—A guide for the stock bit

shank of the drill or bit, and then if it feeds forward or backward while the bit stock is being operated it indicates that the bit is

tipped upward or downward, respectively. When the bit is held horizontal, the washer will remain stationary. The washer should be free from burrs, and the opening should preferably be turned true.

DRILLING HOLES IN MARBLES

Recently a man came to the writer and wanted a hole put through the center of some marbles. The accompanying sketch gives an idea of the way the work was accomplished. Through a piece of soft steel $2 \times 3 \times 1$ inches a hole was drilled of the size

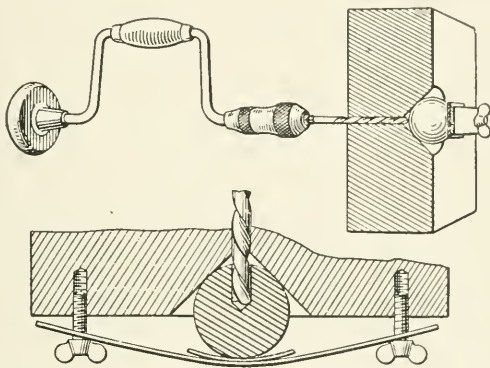

Figs. 108 and 109—A method of drilling holes in marbles

of the one wanted in the marbles. Then with a countersink a conical aperture was made in one side as illustrated. Two tapped holes, one above the other, below the aperture, admitted a pair of thumbscrews that secured a flexible strip made from the spring of an eight-day clock. On the strip next to the marble which was seated in the conical aperture a piece of emery cloth was placed. The whole was then held in the vise and the marble was easily bored.—14

A HANDY TAP WRENCH

A wrench for holding machine taps or reamers and the like can be easily made of a piece of flat steel and two machine screws;

if steel is not handy, iron can be used. Take a piece of stock of about $\frac{3}{8} \times \frac{1}{4}$ inch, and cut off two lengths of .5 inches each. Near the end of these pieces and about 1 inch apart, drill two



Fig. 110—Handy tap wrench

holes; $\frac{1}{4}$ -inch tap holes in one and clearance holes in the other. Centrally between the holes file V-shaped grooves about $\frac{1}{16}$ inch deep. Tap out the holes, and assemble the parts, using round-head screws of $\frac{3}{4}$ inch length. The ends of the wrench should be rounded for convenient handling. The dimensions herein given can of course be varied at will. Any size from the smallest to the largest can be made in this way.—91

AN EMERGENCY REAMER

It often happens, when there is a very important piece of work to be gotten out, the reamer of the size you want is broken, lost or under size. In a case of this sort the writer worked out the following reamer of simple construction, which may be useful to others: Use a piece of drill rod the size you are to ream the hole, place the desired length in a speed lathe, and crown the end. Then grind one side at an angle of about 10 deg. Care should be taken not to grind below the center, as the reamer will not follow true with the hole if the cutting edge is below center.—19

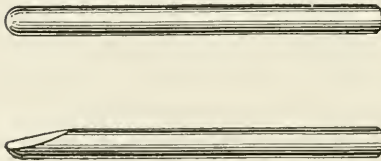

Fig. 111—Emergency reamer



Fig. 112—Drill for brick walls and soft stone

HOW TO DRILL THROUGH BRICK AND SOFT STONE

The accompanying illustration represents a very good drill for brick walls and soft stone. The drill is made of an ordinary gas

pipe and the end is serrated, which can be done with an ordinary half-round or three-cornered file. In boring a hole, the end of the drill is tapped lightly with a hammer and turned slightly after every blow.—5

THE HANDY MAN'S GAGE

The gage shown here is one of the home-made variety, that will work outside the limitations of the average store kind. It

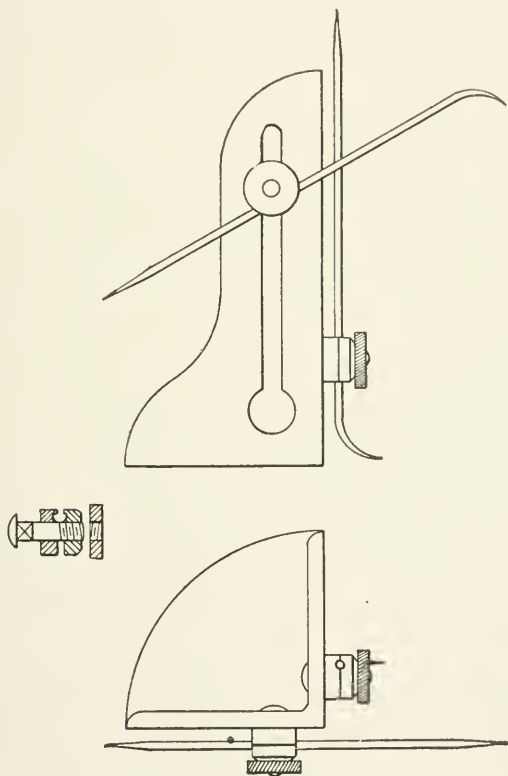

Fig. 113—Side and plan views of the handy man's gage

is easily and cheaply made, and will prove one of the most useful tools in the workshop.

The body is of cast iron, 4 inches high and $2\frac{1}{2}$ inches along the base at the sides. The base is $\frac{1}{4}$ inch thick, and the sides $\frac{3}{16}$ inch, and both sides and base are machined, so that they are

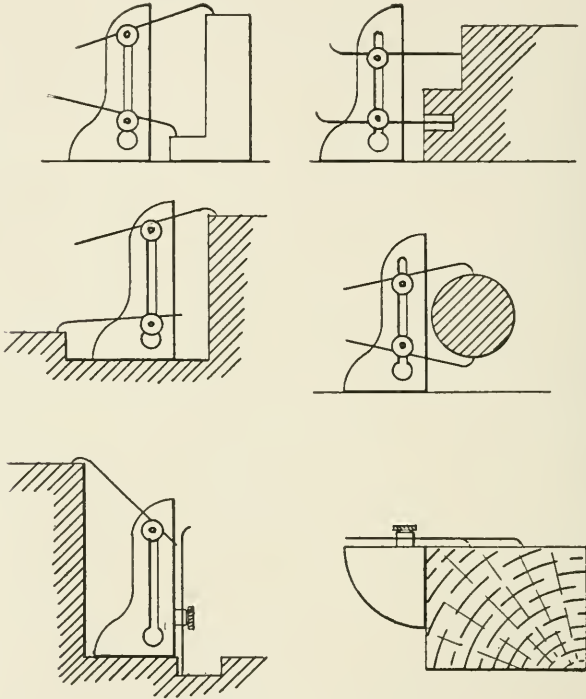

Fig. 114—Various uses of the gage.

square with each other; the body thus forms a handy squaring tool in itself. The scribers are 6 inches long, and are secured in position by passing them through split washers clamped together with a milled nut, as shown in the detail view. The hole at the bottom of the slots facilitates the removal of the scribers.

It will be seen by looking at Fig. 114 that the scope of this gage

is wider than most of those of the so-called universal type. It can be used as either a height or depth gage, giving two measurements in each case, or for height and depth at the same time. It is also an adjustable mortise gage, and can be used as a pair of dividers, as inside or outside calipers, and for a hundred other purposes that will readily suggest themselves to workers in wood and metal.—68

GRINDER AND HOLD FOR SMALL TOOLS

The writer was recently in need of a hollow tool handle with a three-jawed chuck that would take from 0 to $\frac{1}{8}$, but was unable to find one, although there are many kinds of tool-holders on the market. The effort to find a small grinder for awls, needles, etc., was vain. The following explains how

the tools were made with an outlay of but 50 cents and a little labor. In a pawn shop a hand drill was found with a chuck of the desired type. This was bought for 25 cents. The handle and the chuck were removed from the drill, and put together to

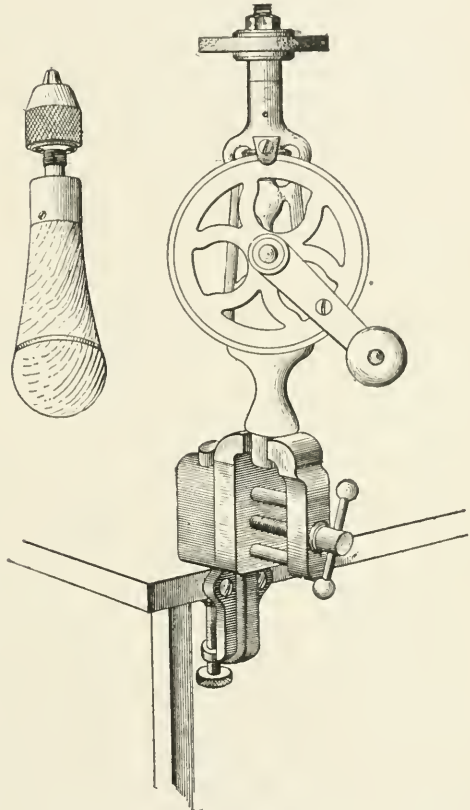

Figs. 115 and 116—Grinder and holder for small tools

form the desired tool-holder. Then for 25 cents a circular oilstone, 2 inches in diameter by $\frac{1}{2}$ inch thick, was bought. This was attached to the spindle of the drill, while the opposite end was squared, so that it could be held in a vise, as shown in Fig. 116. The grinder is used for awls, needles, etc., and the holder for the smallest of pins, awls, taps and the like.—14

DEVICE FOR PUNCHING HOLES IN SAW BLADES, CLOCK SPRINGS, ETC.

The device shown in side and end elevation at *A* and *B* respec-

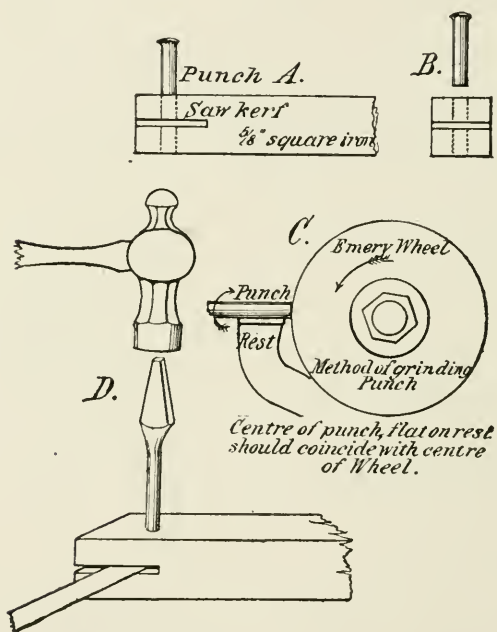

Fig. 117—Method of punching holes in saw blades, etc.

ively, is made from any old piece of iron or steel, the latter being preferable, as it can be tempered after it is made. The writer is at present using one made of a piece of $\frac{5}{8}$ -inch square iron some

3 inches long, which has a hole (the same size as the hole to be punched) drilled through it near one end. After drilling the hole cut down with a hack saw as far past the hole as will clear the material to be punched, care being taken that the hole is at right angles to the saw kerf. For a punch use the broken shank of a twist drill of the same size as the hole. This makes a very efficient punch, and the face of the punch is improved by carefully grinding it on a small $3\frac{1}{2}$ -inch diameter emery wheel in the manner shown at *C*; as by this means the face of the punch is slightly hollowed, and its shearing effect is increased.

The application of the device in punching a hack-saw blade is illustrated at *D*. This simple apparatus if properly made will do excellent work on saw blades and springs. The writer has in this way punched a $\frac{5}{32}$ -inch hole through the blade of a Disston rip saw without distorting the blade or raising a burr around the edges of hole. One can easily make several of these in different sizes, but for hack-saw blades $\frac{5}{32}$ inch is a suitable size. It is of course imperative that the punch be a good fit in the hole. The application of a somewhat heavy hand hammer is effective.—25

DEVICE FOR SAWING HOLES IN METAL

A large hole may be formed in metal by sawing instead of drilling. The tool is made of a piece of clock spring, cutting out the part, with the shears, that is already coiled, to about the size needed. A broad spring gives a better chance for attaching to the piece of hickory, which you have already turned with a little shoulder to back up the blade. Drill about six or seven holes in the clock spring, and attach with wood screws. Put a $\frac{1}{4}$ -inch center pin in the cutter end of the wood, and drive in a square shank at the other end for attaching an ordinary carpenter's brace. Holes can be easily drilled in the clock spring by hardening a small flat drill in soldering acid. Heat the drill dull red hot, and temper. It does not require drawing. Soldering acid is made by dissolving small crumbs of zinc in muriatic acid. Put in zinc until acid refuses to act. It is then saturated. File the teeth in clock spring, which should be swedged with a small hammer to

make clearance, then refiled. The writer cut two holes for $1\frac{1}{2}$ -

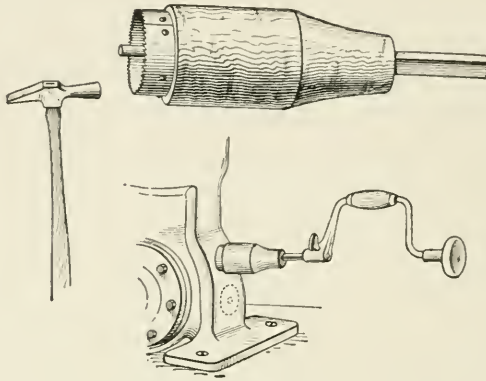

Fig. 118—Method of sawing holes in metal

inch pipe tap through cast iron $\frac{3}{8}$ inch thick in a gas engine bed in forty minutes with an ordinary carpenter's brace to revolve

the cutter, after a hole had been drilled for the center pin to follow. This tool will do larger work more easily than will a ratchet drill if not much thickness of metal is to be cut through.

—6

DEVICE FOR FINDING CENTERS OF ROUND WORK

This little device if carefully made will enable one to accurately determine the centers of round bars, disks, and in fact any object of a circular form. A piece of $\frac{3}{16}$ -inch square brass rod about 8 inches

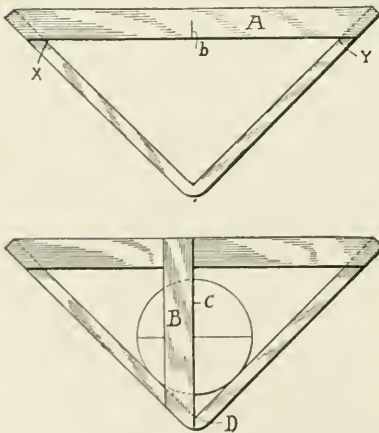

Fig. 119—Device for finding centers of round work

long is bent to form approximately a right angle, both legs being of equal length. A strip of brass, *A*, about $\frac{3}{8}$ inch wide and $\frac{1}{16}$ inch thick is soldered to the ends of the legs. Equidistant between points *X Y* make a mark *b*. Another brass strip *B* of same size as *A* is soldered in place as shown, being careful to have edge *C* exactly on the line *b* and over the angle *D*. Fig. 119 shows method of using the device. Simply place it on the end of the bar or shaft; make a mark with a scratch awl; give a quarter turn, and make another mark. The intersection of the lines will give the exact center.—86

HANDY METHOD OF FINDING THE CENTER OF A SHAFT

In Fig. 120 the circle represents a section of a shaft, the center of which it is desired to find. The corner of a square is placed on any point of the circumference. The points *A* and *B* are the intersections of the outer sides of the square with the circumference. Draw a line from *A* to *B*. Now shift the square a little, as represented by the dotted square, and with the corner on any other point mark the intersections *A'* and *B'*, then connect *A'* and *B'*, and the intersection of *AB* and *A'B'* will be the required center. It is necessarily the center, for it is the intersection of the two diameters.—74

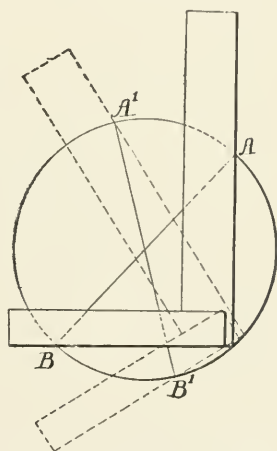

Fig. 120—Method of finding center of a circle

HOW TO SUPPORT A SHAFT WHEN BABBITTING

This is a suggestion for the simplification of the babbitting of crankshaft boxes, which has been used a number of times with entire satisfaction. Drill two holes about $\frac{1}{4}$ inch from the outside end of the box and in about the position illustrated. Tap the holes for small screws. Let the shaft rest on the head of these screws, which may be adjusted until the shaft is lined up.

After lining the shaft it may be taken out of the box and warmed before pouring the babbitt, preventing the metal from being chilled and forming an uneven surface. The shaft may be replaced while warm and the babbitt poured at once, the screws insuring a perfect line-up. The screws may be removed with a

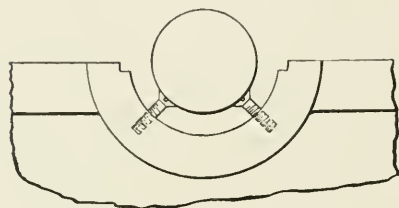

Fig. 121—How to support a shaft when babbitting

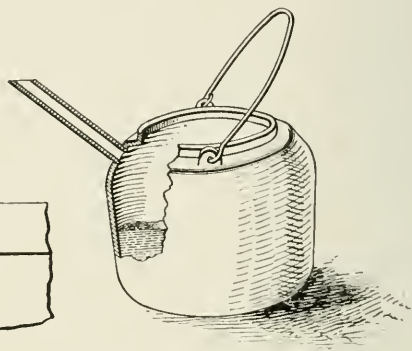

Fig. 122—Old glue pot as a metal pot and ladle

screwdriver when the babbitt has been poured, or they may be left in if brass screws are used.—44

OLD GLUE POT AS A METAL POT AND LADLE

A very handy metal pot for which no ladle is needed may be made by taking the outer part of a glue pot, and drilling a hole near the top, which is to be tapped to receive the threaded end of a piece of $\frac{1}{8}$ or $\frac{1}{4}$ -inch gas pipe. The opposite end of the pipe should be beveled to form a convenient spout.

With this device bearings may be babbitted which would be very difficult to get at with an ordinary ladle. The pipe forms a handle which may be seized with the pliers when pouring the metal. To preserve its usefulness as a glue pot, insert a cork or wooden plug in the end of the gas pipe.—82

A HOME-MADE MICROMETER

Get a common iron or brass bolt about $\frac{1}{4}$ of an inch in diameter and about $2\frac{1}{2}$ inches long, with as fine a thread as possible, and the thread cut to within a short distance of the head of the bolt. A bolt with a cut in the head for a screw-driver should be used. Clamp together two blocks of wood with square corners about 1 inch wide, $\frac{3}{4}$ of an inch thick, and $2\frac{1}{2}$ inches long, with their narrower faces in contact (the width of the clamped blocks being 2 inches), and bore a $\frac{1}{4}$ -inch hole through the center of the blocks in the 2-inch direction. Now remove the clamp, and

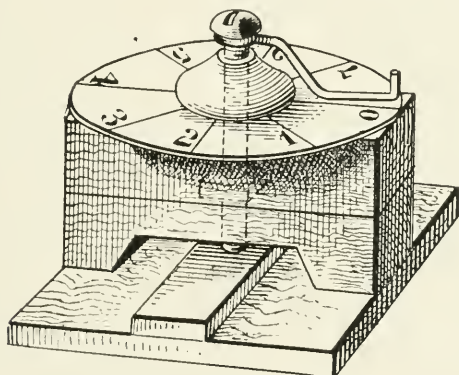

Fig. 123—A home-made micrometer

let the nut of the bolt into one of the blocks so that its hole will be continuous with the hole in the wood, then glue the blocks together with the nut between them. Cut out a piece from the block combination, leaving it shaped somewhat like a bench, and glue the bottoms of the legs to a piece of thin board about $2\frac{1}{2}$ inches square for a support. Solder one end of a stiff wire about 2 inches long to the head of the bolt at right angles to the shaft, and fix a disk of heavy pasteboard with a radius equal to the length of the wire, and with its circumference graduated into equal spaces, to serve in measuring revolutions and parts of

revolutions of the end of the wire, to the top of the bench; put the bolt in the hole, screwing it through the nut, and the construction is complete.

The base is improved for the measuring work by gluing to a central section of it, covering the place where the end of the bolt meets it, a small piece of stiff metal; and it is convenient to have the graduated disk capable of rotating, so that its zero line may be made to coincide with the wire.

Find the number of threads of the screw to the inch by placing the bolt on a measuring rule, and counting the threads in an inch or half an inch of its length. The bolt in making one revolution will descend a distance equal to the distance between the threads.

To use the apparatus, put the object whose thickness is to be measured on the base under the bolt, and screw the bolt down until its end just touches the object, then remove the object and screw the bolt down until its end just touches the base, carefully noting while doing so the distance that the end of the wire moves over the scale. The part of a rotation of the bolt, or the number of rotations with any additional parts of a rotation added, divided by the number of threads to the inch, will be the thickness of the object. Quite accurate measurements may be made with this instrument, and in the absence of the expensive micrometer, it serves a very useful purpose.—101

AN IMPROVED DOWEL PLATE

The chief fault with the ordinary dowel plate is the naturally obtuse cutting angle, formed by the edges of a hole bored in a flat steel plate. The dowel plate here illustrated presents to the wood an acute cutting angle, and also admits of being sharpened. Obtain a leaf of a buggy spring which has on its convex side surrounding the two holes a raised portion or boss. Soften the spring, and cut out the part required, leaving enough metal on either side of the hole to ad-

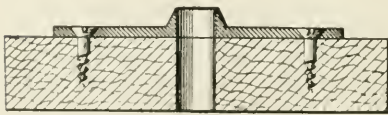

Fig. 124—An improved dowel plate

mit of its being drilled for screw holes. Run a twist drill through the hole with the raised lip, to make it of a standard size, and smooth the interior. After drilling, file the edges of the lip until quite sharp, screw the plate down to a suitable block of hard wood, and bore through it with the same twist drill. The plate is then complete. A mallet must be used for driving the dowels through the plate, so as not to injure the cutting edges.—25

THE TURNING OF A BALL

How to turn a true wooden ball is apt to puzzle the amateur; but this, like most other mechanical methods, is very "simple after you know how." True, all balls for which there is sufficient demand are now turned by automatic machinery, much more cheaply than they could be turned by hand; but the job is a pleasing



Fig. 125—The roughly turned ball

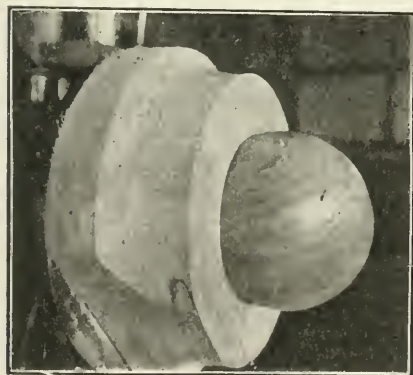

Fig. 126—Ready for finishing cut

one, and well worth doing for its own sake.

If one has a lathe with a face plate, no other equipment, except the usual chisels, is necessary.

The block is first placed between the usual centers, turned as nearly spherical as may be, and the ends sawed off. A piece of hard wood of sufficient size is next screwed onto the face

plate and turned into a cup-shaped chuck, as shown, together with the roughly-turned blank in Fig. 125. The blank is next

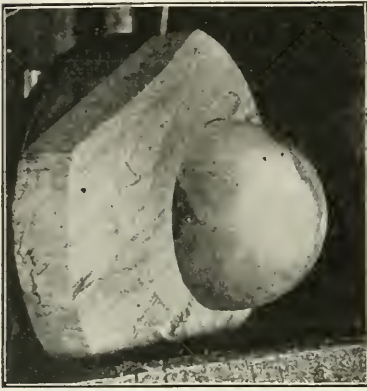

Fig. 127—Finishing cut partly completed

pressed into this chuck, as shown in Fig. 126. If the chuck is turned out to such a size that the blank will go in just a little less than half way, it will stay without trouble. Then, using a common chisel and making a scraping cut, the blank is worked down to the marks of the first cut, to which this one is at right angles. In order that one may see better how the work is progressing, without stopping the lathe, it

is well to mark the blank heavily around the middle with a soft lead pencil. Fig. 127 shows this cut nearly complete. The blank is next reversed, and the same cut made on the other side. If special accuracy is required, it may be well to repeat the operation several times; and it is always advisable to start with the chuck block thick enough, so that it may be cut back and the hole trued up for each succeeding operation. In

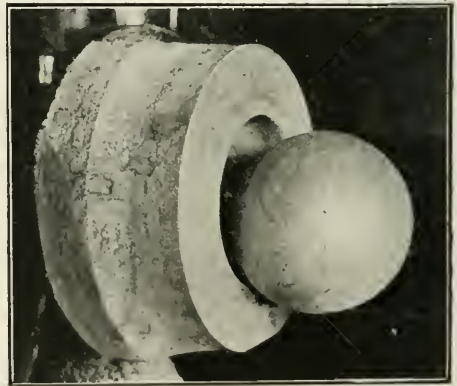

Fig. 128—The finished ball

sandpapering, if the hole is of just the right size, one can change the position of the ball without stopping the lathe.—30

CHAPTER III.

THE SOLDERING OF METALS AND THE PREPARATION OF SOLDERS AND SOLDERING AGENTS

The object of soldering is to unite two portions of the same metal or of different metals by means of a more fusible metal or metallic alloy, applied when melted, and known by the name of solder. As the strength of the soldering depends on the nature of the solder used, the degree of strength required for the joint must be kept in view in choosing a solder. The parts to be joined must be free from oxide and thoroughly clean; this can be secured by filing, scouring, scraping, or pickling with acids. The edges must exactly fit, and be heated to the melting-point of the solder. The latter must have a lower melting-point than either of the portions of metal that require to be joined, and if possible only those metals should be chosen for solder which form alloys with them. The solder should also as far as possible have the same color and approximately the same strength as the article whose edges are to be united.

To remove the layers of oxide which form during the process of soldering, various so-called "fluxes" are employed. These fluxes are melted and applied to the joint, and act partly to keep off the air, thus preventing oxidation, and partly reduce and dissolve the oxides themselves. The choice of a flux depends on the quantity of heat required for soldering.

Solders are classed as soft and hard solders. Soft solders, also called tin solders or white solders, consist of soft, readily fusible metals or alloys, and do not possess much strength; they are easy to handle on account of their great fusibility. Tin, lead-tin, and alloys of tin, lead, and bismuth are used for soft solders, pure

tin being employed only for articles made of the same metal (pure tin).

The addition of some lead makes the solder less fusible but cheaper, while that of bismuth lowers the melting-point. Soft solders are used for soldering easily fusible metals such as Britannia metal, etc., also for soldering tin-plate. To prepare solder, the metals are melted together in a graphite crucible at as low a temperature as possible, well stirred with an iron rod, and cast into ingots in an iron mold. To melt the solder when required for soldering, the soldering iron is used; the latter should be kept as free from oxidation as possible, and the part applied should be tinned over.

The fluxes generally used in the soft-soldering of metals are powdered rosin or a solution of chloride of zinc, alone or combined with sal-ammoniac. A neutral soldering liquid can be prepared by mixing 27 parts neutral zinc chloride, 11 parts sal-ammoniac and 62 parts water, or 1 part sugar of milk, 1 part glycerine, and 8 parts water.

A soldering fat for tin-plate, preferable to ordinary rosin, as it can be more easily removed after soldering, is prepared as follows: 150 parts beef-tallow, 250 parts rosin, and 150 parts olive oil are melted together in a crucible and well stirred, 50 parts powdered sal-ammoniac dissolved in as little water as possible being added.

Soldering fat for iron is composed of 50 parts olive oil and 50 parts powdered sal-ammoniac. Soldering fat for aluminium is made by melting together equal parts of rosin and tallow, half the quantity of zinc chloride being added to the mixture.

Soldering paste consists of neutral soldering liquid thickened with starch paste. This paste must be applied more lightly than the soldering liquid.

Soldering salt is prepared by mixing equal parts of neutral zinc chloride, free from iron, and powdered sal-ammoniac. When required for use, 1 part of the salt should be dissolved in 3 or 4 parts water.

Borax is the flux most frequently used for hard-soldering; it

should be applied to the soldering seam either dry or stirred to a paste with water. It is advisable to use calcined borax, i. e., borax from which the water of crystallization has been driven out by heat, as it does not become so inflated as ordinary borax. Borax dissolves the metallic oxides forming on the joint.

Finely-powdered cryolite or a mixture of 2 parts powdered cryolite and 1 part phosphoric acid is also used for hard-soldering copper and copper alloys.

Muller's hard-soldering liquid consists of equal parts of phosphoric acid and alcohol (80 per cent).

A mixture of equal parts of cryolite and barium chloride is used as a flux in hard-soldering aluminium bronze.

A flux used in soldering iron with cast iron is composed of equal parts of cast-iron filings and calcined borax. This black, glassy mixture is pulverized, and the powder spread on the seam.

It only remains to mention the so-called cold-soldering, in reality a joining of the edges by means of a copper amalgam. The parts to be joined are well cleaned, and a substance made by triturating 1 part of metallic sodium with 50 to 60 parts of mercury rubbed in. This substance may to some extent be used for the same purpose as soldering fluid, as it causes the firm adhesion of the copper amalgam employed as solder.

To make copper amalgam, dissolve copper sulphate in water and add some zinc-plate chips. A fine powder consisting of pure copper is deposited, which should be filtered off, washed, and triturated in a heated porcelain bowl with a double quantity by weight of mercury. The amalgam, which resembles 18-carat gold in color, is formed into little pellets or bars, which are made soft by heating when required for use.

SOLDERING APPARATUS

The chloride of zinc solution used in soldering is prepared by cutting zinc in muriatic acid to repletion and diluting it with an equal quantity of water. For iron, a small quantity of sal-ammoniac may be added. For large work, where spelter is used, it is powdered and mixed with pulverized borax. The mixture is made into a thick paste with water and applied with a brush.

Soft solders are fused with a copper or blow-pipe after the application of the appropriate flux.

While the work and the solder fluid are still hot, any surplus fluid may be nicely removed with a moist brush. A mat-joint may be made between closely-fitting surfaces by placing a piece of tin-foil between the parts, and fusing in a plain or blow-pipe flame.

For small work spelter and silver solders are fused by means of the blow-pipe; the work being laid upon a charcoal or piece of pumice-stone. It is often desirable to flank the work with an additional piece of charcoal, to economize all the heat of the flame, as well as that resulting from the combustion of the coal.

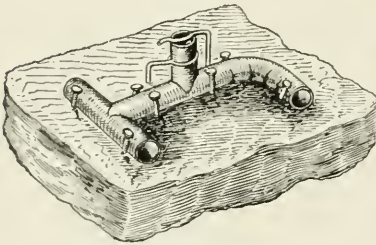

Fig. 129—Anchoring work to be soldered

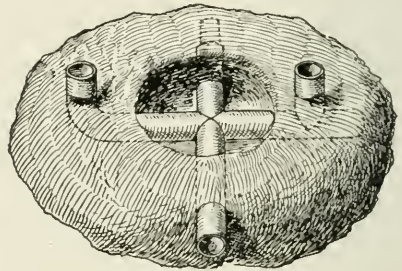

Fig. 130—Incasing the work

If the work is of such a character that it is inconvenient to clasp or rivet it together, or even to wire it, it may be kept in place upon the coal or pumice-stone by means of tacks forced in at points where they will be effectual in holding the work. When tacks are unavailable, parts may be held by wire loops and stays. (See Fig. 129.)

If part of the work has been already done, and it is desired to unite several pieces, having parts which have been previously soldered, in close proximity, these parts may be held in any position, and at the same time the joints already soldered may be prevented from melting by incasing the work in the following manner. (See Fig. 130.)

Take equal parts of plaster-of-Paris and fine, sharp sand;

add a sufficient quantity of water to make a thick batter, and imbed the work in it, leaving the entire joint to be soldered and the adjacent parts exposed. Care must be taken to not get the plaster in the joint, as that would prevent the solder flowing.

It is difficult to hold all the various parts which are to be united so as to apply the plaster. The parts may be put into position one by one, and fastened temporarily by means of a drop of wax, which, when the work is incased and the plaster sets, may be readily melted out and the flux and solder applied. In every case

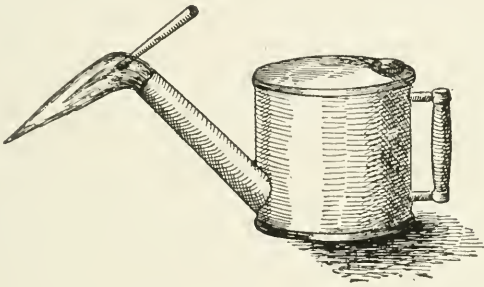

Fig. 131—Soldering flame

where it is possible, the flux should be well brushed into the joints before placing the work on its support. A convenient way of preparing flux for small work is to rub a piece of borax about, with a few drops of water, on a porcelain slab or common slate until it appears like paste; this should be applied to the work with a camel's hair pencil. Small pieces of solder are dipped into the borax paste and put on the joints of the work. A pair of tweezers will be found convenient for this.

When the job is incased as in Fig. 130 it may be placed in a common fire until it has nearly attained a red heat, when it will be found that on applying the blow-pipe the solder will readily flow with little expenditure of time and breath.

Just here, perhaps, it is well to notice the action and use of the blow-pipe and the structure of the blow-pipe flame.

When a jet of air from a blow-pipe is directed into a gas or alcohol flame the form of the flame is changed to a slender cone, having at two points characteristics which differ widely. There is a slender internal pencil, having a fine blue color, which is known as the reducing flame, shown in Fig. 131, and an external flame enveloping the blue pencil, having a more indefinite form and a brownish color. This is the oxidizing flame. A piece of metal—tin, for example—placed at the apex of the outer or oxidizing flame is rapidly oxidized, while the same piece placed at the point of the internal or reducing flame immediately assumes a globular form and has the brilliant surface of clean melted metal.

The *rationale* of this is that at the extremity of the oxidizing flame there is intensely heated oxygen in condition to unite with anything oxidizable; while at or just beyond the inner or reducing cone are unburnt gases having a high temperature and a strong affinity for oxygen, and consequently any oxide placed at this point will be deprived of its oxygen and reduced to a metallic state.

From this the conclusion will be readily arrived at that the proper point in the blow-pipe flame to effect the fusion of solder is just beyond the apex of the reducing flame.

To produce a uniform continuous jet with the ordinary blow-pipe is an attainment which, to some, is most difficult. It is very easy to state that it is only necessary to cause the mouth to maintain the jet at the instant of inspiration, but it is quite another thing to do it. The blowing, in light work, should, for the most part, be done with the mouth alone. It must be made to act the part of a pump or bellows, receiving its air supply from the lungs, but forcing its contents through the blow-pipe, principally by the action of the tongue. Let the tyro close his lips tightly, and with his tongue alone, independently of his lungs, force air into his mouth until his cheeks are distended to their fullest extent.

This done, and all is learned; for it is now only necessary to place the blow-pipe in the mouth and continue the action of

the tongue, when it will be found that a continuous blast may be maintained without difficulty, and the lungs may be used or not at pleasure. Let it not be understood from the foregoing that the cheeks are to be puffed out while blowing. This is not advisable.

Often, even to those who are accustomed to the use of the blow-pipe, protracted operations are tiresome. In view of this,

although a number of devices have been brought out for producing a continuous blast, the one shown in Fig. 132 is suggested. It consists essentially in a gasometer of small dimensions, having a small pipe which reaches above the water inside and terminates in a nipple. There is a valve in the top, shown in Fig. 132, which consists in a flap of leather, very thin rubber, or oiled silk, placed under holes in the top and retained by springs. A weight is placed upon the top to give the requisite pressure. A rope attached to an eye in the top passes over a pulley in the ceiling—or, if the apparatus is put in the cellar, simply passes up through the floor. The operation is obvious. The upper portion of the gasometer is raised by means of the rope; air passes into the valve in the top and is retained; it passes out through a nipple and thence through the rubber tube attached to a blow-pipe of any construction.

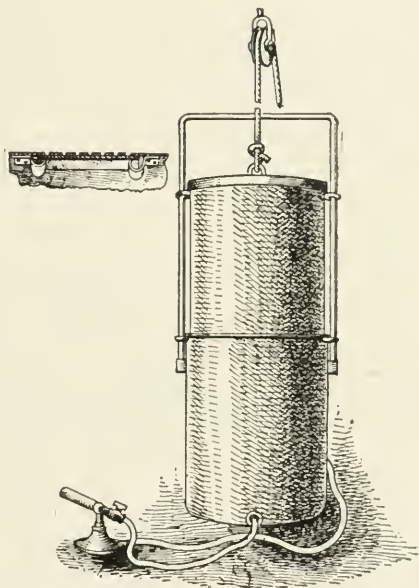

Fig. 132—Continuous blast apparatus

The upper portion of the gasometer is raised by means of the rope; air passes into the valve in the top and is retained; it passes out through a nipple and thence through the rubber tube attached to a blow-pipe of any construction.

A gasometer of this sort, the upper portion of which is $12\frac{5}{8}$

inches in diameter and 18 inches high—fitting into a lower vessel having a diameter $\frac{1}{2}$ inch greater, and the same height—with a valve in the top covering thirty or forty $\frac{1}{4}$ -inch holes, and weighted with 25 or 30 pounds, will give a strong blast for twenty or thirty minutes. It is readily recharged with air. The supply to the blow-pipe is regulated by means of a cock.

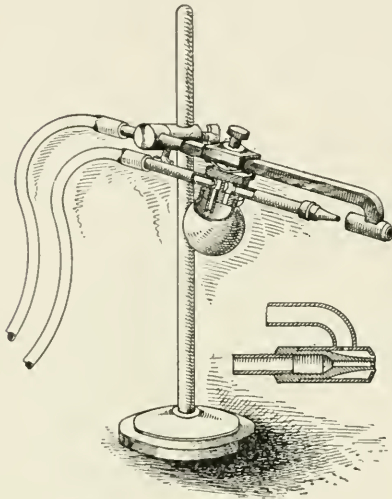

Fig. 133—Blow-pipe

A blow-pipe of peculiar construction, shown in Fig. 133, has some qualities which recommend it for soldering, and also for other blow-pipe operations.

This blow-pipe is in fact a modification of the annular compound blow-pipe. A pipe which is attached by means of a pivoted connection to a standard is turned in a right-angled elbow at its outer extremity, and is fixed to a short sleeve, which is somewhat contracted at its outer end. The slide is provided with a spring-gib, to insure a certain

amount of friction on the pipe, and a set-screw to fix it at any point. This slide supports the air-tube and the ball. The sleeve and air-pipe are axially in line, so that when the nozzle is moved into the sleeve their apertures are truly concentric, and when in the position shown the larger part of the nozzle should fit the sleeve tightly.

The ball collects the moisture, the air passing down the tube and upward through the passage.

The best size for the air-pit for all purposes is $\frac{1}{48}$ inch. The annular space for the exit of gas around the air-nozzle should not be more than $\frac{1}{100}$ inch in breadth. Gas is supplied through the tube and air through the tube.

When the parts are in the position shown, with the air and gas supply in proper proportion, a fine blue pencil from $\frac{1}{2}$ to 3 inches or more in length is produced. By sliding the air nozzle back and using a strong blast, an intense solid flame is produced capable of doing all that can be reasonably required.

This blow-pipe when connected with the apparatus shown in Fig. 132 seems to answer all the requirements for any purpose whatever. The weight on the gasometer may be reduced, when the gasometer may be filled with oxygen, and the operator will enjoy all the benefits of an oxyhydrogen jet, producing the lime-light, fusing refractory substances, and performing any of the brilliant experiments consequent to the use of a compound blow-pipe.

An instrument of this kind, when used for soldering, permits the use of both hands, which is a matter of no small moment.

Work that is too large to be readily soldered by the means already noticed may be done in a charcoal or coke fire with a blast. Even a common fire of coal or wood may often be made to answer the purpose.

Brazing or hard-soldering of any kind must not be tried in a fire, or with coals, or tools which have the least trace of soft solder or lead about them. Neither must the brazing of work which has been previously soft-soldered be attempted. A neglect of these cautions insures failure.

A wash of clay applied to surfaces which are not to be jointed prevents the flow of solder.

The vitrified flux may be readily removed by boiling the articles for a few moments in dilute sulphuric acid. This is best done in a copper vessel.—37

A HEATER FOR SOLDERING IRONS

The accompanying illustration shows a very simple heater for soldering irons, which can be made either stationary or portable. That is to say, it can be attached to the gas pipe in the shop, or it may be provided with an attachment for a rubber hose, so it can be moved about in different places.

The heater is mounted on a suitable base and made up of ordinary pipe fittings. A tee is attached at the lower part thereof, where the connection for the rubber hose is made. To the upper end of the standard a tee is fitted, to one side of which the heater is connected, and to the other an ordinary Bunsen burner. On either side of the tee is secured a small stopcock for regulating the supply of gas. These stopcocks have at their outer ends a small opening about $1/16$ inch diameter, which will of course vary, according to the local gas pressure. Into one of

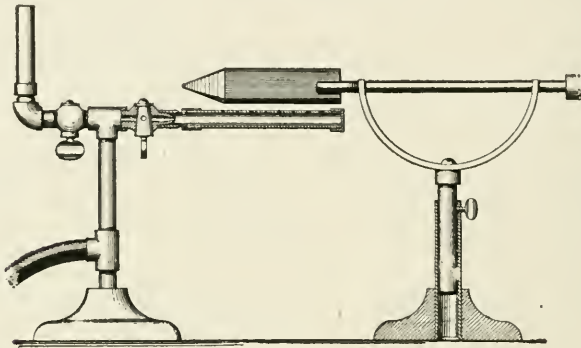

Fig. 134—Gas heater for soldering irons

these stopcocks is screwed a nipple perforated with one or more rows of $1/8$ -inch holes. At the base are two or more larger holes covered with a sliding sleeve for regulation of the air. By moving this sleeve more or less air may be admitted, until a blue flame is obtained. At the outer end of the nipple is screwed an ordinary cap. The Bunsen burner at the opposite side may be made of ordinary gas pipe, with holes and sleeve for the regulation of the air supply.

The stand or rest consists of a suitable base, into which is fastened an ordinary gas pipe with a set-screw at its upper end. Into this pipe slides another, somewhat smaller, to which is screwed an ordinary cap. To this cap is secured a flat piece of

iron, bent in a half circle, the ends being matched to provide a rest for the soldering iron. It will now be seen that by raising and lowering this inside tube, it can be held at any suitable distance from the heater by the set-screw. After the heater is lighted, it will only take a few minutes to heat the iron, as the flames burn directly under and the entire length of the same.

The Bunsen burner is used for heating large and solid pieces to be soldered.—5

HINTS ON SOLDERING

1. Do not buy small and cheap soldering irons, as they are not made of copper, but worthless compositions. Get an ordinary iron weighing about 3 or 4 pounds.

2. The whole pointed end of the iron must be tinned, and kept so, as no soldering can be done without it.

3. Always clean the iron after each heating before any attempt to solder is made.

4. Never make the iron "red hot," or so hot that the solder burns off.

5. Always clean the surfaces to be soldered, and put on flux.

6. Never remove the iron from the parts to be soldered until the solder runs like mercury and fairly boils.

7. Large and solid pieces to be soldered should first be heated, and kept hot while soldering.

8. Always pick up the solder from the bar with the iron; that is to say, touch the bar of solder with the hot and clean iron; a certain amount will adhere thereto.

9. Cast iron should first be filed or cleaned with emery cloth, then rubbed with a soft piece of brass. The brass will adhere to the cast iron, and the solder will stick to same very readily.

10. Always remember that solder will only adhere to clean metals coated with flux.

Use any kind of solder, preferably half and half, on almost any kind of work, either in bars or in strings.

The flux used may be of any kind on the market, but an old and

reliable one that the writer has used for many years is made as follows: Into an earthenware cup pour some commercial muriatic acid, into which put small pieces of scrap zinc. Let one piece dissolve or nearly so before another is put in, as otherwise the acid gets very hot, and is liable to break the jar. Always put more in than the acid will dissolve. Then let it stand for twenty-four hours. Now pour half of this into a small bottle with a wide mouth, and dilute with some water. Use this as a flux, to be applied with a stick or small brush. What remains in the jar is used to clean the iron, after each heating, by dipping the whole pointed end thereof into the liquid. This flux may be used on almost any metal except aluminium, zinc or galvanized iron. For the two last named the commercial acid should be used.

The tinning of the iron is done as follows: Heat the iron to a dark brown color. Then file the point on all four sides and dip the same into the jar. Then on a small piece of wood or tin melt some solder from the bar, and rub all sides of the pointed iron. Then dip again into the flux, and it will be noticed that if the iron was clean the solder will adhere to the same, "tinning" the iron. This operation should be done very quickly, so that the iron does not cool off. The iron should be treated like this from time to time, as the copper deteriorates and the tin burns off, but should not be heated to this high temperature unless it is to be retinned.

The solder is picked up by the iron by simply touching the bar of solder, holding the iron in an inclined position, so that the lower side of the tinned end of the iron will be horizontal. Remove the iron in this position to the object to be soldered, and then incline the handle a little more to let the solder run to the point and drop off.

A good way to ascertain if the iron is hot enough for soldering is to take it off the stand and place it about two inches from the face. In this manner the amateur will soon be able to tell whether it is hot enough to begin soldering.

Now take a piece of tin (iron or steel base tinned on each side) with a small hole in it and try to solder it. We will assume that

the amateur has complied with all the foregoing rules; that is to say, that the piece of tin is cleaned and flux put on where the soldering is to take place, the iron cleaned, and a sufficient quantity of solder picked up and transferred to the tin. The iron is now elevated, causing the solder to drop on the tin; then touch the same with the iron. If the iron is hot enough it will melt the solder, causing it to run through the hole, no matter how small, and form a lump on the other side of the tin. If the iron is not hot enough, the solder will only stick a little to the surface, and may easily be picked off. Now, to make a good job, try to strike a happy medium. Let some of the solder run through the hole and mix with the tin. The remaining solder on top may be left there, or wiped off with cotton waste or a greasy rag.

Therefore, always have the iron as hot as possible, and keep it on the object to be soldered long enough to thoroughly heat it to the same temperature as the iron, so that the solder will run like mercury; and if the object is thoroughly clean, the solder will stick. Rosin as a flux is used extensively on tin.

A granite pan with a hole in it can be soldered in the same way. First remove the granite or agate around the hole, about $\frac{1}{8}$ inch all around, either on one or both sides. This is best done with the end of a small file. The iron or steel base should be scraped until a metallic surface appears. Put flux on both sides, and hold a greased rag on one side to prevent the solder from running off. Then proceed as before described.

If pewter, tin, or other soft metals are to be soldered, it requires a little more practice, when sometimes only a touch of the iron will destroy the article.

In soldering large flat or round pieces together, the surfaces should always be tinned first. This can be done either with the iron or by heating over the Bunsen burner until the solder, dipped in flux, melts; then wipe off with a rag. The pieces are now held or clamped together and heated again, so that the solder melts and runs. More solder may be added as before described. This is generally called "sweating."

After the soldering is done the flux should be wiped off with

a rag and then washed off with some soda water, to prevent the corrosion of the metal.—5

HOME-MADE GAS SOLDERING IRON MADE OF PIPE FITTINGS

A gas soldering iron may be easily made as follows:

A piece of $\frac{3}{8}$ -inch gas pipe *A*, 9 inches long, is threaded at both ends. A $\frac{1}{8}$ by $\frac{3}{8}$ -inch reducer *B* is then screwed on each end of the pipe, and $\frac{1}{16}$ -inch holes are bored through the reducers, as shown at *C*. A piece of $\frac{1}{8}$ -inch gas pipe *D* is threaded on one end. A small brass plug *E*, having a $\frac{1}{16}$ -inch hole through the center, is fastened into the threaded end of the pipe *D*, and the latter is then screwed into the reducer *B*. A piece of copper *F*, $\frac{3}{8}$ inch in diameter and 4 inches long, is threaded on one end and screwed into the other reducer *B*. The opposite end of the copper can be either round, flat, or pointed, as de-

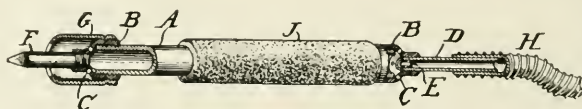

Fig. 135—Gas soldering iron

sired. A piece of tubing *G*, $3\frac{1}{2}$ inches long and large enough in diameter to snugly fit the outside of the reducer, is fastened to it, either by screws or by nicks made with a center punch. The rubber hose *H* is slipped over the pipe *D*. The hose can be protected by a spring made of No. 16 B. & S. wire. This will prevent kinking of the hose when the iron is in use.

The pipe *A* is covered with asbestos or some other poor conductor of heat *J* to form the handle. The action of the iron is as follows: The gas enters at the pipe *A* through the hole in the plug *E*, and mixes with the air that enters through the holes *C*. The mixture passes out through the holes *C* in the reducer at the opposite end, where it is to be ignited. The flame is deflected against the iron *F* by the shield *G*. This makes a very efficient iron that will solder continuously.—12

HOME-MADE BLOWPIPE

The blowpipe shown in the accompanying illustration will be found a very useful adjunct to any mechanic's workshop. For tempering tools, heating soldering irons, brazing, and melting metals in a crucible, it answers the purpose of the more expensive outfits, which the amateur as a rule does not feel able to invest in. Furthermore, there are no bulky air tanks and pumps

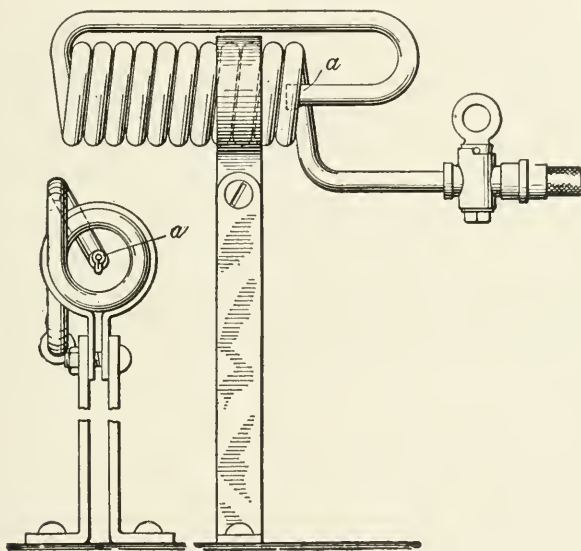

Fig. 136—Details of the blowpipe

to take up room, which to most amateurs means a great deal. The one illustrated can easily be carried in the pocket, so it is evident that the space required is indeed small. To construct one of this size, about 6 feet of copper or brass tubing $\frac{5}{16}$ of an inch outside diameter will be required, also 2 feet of band iron about $\frac{1}{16}$ of an inch thick by $\frac{3}{4}$ of an inch wide. Before bending the tubing to the required shape, it is necessary to fill it with lead or sand to prevent buckling. Either of these will be found to give

good results, though for the smaller sizes of tubing lead is preferable. It is not advisable to attempt pouring the molten lead in the tube, as it cools too rapidly. The safest way is to use wire solder. A piece two or three feet longer than the tube will as a rule be enough. The lower end of the tube will have to be closed by hammering it down. Insert the wire solder, hold the lower end of the tube over a flame to melt the solder, at the same time

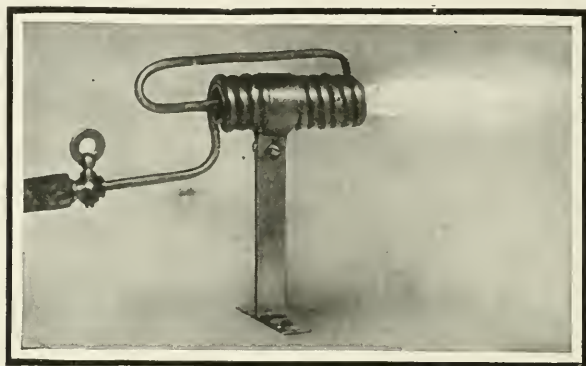

Fig. 137—The blowpipe in use

pressing the wire slightly. Move the tube slowly over the fire and it will quickly melt the lead, and one may feel sure there are no bubbles. To form the coil, use a round bar about $\frac{7}{8}$ of an inch in diameter. A broom handle will prove useful. It is best to reduce the nozzle *a* slightly, to increase pressure of the gas as it becomes heated in the coil. After this is done, and the coil assumes the shape shown, we can proceed to remove the lead, which may be easily done by heating over a fire until the lead melts, then by shaking slightly it will run out and leave the tube clear. The valve may be dispensed with, and a rubber tube from a convenient gas jet may be slipped on.

This blowpipe is adapted for gas under considerable pressure. If the pressure obtainable is low a larger pipe should be used

and be bent into a smaller coil, and the constriction at *a* will be unnecessary.—86

FORMULAS FOR SOLDERS*

The metals, or metallic mixtures, which are employed for the purpose of joining other metals, with the aid of heat, are known by the general name of solders. Their number is considerable, as soldering is done not only with pure metals, but also, and more frequently, indeed, with various alloys.

Solders are classified according to the manner in which they are used, with further distinctions in regard to their fusibility and to the metals which are to be soldered. We will take up first the most general classification referring later to special cases.

The two principal classes may be distinguished as homogeneous and heterogeneous solders. The first consist of the same metals as those which are to be joined to each other, the latter either of a foreign metal or, more frequently, of a mixture of metals.

The homogeneous solders are, of course, the simplest, and in general most to be recommended, since it is possible, with them, to make the soldered article appear as if actually cast in one piece. But they are less frequently employed now than formerly, when fewer good solders were known; and this for the reason that this method of soldering is somewhat difficult, and requires in most cases a very high temperature. It has recently been revived, however, for many purposes, since devices have been learned for obtaining a very high degree of heat in a short time.

The heterogeneous solders, consisting of alloys, have the advantage that by proper changes in their composition they can be easily adapted to any special purpose, and thus the labor is lightened. Since the so-called soldering machine has been so far perfected that a good deal of soldering can be done without the use of a soldering iron, simply by letting the melted solder run into the seams, many kinds of solder, even quite hard, are used in this way, and the work of soldering is thereby considerably simplified.

* Copyright 1906 by Munn & Co.

CLASSIFICATION OF SOLDERS

Solders are divided, according to their fusibility and special uses, as follows:

1. *Soft Solder, or Tin Solder.*—Subdivisions of this class are pure tin solder and the so-called bismuth solder. Soft solder is the most fusible kind, requiring, therefore, the least heat for soldering. As a matter of fact, soft solders can be prepared which will melt at a heat below the boiling point of water.

2. *Hard Solder.*—Some very different substances are brought together under this name; but the one distinguishing characteristic of the group is that all its members have a considerably higher fusing point than the soft solders, and thus can be used in soldering articles which are to be exposed to higher temperatures. The principal varieties of hard solder are:

Copper solder.

Brass solder, with its varieties known as hard and soft brass solder, white, half-white, and yellow-white solder.

German silver solder.

White nickel solder.

Soft and hard silver solder.

Gold solder.

Enameling solder.

Aluminium solder.

Several of these solders can be used for soldering other metals than those which the name indicates. It would be entirely possible, for example, to solder German silver with hard brass solder; but as this is yellow and German silver white, the seams would show and give the article a bad appearance.

To have the color of the solder as nearly as possible the same as that of the metal to be soldered, metallic mixtures are used, and it is also an object, as far as practicable, that the alloy should have similar properties. It is apparent that a large number of different solders are necessary, to correspond with the number of different metals and alloys.

SOFT SOLDERS

Soft solder, or tin solder, can be used to solder many different metals, gold, silver, lead, copper, and steel, as well as brass, wrought iron, and zinc. Its principal use, however, is in ordinary tinsmith's work, for which tin plate, zinc, and sheet brass are the materials most frequently employed. Soft solder can be used for any purpose where the soldered articles need not be heated much above the boiling point of water, so that there is no danger of its melting.

In regard to their qualitative composition, soft solders vary but little. Tin and lead, and sometimes bismuth, are the metals combined. But the proportions of these are varied so much as to make quite a large number of different solders. It may be remarked, in general, that the fusing point of the alloy is raised by increasing the content of tin, and lowered by the addition of more lead. Since lead is much cheaper than tin, alloys containing a large proportion of lead are of course used for objects where a high fusing point of the solder is not necessary, as for instance in making toys. For certain other purposes, solders of pure tin, or those containing but a small amount of lead, are required. This is the case in the soldering of metallic utensils for use in chemical laboratories, or in the preparation of drugs and extracts. These utensils are made either of copper, and tinned on the inside, or of pure tin, which is a good resistant of chemical action. If solder containing much lead were used upon them, the lead would be liable to attack by certain chemical agents, and some amount would be dissolved into the contents of the vessel. In such cases, therefore, no regard should be paid to the cost of the solder; the only consideration should be the prevention of any possibility of attack by substances such as vegetable extracts, fruit juices, etc. Pure tin is the best material for the solder, and it is of importance that it should be the best obtainable. English tin and "Banka" tin rank first with respect to purity, and the fusing point of the metal and the appearance of the fracture may be taken as a standard of the quality. Pure tin melts at 235 deg. C. (455 deg. F.), and the fusing point of a

good quality of tin will be very near to this. If the fusing point is more than five degrees higher or lower, there is reason to suppose that there are adulterations which will be liable to affect the solder injuriously.

If the fusing point is lower than 230 deg. C. (446 deg. F.) it is probable that the metal contains a small quantity of lead, usually added intentionally; a rod of such tin, on being bent, will make but little of the peculiar crackling noise characteristic of pure tin, and if broken, the fractured surface will plainly show the difference.

A fusing point above 240 deg. C. (464 deg. F.) will usually be due to small quantities of iron; tin containing iron is hard to bend, and has a hackly fracture. The presence of iron, however, is far less dangerous than that of lead.

For ordinary tinsmith's work, where the resistance of the solder to acids, etc., is of less importance, it is customary to use mixtures of tin and lead, in varying proportions according to different purposes and according to the required melting point of the solder. Experts have taken much pains to make accurate determinations in this important matter, and the following table gives the fusing point (Centigrade) of a solder containing a given amount of lead to 100 parts of tin:

Lead.	Fusing Point.	Density of the Alloy.
16.5	194	7.927
30	194	7.994
33.3	194	8.109
40	194	8.234
45	187	8.267
50	187	8.408
60	181	8.447
66.6	181	8.726
100	197	8.864
119	197	9.038
125	210	9.270
179	210	9.433

Lead.	Fusing Point.	Density of the Alloy.
200	235	9.554
233	235	9.640
250	235	9.770
268	243	9.797
300	246	9.939
358	246	10.052
536	270	10.331
715	283	10.595
880	292	10.751
1072	292	10.815

It will be seen that the alloys of tin and lead become denser and less readily fusible as the contents of lead are increased.

According to other experiments, the fusing points of the alloys are as given below :

Lead.	Tin.	Fusing Point.
207	118	189 deg.
207	354	180 deg.
207	708	190 deg.
621	236	211 deg.
1242	118	270 deg.

Before the solders really melt, they soften considerably, and the following table gives the softening point of some alloys :

Lead.	Tin.	Softening Point.	Melting Point.
1035	236	185 deg.	189 deg.
1242	236	189 deg.	194—195 deg.
1449	236	192 deg.	198 deg.
1656	236	202 deg.	208—210 deg.

Alloys used especially for solders:

Tin.	Lead.	Fusing Point.
1180	4140	240 deg.
1180	3105	223 deg.
1180	2070	200 deg.
1180	1242	181 deg.
1180	1035	185 deg.
1180	828	190 deg.

Composition of ordinary soft solder:

Lead	207
Tin	118

Weak Soft Solder

Lead	207
Tin	236

Strong Soft Solder

Lead	414
Tin	118

Fluid Solder

Lead	621
Tin	590

Fluid solder is prepared by making the given mixture and letting it stand until partially hardened, when the part which is still fluid is poured off. In using this, it is poured into large seams, and works extremely well. The stiffened part can be used as ordinary solder.

If the alloys are to be made in small quantities, it requires very sensitive scales to weigh the metals accurately. The composition of some varieties of tin solder is given below, in round numbers, with the fusing point of each. They are numbered according to their fluidity, No. 1 being the hardest.

1. Lead	2
Tin	1
Fusing point, 240 deg. C.	
2. Lead	1
Tin	1
Fusing point, 200 deg. C.	

3.	Tin	2—2½
	Lead	1

Fusing point, 185—190 deg. C.

4.	Lead	10
	Tin	177

Fusing point, about 180 deg. C.

Bismuth Solder.—For some purposes even the soft solders of tin and lead are too difficult of fusion, and in this case alloys of tin, lead, and bismuth are employed. This is a most excellent solder, but its use is limited to very special purposes, on account of the expensiveness of bismuth. For ordinary work, also, there is no need of such an extremely low fusing point.

Tin and bismuth alone are sometimes used, but not often. This alloy is more resonant than pure tin, but less ductile. The fusing points of some alloys of tin and bismuth are given below :

Bismuth.	Tin.	Fusing Point. Deg. C.
208	118 (Very brittle.)	137.7
208	236	165.56
208	944	168.99

All solders containing bismuth have a very low fusing point; their disadvantage is that they have but little cementing power, and are very brittle, so that if an article soldered in this way is allowed to fall, the whole soldering seam will often give way. We give below the composition of some of the solders of tin, lead, and bismuth, with their respective fusing points :

Tin.	Lead.	Bismuth.	Fusing Point. Deg. C.
118	207	208	124
236	414	208	145
354	621	208	255
472	828	208	160
236	207	208	160

With a considerable admixture of bismuth, the fusing point

can be brought down to a temperature lower than the boiling point of water. Some of these mixtures are here given:

Newton's Metal

Bismuth	1664
Lead	1035
Tin	354
Fusing point, 94.5 deg. C.	

Rose's Metal

Bismuth	416
Lead	207
Tin	118
Fusing point, 93.75 deg. C.	

D'Arcet's Metal

Bismuth	1664
Lead	1656
Tin	354
Fusing point, 79 deg. C.	

Attention should be called to the fact that these readily fusible metallic mixtures are remarkably well adapted to making reproductions of delicate plaster casts. A cast is made, for example, of a beetle. After drying at 100 deg. C. (212 deg. F.) the insect is carefully removed from the mold, and the latter filled with the fluid alloy. A perfect reproduction will be made.

Bismuth solder is usually made by melting the required quantity of bismuth together with ordinary tin solder, in the proportion of 1 part of bismuth to 8 parts of solder. The tin must be melted first, and heated above the melting point; then the lead is added, the vessel removed from the fire, and the bismuth thrown into the mass, which will at once become thinner. It must be stirred rapidly, and the stirring should be continued until the alloy begins to stiffen, in order to insure an even mixture.

A very good way is to scatter the bismuth, in powdered form, into the melted tin and lead, stirring all the time. Frequent remelting of bismuth solder is to be avoided, since this is apt to raise the fusing point.

Manufacture of Soft Solders.—The correct process of preparing soft solders is very simple, but certain rules must be observed if solder of good quality is to be obtained.

The standard of good quality is that any smallest piece of the solder shall contain all the metals of the mixture in the right proportions. If improperly prepared, some parts of the solder will have a different fusing point from others.

Since lead is harder to melt than any of the other metals used in solder, it ought really to be melted first and the others added to it. The tin, however, is less dense than the lead, and will not sink in it, so that much longer stirring is necessary to insure an even mixture than if the process is reversed. Besides this, the lead oxidizes very easily, and if melted alone, there will be a considerable waste in ash. The following method is the best: Cut the lead into little pieces, and have them ready on a shovel. Heat the tin in a stone or porcelain vessel over a coal fire, gently at first, until melted. When a film of tin-ash forms upon the surface of the metal, throw in the lead, a little at a time, waiting until this is melted before adding more. Stir constantly with a flat wooden paddle, in order that the metals may be thoroughly mixed.

When all the lead is melted, pour the alloy into the molds by means of a ladle with a nozzle. When it has become stiff, dip the mold into cold water, throw out the solder, and have the mold ready for more. Two workmen, with but a small number of molds, can prepare a considerable quantity of solder in this way in a short time.

The forms into which the solder is poured are best made of cast iron, of such a size as to make rods of the solder about 30 centimeters long, 2 to 3 centimeters wide, and 2 to 5 millimeters thick. The sides are inclined outward a little, so that the rods can be easily removed, and the mold is rubbed with grease before being used the first time.

For commercial purposes, and for large factories where the solder is given out to the workmen, it is well to have the pieces all of the same size and weight. The mold shown in Fig. 138

is especially well adapted to this, and the solder is produced in sharp-cornered prismatic pieces.

In making fine bismuth solder and tin solder for delicate work, it is well to cast it in molds which will give cylindrical pieces. Fig. 139 shows the cross-section of such a mold. It consists of

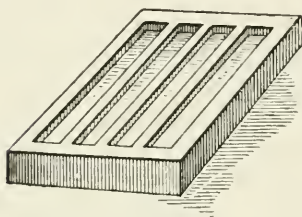

Fig. 138—Mold for solders

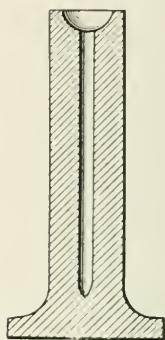

Fig. 139—Mold for bismuth and tin solders

two parts, with half-cylindrical grooves, making a hollow cylinder when placed together. The solder is poured in at the top.

If iron vessels are used to melt the solder, as is frequently done, the solder will take in some iron and become harder and more brittle. Vessels of stone or porcelain are therefore preferable.

Bismuth alloys are made in the same manner as ordinary solder, except that the temperature of the mixture is lowered, by decreasing the fire, immediately after adding the bismuth.

In practice, the quality of the solder is judged by its outward appearance. Good soft solder has a crystalline structure, apparent on the surface, and the crystals are grouped in a peculiar way. These "blossoms," so called in German, are brilliant spots on a dull white ground. If the solder shows very brilliant tin-white specks on a blue-gray ground, this is a sure indication that it was badly prepared, and that the metals are not properly mixed.

Solder of this nature can be made over, by melting and stirring vigorously.

If, in spite of correct treatment and intimate mixture by stirring, the "blossoms" are not seen, it is a sign that there is not sufficient tin in the composition. Melted tin in small quantities can be added to the melted mass, until a sample shows the desired crystalline structure.

Special Uses of Soft Solders.—Metal workers who are in the habit of preparing alloys for solders are likely to have occasion to use them for other purposes also. As before observed, these alloys, on account of their low fusing point and the sharpness with which they fill out the forms, are well adapted to the manufacture of small cast articles, such as children's toys, buttons, etc.

If it is desired to make them harder and save tin, small quantities of antimony may be added during the melting. From 1 to 5 per cent is enough to harden the alloy considerably; a certain limit must not be exceeded, for the reason that the articles, especially if thin, would be very brittle and break easily.

An alloy for casting, made of 4 parts of tin and 3 of lead, is easily fusible, and quite soft, filling the forms perfectly. Eight parts of tin, 6 of lead, and 0.5 of antimony makes an alloy easily fusible, but somewhat harder and more brittle than the preceding.

Sheet Alloy

Tin	35
Lead	250
Copper	2.5
Zinc	0.5

This alloy has a fine white color, and can be rolled out into very thin sheets. It is used for lining tea-chests, and for making sheet to wrap up tobacco, chocolate, etc. The copper and zinc are used in the form of fine shavings, and the alloy cast into thin plates, afterward rolled to the thinness of paper, and called tin foil.

An alloy of 20 parts of tin and 19 of lead is characterized by a high and permanent luster, and can be used to imitate brilliants, for theatrical decoration. An alloy of 2 parts of tin and 1 of lead is usually made first, and more tin is then added until a drop, let

fall upon a smooth iron plate, reflects like a mirror. The brilliants are made by dipping a piece of glass, cut in the form of a jewel, into the melted alloy, quickly removing it and letting it cool. The small quantity of the alloy adhering to it stiffens quickly and falls off. These brilliants are rough on the outside and gray in color, but the smooth inner surface, by artificial light, gives reflections like diamonds; the surface may also be coated with blue, red, or green aniline varnish to vary the effect. Pieces of polished steel or bronze may also be used instead of the glass.

The above-described alloys of tin, lead, and bismuth are the ones generally used for casting objects which cannot be exposed to great heat, such as wood carvings, plaster casts, etc.

The so-called *cliché* metals possess in a high degree the qualities of ready fusibility, softness, and capacity for filling out the molds sharply, which are required of these alloys, and are eminently suited for casts of woodcuts, as in making metal plates for printing.

Cliché Alloys

Tin	3
Lead	2
Bismuth	5

Fusing point, 91.6 deg. C.; excellent for cuts, but expensive on account of the large amount of bismuth. Some cheaper compositions are as follows:

	I.	II.	III.	IV.
Tin	1	3	1	2
Lead	1	5	1.5	2
Bismuth	2	8	3	5
Antimony	I

Alloys for medallions and coins (used by collectors to take impressions) must give extremely fine and sharp impressions. The following mixtures are suitable for the purpose:

	I.	II.
Tin	3	6
Lead	13	8
Bismuth	6	14

Castings of natural objects, such as fruits, leaves, butterflies, lizards, etc., can only be made by using the very softest and most fusible alloys known, prepared by adding cadmium to the bismuth alloys. This metal, whose fusing point alone is 455 deg., has nevertheless the property of lowering the fusing point of metallic mixtures.

Wood's Metal

Tin	2
Lead	4
Bismuth	5 to 8
Cadmium	1 to 2

This is silver white, very fine grained, and melts between 66 deg. and 72 deg. C. It is also excellent for soldering.

Lipowitz's Metal

Tin	4
Lead	8
Bismuth	15
Cadmium	3

This is the most readily fusible of all mixtures, becoming soft at 55 deg. and melting entirely at 60 deg. C.

HARD SOLDERS

In treating of soft solders, it was shown that the fusing point of these compositions varies considerably. The variations are still greater in the case of hard solders, whose composition is such that they melt only on being brought to strong red heat. Some of them can be melted in the ordinary way, with the aid of a soldering iron, while in the case of others, a special apparatus, such as a bellows, must be employed, or the whole object to be soldered must be strongly heated. The numerous kinds of hard solders, with different fusing points, are made necessary by the difference in the nature of the various metals and metallic compositions which may require soldering.

Copper Solders.—Although many hard solders contain copper, and might therefore be classed with copper solders, we will here

consider under that name only those whose essential constituent is copper. Copper is a metal which melts only at very high temperatures, and affects in this way its alloys with other metals; any solders containing copper are hence always to be called hard. But the fusing point is generally lowered as the amount of copper is decreased.

Pure copper, on account of its strength and tenacity, is an excellent material for soldering, and is much used for cast iron, wrought iron, and steel. Where its color is no objection, it is to be highly recommended for use with the above-mentioned metals. It may be employed in the form of thin strips, or in filings scattered over the place to be soldered, this according to the nature of the surface.

Fine copper filings are sometimes used to solder copper itself, and with the best results; but usually alloys containing a large percentage of copper, but more easily fusible than copper itself, are used.

These (used also for bronze) are mixtures of copper and lead. The more lead they contain the more readily fusible they become, of course, and the less they resemble copper in color or in point of tenacity. The most common copper solder is composed of 5 parts of copper to 1 of lead. Another has copper 80 parts, lead 15, and tin 5.

Copper amalgam, that is, a compound of copper and mercury, is very well adapted to soldering such copper and bronze articles as cannot be exposed to strong heat. This is prepared by first precipitating the copper from a solution of blue vitriol, which is done by putting in sheets of zinc and shaking. The copper will be in the form of a very fine powder. From 20 to 36 parts by weight of this powder, according as the solder is to be harder or softer, are put into a porcelain mortar, and enough sulphuric acid is poured on to make a paste, then 70 parts of mercury are stirred in. After a uniform mass has been obtained, the sulphuric acid is washed out, and the amalgam will be left, after ten or twelve hours, as a hard mass, capable of being polished. If heated to 662 deg. F. it becomes soft and malleable.

In soldering, the seams of the copper or bronze articles are brushed over with a solution of mercury, the so-called amalgamating fluid, and become white from the separation of mercury. The amalgam, powdered, is scattered over, and by passing the hot soldering iron over the places, the soldering is completed. The amalgamating fluid is made by dissolving 10 parts by weight of mercury in 11 parts of nitric acid, and diluting the solution with 500 to 550 parts of soft water.

Brass Solder.—This is a very important kind of solder, used by many metal workers to solder brass, bronze, copper, iron, and steel. From its composition it may be considered a kind of brass, to which are sometimes added small quantities of tin.

Brass, as we know, is an alloy of copper and zinc. Most kinds of brass have an average composition of 68 to 70 per cent of copper to 32 to 30 per cent of zinc; but there are certain special varieties in which varying quantities of zinc, from 24 to 40 per cent, may be found.

The less zinc there is in brass, the more it approaches copper in its general characteristics; increasing quantities of zinc tend to make it brittle and crystalline. As a rule, alloys for hard solders should not contain more than 34 per cent of zinc.

The fusing point of brass is raised as the amount of copper is increased; an alloy containing 90 per cent of copper melts at 1,060 deg. C. (1,940 deg. F.), with 80 per cent of copper the fusing point is 1,020 deg. C. (1,868 deg. F.), with 50 per cent 980 deg. C. (1,796 deg. F.), with 30 per cent 950 deg. C. (1,742 deg. F.).

As the alloy becomes more readily fusible with an increase of zinc, the color also changes essentially, and the alloy becomes much more brittle. The latter property may be modified by using partly zinc and partly tin, thus giving the alloy a resemblance to bronze. The durability of the solder is not affected, but it is made much less brittle and more readily fusible. If, however, more than a certain percentage of tin is added, the solder becomes thin and somewhat soft, gray-white in color, and very brittle again, so much so that the seams will separate if the article is

bent. For this reason great care must be exercised in making the mixtures of zinc and tin.

If metals are to be soldered which are very difficult of fusion, brass itself may be used directly as a solder; a very hard solder may be made by melting brass and mixing in copper. There are numerous formulas for hard solders, but not all of them are reliable; a few will be given here, all of which have been well tested and found excellent. The hardest are given first.

Yellow Hard Solders

(Very Hard)

Appelbaum's Compositions

I.

Copper	58
Zinc	42

II.

Sheet brass	85.42
Zinc	13.58

Karmarsch's Composition

III.

Brass	7
Zinc	1

Prechtl's Composition

IV.

Copper	53.30
Zinc	43.10
Tin	1.30
Lead	0.30

The foregoing compositions have the yellow color of brass, are very strong, and require very high temperatures for melting, so that they can be used for copper, bronze, steel, and all kinds of iron. The ones next given melt more easily than the first, and are suitable for all kinds of work with brass.

I.

Sheet brass	81.12
Zinc	18.88

II.

Copper	54.08
Zinc	45.29

III.

Brass	3 to 4
Zinc	1

IV.

Brass	78.26
Zinc	17.41
Silver	4.33

IV. is somewhat expensive on account of the silver, but has the valuable property of being at once tenacious and ductile, and can be worked into wire with hammer or rollers.

Still softer are:

I.

Brass	5
Zinc	2.5

II.

Brass	5
Zinc	5

Half-White

I.

Copper	53.3
Zinc	46.7

II.

Brass	12
Zinc	4 to 7
Tin	1

III.

Brass	22
Zinc	10
Tin	1

IV.

Copper	44
Zinc	49
Tin	3.20
Lead	1.20

I. (Volk's hard solder) and IV. (Prechtl's half-white) are quite readily fusible.

White

I.

Brass	20
Zinc	1
Tin	4

II.

Brass	11
Zinc	1
Tin	2

III.

Brass	6
Zinc	4
Tin	10

IV.

Copper	57.44
Zinc	27.98
Tin	14.58

A. Krupp, in his excellent work, gives the following table of the compositions of hard solders, all of which have been verified in practice. The proportions are given in percentage. The terms "hard" and "soft" refer, of course, to the respective degrees of fusibility, being simply comparative, as the whole class of solders which we are now considering are called in general "hard."

A. Solders Prepared from the Pure Metals

	Copper.	Zinc.	Tin.	Lead.
Very hard.....	57.94	42.06
Very hard	58.33	41.67
Hard	50.00	50.00
Soft	33.34	66.66
Soft (half-white)...	44.00	49.90	3.30	1.20
Soft (white).....	57.44	27.98	14.58
Soft	72.00	18.00	4.00
Soft (Volk's).....	53.30	46.70

B. Solders of Brass and Zinc

	Brass.	Zinc.	Tin.
Very hard	85.42	12.58
Very hard	7.00	1.00
Hard	3.00	1.00
Hard	4.00	1.00
Soft	5.00	2.00
Soft	5.00	4.00
Half-white	12.00	5.00	1.00
Half-white	44.00	20.00	2.00
White	40.00	2.00	8.00
White	22.00	2.00	4.00
White	18.00	12.00	30.00
Very ductile	78.25	17.25
For brazier's work.....	81.12	18.88

C. Brass Solders

	Copper.	Zinc.	Tin.	Lead.
Yellow, hard	53.30	43.10	1.30	0.30
Half-white, soft	44.00	49.90	3.30	1.20
White	57.44	27.98	14.58

German Silver Solders

The solders thus classified, as their name implies, are used principally for soldering German silver. This alloy contains nickel and is very hard and white, and it requires solders which have corresponding qualities. German silver belongs among the alloys which are very difficult of fusion, and the solders used for

it are those which have very high fusing points, and belong therefore to the general class of hard solders. They have great strength, and are used for other purposes, in cases where the object to be soldered is exposed to heavy strain. German silver solder can be given a color very much like that of steel, and is much used in steel work.

In regard to its composition, it bears this relation to ordinary hard solders, that while these may be considered to be brass with an admixture of zinc, German silver solder may be called a mixture of zinc and German silver. It is softer or harder according to the greater or less amount of zinc contained in it; but if this exceeds a certain limit, the solder becomes very brittle.

There are two principal varieties of German silver solder, called, relatively, hard and soft. The former is exceedingly strong, on account of the large amount of nickel it contains, and is sometimes called "steel solder," being quite generally used for soldering steel.

Soft German Silver Solders

I.

Copper	4.5
Zinc	7.0
Nickel	1.0

II.

Copper	35.0
Zinc	56.5
Nickel	8.5

III.

German silver	5
Zinc	4

I. and II. are quite similar in composition, and have correspondingly similar properties; in III., German silver, that is, a compound of copper, zinc, and nickel, is used directly, and in preparing this solder it is necessary to know the exact composition of the alloy, or to try the solder in small quantities, in order to judge of the correct amount of zinc to be added. It may be assumed that the proportions are correct, when the metallic mix-

ture is lustrous, and brittle enough to allow of pulverizing when hot, and when it will become fluid in contact with a red hot soldering iron.

Hard German Silver Solders (Steel Solders)

I.

Copper	35
Zinc	56.5
Nickel	9.5

II.

Copper	38
Zinc	50
Nickel	12

I. requires a very hot flame for melting, and II. can usually be melted only by applying bellows to the flame.

In preparing German silver solder by direct melting together of the three metals, the copper is first to be melted, then the zinc and nickel added simultaneously. It can also be made by melting German silver together with zinc, a method which is not only more convenient, but has other advantages, especially if the solder is needed only in small quantities. The temperature required for melting this solder is so high that some of the zinc, which is very volatile, will evaporate if used pure, and it is difficult to obtain a mixture containing the proper amount of zinc.

The German silver is first melted, and heated very hot, and about six-tenths of the quantity of zinc is then thrown in. The melted mass is immediately stirred with an iron rod and a sample of it is taken out, by means of an iron spoon with a beak, and poured upon a cold stone or iron plate. As soon as it has stiffened, it is put into a mortar to be pulverized. If a few vigorous strokes will accomplish this, the alloy is of the right composition; but if it cannot be pulverized, there is too little zinc. If, on the other hand, the alloy is so brittle, while still hot, that a blow of a hammer will break it to pieces, and if it is very easily powdered in the mortar, an excess of zinc is indicated, and it will not only be too soft, but lose in strength. Too much zinc is also shown by a very high luster.

More zinc can be added as required, and if there is already too much, this can be remedied in either of two ways; either the alloy is kept a long time in fusion, so that a certain quantity of zinc evaporates, or more German silver is added. This method is preferable, as it saves consumption of fuel, and no zinc is lost. The German silver should be added in the form of filings, as it is obtained from the manufactories of German silver articles, in order to insure quick and thorough mixture. The filings are to be scattered over the alloy, and stirred in with a hardwood stick. When this is dipped into the melted mass, the wood begins to decompose, on account of the great heat, and gases are developed which have a reducing effect, and cause an intimate mixture of the constituents.

In soldering German silver articles, which are not to be exposed to very high temperatures, the soft German silver solders are generally used, and the correct composition is hardly to be distinguished from the German silver itself, since the color is nearly the same. The solder is employed in the form of a fine powder, which has the advantage that it can be applied quickly and no more used than necessary.

It is best to heat the mortar, in which the solder is pulverized, very hot, and to pour out the melted solder upon a large iron plate, in a thin layer, which is at once broken in pieces with a hammer and thrown into the mortar. The powder, which will be in grains of uneven size, is put through a hair sieve, and the fine portions are used for solder, the larger particles being ground over again.

The process of pulverizing German silver solder, as just described, is a very troublesome one, as it not only requires a great expenditure of strength, on account of the tenacious nature of the alloy, but must be done within a short time, that is, while the metal is still hot. The following method of preparing the powder is preferable:

A cast-iron mold is made, in two parts exactly fitting together, and allowing the casting of a cylinder 20 or 30 centimeters long and 8 or 10 in diameter. This cylinder is rubbed on the inside

with oil and lampblack, to prevent the alloy from adhering, and filled with the metallic mixture. After it has become entirely cold the cylinder is placed in a mechanical turning lathe, and the turning chisel so adjusted that very fine filings are shaved off, which are then heated and pulverized. The cylinder may also be pressed against a rapidly-revolving steel disk, cut like a file, and the filings procured in this way.

SILVER SOLDERS

The solders which contain silver are very strong and tenacious, and are used not only to solder silver, but also for other metals, in cases where the objects to be soldered require great power of resistance. Two principal kinds of silver solder are distinguished, hard and soft, the former consisting of silver and copper, with sometimes a little zinc, and the latter containing, besides the metals just mentioned, a small amount of tin.

Hard Silver Solder.—According to the purpose for which this is intended, different compositions are used varying in fusibility. Silver workers use different solders for alloys of varying degrees of fineness, and the same ones are not always employed for re-soldering as for the first soldering.

Silver Solders

Very Hard (for Fine Silver Articles)

Copper	1
Silver	4

Hard

I.

Copper	1
Silver	20
Brass	9

II.

Copper	2
Silver	28
Brass	10

Soft

I.

Silver	2
Brass	1

II.

Silver	3
Copper	2
Zinc	1

III.

Silver	10
Brass	10
Tin	1

These solders serve principally for completing the soldering of silver articles done with hard solder, by retouching imperfect places. Some silver workers use for this purpose copper and silver alloys mixed with zinc, as for example, the following:

Copper	4
Silver	12
Zinc	1

Or,

Silver	5
Brass	6
Zinc	2

The latter is readily fusible, but also rather brittle, and is frequently used for soldering ordinary silverware.

Solders for Iron, Steel, Cast Iron, and Copper

I.

Silver	10
Brass	10

II.

Silver	20
Copper	30
Zinc	10

III.

Silver	30
Copper	10
Tin	0.5

Soft Silver Solder

Silver	60
Brass	60
Zinc	5

In the case of solders which are prepared with brass, care should be taken that neither of the metals in the composition contains iron, as it has been found by experience that the presence of a very trifling amount of this is sufficient to change the character of the alloy materially, making it brittle.

Silver solders are used in the form of fine filings or wire, the latter method of preparing it being especially adapted to the tenacious and ductile nature of the alloy.

In the large manufactories for silver ware it has become the custom in recent years to use the same alloy for soldering as that of which the silver article is made. It is used in the form of filings, and melted into the seams so that the object and the solder are really homogeneous.

GOLD SOLDERS

Gold, both pure and variously alloyed, is used to a considerable extent in soldering, but on account of its expensiveness it is limited to articles made of gold or platinum, or the most delicate small steel objects.

Gold alloys are of different colors, according to the kind and proportion of the other metals used. There are yellow, red, white, and green gold alloys. The color of the special alloy should of course be in harmony with the color of the object to be soldered, in order that the seams may be as inconspicuous as possible.

The fusibility of gold alloys varies as much as their color, and is lowered as the amount of gold in the alloy increases. Harder solders should therefore be used for objects of fine gold than for a poorer quality.

Gold solders are made from gold and silver, gold and copper,

and still more frequently from a mixture of all three of these metals; in some cases zinc is added, to make the solder softer. But this must not be done if the soldered articles are to be colored, as the zinc alloy will turn black in coloring. For objects which are to be wholly or partially enameled, the solders made of gold and silver, or of gold, silver, and copper, are the only ones used, and these are called "enamel solders."

Pure Gold Solder.—Before soldering apparatus had been devised by means of which platinum could be melted, pure gold was used for soldering articles made of this metal, such as are employed by chemists and in the manufacture of sulphuric acid. For this purpose, the gold is laid upon the seams in the form of fine rolled wire, or in thin strips, and melted with the oxy-hydrogen blowpipe. But experience has shown that platinum articles soldered with gold are far less durable than those made by direct melting together of the pieces of platinum with the blowpipe, especially in the case of the vessel used in distilling the English sulphuric acid. Of late years this process has become universal in the manufacture of platinum ware, and the gold is only used for repairing small platinum articles, such as the small crucibles and dishes for chemical laboratories. It requires a fierce white heat to melt it properly, and it is even then rather hard, so that the process of soldering demands great skill on the part of the workman.

Hard Gold Solder

Gold 750/1000 fine (18 carat).....	9
Silver	2
Copper	1

This is used for the finest gold articles.

Soft Gold Solder

Gold 750/1000 fine (18 carat).....	12
Silver	7
Copper	3

This is likewise used for fine gold, but is much more fusible than the one first given.

Gold Solder for Articles $583/1000$ fine (14 carat)

I.

Gold $583/1000$ fine (14 carat).....	3
Silver	2
Copper	1

II.

Gold $583/1000$ fine (14 carat).....	4
Silver	1
Copper	1

Gold Solder for Ordinary Gold Ware less than $583/1000$ (14 carat) fine

I.

Fine gold	1
Silver	2
Copper	1

II.

Fine gold	1
Copper or silver	1

Soft Gold Solder

I.

Fine gold	11.94
Silver	54.74
Copper	28.17
Zinc	5.01

II.

Gold $583/1000$ fine (14 carat)	10
Silver	5
Zinc	1

Enamel-Solder, Hard

Gold $750/1000$ fine (18 carat).....	37
Silver	9

Enamel-Solder, Soft

Gold $750/1000$ fine (18 carat).....	16
Silver	3
Copper	1

The degree of fusibility of the enamel must decide the question as to which one of these compositions to use. If it is very hard, the first solder is the proper one, as otherwise the seams would become so hot during the process of melting the enamel that the solder itself would melt. For ordinary gold ware soft enamels are generally used, and in this case the softer solder can be employed. It is easily melted with the common soldering pipe; the harder can also be melted in the same way, but the use of a special apparatus makes the process much easier and quicker.

ALUMINIUM SOLDERS

Since the discovery of aluminium and its production in considerable quantities, it has become a common material in the manufacture of various artistic objects. One of the greatest difficulties, however, in the past has been that there was no perfect solder for aluminium, and various alloys were used which gave unsatisfactory results. This difficulty has now been overcome, and it is possible to solder the metal so perfectly that in tests which have been made the metal itself broke before the solder gave way.

The French manufacturers use five kinds of solder for aluminium, all consisting of zinc, copper, and aluminium, in different proportions. These are given below. Parts by weight.

I.

Zinc	80
Copper	8
Aluminium	12

II.

Zinc	85
Copper	6
Aluminium	9

III.

Zinc	88
Copper	5
Aluminium	7

IV.

Zinc	90
Copper	4
Aluminium	6

V.

Zinc	94
Copper	2
Aluminium	4

There are also other compositions besides these. Bourbouze recommends, for objects which are to be further manipulated or worked on after soldering, a mixture of 45 parts of tin and 10 of aluminium.

Frischmuth gives the following alloys for solders:

	A.	B.
Silver	10
Copper	10
Aluminium	20
Tin	60	95 to 99
Zinc	30
Bismuth	5 to 8

The composition B (an ordinary soft solder) is adapted for soldering aluminium by means of the common soldering iron.

In preparing aluminium solders, the alloy of copper and aluminium is always made first, and the zinc added. First of all the copper is melted, and the aluminium put in gradually, usually in three or four portions. The two metals are of very different density, and the mixture should be stirred with an iron rod, to unite them as far as possible. Immediately after adding the last portion of the aluminium, the zinc is put in, and at the same time some fat or resin is thrown into the kettle, the whole is quickly stirred, the kettle removed from the fire, and the alloy poured into iron molds which have been rubbed with coal oil or benzine. The whole work must be done as quickly as possible after the addition of the zinc, or the solder will not remain in a suitable condition.

The zinc used should contain no iron, as a very small amount

of the latter would materially affect the fusibility and durability of the solder. The purpose of the fat or resin is to prevent the oxidation of the zinc, and, as before observed, the work must proceed as rapidly as possible from this moment, as the temperature of the mass is so high that if it were left long in fusion much of the zinc would evaporate.

On account of its resistance to chemical influences, aluminium solder is frequently used by dentists to unite the metallic parts of artificial teeth, but alloys for this purpose must not contain copper except in very small quantities, as this metal is easily attacked by acids.

Platinum and Aluminium Solder

Gold	30
Platinum	1
Silver	20
Aluminium	100

Aluminium and Gold Solder

Gold	50
Silver	10
Copper	10
Aluminium	20

Solder for Aluminium Bronze.—Aluminium and copper make a very beautiful alloy, and one of valuable properties, much used for soldering artistic objects. Aluminium bronze demands a special composition, and for this purpose a common soft (white) solder is generally used, mixed with zinc amalgam in different proportions, either 2, 4, or 8 parts of the solder to 1 of the amalgam. Zinc amalgam is an alloy of zinc and mercury, as evident from its name (amalgam) being the general designation for alloys of mercury with other metals. To prepare it 2 parts of zinc and 1 of mercury are united, with heat. The zinc is melted, the mercury quickly stirred in and the mixture quickly cooled. It is a somewhat brittle alloy, silver white in color. To make the solder for aluminium bronze, the soft solder is melted, the zinc

amalgam, finely powdered, added, and the mass at once poured out into molds.

The soldering must be done with a soldering tool made of pure aluminium; the solder would easily enough adhere, to be sure, to other metals, but would alloy itself with them, and its composition would be changed.

In using the five aluminium solders given above, the kind of soldering to be done must be taken into consideration; for small ornamental objects, for instance, No. 1 may be used; for larger articles, such as teapots, coffee pots, etc., No. 4 is most frequently employed.

Originally the solders composed of aluminium and zinc were the only ones used for aluminium articles; large objects were first put together with an easily fusible solder, and the soldering finished with a harder one. The alloys of aluminium and zinc have the disadvantage that they oxidize easily in melting, and the work is made much more difficult thereby. This can be remedied by dipping the fine grains of the solder (in which form it is used) in copaiva balsam, which acts as a reducing agent, besides excluding the air. But this is not necessary if the compositions containing copper are employed.—102

HOW TO SOLDER ALUMINIUM

There is no solder which operates with aluminium in the same way that ordinary solders operate with copper, tin, etc. There are two reasons for this.

First. Aluminium does not alloy readily with solders at temperatures as low as the other metals require, and it is consequently necessary, in soldering aluminium, to use a much higher temperature. Furthermore, aluminium alloys with lead only with great difficulty and with but a small proportion of lead at that; consequently lead solders are useless with aluminium.

Second. The surface of all aluminium is covered with a thin invisible coating of aluminium oxide. This coating forms instantly on the surface of aluminium and is very refractory, and its presence is responsible for the high resistance of aluminium to

corroding agents, since, although aluminium itself is soluble in a great many chemical compounds, this protective coating of oxide is insoluble in almost everything excepting hydrofluoric acid. While in general this coating of oxide is beneficial, in that it forms a perfect protection to the aluminium underneath, it is, by reason of its efficiency in this particular, responsible for the principal portion of the difficulty which occurs in soldering aluminium, as naturally no solder will alloy with aluminium oxide.

In soldering aluminium, therefore, it is necessary that this oxide be removed before the soldering can take place; and as it forms again instantly after removal, it is necessary that the removal of the oxide and the covering with solder shall be simultaneous. In soldering other metals, the oxide can be removed chemically. With aluminium this is not possible, and it must be removed mechanically by abrasion.

Bearing these facts in mind, it will be readily understood how aluminium soldering must be done. All the surface to which it is intended that the solder shall adhere must first be tinned. This is accomplished by heating the metal to a temperature above the fusion point of the solder used, and then rubbing the surface with a stick of the solder, thus rubbing the oxide off the surface with the solder itself, and covering the exposed points with melted solder, all in the same motion. In order to make sure that the tinning is thorough, it is better to rub the surface with a steel or brass scratch brush while the solder on this surface is still molten. This insures a thorough job of tinning. After the edges to be united are thus tinned, they may be sweated together with pure block tin, with the aid either of a soldering iron or blast lamp.

With regard to the composition of aluminium solders, zinc appears to alloy with aluminium more readily than any other metal available for the constituent part of the solder; consequently all solders which will readily tin aluminium contain zinc in varying proportions. The solders which we have found to be most satisfactory are composed usually of tin, zinc, and a very small proportion of aluminium. These solders do not run very freely nor

fuse as readily as ordinary solders, and it is necessary, as stated above, to use a higher temperature—so high in fact that extreme difficulty is found in using these solders with a soldering iron, and it is generally necessary to use a blast lamp.

Another thing which must be borne in mind is that solder will not flow into an aluminium joint, even when tinned, by capillary action as it does into copper or tin joints, and it is therefore necessary to place on the surfaces to be united all of the material necessary to sweat them together before the edges are brought into contact. In soldering aluminium joints it is necessary that both the tinning and sweating shall be most thoroughly done; otherwise the joint will not be durable.

On account of the presence of zinc in the tinning solder, the solder is decomposed by moisture, and unless the work is so well done that the joint is absolutely waterproof, it will not be durable. The quality of the workmanship has more influence than anything else on the permanence of the work.—39

CHAPTER IV.

THE HANDY MAN IN THE FACTORY

One is apt to think of the handy man as a pottering amateur, who delights to dabble at all classes of work, but cannot do any single thing in a thorough, workmanlike manner. While there are such handy men, they constitute only a part of the classification, which is broad enough to include the most skillful mechanics. In the large machine shop it frequently happens that a special piece of work of unusual character must be done. The ordinary mechanic is nonplussed. He cannot do anything out of the common run. But the handy man steps forward and suggests a brand-new method of procedure, which solves the difficulty. Every machine shop needs a handy man.

MILLING ATTACHMENT FOR THE LATHE

In a certain factory where the writer was employed, a machine was being constructed which called for a 3-inch shaft cut with a spiral groove of very flat pitch. It was impossible to cut this groove with a screw-cutting lathe, owing to the unusual pitch. The piece was too large for the universal milling machines in the shop, and the pitch was not flat enough to be cut in a planer.

The handy man of the shop proposed that a milling attachment be used. Accordingly, a bracket *A* was made with bearings for two shafts *B* and *C*, lying in planes at right angles to each other, the one horizontal and the other inclined. The horizontal shaft *B* was fitted with a worm, which meshed with a gear *D* on one end of the shaft *C*, the opposite end of which carried a face mill *E*. The inclination of the shaft was such that the plane of the cutter coincided with the desired pitch of the spiral groove. The bracket *A* was bolted to the cross-feed slide of the lathe. The shaft *B* was fitted with a pulley *F*, which was belted to a long pulley or drum *G* on the countershaft above. A special gear was required

to feed the carriage at the requisite speed. A bracket *H* was bolted to the head-stock of the lathe, and furnished bearings for a shaft which was fitted at one end with a pinion *J*, adapted to engage the face gear of the back drive, and at the other with a gear *K*, adapted to mesh with a gear *L* on the feed screw. By this means a 12 to 1 reduction was furnished between the face plate and the screw. The low speed of the driving pulleys was

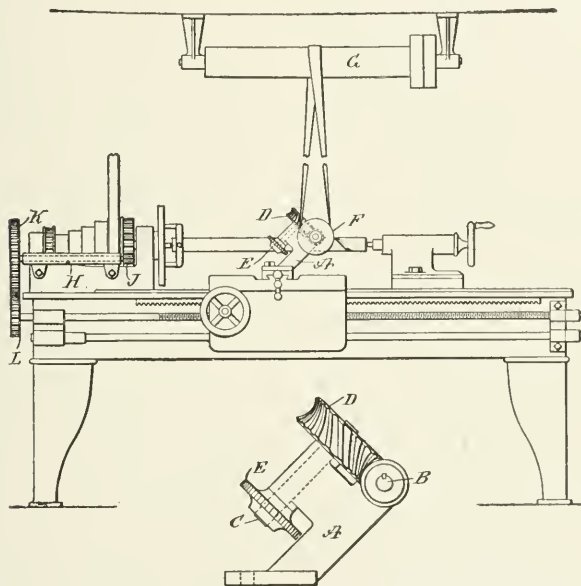

Fig. 140—A milling attachment for the lathe

used so that a single rough cut and a finishing cut sufficed to form the spiral groove in the shaft. This idea was the forerunner of the thread milling machine.—42

CUTTING A GROOVE OF 42-INCH PITCH ON A $1\frac{1}{2}$ -INCH SHAFT

The writer when a lad serving his apprenticeship cut on a lathe with a feed screw of $\frac{1}{2}$ -inch pitch a groove in a $1\frac{1}{2}$ -inch shaft to a depth of $\frac{1}{4}$ inch, which had one turn in 3 feet 6 inches.

The method adopted was to use six change wheels and drive the feed screw with a pulley fixed to the side of the wheel on the screw. There was an open and cross belt on the countershaft, so that the motion could be reversed. Another belt ran from the countershaft to the pulley on lathe feed screw. The nut engaging the lathe saddle was not taken out of gear with the feed screw, but the saddle was run to and fro by reversing the motion of the screw.—80

CUTTING A CAM GROOVE WITH A LATHE

The accompanying illustration, Fig. 141, shows how a cam groove was cut in a drum cam by means of an improvised milling attachment on a lathe. The problem was to duplicate a cam which had previously been cut. This was used as a pattern or

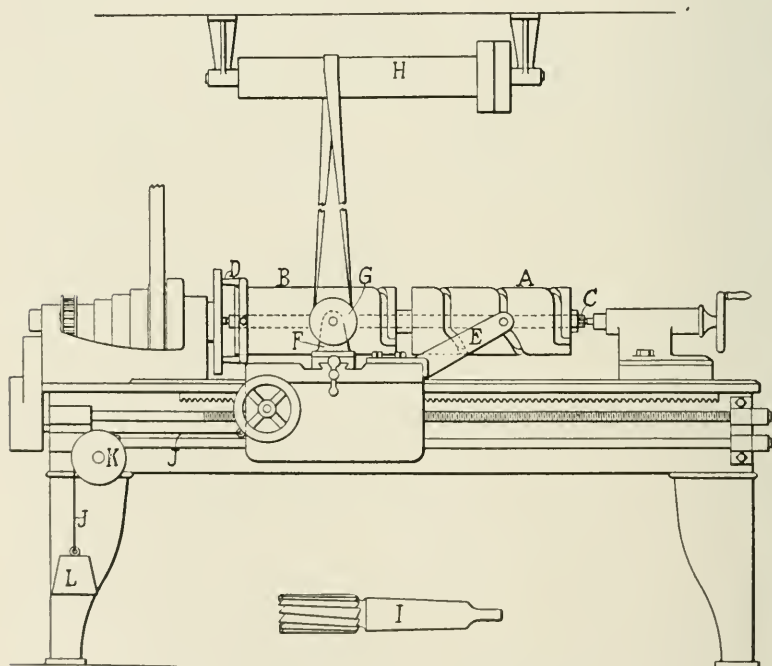

Fig. 141—Cutting a cam groove with a lathe

form to guide the milling cutter while cutting the blank. The form *A* with the blank *B* were mounted on an arbor *C*, and placed between the lathe centers. They were connected to the face plate by means of a dog *D*. An arm *E* was bolted to the carriage, and was provided with a roller to engage the cam groove in the form. The carriage was disconnected from the feed screw, so that as the form revolved it would be fed by the roller and cam groove. A pulley *K* was mounted at the head of the lathe bed, and a cord running over this pulley was provided with a weight at one end, while its other end was attached to the carriage. In this way a constant tension in the direction of the headstock was maintained. On the cross-feed slide a bracket *F* was mounted, and this carried a shaft fitted with a pulley *G*. The latter was belted to a wide pulley *H* on a separate countershaft above the lathe. The pulley *H* was in reality a drum long enough to accommodate the belt as the carriage traveled across the face of the drum which was to be cut. The shaft of pulley *G* was provided with a socket to receive an end mill *I*. The latter was rotated at a suitable speed, by its connection with the pulley *H*, to cut the cam groove while the carriage was moved slowly toward the headstock by the rotation of the form. The lathe was geared down to its lowest speed, and belted to a small pulley on the countershaft.—42

IMPROVED LATHE CHUCK

Many of the standard bench-lathe chucks on the market present the disadvantage of having a very short gripping surface. It is also difficult at times to release the work from the draw-in chuck without tapping on the hand wheel. When the rear end of the collet has a larger hole than the front, the work is also constantly tossing about. The accompanying engraving shows the construction of a lathe chuck which is designed to remedy these troubles. This chuck was especially built to hold drill rods from 3/16 to 5/8 inch in diameter. The body is made of tool steel. The taper shank should first be fitted to the lathe in which the chuck is to be used, so that the latter may be inserted in the spindle and

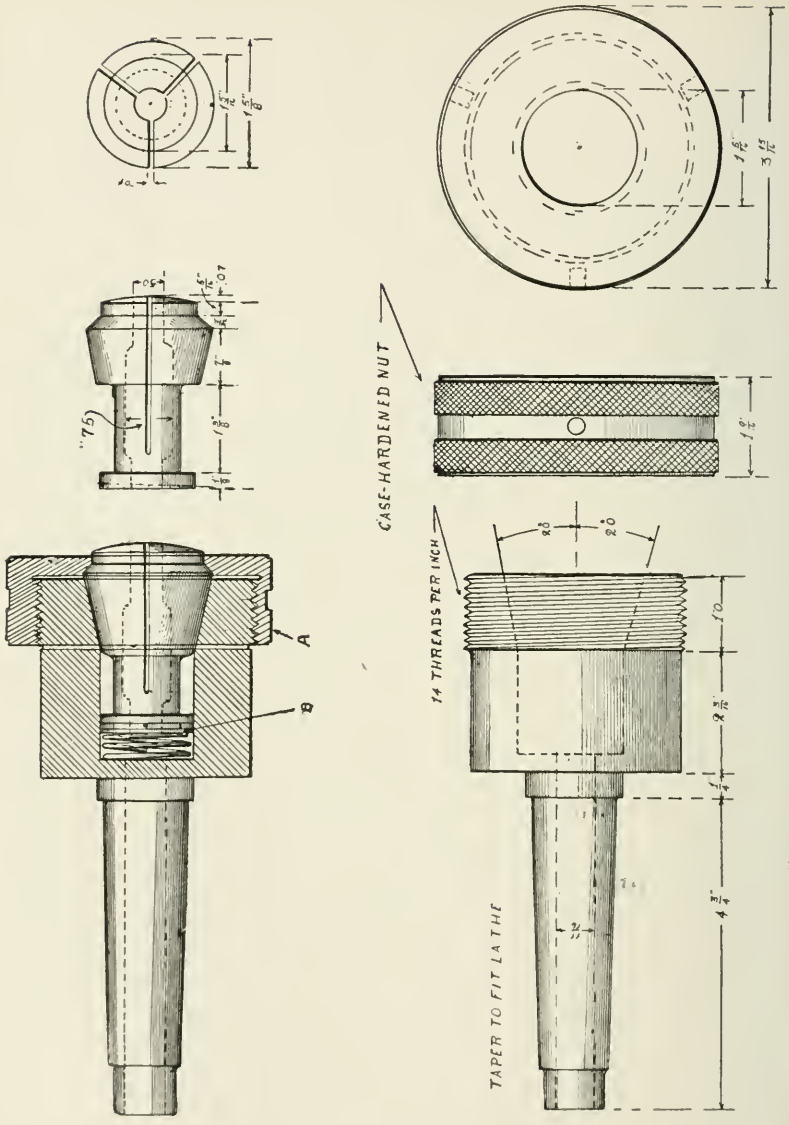

Fig. 142—An improved lathe chuck with spring-actuated collet

finished. The nut *A* is made of machine steel and casehardened. It may be turned with a spanner wrench, holes being provided as shown. Collets of the required size are made of tool steel and hardened. The rear end of the collets have holes of the same size as the front, so as to prevent the work from being tossed about. A spring is inserted in the body of the chuck, which is held in position by a flanged collar *B*, which in turn is retained by dowel pins. When the collet is in position, it is forced against the collar and spring by nut *A*. When this nut is released, the spring forces the collet out and thus releases the work, which can be removed without trouble. These collets should be tempered so that the center is as soft as possible, to prevent their being easily broken. As will be seen by referring to the illustration, this chuck can be made in almost any shop without the use of special tools.—17

CORRECT SHAPE FOR LATHE DOG

A clamp lathe dog should be balanced by making the straight jaw much wider, which gives the desired weight for balancing the opposite jaw that enters the face plate of the lathe. One can readily see the proportions in Fig. 143, which are just as tasty as those of an unbalanced dog. In turning small slender work which must revolve rapidly, the value of the balanced dog will be appreciated.

With large work it does not make any material difference.—6

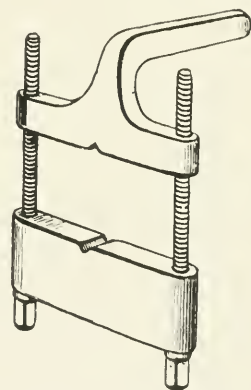

Fig. 143—Correct shape for the lathe dog

ACCURATELY SETTING THE SLIDE REST FOR TURNING PARALLEL WORK

The mechanic using the slide rest dreads to work the swivel for tapered work after he has once set it on the graduation mark, because it is quite difficult to set it absolutely parallel. The

slightest error in setting the swivel will be exaggerated three-fold in the work. When setting the slide rest with the attachment here shown, it is done accurately and very quickly. A small bracket is made and fastened on the slide rest with two machine screws. This holds an L-shaped piece marked *A*, which is pivoted on two pointed screws in the bracket. In setting the

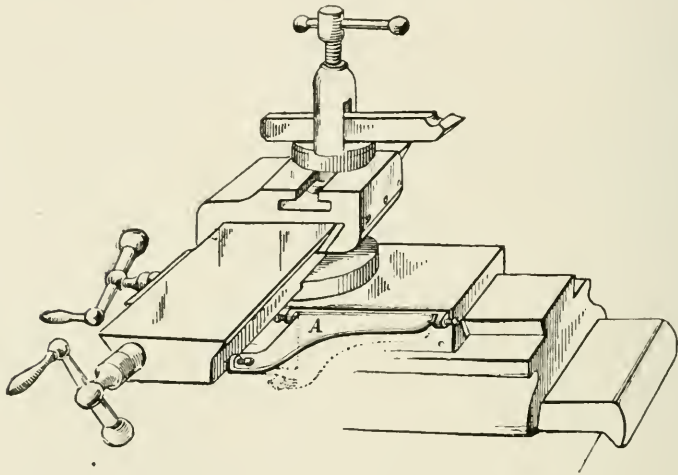

Fig. 144—Device for setting the slide rest.

slide rest for turning parallel work, the L-piece is simply swung up, allowing the swivel part of slide rest to engage it.—6

A PORTABLE POLISHING LATHE

Some time ago the writer took an order to polish and nickel-plate the cylinder covers of a British battleship. Each cylinder weighed 4,000 pounds and each was 6 feet 6 inches in diameter; and considering that nickel baths are no deeper than 33 inches and polishing spindles are only 2 feet long, the proposition was a tough one—a nut which couldn't be cracked by ordinary means.

The cylinder covers arrived at the factory drawn by eight powerful horses, and even special tackle had to be devised to

handle the big, unwieldy things. Every man and boy in the factory laughed at the idea of buffing and polishing them inside of a week. But the work was done on time.

A steel spindle was made, measuring 33 inches long by 1 inch in diameter, and it was fitted with a brass bow handle to be held in the left hand. The spindle had at the center a grooved pulley to receive a rubber band running from a corresponding grooved pulley overhead. On the spindle a brass handle was mounted, which could be moved to any desired position and secured by means of pins which were fitted into holes in the spindle. The spindle revolved within the brass handle on the right side, and within the bow handle on the left side, and was freely run at 2,000 revolutions per minute with perfect ease and smoothness.

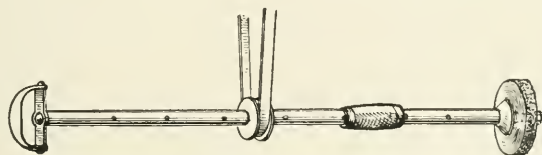

Fig. 145—A portable polishing lathe

The pulley, like the brass handle, was adjustable and could be secured in any desired position by pins in the spindle.

The right end of the spindle was tapered and threaded to receive a polishing buff or emery wheel or other tool, which was secured thereon by a nut. This portable polishing lathe was made at small cost, and proved to be a decided success. In one short half day the cylinder cover was thoroughly buffed, and in another half day it was plated in three sections, by revolving it over the nickel bath. Then it was let down on the factory floor to be finally polished with walrus-hide buffs. One man squatted down on the floor, holding the portable polishing machine in his hands, and directing the rubber drive band running over the grooved pulley. The buff carried on the end of the spindle revolved at 2,000 per minute over the surface of the cylinder cover, making the operation like 'child's play, so simple was it.—28

HOLDER FOR GRINDERS

A very simple device for holding dies and other work of similar shape while grinding on small emery wheels may be made as shown in the sketch.

Between the top plate *A* and bottom plate *B* are two blocks, *C* and *D*, of sufficient thickness to allow the work to pass freely

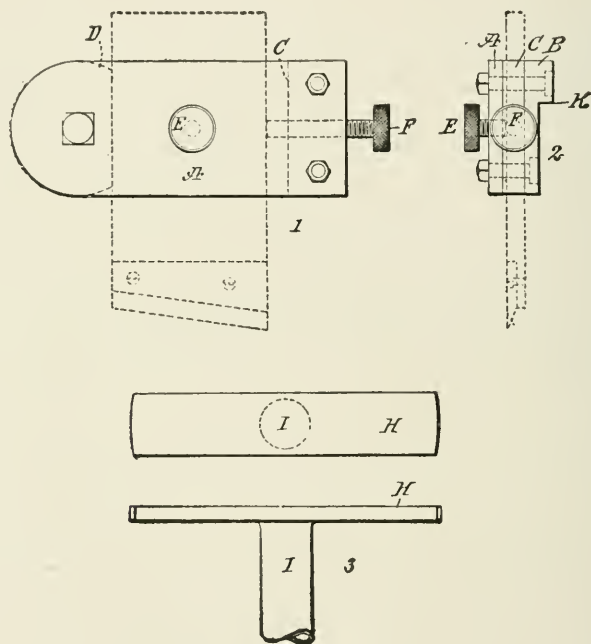

Fig. 146--Holder for grinders

between *A* and *B*. The block *C* has a knurled screw passing through it, which firmly holds the work against the block *D*. The latter is formed of a circular piece and may be clamped at any desired angle by means of a nut.

The knurled screw *E* holds the work against the lower plate. All bolt heads are sunk flush with the bottom plate. *H* is a suit-

able rest for the above clamp. Its shank *I* is turned to take the place of the ordinary rest of a small emery wheel. By raising or lowering the rest, the required clearance is obtained. When the grinding is finished, the edge of the rest engages the shoulder *K* of the lower plate *B*, thus making it certain that each piece will be ground at the same angle and length.—16

CUTTING KEYWAYS ON A DIE SINKER

The accompanying drawing shows the way in which a die sinker may be equipped for cutting keyways in piston rods and

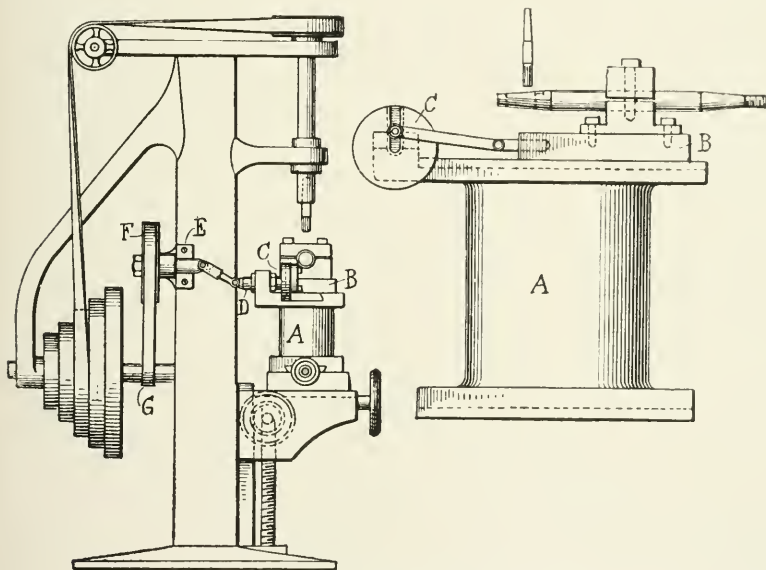

Fig. 147—Cutting keyways on a die sinker

valve stems and drift holes in drill and milling-machine sockets.

Every machinist knows that it is quite a job to drill, chip, and file a keyway in a piston rod or valve stem. A device of this kind has proved itself to be just the thing for such work, and it can be made in any "one-horse" shop with very little cost.

Fig. 147 shows the device and the way in which the work is clamped. Stand *A* is machined, and a dovetail is cut across its bottom to fit the dovetail of the knee of the machine. Slide *B* is machined to fit the top of *A*, and slotted crank disk *C* is attached to shaft *D*. A T-slot is cut half way across the face of the disk *C* to receive an adjustable crank-pin, which gives the slide *B* the stroke required for the keyways. Bracket *E* is attached to the side of the die sinker to receive a short shaft, one end of which carries pulley *F*, while the other end is connected by a universal coupling to the shaft *D*. Belt *G* passes over the driving shaft of the die sinker and around the pulley *F*, which drives the work to and fro while the keyway is being cut. The machine spindle is run at the required speed, and while the work is moving back and forth under the cutter it is fed up into the cutter by means of the elevating screw of the die sinker. This device is simple and practical in its construction, and is now used with perfect satisfaction in the shop where the writer works.—17

SCREW-SLOTTING ATTACHMENT FOR LATHES

The accompanying drawing suggests a method of converting an old lathe or speed lathe into a screw-slotting machine.

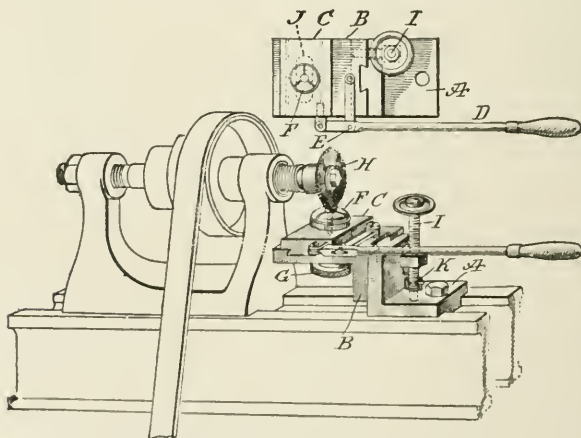

Fig. 148--Screw-slotting attachment for lathes

The angle plate *A* is secured to the bed of the lathe. In the vertical face of angle plate *A* is a dovetail groove, in which angle plate *B* fits, so as to afford an up-and-down motion. On the top face of angle plate *B* is a dovetail groove, in which slide plate *C* operates. Lever *D* pivots on swivel *E*, giving movement to slide plate *C*. Place the screw to be slotted into draw chuck *F*, and tighten on draw wheel *G*. With the fixture so placed on the lathe bed as to cut the screw centrally, the depth of the slot may be regulated by adjusting screw *I*. By moving the lever *D*, the screw is fed into the saw *H*. There is an elongated slot *J* in the angle plate *B* to allow the draw clutch to pass through and move back and forth. In angle plate *A* is a stud *K* to hold in position the adjusting screw *I*.

By a little practice the screws may be slotted very rapidly.

MICROMETER ATTACHMENT FOR THE MILLING MACHINE

A practical and simple tool for accurate milling-machine work is shown in Figs. 149 and 150.

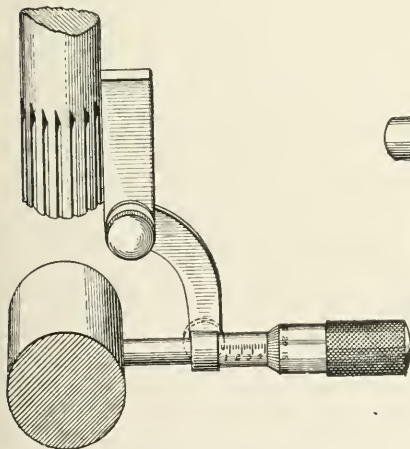

Fig. 149—The micrometer attachment used for centering work under an end mill

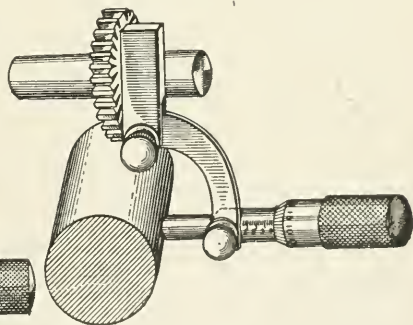

Fig. 150—Centering the work under a face mill

A common method of setting the work central with the cutter is to place a square on the plate of the machine, with the blade in contact with the work, and caliper between the upper end of the blade and the cutter, first on one side and then on the other. The cutter of course is central when the caliper reads the same on both sides. The graduations on the machine are also used.

After working along these lines for some time, the writer made this micrometer attachment. The stock of the gage is shown as placed against the cutter, and the micrometer barrel is adjusted to make contact on the work.

The work is adjusted until the micrometer reads alike on both sides.

This tool is also handy on lathes, planers, shapers, and for a depth gage.—17

CRANKPIN TURNING DEVICE

Some time ago we had a crankpin to true up on a double 20 x 40-inch Corliss engine that was worn so out of round that the engine pounded like a steam hammer. As there was no crankpin-turning device available, and as all machinists know it is a heart-breaking job to attempt to file a crankpin $6\frac{3}{4}$ inches in diameter and $7\frac{1}{4}$ inches long, round and square with the face of the crank, the writer proceeded to design the device illustrated. It is a cheap and simple rig, and answered the purpose as well as a \$5 crankpin turner. It consists of two rings *A* and *A'*, fastened together with three bars *B* set at 120 deg. apart, cap screwed to the inner finished faces of the bars. There are three bearing blocks *C*, which fit the diameter at the outer and enlarged end of the crankpin. The inner ring *A'* is bored to fit the shoulder *E* of the pin. A piece of finished square key steel is fitted and fastened with set screws to the rings *A* and *A'*. It acts as a guide or way for the tool carriage *G*. The tool carriage, or the movable block to which the turning tool is fastened or clamped, has a square hole through it to fit the guide-bar *F*, and is free to move along it without wobbling. A hole is bored and tapped through the end of the carriage for the feed screw *H*.

Attached to the end of the feed screw is a small rope sheave which is belted to the sheave part of the handle with a $\frac{1}{2}$ -inch rope, giving an automatic feed as the handle turns on its axis, while the machine is in operation.

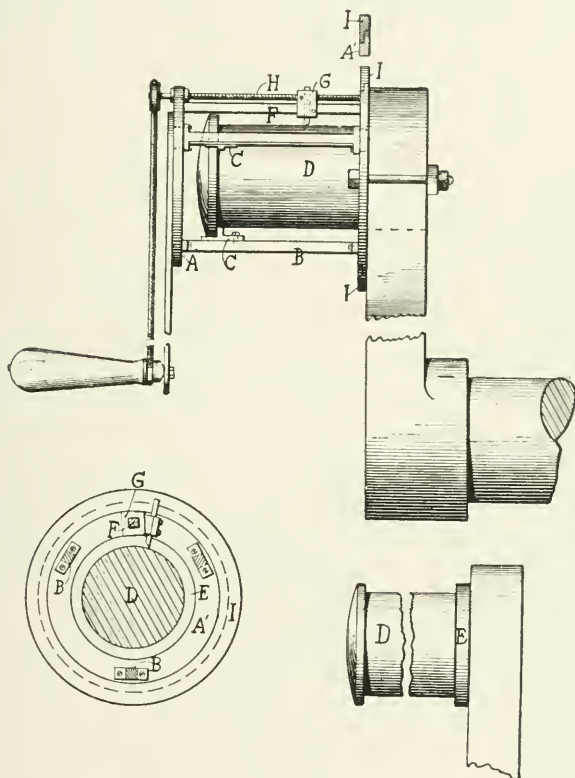

Fig. 151—An improvised crankpin turner

In making a device of this kind, the hole in ring A' , preliminary to the final finishing, should be left small, and the three bearing blocks should be cap-screwed to the spacers, the backs of the bearing blocks only being finished. When the spacers have been cap-screwed securely to the rings A and A' , the partly assem-

bled machine should be chucked in a lathe, and the bearing blocks *C* bored and faced to fit the end of the crankpin. The hole in the ring *A'* should then be bored to fit that part of the enlarged pin nearest the crank. This being done, the square rail *F*, tool carriage, and feed screw can be put in place. On attaching the machine to the crankpin, the three bearing blocks are removed, the machine slid over the crankpin until the ring *A* fits over and against the enlarged end *E* of the pin and against the face of the crank. The bearing blocks *C* are then fastened in place, ready to do the work. A ring *I* is counterbored to fit ring *A'*, as shown, and is then clamped against the arm of the crank with two bolts, one on each side. The necessary clearance is allowed in ring *I*, so as to allow ring *A'* to revolve when ring *I* is clamped securely against the arm of the crankpin.—17

BORING CYLINDER BUSHINGS FOR LOCOMOTIVES

We had some cast-iron cylinder bushings to bore and turn for locomotives. As there were about twenty-five bushings in the

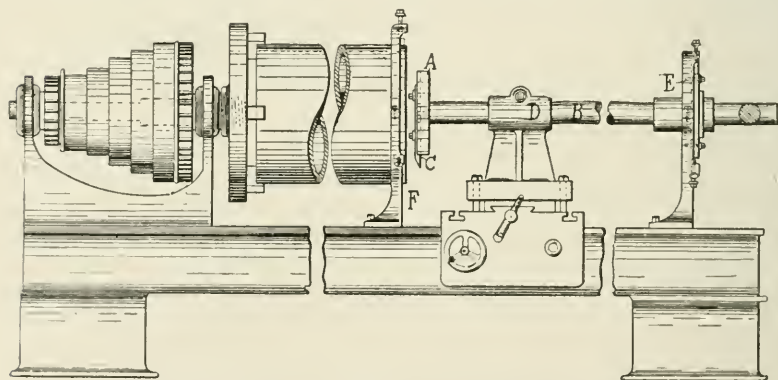

Fig. 152—Boring a locomotive cylinder bushing

lot to be machined, and we were in a big hurry to get the job out, we rigged up a special tool for the job. Fig. 152 shows the tool, and the way in which it was attached to a lathe. The boring head *A*, which is keyed to the bar *B*, had six dovetailed

slots cut across its periphery. These slots were used for holding hard-wood blocks, which fitted closely into the bore and guided the bar. A boring tool was clamped in the groove across the head, as shown at *C*. The split sleeve *D*, which was fastened to the lathe carriage, supported one end of the boring bar, and the sleeve was clamped to the bar when boring, as the feeding was done by the lathe carriage. The bar was also supported by a steady-rest, as shown at *E*. Before the boring bar was placed in position, the end of the cylinder was trued up, as the outer end of the cylinder had to be supported by a steady-rest *F*. In starting the cut, it was necessary to steady the bar by clamping the sleeve *D* close to the boring head; but when the head had entered the cylinder, the sleeve was moved out as far as the bar would permit, and again clamped to the bar. The hard-wood blocks referred to were used for the finishing cut. The

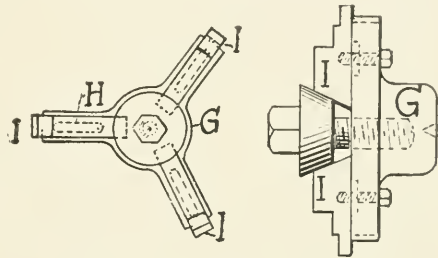

Fig. 153—The adjustable centers

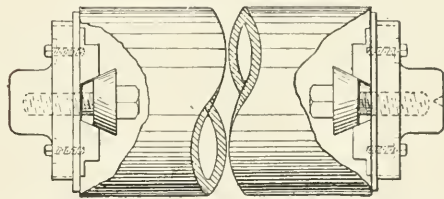

Fig. 154—The centers fitted into the cylinder

cylinder bushings bored in this way were absolutely straight and true, and the work entirely satisfactory. After the bushings were bored, they had to be turned to suit the cylinders, and these centers were also made for the job. Fig. 153 shows the centers, and Fig. 154 shows how they were used. Center head *G* is cast with three arms 120 deg. apart. A slot *H* is cut in each arm, and lugs *I* are fitted in the slot, allowing for the required adjustment. The inner end of each lug is tapered off at 45 deg. angle, and the head of the stud *L* has the same taper as the lugs, and is screwed into

the center head *G*, to adjust the lugs to suit the bushings. After the proper adjustment has been made, the lugs are locked with the bolts *M*, then the job is placed on the centers of the lathe and turned off to the required size.—17

FANS ON MACHINE TOOLS

The writer recently saw in a Buffalo factory, two improvised fans attached to a large milling machine. The operator of the machine fastened on each of two rapidly rotating shafts a piece of tinned sheet iron, forming a fan about 12 inches long and 8 inches wide. The tin plate was simply curled as closely about the shaft as possible, then tightened by means of a wooden wedge. The shafts rotate about 300 times a minute, hence the fans cause a delightfully cool breeze, which not only cools the operator, but also blows away the iron dust from his presence. Thus the operator need inhale but little of such dust.

Many thousand machine tenders in the land might profit by imitating this truly simple, useful, and cheap device. The fan does not cost three cents.—84

A MUFFLER FOR GAS ENGINES

The handy man who has a gasoline engine in his shop and which exhausts outside into the atmosphere may silence that disturber of peace somewhat in the manner shown in the accompanying illustration. It removes the sharp penetrating quality of the noise without causing any back pressure. The end of the exhaust pipe, which must be vertical in order to prevent clattering of the segments, is split into eight parts by means of longitudinal cuts made with a hacksaw. The cuts should extend for three or four feet in the pipe.

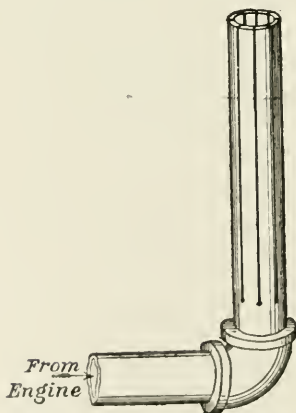

Fig. 155—The slotted exhaust pipe serves as a muffler

AUTOMATIC LUBRICATING CUP

In lubricating the reciprocating parts of vertical engines, there is considerable waste of oil, and the lamp wick dangling from the end of the oil pipe forms a collector of dust and grit, which is carried to the bearings. The waste of oil is due principally to the fact that when the engine stops the oil still continues feeding, and drops into the crank pit rather than into the oil cup.

Much of this can be avoided by the use of an oil cup such as shown in the accompanying sketch. It consists of a cup of the usual shape having inside a mushroom-shaped valve *B*, which is ground to a tight seat at *E*. The stem *D* passes through a clearance hole *C*, in the bottom of the cap. When the cup is filled with oil, the mushroom valve prevents its flow as long as the engine is at rest.

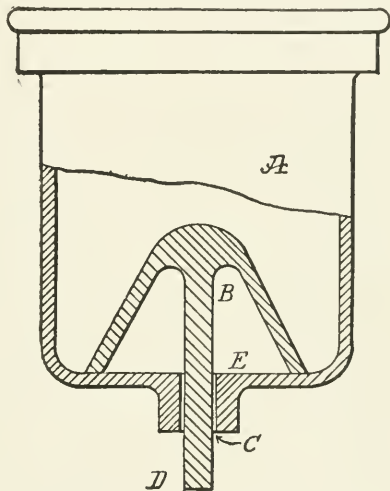

Fig. 156 -An automatic lubricating cup

The cup is placed directly over the oil cup which is to receive the oil, and which moves in a vertical direction.

By means of adjusting screws its height is so arranged that the stem of the valve is raised slightly as the oil cup comes to the top, thus allowing a small amount of oil to pass inside the valve and flow down the stem. The receiving cup should be filled with horsehair, to rub off the necessary oil from the stem.

The oil flows only when the engine runs, and in proportion to the speed of the engine.

No time is lost nor oil wasted in shutting off the supply when the engines are stopped, and the stem can be easily wiped clean.

This cup could be used on horizontal engines by a slight modification of the stem; but on vertical marine engines, as on tugs, where the engine is run intermittently, the writer has seen it do good service and save many times its cost in oil, labor, and hot bearings.—21

A HYDRAULIC TEST FOR THE BOILER

Some time ago my boiler engine was frozen up in a cold snap, and I wished to give my boiler a hydraulic test before steaming up again, to see if it was fit for business. I had no force pump or apparatus of any kind, yet I tested the boiler to the desired pressure, 100 pounds. I have had conversations with engineers since then, and not one of them could tell me how to make such a test without any apparatus, so I believe the idea may be useful for Handy Man's Workshop. I filled the boiler completely with water, leaving no air space whatever, then built a small fire under the boiler, and as the cold water warmed up and expanded, I watched the pressure gage rise until it reached the desired testing pressure, when I opened one of the try cocks, allowing a small quantity of water to escape and relieve the pressure. Having found things O. K., I drained water from the boiler to the proper level and proceeded to get up steam.—47

METHOD OF PATCHING A BOILER

The following method of bolting a patch on a boiler perhaps shows some originality. It was required to patch the bottom of a combustion chamber of a very old boiler, badly pitted on the water side. Riveting was impossible for want of space. The patch was five feet by two, fitted on the fire side, and the greatest difficulty to overcome was to make the bolts watertight, owing to the impossibility of driving them or getting a contact under the heads against the bad plates. Gaskets did not appeal to the repairer, and a metallic contact was aimed at. This was accomplished by making each bolt act as an ordinary miter-seated valve. They were turned a hand-workable fit (all but the last $\frac{1}{4}$ inch,

which was tight) to reamed holes of steel, and case-hardened, fitted in from the water side, and hammered up with a spanner. The "seat" was sunk into the boiler plates. There were also-

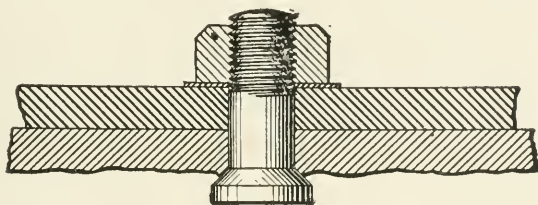

Fig. 157—Bolting a patch on a boiler

together 128 bolts in the patch. The job when finished passed a government inspector's examination, and steamed from Honolulu to San Francisco without mishap.—46

STRAIGHTENING BUCKLED CASTINGS

It is a rare occurrence for long castings to leave the molds perfectly true and level. When cooling off in the sand, they often buckle out of shape. It is necessary, as in the case of drainage cover castings, for instance, to have them level, so that when the horses and vehicles pass over them, they will not tilt or shake. These castings are usually straightened in the blacksmith's shop in the following manner:

Take, for example, a grating like that shown here, which is used by street rail-

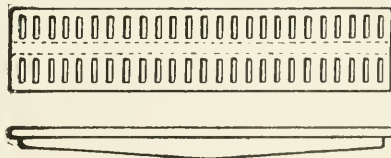

Fig. 158—Straightening buckled castings

ways to allow the surface water to drain into the sewers, and which has to fit very snugly the recess of the trap box in which it lies. The casting is placed in the fire, and heated to a dark cherry red, when it is taken out and placed upon the anvil upside down. Two blocks of iron, about the size of a half brick, are placed at either end of the casting, and a

section of car rail the length of the casting is placed on top. A couple of clamps are slipped over the rail and casting, in the center or where the buckling of the casting appears. The bolts of the clamps are then screwed up, at the same time using the wrenches with a quick turn, until the hollowness of the grating is about one-eighth of an inch more than necessary, which is tried by means of a straight edge. When the clamps are removed, the hollowness will be gone, and the casting will be found to be perfectly level.—3

REPAIRING RAILROAD PICKS

The body of a pick is generally made of a low-grade steel, but the points are either of cast steel or high-grade tool steel.

On account of the body being of a low grade, it is no unusual thing for an energetic laborer, when hammering the pick down upon the helve or handle, to split the eye or even burst it open.

For this reason, in one of the railroad shops, where many of these picks are repaired, the blacksmith conceived the idea of drilling two holes near either side of the eye, as shown in No. 1, and inserting a couple of countersunk rivets, after which he declared that very few picks came to him for repairs in that particular spot. But to my mind the best wrinkle he gave to me was in welding the steel points on the ends.

No. 2, at the right-hand side, shows one of the usual manners of doing this. The ends of the pick are split open for a little way, to take the point, which is made wedge shape at one end, and the whole welded together and brought to a point, as in No. 1. But it was noticed that when these same energetic laborers used their picks for levers, they came back to the shop with the points missing, and wide open jaws, as shown to the left of No. 2.

Another method, called the German, I believe, is to weld a piece of steel on one side of the point, as shown to the right of No. 3. When any of these came back, they were worse than the first, for they came back not only minus the point, but the half-welded jaw.

It will also be seen that in both of the cases mentioned, the

wear and tear of the pick is on the low-grade steel jaws as much as the high-grade steel points. So instead of splitting open the ends of the pick, the blacksmith split the steel point as shown to

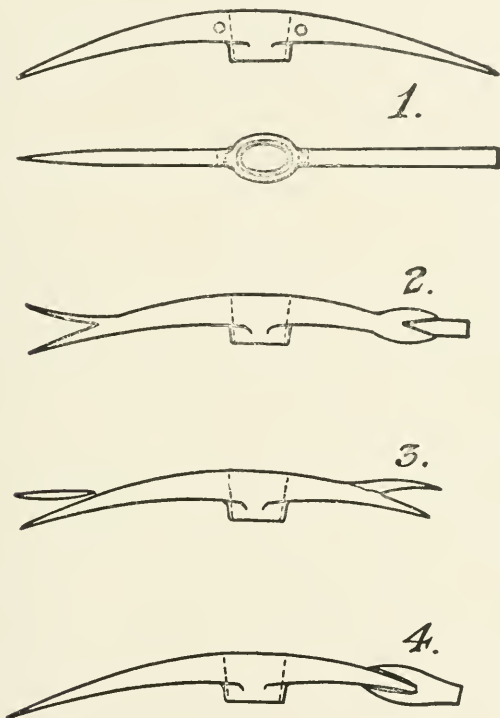

Fig. 159—Repairing railroad picks

the right of No. 4. When these came back to the shop for repairs, they were generally as seen to the left of No. 4, and only needed the points put to the emery wheels.—3

CHAPTER V.

THE HANDY MAN'S EXPERIMENTAL LABORATORY

CHEMICAL FLASKS FROM ELECTRIC LIGHT GLOBES.

To those who work in chemistry, whether as amateurs or professionals, there is no more useful piece of apparatus than a flask. Anyone who can procure old electric light globes can make all the flasks he needs in a short time and at practically no expense. Globes of various dimensions, from the small 2 candle-power to a 32 candle-power, may be used, thus giving a number of different sizes.

All the apparatus or tools needed are a Bunsen burner if gas is available, if not, a gasoline torch, and a three-cornered file. First hold the base of the lamp in the flame a few moments, until the wax holding it on is sufficiently softened to allow of pushing off the brass base with the tang of the file. Clean most of the wax off the glass, and with the file carefully make a scratch all around the glass just back of the place where the tube holding the filament is sealed in. The end will then, if struck a light glancing blow, break out, leaving a clean round hole. With a little practice this can be accomplished quickly and neatly. Now hold the sharp edges of the opening in the globe in the flame until soft, and quickly, with the tang of the file, smooth down and turn out the edge into a sort of a flange, taking care to keep the hole round. When the globe has cooled, hold it with a cloth and place the large end in the flame until it softens. Then press it down on a dry board until the bottom is sufficiently flattened to make the flask "steady on its legs." The flask is now finished with the exception of annealing. When several of the flasks are finished, they should be placed in a vessel of brine and gradually heated up to the boil-

ing point, and then set aside to cool. They can now be used in the same way as the ordinary commercial flask.—76

STOPCOCK OF GLASS TUBING

A small stopcock may be easily made out of two glass tubes and a rubber sleeve. The outside diameter of one tube is smaller than the inside diameter of the other. The end of the smaller tube is softened in the flame of a Bunsen burner and closed. With a file a small slot is cut in the side of this tube. A piece of rubber tubing is fitted over the two glass tubes, as shown in Fig. 164. The smaller tube is not held so tightly by the rubber sleeve as is the larger tube, and it will slide quite readily therein. When the smaller tube is drawn outward, the rubber sleeve covers the

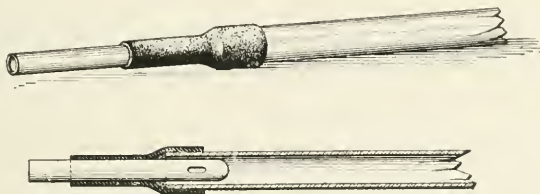

Fig. 160 - Stopcock of glass tubing

slot therein, preventing the passage of liquids or gases through the two tubes. To open the cock, the smaller tube is forced inward, as shown in the sectional view, and the liquids or gases can then flow freely through the two tubes by way of the slot in the smaller tube.

STARTING DEVICE FOR SIPHONS

How to start a siphon running is sometimes quite a problem. If the liquid that is to be siphoned off is harmless, the siphon tube may be filled by suction with the mouth at the end of the longer arm. But this is not always very pleasant, and sometimes it is even dangerous if the liquid is of a poisonous nature. The accompanying engraving illustrates a method by which the siphon may be started by compression instead of suction. The idea is so old that probably it is new to many. The device consists of a

large test tube, in the open end of which a cork is fitted, while in the opposite end a small hole is cut by means of a file. A glass marble is placed in the tube, and serves as a valve to close the opening. Through the cork the shorter leg of the siphon is run, and also a small bent tube. The outer end of the latter tube is placed in the mouth, and on blowing into the test tube the compression serves to close the valve and at the same time force the liquid through the siphon. As soon as the pressure is relieved, the liquid in the vessel will flow up through the opening in the test tube, and continue running off through the siphon. The shorter leg of the siphon extends to within a short distance of the ball valve, so as to limit the motion of the latter, and prevent it from striking the glass with a blow sufficiently hard to break it.

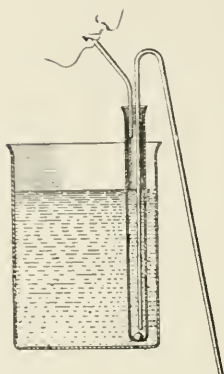

Fig. 161—Starting device for siphons

HOW TO OBTAIN FRESH WATER FROM SEA WATER

A common method of getting salt from sea water is to place the liquid in shallow vats, and expose it to the sun until the water is evaporated. Someone has suggested that the same pro-

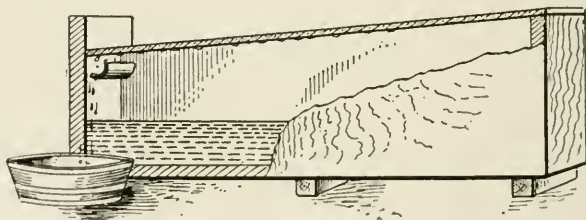

Fig. 162—A simple apparatus for distilling fresh water from sea water

cess of separation be used to get fresh water out of the sea water. Cover the vat with a pane of glass which is tilted slightly. The

radiant heat of the sun passing through the glass will evaporate the water, and the vapor condensing on the under side of the glass will run down the inclined surface and drip into a trough. A receptacle at one side will catch the fresh water that flows from the trough. The condensation may be expedited by pouring water over the glass. The glass will thus be chilled without interfering with the passage of the sun's rays into the vat.

AN ELECTRICALLY CONTROLLED GAS REGULATOR

In some work which is being carried on at various fixed temperatures, accurate and reliable gas regulation is required. The following regulator has proved entirely satisfactory:

In Fig. 163 *A* is a U-tube of glass, of about 8 millimeters internal diameter. This is provided with a side tube *B*, and is enlarged at the top for the reception of a small rubber stopper *C*. Through this stopper passes a tube *D*, the external diameter of which is 1 millimeter less than the internal diameter of the U-tube. The U-tube is filled with mercury to the level *E* a millimeter or so below the end of the tube *D*. The weight *F* is a piece of iron about 7 millimeters in diameter and 15 to 20 millimeters long. This is suspended freely from a hook, *G*, on the armature of an electro-magnet, *H*. The armature is held up by a spring which is fastened rigidly to a support. The spring is adjusted to support the weight but to yield quickly to the magnet. The length of the hook *G* must be such that its end will have a

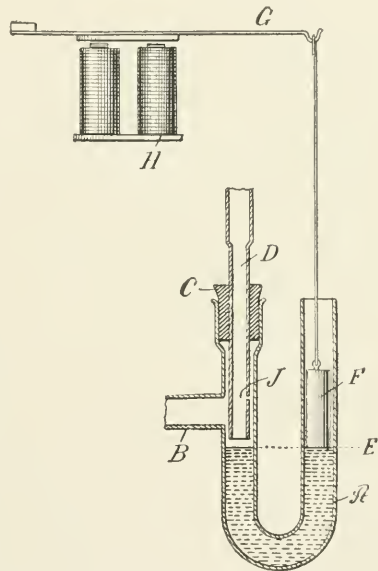

Fig. 163—Electrically-controlled gas regulator

vertical motion of 1 or 2 millimeters. More motion than this is not required, but will do no harm. The suspension of the weight must be flexible and free rather than rigid, so that the weight acts simply by its own weight on the mercury. If the sudden motion of the armature be rigidly and suddenly transmitted to the mercury, the mercury may be caused to splash into the side tube *V*.

The gas enters through tube *D* and, normally, flows under the lower end of this tube up through the annular space about it and out to the burner through the side tube *B*. When the electro-magnet is actuated the lowering of the weight *F* causes a corresponding elevation of the mercury in the other leg of the tube, which cuts off the gas. A pinhole at *J* keeps the burner lit. In constructing the apparatus, two or three very small pinholes may be made and closed with paraffin. One or more of these may be opened with a hot needle as the size of the burner or stove may require for a pilot flame, or the burner may be supplied with an independent supply of gas to keep it lit. The surface tension of mercury is so great that though the weight *F* fits only loosely in the tube, the mercury will not enter the annular space around it. Thus the weight acts as well as an airtight piston. On the other side the pressure of the gas is not sufficient to drive the mercury into the annular space there. To take full advantage of this, the gas should enter through the central tube *D* and go out at *B*, and not the reverse. A motion of only about 1 millimeter is required for the weight *F*, and as this weighs only about 7 grammes, the work required of the electro-magnet is very slight.

For the electro-magnet an ordinary electric bell of the cheapest form may be used, the vibratory make-and-break being short-circuited and the bell removed. The weight may then be hung on the end of the clapper. The magnet should be wound up to 20 ohms to economize current.

The apparatus may be controlled by any of the forms of electrical regulators on the market, in which a contact is made when a certain temperature is exceeded and broken when the temperature goes down. As these regulators may be made of extreme

sensitiveness, the regulation of temperature to any required accuracy may be accomplished.

The advantage of this form of regulator is that it can be made quickly and easily out of materials at hand in the chemical laboratory. It may be readily cleaned. The large gas opening permits of much fouling of the mercury before cleaning is required.

In Fig. 164 is shown another way of using the same principle. In this a block of cast iron, about $2 \times 2 \times \frac{3}{4}$ inches or $60 \times 60 \times 18$ millimeters, is taken and the tubes made by drilling holes in it. As the most of these correspond to the tubes in the other figure and are lettered the same way, they will not be redescribed. The main holes may be the same size as the tubes in the other figure, or may be of any size suitable for the supply of gas required. A plug, *K*, may be used to regulate the height of the mercury in the U-tube. Should the mercury become foul, it may be removed by taking out this plug, cleaned, and replaced. The inlet tube is made in the shape shown, its lower part being turned down, so as to leave the proper space for the gas. Its upper portion is threaded with a straight thread, so as to screw into the block. When it is put in place, the lock nut *L* is screwed on firmly over the lead washer *M*. Then the hole *N* is drilled through the block and into the tube *D*. The outer end of this hole is closed by a screw plug provided with a lead washer. A hole is drilled so as to intersect the hole *N*. This is continued by the small hole *O*, which opens into the outlet *B*. A pointed screw *P* serves as a needle valve to regulate the by-pass and supply any amount of gas desired to keep the burner or stove lit.

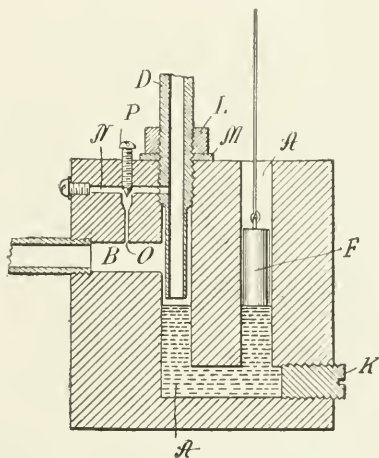

Fig. 164—Another form of gas regulator

A gas-pipe thread may be cut on the extreme upper end of *D*, and the supply pipe screwed on directly. The hole *B* is tapped to receive the iron gas pipe for the burner. The advantage of this form over the other is that being entirely of metal it is unbreakable and compact and eliminates any fear of fire. The operation is the same as that of the other form.—77

A HOME-MADE BAROMETER

As is well known, a barometer is nothing more than a con-



Fig. 165—Filling the mercury tube

trivance for measuring the weight of the air. A glass tube closed at one end and filled with mercury, then immersed in a bath of the mineral without the admission of air, is an elementary form

of the instrument. When the tube is upright, the column of quicksilver is seen to fall four or five inches, leaving a vacuum at the top. It will be evident that the height of the mercury in the tube responds to the variations in the weight of the atmosphere pressing on the bath of mercury. The relations of the movements of the "glass" to the weather are of course simple enough. When the atmosphere is heavy it causes the mercury column to rise, indicating fair weather; and conversely when the atmosphere is under low pressure the mercury column subsides, indicating the approach of a storm.

For the construction of a home-made barometer, purchase about three-quarters of a pound of mercury, a glass tube three feet in length and closed at one end, and a small glass receptacle four or



Fig. 166—Inserting the tube in the mercury receptacle

five inches long. This should be large enough to take the end of the long glass tube, allowing a quarter of an inch or so all around. The wood necessary for the construction of the frame is likely to be found in almost any house. It is desirable that this work should be taken in hand in the first place. To make the frame take a board about three feet three inches long and four

inches wide: make the whole nice and smooth. Now cut two strips of wood, say thirty inches long and one and a quarter inches in width. Screw these to the board far enough apart to allow the glass tube to be dropped in between them, at the same time taking care to place them four inches from the bottom of the



Fig. 167—The tube immersed in the mercury receptacle

board. Along the bottom of the board fasten a strip of wood sufficiently wide to support the glass receptacle. Add two pieces of wood to either side of the board, these to run up to where the two long strips terminate. In this way will be formed the three sides of a little box. A piece for the top of the box must have an archway scooped out in the center to allow for the passage of the tube. A square piece of thin wood may be cut to form the lid of the box. After applying some stain to give the wood a finish the frame is complete.

The next matter for consideration is the filling of the small glass receptacle and the tube with mercury. In filling the tube a funnel formed out of a sheet of paper will be found useful. When the tube is full, place the finger over the orifice. Then invert the tube, and without admitting any air immerse the end in the mercury contained in the receptacle. This is likely to be rather a difficult undertaking, and perhaps the best way of all to accomplish it is to tie a piece of skin or leather very tightly over the

upper end of the tube after it is full; then immerse, and finally cut away with a penknife the twine which binds the skin. If this has been accomplished without letting in any air, the column of mercury will be observed to fall several inches. If atmospheric bubbles are to be seen working their way upward, the tube must be refilled.



Fig. 168—Fastening the tube to the frame

The tube and receptacle must now be carefully removed to the case. The contrivance is best fixed into its position by looping wire round the tube in about four places, and twisting these tightly at the back. The scale is easily prepared. Consult a reliable barometer in quiet weather, and when this stands at 30.00, make a slight mark in the woodwork opposite the level of the

mercury in the home-made article. On a piece of paper rule out



Fig. 169—The scale in place

your scale for the two sides of the glass to the extent of about four inches; dividing each into tenths. Put the central inch at 30.00, and number the inches up and down accordingly. Paste the slips of paper on either side of the tube, and cover the receptacle with the lid which has already been prepared, and the instrument is complete. The barometer should be kept in an upright position, and must never be hung where the sun will fall on it. It is not claimed that this contrivance will work with extraordinary accuracy, but if reasonable precautions are taken in its construction, the instrument should record the variations in pressure with fair reliability.—88

SCALE FOR BAROMETERS

The indications of a barometer being dependent on the relative movements of the mercurial column, the scales here described are intended to afford a simple means for the necessary comparative observations.

Referring to the diagram, it will be seen there are the usual scales on both sides of the tube divided into inches and tenths; outside these are movable pieces—indices—arranged to be moved up or down, and be held where placed by a flat spring behind each. Across the center of the indices is a line lettered "Settled," and other lettering is as shown, which is, however, entirely arbi-

trary. One of these indices is labeled "For To-day," and the other "For To-night."

In use the day index is set with the "settled" line even with the top of the mercurial column at 9 o'clock in the evening; the night index being set in the same way at 9 o'clock in the morning each day. The reading of either index holds good until the time arrives for setting the other index, and then remains an indication of the general barometric tendency for the preceding twelve hours.

These indices, used as described, take the barometer somewhat out of the scientific class, and place it on a plane where it may become of everyday popular interest and utility.

It is known that rising barometer generally means improved weather conditions, while falling barometer indicates the opposite; but the direction of the wind should be considered in connection with the barometric indications; as changing barometer with a given wind may indicate simply an approaching change of temperature, while with a different wind the change would be of a general character. The changes which follow a rapid rise or fall of volume, though likely to be very marked, are not usually very lasting.

Daily observations of a barometer and the general weather conditions will be found most interesting and instructive when assisted by these handy "indices."—23

A HOME-MADE AIR THERMOMETER

Among the various instruments which have been devised for the measurement of temperature, the air thermometer has the distinction of being the first form of any value. It was invented

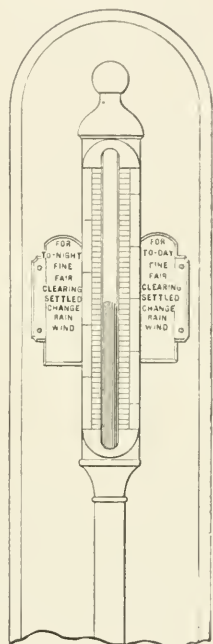

Fig. 170—A convenient scale for barometers

probably by Galileo about the year 1593, and was used to a considerable extent by physicians; but its readings were deceptive, for at that time the influence of atmospheric pressure was unknown. Galileo invented the alcohol thermometer eighteen years later, and this more accurate and at the same time more simple instrument almost entirely superseded the older form.

In some ways however the air thermometer is more efficient than either the mercury or alcohol thermometer. Since it is based on the principle of expansion of a gas, the air thermometer is very sensitive, and offers a large register for a small change in temperature. The reason for this greater susceptibility to heat is evident from the following data. The coefficient of expansion of air is 0.003665, or approximately 1-273 of the volume; the coefficient of mercury is 0.0001815, or 1-5510. Thus, a cubic centimeter of air, upon the application of one degree Centigrade of heat, will expand about twenty times as much as an equal volume of mercury. Besides this, a greater quantity of air than mercury can be conveniently utilized for expanding.

A simple air thermometer can easily be made. The materials needed are: A thin, hollow sphere or bulb of glass, about two inches in diameter, having as an outlet a glass stem from eight to twelve inches long, of about one-eighth inch inside diameter. A bottle of considerable weight, about three inches in diameter and from three to five inches high, is necessary. (Any ordinary rather small bottle will do.) This should be half filled with eosin solution or otherwise colored water. A cork stopper for the bottle, having a hole through it large enough to admit the glass stem. The stem must now be partially filled with the eosin solution. This can be done by warming the sphere with the hand, and holding the end of the stem under the surface of the liquid. Some of the expanded air is expelled, and when the hand is removed from the bulb, the eosin solution rises gradually in the tube to fill the sphere made vacant by the contraction of the cooling air. If temperature changes not far from the normal are to be registered, the eosin should stand finally at somewhat over half way up the tube. It is rather difficult to reach a satis-

factory result sometimes, and several trials may be necessary. They are easily repeated, of course, for the liquid already in the tube can be driven out by warming the bulb again.

Two grooves, running lengthwise, should be cut into the sides of the stopper to provide for free communication between the air in the bottle and the outside atmosphere. It is essential that the bottle should not be corked airtight, since this condition would cause a counter pressure of the air in the bottle whenever the air in the bulb is expanded. When the cork stopper has been put in, and the stem of the glass sphere inserted so that the end of the tube is under the surface of the liquid, the air thermometer is complete. A scale of degrees marked on cardboard may be put back of the tube, or the gradations may be scratched on the glass itself, but the readings will be inaccurate, for they will vary with every barometric variation, since the air pressure on the liquid in the bottle fluctuates. In only a modified and rather complex form can the air thermometer be relied upon for exact measurement.

The delicacy in action of the air thermometer makes it very useful in detecting sudden local changes in temperature. Interesting experiments can be performed with it; for instance, if a piece of filter paper saturated with ether is placed on the bulb, the eosin quickly rises because of the heat absorbed in evaporation. Because of its inconsistencies in readings, however, it is wrongly named as a definite measurer of temperature, for it is really only a thermoscope.—15

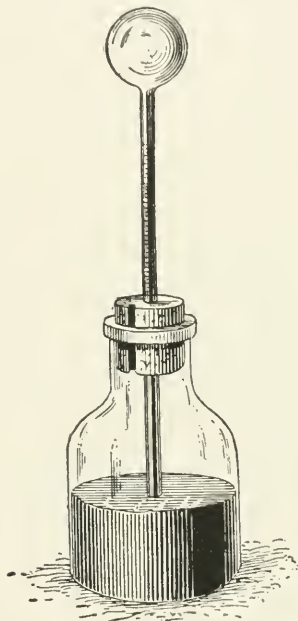

Fig. 171—A home-made air thermometer

HOW TO MAKE AN ELECTRICAL ANEMOMETER

The velocity of the wind is usually measured by noting the rate of rotation of a small wheel driven by the wind. In the instrument described below, the pressure of the wind is used as

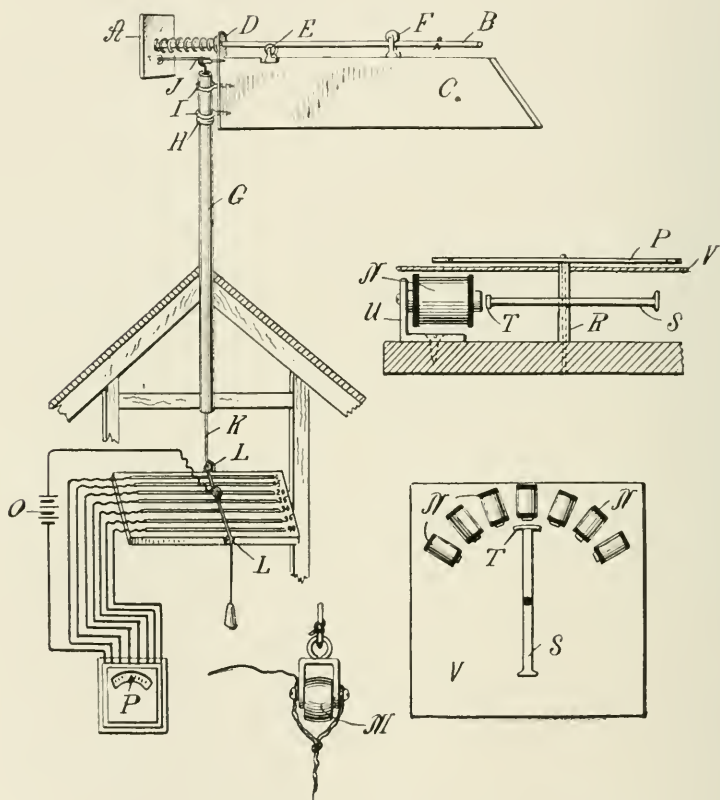

Fig 172—Details of the electrical anemometer

a measure of its velocity. A thin board is backed by a spring, which is held into the wind by a vane. The compression of the spring is determined by means of a weighted cord attached to

the board and which passes through a tube to a convenient location within the building. In Fig. 172 the board against which the wind presses is indicated at *A*. It must be 1 foot square, and is preferably made of $\frac{1}{4}$ -inch stuff and secured to a brass tube *B* 30 inches long by means of two nuts, one at each side of the board. The vane *C* is cut from a board 30 inches long by 6 inches wide and $\frac{3}{4}$ of an inch thick. A piece of strap iron, *D*, is fastened to one end of the board, and projects above it. A hole is drilled through the strap iron to receive the tube *B*, which rides over a roller, *E*, and under a second roller, *F*, fastened on the upper edge of the vane. Between the board *A* and the strap iron is a brass spring of No. 15 wire about 16 inches long, which loosely fits over the tube *B*. The vane is mounted on a pipe *G*, which passes up through the roof of the building. Three screw-eyes are secured. The shank of one is chipped off, leaving a ring which is soldered fast to the pipe at *H*, forming a collar thereon to prevent the vane *C* from sliding down the pipe. The other two screw-eyes, *I*, are fitted over the pipe *G* after being screwed into the board *C* through holes in strap iron *D*. A small pulley, *J*, is secured to the board *C* directly over the pipe *G*, and a cord, *K*, of suitable length attached to the board *A* passes over this pulley and through the pipe to the indicating mechanism within the building.

According to statistics recently published, the wind pressure to the square foot at different velocities is as follows:

10 miles per hour.....	0.37 pounds
15 miles per hour.....	0.76 pounds
20 miles per hour.....	1.27 pounds
25 miles per hour.....	1.90 pounds
30 miles per hour.....	2.64 pounds
35 miles per hour.....	3.50 pounds
40 miles per hour.....	4.44 pounds
45 miles per hour.....	5.50 pounds
50 miles per hour.....	6.66 pounds
55 miles per hour.....	7.80 pounds
60 miles per hour.....	9.22 pounds

By attaching a weight to the cord K of say 1.90 pounds, we will be able to determine how much the board A will be pressed back out of its normal position by a wind of 25 miles per hour. A board should be placed at a suitable position in the building, with a pulley, L , at each end to guide the cord across it. A small brass roller, M , should be introduced into the cord between the pulleys L . The method of attaching the roller is indicated in the enlarged detail view. On the board over which the roller is adapted to pass are a number of brass bars, each electrically connected to a separate magnet N , while the other terminal of each magnet is connected to the battery O , and the circuit is thence continued by a wire running to the roller M . In this way, as the plate A is forced back, the roller M travels across the brass bars and successively energizes the magnets N . These magnets are placed under a dial face, and an armature is pivoted before them in such a way as to be attracted by the energized magnet, causing a needle P to move over the dial face and indicate thereon the velocity of the wind, as shown by its pressure against the plate A .

The weights, which must be fastened to the cord in order to show the location of the brass contact bars, may be made as follows: Procure a piece of thick cardboard, and trim it until it weighs exactly a quarter of a pound. Then divide the cardboard into 25 equal parts, and each part when it is cut out will weigh approximately $1/100$ of a pound. With these small weights it will be an easy matter to make up the weights called for in the table above to represent the pressures at the various wind velocities. A small sinker should be tied to the end of the string, to keep it taut. A $1/4$ -pound weight and twelve of the $1/100$ -pound weights, making $37/100$ in all, are now tied to the end of the string, and a pencil mark is made on the board where the roller touches it. This shows where the first contact bar should be placed, representing a wind velocity of 10 miles per hour. In the same way the positions of the other bars are found. To eliminate errors due to stretching of the cord K as the heavier weights are attached to it, a second cord may be used to carry

the weights by which the board *A* is drawn back while the positions of the contact bars are being determined.

To make the indicating instrument, procure a piece of jeweler's tubing with an outside diameter of not over $\frac{3}{32}$ of an inch and an inside diameter as large as an ordinary hatpin. The tubing *R* is fitted into a hole in the center of an ordinary nail, *S*, and the pointed end of a hatpin is driven into the baseboard of the instrument through the tubing to form a center for the armature *S* to revolve upon. A short piece of soft iron is soldered to the end of the nail at right angles as shown at *T*. The magnets *N* are mounted on small brackets *U*, with their poles facing the center of the armature and in close proximity to the path of the piece *T* as it is swung about. The needle *P*, which is soldered to the upper end of the tubing *R*, will travel with the armature over the dial face *V*, which is graduated to show the various wind velocities.—73

GYROSCOPE MADE FROM A BICYCLE

The accompanying illustration, Fig. 173, shows how a good-sized gyroscope can be made out of an old bicycle. The turn-

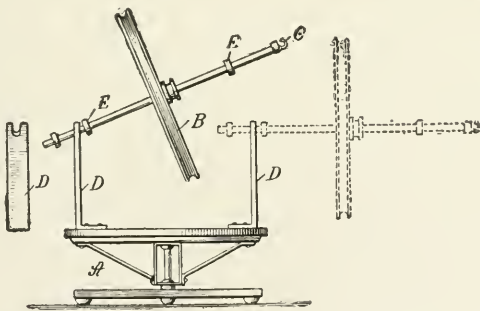

Fig. 173—Bicycle wheel gyroscope

table *A* is furnished with a ball-bearing mounting by attaching it to bicycle pedal. The pedal is secured on a stand, to which the pedal spindle is bolted. An ordinary bicycle wheel is indi-

cated at *B* with its axis extended, by screwing on a pipe in place of the ordinary nuts. At one end of the axis is a hook, *C*, by which the wheel may be hung and be swung as a pendulum to show the curious path taken when the wheel is spinning horizontally, and also how it resists any change to its plane of rotation. *DD* are supports with grooves in which the extended axis can rest. Stops *EEE* are to prevent the wheel from sliding down the groove when its axis is raised toward the vertical. The apparatus is worked as follows:

First. Placing the wheel *B* in between the supports *DD*, the turntable can be spun round, to show that the wheel remains inert when not spinning; spin the wheel (which can be done by the hand quite fast enough), and on revolving the turntable the wheel rises toward the vertical, as shown in sketch, supporting itself. Reverse the direction of the turntable, and the opposite end rises with similar results.

Second. Remove the wheel from the turntable, and place the axis on one of the supports *DD*, so that it comes between the stops *EE*. The other end is held in the hand until the wheel is spun, when it will revolve in the usual manner of gyroscopes, carrying the turntable with it.—25

THE ELASTIC PENDULUM

By elastic pendulum is here meant a weight so suspended that more or less of the suspension is in the form of a spiral spring, so that the weight is capable of two movements in one plane—the usual pendulum vibration, and a vibration along the suspension. A very simple apparatus for readily and accurately finding centrifugal force may be constructed as shown in Fig. 174. As this is an experiment often given in laboratory courses, it is believed that a really accurate method will be welcomed. A small brass rod or tube about 125 centimeters long carries at the top a hollow adjustable weight, *A*. Below this a cylinder, *B*, of hard rubber, having two knife edges, *C*, and a yoke from which depend two spiral springs. Springs from cast-away shade rollers are excellent for this purpose. The springs support a weight, *H*,

of about 700 grammes. As shown in the figure, the rod runs through the weight upon four grooved rollers *E*, mounted upon conical bearings. Above the weight is an adjustable collar, *F*. For convenience the vertical distance, *C—G*, is made 100 centimeters.

In use the apparatus is suspended from its knife edges, the spring is stretched by a weight of about 200 grammes and the collar *F* is set to hold the weight in the stretched position of the spring. Now take the vertical distance between the knife edges and the middle of the weight, and calculate the time of vibration of a simple pendulum whose length is this distance. Vibrate the apparatus through a small arc, and adjust the weight *A* until the time of vibration is that above calculated. No great care is demanded in this adjustment. A circular arc of one meter radius, divided to thirds of a degree, is placed under the pendulum, so that *G* is at its zero point. Such an arc can be very quickly made upon wood or cardboard with a rule, a pair of dividers, and a table of chords. Put a loop of thread around the weight *H*, and pull it up the arc. It will be readily seen that upon releasing the weight at some particular point of the arc, the central acceleration at its fall will exactly balance the tension of the spring. This point can be found to a fraction of a degree after a few trials, and is indicated by a slight tick caused by the weight leaving the collar and returning against it. Call the angle so found θ , the distance through which the weight falls vertically *S*, and *V* its acquired velocity, we now have:

$$S = r \text{ versin } \theta \text{ and}$$

$$V^2 = 2 g r \text{ versin } \theta$$

$$W V^2$$

But the centrifugal force $F = \frac{W V^2}{g r}$ and therefore:

$$F = 2 W \text{ versin } \theta$$

The result is readily verified by adding weights to *H* until it just leaves the collar. Several trials have shown an agreement well within one per cent.

A weight swinging from the end of a spiral spring traces an

interesting variety of curves, according to the ratio of the pendulum and vertical periods. The ratio may be varied by making more or less of the suspension of inelastic string, and varying the suspended weight. A ring is screwed into the ceiling of a high room, and through this ring a string is passed and to the hanging end of the string is attached the spring and weight. The weight is a brass tube about 10 centimeters long, having a bail

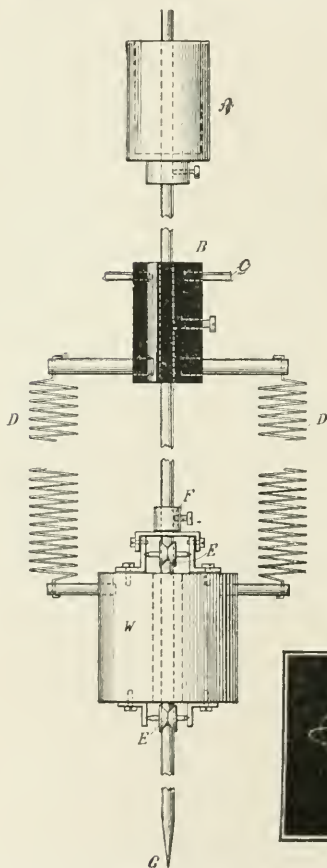

Fig. 174—Details of the elastic pendulum

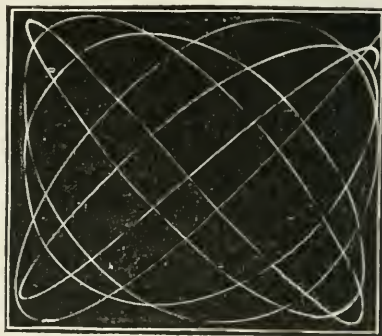

Fig. 175—Curve obtained when weight is drawn aside and lifted—ratio $1/1$

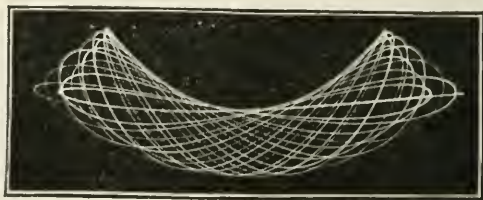

Fig. 176—When weight is deflected and raised—ratio $1/2$

at the top and a plug of lead at the bottom. The weight may be added to by putting shot in the tube. A record of the curve traced by the moving weight is obtained by attaching a "pea" lamp to the lower end of the weight; supplying this with current from two very light wires coming in from one side, and photographing this light by a camera placed vertical to the plane in which the pendulum swings. A lamp may be selected giving

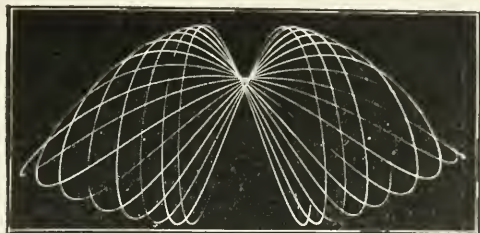

Fig. 177—When deflected and depressed—ratio $\frac{1}{2}$

practically a point source, and the small wires do not sensibly affect the motion of the pendulum.

First case: When the ratio is $1/1$. It was not found possible to exactly produce this ratio with springs of brass or steel; the vertical vibration being too fast when the whole suspension was spring. The best that could be done was a ratio of about 87 to 100, which is, however, near enough to enable us to see what the curve would be, were the exact ratio 1 to 1 obtainable.



Fig. 178—A limiting condition—ratio $\frac{1}{2}$

Fig. 175 shows the curve obtained when the weight is drawn aside, raised, and released. It is readily seen that the cycle would be complete after three revolutions to the right and three to the left, were the ratio exactly 1 to 1. When the weight is drawn aside and pulled down, exactly the same curve is described. There is, however, a limiting condition when the weight is just sufficiently lowered that the upward acceleration of the spring balances the downward acceleration of gravity. We then get the

curious case of a freely-moving pendulum whose bob describes a straight line.

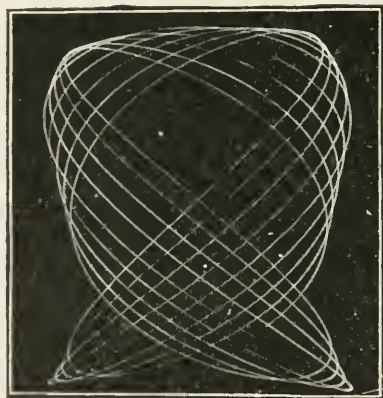

Fig. 179—Curve made with a ratio of $\frac{2}{3}$

Second case: Ratio $1/2$. Fig. 176 shows the curve obtained when the weight is deflected and raised; Fig. 177 when deflected and depressed. In Fig. 177 the cycle is incomplete. The horizontal component of motion dies out rapidly, and before the reverse half of the cycle is reached the pendulum has lost its directive force. In Fig.

176 it will be noticed that the contraction of the successive loops is due to falling off in amplitude of the pendulum.

Case two also presents a limiting condition shown in Fig. 178. Here the path is a parabola, and it is interesting to note that the upper loops of Fig. 177 are tangent to this parabola, when applied to it, and that it coincides with the median line of Fig. 176.

When the ratios are made less simple, the curves become more complicated. Fig. 179 corresponds to a ratio of $2/3$.

No attempt is here made to treat the matter analytically. These cases do, however, present new and interesting matter to the mathematician, should the present state of analysis be found

equal to the problem. In general, we may remark that the shapes of the individual loops of the various curves are those of the corresponding aliquot ratios in simple harmonic motion, but the point of departure moves ahead with each successive loop.—32

CUTTING WOOD WITH PAPER

A tallow candle bullet can be fired through a board. A straw driven by a cyclone will penetrate a tree. A stream of water, under high pressure, will tear the skin off a man's hand. A copper disk rotating slowly can be cut by a steel cutting tool; but if rotated at high speed it will turn about and cut the tool. These facts suggested the following experiment on the cutting ability of paper. Everyone knows that the hand can be badly cut with paper; but the experiment was undertaken to discover whether hard substances, such as wood, could be cut with paper.

A page of the *SCIENTIFIC AMERICAN* was trimmed to the form



Fig. 180—Cutting a pencil with a disk of Bristol board

of a disk, 10 or 11 inches in diameter, and a wooden spool was glued to the paper at its center. An electric fan was dismantled of its fan and guard and the spool was bored out to fit snugly on the armature shaft. A wood screw with its point blunted was threaded through the spool and against the shaft to fix the disk securely thereon. Then the current was turned on and a pencil



Fig. 181—The Scientific American as a cutting tool

was held lightly against the edge of the spinning paper. Although the paper bit into the wood the centrifugal force was not sufficient to hold the paper rigid, and instead of making a clean cut it scratched the wood as if by a file. The fan was making about 2,000 revolutions per minute, but the speed should have been doubled for so thin a paper. Better results were obtained by pasting the paper on a disk of cardboard of smaller diameter, so that the edge of the paper projected half an inch over the peri-

phery of the cardboard. With this a clean cut was made into the wood of the pencil.

But the best cutter was made out of a sheet of three-ply Bristol board, the kind on which drawings for the Patent Office are commonly prepared. With this stiff paper the pencil was cut into very quickly, and the cut was exceedingly fine and clean. When the lead of the pencil was reached, the progress of the cutter was much slower because the graphite acted as a lubricant. Neither the paper nor the Bristol board showed any material wear with use. Fig. 181 shows the Bristol-board cutter making a cut, while in the foreground is a pencil which has been cut in two by the paper.

CHEMICAL PUZZLES

The following experiment is easily performed even by those who have had little or no previous chemical training. It gives an idea of the infinite diversity of chemical and physical changes which one and the same reagent may induce in other substances.

Fourteen glasses, arranged in seven pairs, are brought before the spectators, who are requested to examine them and their contents. The experimenter then pours one and the same liquid into the fourteen glasses. The following contradictory results become at once apparent:

Substance contained in glass *A* becomes so hot that the glass cannot be kept in the hand. Substance contained in glass *A'* becomes so cold that frost promptly collects outside of the glass.

Liquid contained in glass *B* was blue; it becomes colorless. Liquid contained in glass *B'* was colorless; it becomes blue.

Glass *C* contained a clear liquid which becomes muddy. Glass *C'* contained a muddy liquid which becomes clear.

If a lighted match be introduced into glass *D*, several inches above the liquid, noisy flames are seen to spring in every direction. If the same experiment is made in the same manner with glass *D'*, the match is quietly but immediately extinguished. Liquid in glass *E* had a burning, suffocating smell; it becomes odorless. Liquid in glass *E'* was odorless; it acquires such an

offensive smell that it becomes necessary to carry it outside.

Liquid in glass *F* was red; it becomes blue. Liquid in glass *F'* was blue; it becomes red.

Glass *G* contained a solid substance which becomes liquid. Glass *G'* contained a clear liquid which becomes instantaneously solid.

Every transformation is the result of the action of common hydrochloric acid over some chemical. Here are the nature and



Fig. 182—A chemical puzzle

proportions of these; capacity of glasses being supposed to be about one pint.

Glass *A* contains 50 grammes of sodium hydrate dissolved in 100 cubic centimeters of water. This solution fills about one-half of the glass. During the experiment the other half must be entirely filled with hydrochloric acid. This should be poured slowly while the liquid is agitated with a glass or wooden stick. The last additions of acid cause the liquid to boil. The glass will then be found to contain common table salt mixed with an excess

either of acid or of sodium hydrate. Glass *A'* is filled with sodium sulphate in small crystals, such as is sold by pharmacists to be taken internally. Enough hydrochloric acid must be poured to cover the salt. Temperature goes at once much below 32 deg. F. The cold becomes still more intense if the mixture be agitated.

Three-quarters of glass *B* are filled with water; then one decigramme of copper sulphate is dissolved in it. Ammonia is added in small portions until an intense blue color appears. The addition of hydrochloric acid will cause it to vanish. A solution of two centigrammes of potassium ferricyanide in 100 cubic centimeters of water is made in glass *B'* and, in this, another solution of $\frac{1}{3}$ centigrammes of ferrous sulphate in 100 cubic centimeters of water is poured. A little ammonia is then added until the beautiful blue color vanishes. Hydrochloric acid will cause it to reappear instantaneously.

Glass *C* contains the ordinary solution of lead acetate sold by druggists for local or external application. Hydrochloric acid forms in it a dense precipitate of lead chloride. Three-quarters of glass *C'* are filled with water to which about a quarter of a teaspoonful of slaked lime, free from coarse particles, is added. Calcium chloride, resulting from the action of hydrochloric acid on lime, is exceedingly soluble in water.

A few pieces of zinc are deposited in glass *D*. Bubbles of hydrogen will be set noisily on fire when a match is introduced into the glass. The experiment is free from danger so long as no attempt is made to close the glass. One-third of glass *D'* is filled with wood ashes with enough water to make a thin paste. Carbon dioxide is the gas which promptly extinguishes the match.

A hundred cubic centimeters of water, fifty cubic centimeters of ammonia, and enough litmus solution to give the liquid a bluish tint are poured into glass *E*. During the experiment, hydrochloric acid is added, little by little, until the bluish color suddenly becomes reddish. The odor will then be found to have vanished. One-third of glass *E'* is filled with water, and 8 grammes of powdered iron sulphide are thrown into it. Hydrochloric acid

will generate hydrogen sulphide in the glass. This gas is the active agent found in some mineral waters, to which it gives a characteristic smell of putrefied eggs. It is poisonous, but the amount evolved during the experiment is small, and the smell is so strong that it makes the air apparently irrespirable long before there is any danger. It should not, however, be smelled directly over the glass, nor should the glass remain in the room longer than is necessary to detect the odor.

Glass *F* contains the same liquid as used in glass *B*, with the addition of one centigramme of aniline red scarlet. Glass *F'* contains the ordinary solution of blue litmus.

Calcined magnesia is the solid substance which fills about one-third of glass *G*, and the ordinary syrupy soluble glass or sodium silicate solution sold by druggists is the liquid substance which will become instantaneously solid, in glass *G'*, if mixed with about one-third its volume of hydrochloric acid.—58

SOME EXPERIMENTS WITH CARBON DISULPHIDE

Carbon disulphide vapor is nearly twice as heavy as carbon dioxide gas. Some experiments, still more curious than those which are usually made to manifest the density of carbon dioxide, can be performed with carbon disulphide.

To obtain carbon disulphide vapor there is no need of heating the liquid. It boils at 117 deg. F., but emits a considerable amount of vapor at temperatures far lower than 117 deg. To ascertain this fact, place in a dish a handful of cotton. Pour some carbon disulphide over it, and with bellows blow steadily over the whole. After a minute or two it will be found that the carbon disulphide has gone, and that a thick external layer of snow has taken its place. Condensation and congelation of atmospheric humidity were the result of the quick vaporization of the liquid.

The following experiment made with carbon disulphide always succeeds, although the writer has tried in vain to perform it with carbon dioxide. It offers no difficulty whatever, even when the thermometer stands as low as 66 deg. F., and it can probably

be made at a lower temperature, although it is of course better to select a summer day, or, in winter, a heated room. Take a long and narrow strip of stiff paper. Fold it longitudinally so as to form a V-shaped trough. Support the trough on an incline, with the upper end resting on a book and the lower end in the mouth of an empty glass. In the bottom of a second glass press some cotton, and over this pour some disulphide. Have a third empty glass at hand. Everything is now ready for the experiment.

Go through the motions of pouring into the third glass the carbon disulphide contained in glass number two. Capillarity will keep the liquid in the cotton, and nothing will seem to flow



Fig. 183--Making frost with carbon disulphide

out. Now take glass number three, which apparently contains nothing; handle it as if it contained something, and pour slowly its invisible contents into the upper part of the paper gutter. Nothing is seen to leave the glass nor to run along the gutter nor to fill glass number one at the lower end of the gutter, but throw an ignited match into the latter glass and a blue flame will fill it for one or two seconds.

A little apparatus, called the four liquids vial, is generally shown to students during a course in elementary physics. Mercury, a solution of potassium carbonate, alcohol, and petroleum are seen to superpose themselves in one vessel according to their relative densities, the surface of separation being in each case

horizontal. This is the way in which non-miscible liquids generally arrange themselves when thrown together in one vessel. Carbon disulphide permits of a somewhat different arrangement, which appears very odd because the conditions of its realization are so unusual. It happens that carbon disulphide and glycerin cannot be mixed, and have exactly the same density (1.26) up to the second decimal, the third decimal being variously influenced by the purity and temperature of both chemicals. If the

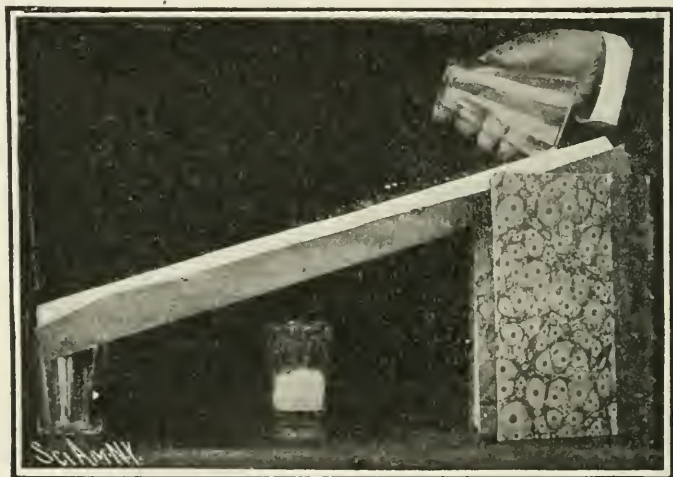

Fig. 184—Pouring invisible vapor of carbon disulphide down a trough and into a glass

two liquids be placed with some care side by side in one vessel, the adhesion of glycerin for glass will keep them in that queer position.

Take an ordinary glass, and divide its capacity into two halves by means of a roughly-cut pasteboard partition laid vertically in the glass. Pour at the same time glycerin on one side of the partition and carbon disulphide on the other. If, while so doing, you are careful not to allow too great a difference of level between both liquids, each will stay on its own side of the partition, even

though the latter may imperfectly fit the glass. Now raise the partition. The surface of separation of the two liquids sometimes remains perfectly vertical for several minutes. More frequently,

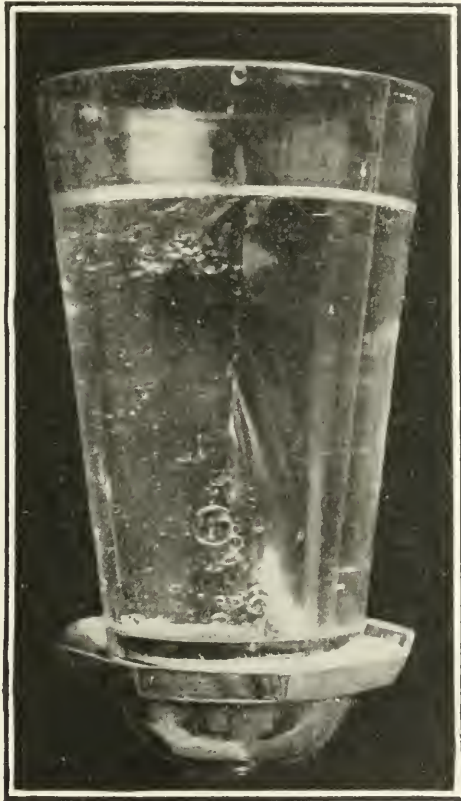

Fig. 185—Carbon disulphide and glycerin side by side

under the influence of the three factors which determine its shape, i. e., adhesion, cohesion, and a small difference in density, it bends itself and becomes more or less S shaped.

While handling carbon disulphide, one should always bear in

mind that *this liquid takes fire even more readily than gasoline, and that its vapor is poisonous.* The latter inconvenience is the lesser, because the nature and intensity of the smell of the commercial product are such as to cause one to step back when the vapor reaches the nostrils.—58

BLUE ROSES

The roses shown on the accompanying figure are white with a delicate and beautiful network of blue veins. Such roses can be



Fig. 186—The roses are covered with a network of blue veins

obtained in little more than one hour by placing the following solution, instead of water, in the vase in which the cut ends of the stalks are dipping:

Water.....	100 cubic centimeters.
Aniline methylene blue.....	2 grammes.
Potassium nitrate	2 grammes.

School boys know that white roses can be transformed into red flowers by allowing the cut end to remain some time in some kinds of red ink. The writer tried to obtain similar results with a number of aniline dyes and found that while some, like aniline red scarlet, for cotton, readily rise into the vessels of the stalk, others, like aniline methyl green, will not, under any circumstances reach the flowers. Some common salts were added to the dyes and one of them, potassium nitrate (saltpeter) was found to exert a powerful influence over the ascent of the dyes, which rise then rapidly and in considerable quantities. The experiment is curious and should be repeated while using the blue liquid; the end of a few stalks being placed in some of the solution to which no saltpeter is added. Aniline methylene blue is not one of the dyes which readily ascend in plants and it will be soon noticed that, while the flowers with the stalks dipping into the saltpeter and blue dye solution are covered with the blue network, nothing can yet be detected on those whose stalks are allowed to dip in the same liquid but without saltpeter.

Will some botanist suggest an explanation of this influence of saltpeter on the ascent of dyes in stalks and flowers?—58

HOME-MADE CHEMICAL PERFUME

Early in the nineteenth century, chemists generally thought it impossible to make organic compounds out of the elements found in them. Synthesis they believed to be practicable only in the case of minerals. Woehler, with his remarkable synthesis of urea, shook that belief at least as much as the Curies recently shook the common belief of chemists in the integrity of the atom. Other organic syntheses followed that of urea, and some of them, as that of the alizarin dye, were made in conditions so favorable that it became unprofitable to grow the plants from which the chemical had hitherto been extracted. Thousands of acres have thus been so far given back to the cultivation of food stuffs, and

one may confidently expect a time in which most, if not all, of our drugs, dyes, and even food will be made through synthesis. Agriculture then will be a thing of the past. Factories will make for us sugar, starch, fats, proteids, that is to say, bread, eggs, milk, fruits, besides some new foods which may prove as superior to the old ones as antipyrin and pyramidon have proved superior to the natural alkaloids formerly used in similar circumstances.

The most recent and greatest advance in the organic synthesis



Fig. 187—Apparatus for making synthetic lilac

of industrial products can be observed to-day probably in the perfume industry. The fragrance of heliotrope, hyacinth, pink, rose, violet, hawthorn, lilac, musk, wintergreen, vanilla, cinnamon, bitter almonds, and that of many fruits, are now produced with chemicals which frequently have but a repugnant smell or no smell at all. Most of these syntheses require complicated apparatus as well as considerable chemical skill, but in one case at least, that of terpinol, an essence now sold sometimes under the

name of lilac, sometimes under that of lily of the valley, the operations are simple enough, and the synthesis is but an enjoyable experiment easily performed at home or in the class room.

Besides the vessels found in every kitchen, the only needed apparatus are a round-bottom flask (capacity about one pint), a rubber stopper with one hole, and two glass tubes united together with a piece of rubber tubing. The preparation may be divided into two operations, i. e., the transformation of common oil of turpentine into terpin and the transformation of terpin into terpinol. The first operation requires much time and no care whatever. The second operation is made in less than a quarter of an hour.

One-half of a quart bottle is filled with oil of turpentine. Three-fourths of a pint of alcohol at about 80 per cent is mixed with it, and one-fourth of a pint of nitric acid is added to the mixture, which is left to itself for several days, until crystals are formed. These are collected, and dried with some blotting paper. They are pure terpin. To get the full amount formed in such circumstances, one should wait over three months; but, for experimental purposes, such a delay is, of course, unnecessary. Moreover, should the experimenter wish to prepare the perfume at once, he may get the ready-made terpin at the drug store, as it is prescribed by physicians for a kind of lung trouble.

To transform odorless terpin into fragrant terpinol, terpin must be heated with water containing a small amount of sulphuric acid. The round-bottom flask is half filled with water. Two or three large spoonfuls of terpin are thrown into it, and about as much sulphuric acid is slowly poured into the flask. There is no danger in pouring sulphuric acid into water, but water should never be poured into sulphuric acid, as the heat thus suddenly generated may cause some of the caustic liquid to be thrown out of the bottle.

An alcohol lamp is now lighted directly under the flask. If a gas stove be used, a piece of wire gauze should be interposed between flame and flask. As soon as the liquid in the flask begins to boil, the glass tube is plunged into the water in a tumbler.

There the steam and the terpinol carried along with it noisily condense. A delightful scent fills the room. To keep the tumbler cool, place it in a bowl of water. The operation is over when the liquid in the tumbler has become nearly hot in spite of the water in which the glass is immersed. A layer of liquid terpinol will then be found to float over the water. The fragrance, which is extremely strong while the essence is warm, becomes much more agreeable after it has cooled. Some odoriferous plants, such as marjoram, contain terpinol, in their leaves, but the extraction of the essence from such sources is always much more expensive than its synthesis with oil of turpentine.—58

ARTIFICIAL ZINCITE

Zincite for use in wireless "perrikon" detectors can be made artificially as follows:

Mix thoroughly 1 part of zinc sulphate with from $\frac{1}{2}$ to 1 part of either potassium or sodium sulphate (Glauber's salt). Place in a crucible (platinum preferred, but porcelain or iron will answer) and heat until fused to a thin liquid. Then bring up to, but not above, a bright red heat. Sulphur dioxide will be given off, and against the outside of the crucible will be formed an opaque crust, white, if the materials were pure and the operation carried out in a platinum crucible. Under the microscope this crust is shown to be composed of small crystals identical in form and composition with those of the natural zincite. Slow action is better than a rapid one, because the slower the action the larger the crystals. It is even possible to obtain crystals of perfect hexagonal shape measuring from 2 to 3 millimeters in diameter. This opaque crust is removed from the crucible in as large pieces as possible, and then set in fusible metal.

Another method is to fuse powdered zinc oxide in the electric arc. This gives a hard, white, amorphous, porcelain-like substance, which can be used for similar purposes.—11

AN INTERESTING EXPERIMENT AND ITS EXPLANATION

Ordinarily, the precipitate produced by mixing two chemicals in solution is formed more or less slowly. But in the following

experiment we have a case where two different speeds of reaction are shown. The first takes several seconds before it is complete, while the second is quicker than a flash. The experiment also shows just when that action takes place.

When iodine is added to a starch solution, or *vice versa*, the solution is colored blue. This is a well-known test for either free iodine or starch.

Prepare a solution, A, of starch in water, and add to it some sulphurous acid. Prepare a separate solution, B, of potassium iodate, and add to it a little sulphuric acid. These last two substances form potassium sulphate and iodic acid, in accordance with the following reaction:



The iodic acid is the only constituent which plays any part and need be considered in the experiment proper. Pour A + B together quickly into a glass vessel and watch it closely. In a few seconds the solution will change like a flash to a deep blue. The explanation and reactions are as follows:

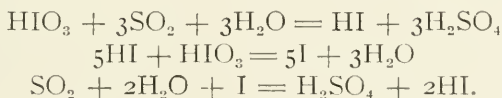

The iodic acid unites with the sulphurous acid to form hydriodic acid and sulphuric acid. The iodic acid then unites with some of the hydriodic acid and forms iodine. But the iodine does not get a chance for existence, because it is immediately taken up by some of the sulphurous acid and formed into iodic acid. This process keeps on as long as there is any sulphurous acid present, and the solution remains clear, for there is also no free iodine present. But just as soon as the last molecule of sulphurous acid disappears, the whole solution turns blue so quickly that one looks twice before believing. The blue color generally flashes in from 20 to 40 seconds, depending upon the concentration and strength of the solutions. With a little experimenting the solution may be made to change in a predetermined time. It is a good idea to use a small part of the solution, and time it before

mixing the remainder. Care should be taken not to use too much sulphurous acid.—59

NOVEL HEAT MOTOR

Owing to the fact that water in liquid form is nearly incompressible, it cannot be used to perform a cycle of operations such as take place in the steam engine. Theoretically, however, any substance having a temperature above its surroundings is capable of serving as a power generator. Disregarding the possibility of thermo-electric conversion of energy, useful mechanical work can be derived through the expansion of vapors of volatile substances.

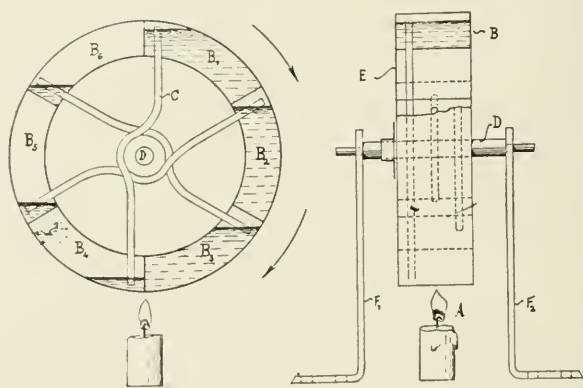

Fig. 188—A simple heat motor

Many liquids are known to pass into vapor under a feeble heat, such as, for instance, the sun's rays.

If other media than water are used as heat carriers, it becomes indispensable to recover the original liquid by means of condensation for economic reasons.

A simple apparatus, which can be made by the Handy Man, will demonstrate that a very small degree of heat is sufficient for performing light mechanical work.

A disk *E*, mounted on shaft *D*, serves as support for six compartments, B_1, B_2, \dots, B_6 , concentrically arranged about *D*. These

as well as the disk can be made of tin soldered together. Two opposite chambers, for instance, B_1 and B_4 , are connected by a small brass tube C , bent outward at the center to clear the shaft D and projecting through the chambers nearly to the outer cylindrical wall. Two uprights, F_1 and F_2 , support the wheel at a proper distance over a small flame A or over a basin filled with hot water. One of each pair of chambers is filled with ether or acetone, while the other contains only the vapor of the liquid in an expanded state, but no air at all. The liquid is introduced into the chambers through small holes, and after the air has been blown out (by heating this liquid to the boiling point) each hole is sealed with a drop of solder.

Evidently, when one chamber passes through the hot zone, the liquid vaporizes and passes through the tube to the opposite chamber where it condenses. Thus the center of gravity is constantly changed, causing the wheel to revolve.—36

AN ORNAMENTAL HEAT MOTOR

In the foregoing article the heat motor described is made of metal. This can be improved upon and made much more attractive by constructing the apparatus of glass. The entire operation is then visible, and if the source of heat be hidden, the result is very mystifying to the uninitiated. A set of glass balls are procured, each pair connected by a small glass tube as shown, and one of them filled with a volatile liquid, alcohol or ether, the air being exhausted before the bulb is closed.

A set of these bulbs, three or four, is arranged on a central support which revolves on pins. The support can be made as follows: Procure a cylindrical piece of wood, as shown at A , and drill holes at angles, dividing the circumference equally. Then with a fine saw cut through the center of these holes at right angles to the axis of the wood. This will provide a set of clamps, which will hold the rods connecting the bulbs in the position as shown on the assembled sketch. The bulbs are then balanced in their support and securely fastened, and the whole mounted on two vertical supports, which are in turn placed on top of a box.

This box is best made of tin or light sheet iron, and contains inside a deflector through the top of which some small holes are bored, to allow the heat from a small spirit lamp to strike the lowest bulb only. Air holes are provided at one side, on the bottom as shown.

The operation is as follows: When the heat strikes the lower bulb, the liquid evaporates quickly, forming sufficient pressure

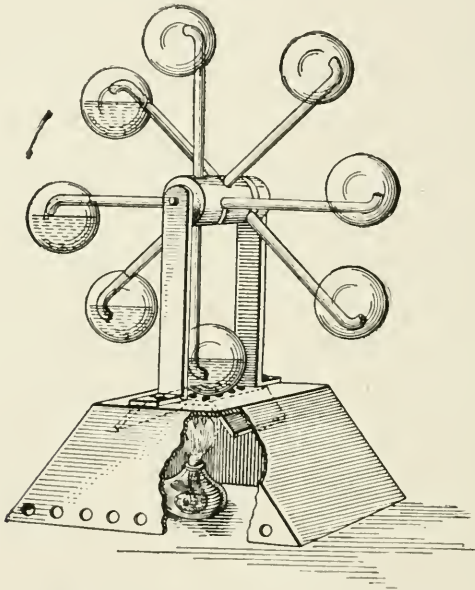

Fig. 189—An ornamental heat motor

to blow the remaining liquid into the opposite bulb directly on top. This displaces the center of gravity, as the bulbs overhang the center, and causes the set to revolve and bring each bulb in succession over the hot gas from the lamp, producing a rotary motion. Of course, very little power, if any, can be obtained from such a machine, but as a window attraction it is very successful. The source of heat being hidden, the sudden upward

flow of the liquid is mystifying, and very pretty effects can be obtained by using four different colored solutions of alcohol.

The sizes of the bulbs should be about $1\frac{1}{2}$ inches diameter, one of each pair being filled slightly over one-half its height with liquid. The distance between the centers of bulbs of the above diameter should be not less than 9 inches. The tubes should extend to within $\frac{1}{2}$ inch of the outer side of each bulb, and the connecting tube should be not less than $\frac{1}{8}$ inch inside.

The bulbs complete can be had made to order as described for about 50 cents at any glass blower's.—21

“ROTAGONS”

There is a class of geometrical figures possessing peculiarities which possibly have not been investigated or published before. For the sake of a title, and owing to the relation these figures bear both to circle and polygon, let us arbitrarily name them “rotagons.” A rotagon is a plane figure whose perimeter is composed of an odd number of circular arcs such that each point where two arcs meet is the center from which the opposite arc may be described.

Referring to Fig. 190, the figures *A*, *B*, *C*, and *D* show four out of an infinite number of forms which the rotagon may take. It may be observed that these figures have the same width in all directions, that the sum of the arcs equals a semi-circle, that the sum of the points of the inscribed star is therefore 180 degrees, or in other words, the dotted line and arcs represent the overlapping sectors of a semi-circle, and that these dotted lines may be conceived as link work whose limit of motion is reached in the figure *A*. When inscribed in a square or rhomb, rotagons may be conceived as turning around while remaining at all times in contact with the four sides. When regular in form, they may turn in any regular polygon the number of whose sides is one more or one less than the number of arcs, and they will maintain contact with all of the sides. It follows that the same motion is possible within any combination of three or more sides of the polygon, which, if produced, will close.

The motion is complex and the complete orbit of any given point consists of a number of elements (*glissettes*) which may be either elliptical, circular, or straight. These orbits, by reason of their composite nature, are of curious and even fantastic forms. Some idea of their endless variety may be gained from the accompanying diagrams, which were developed graphically by means of cardboard models. As the figure *A* turns in a square (see Fig. 190), the points 1, 2, 3, 4, describe the paths shown in section *E*. Sections *F*, *G*, and *H* contain the orbits of the same

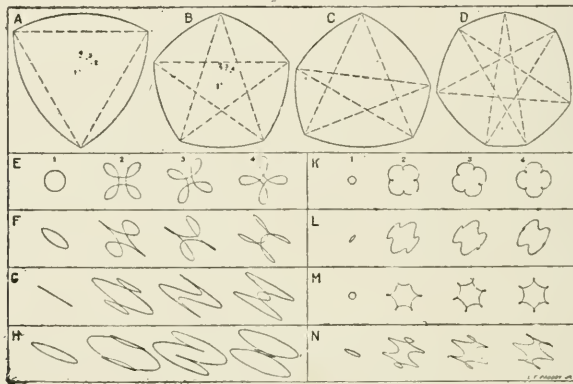

Fig. 190—Figures produced by rotatons of various forms

points as the figure turns in rhombs, whose minor angles are respectively 75, 60, and 45 degrees. Sections *K*, *L*, *M*, and *N* show the corresponding curves for points 1, 2, 3, 4, in the figure *B*. When *A* revolves once in a square, its center of gravity at point 1 makes three revolutions in an opposite direction in an orbit composed of four elliptical arcs. Regular rotatons produce symmetrical orbits, but irregular figures such as *C* and *D* produce unsymmetrical orbits. That such complex and intricate motions are possible in a single moving part under such simple conditions of operation, seems almost incredible until one has made the experiment. There is a singular grace and beauty in

some of the curves, which suggest possible adaptation in the field of decorative design.

Fig. 191 shows more fully the motion of the triangular rotagon. Twenty points are taken in the figure DAE , the point O being at the center and points 1, 2, 3, etc., being on the three axes A , B , and C . Each point and its corresponding orbit is indicated by the axis letter and the number of the point on that axis. The orbits

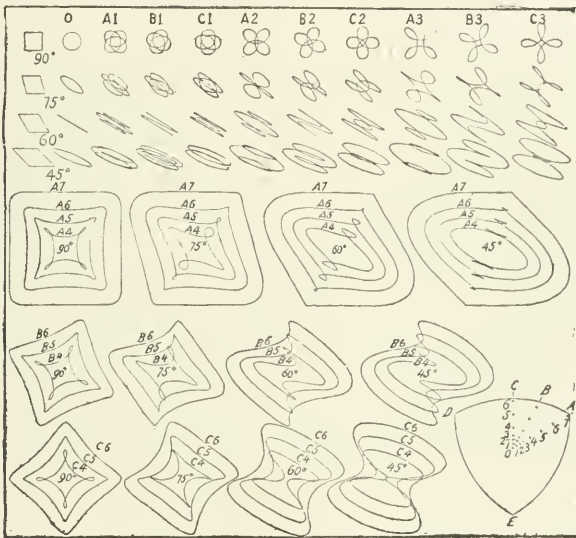

Fig. 191—Motions of a triangular rotagon in a square and rhombs of various angles

marked 90 degrees are described by these points when the rotagon moves in a square, and the other orbits are developed by turning the figure in rhombs, whose minor angles are 75, 60, and 45 degrees, as indicated.

In Fig. 192 the model f is shown ready for operation. The weighted pencil b is inserted in one of the holes in the cardboard and the model is turned around by hand and at the same time kept in contact with the guides aa , which may be set at any

angle. As the motion is determined by two contact points, the other two sides are unnecessary. The model used is about six inches in diameter, and from the orbits drawn by the pencil, free-hand ink tracings were made in order to facilitate reproduction in the accompanying cuts. This accounts for some roughness in the curves, which does not exist in the pencil drawings. Five-sided and seven-sided models (*c* and *d*) are shown in the illustration, and also a piece of wood *e* resting on "three-cornered rollers." When set in motion *e* travels in a straight line, exactly as if sup-

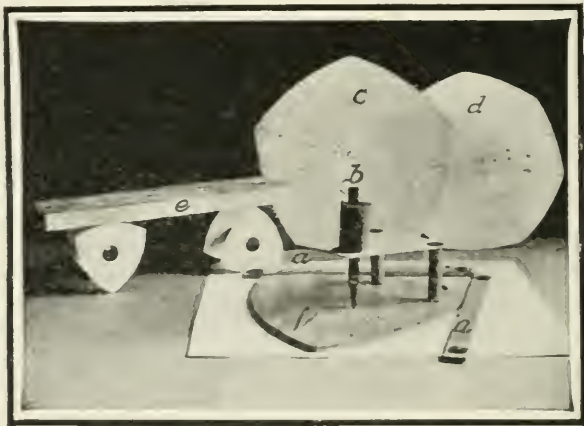

Fig. 192—Rotagon apparatus for producing geometrical figures

ported on cylinders, while the motion of the supports is alternately circular and cycloidal. The same motion would follow with any other form of the rotagon. To most persons it will come as a surprise to realize that a cylinder is not the only form of roller which will impart straight-line motion to a supported body.

The rotagon may possess little interest for the mathematician and may be without value in the realm of mechanics, but its properties are so unique and the infinite variety of its fixed motions is so startling that it becomes worthy of investigation, even if regarded only as a scientific toy.—65

A HOME-MADE SEISMOGRAPH

The Scientific American has occasionally told its readers something of the seismograph, and of the mysterious tremors and pulsations of the earth's crust that it reveals. But probably very few have ever seen one, or had the opportunity to "feel the earth's pulse" for themselves. Yet a really serviceable seismograph can be constructed by anyone with a mechanical head, with very few tools and a very small outlay. The following is substantially a description of the seismograph constructed by the writer at Euphrates College, Harpoot, Turkey. It involved an outlay for materials of less than three dollars. This instrument has been in operation for the past sixteen months, and has during that time recorded over one hundred and sixty earthquakes. Its construction is shown in the accompanying engraving.

The Steady Mass.—The fundamental part of the instrument is a horizontal pendulum, whose function it is to remain at rest during an earthquake. The mass is a sheet-iron drum, *A*, full of gravel, weighing about eighty pounds. This is fixed securely to the end of a one-inch iron pipe, *E*, whose other end rests, by a frictionless bearing *C*, against a solid wall. The drum is also hung from the wall by a similar bearing at *C'*. The bearings are made as follows: The half-inch machine bolts, *B* and *B'*, turn in nuts which are very firmly imbedded in the wall. In a slight depression in the head of *B* a quarter-inch bicycle ball, *C*, is set, with wax. Against this ball rests a polished, hardened steel plate, *D*, slightly concave, which is tacked to the hardwood plug driven into the end of the pipe *E*. The upper bearing ball, *C'*, is set in a depression in the bent bar *F* ($1\frac{1}{2}$ by $\frac{3}{8}$ -inch iron) which is firmly clamped to the wall by the bolt *B'*. The concave steel plate *D'* is cemented to the iron stirrup *G*. The other end of the stirrup is formed into a hook, over which passes the suspending wire, *W*, whose ends are fastened to the ends of the rod *HH'*, which passes through the drum *A*.

Adjustment of the Steady Mass.—By tapping the bar *F* to one side or the other, the bearing *C'* is brought exactly over *C*, so that the pendulum swings out perpendicular to the wall. The

bolt *B* is then turned in or out, to regulate the period of the swing. The pendulum, when disturbed, should swing back and forth once in forty or fifty seconds. Turning the bolt *B* inward shortens the period, turning it outward lengthens it. If *B* is too far out, the pendulum will not swing back and forth, but will swing clear over to either side. As it is impossible by moving the plate *F* to adjust the pendulum very exactly, a weight, *Z*, of

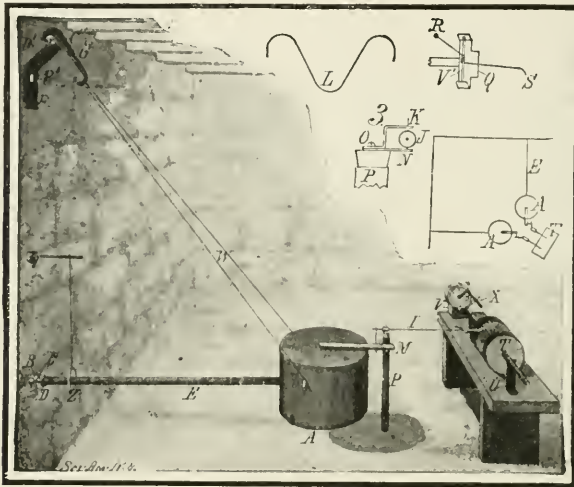

Fig. 193—A home-made seismograph

two or three ounces, is hung by a long thread against the strut *E* a few inches from the bearing. The support from which this weight is hung can be adjusted, so as to bring more or less pressure on the strut as needed.

Multiplying Lever and Recording Pen.—To the steady mass is connected the short arm of the multiplying lever *I*. The short arm consists of a bit of brass wire, No. 12, three inches long. It is inserted into the cork *J* which serves to join together the two arms of the lever and their pivot, *K*. At one inch distance from the pivot the brass wire is flattened slightly on top, and a conical depression is made in it. In this depression rests one point of a

link, L , of fine piano wire, shaped as shown in the detail view. The other end of the link rests in a similar depression in the brass bar M , which lies on the pendulum drum. This link communicates any motion of the drum to the short arm of the lever I . The long arm of the lever is a stout straw, fourteen inches long. The short arm should nearly balance the long one; if necessary, a drop of solder may be added at the end of the wire. At the end of the long arm is a crosspiece, Q , of aluminium foil, whose two ends are bent up to form a support for the needle I'' , whose pointed ends rest in depressions in the foil. A piece of No. 24 aluminium wire is given two turns about the needle I'' , and

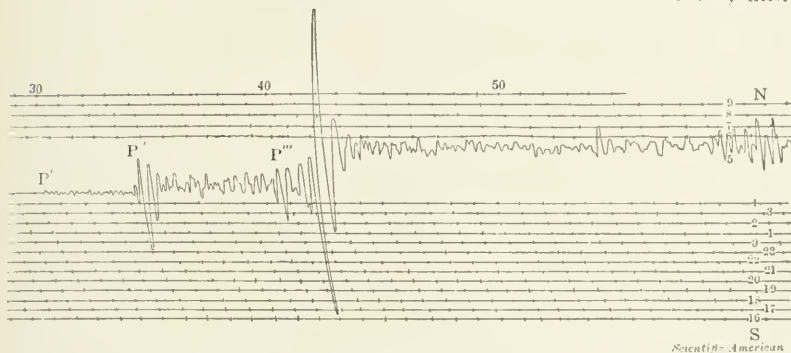

Fig. 194—A diagram of the Bokhara earthquake recorded by the home-made instrument at Harpoot, 1850 miles away.

cemented to it. One end of the wire, an inch long, is ground to a conical point, S , and bent downward so that the point rests on the drum T . The other end is bent up and to one side, and cut off half an inch long. A drop of wax, R , makes this short arm nearly balance the point. Thus when the point is down, it rests on the drum very lightly, and when swung up, the short arm does not touch the drum. The pivot, K , is a common sewing needle, rather fine, whose point rests in a conical depression at N , while the upper end passes through a fine hole in the sheet-brass yoke, $K O N$. The latter is fastened with a screw to the top of the post P , which is an iron pipe, firmly planted in the ground, with a hardwood plug driven into its upper end.

Recording Drum and Clock.—The recording drum is a cylindrical tin can closed at both ends, with a quarter-inch shaft fastened in its exact axis. The drum must be perfectly balanced on its axis by adding wax or solder to one side or the other. The shaft rests on uprights, *U*, of thick strap iron, which are fastened to the table on which the recorder is mounted. A screw thread of about thirty turns is formed on one end of the shaft with a soft brass wire, wound spirally and soldered at each end. This thread engages the upright, *U*, and drives the drum slowly forward as it rotates. The clock is an ordinary one-dollar lever clock. It is firmly fastened on the block, *V*, on the table, so that its axis is exactly in line with that of the drum *T*. The L-shaped iron wire *X* is soldered along the minute hand, and also to its bushing and pivot, so that it will rotate rigidly with the minute hand. The long arm of the L is parallel with the axis of the drum, and is engaged by a fork soldered to the end of the shaft. Thus the drum rotates with the clock, but moves gradually along its axis. On the drum is wrapped a sheet of white glazed paper, held in place by an open ring of spring wire slipped over each end of the drum. The paper is blackened by revolving the drum over a large, smoky flame, such as a kerosene torch.

Important Details of Construction.—Exact dimensions are unimportant. The drum *A* is one foot in diameter. The following points, however, are of vital importance:

1. The wall from which the pendulum is hung must be exceedingly solid. If possible it should be below ground, and not subject to great and changing strains. A lengthwise displacement of the millionth part of an inch in the upper part of the wall makes a perceptible jog in the record. Short-period tremors, however, such as machinery or cars near by, do no very serious harm.

2. The steel bearing plates, *D* and *D'*, after being shaped with a smooth, slightly concave surface, should be tempered file-hard, and then the bearing face should be highly polished with leather and fine emery.

3. The bearings of the lever *I*, the link *L*, and the stylus *RS* must be very perfect. The points of the needles, *K* and *V'*, and of

the link L must be perfectly sharp and smooth. The conical depressions in which they rest may be made by pressing into the metal a sharp-pointed awl with a whirling motion. In regions where sharp earthquakes are sometimes felt these depressions should be rather deep, to prevent the points flying out. The needle K must be exactly vertical.

4. As most of the friction of the seismograph is at the point of the stylus S , it is of the utmost importance that that stylus should rest very lightly on the paper, only heavily enough to scratch through a moderately thin soot layer. The broad part of the crosspiece Q should be bent upward, so as to prevent the stylus dropping too far when the pen swings off the paper in a great earthquake.

5. If there are drafts in the room where the seismograph is installed, the instrument must be well protected from them.

Time Marking.—To be of scientific value, the records should have exact time marked on them at frequent intervals. This can easily be done if a reliable clock is available. A bit of platinum wire soldered to the second-hand wheel makes a short contact once each minute with a fixed platinum wire. These contact points are connected, through two dry cells, to the magnet of an electric bell. (Directly, not through the vibrator.) The bell, with gong removed, is rigidly attached to the post P , so that the strike of the armature is at right angles to the lever I . Thus at the end of each minute there is a sharp click against the post, which causes, as it were, a miniature earthquake, which is plainly visible in the record. The effect is improved if the clapper of the bell be replaced with a lead weight of two or three ounces.

Records.—Once in twenty-four hours, after marking on the smoked paper the exact time at the last minute mark, the paper is carefully removed, a fresh sheet put in place and smoked, and the clock wound. First the beginning of each hour is marked, and on the top line a mark is made at every tenth minute. The date, ratio of magnification, and clock error are also noted. All these are scratched in the soot on the sheet. The record is then fixed by brushing rather thin varnish over the *back* of the sheet.

If a register is kept, at least the following data should be entered in it: 1. Time of the beginning of first preliminary tremors, P' . 2. Beginning of second preliminary tremors, P'' . 3. Beginning of the first group of large or principal waves, P''' . 4. Time of maximum motion. 5. Amplitude of maximum motion. (Measured from position of rest of pen to extreme of motion to either side. This should be divided by the ratio of magnification of the lever L .) 6. Period at time of maximum. (I. e., time from one crest to the next of the largest waves.) 7. Time of end of principal portion. 8. End of succeeding tremors.

Locating a Distant Earthquake.—The writer has been able, in the case of large, distant earthquakes, to announce the general location of the shock at once, from the records of the seismograph. Two elements are needed for this—the distance and the direction. As the first preliminary tremors travel much faster than the main, large waves, the difference in time of their arrival gives a measure of the distance of the origin. Various formulæ have been computed for this, some of them very complicated. The writer has found, however, that a uniform rate of three degrees per minute is not far from the truth, for all distances; that is, for every minute that elapses between the beginning of the first tremor P' and the beginning of the first group of large waves P''' , measure three degrees of distance on a great circle of the globe. That will generally give within ten per cent of the correct distance.

To determine the direction of an origin, a single horizontal pendulum is inadequate. There must be two, set at right angles to one another, so that by compounding the two co-ordinates thus given, the actual direction of the earth's movements may be seen. The small diagram shows one method of bringing the records of two pendulums on one recording drum. The short arm of each recording lever is set at an angle of 135 deg. to the long arm, thus bringing the long arms parallel, as shown. One pendulum hangs north and south, and records motions of the earth east and west, while the other records motions north and south. To determine the direction of an earthquake origin, attention need

be given only to the very first one or two waves of the preliminary tremors. It is known that the first preliminary tremors are waves which, like sound waves, move in a direction parallel to the line of propagation, while the main waves have a motion at right angles to this, like light. The latter, however, are exceedingly complicated waves, while, so far as the writer has observed, the first preliminary tremors always begin with a very slight motion away from the point of origin, followed by a considerably larger swing toward the origin. So that whenever the beginning of these tremors is strongly recorded it is possible, by comparing the north-south and east-west components of these first motions, to ascertain the direction from which the waves have come. This, with the distance, marked out (on the great circle) on a globe, gives the approximate location of the earthquake.—79

CHAPTER VI.

THE HANDY MAN'S ELECTRICAL LABORATORY

AN UNBREAKABLE LEYDEN JAR

Two ordinary tin cans may be used to make a serviceable Leyden jar, which has the advantage of being unbreakable.

Select two tin cans such that the diameter of the one exceeds that of the other by about one-half inch. Cover the bottom of the

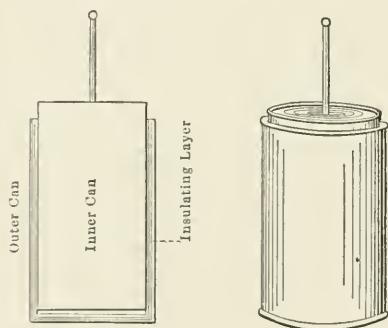

Fig. 195—An unbreakable Leyden jar

larger can (inside) with a disk of rubber or varnished cardboard. To the bottom of the smaller can (on the outside) solder a piece of iron or copper wire, bent into a hook at the tip, or else ending in a ball. Around the smaller can wind an old rubber plate or several layers of silk rags or well-varnished parchment, folding this insulating layer down into the can over the edge, an inch or more. Place

the smaller can, thus insulated, with the edge down, in the larger can, and the Leyden jar is completed, ready to be charged from a frictional machine or an electrophorus.

The inner can should stand out an inch or so above the outer can, to prevent sparks from passing over.—103

A SUBSTITUTE FOR TINFOIL IN LEYDEN JARS

The deposit of silver from a mirror solution is a convenient and effective substitute for the tinfoil on the inside of Leyden jars. It lies close, and presents no points or sharp edges to invite

a puncture of the glass. It very much enlarges one's choice of bottles, as one is not obliged to sacrifice a flask of good dielectric properties because it has too narrow a mouth for convenient manipulation of the tinfoil. The suggestion may have other applications; for instance, a pair of thin glass test tubes, silvered in this way, serve very well in the construction of Regnault's hygrometer.

The easiest way to get proper silvering solution is to go down to the mirror maker's with the flasks that need the coating. The solution can be purchased for a trifle. The following formula will do very well. A. Rochelle salt 10 grammes in 1 liter of water. B. Silver nitrate 5 grammes dissolved in a little water. Add 3 grammes of strong ammonia gradually, so that the precipitate at first formed is dissolved. Add water enough to make 1 liter. Mix equal parts of A and B. The glass ought to be perfectly clean and at a temperature of 25 deg. or 30 deg. C. In about half an hour the deposit is complete.—43

A HOME-MADE WIMSHURST MACHINE

The Wimshurst machine illustrated herewith (Fig. 196) was made very cheaply out of such materials as came to hand. The frame is of oak and the bosses of pine. The two glass disks are 12 inches in diameter. The sectors were made of brass foil with brass hemispheres (tack heads) soldered on them. Sixteen sectors are used on each disk. The Leyden jars consist of Welsbach lamp chimneys (the straight kind) to which the tinfoil was applied at the center, keeping it $1\frac{1}{2}$ inches from each end. The posts that support the combs and terminals pass through the chimneys. The posts are of hard rubber, and each has a hole bored in the end to receive the stem of the brass ball, which connects the comb and the terminal to it. The stems were made fast by pouring melted sulphur into the holes around them. The combs are connected to the inner coating of the Leyden jars. In place of simply connecting the outer coatings of the jars with wire, two tubes are fitted into the frame in such manner that they can be connected by putting a plug in one tube, and be disconnected by putting it

into the other, and then hand holes or any other form of terminals may be attached to them.

The device is used for a display design by placing in the circuit a tinfoil strip cut away at the points where sparks are wanted to

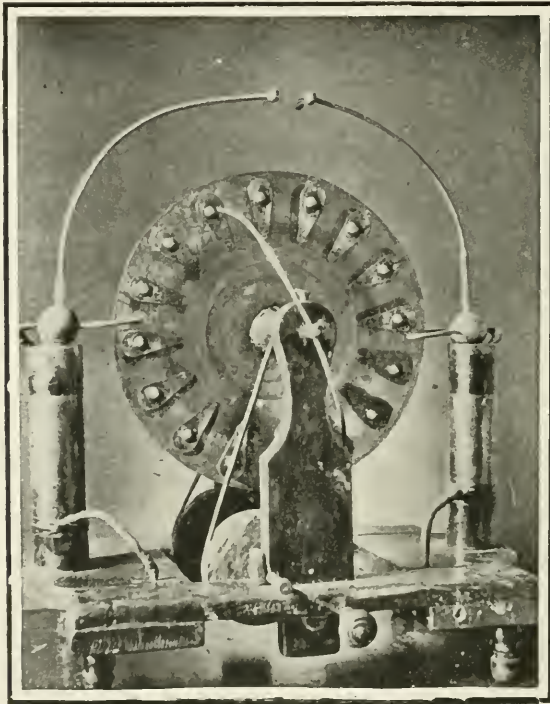

Fig. 196—A home-made Wimshurst machine

make the design or letters, etc. When the outer coatings are connected, a $1\frac{1}{2}$ -inch spark is obtained. The machine is driven by means of oak pulleys and a leather cord belt.

The accompanying photograph of the machine and the spark was made as follows: When the camera had been focused on

the machine, the room was darkened by drawing the shades; then while the plate was exposed, the machine was operated to give several sparks. The camera was now closed and, after the shades were raised, a second exposure was made without disturbing the machine or the camera.—I

HOW TO MAKE AN OSCILLATING STATIC ELECTRIC MOTOR

There is no adjunct of the influence machine that affords a prettier or more striking experimental demonstration of electrostatic attractions and repulsions than an oscillating static motor.

In view of the dependence of the action of all ordinary types

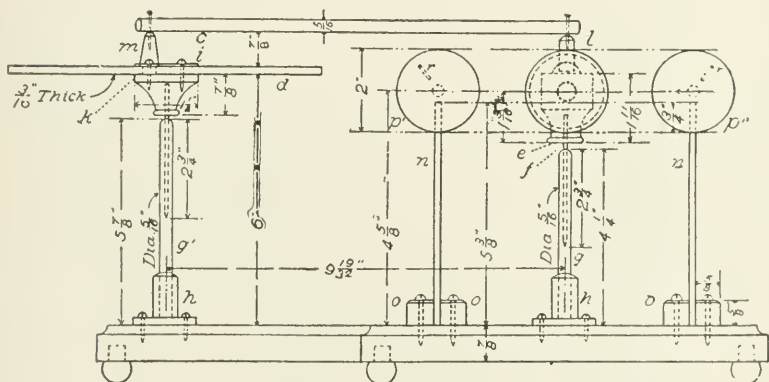

Fig. 197—Side elevation of the motor

of electric motors upon magnetic influences, the curious little machine here illustrated is truly unique; for though an electric motor in the purest sense of the term, yet it derives its motions from forces that are wholly non-magnetic. With the aid of the working drawings and the hints here given, the amateur may easily construct for himself an experimental static motor whose action will be highly gratifying and instructive.

A horizontally oscillating lever, *a*, of round vulcanite rod, carrying at its extremities two hollow balls, *b* and *b'*, of soft pine, communicates its motion through a slender vulcanite connecting

rod, *c*, to a light flywheel, *d*, of thin wood. The lever, *a*, passes tightly through a turned wooden hub, *e*, into whose lower end is inserted a pivot rod, *f*, of steel wire, slightly under $\frac{1}{8}$ inch in size. The lower portion of *f*, whose end terminates in a sharp point, turns freely in a vertical socket, *g*, rising from the wooden base of the instrument. The flywheel is supported in a similar manner by pivot socket *g'*. These sockets, which are of $\frac{5}{16}$ -inch round brass rod, soldered into turned brass foot pieces, *h*, are drilled longitudinally in the lathe with a $\frac{1}{8}$ -inch twist drill to a

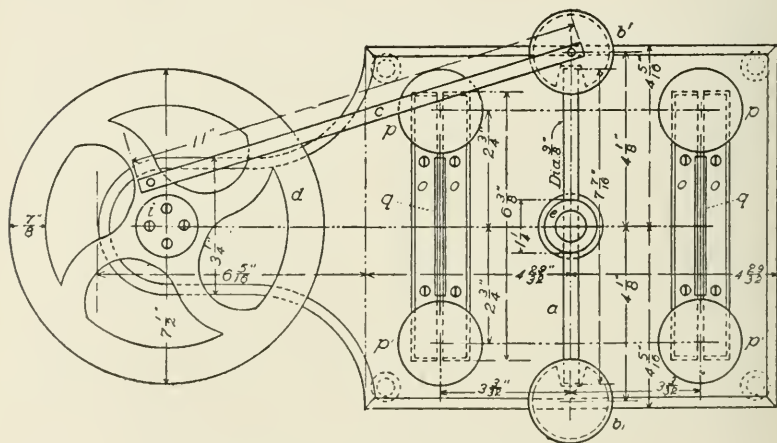

Fig. 198—Plan view of the motor

depth of $2\frac{3}{4}$ inches. To reduce friction as much as possible, the parts of the pivot rods within the sockets are filed down slightly in their middle so that they may bear against the sides of the sockets for short distances only, near the tops and bottoms of the holes.

A circular polished plate, *i*, of sheet brass, centrally located on the upper face of the wheel serves to give the latter a finish, and to assist in binding it with small screws upon the turned wooden hub, *k*. Into the ball, *b'*, is inserted vertically a short piece, *l*, of $\frac{3}{8}$ -inch round wooden rod having a rounded top to

reduce the friction between itself and the connecting rod whose end it supports. A round-topped conical wooden crank pin, *m*, rising from the wheel, supports the other end of *c*. The lower end of *m* is turned down slightly and glued into a $\frac{1}{4}$ -inch hole bored through one of the arms of *d* near the hub. The connecting rod, *c*, works freely on two slender wire nails which pass loosely through transverse holes in the rod near its ends and enter *l* and *m* respectively.

On the base of the machine on opposite sides of *g*, and at equal distances from it, are erected vertically, and parallel with each

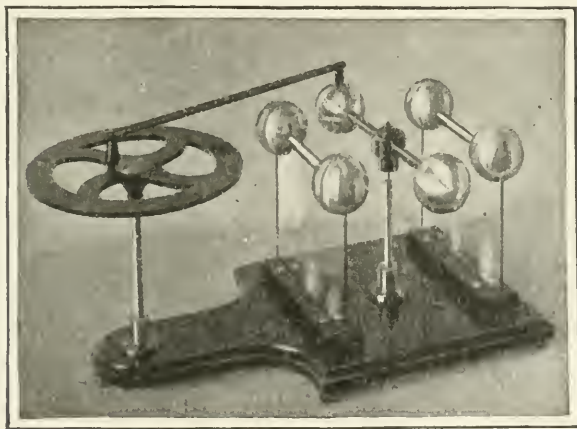

Fig. 199—The static electric motor

other, two rectangular pieces of double-strength window glass, *n*, each measuring $6\frac{3}{8} \times 5\frac{3}{8}$ inches, the glasses being held firmly with shellac between the square wooden cleats, *o*. Upon the upper corners of each glass are cemented with shellac two solid wooden balls, *p* and *p'*, the balls being slotted to a depth of $\frac{3}{4}$ inch to receive the glass. The two balls on each glass are electrically connected with each other through a straight stiff wire passing between them, the exposed portion of the wire being covered for purposes of insulation with lengths of glass tubing, *q*.

In each of the balls, p' , a little above its horizontal center, a small hole, r , is bored, somewhat slantingly downward, to receive the ends of the conducting cords or wires connecting the two pairs of stationary balls, respectively, to the positive and negative poles of the static machine. The exact distance apart of the holes in c , also the radius of the circle described by the movement of the crank pin, m , are not given on the drawing, as it is best to determine these experimentally. The latter should be such as will give about $3/16$ -inch clearance space between the stationary and the moving balls at the end of the latter's travel. To determine the former accurately, a temporary experimental rod of flat thin wood should first be made. By a few experiments with differently spaced pairs of trial holes in the wooden rod a distance will be found which will evenly divide the clearance room between the stationary and the moving balls at both extremes of the motion of the lever. When the proper distance is found the vulcanite rod may be marked and drilled from the wooden pattern.

The hollowing out of the moving balls, by reducing the weight, adds considerably to the speed of the motor, and is effected as follows: After being bored to a depth of $3/4$ inch, and fitted to receive the lever, a , and the vertical pin, l , the balls are neatly split apart through the centers of the bored sockets by carefully driving into them a thin-bladed case knife, which will open them with very little bruising. With a small, sharp gouge each half is hollowed out until its walls are not more than $1/8$ inch thick, removing all of the material that can be spared without cutting away the bored sockets. The halves are then glued together again. Before assembling the parts all of the balls must receive a conducting coating of tinfoil. This may be neatly done in the following manner: The ball is first given a sizing of shellac and allowed to dry thoroughly; it is then well smoothed down with sand paper. Next prepare two round pieces of foil about $1\frac{1}{2}$ inch across, slitting each piece inward from its edge for a distance to about $1/3$ its diameter. A place upon the ball equal in size to that of the foil is now shellacked, as is also one side of the foil itself. Wait a few moments until the varnish has become

quite "tacky," then lay the foil in position with the varnished side against the varnished place on the ball and press down into place, allowing the slitted flaps to overlap to prevent undue wrinkling. Proceed in like manner with the second piece, locating it as exactly as possible on the opposite diameter of the ball. The uncovered zone around the equator of the ball is now covered, a piece at a time, with strips of foil reaching across it from one end piece to the other, and as wide as can be applied without excessive wrinkling, varnishing only such portion of the ball at a time as will be covered by the strip to be applied. To avoid too much overlapping of each other at their ends the strips are made somewhat narrower at their ends than at their middle. After the ball is covered all loose corners or edges of foil should be carefully shaved off and any wrinkles or rough places nicely burnished down with a lead pencil or some smooth implement. An almost invisible point left projecting might seriously impair the working of the motor by allowing a silent escape of the electricity into the air. All the working joints must be made sufficiently loose to insure perfect freedom of movement without any possibility of cramping or binding, for it must be remembered that the mechanical forces of static electricity are of a very delicate nature. In operating, to get the best effects, some experimentation will be necessary to ascertain the proper degree of electrification; too vigorous excitation will be found as undesirable as too feeble. If the foregoing conditions have been complied with, the motor will run very satisfactorily from a small Holtz or Wimshurst machine, its speed being about 175 revolutions per minute. The completed machine is shown in perspective in Fig. 199. The action of the instrument depends upon the well-known physical principle of attraction between unlike and repulsion between like electrical states. When covered wires are run from the opposite poles of the generator to the two pairs of fixed balls, the latter become charged, respectively, with positive and negative electricities. The movable balls, being as yet uncharged, are attracted and drawn toward the nearest of the electrified stationary balls, until coming close enough, each moving ball receives a spark and becomes

identical in polarity with the ball that has attracted it. Attraction is now instantly changed to repulsion, and the lever begins to reverse its movement. The moving balls, now bearing charges opposite in sign to those of the fixed balls they are approaching, are strongly attracted by the latter, while repelled by those they are receding from. This state persists until the moving balls, gaining fresh sparks of opposite sign to those they first received, have their electrification reversed and are again repelled. A continuous oscillation of the lever with rotation of the wheel results.

With its crisp-clicking sparks, its general air of brisk activity, and the interesting play of the group of curiously correlated forces visibly demonstrated, the experiment is a most pleasing and attractive one.—24

ELECTROSTATIC ILLUMINATIONS: INTERESTING EXPERIMENTS FOR THE INDUCTION MACHINE

Among the multitude of attractive experimental possibilities suggested by high-tension electricity, there is no class of phenomena susceptible of more interesting treatment, or in whose development lies fairer promise of gratifying result from simple apparatus, than the beautiful luminous effects of the static discharge over interrupted conductors. A certain few pleasing experiments of this character have long formed a familiar subject of illustration in most of the older works on physics; however, very little recent effort toward any amplification of these beautiful effects has been made.

Ordinarily, in such experiments the conductor remains at rest, its cut spaces illumined by the electric discharge, the value of the result as a spectacle depending upon the necessarily limited disposition that can be made of the luminous conductor; but by arranging the latter to be kept in rapid motion, so as to call into play the phenomenon of persistence of vision, this form of experiment becomes at once susceptible of some exceedingly fine adaptations.

To those having at hand a good static machine the illumination of such objects as wine glasses, vases, lamp chimneys or any symmetrical glass objects of this sort, becomes easy, and consti-

tutes one of the most beautiful of all the varied line of possible visual effects. Fig. 200 suggests the method of arranging such articles for illumination. In the example illustrated a large goblet of thin glass is held by three small screws upon a revolving platform having upon its under side a small grooved pulley which is



Fig. 200—Goblet mounted for illumination

belted for moderately rapid rotation to a suitable hand wheel. A single narrow strip of tinfoil, $1/16$ of an inch wide, is cemented over the glass with thick shellac varnish as follows: Starting under the goblet at the spindle of the whirling table, with which it makes contact, the strip proceeds to the edge of the foot of the glass, which it follows for perhaps an inch; thence in a curved line

across the base to the stem, which it ascends in a straight path; then, over the bowl of the goblet in a somewhat sinuous course to the upper rim, after following which for about one-third its circumference it descends upon the inside, and terminates in the center at the bottom. All that portion of the tinfoil on the outside and along the upper rim is divided every eighth of an inch

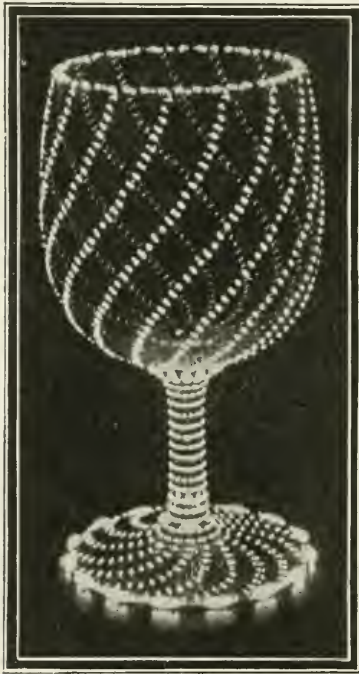

Fig. 201—Luminous goblet

with a knife point, those parts within and under the goblet being left intact. The divisions should be carefully gone over and examined to see that they are all perfect and of sufficient width to insure a good bright spark at each break when the current from a Wimshurst machine is passed through the foil. Current is led into the strip through binding posts attached respectively to the supporting spindle of the whirling table, and to the foot of a vertical conducting standard formed of brass tubing, rising from the base of the apparatus at some distance from the goblet. The curved upper part of the standard, formed of thick wire, is made removable to

allow of changing the object to be exhibited, one end fitting into the brass tube, the other terminating in a fine, straight, stiff wire that extends down inside of the goblet, nearly touching the end of the tinfoil strip. A piece of glass tubing covers the lower part of the standard for purposes of insulation. When the glass is whirled rapidly with the static discharge pass-

ing over it in a darkened room, the effect is one of exceeding beauty. Surrounding objects and even the substance of the goblet itself are invisible. Nothing is seen but the brilliantly luminous strip, multiplied many times by persistence of vision, and seeming to cover the whole glass at once, studding it most beautifully all over with innumerable jewels of sparkling light. Some idea of the general aspect of the experiment may be gained from Fig.

201. The ornamental irregularity seen around the periphery of the foot of the goblet is obtained by cutting out of that portion of the tinfoil following the edge a section about $\frac{3}{8}$ of an inch long, producing at this point a spark longer and brighter than the others. The same might be done with the upper rim if desired. Should it be desirable to produce these results on a larger scale, such objects as fish globes, show domes, large bottles, etc., may be used, the style of decoration being capable of considerable variation through the disposal of the luminous strip.

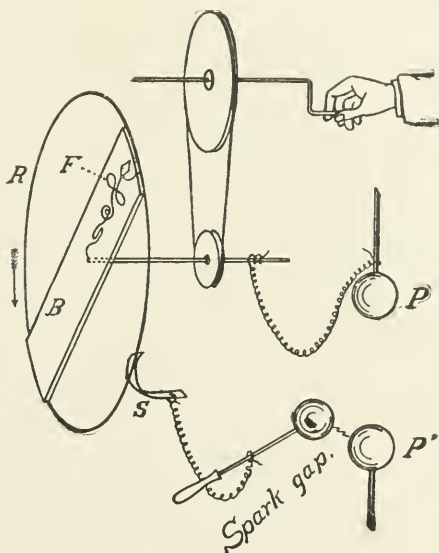

Fig. 202—Diagram showing apparatus employed

One of the finest of luminous optical effects with which persistence of vision has to do is that known as "Gaisso's wheel," produced by the rotation of a single Geissler tube. Owing, however, to the fragility and expensiveness of Geissler tubes and the difficulty of mounting them safely for rotation, the spectacle is rarely exhibited. A beautiful modification of this experiment,

utilizing the interrupted conductor, and having the advantage of simplicity and substantialness, will be understood from Fig. 202. A thin, smooth, well-shellacked board, *B*, 24 inches long, is mounted at its middle on a metallic shaft so as to be capable of rapid rotation edgewise. On the back of the board at each end are screwed two small plates of sheet brass to which is soldered,

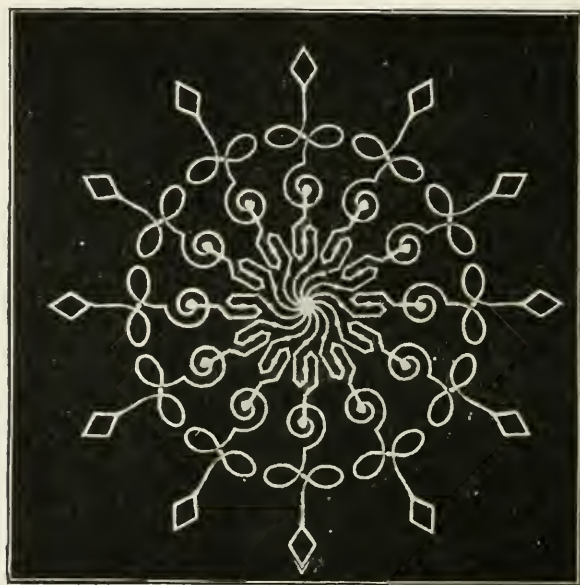

Fig. 203—Colored electric star produced with interrupted conductor

in such a manner as to be concentric with the shaft, a ring, *R*, of stiff wire, about equal in diameter to the length of the board. A narrow tinfoil conductor, *F*, divided at $\frac{1}{4}$ -inch intervals, is laid on one-half the board in some fanciful shape, insulating with thick, transparent mica wherever the foil crosses or returns upon itself. The ends of the strip make contact with the shaft and ring

respectively. From the opposite poles, P and P' , of an influence machine wires are run, one direct to the shaft and the other through an adjustable spark gap to a stationary spring, S , of thin leaf copper, or a small tinsel brush, bearing lightly against R . When the board is whirled in the dark with the static discharge in action, there appears a magnificent, brilliant, many-armed star of generous size. The original of the photograph, Fig. 203. produced in this manner with a large generator, was over three feet across. Exquisite color effects may be secured by placing over different portions of the luminous conductor pieces of mica stained thickly with transparent water colors, such as are used for coloring lantern slides, photographs, etc. The speed of rotation for the above experiments should approximate 450 turns per minute to insure good persistence effects.

The spark fulfills an important function in all interrupted conductor experiments, especially those in which the conductor is to be rotated. Evidently, in the latter class, the spark discharge from the influence machine must occur at regular time intervals, or the elements of the luminous figure will not appear evenly spaced. The gap operates to effect the necessary steadiness of discharge, besides adding greatly to its brilliancy. It also increases materially the power of the generator to overcome a given resistance. Through its use, in conjunction with the two small Leyden jars of a medium-sized Wimshurst machine, the writer has been able to send with ease an apparently continuous discharge entirely around a room fifteen feet square over a tinfoil conductor divided every two inches, the same being shellacked directly on to the wall paper near the ceiling, the latter also carrying as a center-piece a large circle, similarly made, over four feet in diameter. To an observer seeing it for the first time, this effect is novel and surprising. The whole atmosphere seems aglow with a subdued, mist-like radiance—pale, shimmering, and weird. The gap should be arranged between two large, rounded surfaces, such as smooth metal or foil-covered, wooden balls, $2\frac{1}{2}$ inches or more in diameter, one of them on a sliding rod for adjustment.

STRATIFICATION IN VACUO: ITS PRODUCTION WITH THE INFLUENCE MACHINE

Every experimenter in electricity who has had to do with Geissler tubes has at one time or another marveled at the beauty and the mystery of the phenomena of stratification. In producing the stratified light *in vacuo* the Ruhmkorff coil has been generally regarded as the only practically available means for the illumination of the vacuum. So common has been this impression that few experimenters, not even the makers themselves of the tubes, have seemed aware of the valuable possibilities of the influence machine for this particular form of experiment. This, of course, has not been without its reason. While no special precaution or nicety of manipulation is required in exhibiting stratified tubes with the coil, when such a tube is essayed to be used with the static machine the first experiences are usually disappointing. As the vacuous space merely lights up with the familiar unbroken glow of the ordinary Geissler tube, without any traces of striation, the experimenter naturally concludes the desired effect to be impossible of attainment with the static machine. However, with attention to a few simple details of technique, striations can be developed with the influence machine, having a distinctness and beauty, uniformity, and fixity of position never realized with the coil method of excitation.

In bringing out the striæ with the static machine two vital conditions are to be observed; namely, sufficient, though not excessive current through the tube; and the careful avoidance of all sparking, even of the minutest character, at possible imperfect contacts in any part of the circuit outside the tube. The first implies a generator of sufficient size, to begin with, whose output can then be diminished or increased by regulation of its speed. In exciting stratification tubes with machines of the Holtz type it is generally only necessary to connect their terminals direct to the poles of the machine, with careful attention to perfect metallic contacts; the minutest break where disruptive sparking can occur destroys the striation and diffuses the light. This precaution

attended to, the proper strength of current must be found by experimental regulation of the speed of the generator. As the machine slowly starts, the light within the tube is first seen as a thick nebulous line along the axis of the tube between the electrodes. This, at first continuous and steady, soon shows signs of uneasiness as the machine speeds up, and presently wavers and breaks into a beautiful series of brilliant, evenly spaced, isolated bands or strata which, when the current strength attains a certain value, settle into fixed positions and remain perfectly motionless. It is significant of this feature of steadiness that it is one specially remarked by De la Rue as characteristic of the striæ developed in his vacuum tubes by direct galvanic currents, during his now historical experiments with high-potential batteries of many hundred cells; thus, again, suggestion of the probable ultimate iden-



Fig. 204—Striation produced with influence machine

ty of the natures of static and voltaic forms of electrical action is here vividly brought to mind. In the study of striation by the present method, the almost total absence of the violent oscillatory movements, frequent blurring and overlapping, and uneven spacing of the striæ so characteristic of coil excitation, is an obvious advantage. The remarkable constancy of the stratification renders easy the making of photographic studies, with time exposures. Fig. 204 illustrates the beautiful uniformity, even spacing and perfect segregation of the striæ produced with a Wimshurst machine in a 12-inch tube, the effect being photographed with a three-minute exposure. In exciting stratification with the Wimshurst machine (which has probably been more largely made and used by amateurs than any other type), a simple device which from its function might be termed an atmospheric rheostat is

required in conjunction with the tube. This necessity arises from a well-known peculiarity of Wimshurst machines, especially those of the sectorless type. If such machines are attempted to be run on closed circuit, or on a circuit having too little resistance, such, for example, as might be offered by a single Geissler's tube, their fields suffer such a diminution of potential as to cause a serious falling off of the output of the generator; thus, a tube may not receive sufficient energy even from a large generator to establish the stratification. This is obviated by supplementing the resistance of the tube by that of two air gaps, one on each side of the tube in series with it. But as these gaps must not be *spark* gaps, the construction shown in Fig. 205 is adopted. Two smooth metallic disks three or four inches in diameter

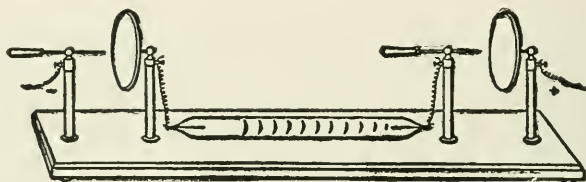

Fig. 205—Atmospheric rheostat for stratification in vacuo with Wimshurst machine

with well rounded edges are mounted in vertical positions on short insulating standards. Opposite the center of each disk and facing it is an insulated sliding rod terminating in a fine sharp point capable of longitudinal adjustment through a space of two or three inches. The tube to be exhibited is connected as shown between the two middle posts; the two outer posts are in unbroken metallic connection with the opposite poles of the generator. With this arrangement the current passes the air gaps between the points and disks as a silent, continuous, non-sparking discharge and the stratifications within the tube are beautifully developed. In using the device, proper polarity is of vital importance. The point at the left must be connected to the *negative* side of the generator—that side which shows the *brush* effect on

the collecting combs; the disk at the right is wired to the positive pole. If this order be reversed, sparking occurs at the resistance gaps and the effect is destroyed.

The "stratified" tube, without which no collection of vacuum tubes is complete, is a specially prepared Geissler tube exhausted to just the proper degree, and containing some particular residual gas or vapor whose molecular movement has been found especially compliant to certain conditions of vibration, in the peculiar ordering of which the phenomena of "resonance" has had strong suggestion of probable participation.—24

A SIMPLE EXPERIMENT IN STATIC ELECTRICITY

Of the many interesting effects obtainable with static electricity, one of the most pleasing and instructive is the ringing of a bell by alternate attraction and repulsion of a freely-moving insulated body. The experiment, however, as ordinarily arranged, is not easily available for home demonstration, owing to the usual requirement of Leyden jars and machinery for charging.

Fig. 205 shows how a very pretty impromptu exhibition of the experiment can be given, using only such simple apparatus as can be assembled in five minutes' time from among the common objects of the household.

A large round pie tin is supported bottom upward upon a clean inverted glass tumbler. A small bell borrowed for the occasion from the family alarm clock is mounted at a distance of one inch from the pie tin upon a sharpened pine stick inserted in a base made from a large potato, which has had a flat slice cut from its under side to make it set level. The lower edge of bell and pie tin are adjusted to exactly the same height.

From the family button box select a very small round metallic button shaped like a shoe button, and not larger if possible than a very small pea. Suspend this button by its eye with a *silk* thread from a support made by inserting a slender stick about 14 inches long into a second potato base, as shown in the illustration. Adjust the suspended button so that it will hang exactly in the middle of the space between the bell and pie tin, and

at a height coincident with the edge of the bell. The adjustment for height is easily made by drawing the thread through a small knife cleft in the end of the stick.

Cut a piece of newspaper of a width equal to the diameter of the pie tin, and of a length 2 or 3 inches greater than the width. Lay the paper upon a piece of smooth board, which has been previously well heated in an oven or over the gas range. Hold the paper down upon the hot board by one of its ends, and with the palm of the hand rub it strongly and briskly all over in one direction, using considerable pressure and taking care that the hand is dry and free from all perspiration. After a few strokes

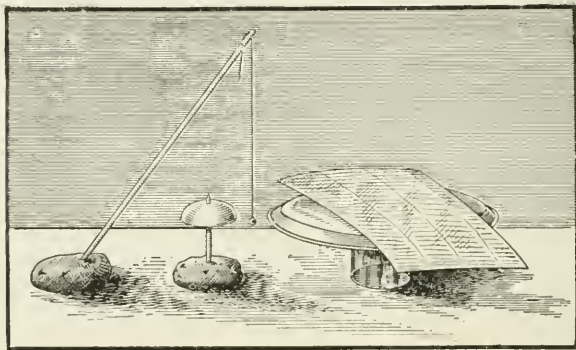

Fig. 206—Ringing a bell by static electricity

the paper will become powerfully electrified, and will be found strongly adherent to the board by electrical attraction. Now lift the paper quickly by its two ends, and drop it across the tin, being careful not to let the fingers touch the tin. See also that the corners of the paper do not bend down far enough to touch the table. As the charged paper strikes the tin, the little clapper begins a vigorous vibration, striking alternately the bell and the pie tin, producing a continuous ringing which persists for some time. After the button has finally ceased its motion, the mere

lifting of the paper off the tin causes it to begin again with renewed vigor.

Under good atmospheric conditions it is not always necessary that the charged paper actually touch the tin plate.

Oftentimes its mere presence in the vicinity of the plate, 3 or 4 inches above it, is sufficient to set the bell ringing by induction. If a small hard pellet about the size of a buckshot (made by rolling a little pinch of fresh bread between the fingers) be substituted for the metallic clapper, the motions of the pellet, by reason of its comparative lightness, will be much exaggerated, and the little ball will execute many comical and unexpected gyrations.

The tumbler used must be one of thin blown glass to obtain perfect insulation, the heavy tumblers of thick pressed glass being entirely worthless for the purpose. Also, a detail not to be forgotten is to render the wooden support for the bell electrically conductive by wetting its surface thoroughly all over, to allow the free escape of the electricity brought to the bell from the pie tin by the successive contacts of the clapper. Like all other exhibitions of static electric phenomena, the one here described succeeds best in cold weather, it being practically useless to expect satisfactory results from it with the atmosphere outside above the freezing point, though its action is always very gratifying at other times. The experiment as here illustrated constitutes a very attractive parlor demonstration, which, from its simplicity of arrangement and certainty of action, is always in favor with the young.—24

HOW TO MAKE A SIMPLE ELECTRIC ENGINE

A simple electric engine may be made as follows: Take an ordinary electric bell and remove the gong. The striker arm should be cut off about $\frac{3}{4}$ inch from the armature leaving the butt *G*. A strip of brass $\frac{1}{16}$ inch thick and $\frac{1}{4}$ inch wide of suitable length is bored at both ends, one end to fit the butt *G* and the other end to fit the crank *J* of the shaft *C*. The shaft is made of $\frac{1}{8}$ -inch diameter brass or steel—care should be taken

to make the stroke of the crank *J* the same as that of the armature.

The balance wheel *A* is fastened to the shaft *C*. Any wheel of suitable size and weight can be used. In the model made by the writer a valve wheel 2 inches in diameter was used.

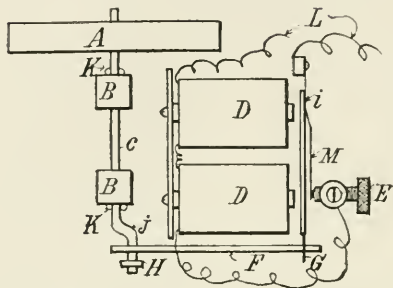

Fig. 207—A simple electric engine

The bearings *B* can be made of strip brass—in the model screw eyes were used. *K K* are wire rings soldered to the shaft *C* to keep it in place. *H* is a wire ring soldered to the crank to keep the strip *F* in place. When the screw *E* is properly adjusted and the terminals *L* are connected to a battery the engine will run at a high rate of speed.—12

A SIMPLE MEDICAL COIL

Doubtless there are many persons who would like to make an induction coil for medical use, but are deterred from so doing by the belief that the work is too difficult for any one but a skilled mechanic to undertake. This is a great mistake, however, as it is quite possible for almost anybody to make a coil that will give good results at a cost of but a few cents, and with the use of only the most ordinary tools.

For the core there may be used an iron bolt about three inches long and three-eighths of an inch in diameter, as shown at *A* in the accompanying drawing. It is a good plan to soften the bolt by heating it red hot in a fire and allowing it to cool slowly. Make two thin wooden washers about an inch and a quarter in diameter, and glue them on the bolt to form a spool as shown at *B*, and cover the iron between the heads with a wrapping of two layers of paper glued on. The nut shown is not necessary, but makes a neat finish.

The first part of the winding, or primary coil, requires about half an ounce of No. 20 or No. 22 double cotton-covered magnet wire. Pass the end of the wire through a small hole in one of the heads, and wind on a smooth layer of the wire like thread on a spool. When the opposite head is reached wind a second layer of wire over the first one back to the place of beginning. Cut off the wire and pass the end through a second hole in the head near the first one, as shown at *D*. The excess of wire will be useful for connections.

The next part of the winding, or secondary coil, requires an ounce or two of No. 32 single cotton-covered magnet wire. Finer wire gives more powerful results because of the greater number of turns for a given weight, but it is rather delicate to handle. Before winding on any of this wire, glue on a wrapping of two or three layers of paper over the primary coil, to keep the two coils entirely separate. The secondary wire need not be wound in layers, though care is required to avoid injuring the insulation or breaking the wire by pulling it too tight. The two ends may be left projecting, as shown at *H*, for connection to two handles or electrodes, and the coil may be protected by a final wrapping of paper, as shown at *C*.

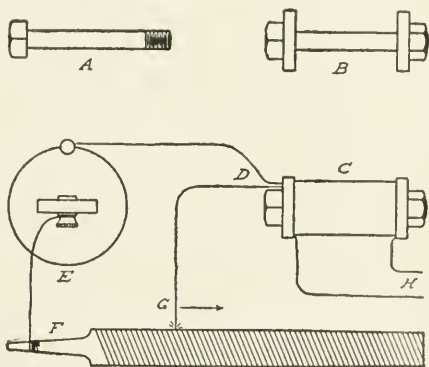

Fig. 208—A simple medical coil

One pole of a dry battery *E* is connected to the tang of a large file *F*, and the other to one of the primary terminals *D*. The remaining primary terminal *G* is then lightly dragged along the surface of the file, thus making and breaking the circuit in rapid succession as the wire passes over the teeth. If the shocks received from the handles are too strong, use a longer piece of wire

at *G*; if too weak, add another dry battery in series, or put more wire on the secondary.—95

AN EASILY MADE MAGNETO MACHINE FOR PHYSIOLOGICAL EFFECTS

As one of the diversions of an evening's entertainment for a company of young folk there is perhaps nothing that will contribute so much to the general enlivenment as some means of

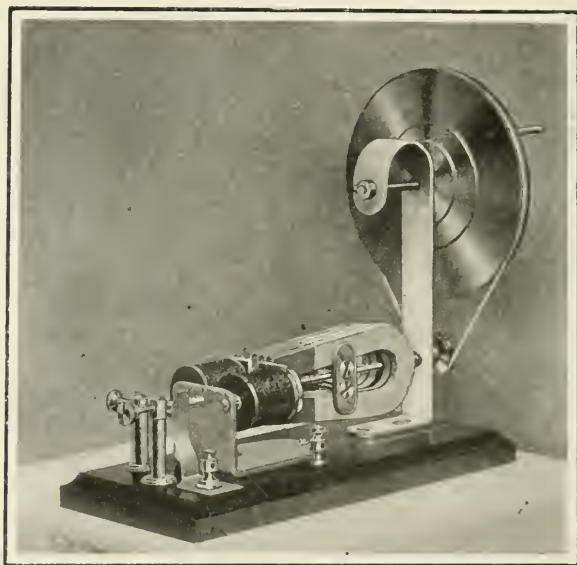

Fig. 209—A magneto machine of simple construction

giving electric shocks. Of the various devices for producing shocks nothing is more convenient and satisfactory than the magneto machine.

A simple magneto-machine of novel construction designed especially for physiological effects is here described. Fig. 209 shows the completed machine. Fig. 210 gives details of construction.

Four ordinary 5-inch horseshoe magnets, *d*, are clamped in a bundle with their like poles in contact upon a horizontal brass shaft, *a*, $3\frac{1}{16}$ of an inch in diameter. The magnets are held, two on each side of the shaft, by clamping plates, *b*, of thick sheet brass, drawn together against the faces of the magnets by small brass machine screws.

At their butts the pairs of magnets bind directly upon the shaft; at their open ends they clamp upon a rectangular strip of No. 22 sheet brass, *c*, half an inch wide, soldered transversely upon the shaft near the ends of the magnets.

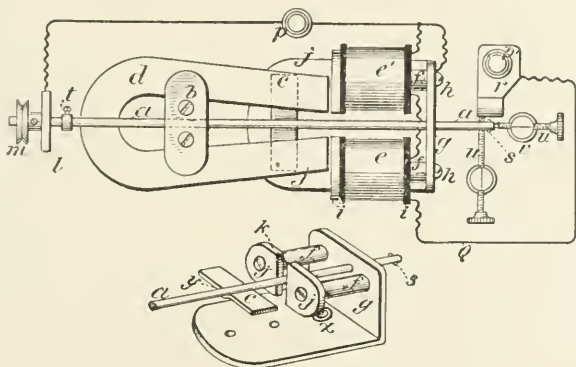

Fig. 210—Details of the construction

At its middle the brass strip has bent into it a shallow cross-groove, *y*, conforming to the shape of the shaft, the depth of the groove being just sufficient to bring the plane of the wings of the cross-piece coincident with the shaft's axis.

In front of the magnet's poles are fixed, horizontally, two bobbins of fine insulated wire, *e e'*. The bobbins have $\frac{3}{8}$ -inch soft iron cores, *f*, $1\frac{1}{2}$ inches long, attached by small machine screws, *h*, to the vertical limb of an iron yoke, *g*, made of $2 \times \frac{1}{8}$ -inch strap iron bent at right angles and attached to the base of the instrument with wood screws.

The bobbins are formed by driving tightly upon the cores centrally apertured disks, *i*, of vulcanized fiber or hardwood $\frac{1}{8}$ inch thick and $1\frac{1}{4}$ inches diameter. The space between the bobbin heads for each coil should be $1\frac{1}{8}$ inches. An insulating wrapping of paper is shellacked upon the cores between the heads and fitted tightly up against them. The spools are wound full of No. 36 single-wound silk-covered copper wire, $2\frac{3}{4}$ ounces being required for each spool. The windings of the two bobbins are joined together like the windings of an electro-magnet.

The ends of the bobbin cores are provided with flat pole-pieces, *j*, made of $\frac{1}{8}$ -inch strap iron, attached to the cores with flat-headed machine screws. The pole-pieces are rounded at their outer ends to conform to the shape of the bobbin heads, whose diameter they equal in width, their inner ends being left straight with a vertical space, *k*, between them whose width equals that of the opening between the poles of the magnets. The bobbins should be placed only just far enough apart to admit the free passage of the shaft between them. One end of the magnet shaft is journaled in the bobbin yoke, and projects 1 inch beyond it. The opposite end turns in a support, *l*, made of $1\frac{1}{4}$ by $\frac{1}{8}$ -inch strap iron carrying at its upper end a grooved hand-wheel 6 inches in diameter, which is belted with a waxed cord onto a $\frac{7}{8}$ -inch grooved pulley, *m*, carried by the shaft.

The magnets should revolve as closely as possible to the pole pieces, much of the effectiveness of the machine depending upon the nearness of approach at this point; therefore, the pole pieces are dressed perfectly flat and level and set so as to face the magnets squarely. Should the magnets differ slightly in length they should be clamped together and all ground to uniform length.

The coils are in permanent electrical contact with the magnet shaft through its bearings, by way of the connection uniting the bobbin yoke and hand-wheel standard, and carrying the binding post, *p*. The terminal, *Q*, connects with a vertical sheet brass spring, *r*, $\frac{1}{2}$ an inch wide, bearing against the side of the projecting end of *a*, and carrying the binding post *p'*. All these

connections are made underneath the base, the terminals passing through an insulation lined hole, x , in the bobbin yoke.

For varying the strength of all currents given by the machine the magnet shaft has an end play of about $5/16$ of an inch to allow of changing the distance of the magnets from the bobbin, this movement being limited by a set-collar, t , and regulated by an adjusting screw, u , held by a split metallic post, τ , the screw bearing against the end of a . A similar screw, u , passing below a serves to hold the spring, r , permanently out of contact with a when desired.

With the spring held away from the shaft, the ordinary coil currents traverse the wires to the posts p and p' , yielding pleasant effects of moderate intensity.

With the spring in contact with the shaft a short circuit is formed through g, l, a, r, Q , whose interruption at proper moments causes the powerful shocks of the self-induced or "extra" currents. The short circuit is broken twice during a revolution of the magnets at the instant when the coil current attains its maximum, which is just as the magnets reach a horizontal position before the coils. The breaks are effected by the pressing of the spring away from a by the projecting ends of a small plug, s , of hard wood driven tightly into a $1/16$ -inch hole drilled through the shaft $1/8$ of an inch from its end in a plane parallel with the cross-piece, c , the ends of the plug being filed away until they project barely above the shaft's surface.

The facility with which sinusoidal electrical impulses of slow period can be produced with this machine renders possible certain curious physiological effects not obtainable with induction coils, one or two of which effects will be mentioned. The best results are obtained with sponge hand-electrodes wet with salt water. Set the machine for the sinusoidal current with r and a out of contact. Place the sponges upon the closed eyes and revolve the magnets very slowly. A bright globe or aureole of violet light will alternate before the vision from one eye to the other as the current changes polarity.

Press the electrodes firmly against the head directly behind

the upper parts of the ears, and turn slowly. The experimenter's room, with its whole contents, will seem to rock and tip in a most pronounced and riotous fashion.

Place the electrodes upon the temples, well forward, and move them about slightly until the exactly proper spot is found, and the eyes will be violently winked alternately in a vigorous manner. By holding one of the electrodes in the hand and exploring the face with the other, nerve centers can be found whose stimulation will cause various other amusing facial contortions; thus, reckless twitching of the mouth and chin, dog-like wrinklings of the nose, etc., may be effected. These experiments are perfectly harmless and need not be feared. When not in use the magnets should be protected by broad flat armatures of strap iron laid upon the sides of the bundle near the poles.—24

MACHINE FOR WINDING COILS

A simple and inexpensive machine can be made as follows for winding No. 38 bare copper wire for making induction coils that give sparks up to 2 inches, without the use of a lathe: Make four pulleys of wood 4 inches in diameter by $\frac{1}{2}$ inch thick, and cut a groove in each pulley for a string belt. Fasten two of the pulleys on one end of a round piece of wood *A*, about 1 inch in diameter. Space the pulleys 1 inch apart. On the other end fasten a crank. Mount the round piece of wood in a couple of standards, so that it can be revolved by the crank. Put two small pins in the outside pulley *B*, to project from the face of the wheel about $\frac{1}{4}$ inch. This will act as a face plate to hold the coil. Drill two holes $\frac{1}{4}$ inch deep in one end of the coil, to slip on the two small pins, so that the coil will revolve when the crank is rotated. The rear end of the coil is held by a screw *C*, in the same way as it would be held in a lathe. The feed screw *D* is 14 inches long by $\frac{3}{8}$ of an inch in diameter, and has 16 threads per inch cut for a length of 12 inches. In the middle of the unthreaded 2-inch space a piece of wood *E*, 1 inch thick, is fastened, with a screw that runs through the wood and iron. At one end of the piece of wood a clutch is arranged to slide either

way. Two of the 4-inch pulleys have a number of holes around the outside. A pulley is placed on each side of the clutch on the feed screw. The clutch will engage the holes in the outside of

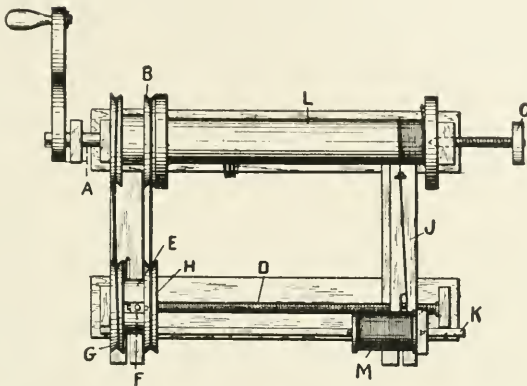

Fig. 211—Details of the coil winder

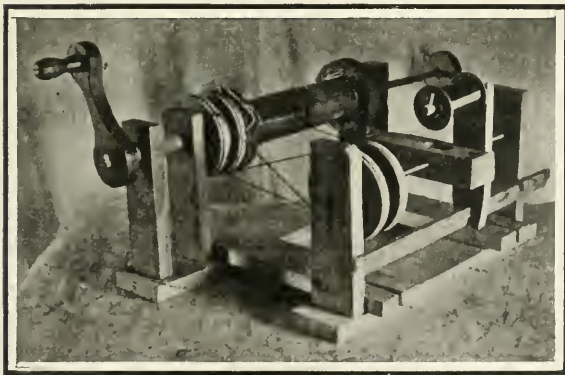

Fig. 212—General view of the coil winding machine

one of the pulleys. By moving the clutch, one pulley will be engaged and the other released. One pair of pulleys is connected by a straight belt, the other by a crossed belt. It will be

seen that the feed screw will carry the wire to one end of the coil. When the clutch is thrown, it will engage the holes in the other wheel, changing the direction of rotation of the feed screw, and the wire spool will be moved to the other end of the coil.

The wire will wind true, and the coils will have the same pitch as the feed screw. Two slots are cut in the cross pieces of the frame for two small bolts to be used for tightening the belts. The two string belts are placed entirely around each wheel, to prevent slipping.—45

STORAGE BATTERY WITHOUT CHEMICALS

An experimental storage battery, having qualities of interest, and at least remotely suggestive of commercial possibilities, may be constructed at a cost of a few cents, as follows:

Provide four strips *A*, *B*, *C*, *D*, of thin cloth (calico will answer), the strip *A* being 20 feet long and 4 inches wide, the strip *B* 18 feet long and 3 inches wide, the strip *C* 10 feet long and 4 inches wide, and the one designated as *D* 9 feet long and 3 inches wide. Procure an ordinary battery jar, *E*, of cylindrical form, a pound of commercial flake graphite, a few gum bands, and two pieces of No. 30 bare copper wire, one (*G*) being 20, and the other (*H*) 10 feet in length. These parts and materials, together with a carbon rod *F* of the kind used for arc lighting, comprise everything needed except water and enterprise.

Spread out the strips *B* and *D*, shower them liberally with water, and dust the graphite upon them. Then stroke them off with the hand. This will remove all excess of graphite, and leave them shining like strips of new tin plate. A single coating of the graphite upon one face of the cloth is sufficient.

Spread out the strip *A*, which remains uncoated, and lay the strip *B* centrally upon it, so as to leave exposed all margins of the strip *A*, its ends extending equally and in opposite directions beyond the ends of the strip *B*. Extend the wire *G* along the strip *B* from one of its corners to the opposite corner, the wire thus being slightly oblique relatively to the strip, and extending a couple of feet beyond one corner. Next place in position the

strip *C*, which remains uncoated, centering it lengthwise in relation of the other strips, and bringing its longer edges flush with those of the strip *A*. Place the strip *D* on the strip *C*, leaving all margins equally matched. Stretch the wire *H* along the strip *D*, from one corner to the corner opposite, the wire being slightly oblique to the strip, so as to cross the wire *G* and leaving a foot of the wire *H* projecting.

Wind the projecting end (2 feet long) of the wire *G* tightly around the carbon rod *F*, and lay the rod squarely across the adjacent end of the strip *B*, so as to make good contact with the graphite. This will leave a foot of the strip *A* extending from

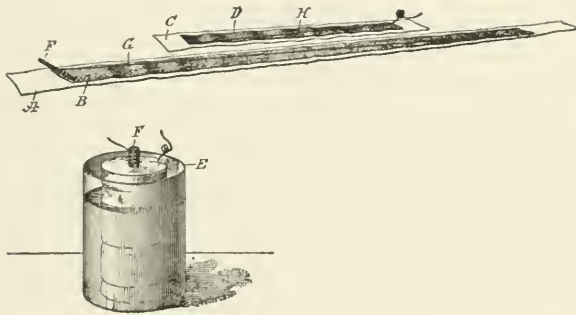

Fig. 213—Storage battery without chemicals

the rod *F*. Bend this extending portion back over the rod so as to cover it, and then, using the rod *F* as a spool, roll it along, pressing it down hard; and thus wind tightly upon it all of the strips and both of the wires, so as to form a hard roll having generally the appearance of a solid white cylinder. Stretch two or three rubber bands around the roll, so as to hold all of its parts rigidly in position. Find the projecting end of the wire *H*, and leave it exposed. Set the roll into the jar, so that the exposed portion of the wire *H* and also a portion of the carbon rod *F* extend upwardly. Now fill the jar with water, preferably submerging the roll to within half an inch of its top.

This completes the battery. In some instances it may be im-

proved by making the strips *AC* of cloth thicker than above designated.

The battery may be charged from an ordinary dry cell, by connecting the zinc shell of the dry cell with the carbon rod of the storage battery, and the carbon of the dry cell with the protruding wire of the storage battery. After being thus charged for fifteen or twenty minutes, the storage battery may be disconnected, after which it will yield, for a few minutes at least, a current not differing greatly from that with which it was charged, and adequate to operate a telegraphic sounder or an electric bell. If the energy of the battery be conserved by leaving the circuit open, the charge may last for several days. Like other storage batteries, this one, after being partially exhausted, will recuperate to some extent if the circuit be left open, though of course the total energy it gives out can never exceed that with which it is charged.

This device is in every sense a true "gas" battery as well as a storage battery. While it is being charged, the current sent through it disintegrates a portion of the water into its two component gases. The hydrogen, being disengaged throughout the entire length and breadth of the graphite coating carried by the strip *B*, is simply absorbed or occluded within the pores of the cloth, and thus effectively held as a free gas in a state of captivity. The oxygen, being in part in its allotropic form of ozone, is similarly collected and held in the strip *C*. The strip *A*, holding the hydrogen, being twice as long as the strip *C* holding the oxygen, is adapted to hold twice as much gas, thus compensating for the difference in volume between the hydrogen and oxygen. Both gases, being freshly liberated, are in their nascent state and eager to recombine. After the charging is completed, therefore, and a conducting path is established from one of the coated strips to the other, the gases recombine, forming water, and in so doing they generate an electric current flowing in a direction opposite to that of the current previously used for breaking up the water and forming the gases.

It is a fact not generally known that if a quantity of hydrogen

and a quantity of oxygen be subjected as nearly as practicable to the same physical conditions, they will present relatively to each other a difference of potential of about a volt and a half.—34

HANDY FORM OF VOLTAIC BATTERY

The battery shown in Fig. 214 is contained in a vulcanite case, closed at the two ends by screw caps. The battery proper consists of alternate layers of zinc and carbon, with the alternate pairs of layers separated by a layer of wool or other absorbent material soaked in a solution of sal ammoniac. The advantages claimed for this construction are compactness, and all the advantages of a dry cell with rechargeableness of a wet cell, thus greatly lessening the cost of up-keep. The voltage and amperage can be regulated by the size (diameter) and number of disks used.—9

HOW TO MAKE A SIMPLE DRY BATTERY

Often the experimenter is in need of a good dry battery of a certain size or shape for some particular work, where the ordinary standard sized cell is either too large or not of the right shape for the same work. An inexpensive dry cell that will produce results, and can be made by anybody capable of handling a soldering iron,

has long been the desire of every experimenter. The cell as described herein has been used for many purposes and with marvelous results by the writer, and has been used in other shapes where economy in space was desired, such, for instance, as in wireless telegraphy.

To make a cell of the standard size, a strip of zinc of medium thickness, $8\frac{1}{4}$ inches long and 6 inches wide, is necessary. The

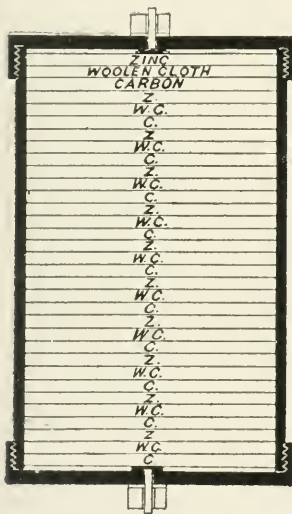

Fig. 214—Sectional view of the voltaic battery

zinc is rolled into a cylinder 6 inches long and 8 inches in circumference, thus leaving a quarter of an inch which is to be tightly soldered. A zinc cap is next soldered on one end of the cylinder. Any solder showing on the inside is to be well shellacked. Do not shellac any zinc surface, as that will interfere with the action of the battery. Line the inside of the cylinder with a thin layer of blotting paper. For the positive pole of the battery the carbon from a wornout cell is the best if procurable, but if not, a bundle of arc light carbons with the copper surface well filed off is the next best. The chemicals for producing the action that generates the electricity are, $\frac{1}{4}$ pound of sal ammoniac, $\frac{1}{4}$ pound of chloride of zinc (paste form), $\frac{1}{4}$ pound oxide of zinc, and $\frac{1}{4}$ pound plaster of Paris. These salts should be thoroughly mixed with a mortar, and packed tightly in the cylinder about the carbon, which is a half inch from the bottom of the cell. This paste will fill the cylinder to within half an inch of the top, the rest being filled with paraffine. A copper terminal soldered to the zinc and a heavy copper wire scraped clean and bound about the protruding end of the carbon, form the negative and positive connections for the cell.

This cell can be easily formed in various other shapes to suit the experimenter's fancy. The cell herein described, if constructed according to specifications, will produce very satisfactory results, especially in ignition work or for wireless telegraphy. It will register about $1\frac{2}{5}$ volts and between 10 and 15 amperes.

—100

RESTORING A DRY BATTERY

The best possible manner by which to restore partially the strength of a dry battery is to proceed as follows: Bore several small holes with a $\frac{1}{4}$ -inch bit around the carbon of a battery, to within an inch of the bottom. Fill these holes to within $\frac{1}{2}$ inch of the top with water, and the remaining $\frac{1}{2}$ inch with paraffine, or better still, sealing wax. The writer has taken a cell that was in such a worn-out state as to barely "flicker" a tangent galvanometer, and subjected it to this process, after which it read and easily maintained five amperes.

A battery can be made by filling a crock with a saturated solution of the chemicals of a dry cell with water. Bundles of carbon and zinc are placed on this solution for the + and - poles. This battery is especially adapted for closed-circuit work.—100

A HOME-BUILT ALTERNATING-CURRENT MOTOR

A small motor can be constructed by any one having ordinary skill in the use of tools, and having access to a screw-cutting lathe with a swing of nine inches or more, by following the instructions given here.

The motor is of the type known as a "creeping field" induction motor, and is designed to run on a 100- to 120-volt, 60-cycle, single-phase alternating-current circuit, such as is now in wide-spread use for the lighting of dwellings. Being a four-pole motor, it will run at a speed of something like 1,600 revolutions per minute, and will, if well made, deliver about $\frac{1}{8}$ horse-power. This is sufficient to drive either a 16-inch brass fan, a small lathe, a 50-watt dynamo for generating direct current for charging storage batteries, or, in fact, almost any kind of work that can be done by one-man power. It should be noted, however, that a creeping field motor is adapted to run in one direction only; so that when set up for driving a screw-cutting lathe the motor should be belted to a light countershaft having two belts, as is done when steam power is used. For most other cases where reversing has to be done it is sufficient to merely turn the motor around and put the pulley on the other end of its shaft.

A small alternating-current motor is much easier to build than a direct-current motor, for the reason that the armature, or "rotor" as it is called in an A.C. machine, requires no such delicate parts as insulated wire coils, commutator, and brush-rigging. The field magnet, or "stator," offsets much of this advantage, however, as it is impossible to use an iron or steel casting for this part, since the entire magnetic circuit must be built up of thin plates of sheet steel. If a solid casting were used the alternating current would set up wasteful or eddy currents within it, and the motor would be burned up by the energy thus converted into

heat. In factories where small motors of this kind are made, the thin sheets for the stator and rotor are punched out by machines built for the purpose. For the amateur, however, the only successful way in which so many irregular-shaped pieces of metal can be made all alike is to first bolt the required number of steel sheets on the face-plate of a lathe, and then bore out the inside and turn off the outside to the required dimensions. This

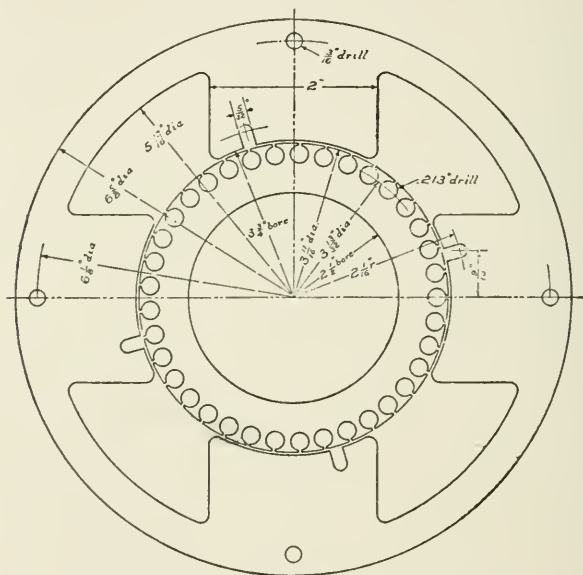

Fig. 215—Details of stator and rotor core plates

will leave a heavy ring made up of the sheets, on the inside of which, in the case of the stator, the four pole-pieces can be readily formed by drilling and sawing away. When finally completed, the stator and rotor core plates should have the form and dimensions as shown in Fig. 215.

For the stator core about 25 pounds of thin sheet steel are required, cut 7 inches square. This is sold at hardware stores under the somewhat misleading trade names of "Russia iron."

"sheet" or "stovepipe iron," and "roofing tin." The most desirable thickness is about $15/1,000$ or $1/64$ of an inch, but anything thicker than $25/1,000$ will answer the purpose. If roofing tin is selected, the cheaper grades are the most desirable, and better if somewhat rusty. When tightly compressed, the bundle of sheets should measure $1\frac{7}{8}$ inches in thickness or a trifle over.

If the lathe is large enough to swing a piece 11 inches in diameter, the bundle of sheets may be mounted on the face-plate without further trimming; but if a 9- or 10-inch lathe is used, then an inch or so must be clipped from the four corners of each of the sheets. The ease with which the work of boring and turning can be done depends very much on how firmly the sheets are bolted to the face-plate; and if the following method is adopted, the mass will behave almost as if it were a solid block.

Procure about ten pieces of stiff, hard wrapping paper, and two flat pieces of sheet brass not less than $\frac{1}{8}$ inch thick, all of them being the same size as the steel plates. Lay the face-plate on the bench, face up, and pile on it first the paper, second one of the brass plates, third the bundle of steel sheets, and finally the remaining brass. Straighten up the pile as neatly as possible, and have the centers of all the pieces coincide as nearly as may be with the center of the face-plate. The whole must be firmly clamped together by means of four wood or metal clamps, to hold the mass while it is being drilled for the four bolts that are to hold it on the face-plate while it is being bored and turned. To mark off the places for these four bolts, first find the true center of the upper brass plate by measuring from the periphery of the face-plate with a pair of dividers or with a rule and square. From this center strike a circle of $2\frac{5}{16}$ inches radius on the brass. When this circle is divided into four equal parts, the points so found will be at the corners of a square which will measure a trifle over $3\frac{1}{4}$ inches on a side. The bolt holes are drilled through these corners, so that the whole mass may be bolted together with machine bolts not less than $\frac{3}{8}$ inch in diameter. (See Fig. 216.) At least two of the bolts may be made to pass through the radial slots in the face-plate, but if the latter

is provided with *six* such slots it will, of course, be necessary to bore right through the plate in making the other holes. As soon as each hole is drilled put in the bolt for which it was made from the front side, and tighten up the nut. When all have been tightly

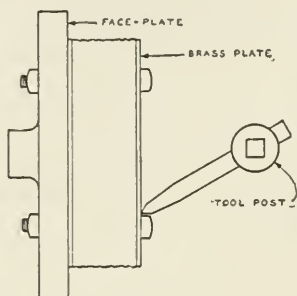

Fig. 216

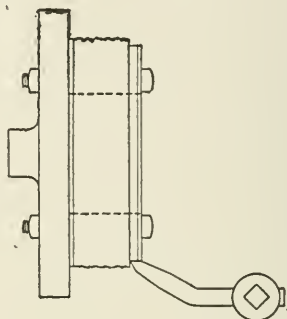

Fig. 217

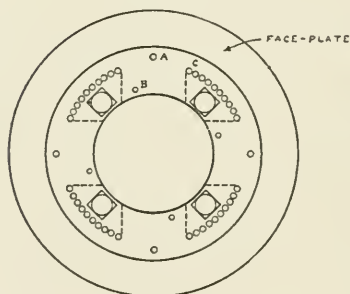

Fig. 218

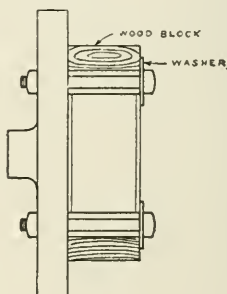

Fig. 219

Figs. 216-219—Details of face-plate work

set up, the clamps may be removed and the face-plate will be ready to be screwed on the lathe spindle.

"Make haste slowly" is one of the secrets of success in working a pile of laminae in a lathe. Put in the back gears and run the belt on the largest of the cone pulleys, keeping the speed of the work down to thirty revolutions per minute or even less. An ordinary V-shaped threading tool, as shown in Figs. 216 and 217,

is one of the best to use. Feed the tool slowly by hand. As each successive plate becomes nearly cut through the tool will catch in the ragged edge and the entire piece to be removed will be quickly torn out. When the bulk of the metal has been thus cut away, the pieces may be bored and turned to the exact dimensions with ordinary tools and slow power feed. Make the bore $3\frac{3}{4}$ inches in diameter, and the outside $6\frac{5}{8}$ inches.

Before unscrewing the face-plate from the lathe, take a light cut off the face of the brass plate so as to make the part of it lying outside of the bolt heads perfectly true. By placing a sharp pointed tool in the carriage it will then be easy to mark off two circles on the brass, the one being $6\frac{1}{8}$ inches in diameter and the other $5\frac{5}{8}$ inches. These circles will form accurate guides for laying out the permanent bolt holes and the pole pieces, in accordance with the drawing in Fig. 215.

Divide the outer circle into four equal parts, choosing points midway between the bolt heads. If this is done, the removal of the metal between the pole pieces will take away also the old bolt holes, which form no part of the finished core plates. Mark out the outline of the pole pieces on the surface of the brass, and drill all necessary holes before removing the laminæ from the face-plate. As shown in Fig. 218 there are to be four $3/16$ -inch holes, *A*, for the permanent bolts, four $5/32$ -inch holes, *B*, to form the bottoms of the slots in the pole faces, and four circular arcs, *C*, made by drilling $3/16$ -inch holes as closely together as can be done without danger of the drill breaking through from one hole to the next. These last holes will have their centers all on the circle $5\frac{5}{8}$ inches previously marked on the brass. It is to be noted that the four holes, *A*, must pass entirely through the second brass plate, but the others need be only deep enough to pass through the steel plates.

When all the holes are drilled, the laminæ will be ready for removal from the face-plate. This can be best done by taking out at first only three of the bolts, after which the bundle of plates may be swung around on the fourth, to permit of the insertion of some of the $3/16$ -inch bolts. This prevents the

springing apart of the plates and avoids the danger of a mix-up. The laminæ, now tightly clamped between the brass plates, must next be held in a vise while the eight cuts indicated in Fig. 4 by dotted lines and the four small slots in the pole faces are made with a hacksaw. The pieces containing the original large bolt holes can then be easily removed, thus leaving the stator plates finished except for roughness, which must be carefully removed with a file. Finally the brass plates may be removed and thrown aside. The operations in the lathe have made a very intimate contact between successive laminæ, so that as far as being an electrical conductor is concerned the stator might now almost as well have been cut out of a solid block. It is very well worth while, therefore, to take apart the laminæ, remove the burrs from each one separately with a fine file, wash them in a pan of benzine to remove oil and loose filings, and finally to give each plate a coat of very thin shellac on one side only before reassembling. It is quite important that the plates be not mixed up during these cleaning operations, as the inevitable irregularities in the form of the different poles and in the location of the bolt holes makes it impossible to reassemble the plates in any other than their proper positions. To avoid this mixing pass a stout string about four feet long through one of the bolt holes and tie a big knot at each end. The plates may then be handled separately, and then be finally put back as they were at first. The finished core must be exactly $1\frac{7}{8}$ inches thick.

The work of making the rotor core plates is much easier than that of the stator, so only a brief description is necessary.

The material required is about $8\frac{1}{2}$ pounds of sheet steel (similar to that used in the stator) cut 4 inches square, and two copper plates of the same size and $\frac{1}{8}$ inch thick. These copper plates are not used merely to make the work of clamping and turning easy, as in the case of the stator, but are to be left at each end of the finished core. If suitable copper plates cannot be obtained, some $\frac{1}{8}$ -inch brass may be substituted. Protect the face-plate with sheets of paper, as before, and bolt on the metal plates with four $\frac{3}{8}$ -inch bolts. Strike a circle 2 inches in diameter on the

upper copper plate, and divide this into four equal parts to find the place for the bolts. On large lathes the hub of the face-plate will be in the way. In this case screw the bolts into tapped holes made for them either in the face-plate itself or in a heavy, flat metal plate bolted on it.

When the material has been fastened, turn off the outside smoothly to a diameter of $3 \frac{11}{16}$ inches. Mark off on the top copper plate a circle having a diameter of $3 \frac{13}{32}$ inches and divide up this circle accurately into 37 equal parts, and mark the points so found with a center punch. The correct spacing can be found only by repeatedly "stepping off" around the circle with a pair of dividers, trying different distances between their points until it comes out just right.

It may appear at first sight as if 37 were an unnecessarily difficult number of holes to space off, and that 36 might just as well be substituted, but this is not true. It has been found by experiment that the number of slots should be an odd one. One of the reasons for this will be self-evident if one considers what would happen if the rotor were provided with only *four* such slots, of somewhat larger size, or, to go to an extreme, if an iron cross were to be substituted for the rotor. When the arms of this cross came opposite the four polar projections of the stator they would be very firmly gripped by the magnetic flux, and it would take considerable force to twist the cross out of the magnetic path. After being twisted far enough, however, to become released from the attraction of the poles, the cross would move forward with a jerk to the next favorable position. In a four-pole motor, then, the rotor must not have a number of slots divisible by four, or it will, to a less extent, be found to turn with little jerks that result in vibration and noise when the motor is running, in addition to interfering with its starting.

Drill the 37 holes for the slots with a No. 3 drill, which is 0.213 of an inch in diameter, and make sure that they are deep enough to pass clear through the second copper plate. After the holes are finished it will be necessary to clamp the laminae to the face-plate so that the four bolts in the middle may be removed to per-

mit of the inside being bored out. One way to do the clamping is to pass six or eight $\frac{3}{16}$ -inch bolts through as many of the 37 slot holes, but the method shown in Fig. 219 is better. Four $\frac{3}{8}$ -inch bolts applied as shown will grip the laminæ quite firmly. Bore out the inside smoothly to a diameter of $2\frac{1}{2}$ inches, and before removing the laminæ from the face-plate fit three or four wood sticks in the small holes to keep the bundle of laminæ from falling apart. The final operation is to put the plates in a vise and with a thin hacksaw cut through the little bridge of metal that separates each of the 37 holes from the outside, when the plates will appear as in Fig. 215. The saw-cuts ought not to be more than $\frac{1}{32}$ inch wide. If the saw cuts wider than this, it is well to grind off some of the "set" by holding the blade flat against a grindstone.

Clean and shellac the rotor core plates as was done with those of the stator, and guard against mixing them. Before separating the plates file a well-defined groove inside the central hole, so as to make a slight notch in each plate to serve as a mark, and then pass a stout string through the hole and tie the ends together.

In Fig. 220 are shown details of the rotor shaft, spider, and "winding." The material required for the shaft is a piece of cold-rolled steel $\frac{9}{16}$ inch in diameter and 7 inches long. This should be held in the lathe chuck while truing up each of the ends and drilling the centers in them, after which it may be supported between the lathe centers and finished all over. Make the central portion $\frac{1}{2}$ inch in diameter and $2\frac{1}{4}$ inches long, and the bearing portions $\frac{7}{16}$ inch in diameter. The latter, after being turned and filed as smoothly as possible, should be given a polish with a piece of very fine emery paper wet with machine oil.

The best material for the spider is a brass casting, for which it is not difficult to make a wood pattern by turning off a piece of white pine in the lathe. A very good substitute for the brass, however, can be made of Babbitt metal, or of ordinary plumbers' solder, which can be cast at home in a sand or plaster of Paris mold, or even in a wooden one. The rough spider casting should be drilled with a $\frac{31}{64}$ -inch drill, reamed to $\frac{1}{2}$ inch to fit the

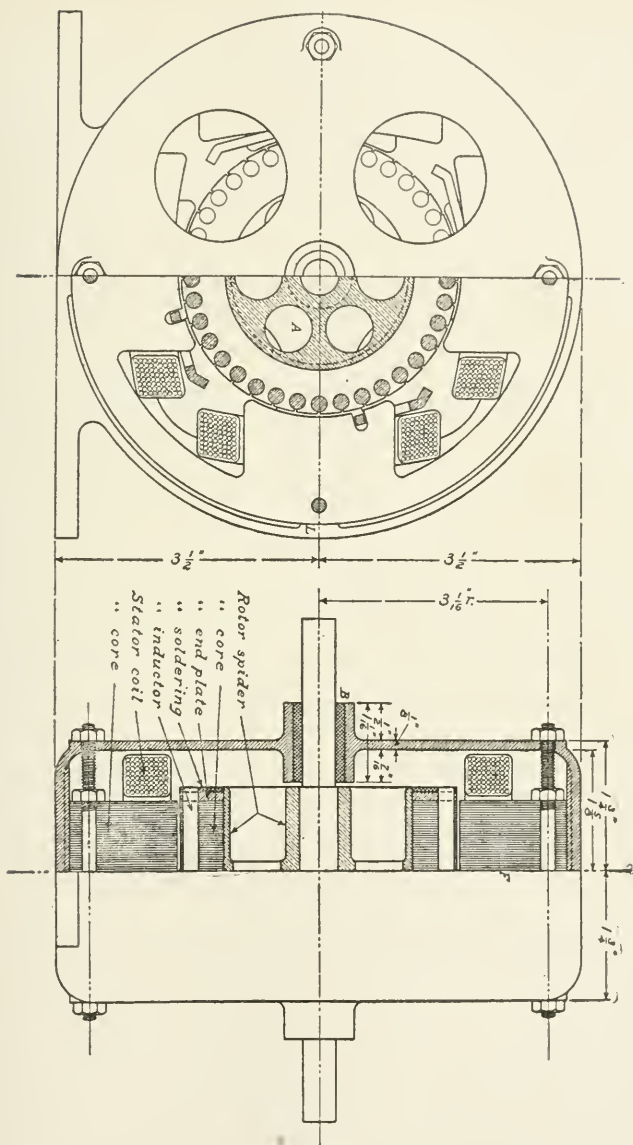

Fig. 220—Details of complete motor

shaft, and secured to the latter by pinning with a small steel pin. If one of the suggested methods of making the casting at home be adopted, there is no reason why the spider may not be cast right on the shaft itself, thereby saving the trouble of fitting it to the latter afterward. The cylindrical surface of the spider must be turned in the lathe to a length of $2\frac{1}{4}$ inches and a diameter of $2\frac{1}{2}$ inches, or rather, to such a diameter as will permit of the rotor plates being put on easily without being loose enough to shake. On the inside the spider should be finished all over, to make it as light as possible and to keep it balanced. The rim needs to be about $\frac{3}{32}$ inch thick, and the arms and the hub about $\frac{3}{16}$ inch thick. The six holes shown at *A* in Fig. 220 are not merely for ornament, but are to allow of air passing through the machine for ventilation.

Assemble the rotor core plates on the spider with one of the copper or brass plates at each end. Use only enough of the steel plates to make a length of $1\frac{7}{8}$ inches, which will make the length when the end plates are in place just $2\frac{1}{8}$ inches long, and leave about $\frac{1}{16}$ inch of the spider projecting at each end. For the "inductors" to go in the slots, procure $7\frac{1}{2}$ feet of No. 4 copper wire, which is 0.20431 inch in diameter, and after straightening it out saw off thirty-seven pieces each $2\frac{1}{4}$ inches long. Clean these carefully by scraping each of the ends for about $\frac{1}{4}$ inch with a knife. The middle portions may be left as they are, but if the best results are desired, it is worth while to glue on a wrapping of thin paper to insulate the inductors from too much contact inside the slots. Insert the wires in the slots and rivet all the projecting ends by tapping lightly with a hammer until each one is expanded enough to prevent its dropping out. The inductors are next to be soldered to the end plates, to make good electrical contact all around. To do this, stand the rotor up on end, and apply some good quality soldering salts or paste to the riveted heads, end plates, and spider. Use a *hot* soldering copper, and apply the solder very generously so as to bury all the rivet heads out of sight. When both ends have been thus treated, place in the lathe again and true up the soldered rings by turning off the

solder until the copper inductors begin to show. This will complete the rotor except for balancing. Take two smooth metal rods of any convenient size, and support them about 4 inches apart on the upper edges of an empty box, as if to form a miniature pair of parallel bars. Have them as nearly level as possible, and place the rotor shaft with one end on each bar. If the rotor is out of balance it will, of course, roll over and stop with the lighter side up. Make a mark at this place, and apply a little solder to the inside of the spider as near to the arms as possible. Increase or reduce the weight as required until the rotor will lie indifferently in any position in which it may be placed on the rods. This type of rotor is known as the "squirrel cage."

In Fig. 220 there are also shown some details of a suitable external casing for the motor. This is intended to hold the bearings and the stator plates in a fixed relation to each other, and at the same time to protect the delicate stator coils from accidental injury. It is to be cast in two halves exactly alike, so that both "shields" may be made from the same pattern. Brass castings are the easiest to finish in the lathe, but iron is much cheaper. In the selection of material, and in the arrangement of the details of the casing and bearings, the amateur is advised to use his own judgment and skill, provided that the following points are observed. The rotor must be supported in the exact center of the stator field, so that the air-gap under each of the four poles will be uniform, or $1/32$ inch all around. This desired result will be secured as a matter of course, if the seat for the bearing *B*, Fig. 220, the four internal lugs *L*, and the face *F* be all finished in the lathe at one chucking of the casting. The four bolts passing through the stator plates must be long enough to pass also through the end shields, to clamp the whole together as shown. The bearings may be of either brass or Babbitt metal, and the rotor shaft should turn freely in them without being loose enough to shake. Allow sufficient room between the two bearings so that the shaft has an "end play" of nearly $1/8$ inch, and provide oil cups of some kind to furnish plenty of lubrication. In the end shields there must be several holes to permit air to circulate

through the motor and help to keep it cool. If the lathe on which the shields are to be finished is not too small, it is a good plan to have suitable feet cast on them, so that the finished motor may be conveniently bolted fast in the place where it is to be used.

All parts of the motor have now been described, except the

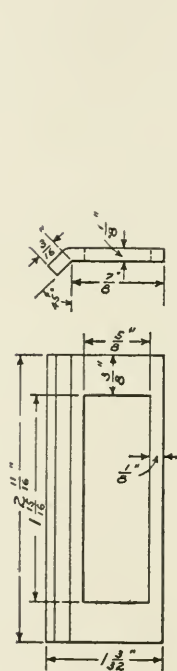

Fig. 221—Cotton damper

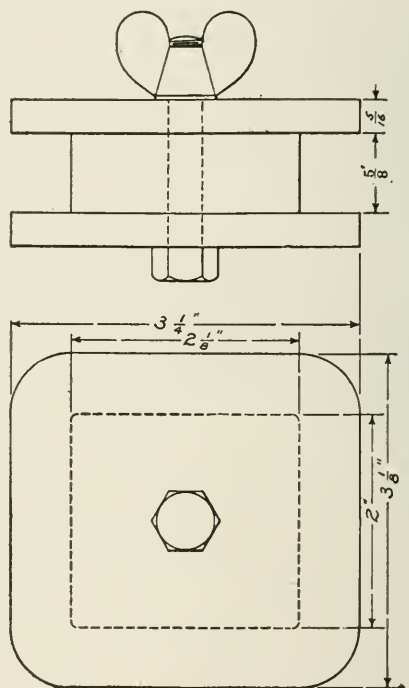

Fig. 222—Coil winding form

winding for the stator, which consists of four copper "dampers" and four coils of wire. The copper dampers are shown in detail in Fig. 221. Each one can be cut from a solid piece of copper sheet $\frac{1}{8}$ inch thick, or they may be built up of several thinner pieces having the same total thickness. If the latter method be

adopted, the small pieces should be soldered together after they are finished, so that they can be handled as single units.

Figs. 222 and 223 show the winding form for making the stator coils. This consists of three blocks of wood held together by a bolt and revolved in the lathe by gripping the bolt head in the

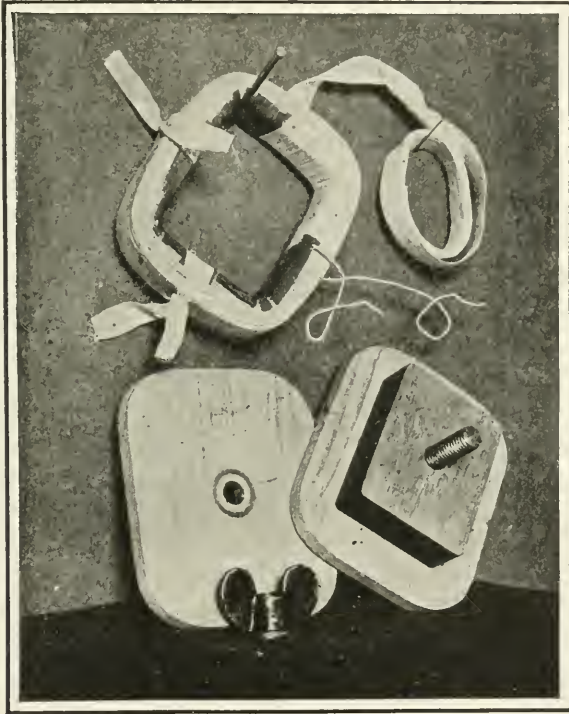

Fig.223—Coil winding form and partly taped coil

chuck. The central block, measuring $\frac{5}{8}$ by 2 by $2\frac{1}{8}$ inches, is best made of a piece of hard wood, such as maple or mahogany, and it must be quite accurate in each of its three dimensions, since these fix all of the dimensions of the coils. The four corners of the block must be very slightly rounded, to avoid the difficulty

of having to bend the first turns of wire around square corners. About two pounds of No. 21 single cotton-covered magnet wire is required for the four coils. Each coil is to have 165 turns, put on in close, even layers. The number of turns is so important that it is not well to trust to the mind to keep tally while winding. Set the gears to feed at some convenient rate, say ten threads per inch, and run the tool carriage to the extreme right-hand end of the bed and make a chalk mark on the bed at that position. Then, when the winding is started, throw in the screw feed, and the movement of the carriage to the left of the chalk mark will count the turns automatically, for when the carriage has traveled $16\frac{1}{2}$ inches, as measured by a foot rule, the spindle will have made the required number of turns. Before beginning the winding, it is necessary to provide means for holding the turns of the coil together so that the blocks may be afterward removed without any danger of the coil coming apart. For this purpose, nothing is better than four strips of cotton cloth about half an inch wide placed crosswise in the space where the wire is to be wound. These may be readily held in place by the first turn of wire, or, better still, by a strip of canvas or tough paper cut $\frac{3}{4}$ inch wide, wrapped once around the form, and glued to itself like a cigar band. Do not attempt to wind the coils by power, but turn the lathe head over a little at a time by hand, so that the wire can be laid on in closely-fitting, smooth layers. Start the winding near the middle of one of the longer ($2\frac{1}{8}$ -inch) sides, and have it end near the same place. It is well to paint the inner end, or terminal, black for the purpose of easy identification later on. After putting the required number of turns on a coil, tie the ends of each of the four pieces of cloth together and remove the blocks.

Fig. 223 shows the method of applying a final covering of tape for protection and insulation. Very thin cotton tape about $\frac{1}{2}$ inch wide is suitable, and it should be lapped on itself about half way in the winding, so that the coil is really protected by two layers. As the taping progresses, the temporary ties may be removed, but the inner band of canvas or tough paper is to be left

there as shown. Where the inner lead or terminal comes out across the other layers of wire a piece of paper about $\frac{1}{2}$ inch square should be slipped in to guard against possible short-circuits.

The final assembly is next in order. (See Fig. 224.) The

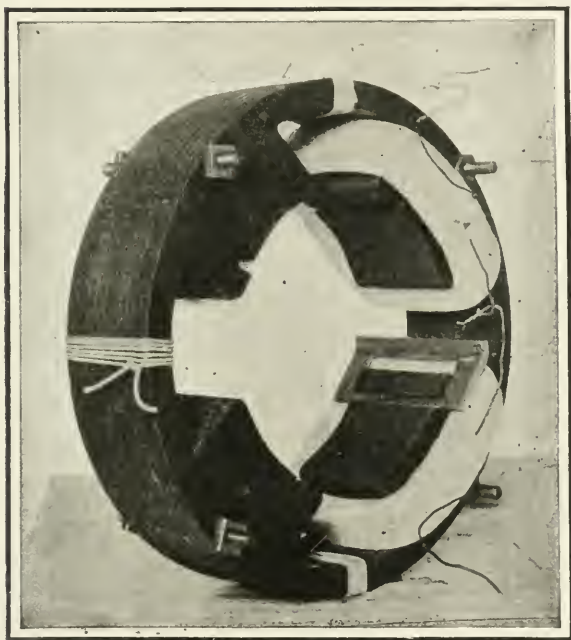

Fig. 224—Assembling the parts

stator plates, in addition to being held together by their four bolts, should be tied with string, as shown. The coils are to be placed on the poles all in the same position, i. e., all of the faces which were next to the lathe head during the winding must be turned either toward the rotor or away from it. Do not force the coils over sharp corners on the poles and run the risk of

cutting through the insulation. If the coils do not go on easily, file the corners of the poles round and smooth. The coils and the dampers, when once in place as shown, are most conveniently held in position by bending outward the first lamina on each side of the pole tips, which holds them on as if they were riveted there.

The four coils must be connected in series so as to make the poles alternately positive and negative. One way to do this is as follows: Beginning at any given point, connect the inner end of coil No. 1 to the inner end of coil No. 2. Next connect the outer end of coil No. 2 to the outer end of coil No. 3, and finally connect the inner end of No. 3 to the inner end of No. 4. This will leave free the outer ends of coils No. 1 and No. 4. If the coils are not wound all in the same direction, or are not assembled at all in the same position relative to their respective poles, or the inner and outer leads become confused, then the polarity of the poles will not come out right. To make sure on this point connect the two free ends of the winding to a battery of one or more cells, and present a pocket compass to each of the pole faces in succession. They must show alternately north and south all the way around. In case they do not, some mistake has been made, and this can be easily corrected by exchanging the connections of any coil that shows up wrong. When everything is right, it is worth while to solder the connections and cover them with tape for insulation. Do not apply alternating current to the coils unless the rotor is in its place, properly mounted in its bearings, and *left free to turn*. If this caution is not observed, the coils will be soon burned up, as their resistance alone is not sufficient to prevent their taking too much current from the line.

When assembling the stator in the casing, see that no part of the winding or its connections is pinched or grounded. If any connections lie against the frame, slide pieces of tape under them and glue them fast. Perfect insulation is much more necessary in alternating-current magnets than in direct-current. A short circuit between a few of the turns of a coil does no particular harm on direct current, but in the case of alternating current tre-

mendous currents are set up in the short-circuited turns and the entire coil is soon burned up.

The two leads or terminals to the winding may be attached to two pieces of rubber-covered flexible cable brought out through holes in the casing for the purpose of connecting to the alternating-current mains. A much neater way, however, is to attach two small binding posts to the casing, from which they can be insulated with fiber thimbles and washers. No pulley has been shown in the drawings, as the form and dimensions of this will depend on the particular kind of work the motor is expected to do. For ordinary service a pulley of about 2 inches in diameter by $1\frac{1}{8}$ inches face will probably give the most satisfaction.

No starting box is required for this type of motor. An ordinary socket plug and lamp cord is all that is needed. The rotor, on account of the unbalanced pull exerted by the four dampers on the poles, will start to revolve as soon as the current is turned on, unless it is stuck in its bearings or stalled by an overload.—95

SMALL TRANSFORMER FOR BELL CIRCUITS

It not infrequently occurs that where one has alternating current at 110 volts available, a lower voltage is required for some special purpose, as the operating of small lamps of low voltage, induction coils, etc. In theory it is a very easy matter to construct a small step-down transformer to reduce the voltage and increase the quantity, but in practice many difficulties arise. The windings together with the size and mass of iron in the core all have to be taken into consideration to obtain satisfactory results. The writer has recently had occasion to construct a transformer for the purpose of stepping down an alternating current of 110 volts and 60 cycles, to furnish a current to replace that from a series of four to six dry cells for operating a gong-striking device, the circuit of which is closed at intervals by a clock, and the current carried through an electro-magnet originally wound to a resistance of 4 ohms, this in turn attracting an iron armature with hammer, striking the gong. Because the batteries would run down rapidly, it was deemed of advantage to make use of

the lighting current already on the premises, in connection with the transformer referred to. As the primary windings were connected across the 110-volt mains at all times, and the secondary only closed at intervals, it was important that as little current as possible pass through the primary windings and register on the meter, when the secondary was open. A sufficient number of pieces of soft stovepipe iron were cut each $6\frac{1}{2}$ inches long and $1\frac{1}{4}$ inches wide, to make two piles, each $1\frac{1}{4}$ inches high; and a number of pieces 5 inches long and $1\frac{1}{4}$ inches wide were also cut to make two piles, each $1\frac{1}{4}$ inches high. These were well coated with shellac varnish, and then arranged as shown at *C* in Fig. 225, forming two right angles, the shorter pieces being placed between the longer pieces at one end in each case. The

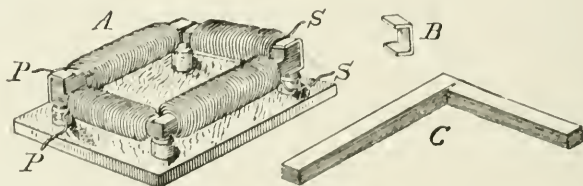

Fig. 225—Construction of the small transformer

corner of the pile in each case was then squeezed down in a vise, and the iron well wrapped with adhesive insulating tape, putting on several layers, but not covering the outer ends for a space of $1\frac{3}{8}$ inches. After releasing the vise, that portion at the angle was also covered with tape. The secondary coils were then put on, consisting of 100 feet of No. 16 double cotton magnet wire, on each of the angle pieces, or 200 feet altogether, and well coated with shellac, the windings being in such direction that when the two angle pieces were brought into contact at the exposed ends, they formed a continuous magnetic circuit. The windings were all in one direction. These secondary windings were then covered with two layers of cotton cloth, well coated with shellac varnish, and the primary windings were put on over the secondary, consisting of 650 feet of No. 28 double-covered cotton mag-

net wire on each side, or 1,130 feet altogether, wound in the same manner as the secondary, and coated with shellac varnish. The exposed corners of the two iron cores were then brought together, and clamped firmly, as shown, with iron clamps *B*, and then the whole was mounted horizontally on four large porcelain knobs screwed on a suitable wooden base. This served to insulate it, and allow for the passing off of any heat generated. It was held in place with strips of tape passing down around the knobs. The primary coils (the No. 28 wire) were now connected in series, the ending of the coil on the first side wound, being connected with the beginning of the winding on the last side wound, the ending of the last coil, and the beginning of the first being connected to the 110-volt, alternating circuit, being bridged across it, not cut in in series. The secondary windings were connected experimentally in two ways: first, in series, giving 200 feet from the terminal of the first winding to the commencement of the last winding; and afterward in parallel, the beginning of the first and second windings being twisted together, and the endings of the first and last windings, giving a length of 100 feet of wire, and a decrease of resistance due to the mass of copper. Both methods of connecting worked well, the series connecting giving 14 volts and about 5 amperes, and the parallel 7 volts and about 10 amperes. For the particular purpose for which this was constructed, it is giving excellent results, there being very little heating, even when the secondary is closed, and practically none when it is open.

It was found advisable to change the winding of the electro-magnet that strikes the gong, owing to the counter electro-motive force generated in it by the alternating current, and it was rewound with 60 feet of No. 17 double cotton magnet wire. Its cores were about $\frac{5}{8}$ inch in diameter, and $2\frac{1}{2}$ inches long. It is well to remember that in operating electro-magnets with the alternating current, a considerably higher voltage will have to be used than in the case of the direct current, owing to the choking effect due to counter electromotive force, and that the cores should be laminated. Where a current of higher voltage

is required, particularly if the transformer is only required to be connected with the lighting mains at intervals for operating large induction coils, or charging storage batteries through a rectifier, etc., it may be made in the same general form as the one just described, with the following changes: Make the pieces for the core 7 inches long and $1\frac{1}{2}$ inches wide, and 5 inches long and $1\frac{1}{2}$ inches wide, and of such quantity that they will make two piles in each case, of a height of 2 inches, and coat with shellac as before, and assemble, etc. Wind the secondary with 60 feet on each side, or 120 feet altogether, of No. 14 double cotton magnet wire well coated with shellac. Put on two layers of cloth well coated with shellac, and wind on the primary coils over the secondary, consisting of 150 feet on each side of No. 18 double cotton-covered magnet wire, or 300 feet on both sides, and coat well with shellac. Clamp the two sides together, as in the previous case, they being in this case 2 inches thick, and mount as in the previous case. Connect the primary windings in series, the terminal of the first winding to the beginning of the second winding, and the beginning of the first winding and the terminal of the second to wires leading to the 110-volt feed wires, to which they are connected as in the previous case. The secondary windings are connected in series, in the same manner as the primary, and a short tap is run out from the point where the two coils are connected together, the beginning of the first winding and the terminal of the last winding being connected to the circuit where the current is to be used. This transformer connected in this way will give a current of 40 volts and a maximum amperage of 10. By making connection with the beginning of the first winding and the tap between the two windings only, the voltage will be 20; and by connecting the two windings in parallel, the two beginning wires of the two windings being twisted together and the two terminal wires of the two windings being likewise twisted together, the current will be 20 volts, with a considerable increase in amperes as compared with the connection in series. It will be noted that the secondary winding is put on first, the primary being wound over it, the primary being con-

sidered as being the current of highest voltage coming from the mains to be stepped down, and the secondary being the winding producing the current of reduced voltage. An increase in the length of the secondary winding increases the voltage of the current produced, and a shortening of the secondary winding reduces the voltage; but if any very radical change is made in the winding, it may necessitate a change in the amount of iron in the core to get the best results. Pieces of fiber or wood may be shaped to fit, and slipped over the core to aid in holding the windings in place if desired, forming spools as it were. It is advantageous to extend the windings, as shown, on both sides of the angle, as thus the whole or nearly the whole of the magnetic flux is made to pass through or thread the coils; but in the case of the transformer last described, the amount of wire being less and being closer to the core, the windings may be on the two opposite sides only, the shorter sections of the core merely completing the magnetic circuit, and not being covered with wire. Both of these transformers are intended for use on a single-phase alternating current of 110 volts, and of a frequency of 60 cycles. The one first described, when the secondary is open, uses very little current, rather less than that required for a four-candle-power lamp. The normal primary current of the last-described transformer is 2 amperes with proper load.—99

AN ELECTROLYTIC RECTIFIER FOR CHARGING IGNITION BATTERIES .

It is well known that small storage batteries, such as are used for automobile ignition, are very easily charged by connecting them to a direct-current house-lighting circuit through a suitable resistance, but where the current supply is alternating many have supposed that good results cannot be obtained without the use of complicated and expensive apparatus for converting the alternating into direct current. By following out the instructions given below, however, an electrolytic rectifier suitable for charging a six-volt sixty-ampere-hour battery from 110 volts can be

made and used at home with small expense and satisfactory results.

There are two parts to the required apparatus—the autotransformer for reducing the voltage of the line from 110 to that required by the battery, and the electrolytic cell for rectifying the current or causing it to pass always in the same direction.

The autotransformer is shown by the drawings in Fig. 226. It consists of a single coil of magnet wire wound on a rectangular wooden spool, inside of which a bundle of steel strips is after-

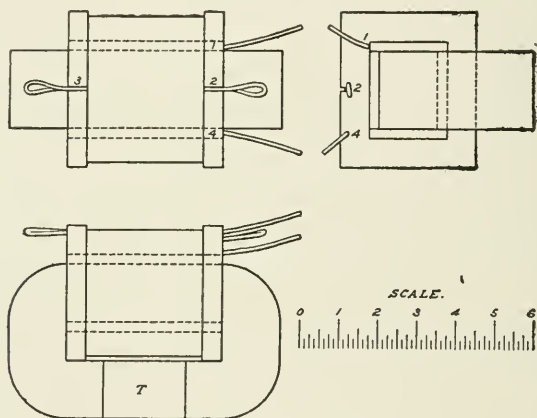

Fig. 226—The autotransformer

ward placed to form a core. The spool is best made of well-seasoned white pine or whitewood, as these soft woods are readily obtained and easy to work. It is a good plan to dry the wood thoroughly in an oven before it is cut up.

For the body of the spool, four pieces $2\frac{1}{16}$ inches wide, 4 inches long, and not thicker than $\frac{1}{4}$ inch are required. These should be securely glued and nailed together so as to form a rectangular tube 4 inches long and measuring $1\frac{9}{16}$ inch by $2\frac{1}{16}$ inches on the inside. For the heads, two pieces $\frac{1}{2}$ inch thick, $3\frac{1}{2}$ inches wide, and 4 inches long are needed. Through the middle of each a hole about $2\frac{1}{16}$ inches wide by $2\frac{9}{16}$

inches long should be cut to fit snugly over the ends of the tube. When the heads are securely glued to the central tube, and braced by a few wire nails driven into them from the inside, the whole will form a strong spool having a space 3 inches long between the heads for the winding. The corners of the tube where the wire is to be wound must be well rounded off with a file, to avoid the difficulty of having to bend the first layer of wire around square corners. In one of the heads two small holes and a saw cut must be made as shown at 1, 2, and 4 in Fig. 226, while in the other head only one saw cut, 3, is needed. These holes and slots are for bringing out ends and loops in the winding, so that connections may afterward be made to different parts of the latter. On the heads of the spool the numbers 1 to 4 should be plainly carved to avoid confusion.

The coil is to be wound of No. 16 double cotton-covered magnet wire, of which about three pounds, all in one piece, will be required. This is to be wound on the spool in eight layers of about fifty turns each, as follows: First pass about 4 inches of one end of the wire out through the hole numbered 1, and then wind on six even layers like thread on a spool. The work can be done most easily by clamping the spool on the face plate of a lathe and turning it over slowly by hand as the winding progresses. It is well to give each layer a coat of shellac before winding the next. When the six layers have been put on, make a short loop in the wire at saw cut marked No. 2, and allow the loop to project outside an inch or so, as shown. Continue the winding as before, and at the end of the seventh layer leave a similar loop at saw cut No. 3, and finally finish by putting on the last, or eighth, layer and passing the end of the wire out through hole No. 4. After the winding is complete it should be protected from possible injury by a covering of two or three layers of cloth fastened with glue or shellac.

The core is to be made of strips of thin sheet iron or sheet steel cut two inches wide. One sixty-fourth inch is a desirable thickness, but anything less than $1/32$ inch will answer. About eleven pounds will be needed for the core, in strips of different

lengths varying all the way from 11 up to 21 inches long. Insert the strips into the hole through the spool one by one, putting in the longest ones first at the side nearest where the terminals are brought out, and finishing up with the shorter pieces at the opposite side. Enough strips should be used to fill up the hole snugly. If the strips are rusty it will not be necessary to insulate them from each other, but if they are clean and bright it is a good plan to insert an occasional strip of paper so as to divide the core up into groups of half a dozen sheets each.

The strips must next be bent around, one at a time, so that their ends meet at the side of the coil opposite the terminals. Trim off the ends of each strip with a pair of tinner's snips so that they meet without overlapping, forming what are known as "butt joints." Care should be taken that the successive joints do not come in the same place, but overlap each other about two inches as they pile up, in the same way as the joints in brickwork. After the ends are all in place, they may be held permanently by wrapping them with a layer of stout cord (not wire) as shown at *T*, Fig. 226. This completes the autotransformer, though a coat of black paint will improve it.

The electrolytic cell consists of a lead tank nearly filled with a suitable liquid in which are immersed two rods of aluminium supported by a light wood frame, as shown in Fig. 227.

The tank should be made of sheet lead not less than $3/32$ inch in thickness. A good size is 4 inches wide, 9 inches long, and 8 inches deep. Fig. 227 indicates how a piece of the sheet lead 14 by 20 inches may be used most economically. Cut out the two pieces as shown, fold on the dotted lines so that the joints lap on the outside, and solder the seams heavily with ordinary solder. Do not try to use a lead-lined wooden tank, as the success of the apparatus depends largely on the cooling effect of the surfaces exposed to the air.

For the electrodes, two round aluminium rods $3/4$ inch diameter and $6\frac{1}{2}$ inches long are required. These must be of commercially pure aluminium, and not the so-called "hard stock" or alloy. Fasten to one end of each rod a piece of No. 16 copper

wire to serve as a terminal. The best way to do this is to drill a small hole through each rod near one end, and then insert the wire and drive down the aluminium with a center punch until the wire is tightly pinched. (See *A*, Fig. 227.) The tank itself also serves as an electrode, so that it is necessary to solder a wire to it somewhere on the outside. The aluminium rods are best supported in the tank by means of a light wooden frame made of six pieces as shown at *B*, into which the rods may be clamped by thin wooden wedges driven in where they pass through the holes.

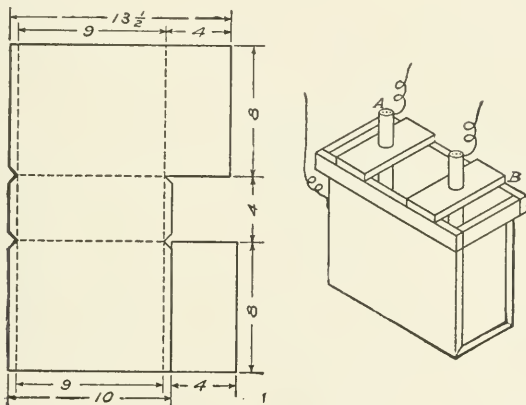

Fig. 227—The sheet-lead tank

To make up the liquid for the cell, put two pounds of crystallized sodium phosphate in the tank, and fill up the latter with about one gallon of lukewarm (not hot) water or enough to fill it to an inch from the top. Stir with a stick until the salt is dissolved, and then adjust the aluminium rods so that they dip into the solution three inches.

Before the apparatus can be set at work the rods must be coated with a film of oxide. This has to be formed by the alternating current itself, for which purpose the rods may be temporarily connected to the 110-volt power mains as shown in the

first diagram in Fig. 228. A resistance, R , of about ten ohms must be used to prevent too much current from passing at first. After half a minute this resistance may be gradually reduced to zero, and the operation will be completed.

For actual service the autotransformer, rectifying cell and storage battery are to be connected up as shown in the second diagram in Fig. 228. The autotransformer may be connected to a 110-volt lamp socket by means of a sufficient length of No. 16 lamp cord and an attachment plug. A two-ampere fuse should be included in the circuit.

The windings of the autotransformer have been so proportioned

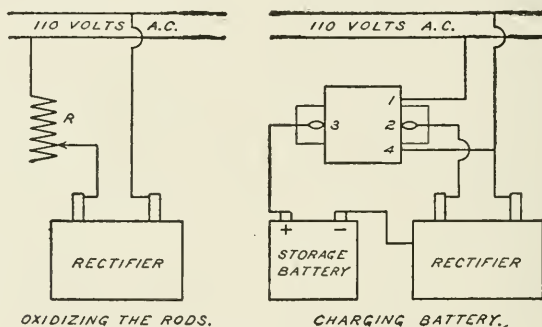

Fig. 228—Method of connecting up the rectifier

that when connected to 110 volts about $2\frac{1}{2}$ amperes will flow through a six-volt, sixty-ampere-hour battery. This low rate of charging contributes to long life of the battery, and at the same time minimizes the amount of attention necessary in charging, since an overcharge at low rate does very little harm. With ordinary use of an automobile, a ten-hour charge over night every two weeks will keep the battery full and in good order.

After about fifty or sixty hours' use of the rectifier the sodium phosphate solution will become exhausted. This will be indicated first by unusual heating of the tank and autotransformer, due to leakage currents, and finally by the blowing of the main fuse and possibly the discharge of the battery back through the tank

and coil. It is therefore necessary to make up a fresh solution for the tank and reoxidize the rods after about fifty hours' use, or when excessive heating is first noticed.

The aluminium rods last a long time, and when the lower ends become worn thin they may be inverted if care be taken to remove every particle of the copper connecting wires.

The apparatus will charge an eight-volt battery, if necessary, but at a slower rate, and it can also be used on a four-volt battery in an emergency. In the latter case the large currents may soon cause overheating unless a resistance of about one ohm be connected in series with the battery.—95

HOME-MADE ADJUSTABLE SOCKET FOR TUNG- STEN LAMPS

The accompanying illustration shows a very simple way of making an adjustable socket for tungsten lamps, in which the lamp will tend to hang perpendicularly of its own weight. A cage is first made consisting of three or more prongs, brazed to a split ring, which is slipped over the lamp socket. A similar cage is made to slip over the neck of the plug. The prongs may also be soldered to the socket and the plug. These prongs must be long enough to extend past the center of a solid rub-

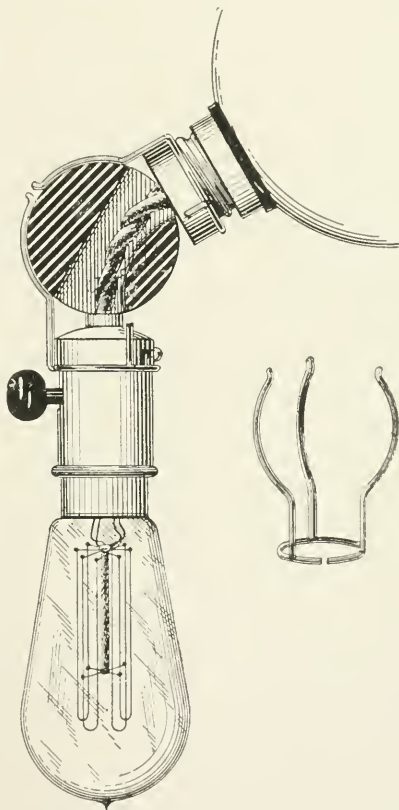

Fig. 229—Adjustable socket for tungsten lamps

ber ball, which is to unite the lamp socket and plug. The rubber ball may be purchased at any toy store.

With a thin metal tube cut a hole through the center of the ball. This is easily accomplished by turning the metal tube with one hand and holding the ball with the other. By running the tube through the rubber a second time at an angle to the first hole an oblong bore is made, such as shown in the illustration. Through this hole put an ordinary lamp-cord and connect one end with the plug and the other with the lamp socket. Now screw the plug into the bracket and turn the ball so that the lamp socket hangs perpendicularly. Then screw in the lamp. It will be seen that almost any angle may be obtained.—5

A CHEAP LAMP RHEOSTAT

A lamp rheostat is sometimes required for experimental purposes when receptacles for the lamps are not available. Where they are watched sufficiently to avoid any danger from fire, Edison base lamps may be held in place by nails, thereby overcoming the need of receptacles. The illustration shows such an arrangement, in which a lamp is held in place on a board by three nails, *A*, *B*, *C*. No dimensions are given for the location of the nails, as their proper position is very readily obtained by using a lamp as a gage. The edge of the board should be about at the junction of the base to the globe, as shown. See that the nails for holding the various lamps are so located that the globes do not crowd one another. The wires are connected to the nail *B* and to either *A* or *C*. They are twisted around the nails and may be soldered thereto if desired. When in use the board should be laid on a table somewhat larger than itself, and with the lamps in a horizontal position.

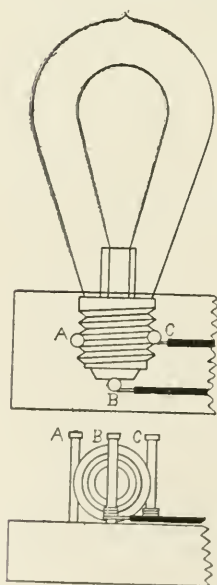

Fig. 230—A simple lamp receptacle

In case a lamp accidentally becomes loose, the table will catch it and prevent its being broken. The lamps are inserted by pushing them downward between the nails *A* and *C*, and screwing them up until contact is made with a nail *B*. Notice that, with certain connections, a short circuit will result if the shell of the base touch the nail *B* at the same time that it touches *C*.—54

OPEN-CIRCUIT TELEGRAPH SYSTEM

Experimenters and learners of telegraphy often wish to use open-circuit cells on short lines, but find that they are unable to call other stations without closing (keeping closed) their own key. But when the keys are closed the cells are polarized, and are soon worthless. The simple arrangement shown in the

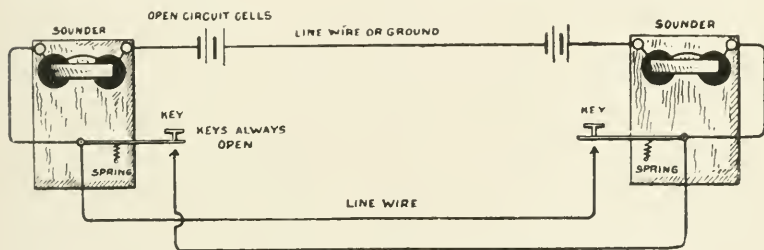

Fig. 231—An open-circuit telegraph system

accompanying diagram will obviate all the trouble, enabling them to call other stations, and at the same time the keys are always open; the cells being used only when the instruments are being operated. Any number of additional instruments may be put on by following the method indicated in the diagram.—94

A TEST FOR TELEPHONES

A great many so-called "high-resistance" telephones have recently appeared on the market for use with wireless detectors. Some of these have been found to be wound with German-silver wire. This gives the required resistance at a greatly reduced cost.

This fraud can be easily detected, even if the German silver is

concealed under an outer layer of copper wire, as follows: Balance as nearly as possible on a sensitive Wheatstone bridge, so that the indicator comes to rest at or near the zero point. Then hold down the key for about a minute, allowing the battery current to flow through the apparatus. If ten bobbins of the telephone are wound with copper wire, the indicator will move slowly up the scale because of an increase in resistance, due to the heating effect of the current. With copper this change of resistance is considerable, while with German silver it is small.—11

WAYS TO BRACE POLES FOR PRIVATE TELEPHONE LINES

The extension of telephone lines to rural districts is one of the real blessings modern science and business enterprise have bestowed upon the farmers. Most of these spurs and cross-country lines are made at the expense of the telephone companies; but sometimes, when the number of subscribers does not warrant it, the prospective customers must furnish or erect their own poles. Even if these are done by the companies, many boys may desire to unite their neighbors' houses with theirs by private telephone or telegraph lines. Telegraphy is a fascinating study to boys. To those who contemplate the erection of a private telephone or telegraph line it may be informing for them to examine these designs of two ways of bracing poles. In fact, the plans are worthy of any farmer's attention who uses poles for any purpose whatsoever about the farm.

It is to be remarked, first of all, that poles get out of plumb and alinement because of wind pressure and wire strain. Eliminate these two stresses upon any pole, and unless it be located at the edge of quicksand, or abuts a living spring of water, it will very likely remain erect until it decays. Fig. 1 shows a form of bracing that is excellent to aid a pole to withstand the rocking effect of the wind. Most winds are unsteady in effort, and this accounts for so many poles leaning, for the pressure of the wind comes and goes suddenly, each gust being followed by periods of lull, so that a pole rocks, swinging out with the gust, and back with the following lull. The design is self-explan-

atory, and is intended for a full-sized pole, set seven feet in the ground. But poles to carry two to four wires need not be so large, either in diameter or in height, nor be set so deeply in the ground. The perpendicular braces, coupled at the top by horizontal timbers, are efficient to withstand the rocking effect of the pole. The oblique braces are also valuable assistants. Strange as it may appear, when oblique braces are used alone, they tend to lift a pole out of the earth as it rocks back and forth. The horizontal braces do not have this tendency. Perhaps chil-

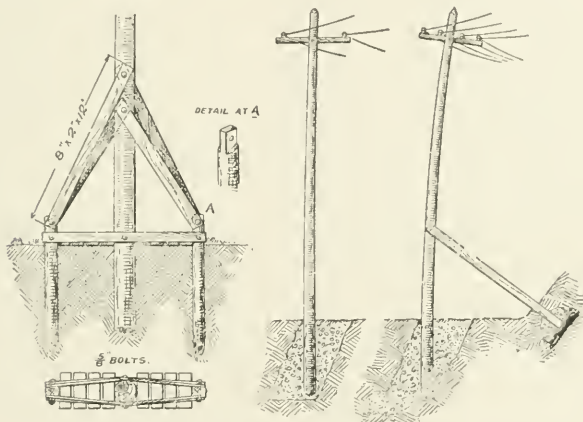

Fig. 232—How to brace a telephone pole

dren have observed that their swing poles, when braced by oblique braces only, have gradually become loosened and lifted by swinging. This system of bracing poles, therefore, is to be recommended for children's swings. The design shows the parts well proportioned, and they may be proportionally reduced in dimensions in working them out.

As indicated at 2 cement may be substituted for wooden braces at a bend of the line where the wind and wire strains are not too severe. The hole in the ground is dug obliquely, the pole is set upright, and the triangular spaces on both sides are filled with cement. Odd-shaped poles, should it be necessary, may be used

anywhere when properly braced. One good way of bracing such a pole is portrayed in Fig. 3. A toe of cement may be extended into the ground to give the cement a "grip." If it is required to have a still stronger support, a wooden brace may be affixed as shown, its bottom resting on a large flat stone, with or without a cement binding.

By either of these methods, a private line of telephone or telegraph wires can be maintained against the blasts of Boreas himself, whether the old mythological god blows hot or cold, hard or easy.—7

A SIMPLE WIRELESS TELEGRAPH DETECTOR

One of the requisites of a good wireless telegraph detector of the crystal type, is that it be so constructed as to permit easy

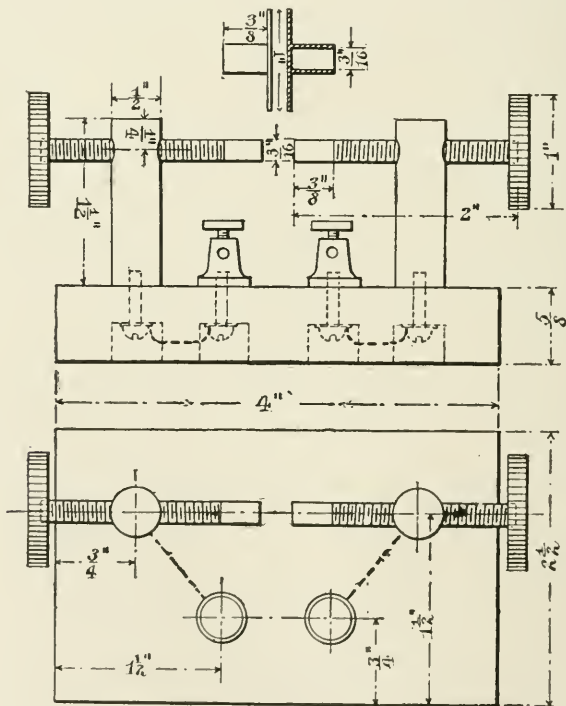

Fig. 233—Details of the construction of the wireless telegraph detector

removal and substitution of different metals for the electrodes, as different metals sometimes produce different results.

The necessary parts of a simple yet very efficient wireless detector are as follows: A base, of the dimensions shown in Fig. 233; 3 inches of $\frac{1}{2}$ -inch round brass rod; 4 inches of $\frac{3}{16}$ -inch round brass rod; some brass tubing, $\frac{3}{16}$ inch inside diameter; two thumb nuts of brass or hard rubber, and two binding posts.

The $\frac{3}{16}$ -inch rod is cut into two equal parts, and both pieces threaded to within $\frac{3}{8}$ inch of one end. The other rod is also cut into two equal parts,

making a pair of standards. At $\frac{1}{4}$ inch from the top of each of the standards a hole is drilled and tapered to receive the smaller rods.

The other end of each standard must also be drilled and tapped to receive a machine screw, by which it is fastened to the base. The positions of the standards on the base are indicated on the drawing.

The smaller or pressure rods are screwed in the holes on the standards, with the untapped ends facing each other, and the thumb nuts, having previously been tapped to fit the rods, are screwed on them.

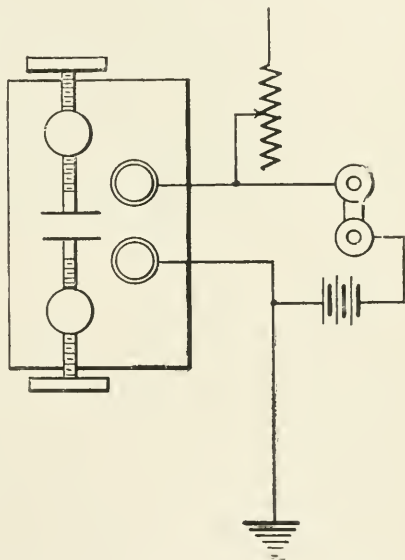

Fig. 234—Electrical connections of the wireless telegraph detector

The binding posts must now be mounted on the base, and connected to the standards by wires run underneath the base.

To make the removable electrodes, the brass tubing is cut in $\frac{3}{8}$ -inch lengths. One-inch disks of $\frac{1}{16}$ -inch brass, copper, and other metals are cut out, and at the exact center of each is sol-

dered one of the brass tubes, with its length perpendicular to the disk. When it is desired to use them, the tubes are slipped over the ends of the rods, a crystal placed between them, and the rods screwed up so as to hold the crystal in place. Carborum lum and

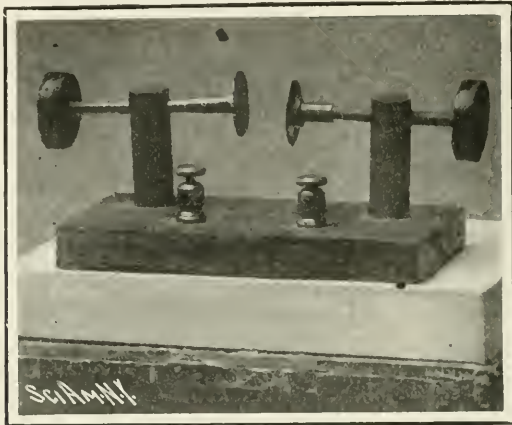

Fig. 235—A simple wireless telegraph detector

silicon are the most common crystals, although there are many others that produce excellent results.—38

AN ELECTROLYTIC DETECTOR

Those who have attempted to make a wireless detector have doubtless been slightly dismayed when it came to deciding on a certain type. Of course, there are many amateurs who like to make several types, but it is for those who desire to make but one detector, that this short description is written.

Of all the modern wireless detectors—the electrolytic, the carborundum, magnetic, silicon, audion—the electrolytic is given first place. It is very easily made, and when made well requires very little adjustment or attention. The silicon and carborundum detectors being of the crystal type are fairly sensitive when correctly adjusted, but it is very hard to strike the maximum sensitive point. The audion is beyond the reach of most amateurs, because it employs platinum grids sealed in an electric-light bulb

from which the air has been exhausted. The magnetic responder is a mechanical device, and is not very sensitive.

The sensitiveness of the electrolytic depends entirely upon the size of the platinum wire used for the "point," and the good workmanship and accuracy displayed in making the detector. A photograph and drawing of this type is shown herewith, the cross-section lines being omitted in some places, in order to bring out the design better and clearer.

The part *A*, Fig. 236, which will be called the standard, is made from a piece of brass $\frac{1}{4}$ inch square and $1\frac{1}{2}$ inches long. A hole is drilled in each end and tapped for an $\frac{8}{32}$ -inch thread. A $\frac{1}{8}$ -inch brass rod $1\frac{3}{4}$ inches long is threaded its whole length, and screwed in one end. The part *B* is made from square brass tubing, $\frac{1}{4}$ inch inside and about $\frac{1}{16}$ -inch walls. There should be no side motion, turning to the left or right. It is important that this piece should fit snugly over part *A*. A square piece of sheet brass is to be

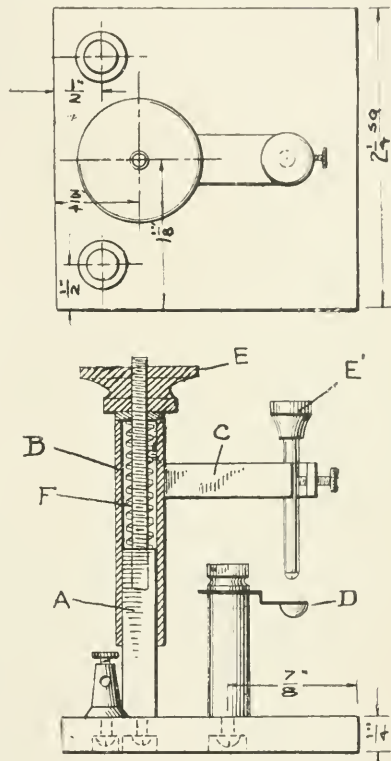

Fig. 236—Plan, side and sectional views of the detector

soldered on one end, and a hole drilled exactly in the center. The arm *C*, which is soldered to piece *B*, is made $\frac{1}{4}$ by $\frac{3}{8}$ by $1\frac{1}{8}$ -inch, one end being cut and drilled as shown. To hold the platinum wire, or point, a point holder is made from $\frac{1}{8}$ -inch rod about $1\frac{1}{8}$ inches long. One end is threaded with an $\frac{8}{32}$ -

inch die, and the other end is tapped to hold a $4/32$ -inch machine screw. A $1\frac{1}{4}$ -inch piece of $3/8$ -inch round brass is tapped at one end for an $8/32$ -inch screw. The other end must be turned to a diameter that can be threaded with an $8/32$ -inch die. A small

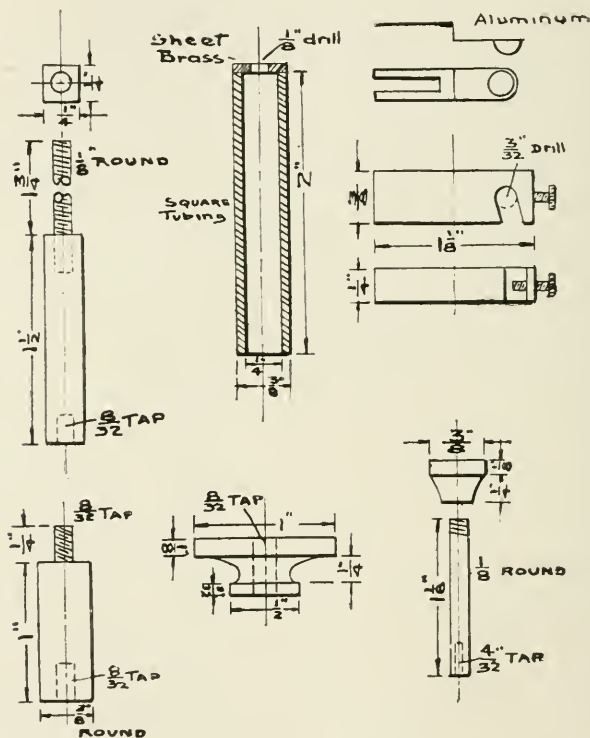

Fig. 237—Details of the detector

nut, which may be conveniently obtained from a dry cell, is fitted on the threaded portion.

The small cup *D*, which is to be made of aluminium, is formed by hammering a cup-shaped depression in a piece of thin sheet aluminium. It need not be larger than $1/4$ inch or $3/8$ inch wide and 1 inch long. A slot is cut in the end opposite the cup, and

is made wide enough to permit its being fastened under the nut on the small standards. The thumb nuts, EE' , are made from hard rubber, and may be turned to any desired shape. The larger one will have to be threaded to go on the rod of the standard, A . A small spring, shown at F , can be made from a brass wire.

If a glass cup, to hold the acid, is preferred, it may be made by sealing a platinum wire in a small piece of glass tubing. The platinum wire may be soldered to a strip of brass, which in turn may be fastened under the nut on the standard. As regards the size of platinum wire

to be used, 0.0001 inch is a very good size, and will work very delicately indeed. Of course, there are both finer and coarser wires that will work also, but the size mentioned gives excellent results and is moderate in price.

The assembling of the detector is made clear in Fig. 236. The position of binding posts, kind of base, and other details may be altered to suit the taste of the maker. The connections are shown in the small diagram, Fig. 238, A being

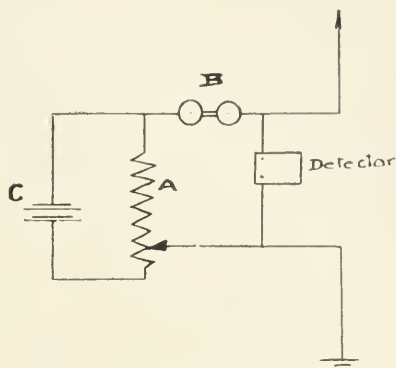

Fig. 238—Diagram of the electric connections

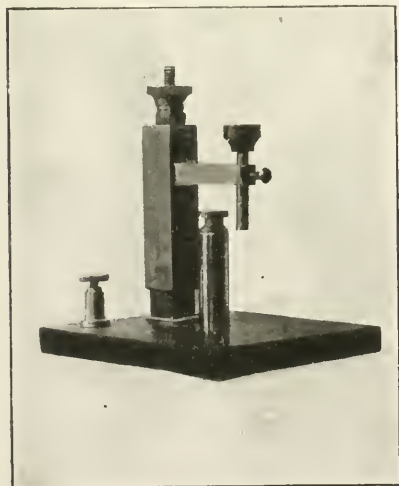

Fig. 239—General view of the electrolytic detector

the potentiometer or variable resistance, *B* the phones, *C* the battery; the tuning coil not being shown.—38

THE CONSTRUCTION OF A MAGNETIC DETECTOR

A practical magnetic detector may be made quite simply as follows:

A suitable baseboard for the instrument is first selected from straight-grained pine, 18 inches long, 6 inches wide, and $\frac{7}{8}$ inch thick.

Procure the works from an ordinary clock, preferably of the eight-day variety, although those from an ordinary alarm clock will be chosen here for the sake of simplicity. Remove the balance wheel and all unnecessary gears, screws, etc. To one end of the spindle of the last cogwheel solder a narrow strip of tin 1 inch long and $\frac{1}{8}$ inch in width, to serve as a dog to hold a wind-brake, this to cause the wheels to revolve slowly and quietly. The tin strip should have a small hole punched through the center and placed over the end of the spindle, which projects a trifle from the under frame. A small drop of solder will secure it, after which any form of small cloth or paper vane may be attached by a wire loop or frame. Owing to the difference in construction of various clockworks, it is difficult to specify any shape or position of the brake, but the one shown in Fig. 240 gives the general idea. Cloth over a frame is preferable to paper or cardboard, as it moves silently. Allowance should be made for the movement of the vane, either by cutting away the wood around it, or projecting the vane through a hole in the base, and supporting the whole instrument on a superficial base by means of cleats. The spindle to which the hands are attached serves for the driving shaft, and should be soldered to the cogwheel through which it passes, as ordinarily it is held by the friction of a spring pressing against it.

Two wooden disks, preferably birch, are now cut out 4 inches in diameter and $\frac{3}{8}$ inch thick. Upon the periphery of each disk is cut a groove of the shape shown in Fig. 241.

From a piece of heavy sheet brass cut a square 2 by 2 inches

and drill a $\frac{1}{8}$ -inch hole in each corner and one in the center to fit the driving spindle on the clockwork. Place in position on the spindle and fasten with solder, being careful to keep it true. Hollow out the center of one of the wooden disks sufficiently to contain the lump of solder so formed, and fasten it to the brass square by means of small steel screws passed through the hole in each corner. A small magnetic screw driver will be found

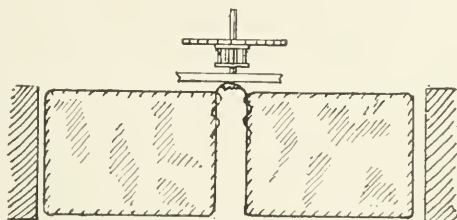

Fig. 240—The wind brake on the clock

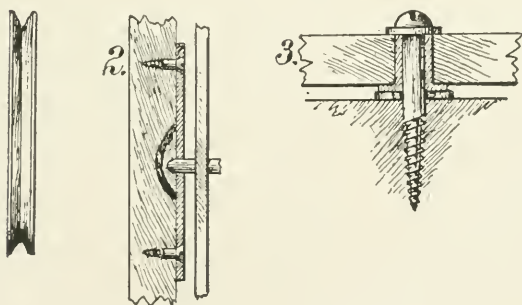

Fig. 241—Details of the pulleys

very useful for passing the screws into place through the open work of the clock frame.

The clockwork is now mounted on one end of the board, the center of the disk being 3 inches from the edge. Stove bolts passed through open parts in the frame from the bottom of the baseboard and fitted with nuts and washers will be found the best method of doing this. A hole should be bored in the baseboard immediately beneath the winding stem, to allow for the

insertion of the key. Next cut a block of soft wood 5 inches square and of a thickness of $1/16$ inch less than the distance between the top of the baseboard and the under side of the mounted disk. The remaining disk is now fitted with a brass bushing and a 1-inch round-head brass screw selected to fit the hole in the bushing nicely, and passed through it into the block of wood just mentioned, placing a washer beneath the disk and one under the screw head (Fig. 241). Fasten the block to the baseboard in a position so that the distance between centers of the disk shall be 12 inches.

This finishes the framework, and the coils should now be wound and adjusted. Obtain a piece of annealed glass tubing,

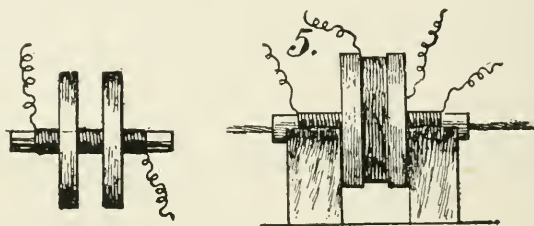

Fig. 242—The primary and secondary coils

as thin as possible, 2 inches long and $1/4$ inch external diameter. Hold the ends in a Bunsen flame just long enough to smooth the rough portions, flaring one end slightly with a small stick of wood. This prevents chafing of the iron rope.

In winding the primary coil over this tube it is a good plan to tie the ends tightly with thread, to prevent slipping. The wire used should be No. 36 silk-covered, and should measure 10 feet in length. It is wound in a single layer as closely and evenly as possible, leaving 6 inches of the wire at each end for connecting. The coil when wound should occupy a space of $1\frac{1}{2}$ inches in the center of the tube. Give the whole a good coat of shellac and allow to dry.

Over the coil and tube so formed are slipped two small disks

of $\frac{1}{4}$ -inch soft wood $1\frac{1}{2}$ inches in diameter (Fig. 242). The hole in the center of the disks should be just large enough to fit over the coil tightly, and shellac used to hold them in place. They should occupy a position in the center of the tube, being set $\frac{3}{8}$ inch apart. When they have become firmly fastened in place the space between them is wound full of No. 36 silk-covered wire, leaving free ends about a foot long for connecting.

Tube and coils are now placed in position on the baseboard so that the interior of the tube is in line with the grooves on the periphery of the disks, and the coils midway between them (Fig. 243). Support the tube on a pair of blocks, as shown, using a liberal amount of shellac to hold it in place.

Cut out another wooden block 4 inches long, 2 inches wide, and

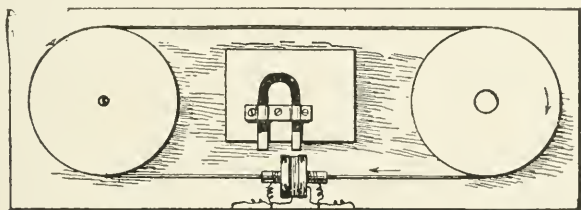

Fig. 243—The detector assembled on the base board

of about the same height as those supporting the tube. Fix this block lengthwise in the center of the baseboard. Procure a small permanent magnet of the horseshoe variety, and mount it on the block in such a position that its north pole will be pointing directly in front of and nearly touching the outside turns of the secondary coil (Fig. 243), while its south pole will be opposite one end of the tube. If the disk on the clockwork revolves from right to left (as it ought), the south pole should be to the left of the center of the tube and coils; if in the opposite direction, to the right. It is immaterial which pole is in front of the secondary coil, as long as the remaining pole is in the proper relation to the direction of the moving band, about to be described. The commercial instrument is fitted with two magnets, like poles adjoin-

ing, and facing the center of the secondary coil, but the difference in effectiveness of this arrangement is so slight as to be unnoticeable.

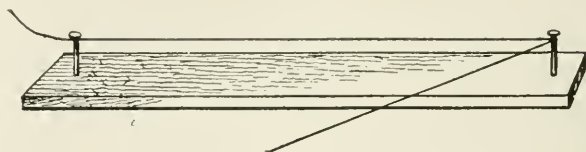

Fig. 244—Winding the wire band

We now come to the last, and if not properly made, the most difficult and exasperating part of the detector, the moving band or rope of iron wire. To the uninitiated this has always been a source of great difficulty and annoyance, and though simplicity itself when made in the following manner, attempts at other methods are almost sure to result in a bungling tangled mass of stray loops and ends.

The wire of which the band is made is No. 36 silk-covered, iron wire. Select a soft pine board $\frac{7}{8}$ inch thick about 3 feet long and 4 inches or 5 inches wide. Drive two nails to a depth of $\frac{1}{2}$

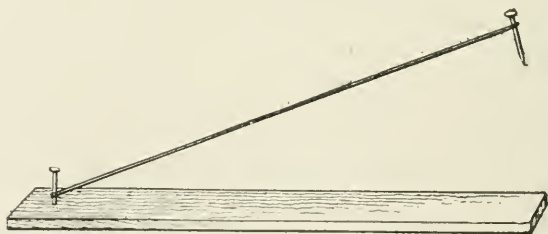

Fig. 245—Removing the wire strands from the board

inch in the board at a distance apart equaling twice the circumference of the oval formed by the two wooden disks, when measured by a string passed around the grooves. Starting at one nail (Fig. 244) wind the wire from one to the other, always winding in one direction; that is, so as to inclose the two nails in a narrow coil of wire. When the total number of strands equals 100 the

ends are connected, and one nail is cautiously withdrawn from the board, keeping the wire still on it, and drawn taut (Fig. 245). Twist the strands into a rope, keeping them taut, and remove the remaining nail from the board. Both nails are now removed



Fig. 246—Method of connecting the ends

from the ends of the band, being careful not to disturb the loops formed by them. Thread the band through the glass tube, passing it around both pulleys and bringing the ends together between them. The two ends are linked together by threading a separate piece of the iron wire through and through them (Fig. 246), drawing tight after each threading, and connecting the ends of the wire by tying or twisting, as in the case of the band.

This completes the working parts of the detector, and any casing may be fitted to it and finished according to the ideas of the operator.

A good casing is made by fitting the sides and ends with $\frac{3}{8}$ -inch hardwood strips extending $\frac{1}{2}$ inch above the surface of the disks. This forms a box with a top open, and a nice-looking

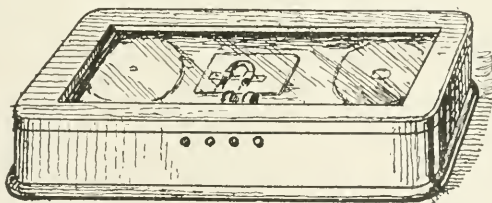

Fig. 247—General view of the magnetic detector

instrument is made by attaching a glass door by hinges to cover it and protect the working parts from dust and injury (Fig. 247).

The ends of the primary coil are brought to binding posts in the side of the box nearest them, and those of the secondary

connected to another pair of binding posts, one on each side of the first two. If desired, a false bottom of pressboard can be fitted beneath the disks, leaving only the coils and tube, magnet, band, and disks visible.

It will be noticed in the case herein cited that the winding stem is situated in the base of the instrument—a great inconvenience that can be remedied only by gears or ratchets; but this is hardly worth while, in view of the great advantage to be gained by using an eight-day clock, which, in addition to its ability for long running, usually has the winding stem on its face. The proper speed of the driving disk is that which will cause the moving band to complete the circuit through the tube in about two minutes.

Aerial and ground are connected to the terminals of the primary coil, and the telephone to those of the secondary. An almost inaudible hissing sound, in the telephone, as the band slowly threads its way through the tube and around the pulleys, shows the detector to be in working order.—31

EXPERIMENTS WITH ALTERNATING CURRENT, USING A SMALL DIRECT-CURRENT MOTOR

A small direct-current motor, such as can be purchased for about a dollar, will operate in various ways as an alternating-current motor. These methods of operation are not recommended for regular use, but they serve as excellent experiments with alternating currents.

A series-wound motor with a three-part commutator is suitable. Owing to the variety of such motors on the market, only general directions can be given here, leaving the details to the judgment of the experimenter. If the motor is to be connected to an alternating-current circuit of about 110 volts, it is necessary to have some means of limiting the current passing through the windings. The diagrams show a lamp rheostat used for this purpose. The rated voltage of the lamps should not be less than the voltage of the circuit, for the resistance of the motor may be so low that the lamps will receive almost the full voltage of the

supply, and they would then be burned out if made for a lower voltage. A rheostat enabling any number not exceeding ten of 16-candle-power carbon filament lamps to be connected in parallel is large enough. In determining whether the wiring and fuses through which the current is supplied have sufficient carrying capacity, remember that each lamp takes about $\frac{1}{2}$ ampere when supplied with its rated voltage. The current per lamp will be less than this when the motor is in series with the lamp rheostat.

Make the connections to the motor with all of the lamps turned off, and start by turning on the lamps until the motor receives sufficient current. Do not turn on so many lamps that the motor attains an excessive speed or temperature.

Of course, a suitable step-down transformer or a reactance coil may be used instead of a rheostat.

When the motor is in proper condition to operate as a direct-current series motor, it may be operated as an alternating-current series motor. With the exception of inserting the rheostat, the motor is connected to the alternating-current circuit in the same way that it is connected to a battery when run as a direct-current motor. (See Fig. 248.) To reverse the direction of rotation, transpose the wires connected to the brush holders, as would be done to reverse it when operating with direct current.

A repulsion motor consists of a stationary field magnet, through the winding of which alternating current is passed. The armature is similar to a direct-current armature. Instead of the two brushes, or, in larger machines, the two sets of brushes (corresponding to the positive and negative sets of brushes in a direct-current machine) being insulated from one another, they are connected together. To run the motor as a repulsion motor, it will be necessary to shift the brushes until the proper position for operation is found. If the brushes supplied with the machine can be readily shifted, then they may be connected together by attaching a wire to the two brush holders. If they cannot be readily shifted, remove them and bend a piece of copper wire into the shape shown in the diagram (Fig. 249) so that it can embrace the commutator and touch it at diametrically opposite

points. This wire acts as two brushes connected to one another, and for experimental purposes may be held in place by hand. After the brushes have been arranged, pass current through the

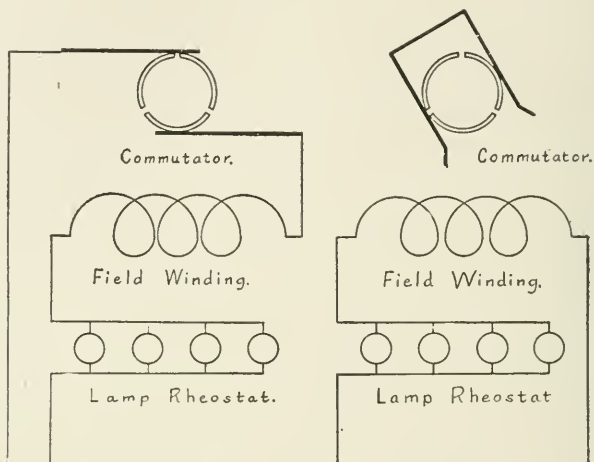

Fig. 248

Fig. 249

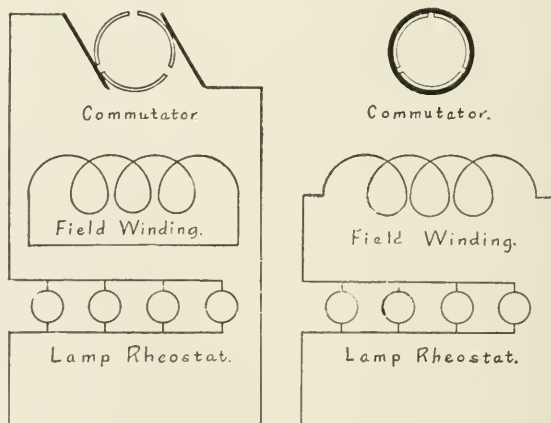

Fig. 250

Fig. 251

Figs. 248 to 251—Various methods of connecting the motor

field winding, as shown in Fig. 249, and vary the position of the brushes until the motor runs.

The inverted repulsion motor differs from the repulsion motor in that the alternating current is supplied to the armature, and the field winding is short-circuited. To obtain this motor (Fig. 250) connect together the two ends of the field winding and supply current to the armature. As was the case with the repulsion motor, it is here necessary to shift the brushes until the proper position for operation is found. If the brushes supplied with the motor can be readily shifted, supply current to the armature through them. Otherwise, the current may be supplied to the armature by removing the regular brushes and pressing the wires carrying the current against the commutator at two diametrically opposite points, shifting them until the proper position for operation is found. The repulsion and inverted repulsion motors are reversed by shifting the brushes.

In the single-phase induction motor current is supplied to the stationary winding, and the revolving part consists of a winding having short-circuited coils, or else a squirrel-cage winding.

To obtain the induction motor, wrap a few turns of wire around the commutator, so that each coil of the armature is short-circuited. Run without brushes, supply current to the field winding only, according to Fig. 251. Unlike the other motors here described, the single-phase induction motor is not self-starting unless special devices are provided to make it so. When these devices are absent, as in the case here, the motor will run equally well in either direction when once started. Start by giving the shaft a twist with the fingers or by wrapping a piece of string around the shaft and rapidly pulling it off.

For the theory of these motors, and also the modifications in construction used to secure better operation, text books on alternating currents should be consulted.—54

AN ELECTRICAL PARADOX

With comparatively little apparatus, it is possible, apparently, to set Ohm's law at naught by lighting an ordinary electric light having a considerable resistance, to full incandescence while on

a heavy short circuit. All that is required is a medium-size induction coil, giving, say, a four-inch spark, provided with a pair of spark balls, a source of current for it, a glass condenser or Leyden jar of suitable capacity, a miniature incandescent lamp having a resistance of from 5 to 10 ohms, and about a meter (39.37 inches) of heavy bare brass wire.

The brass wire is to be bent into a long U about eight centimeters (3.15 inches) wide, and the ends inserted into an insulating base. The lamp is then to be arranged so that it can be slid to any position between the parallel sides of the U.

If the several parts of the apparatus are now connected as

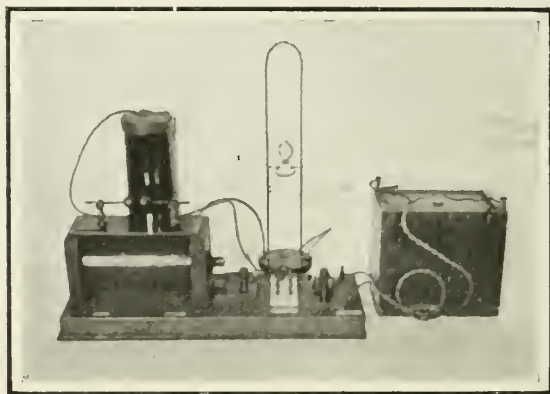

Fig. 252—Apparatus for performing the electrical paradox

shown in the diagram, and the knife switch is thrown, the usual heavy discharge across the spark gap, due to the energy momentarily stored in the condenser, will take place, and at the same time, the lamp will be found to light up quite as well as if connected to the battery alone. Upon sliding the lamp, the light will be found to become dimmer, while it will grow brighter as the bottom is approached. Indeed, if the lamp is small, it will be well to place it close to the top at first, and then slide it down

until full candle-power is reached, otherwise it might be burned out from excessive current. The experiment is particularly striking if the operating apparatus is concealed, and a fairly heavy piece of bare copper wire substituted for the "short circuit." A small gage of wire should then be used for leads for the lamp, for, curiously enough, a fine piece of wire connected across the terminals of the lamp will extinguish it altogether. That is, a small wire conducts this peculiar current with more facility than one of larger diameter.

The brass wire may be touched without fear of a shock, for while the current which it conducts is of a very high voltage and appreciable amperage, its extremely high frequency renders contact harmless.

Although the fundamental law of electrical engineering has seemingly been defied, really it has only been modified by a factor which does not enter into the computation of ordinary electric currents. From the behavior of the light at different points on the wire, it can be seen that the current shunted through the filament of the lamp is still proportional to a resistance, though obviously of a very different nature. If the effect of various sizes of wire on the current passing through the lamp is studied experimentally it will be found that in general the current is not proportional to the square of the wire, but is more nearly proportional to the diameter. That is to say, this resistance is a matter of perimeter and not of cross-sectional area, and since the current flows over the wire and not through it, hollow wires would conduct as well as solid ones.

The phenomenon is essentially one of impedance, and due to the large inductance which the brass wire offers to alternating currents of this character which have a very small time rate of change.—48

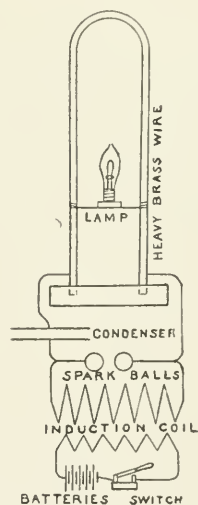

Fig. 253—Diagram of connections

CONSTRUCTION OF A SELENIUM CELL

The materials required for the construction of a selenium cell are as follows: Twelve feet of spring brass $\frac{1}{2}$ inch wide, $\frac{1}{16}$ inch thick, two small machine screws, two 3-inch bolts and nuts, a piece of thin mica 6 by 12 inches, $\frac{1}{4}$ ounce of selenium, a small piece of thin board, some wood screws, and a piece of glass about 3 by 3 inches.

From the brass cut 40 pieces 3 inches long, and drill a hole to take the bolts $\frac{1}{8}$ inch from one end. Also make up 39 washers by cutting pieces $\frac{1}{2}$ inch long and drilling holes in the center. From the mica cut 39 pieces $2\frac{1}{2}$ inches long by $\frac{5}{8}$ inch wide. Take half the brass strips, place a washer between each, pass a bolt through the holes in the ends, and screw up the nut. Do the same with the rest of the strips, and you have two sections of the cell. Now slide one section into the other, tighten up the nuts, and place in a vise. File down and polish the edges of the strips so as to form a perfectly smooth surface on one side.

Next separate the two sections again, place a piece of the mica between each strip, so as to insulate one section from the other, then assemble as before, being careful to get the top surface perfectly level and smooth.

Take another piece of the brass, $4\frac{1}{2}$ inches long; $\frac{1}{2}$ inch from each end drill and tap a hole to take the machine screws, and bend up $\frac{3}{4}$ inch of each end. Use this piece to clamp the two sections together in the center, being careful to insulate it from them. After making sure that the sections are properly insulated from each other, the selenium may be applied as follows: Hold the brass over a flame until the selenium melts freely, then rub the stick of selenium over the polished surface. If the brass is hot enough the selenium will adhere readily, but if too hot it will burn off. After applying the selenium, and while it is still soft, pass a knife blade lightly over the surface. This removes the surplus selenium, and leaves a thin smooth coating.

Now bake the cell in an oven for one hour, having the temperature just below the melting point of the selenium. Then take out and allow to cool in the open air.

Make a box with a glass cover, and wedge the cell in this with small pieces of wood. Fasten two binding posts in one end, and connect each binding post to one of the sections. The cell is now complete.

The advantages of this type of cell are that it is easy to get the top surface of the brass strips perfectly smooth, and, as the insulation is of mica, there is no danger of burning it and thus spoiling the cell. It is not necessary to tin the edges of the brass strips, and it is better not to do so, as the solder used in tinning is apt to melt and run between the strips, short-circuiting the cell.

CHAPTER VII.

THE HANDY MAN ABOUT THE HOUSE

A NOVEL MUSIC STAND OR BOOK REST

To make a music stand or book rest, such as shown in Fig. 254, out of one and the same piece of wood, without joining or the use of pins, seems almost impossible. Nevertheless, a novice,

so far as the use of wood-working tools is concerned, will be able to make one by following the instructions here laid down.

The size of the stand will depend upon the use to which it is intended to be put. If for a music stand or a large book rest, eighteen inches wide by three feet long will be a nice size. If intended for the table, for smaller size books, the length would better be only eighteen inches, the same as the width.

The board should be one and one-eighth inches thick, free from knots, cracks, and other defects. Either walnut, oak, or mahogany will do.



Fig. 254—A music stand made, without joining, of two intermeshing pieces

It would be well for a novice, in fact it would save time in any case, to have the saw cuts shown in Fig. 255 done at a mill or carpenter's shop. As seen by the dotted lines and in the end elevation, these cuts do not extend the full length of the board, but to within two inches of each other, at the center of the timber.

The board being cut, the next step is to mark five equally-spaced divisions, as shown in Fig. 257. The four short vertical lines are to be cut straight through the board, but the horizontal lines, joining them at the top and bottom, must only be cut half way through, or to the saw cut. The parts shown shaded are cut with a flat chisel, at an angle of forty-five degrees from the center, down to the vertical cut of the horizontal lines, as clearly shown in the side elevation. The board is now turned over and

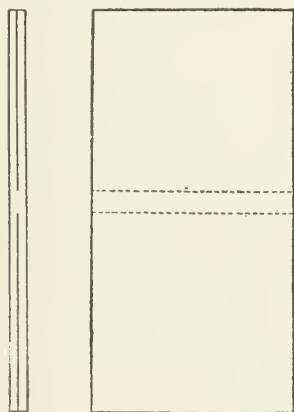

Fig. 255—The board is cut to within 2 inches of the center

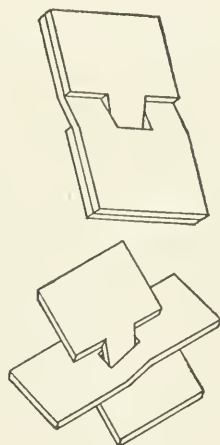

Fig. 256—A puzzling bit of woodwork

the same cutting done, but alternately, as clearly shown in Fig. 254.

The lower part of the stand may be ornamented as may be desired, but the upper half should be kept perfectly plain. The whole must be sandpapered down, first with rough and then with fine paper, and afterward varnished or stained.

To hold the stand in a certain position, according to the use to which it is being put, an ornamental brass chain is connected across the bottom by means of a screw eye at one end and a hook

at the other. The stand can be folded and leaned against the wall when not doing service.

A small model of the stand makes a very interesting puzzle. If made as shown in Fig. 256, the two pieces of wood can be separated and twisted around at right angles to each other. The

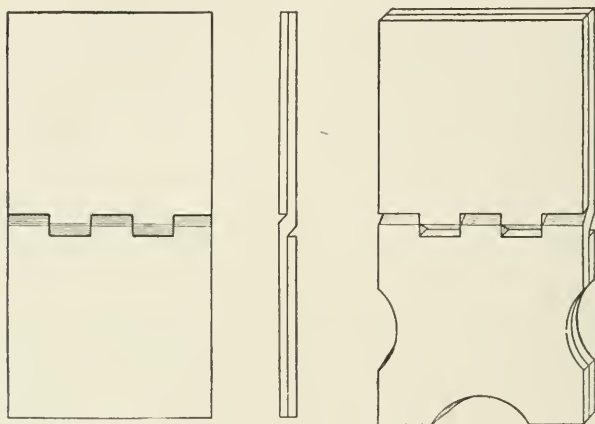

Fig. 257—How the joint is cut

device can then be given to a friend with a request that he get the two pieces apart, without breaking them. If the wood is sandpapered, and robbed of all traces of saw cuts, etc., the "puzzle" will deceive the most wary.—3

A TABOURET MADE FROM AN ONION CRATE

The accompanying illustrations show how a simple crate, used in shipping potatoes or onions, can be readily converted into a tabouret or flower stand.

A crate such as shown in Fig. 258 can be secured from any grocer or from a vegetable dealer. The sides and ends of the crate, which are comprised of slats arranged as shown, are fastened at their corners by a long nail, passing through holes in the ends of the slats.

To construct a tabouret, the nails in each corner are withdrawn and the slats, being separated, are then taken and slipped on the

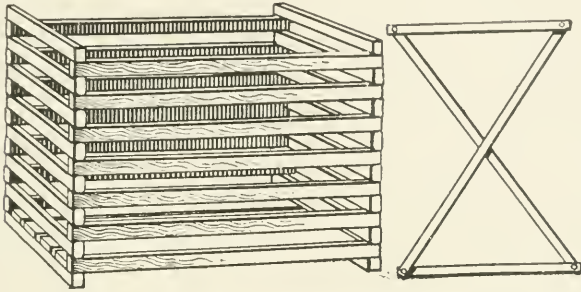

Fig. 258—Common onion crate and the rearrangement of the slats



Fig. 259—Artistic possibilities in an onion crate

nails, and arranged as shown, Fig. 259, the long slats forming a cross and the short slats arranged horizontally. After the slats have been assembled, the point of the nail can be riveted, holding the slats together, and producing an article of rigid construction, as shown in the photograph.

The same can be stained or painted at a small cost. While the slats are fairly well planed, the appearance of the article can be improved by planing the slats a trifle more before assembling them.—29

HOME-MADE METAL LAMP SHADE

The accompanying sketches show a simple and yet effective way to make a metal lamp shade. When the desired size, shape, and general style of the shade is selected, a diagram is made, from which the blanks or sections are made. The blanks are cut out from some thin metal, such as copper, brass, or black iron, with a small strip on one side, as indicated in dotted lines in Fig. 260. This flap is to be turned in and soldered to the adjoining blank.

Now trace the desired design on the blank, which may be a conventional flower or anything that appeals to the fancy of the maker. Put a blank on the end of a hardwood block, such as maple, and with a small punch, any shape, punch out the outlines of the design as closely as possible. After this the blank is turned over and laid on a piece of soft iron, and with a small prick punch a number of indentations are made in it between the outlines of the design.

After the blanks have thus been prepared, solder strips of metal on the inside, for the purpose of holding the glass, also to make the blanks stiff (Fig. 260). Now solder the blanks together. Small bows of lead ribbon may be made and fastened at the corners, giving the impression that the several blanks are tied together. The shade is now ready to be painted. Use any kind of paint that will dry flat, such as ivory black. When dry, place between the glass and the frame a color screen of colored gelatin or celluloid. Different colors may be pasted on the glass,

side by side, so as to bring out the different colors the design is supposed to represent. For instance, if the design should be a bunch of cherries on a twig, red may be used for the cherries, brown for the stem, and green for the leaves.

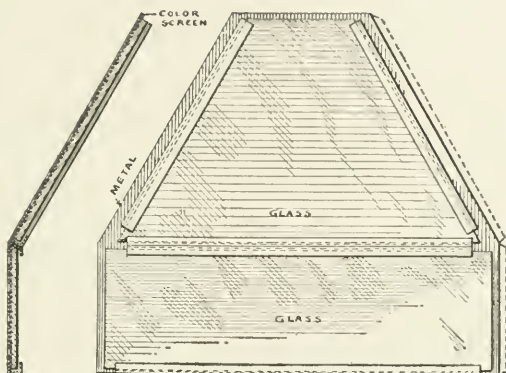

Fig. 260—Applying the glass to the sides of the lamp

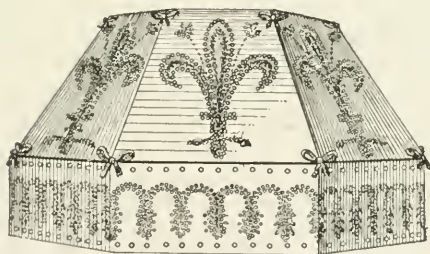

Fig. 261—A home-made metal lamp shade

When the glass is finally put in place, the pieces of metal soldered on the inside of the shade are now turned over, so as to hold the glass in place. Care should be taken that the glass does not fit too tightly. Always give it more or less room to allow for thermal expansion. A string of beads may be fastened to the bottom or lower edge of the shade.

The shade may be made of paper in which case two blanks are used. These are fastened and perforated at the same time with a large needle over a small cushion of sand or emery. The color screen is then inserted between the blanks and the latter are bound together with ribbons. Another pretty effect may be obtained by using two blanks of white Bristol board, without any perforation, and instead of the color screen, place between the sheets some pressed flowers, leaves, grasses, or the like.—5

ANOTHER METHOD OF MAKING METAL LAMP SHADES

Lamp shades, electric-light shades, shades for drop lights, and shades for candelabra can readily be made as follows: The material should be sheet brass, in thickness ranging from $1/40$ of an inch to $1/64$ of an inch according to the size and character of

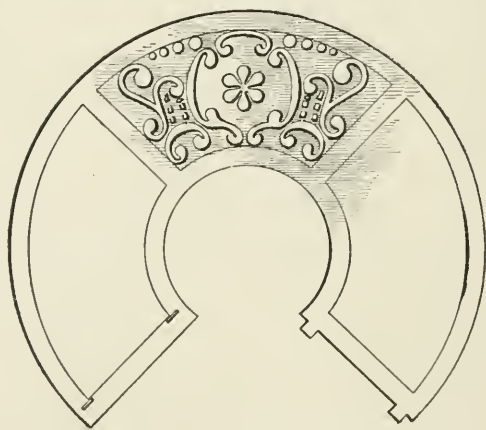

Fig. 262—A lamp-shade of brass cut with acid

the work. If the shade is to be quite large and to contain glass or other heavy materials, it is necessary to use the heavier brass or that of $1/40$ inch in thickness. In light work, like that of the candelabrum shades, the $1/64$ -inch brass is more desirable.

To make the candelabrum shade it is necessary first to draw the pattern on paper. Then, placing the paper upon the brass,

an outline of the pattern should be made with a very soft pencil. With a heavy pair of scissors this pattern can be cut out of the brass, but it is impossible to cut any design in the brass pattern with the scissors without wrinkling the metal. The neatest way is to burn out the design with nitric acid. First, the design should be drawn upon the brass pattern with a soft pencil. Then the pattern should be heated over a stove. While the shade is still hot a piece of wax or ordinary candle is rubbed over both sides of the brass. The heat of the brass melts the wax and forms a thin wax coating. When the brass becomes cold, the design, which shows through the wax, is traced with a pointed instrument. The parts of the brass which are to be burned out are scraped free of wax. The shade is then immersed in nitric acid. The acid eats through the exposed brass and the required design is very cleanly cut out.

The lamp, electric, and drop-light shades are made in the same way. Without much expense or trouble these larger pieces can be improved by placing different colored glass behind the designs.—96

DECORATIONS FROM PAPER PULP

Visitors to Washington usually bring away with them a pretty little souvenir knick-knack made from the pulp of destroyed greenbacks. It is not generally known that such pulp can be made just as well from any kind of waste paper as from the government notes. Accompanying this is a series of photographs showing the



Fig. 263—Grinding the paper pulp

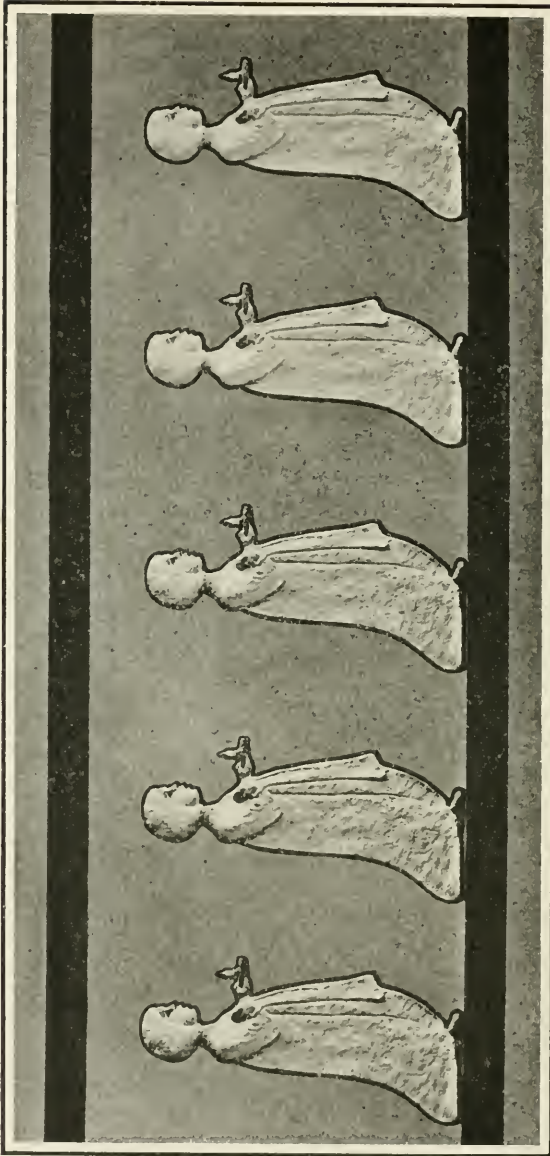

Fig. 264—Paper pulp frieze for the nursery wall

result of some experiments with pulp produced by tearing waste newspapers into small pieces, leaving them to soak for a night and a day and then making them into pulp by the simple process of putting the soaked paper through an ordinary meat chopper such as is in use in every household.

With this pulp it is possible to decorate boxes so as to transform them into attractive glove cases, suitable for Christmas presents, to fashion grotesque figures for the corners of dens, to change common jelly jars into chimney ornaments and to mold dainty figures for use in decorating walls or corners of rooms.

There is no mystery about the process. The simple story of the material used in making the figures shown in the photographs, which are so hard that they cannot be cut with a knife, is this: The members of the family were set to work tearing the newspapers into small pieces. These were left to soak in a wash tub for a night. They might have been ready then, but as the writer of this was not ready to use them they were soaked until the evening.

Then they were ground up and pulverized by being put through the meat chopper in the manner shown in Fig. 263. After this an attempt was made to use the pulp in molding. It was all right for this purpose, but it lacked cohesiveness. The pulp dried and spread so as to make the work useless. The idea of



Fig. 265—Decorating a box with paper pulp

mixing liquid glue with the pulp was then tried, with the greatest success. In this fashion it was not difficult to mold the pulp and it dried firmly and as hard as cement.



Fig 266—A jar ornamented with paper pulp

Variations of the idea can be found by any one with ingenuity. The figures molded from the pulp can be painted, as was the figure of the little child with the candle, which was found to make a most attractive ornament for a bedroom wall (Fig. 264). The molding itself of course is work that requires some talent. But in these days there is almost sure to be

some member of the family who has a talent in this direction.

HERO'S FOUNTAIN AS A TABLE ORNAMENT

A pretty table ornament in the shape of a small automatic fountain can be constructed of materials within the reach of every Handy Man.

While the height of the jet is small, unless the apparatus is constructed on a large scale, still it makes a very attractive ornament, running, as it does, continuously.

The outside shell can be of any convenient diameter as this dimension has no effect on the result. It is divided into three horizontal compartments, *A*, *B*, and *C*, the two latter of which must be air-tight. The upper one, *A*, is open on top and on the depth of this depends the height of the jet.

A pipe *D* connects the compartments *A* and *C*. The partition which separates *B* and *C* has an opening *E* in it. In the center of this partition a circular cup-shaped depression, *F*, is formed and there extends into this cup a small pipe, *G*, which passes through the upper partition of compartment *B* and projects slightly above the upper edge of the shell. All joints should be soldered tight. The principle of operation is as follows: The opening in the pipe *G* at the point *H* is stopped up and then the upper section *A* is filled with water. This descends through the pipe

D and fills the compartment *C*; then it flows through the port *E* and fills the cup *F*.

The compartment *B* being an air pocket is under pressure equal to the head or weight of water from the top of the cup *F* to the level of the water in *A* and when the pipe *G* is opened this pressure forces the water in the cup up through the pipe, forming a jet at *H*, the water being replaced by the flow through the pipe

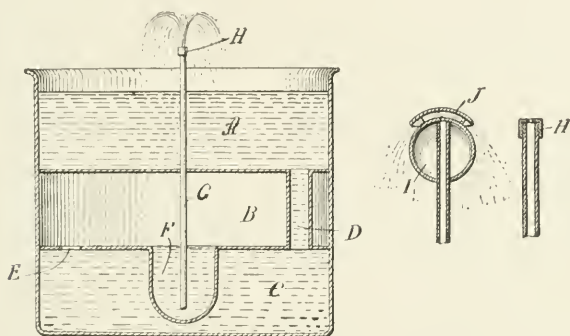

Fig. 267—A fountain for the table

D into the compartment *C* and overflowing into the cup *F*.

The pipe *G* should be about $1/16$ -inch copper pipe, smooth inside, and the opening at *H* about $1/32$ inch in diameter drilled smoothly, that is without burrs.

The best method of obtaining this latter hole is to have a small cap threaded onto the pipe *G* and the hole drilled in it. In this way holes of different sizes and shapes can be tried.

A pretty effect is secured by means of a silvered glass ball *I* attached to pipe *G* with a deflector, *J*, which gives a circular sheet of water.—21

CONVENIENT HANGER FOR THE CLOTHES CLOSET

The accompanying illustration shows a hanger, for shirtwaists and other garments, located in the upper part of a clothes closet

to utilize space that is usually wasted. The hanger is so placed that garments hung thereon will not interfere with clothing that is hung on the usual hooks. But it may be lowered wherever desired so as to provide access to the garments thereon.

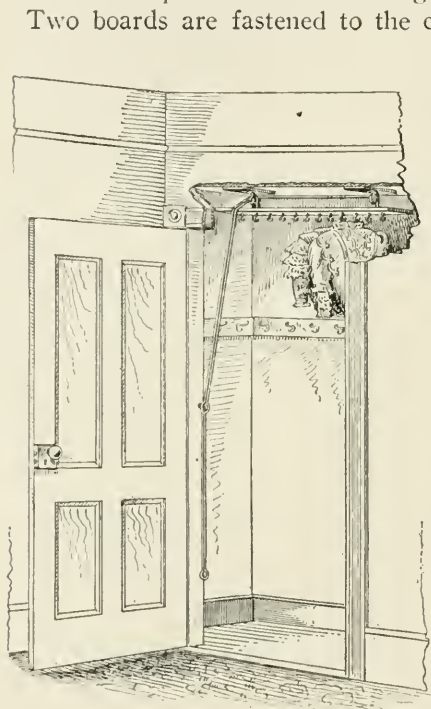

Fig. 268—Convenient hanger for the clothes closet

Two boards are fastened to the ceiling of the closet and are provided with pulleys one of which is a double pulley to receive its own cord and the cord running over the other pulley as well. The cords are secured at one end by means of screw eyes to the top of a board hanger which is provided on the under side with a row of hooks properly spaced to support the shirtwaists or other garments, one alongside the other, without crumpling them. The cords are fastened together at the opposite end and are provided with two loops for engagement with a hook fastened to the side of the door casing. One loop when caught on the hook holds the hanger in its highest position, as illustrated, while the other is used when the hanger is lowered for the purpose of hanging or removing a garment. The hanger may be raised or lowered at will by operating the cords.—40

AN IMPROVED CARPET STRETCHER

One of the things that makes carpet laying difficult is the fact

that in stretching the carpet one must drag his own weight along the floor. To overcome this difficulty the arrangement shown in Fig. 269 may be used. This consists in bracing the carpet stretcher against the opposite wall of the room in such a way that the operator can stand to one side and by depressing the brace cause the carpet to be stretched with a powerful toggle leverage. The brace must of course be adjustable so that it can be used in rooms of different sizes. It consists of two strips of wood, $1\frac{1}{2}$ inches thick, 4 inches wide, and 8 feet long. The strips are connected by means of a pair of $\frac{3}{8}$ -inch bolts which pass through holes spaced 4 inches apart along the length of the strips. In

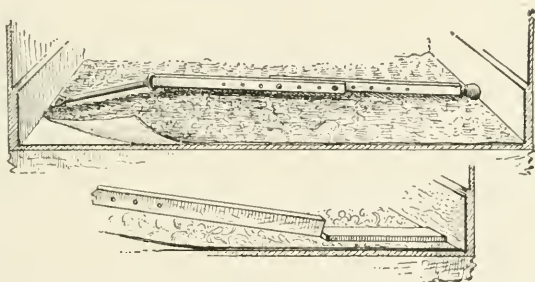

Fig. 269—Bracing the carpet stretcher against the opposite wall

order to prevent marring the baseboard at the opposite side of the room the end of the brace should be padded with cloth, as shown. In the case of a room that is too wide for this brace an extension board may be laid on the floor against the base board and the end of the brace abutted against this extension board. The manner of operating the carpet stretcher is clearly shown in Fig. 269. The carpet stretcher is so powerful that if not properly operated it will draw out the tacks from the opposite side of the room.

RAG CARPET NEEDLE

The strips of cloth for making rag carpet are usually formed into a long string or rope by stitching the ends together with cot-

ton or thread, a process not only tedious, but taking no little time. To obviate this, a handy tool, or needle, can easily be made from a small piece of clock spring, the end of an old table knife, or any thin piece of steel. Make the needle about one inch and a half long, and either turn it up at right angles to form a foot, by heating it in the fire first, or drill a hole in one end for an ordinary wood screw. In the former case, a thumb-screw clamp can be used to hold the needle to the table. The other end of the needle is to be formed with a V-shaped point, fairly sharp. Just below the point a slot is made about one-eighth of an inch wide by half an inch long, or long enough to pass the ends of the pieces of cloth through.

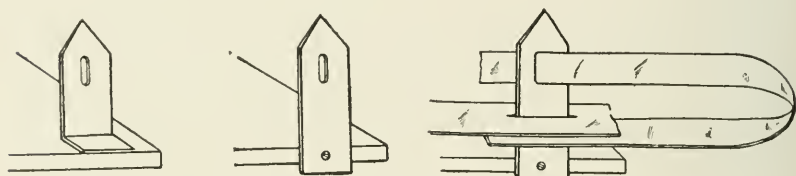

Fig. 270—Rag Carpet Needle

To sew the pieces together, which can be done very rapidly, after a little practice, press one end of a length of cloth down upon the needle until it passes the eye. Likewise, one end of another piece is pressed down upon the first. The other end of either piece is then threaded through the eye for a short distance, as shown in Fig. 270. The whole is then lifted up until the threaded end falls below the other two, when it is pulled all the way through. It will be found that these joinings are perfectly flat and satisfactory.

Two styles of clamps are shown, one with a foot, to be held to the table by means of a thumb-screw clamp, and the other with a screw attachment, to be held on the edge of the table by means of an ordinary wood screw.—3

A CHEAPLY CONSTRUCTED FIRELESS COOKER

A cheap and efficient fireless cooker was made by the writer as

follows: A box measuring $34\frac{1}{2}$ inches long, 12 inches wide, and 16 inches deep inside measure was bought from the grocer. After lining it well with newspapers lapped at the corners and tacked in place, a bed of newspapers *A* was placed on the bottom to a depth of 4 inches. The false bottom *B* was then nailed above them, and a sheet of asbestos placed upon it.

Three pieces of sheet zinc, 7 by $26\frac{1}{2}$ inches, were made into cylinders and soldered at the joint. These cylinders were then soldered to a sheet of zinc, *D*, cut to fit the false bottom, *B*, the cylinders being spaced 10 inches between centers. To facilitate the soldering of the cylinders *E* to the zinc plate *D*, small ears may be left in the cutting and bent outwardly.

Three holes the diameter of the outside of the cylinders, 10 inches between centers, were made in a board *F* $34\frac{1}{4}$ inches long and $8\frac{1}{2}$ inches wide, and nailed in place around the cylinders, the cylinders being nailed to the board *F*. A strip of asbestos was then wrapped around each cylinder and tied in place with string.

The space around the cylinders was now well packed with sawdust, *K*, and the small strips of wood, *f*, were inserted and nailed to the box to complete the shelf *F*. Three half bricks, *G*, and three enameled-ware pails 5 by $6\frac{1}{2}$ inches covered by an old feather pillow, *H*, which in turn was pressed firmly over the pails by a hinged lid, *L*, held closed by a suitable fastening, completed the cooker. To improve the appearance of the box the outside, with the exception of the bottom, was padded with paper tacked in place and covered with cretonne. Handles placed at the ends were found useful as well as ornamental. The novelty and efficiency of this cooker lies in the use of the half-bricks, *G*, which being placed around the gas burner, or on the stove with the pail resting on them, while bringing the contents of the pail to the

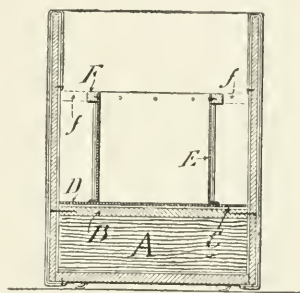

Fig. 271—Cross-section through one of the zinc cylinders

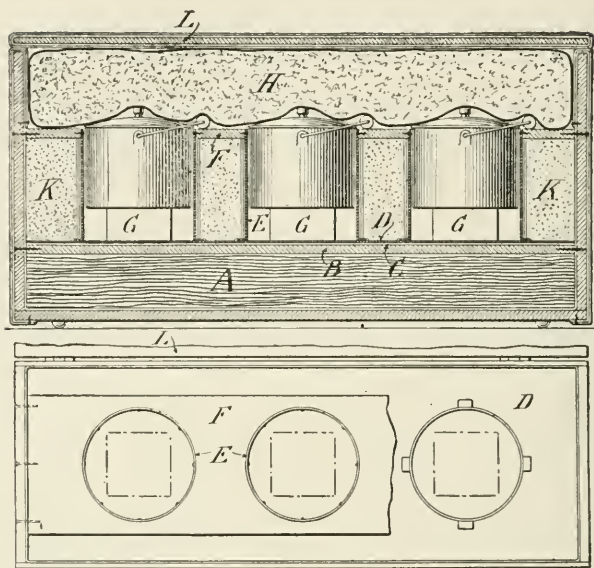

Fig. 272—Section and plan views of the fireless cooker

boiling point, absorb considerable heat (the hotter they get the better). They are then used as shown in the illustration.—90

AN ELECTRICAL FIRELESS COOKER.

The so-called “hay-stove” or fireless cooker has now become so popular and its advantages so well known that it is hardly necessary to call attention to them. One serious drawback to its general use, however, is the fact that the food to be cooked must first be heated up to the boiling point on a stove of some kind before it is placed in the cooker. This is not only inconvenient, but in warm weather it goes far to defeat one of the important objects of the fireless cooker, namely, the elimination of heat from the kitchen.

Wherever there is a supply of electric current available it is quite feasible to combine the electric heating and fireless cooker

principles in such manner that the food may be placed in the cooker cold and the current be turned on for about fifteen minutes to heat it up, for which time the cost for electric power will be only about three cents.

In its general construction such an electrical fireless cooker may be made as shown in the sectional view, where *A* is an ordinary stone crock with cover, imbedded in a suitable heat-insulating packing, *B*, such as mineral wool, and covered with a mattress, *C*, of the same material, the whole being contained in the wood box, *D*, having a hinged cover, *E*. For an average-sized cooker an ordinary four-gallon stone crock, which measures $10\frac{1}{2}$ inches in diameter inside by about the same in height, will be found to be well adapted to the purpose.

To make the electrical heating element suitable for use on a circuit of about 110 volts, procure 70 feet of bare No. 18 "30-per-cent nickel" German-silver wire. Such a piece of wire should have a resistance of about 12 ohms, so that when connected to the mains about 9 amperes will pass, and the heater will thus consume about 1,000 watts. As 70 feet of the wire will weigh only $\frac{1}{3}$ of a pound and cost but a few cents, it is advisable to buy a pound of it, so as to have a couple of extra pieces on hand to use when repairs become necessary.

To form the heating coil, first anneal the wire by heating it to a dull red (but not white) heat in a suitable fire or gas flame, and after allowing it to cool form it into a helix by winding it closely on a metallic rod $\frac{5}{16}$ inch in diameter and about 36 inches long. (See Fig. 273, *G*.) It is best to do this winding in a lathe if possible, as hand work is not only tedious, but the coil is likely to be uneven. After winding slip the helix off the rod, take hold of one end in each hand and stretch it to a length of about five feet. This will separate the individual turns of wire so that they look something like Fig. 273, *H*.

The support for the heating coil, Fig. 274, *A*, should be made of a piece of asbestos board or magnesia board $\frac{1}{4}$ inch thick and of such a diameter as to fit easily in the bottom of the crock—in this case about $10\frac{1}{4}$ inches. If the asbestos or magnesia

boards cannot be obtained, a good substitute may be found in slate, or in a disk of 1/16 inch thick sheet iron covered on top with several thickness of asbestos building paper. Then porcelain insulators, each about 1 inch in diameter by 1 inch high and having a shallow groove near its upper end, should be fastened to the base with flat-head stove bolts in the positions shown. When stretched on these insulators zigzag fashion, the heating coil will be retained in the grooves by its own elasticity. For the electrical connection to the heater use two pieces of No. 14 white asbestos-covered copper wire, each about two feet long.

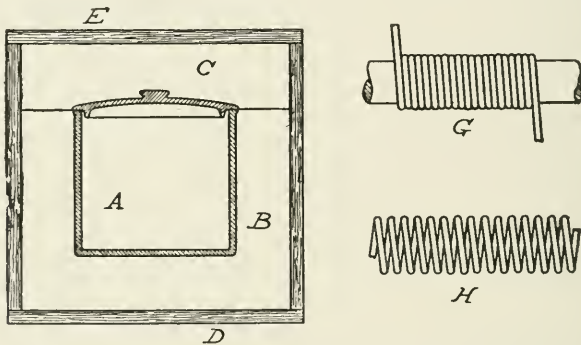

Fig. 273—Section of the electric cooker and method of making the heating coil

Attach these to the German-silver wire by twisting the ends, and tie them securely to the end insulators with wire. Place the heater in the bottom of the crock and bend the terminal wires close up against the inside of the latter and over the edge, so as to be out of the way of the cooking vessels that are to stand on the porcelains. The outer ends may be attached to a double-pole knife-switch mounted on the side of the cooker.

The electrical connections to the house circuit must be of a substantial character. Do not try to connect the cooker to a lamp socket or with small lamp cord—neither will carry the current safely. If no baseboard receptacle has been provided in the kitchen, wire all the way back to the panelboard with No. 14 rubber-

covered wire and provide a pair of inclosed 10-ampere fuses. It is well to remember that it will be necessary to move the cooker occasionally, so that it is worth while to make provision for easily disconnecting it.

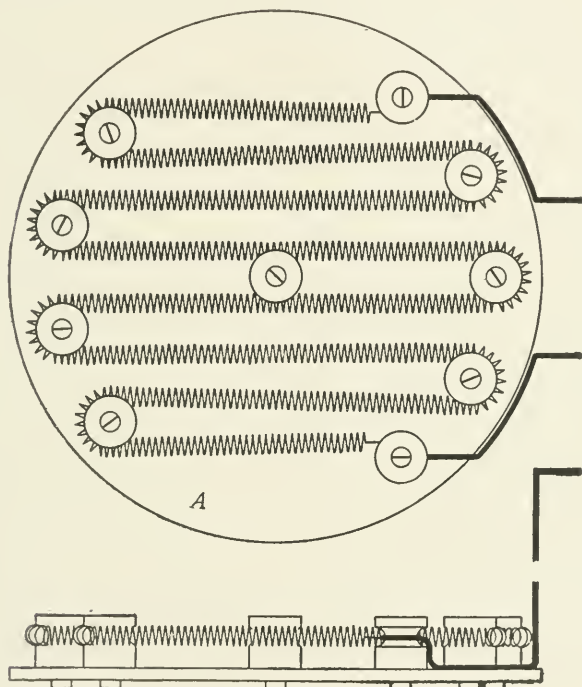

Fig. 274—Arrangement of the heating element

The operation of a cooker made as described is very simple. The prepared food is put in a covered tin vessel of suitable size and placed on the heater in the bottom of the crock, after which everything is closed up tightly. The current is then turned on for ten to twenty minutes, depending on the quantity and kind of food to be cooked, after which the cooker will keep hot for several hours. A little experience soon teaches one how long to keep the current on, and then the whole operation becomes

as easy as the boiling of an egg in the old-fashioned way. In the cooking of roast meats it is well to apply the current a second time for two or three minutes after an hour has elapsed.

No danger of fire is to be anticipated from a cooker made and installed as described, but it is almost self-evident that if one were to forget to turn off the current both the food and the heating coil would soon be destroyed, since the heat is generated very rapidly and has no means of escape. To guard against such a mishap, procure about a foot of $\frac{1}{8}$ inch brass or copper tubing and a very small whistle. Arrange the tube so that one end opens into the crock alongside of one of the connecting wires while the other end passes out through the wood case. To the outer end solder the whistle in such a manner that it will be blown by steam escaping from the crock. With this device in working order, if the current be left on too long, the steam escaping from the food will sound the alarm in good time.—95

A HOME-MADE HEAT-RETAINING BOTTLE

Within the last few years there have appeared on the market several different makes of bottles designed to keep their contents hot or cold for a day or more, but their present high cost of from five to six dollars each in quart sizes still keeps them in the class of luxuries. By following out the instructions given below, however, anybody can make for a few cents a bottle that will be a fair substitute for the more costly manufactured article.

The essential principle involved is to surround a bottle with as poor a conductor of heat as possible, and thus prolong the time that it would ordinarily take for the contents to lose their initial heat or cold. The manufactured bottles are blown double, one within the other, and a vacuum is then formed in the space between them. Since a vacuum is the best possible non-conductor of heat, the contents of the inner bottle are well insulated from the outer air, except at the neck and top. In addition to this the inner bottle is also silver-plated on the outside so as to act as a heat reflector.

Nature has not provided us with any solid substance that even

approaches a vacuum in its heat insulating qualities, but by using a sufficient thickness of loose sheep's wool, well dried, fair results can be obtained. Other substances, valuable in the order named, are woolen blankets, loose feathers, hair felt, and cotton wool.

In Fig. 275 is shown a section of a bottle intended to be portable, and therefore made as light and compact as possible. It consists of a cylinder *A* of bright tin and an outer tin box *B* having the space between them filled with the wool *C*, a part of which is sewed up into a mattress or cushion *E*. The bottle *D* must in all cases be provided with a tight rubber ring to prevent spilling the contents, and, what is equally important, to avoid moistening the wool. The bottle may be a quart milk bottle or a one or two quart fruit jar. Smaller sizes do not hold their heat long enough to be worth

while. The thickness of the wool packing must be $1\frac{1}{8}$ inches thick at the very least, and when portability is not necessary it is desirable to have a thickness of from four to six inches. In the latter cases the outer box may be made square and of wood with a hinged cover.

Made as described, a bottle of this kind can be depended upon to keep its contents reasonably hot or cold for from six hours to an entire day, depending mostly on the thickness of the packing and its composition.—95

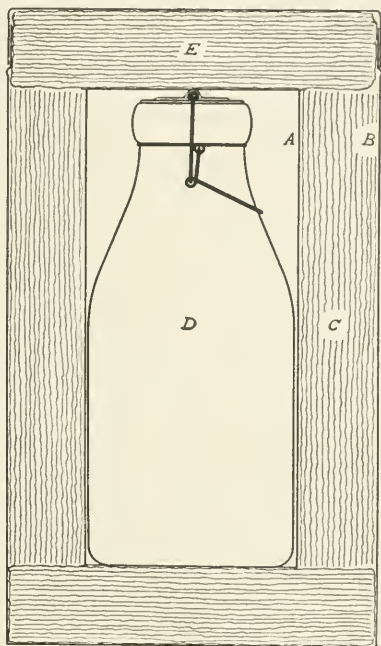

Fig. 275.—A heat retaining bottle

ICELESS REFRIGERATION

While the mad race for supremacy between the mercury and price of ice is on much comfort can be taken in the fact that there are other methods of keeping victuals cool besides that of melting ice in an ice box. If in changing from the solid to the liquid state water absorbs sufficient heat to keep an ice box cool, it is equally true that a change from the liquid to the gaseous state will result in refrigeration, provided, of course, the rate of vaporization keeps pace with the heat which enters the ice box from the outside atmosphere. Under proper conditions it is possible by this method to maintain a sufficiently low

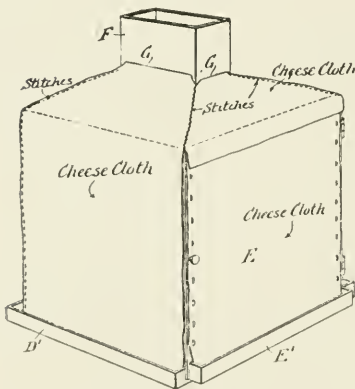

Fig. 276--Refrigerator complete with tank uncovered

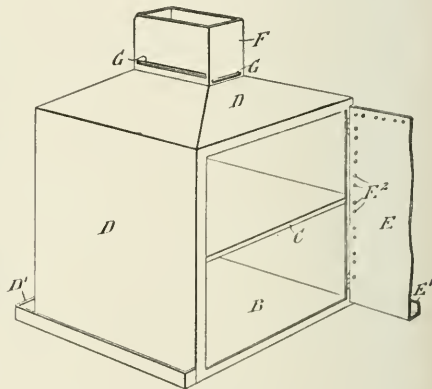

Fig. 277--Cloth removed to show the zinc box

temperature in the ice box to preserve food from rapid decay. A simple method of making such an iceless refrigerator is illustrated in Fig. 276. In Fig. 277 the cover of the water tank is removed. The box comprises a frame *A*, Fig. 278, which is built upon a wooden floor *B*. The frame *A* serves as a support for a zinc box *D*, which is fastened thereto. The water tank *F* is soldered to the top of the box, while at the bottom is a trough *D*¹. The door *E* at the front of the box has its own trough section *E*¹. Slots *G* are cut in the four sides of the tank *F* to re-

ceive the ends of a cloth cover for the box. The cover is preferably made up of several thicknesses of cheesecloth stitched together at the corners, and the ends are jammed tightly through the slots into the water tank *F*. The door *E* is provided with its own section of cheesecloth, as indicated in the illustration. In operation the water from the tank soaks into the cheesecloth and by capillary attraction and gravity passes on down to the bottom of the cloth, where any excess of water is caught in the trough. The flow of water through and over the cloth

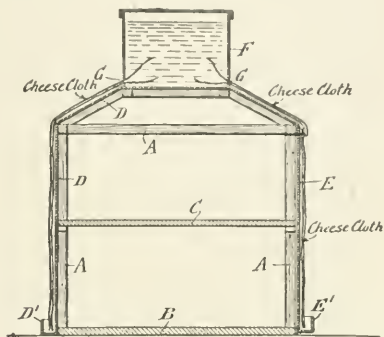

Fig. 278—Cross-sectional view of refrigerator

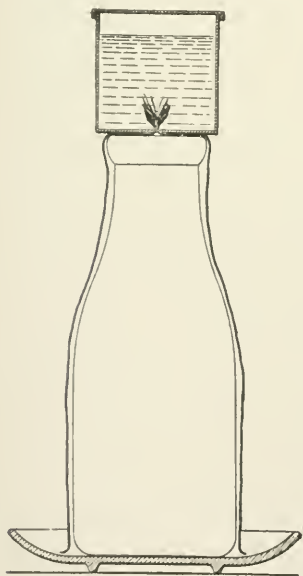

Fig. 279—How to keep a milk bottle cool

should be very slow, and may be regulated to a large extent by the tightness with which the cloth is stuffed into the slots *G*.

The box is placed on a suitable shelf supported by brackets just outside of the open window on the breeziest side of the house and out of the direct rays of the sun. It is advisable to make the box a couple of inches narrower than the window opening, so that the currents of air passing in and out of the window may have free passage all around the moist cheesecloth. As the water in the cheesecloth is evaporated it absorbs a large amount of heat, much of which is taken from the zinc box, tending to keep the food in the box cool. A modification of this idea is

shown in Fig. 279. Here the construction is adapted to cool an individual milk bottle. The cloth covering is placed directly over the bottle, and at its upper end is jammed into a slot in the bottom of the small reservoir. The milk bottle is placed in a saucer, which serves as a trough to catch the excess of water. Instead of the cheesecloth covering, the leg of a sock can be used, as this is already of cylindrical form and is well adapted to hold the moisture. In case the water from the tank does not moisten the cover sufficiently, the trough may be also filled, and the water will be drawn up therefrom by capillary attraction.—90

ELECTRIC COFFEE POT

A simple electrically heated coffee pot can be made as follows: Procure a round tin can of about two quarts capacity. This can should be about 5 inches in diameter and should be open at one end. The open end should be round and smooth, so that a wooden cover can be easily fitted into it.

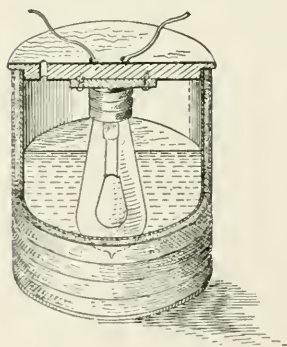

Fig. 280—An electric coffee pot

Cover the bottom and sides of the can with heavy felt, sticking it on with shellac. Put on a layer of electrician's tape over the felt, and stick a piece of fiber or cardboard on the bottom. Then give the whole outside of the coffee pot a couple of good coats of shellac. It is very important that this part of the work be well done, since if the can is not properly covered with felt, the heat generated in the coffee pot will be conducted off so quickly by the air that it will be impossible to boil water in it.

The next step is to make a cover for the can. This cover should be made from hard wood, should fit tightly, and should have a small hole in it to allow steam to escape. A standard water-proof lamp socket should be screwed to the inner side of the cover, and the leading-in wires should

be brought out through small holes drilled in the cover for that purpose. Each wire should be brought through a separate hole, so as to avoid possibilities of a short circuit; and wherever there are live metal parts care should be taken to insulate them, as it is very easy to get a short circuit where all parts are exposed to steam.

The leads from the socket should be connected to a screw plug by a suitable length of flexible lamp cord.

Screw an ordinary 32-candle-power lamp into the water-proof socket. Cover the joint with tape and shellac to keep the steam away from it.

The coffee pot is now complete, and all that is required is to fill the pot with water and coffee, put the cover on with the lamp projecting down into the pot, and screw the plug into the handiest lamp socket.—62

AN IMPROVEMENT FOR THE BROILING PAN

When broiling steak, chops or the like in a gas-range, the suet that is tried out from the fatty part invariably catches fire. As a

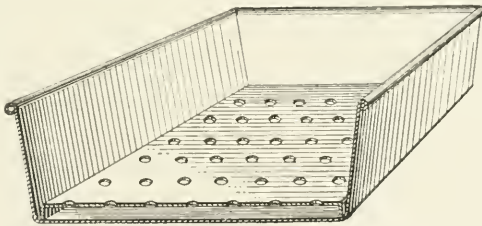

Fig. 281—Double-bottomed broiling pan

rule the fat is overheated and burns fiercely, and many efforts to put it out, when taken from the oven, fail.

The accompanying illustration shows a very simple way to avoid this. In the pan used for broiling is placed a perforated false bottom, made out of black iron of any thickness. The edges are turned down, say one quarter of an inch, forming supports for the bottom. This false bottom should be nearly of the same size as the pan. On large pans, of course, the bottom should

be braced with strips of iron, to prevent warping from the heat.

In service the suet melts, and runs down through the perforations to the bottom of the pan. No matter how hot the fire, the suet will not catch fire, as it is protected from the flames by the perforated bottom which acts like the screen of a miner's lamp. The bottom can easily be removed and cleaned and the suet in the pan be emptied out.—5

PATCH FOR KITCHEN BOILERS

When by reason of rust, corrosion, or any other agency, the shell of the kitchen boiler is punctured, the problem of stopping the leak should not cause Handy Man any worry. A little device

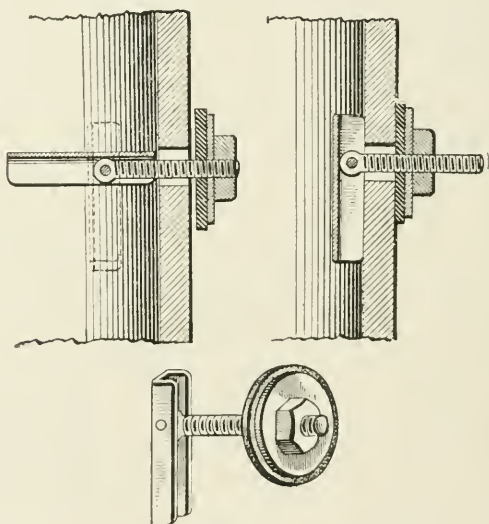

Fig. 282—Patch for the kitchen boiler

like that shown above can readily be made, and it will effectually and permanently close the hole. It consists of a square-headed brass machine screw, with head flattened and pierced to receive a pin, whereby it is pivoted between the walls of a channel-

shaped brass bearing piece. The opposite end of the screw is fitted with a leather washer, a broad metal washer slightly curved to fit the contour of the boiler, and a nut.

The illustration shows how the device is applied. The puncture is enlarged sufficiently to admit the bearing piece. The latter is swung into alinement with the screw and passed through the hole. The overhanging part of the bearing screw should be longer, and hence heavier, than the other portion, so as to make the bearing piece swing to a vertical position as soon as it clears the inner surface of the boiler shell. The screw will then be retained by the bearing piece, and the nut can be screwed up to clamp the leather against the outer surface of the shell. This done the projecting part of the screw can be cut or filed off.—27.

HOW TO MEND A CAST-IRON BOILER

An overheated cast-iron steam boiler, with low water level, is very easily cracked when cold water is let in suddenly. The leak caused thereby will sometimes put out the fire and render the boiler useless.

The leak is very easily mended in the following manner: First cool off the boiler by putting on some fresh coal, and leaving the fire door open until the steam pressure has gone down. Then unscrew the safety valve or any other fitting on top of the boiler. Through the opening pour in about half a package of ordinary oatmeal. Bran will also serve the purpose.

Then replace the safety valve, and open the feed-water cock, and fill up the boiler with water above the crack. This will stir up the oatmeal. As the water runs out through the crack, it carries particles of the oatmeal with it, which will lodge in the crack and soon stop the leak.

Now close the feed door, and draw up the fire, and the steam generated will force these particles of oatmeal through the crack, which soon will rust and bake there, making it nearly as hard as the cast iron itself, and it will withstand almost any steam pressure. In fact, it would be impossible for the steam to blow it out; it simply gets tighter and tighter, making the boiler nearly

as good as before. The writer has known boilers mended in this way to last several years.

When the boiler has thus been mended, open partly the feed-water cock, thereby filling up the boiler with water. At the same time draw off the water from the boiler through the drain cock until all the surplus oatmeal is drawn off and the water becomes clear, maintaining at all times the normal water level.

If the surplus oatmeal is not drawn off, it will cause the boiler to foam and blow off through the safety valve, raising more or less disturbance for a long time to come.—5

MENDING CAST-IRON BOILERS, RADIATORS, AND THE LIKE

The writer has seen people try to solder up a leak in a cast-iron radiator; but as a rule, after a short time, the fault needs mending again. A much better way is to plug the leak with

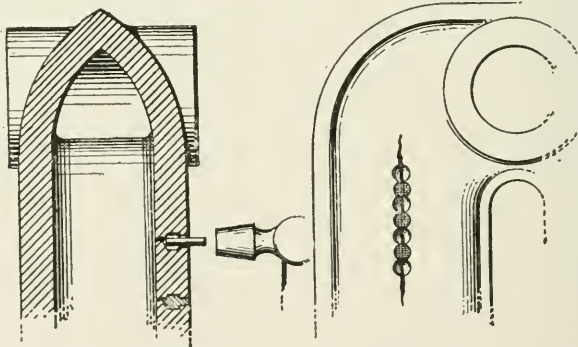

Fig. 283—Plugging a hole with copper wire

Fig. 284—Stopping up a crack with copper plugs

copper. The accompanying drawings show how easily this is done, making a permanent job. When the radiator is cold, drill a small hole, say $\frac{1}{8}$ inch diameter, with an ordinary drill; then with another drill, preferably flat, ground a little out of center, drill into the same hole a little deeper. It will be seen that the

last drill has made the hole somewhat larger at the bottom. Care should be taken not to drill in too deep or through, as there will be nothing to rivet against.

Now take a piece of copper wire, anneal it, and file or point the end that goes into the hole, so that it will fit the bottom of the same. Cut it off about $\frac{3}{16}$ inch longer than the depth of the hole. Then with a small hammer drive it into the hole, and keep on hammering with quick blows until the whole length is driven in and riveted on the outside. The soft copper wire will then fill the enlarged hole at the bottom, and form a head inside the cast-iron.

As the radiator gets hot, the copper will expand and make the hole absolutely steam-tight. If a crack is to be fixed, then a number of holes are drilled at a distance apart that equals nearly the diameter of the copper wire to be used. Then these holes are plugged, and another set of holes are drilled between the first ones, cutting all the cast iron away and part of the copper plugs as well. Then these holes are plugged as before described. It will now be seen that practically a strip of copper is dovetailed into the cast iron, which will not work loose or come out, and when hot will expand and withstand almost any steam pressure. This operation can also be used in riveting one or more pieces of metal together, especially where a blind rivet is desired. Instead of copper, soft iron or steel may be used, as the rivets need not be steam-tight.—5

GAS FIRE-LIGHTING APPARATUS

A simple and quick method of lighting a fire without the use of paper, wood, or charcoal is of great convenience at times. This object can be obtained by the use of the arrangement illustrated herewith. It consists of material which can be procured at any plumber's and costs very little. Three $\frac{3}{8}$ -inch pipe nipples *A*, three 1 inch nipples *B*, a standard hose connection *C*, one $\frac{3}{8}$ -inch plug *D*, and three standard $\frac{3}{8} \times 1$ inch air mixers or tees *E*, such as are usually used in vulcanizers, form a list of the fittings necessary.

These tees *E* are $\frac{3}{8}$ inch on the run and 1 inch on the outlet. The outlet end is closed back of the thread except for a small hole *F* of about $\frac{1}{32}$ inch diameter, and they have $\frac{5}{16}$ inch air holes *G* on both sides. With the 1 inch nipples they make first-class Bunsen burners.

The fittings are arranged as shown in Fig. 285, and are supported by a $\frac{3}{4} \times \frac{1}{8}$ inch flat iron stand *HI*, made high enough to permit the entire apparatus to be placed in the ashpit of the range and still kept as close as possible to the grate bars.

The number of burners must of course be made to suit each

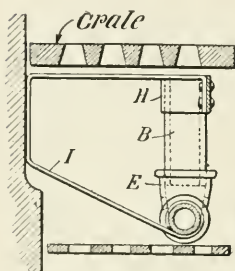

Fig. 285—Section through range showing lighter in place

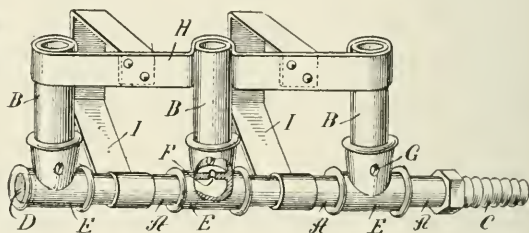

Fig. 286—A general view of the fire lighter

grate, but for the ordinary case, two or three will be sufficient. To light the fire, the burners are placed in the ashpit, close to the grates, and with the range full of coal they are lighted. The coal catches fire very quickly, and the burner may be removed. Of course, the attachment between the burner and the fixture should be by rubber hose, and the entire apparatus occupies such small space that it can be easily stowed away in a small space.—78

REPLACING A FIREPOT

People having homes equipped with a fireplace heater have probably found that after a few years' service their heater loses its efficiency as a heat producer. In the case of a heater having an iron firepot, this is usually due to the iron being burnt out, causing it to lose its heat-retaining qualities.

To replace the old firepot with a new one, it is necessary to put in a new ring to hold the pot in place, due to the warping of the old ring from heat.

To have a stove repairer do this work is expensive, as the practice is to take the heater apart in sections by removing the bolts *A* (Fig. 287), to admit the ring *B*, which is of such dimensions as to prohibit its admission in front of heater. This ring is provided with recesses to engage the projections or pins *C* on the under side of firepot sections *D*.

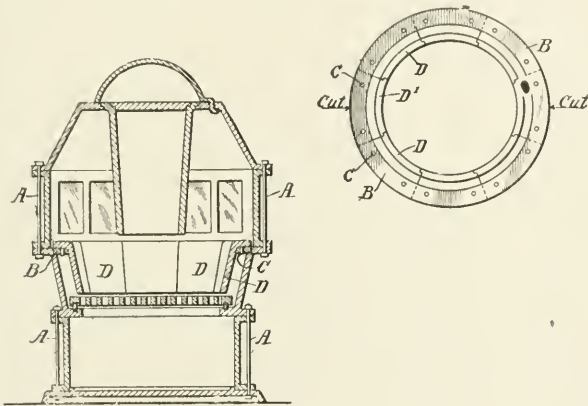

Fig. 287—Replacing a firepot

The writer has found that by cutting through the ring *B*, as shown in the bottom plan view, so as to break joints with the firepot sections *D*, the two sections of the ring may be set in place through the door openings, and the firepot sections set in their respective positions one after the other, beginning with the section *D*, which bridges the breach in ring.

This method has its advantages over the old way in giving an equally strong construction, and being far more economical, as it does not necessitate the removal of the heater.—3

LET THE CLOCK OPEN THE FURNACE DRAFTS

Most furnaces are nowadays arranged so that the drafts can be operated from the living rooms above, but still require the

personal attention of some shivering member of the household, before dawn on cold winter mornings, if the house is to be comfortably warm by breakfast time. Undoubtedly much irritability and fatigue, if not actual sickness, can be traced to the strain of this early rising under the most unfavorable conditions.

It is a very simple matter, which anyone could undertake



Fig. 288—Drafts closed, alarm set

successfully, to so arrange an alarm clock that it will control all the drafts and dampers and open them at any desired time in the morning. If it is absolutely necessary to shake down the fire, remove ashes, and add fresh fuel, the problem is a much more difficult one, far beyond the strength or capacity of the dutiful alarm clock. Most furnaces, however, can, with a little experience, be so left the night before that on opening the drafts in the morning they will burn up rapidly and soon have the house at a comfortable temperature. Fresh fuel, unless absolutely neces-

sary, actually delays the heating up of the house and is much better added later, when the demand for heat is not so urgent.

The apparatus comprises a base-board fitted with two screw eyes, through which the usual chains are passed. Hinged to the board with a pair of staples is a U-shaped lever, with one arm about 5 inches long and the other just long enough to catch the chain. The lever is located far enough above the screw eyes to

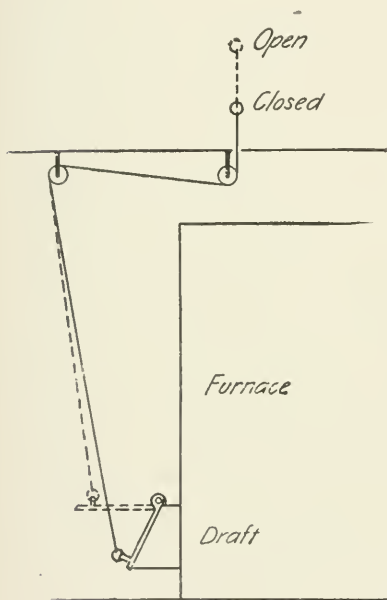

Fig. 289—Drafts directly connected to alarm key

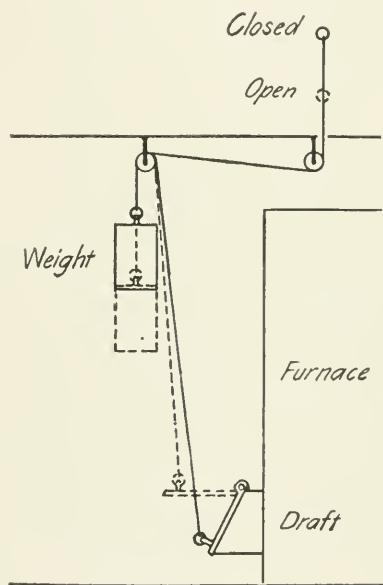

Fig. 290—Arrangement with counterweight to open drafts

allow for the proper opening and closing of the drafts. The screw eyes are not placed directly under the short arm of the lever, but on either side, so as to prevent the chains from kinking and catching on the hooks when they are released by the lever.

The alarm clock, which furnishes the brains for this apparatus, may be supported on a long hook or nail, and others bearing

against the feet on each side will prevent it from swinging side-wise. Some people, who desire unbroken dreams, will turn the gong or bell upside down to put it out of the reach of the fiendishly energetic clapper, but that is an unimportant detail which may be left to personal taste and preference.

The clock, intended for a hard physical job like this, must



Fig. 291—Chains released, drafts open

have the alarm winding key so arranged that it unwinds when the alarm "goes off." There are a number of clocks on the market of different shapes and sizes which are made with this important feature.

To prevent chafing of the cord, unscrew this winding key and slip on, back of it, a thick cardboard washer. Then connect the key and wire lever with a piece of cord and the contrivance is ready for operation. After setting the clock, the cord should be wound onto the key in winding the alarm. Then the chains are

hung in place on the lever. When the alarm "goes off" the lever turns on its pivot, releasing the chains and permitting the usual weight to drop and thereby open the drafts and damper. If the furnace is not arranged with a weight for operating the draft the chains may be connected directly to the key by a cord which will be wound up on the key as the alarm goes off.—98

MILK TESTING WITHOUT APPARATUS

The following process for the detection of added water or of skimmed milk in ordinary milk is more accurate than the simple use of the lactodensimeter without the creamometer check.



Fig. 292—Simple method of testing milk

The whole test can be made in five minutes. The result does not show whether the adulteration consists in the addition of water or in the subtraction of cream, but as a rule this matters little to the consumer. What he wants to know is whether or not he has what he has paid for.

The suspected milk is stirred with a spoon, in order to disseminate into the whole liquid the cream which may have come to the surface. Then one volume of milk is poured into fifty volumes of water. (One fluid ounce to two and a half pints.) A candle is lighted in a dark room. The experimenter takes an ordinary drinking glass with a tolerably flat and even bottom, and holds it right above the candle, at a distance of about one foot from it, so as to be able to see the flame of the candle through the bottom of the glass. He then pours slowly the diluted milk into the glass. (See the accompanying figure.)

The flame becomes less and less bright as the level of the liquid rises into the glass. The flame is soon reduced to a dull white spot. A little more liquid, slowly added so as to avoid pouring an excess, and the flame becomes absolutely invisible. All that remains to be done is to measure the height of the liquid in the glass, this being most conveniently ascertained by dipping into it a strip of pasteboard and then measuring the wet part. It should measure not over one inch if the milk is pure. With good quality milk, diluted and tested as stated, the depth will be about $\frac{7}{8}$ of an inch before the flame is lost to view. A mixture of one volume of milk and a half a volume of water should show a depth of $1\frac{1}{2}$ inches. A depth of 2 inches indicates either partially skimmed milk or a mixture of one volume of good milk with one of water, and so on.

The reader has already understood that the process is based upon the close relation between the opacity of milk and the number of fatty corpuscles contained in it. Both skimming and the adding of water work in the same direction, namely, to decrease the opacity of milk. The same cannot be said of the density. Skimming increases it, adding water decreases it: and the common test, which consists in the mere introduction of the lacto-

densimeter in milk, is worthless, as a skimmed milk may have a normal density if care has been taken to pour into it a certain amount of water. Density should be taken before and after skimming, and the percentage of cream should be determined with the creamometer. Thus applied, the density test requires a lacto-densimeter, a thermometer, and a creamometer, and the test requires twenty-four hours, while the result is not much more accurate than the opacity test just described.—58

SIMPLE METHOD OF PULLING A CORK

If you own a corkscrew of the kind illustrated, you can easily remove the tightest cork without fear of soiling your clothes. After turning the screw well into the cork, place the lip of the

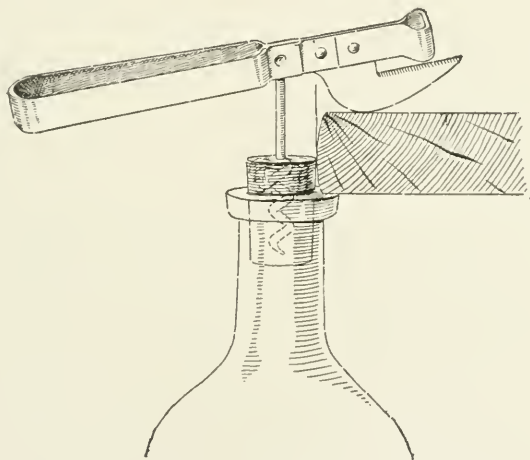

Fig. 293—Simple method of pulling a cork

bottle under the edge of a table or shelf, then with the upper surface of the table as a rest, lift up on the handle of the implement, and the cork will follow smoothly.—33

WATERPROOF MATCHES

Perhaps some of your readers would be interested to know that I have found a simple, inexpensive way to waterproof matches.

Into some melted paraffine (care being taken that it was as cool as possible) I dipped a few ordinary parlor matches. After withdrawing them and allowing them to cool it was found that they scratched almost as easily as before being coated with the wax. Several were held under water for six or seven hours and all of them lighted as easily as before immersion. When the match is scratched the paraffine is first rubbed off and the match lights in the usual way.

Matches treated as above would be very useful on camping or canoeing trips, as they do not absorb moisture. Since more rubbing is required to light them than the ordinary match, it would be practically impossible to set them on fire by accidentally dropping them.—2

UNSCREWING A JAR TOP

When recently called upon to unscrew a jar cover that resisted all other efforts to loosen it, the writer bethought himself of the rope and lever pipe wrench. (Described on page 74.) A length of strong twine was procured, and coiled double around the cover. Through the loop in the end of the doubled twine, a



Fig. 294—Unscrewing a tight jar top

stick of wood was inserted. Then with the thumb of the left hand pressing lightly against the twine to prevent it from slipping, it was an easy matter to pry open the cover with the right hand in the manner illustrated in the accompanying photograph.—89

AN IMPROVISED SHOE STRETCHER

Nearly every person, at some time or other, has wished he could stretch a shoe which at a particular point pinched the foot or irritated a corn. It is not necessary to go to a shoemaker to have the leather stretched. It can easily be done at home by means of a shoe tree of suitable form upon which an enlargement is formed at the necessary point. The enlargement must adhere firmly to the tree and must be of such a nature that it can be easily molded, and that it will not become detached from the tree when the latter is forced into the shoe. A material answering

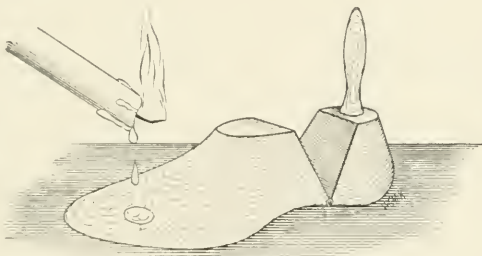

Fig. 295—An improvised shoe stretcher

all these requirements is ordinary candle wax. Sealing wax might be used but the candle wax is preferable, as it will not injure the tree, and may be more easily manipulated. The enlargement is formed by dripping a suitable quantity of the melted wax upon the tree at the desired point, and molding the resulting excrescence into proper shape while the wax is plastic. It adheres to the tree with remarkable and unexpected tenacity, and owing to its waxy nature tends to slip easily into the shoe with the tree. The shoe can be slightly moistened at the troublesome part to facilitate the stretching action.—10

HOW TO MEND A HAMMOCK OR FISH NET

It is safe to state that not one per cent of persons using a hammock or handling a fish net know how to mend them should they get torn or damaged in any way.

Whether the tear is a large or small one, the meshes or small squares of which the net is made must be cut out, until a symmetrical figure is made, as shown in Fig. 296; i. e., there must be a single square or mesh and a double one on opposite sides of the tear.

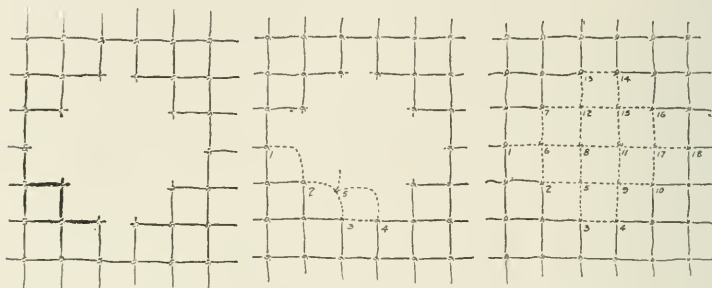

Fig. 296—How to repair a hammock or fish net

Fig. 296 also shows the commencement of the mend and the tear completely mended.

Always commence in the middle of the double mesh, and end in the opposite one. Each successive stitch and knot is numbered in the illustration from 1 to 18.

The knots are formed by pinching the meshes, as at 5, for instance, into a loop, as shown in Fig. 297 at *A*. Then threading the cord through the loop, a knot is made, either a flat or true lover's knot, as shown at *B*, or better still a fisherman's bend knot, as shown at *C*. The latter is not only more easily made, since it only passes through the eye once, but it will not slip so easily.

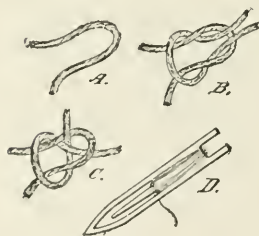

Fig. 297—How to knot the cord

If the tear is a large one, it is well to make a needle, as shown at *D*, which is made from a piece of thin wood, about 5 or 6 inches long by $\frac{3}{4}$ of an inch wide, cut out as shown. The cord or twine is wrapped around this needle, and as the stitches and knots are being made, is unwound.—3

MENDING A CRACKED BOTTLE

A very neat way to mend a piece of cracked glassware with sodium silicate or water-glass came to the writer's notice some weeks ago. A cut glass decanter which the owner valued very highly had a bad crack running irregularly around the bottom and partly up the side. In addition to preventing its use, it rendered it unsightly.

To remove all appearance of the crack, the decanter was warmed slowly and then sealed with its own ground stopper. The water-glass was then applied with a broad brush on the outside

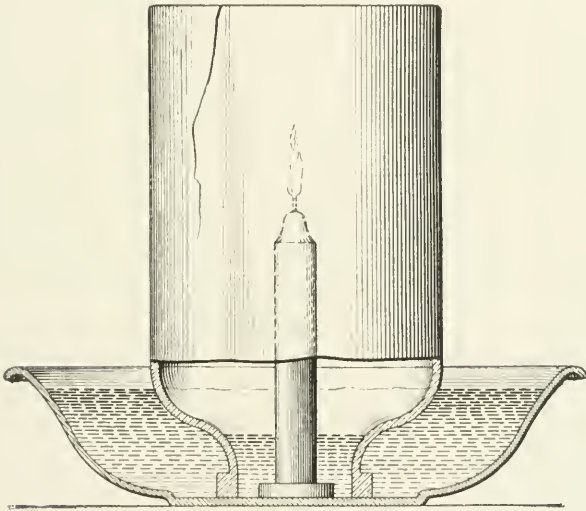

Fig. 298—Mending a cracked bottle

of the crack, and as the air cooled inside the external pressure forced it into the crack, which completely disappeared and was rendered perfectly water tight to cold water at least.

Since seeing the above the writer has tried the same operation

with success on a wide-mouthed jar, but obtained a much better vacuum and therefore better results without heating the jar.

A deep basin was procured, and in the center a candle was arranged, as shown in Fig. 298. The basin was then filled with water and the cracked jar inverted over the lighted candle; as the air in the jar was consumed by the candle, it was slowly lowered into the water which effectively sealed it. The water-glass was then applied as in the previous operation and the whole left to harden. The water-glass took six to eight hours to set and then the outside of the bottle or jar was washed with a cloth dipped in hot water to remove all superfluous water glass.—21

A TIN CAN LEADER

A friend of mine who hates to see anything go to waste has found an excellent use for old tin cans. The rain pipes or leaders of his house are all home-made, and built up of tomato cans.

He claims that they are much more satisfactory than the ordinary galvanized iron leader, for the reason that they were thickly coated with paint on the inside as they were built up can by can. The first step in the operation was to remove the top and bottom of each can. The solder was melted off by placing the cans on a hot stove. After the tops and bottoms dropped off, one end of each can was expanded slightly so as to receive the end of the next can, which was fitted in, to a depth of about a quarter of an inch. Then they were soldered together and,

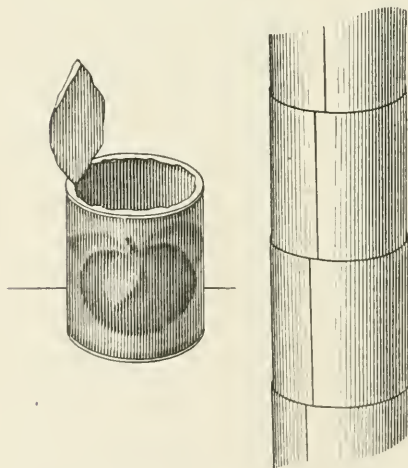

Fig. 299—A leader made of old tin cans

receive the end of the next can, which was fitted in, to a depth of about a quarter of an inch. Then they were soldered together and,

as an extra precaution, the longitudinal seam of each was resoldered so as to close any leak that may have been sprung during the process of removing the top and bottom of the can. To increase the strength of the leader the cans were so arranged that the longitudinal seams of the successive sections were staggered as shown in the illustration so as to form a symmetrical and regular spiral running around the leader. Each can as it was soldered to the leader was painted on the inside wall with a thick coat of paint, special attention being given to the joints. After the leader was completed the outside also was protected with several coats of paint.—55

EJECTOR MADE OUT OF PIPE FITTINGS

A simple ejector may be made out of ordinary pipe fittings, which will compare very favorably with some of the ejectors on the market. It may be used in draining a flooded cellar, in which case it may be attached to the ordinary water faucet for motive agent. It can also be used for emptying cisterns or in excavations for new work where water is struck. (Of course, in this case, steam will be used as the motive agent.)

Some time ago the writer was engaged in building a reservoir, and at a depth of 15 feet a spring of water was struck. Having no means at hand to get the water out of the excavation, an ejector was made out of some old pipe fittings. Four such ejectors kept the water level down while the work was being done. One of these ejectors worked night and day for nearly three weeks until completely worn out owing to the fact that a great amount of sand and gravel was carried through.

These ejectors can be duplicated as follows: First take a $1\frac{1}{4}$ by 6-inch nipple; screw on each end of the same any kind of fitting so as to preserve the threads. Heat the nipple in the middle to a white heat. Then swedge down until the outside diameter is about $\frac{3}{4}$ inch. When cold remove the fittings, and the cone is made. (See *A*, Fig. 300.) Now take a $\frac{1}{2}$ -inch pipe, heat one end to a welding heat, and swedge down to a long point. A $\frac{3}{16}$ rod may be inserted in the end to give the hole the right dimension, as it

may be drilled out afterward. When cold, thread the pipe about 4 inches and screw on a jam nut *B*. On the "rim" of a 1¼-inch tee attach the cone above described and then a 1¼-inch elbow into which screw a close nipple. On the other end of the nipple screw another elbow, forming a kind of step or stop. To this elbow may be attached either a hose or a pipe to carry off the

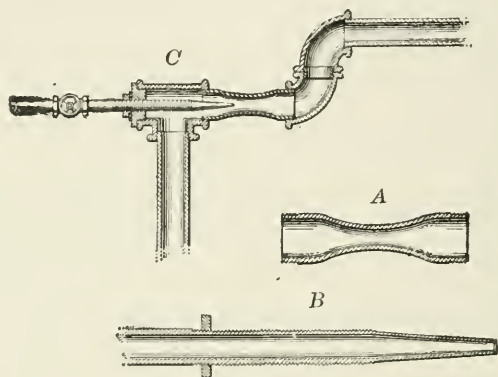

Fig. 300—This ejector can be used for draining flooded cellars

water. On the opposite end of the tee attach a reducing bushing, into which insert the nozzle shown at *C*. Care should be taken to get the nozzle in perfect alinement with the cone, and when in proper place, screw up the jam nut with some packing behind it, to make it air tight. In the other opening of the tee attach a pipe or a very heavy hose, preferably "ironclad," as the suction will have a tendency to close it up.—5

HOME-MADE VACUUM CLEANER

The installation of a vacuum cleaning system in private houses entails at present a considerable expense, as it includes the purchase and maintenance of a gasoline engine and vacuum pump.

If the latter two machines were eliminated, and a simple method of obtaining the required vacuum devised, this great labor-saving device would be much more in evidence, even in homes of moderate size.

This object can be realized by use of the ejector or ordinary barometric condenser used in connection with the city water supply *through* a tank.

The entire arrangement can be built at the rear of the dwelling, and does not take up more room than an ordinary leader pipe.

The illustration shows the arrangement of the device. *A* is an ordinary hose nozzle 12 inches long, with thread for a 3-inch iron pipe on large end and tapped for a $\frac{1}{2}$ -inch pipe on the smaller end.

By means of the nipple *G* it is connected to a 3 by $\frac{3}{4}$ -inch tee, which is bushed on the opposite end to 1 inch. This bushing has a 1-inch pipe *D* extending from the inside and ending as shown in the cut just inside of the nozzle. The other end of *D* protrudes through the bushing *F*, and is then run as afterward described. The smaller end of the nozzle carries a $\frac{1}{2}$ -inch pipe *H*, which forms the down leg of the ejector. The apparatus is placed so that the point *K* is at least 34 feet above the cellar, forming the barometric column. The pipe *B* is connected with the water supply, preferably a tank with a float valve to regulate the flow.

The pipe *H* is carried down to a seal pot *M* situated in the cellar. This can be made of a barrel with an overflow to the sewer, as shown at *L*.

The pipe *C* is carried to a vacuum reservoir, which can be situated either in cellar or attic, preferably the latter, as it means a

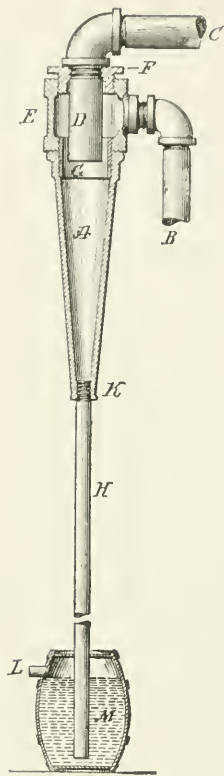

Fig. 301—Home-made vacuum cleaner

saving in piping and less joints to provide chance of leaks. This pipe is connected to the top of the reservoir, and the service pipe to the various rooms also comes from the upper end, but extends to within 12 inches of the bottom.

The service pipe has a connection for rubber hose, with a valve at each floor.

In order to obtain the required vacuum, all that is necessary is to turn on the water in the pipe *B*, when the descending column in *H* causes a partial vacuum in the reservoir and in the service pipes.

Care must be taken that all joints are made perfectly airtight in service pipes and in *C*.

The reservoir must also be airtight. It can be made of a kitchen boiler with a small handhole cut in the bottom to remove dust which collects within.

The ejector can be placed outside without danger of freezing if precaution is taken to break the vacuum when through using, thereby emptying the down leg of all water.

The down leg need not be straight if the first bend is at least 10 feet from the nozzle.

This device is not intended to supply a vacuum cleaning system for large buildings, but rather for private dwellings, and can be put up by anyone accustomed to handling pipe and competent to make good tight joints.

The pressure of water in the pipe *B* has no effect on the amount of vacuum obtainable. This depends on the column of water in the pipe *H*, which, as stated, must be at least 34 feet from *K* to *L*. This distance corresponds to the height of the barometer, or in other words, to the weight of the atmosphere. The best and most economical method of controlling the water supply is to place a tank, similar to the ordinary bathroom tank, above the apparatus and control the amount of water through a valve. The tank would get its supply from the house mains through a float-operated valve.

The apparatus is meant to supply a small private dwelling where not more than one or two openings would be in use simulta-

neously, and if required for a larger installation must be increased in size.

The nozzle *A* is a standard size nozzle and can be used if desired for larger installations by changing the bushing *B* to correspond to the increased size of the pipe *C* and using the proper opening at *B*. The pipe *H* when increased must be attached to the nozzle by means of a coupling which in turn is screwed on the outside of the nozzle, the latter being turned and threaded to suit. The nozzle described has a $\frac{3}{4}$ -inch hole at this point and can stand being bored to 1 inch, as the metal is pretty heavy.

The reservoir mentioned is not absolutely necessary. Most of the dust is carried over and goes down with the water and only the larger particles will drop in the reservoir. If the latter is omitted, an opening must be left in the lowest part of the pipe *C* through which this dust is removed.

The efficiency of the apparatus depends in the first place on the joints in all pipes being absolutely airtight. If pipe with good threads, fitting tightly, is used and made up with red lead in a proper manner, airtight joints may be expected. If it is necessary to make a bend in the pipe *H* at a point 10 feet below *K*, 45-degree ells should be used to make it as gradual as possible. In figuring out the size of the pipe necessary for any size of machine the starting point must be the sum of the areas of openings in use. This will give the area of the pipe *C*. The seal pot *M* can if desired be dispensed with if the pipe *H* is connected to the waste water connection. The dimensions of all pipes are inside. This holds good in all cases up to 14 inches when outside diameter is usually given.

The quantity of water will depend of course on the size of the machine. The following formula will be found accurate enough for all purposes:

$$g = 28 \sqrt{d^5}$$

g = gallons of water per minute and *d* = diameter of pipe *H* in inches. The amount of vacuum necessary for ordinary cleaning purposes should not be less than 15 inches, but for light work such

as walls, hardwood floors, etc., satisfactory results can be obtained with 8 to 10 inches. The higher figures are necessary where heavy rugs, carpets, and similar articles are to be cleaned.

The cleaning implements are far too numerous in design to describe, and can be procured on the market much cheaper than they can be made at home.

As regards mechanical efficiency this apparatus will create sufficient vacuum to do all necessary cleaning, but it has a fixed volume, therefore its volumetric efficiency is less. The apparatus is intended not to supply a cleaning system for hotels, clubs, churches, and buildings of such a character, but is thoroughly capable of cleaning private dwellings. In a pump plant, for instance, its cleaning power can be increased by running the pump at a greater speed and thereby taking care of a larger number of openings, of course up to a certain point. In the water system nothing is gained by increasing the flow of water in the pipe *B*. Therefore, if the capacity of this apparatus is to be increased the only method of doing so is to increase the size of the pipe *C* and all other fittings accordingly. For large installations this would mean a considerable increase and therefore render the apparatus impracticable.—21

ANTI-FREEZING OUTSIDE FAUCET

It is at times convenient to be able to use an outside faucet in winter as well as in warm weather. To do this change the location of the stopcock, which is always placed just inside the cellar wall, from the dotted position *A* to the position shown by full lines. Then make an extension handle out of a piece of $\frac{1}{2}$ -inch pipe *B*. After first cutting a thread on both ends, slot one end to receive the T handle *C* of the stopcock. The other end of this pipe should be slotted, or a hole drilled through it large enough to receive a piece of $\frac{1}{8}$ -inch gas pipe *E* or a piece of iron of about the same diameter (a 20-penny wire nail will answer). Now screw on a gas cap so that it presses tightly against this cross-piece and holds it in place. An extra hole must be drilled through the brick wall for the extended handle. For this make a drill

out of a piece of gas or water pipe of the same diameter as the handle, having teeth filed in the end. Pass the handle through

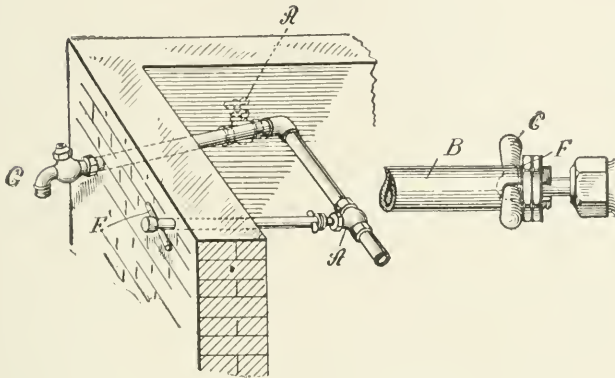

Fig. 302—Anti-freezing outside faucet

the hole in the foundation and secure it to stopcock *C* by two locknuts *F*, leaving a little play so as not to bring any strain on the stem. If locknuts are not handy wrap a few turns of wire around the end of pipe after slipping it over the T handle.

Of course the hose faucet must always be left open, and the best way to insure this is to remove the handle and working parts, and cap the stem hole by placing under the stuffing cap a piece of tin with a leather washer under it, or take off the faucet and put on an elbow.

Be sure that the pipe slants downward from *A* to *G* or the water will not run off when the stopcock is closed.

The best kind of stopcock to use is the compression type, as it works more easily than the ground seat kind and does not become leaky as soon.—82

THE HOSE REEL ON A HYDRANT

The hose reel illustrated herewith is arranged to have the hose always connected to the hydrant so that it may be reeled and

unreeled to any extent desired, the surplus length of hose remaining on the reel. The writer has not tried out this scheme but merely offers it to the Handy Man as a suggestion. The details

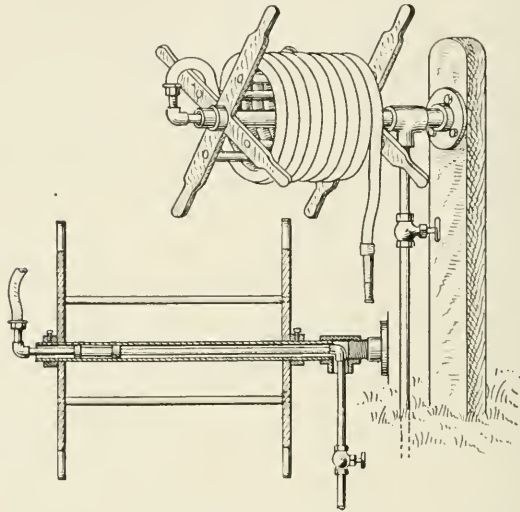

Fig. 303—The hose on the reel is permanently connected to the hydrant

of the construction need little explanation as they are clearly shown in Fig. 303. The reel is mounted to revolve on a horizontal pipe. The hydrant pipe passes through the horizontal pipe and is connected by a swivel joint with another pipe attached to the hose. This provides a permanent connection between the hydrant and the hose which is in no way interfered with by revolving the reel.—71

A HOME-MADE LAWN SPRINKLER

The accompanying illustrations show how a lawn sprinkler can be made. First take a one-half-inch street ell and drill a hole through it. Into this drive from the inside a large wire nail, and

solder the same. This nail is to stick into the ground and hold the sprinkler in an upright position. Now screw on the male end of the ell an ordinary pipe coupling, and on the female end solder an ordinary half-inch hose coupling, so as to connect to the garden hose.

Now take a block of end wood and cut out a cone-shaped recess. Make a round plug of wood, and shape the end a little smaller than the recess in the block. Take a small thin piece of brass about $1\frac{1}{4}$ inch in diameter and anneal same. Place this brass disk on top of block and with a few quick blows with a hammer drive the plug down into the recess in the block and the brass disk will assume the shape of the recess in the block. Now drill four holes, say about $\frac{1}{8}$ inch diameter, diametrically opposite each other, and solder this cup-shaped disk to the pipe coupling as shown in the cut, and the sprinkler is ready for use. With ordinary water pressure it will throw water in a 30 to 40-foot circle.—5

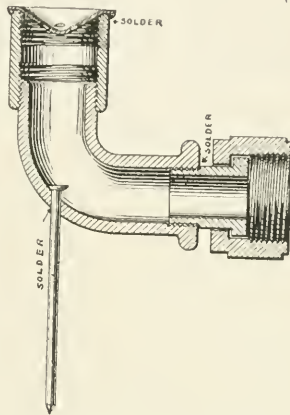

Fig. 304—A home-made lawn sprinkler

HOW TO MEND GARDEN HOSE

As the garden hose gets a little old, and begins to swell, it soon gets out of commission altogether if not attended to.

A simple way to mend it is to wrap the hose with ordinary twine, which will make it last a few more seasons. As it is no easy matter to wind this cord by hand and get it even and under uniform tension, the writer has for many years used the simple contrivance shown in the accompanying illustration.

It consists of an ordinary tin can with a lid, into which is put the ball of twine. In the center of the bottom make a small hole, through which pass the loose end of the cord. Thence let it run down the side of the can through a tension device and to the

hose. To the cover of the can is soldered a small piece of tin, bent to a right angle and forming a guide for the hose. The tension device consists of a short piece of metal, with its upper end bent outward, forming a fulcrum for a short spring-compressed lever. The latter at its lower end has a small hole therein through which the cord is passed. A short stove bolt serves to regulate the tension on the lever. It will be observed that the

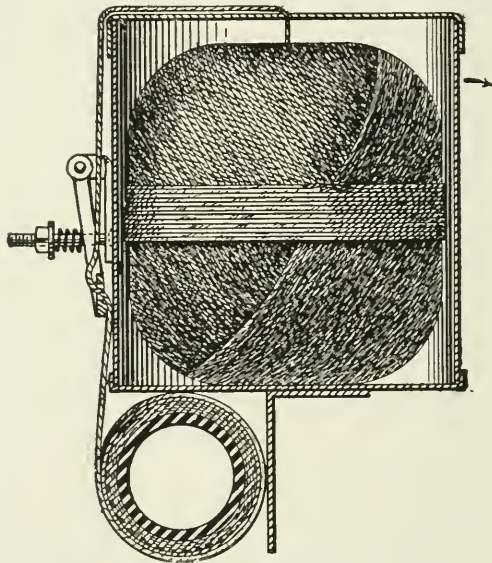

Fig. 305—Device for wrapping garden hose

cord is pressed against the can by the lever. The whole device is now soldered to the tin can.

In use, the can is turned around the hose, and with the tension properly adjusted, the twine will wind around the hose very closely, and will feed the can forward automatically. It will make the hose slightly smaller, and thus close all the small punctures, through which the water percolates, between the several layers of the canvas. By giving the cord a coat or two of some

waterproofing, it will be found that the hose will last as long again; besides it will stand a great deal more pressure than before.—5

HOW TO REPAIR A LEAK IN THE GARDEN HOSE

To repair a leak in the garden hose obtain from a dentist a piece of the soft rubber which he uses in making artificial teeth. A piece large enough to cover the leak freely will be sufficient. Place this over the leak and bind it firmly in place with adhesive tape, being sure that the rubber is completely covered by the tape. Over this wrap twisted linen twine, commencing well below the leak and wrapping closely about the hose to a point beyond, so as to reinforce the hose where it may be weak. This makes a water-tight patch; one that will stand heavy pressure and give good service.—66

TO MAKE PAPER FLOWER POTS

All gardeners and florists, and especially the amateurs, find that the common burned-clay flower pots are at once heavy and fragile, and that much room is required when they are to be stored away. As substitutes many gardeners have used strawberry boxes and paper oyster pails, and have found them handier, especially for growing tomato or melon plants in hot beds and

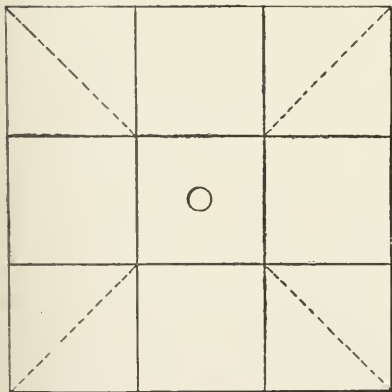

Fig. 306—How the paper is folded

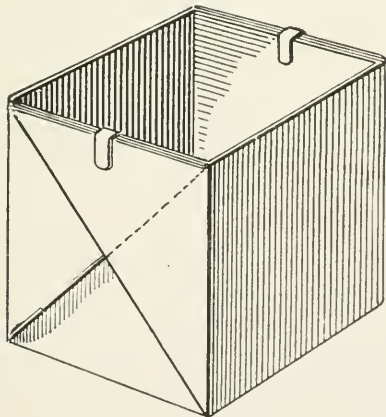

Fig. 307—A paper flower pot

cold frames. Such things do well, but any gardener can make paper pots that will serve the purpose still better. Common building paper, that can be purchased for a dollar a roll, is excellent. For three-inch pots cut it into pieces that are nine inches square; for four-inch pots, twelve inches square, and for five-inch pots, fifteen inches square. Each piece of paper is now to be folded, first along the solid lines (Fig. 306), dividing it into nine equal squares. The corner squares made are then pinched up into dog's ears and the whole piece is erected into the shape of a box with the dog's ears overlapping on opposite sides of the box. The ears are secured in place by means of ordinary clips and the box is done. A hole punched in the bottom will afford drainage. When ready for transplanting the clips are removed from the box which is then opened and the mass of earth and roots lifted out with no injury whatever to the plant.—85

CHAPTER VIII.

THE HANDY SPORTSMAN

A PORTABLE AUTOMOBILE HOUSE

It is the purpose of this article to show how to build an automobile house which has the following advantages: It is portable, as all sections and other parts are held together with a minimum number of bolts and screws. It requires no special skill with tools. It is easily set up and taken apart. It is light and sufficiently strong, and presents a neat and finished appearance.



Fig. 308—Front view of the automobile house

The complete bill of materials for the house as shown herewith costs \$70. To this may be added about \$10 for paint. Because of its ready portability, it may be set up by the lake shore or in the woods and used as a summer cottage. It makes but one easy wagon load for two horses. It has no masonry supports, and therefore does not revert to the owner of the land on which it is

placed, but it can be moved whenever moving day comes. The open doorway gives almost seven feet clearance, which is sufficient to admit an auto with top up. It is large enough for a small touring car with room to work all around it, as well as for the storage of supplies. With a runabout it gives room for shelves and a bench for a convenient workroom at the end.

The frame is of hemlock, Fig. 310, and measures 15 feet 4 inches by 9 feet 6 inches by 7 feet 8 inches high. Above the floors



Fig. 309—A side view of the portable automobile house

the frame consists of only four corner posts, the plate frame, two pairs of rafters, two tie-pieces—not shown—across from plate to plate at the foot of the rafters, all of 2-inch by 3-inch hemlock dressed, and four roof boards, $\frac{7}{8}$ inch by 4 inches. The gable sections serve also as rafters. The sills are held together at the corners by angle irons 6 inches by 6 inches, $\frac{3}{16}$ inch thick and 1 inch wide, fastened with carriage bolts $\frac{3}{8}$ inch by $2\frac{1}{2}$ inches, Fig. 312. These should fit snugly in the sills, so that the square shoulders will prevent turning, and the heads are countersunk flush.

The floor joists rest on straps nailed to the side sills. Two of the joists, Fig. 311, are fastened with lighter angle irons to prevent the sills springing outward. The rest are held in place by small cleats. Two mudsills, 2 inches by 3 inches, are laid under the joists to stiffen them for the load of the machine. These, as well as the whole frame, are blocked up and rest upon boards or plank pieces about 8 inches by 12 inches crossed and laid up

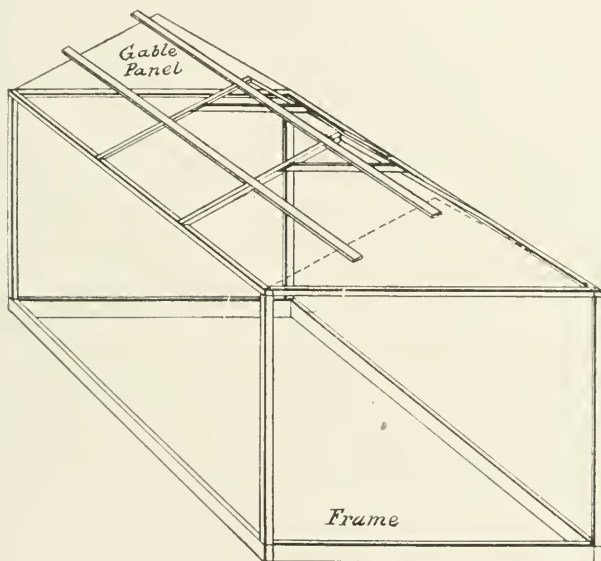

Fig. 310—The frame of the house

under the sills at distances of four or five feet. If these supports settle by the action of frost, it is a simple matter to level up by adding more.

The corner posts stand on the sills, to be fastened later by corner boards, Fig. 312. The plate sticks are halved together at the corners, a hole is bored down through their ends into the top of the post, and a 24-penny wire spike is pushed into it. The plates are also held together by small angle irons at the corners.

At this point the frame must be stayed up while the side and roof sections are put in place.

The side panels, Fig. 313, are of matched Georgia pine ceiling material, $7/16$ inch thick, dressed and beaded one side, cleated with $7/8$ -inch dressed pine on the outside as shown, and cleated with a strip of the $7/16$ -inch material on the inside. They cover each 3 feet by 7 feet and are all interchangeable except that the corner sections are slightly modified to slip under the corner boards.

The window sections are made interchangeable with the rest, and the position of the windows may be varied to suit circum-

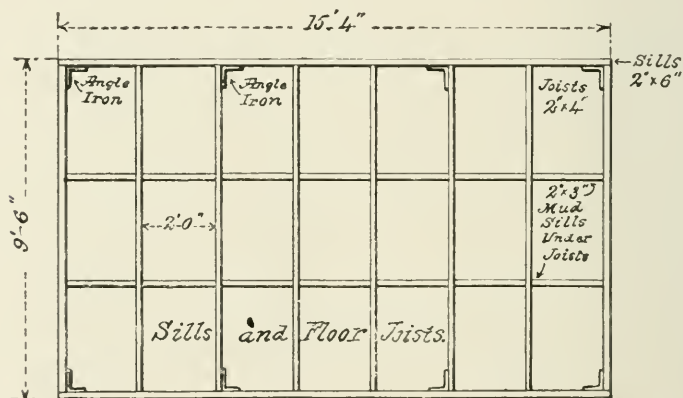

Fig. 311—The floor of the house

stances. The bevel on the cleats and on base and eaves boards, Fig. 314, aids in excluding the weather. The way in which the battens and cleats of the panels interlock to give tightness and strength is apparent from details of Fig. 313. Cleats, 2 inches by $7/8$ inch, are fastened with $1\frac{3}{8}$ -inch package wire nails, clinched on the outside. The inside cleat is fastened with $7/8$ -inch nails clinched inside. In general, the nailing is done with nails just long enough, so that the sharp points prick through slightly. The nail is driven against an iron block, and is readily bent within the wood instead of forming a clinch visible outside.

In the window panel the frame is slotted on the sides to admit the battens. This panel is further stiffened inside by a frame of $\frac{7}{8}$ -inch stuff around the window opening. The double casement windows are factory made, sash $1\frac{3}{8}$ -inch thick, and cost \$1.50 per pair or window. They are hung with parliament butts—separable—swing inside, and shut against the outside frame about

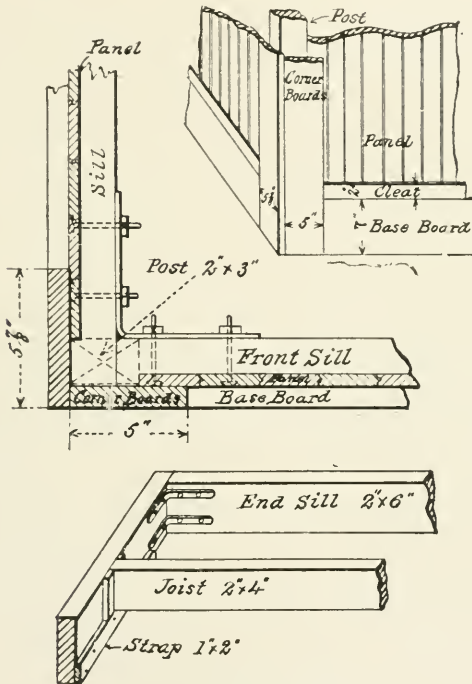

Fig. 312—Corner details

$\frac{3}{8}$ inch. The sill is beveled outside of foot of window sash, and a small square bead is run on the sill for them to shut against. The windows are rabbeted together with a simple L rabbet, and are then fastened inside with small bar bolts top and bottom.

The front gable section is framed of $\frac{7}{8}$ -inch pine, with the

7/16-inch siding nailed to it. The bottom board of this frame overhangs the front plate 1½ inches, and the matched stuff rests on top of the plate. This leaves the lower ½ inch of the plate for the doors to shut against. The gable window opening is framed around with 7/8-inch stuff outside, and with 7/16-inch stuff inside. The gable window sashes are home-made of 7/8-inch

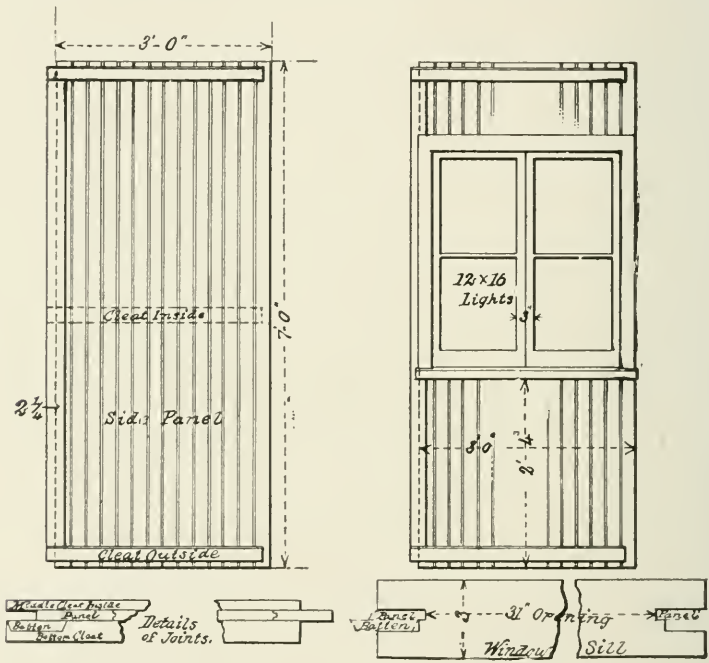

Fig. 313—The side panels

pine, and are hinged with separable butts to swing up for ventilation. The rear gable is slightly modified by narrowing up the bottom board and beveling it to overhang the plate ¾ inch, and by fastening a beveled trim board to the plate to retain the panels below the plate in the same way, the side panels are held by eaves boards.

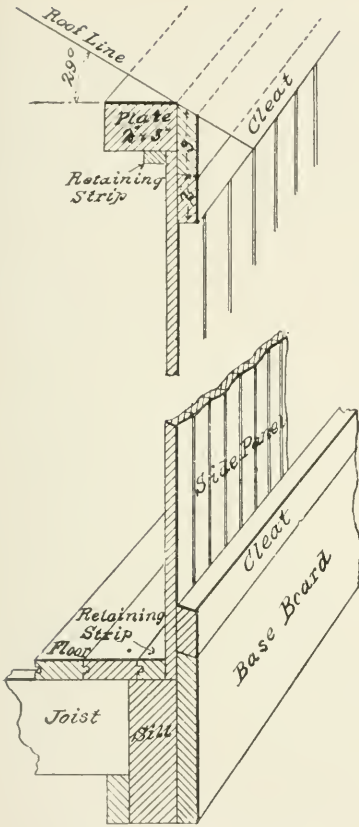

Fig. 314—The base and eaves

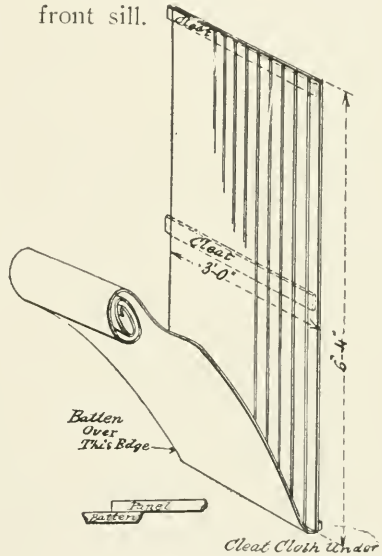

Fig. 316—One of the roof sections

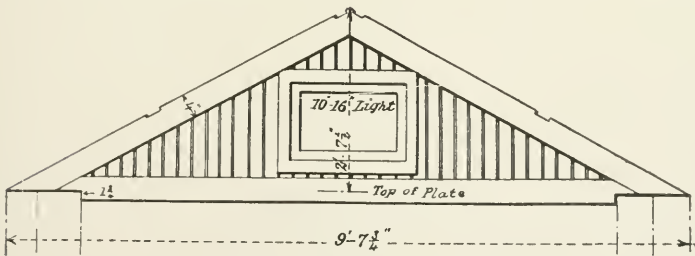

Fig. 315—The front gable

The floor is made in three sections strongly cleated underneath with cleats passing two inches beyond the section edges to stiffen the joints between sections. The floor serves to retain the rear panels on the sill, but stops flush with the front face of front sill.

The front door is constructed of $\frac{7}{8}$ -inch pine. The top boards shut against the plate $\frac{1}{2}$ inch, while the bottom boards shut against the ends of the floor. The matched stuff stands between the plate and the floor.

The roof sections have an overhang at the eaves of about $9\frac{1}{2}$ inches, and the same overhang at the gable ends. Ten sections cover 3 feet by 6 feet 4 inches each, and two sections cover 2 feet by 6 feet 4 inches. They have each three cleats of the same $\frac{7}{8}$ 16-inch material, the bottom cleat being only one inch wide. They are first cleated together (Fig. 316) with the end of a strip of unbleached factory cloth under the bottom cleat, which is nailed from the outside with all nails well clinched. The cloth is smoothed loosely over the section and cut off, and then the face of the section is given one or two coats of white lead mixed thin with raw oil and turpentine. After this dries the cloth is brought over, laid smooth without stretching, and tacked thoroughly at top and sides. Then a batten strip is nailed on at the left edge to cover the joint, as in the side panels. Care must be taken not to stretch the cloth, but to leave it as loose as possible without actual wrinkles, as it will shrink in the subsequent painting. The finished panel must now be given repeated coats of good paint until the cloth is filled and a glossy, weatherproof deck surface is formed. On each slope of the roof two roof boards of hard pine, 4 inches by $\frac{7}{8}$ inch by 17 feet, are let into and flush with the rafters and gable sections and fastened with long screws.

After the frame is up, the base boards and eaves boards are temporarily tacked in place; then the panels are put in place from the inside, bottom end first; then the base and eaves boards are permanently adjusted and fastened to sill and plate with long screws. The corner boards are set together with screws and then fastened in place with long screws into sill and post and plate. The panels next the corner boards are bolted to the corner boards at the middle cleat with roundhead stove bolts, using washers. The roof sections are held in place by stove bolts through the loose edge of the battens and the roof boards, and by screws into the plate. The ridge boards, one 4 inches,

the other 5 inches wide, are beveled and put together with long wire nails. They are then put in place and pieces of the 7/16-inch siding, 2 feet 9½ inches long, are slipped under the ridge boards to level up between the battens, and stove bolts are put through the ridge board, understrip, and roof section. This fastening adds much to the strength of the roof. Finish boards of the 7/16-inch material should be cut and fitted at the gable edge of the roof to give a neat appearance. To stiffen the door opening, brace boards should be put across inside from plate to post at the upper corners of the opening.

In the work of erecting the building no fastenings are to be used but bolts and screws, and to facilitate the work, provide two bitstocks, one for a screwdrive bit, the other for a proper size gimlet. After the house is finished, it should have three coats of paint well brushed into the grooves in the beading, etc. The inside of the doors should also be painted, since they are frequently exposed to the weather.

The panels, and all parts requiring time in the making, can be put together in a shop of limited space, and given a coat of priming paint before erecting the building. This coat should be of white lead and oil, possibly shaded with lampblack ground in oil, and thinned well with turpentine, so that it will strike into the pitchy surface of Georgia pine.

The house shown has been in use for a year, and has proved both tight and strong, in contradiction to the critics of the plan, who thought it would do all sorts of undesirable things under the heat and rains of summer. It is most essential that it be well painted before the weather acts upon it, and that it be kept well painted.

LUMBER BILL.

Side Panels and Roof Panels.—Matched and beaded Georgia pine ceiling stuff, 7/16 inch by 2½ inches by 14 feet. Lengths to cover 700 square feet; add ¼ for matching. 875 square feet
Sills, Mudsills, and Joists.—Rough hemlock, 2 sticks 2 inches by 6 inches by 16 feet; 1 stick

2 inches by 6 inches by 20 feet; 4 sticks 2 inches by 4 inches by 19 feet; 2 sticks 2 inches by 3 inches by 16 feet.....	119 feet
Upper Frame.—2 inches by 3 inches dressed hemlock, posts, 2 sticks 14 feet; rafters, 2 sticks 12 feet; plates, 2 sticks 16 feet; 2 sticks 20 feet (1 for plate ties),.....	62 feet
Floor.—Third quality pine flooring, matched and dressed, 16 feet long, cover 180 square feet, add $\frac{1}{4}$	225 feet
Framing Boards.—Of same stuff, 8 sticks 4 inches by 14 feet, 2 sticks 8 inches by 16 feet; cleats, 26 sticks $2\frac{1}{4}$ inches by 3 feet; next to doors, 1 stick 8 inches by 16 feet; joist supports, 2 sticks 2 inches by 14 feet, approximate....	150 feet
Finish Boards.—Second quality pine, $\frac{7}{8}$ inch dressed and ripped, corner boards, 2 sticks 5 inches by 14 feet, 2 sticks 6 inches by 14 feet; base and eaves, 2 sticks 7 inches by 16 feet, 2 sticks $3\frac{1}{2}$ inches by 16 feet; base and rear plate, 2 sticks 7 inches by 16 feet, 1 stick $2\frac{1}{2}$ inches by 12 feet.....	76 feet
Roof and Ridge Boards.—Georgia pine, $\frac{7}{8}$ inch dressed, 5 sticks 4 inches by 18 feet, 1 stick 5 inches by 18 feet; window sills, white pine dressed, 1 stick 2 inches by $3\frac{1}{2}$ inches by 7 feet	44 feet

—4

HOW TO CONVERT A HORSE-DRAWN BUGGY INTO A MOTOR BUGGY FOR LESS THAN \$300

By following the directions here given, a horse-drawn buggy can be rebuilt at moderate cost into a self-propelled vehicle, which, though roughly made, will give good results and prove satisfactory.

The frame is of angle iron, $1\frac{1}{2} \times 1\frac{1}{2} \times \frac{1}{4}$ inches, cut 6 inches longer than the distance from the front to the rear spring of the

buggy, and bent cold 3 inches from the ends, as in Fig. 318. Triangular pieces should be sawed out where the corners are to come, and the bending done little by little. The body hangers or spring bars for the front and rear can be made of wood, as indicated. Drill a $\frac{3}{8}$ -inch hole at each end, and fit large-head carriage bolts, with the heads inserted in the wood. About $1\frac{1}{2}$ inches from the edge of the dash (inside) and the same distance

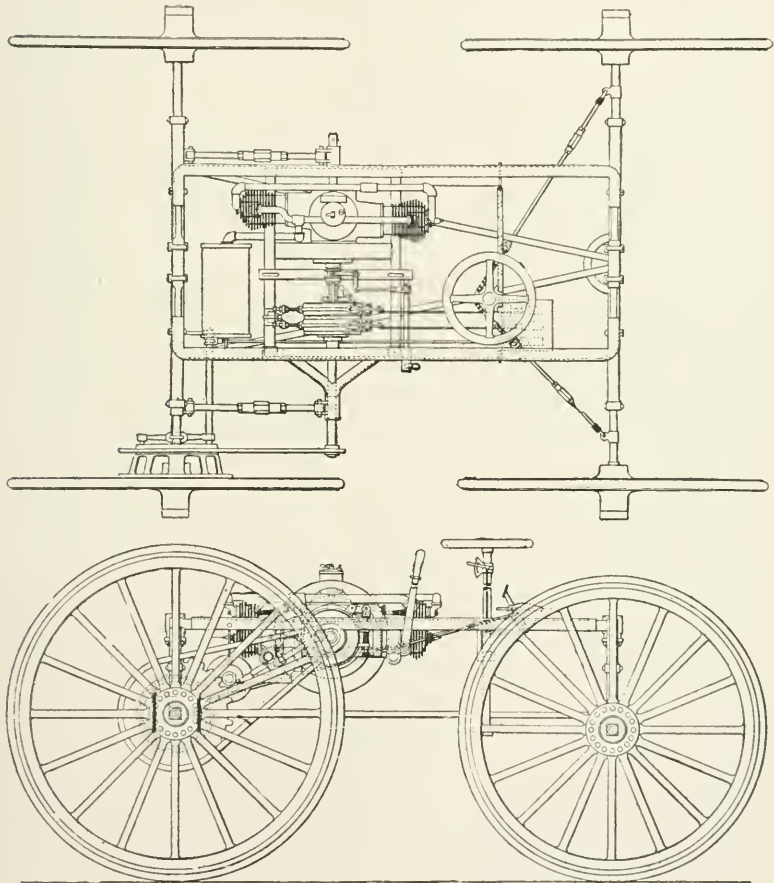

Fig. 317—Plan and side elevation of the assembled buggy

from the rear panel of body, drill $\frac{3}{8}$ -inch holes for body bolts, and 3 inches from the front and rear of the engine hangers cut slots for $\frac{1}{2}$ -inch bolts.

The engine and transmission should be placed under the center of the seat, to avoid cutting the floor boards. The supports should be secured to the angle-iron side members of the frame with three $\frac{1}{2}$ -inch carriage bolts, one on each end and one as near the center as the transmission shaft and starting crankshaft will allow without striking. The holes in the side members

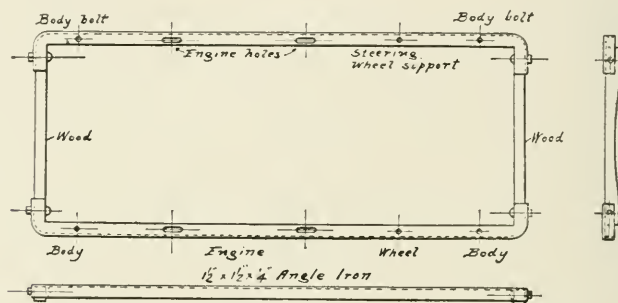

Fig. 318—Angle iron frame with wooden spring bars

should be slotted to provide for chain adjustment, and made large enough to insert the square of the bolts, to prevent them from turning when loosened. Power-plant hangers can be bought, or may be made as shown in Fig. 319. Holes of $\frac{3}{8}$ -inch diameter should be drilled in the frame for the steering-post supports where the steering wheel will be most convenient, which can be determined by trying the wheel in different positions. The distance can then be marked off from the inside of the dash.

The engine should be fastened securely to the engine hangers, and the transmission bolted to the fly-wheel or coupling before babbitting the transmission bearing. Cut two washers out of wood to fit easily over the shaft, making the inner washer in two parts, so that it can be fitted around the shaft after the

hanger is in place. Putty all cracks where there is danger of the Babbitt metal running through. Drill one $5/16$ -inch hole near each end of the bearing on top, and one $1/2$ -inch hole in the center for pouring. Build three cones around the holes, the largest one around the center hole and about $3/4$ inch high. Heat the bearing until it gets hot, but not red, before pouring. When melting the babbitt, put about a teaspoonful of resin in the ladle to make it flow better. To tell when the babbitt is hot enough, insert a perfectly dry stick for a second or two, and if it begins to char or to blaze, the metal is ready. Continue to pour steadily until the bearing and the pouring hole are full, and if the babbitt settles below the holes, pour in more while hot.

As this buggy is driven by one rear wheel only, no differential countershaft is needed, and only one brake drum, drive chain, and set of sprockets is required. Driving sprockets for the transmission shaft and rear wheel can be bought from the manufacturers or dealers. To insure that the wheel sprocket will be concentric with the hub and run true, it is advisable, when marking out holes for the brake drum, to mark one first, then secure the drum to the wheel with one clip, place the wheel on the axle, and hold a stick on the axle. Now revolve the wheel and shift the drum repeatedly until the stick touches all around. Then mark off more holes, two at every fourth spoke (if it is a 16-spoke wheel) and clamp spring clips to the wheel and revolve

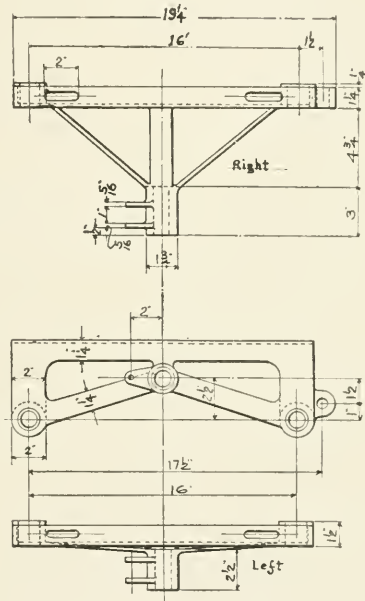

Fig. 319—Plan and elevation of engine hangers

marking out holes for the brake drum, to mark one first, then secure the drum to the wheel with one clip, place the wheel on the axle, and hold a stick on the axle. Now revolve the wheel and shift the drum repeatedly until the stick touches all around. Then mark off more holes, two at every fourth spoke (if it is a 16-spoke wheel) and clamp spring clips to the wheel and revolve

as before until it runs true. Finally, mark off two holes for clamps to straddle every second spoke.

Brake bands, cams, and hanger set can be bought or can be made, as shown in Fig. 320.

Steering rods are secured to the front axle as in the plan view and are fitted with turnbuckles. The length of chain passes around the rear arc of a sprocket on the lower end of the steering post, which should be in the same horizontal plane as the axle. The steering wheel and column complete can be bought.

When setting the spark and throttle controls, it is advisable to have them drawn as far to the rear as possible, the spark lever

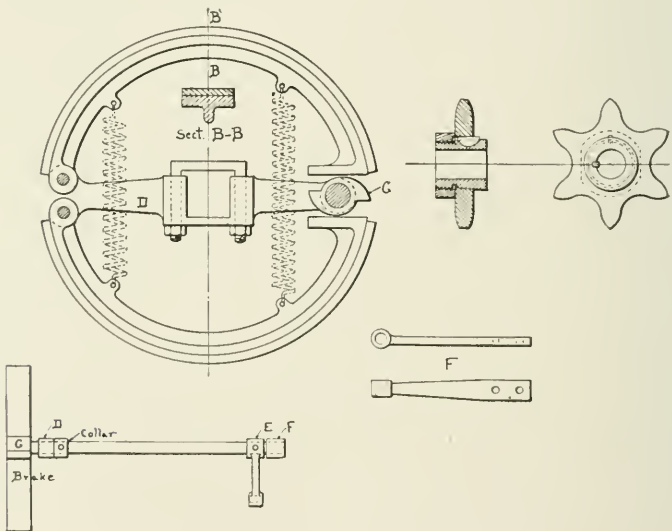

Fig. 320—Expanding brake sleeves and operating rod

on the right and the throttle lever on the left. Set the commutator or timer arm backward also (provided, of course, the timing shaft turns in the opposite direction from the crankshaft) and make the rods of the right lengths to enable you to get the timer lever all the way back.

As the engine shown in the drawing is of the automatic intake type, the intake valves will take care of themselves. Turn the engine over toward the front until the exhaust valve begins to open, as shown by the compression of the valve spring. Continue turning until the valve is full open, when a wire inserted through the spark-plug hole will show that the piston is at the top of the cylinder or at the upper dead center. At this point the flywheel will revolve some distance without the piston's moving. Mark the wire, and then turn the wheel one more complete revolution

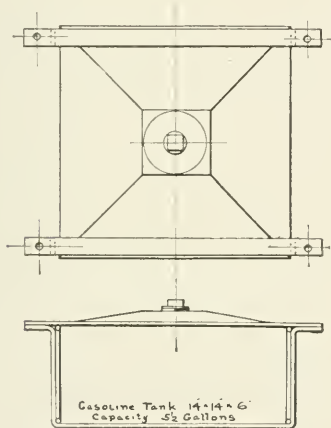

Fig. 321—Plan and end view of fuel tank

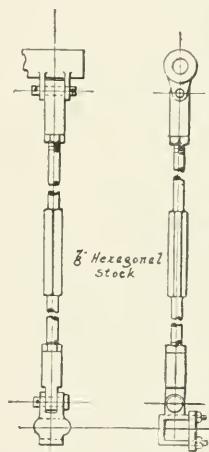

Fig. 322—Plan and side view of radius rods

and until the piston descends about $3/16$ inch past the dead center. Now set the roller, ball, or other type of contact of the timer where it will strike the contact post that is to represent the cylinder you have timed to fire at this point, making sure that the roller or ball is striking the contact so that it will continue to spark after passing $3/16$ inch beyond dead center, as this is a vital point. Fasten a double-cylinder spark coil to the inner side of the body nearest to the engine, so as to use short wires.

Throttle lever, rods, etc., should be set backward as the timer

was. A simple, inexpensive carbureter is advisable, such as a Schebler model E, which has only two adjustments to make, one for the air and another for the gas. Screw the air adjustment screw about half way down, and lock it there. Then adjust the gas to give the best results. When the gas throttle is closed, the lever on the steering post should be in rearward position, that is, toward the driver.

The gasoline tank should be made to fit between the sills of the seat and fastened on the right-hand side, leaving the space over the engine open. The tank can be made in any tinshop, of galvanized iron with strap iron supports, as in Fig. 321.

A force-feed oiler will give the best results, and can be driven by leather or spring-wire belt from a pulley on the crankshaft.

Radius rods are made from $\frac{7}{8}$ -inch hexagon stock, turned down

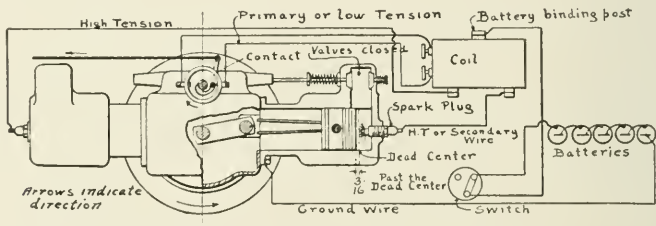

Fig. 323—Wiring diagram for engine

as in Fig. 322, and with right and left threads cut on the ends, so that they can be lengthened or shortened by turning.

A two-speed planetary transmission is used, which also has a reverse gear. The band nearest the flywheel gives reverse motion, and the other is for first or slow speed ahead. High speed is controlled by a lever on the side, which, when pushed forward, locks all the gears, the transmission turning as a unit, so that the drive is direct at the same speed as the engine. First speed and reverse are controlled by pedals, which, when pushed forward, tighten the friction bands around the drums on the transmission. The bands should be free of the drums when the car is not run-

ning. Otherwise the machine will have a tendency to creep forward or backward when the engine is running and the gears are not engaged, according to which band is dragging, and the bands will wear out rapidly. The pedals are held in plates screwed to the floor of the car in front of the seat, and have ratchets to hold them in position when set. The brake pedal is held in the same way. The footboard must be sawed away to receive the plate at just the proper distance from the seat to be comfortable in operation, and care must be taken to have the pedals come in exact line with the transmission bands, otherwise there will be a tendency for the rods to pull the bands sidewise, so that they will not hold securely and will wear unduly.

All the necessary parts and materials for transforming a buggy as described, and equipping complete, can be bought ready made at a total of \$283.57, as itemized herewith:

1—2-cylinder spark coil.....	\$14 00
1—switch	70
2—standard spark plugs.....	2 68
1—6½ x 12-inch muffler	7 50
5—dry cell batteries	2 00
6—battery connections	20
6—secondary copper terminals.....	15
6—primary copper terminals	20
20 feet primary wire	2 80
10 feet secondary wire	3 00
1—pair side lamps	5 00
1—tail lamp	5 00
1—set of lamp brackets	3 00
1—4½-inch horn	4 00
1—gallon can lubricating oil.....	1 40
1—pound can of cup grease.....	30
1—⅛-inch brass grease cup.....	26
1—oil gun	60
1—small oil can	30
1—box assorted cotter pins	25
1—box assorted lock washers	60

1—tool kit	8 00
1—rear wheel brake drum	4 25
1— $\frac{3}{4}$ -inch pitch $\frac{1}{2}$ -inch wide 60-tooth roller chain sprocket	10 20
1—countershaft sprocket hub	2 00
1— $\frac{3}{4}$ -inch pitch $\frac{1}{2}$ -inch 9-tooth roller chain sprocket....	50
6 feet $\frac{3}{4}$ -inch pitch, $\frac{1}{2}$ -inch roller chain, \$1.17 per foot..	7 02
2 feet 1-inch pitch, $\frac{5}{16}$ -inch block chain.....	86
1—1-inch pitch $\frac{5}{16}$ -inch 6-teeth $\frac{5}{8}$ -hole sprocket.....	36
1—6-horse-power double-opposed air-cooled motor.....	85 00
1—6-horse-power transmission	32 00
1—4-feed force-feed oiler, pulley and belt.....	15 00
$\frac{1}{2}$ pound oil tubing	60
3 feet 1-inch standard pipe for muffler (8 cents per foot). (Add 10 cents for each piece cut and threaded)..	24
2—1-inch malleable elbows	20
2—1-inch Street ells	20
1—1-inch tee	15
1—1 by 2-inch nipple	10
1—steering wheel complete (with fittings, turn-buckles, tie rods, etc.).....	15 00
1—set power-plant supports (hangers, pipe, high-speed lever, support, bolts, etc.).....	18 00
1—high-speed lever, finished	75
1—set radius rods, complete, with axle clips.....	6 00
1—set brake shoes, hangers, rod, yokes, etc., complete....	6 00
1—pedal plate, transmission rod and yokes.....	5 00
1—frame to fit any body, finished complete.....	7 00
1—starting crank, finished	75
1—set spark and throttle control rods, levers, etc.....	1 25
1—pound copper tubing, for gasoline.....	1 20
1—gasoline tank, holding about 3 gallons.....	2 00

Bolts and screws at any hardware store.

\$283 57

GETTING HOME WITH A WEAK BATTERY

When a storage battery is exhausted, no more current can be obtained from it until it has been recharged, which should be done at once. A dry battery, on the other hand, weakens gradually. If one gets out on the road and the engine starts to miss after running a few miles, he may get to the next town sometimes by slightly adjusting the trembler contacts, sometimes by adjusting the tremblers themselves to bring them a little closer to the magnetic core beneath them, and sometimes by bending the spark-plug points a little closer together, so that the spark has a smaller gap to jump. If these expedients fail, the pitch may be dug out from the tops of the cells, and water poured in until the cells are saturated. If salt is at hand, salt water is better.

THE HANDY MAN'S SPARK PLUG

The spark plug shown here is equally well adapted for high or low tension ignition. It may be made by any handy workman from an old mica plug by taking out the steel wire down the center and putting in its place a piece of brass tubing, $\frac{3}{16}$ of an inch outside diameter and $\frac{1}{8}$ of an inch inside diameter. *A* and *B* are the terminals forming the spark gap, *C* is the mica, and *D* the threaded body of the plug. The upper end of the terminal *A* is riveted to a small valve *E*, which is pressed down by a weak spring and thereby closes the upper end of the tube, as shown in the sketch. A valve chamber is screwed on the upper end of the tube, thus holding the mica together. The valve operates in the chamber, being fastened thereon by the screw *F*. The valve and its seat should be ground flat, and then the terminal *A* should be riveted to it. There is a small hole *G* in the cover of the air chamber. The cover should be fastened to the chamber with a screw or other simple means, so that

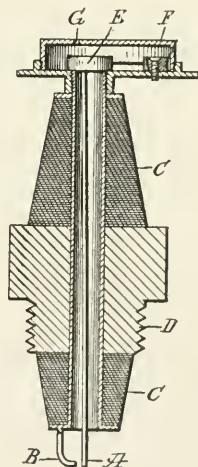

Fig. 324—Sectional view of the spark plug

it may easily be detached for the purpose of cleaning the valve. In use the terminal *A* vibrates rapidly, like the trembler of a coil, and in this way strikes the terminal *B*. During the compression stroke the compressed gases travel up the central tube, lift the small valves, and instantly fill the valve chamber to the same pressure as the cylinder. With the same pressure on both sides of the valve, it will be forced down by its spring. But as the gases in the chamber *C* escape through the hole *G*, the pressures will be thrown out of balance, and the valve will again be raised by the pressure in the cylinder. This action will continue during the entire compression stroke. The hole *G* should be extremely small, and the amount of gas that will escape during compression will not perceptibly lessen the power of the engine. It will be clear that as the valve is raised, *A* approaches *B* and also that *A* moves away when the valve is closed, because the fulcrum is virtually at the screw *F*.

As *A* keeps striking *B* while it vibrates, the low-tension contact, or touch spark, may be used with this plug. This plug gives many contacts, and therefore many sparks, instead of the single contact given by the usual hammer and anvil. This plug is far simpler than the hammer and anvil system, and besides it does not leak and lose compression like the latter does when worn. It will work with high-tension ignition with a trembler coil. As the terminal vibrates, it keeps itself clean, and an excess of oil or soot will not affect it like an ordinary plug. If used for high-tension ignition, the period of vibration should not be the same as that of the coil trembler, or an odd spark will be missed, owing to *A* being sometimes in contact with *B* when the high-tension current is in the act of flowing. The terminal *A* may be made to vibrate as rapidly or slowly as desired by strengthening or weakening the valve spring.—70

SCRAPING CARBON FROM THE PISTON HEADS

Carbon is deposited in the combustion chambers of all automobile engines by imperfect combustion of the cylinder oil and gasoline. Dust from the road, drawn into the engine, adheres to the oily surfaces, and adds to the accumulation. On the piston heads,

and sometimes elsewhere as well, this deposit in time becomes so thick as to be raised to incandescence, so that it causes premature ignition of the charge. It may usually be removed from the piston head by the use of long scrapers, as illustrated. These scrapers are made of $1/4$ -inch or $5/16$ -inch soft steel, with the ends flat-

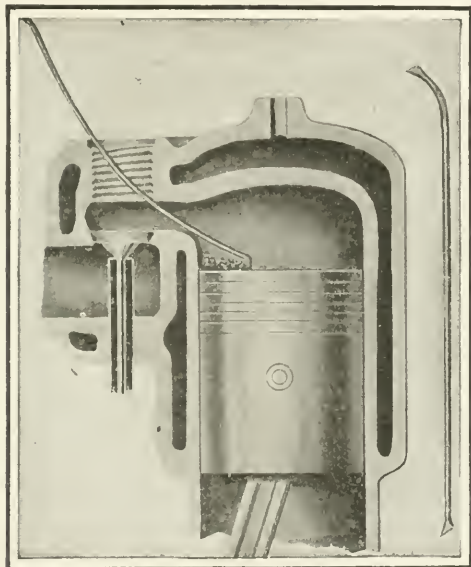

Fig. 325—How the carbon is scraped from the piston head

tened in the forge and bent hoe-shaped. By suitably bending the shanks and by turning the crank to bring the piston into an accessible position, it is usually possible to detach all the carbon on the latter. Kerosene is used to soften the carbon, and a small battery lamp connected to a length of cord, aided by a flat dentist's mirror, enables the whole interior of the combustion chamber to be explored with ease. The material detached is scooped out clean with the piston at its highest point.

CLEANING THE SPARK PLUG

The usual method employed in cleaning spark plugs is to use a small brush and gasoline and polish the end of the plug. As most plugs are constructed so that it is impossible to thoroughly clean the porcelains in that way, it is advisable to take them apart and brush every particle of carbon from the porcelain. If the carbon is baked on hard use a sharp knife to remove it. Never use emery cloth to clean porcelains as that cuts off the glaze and then they will absorb enough carbon to destroy their insulating qualities.

STRAIGHTENING AN AUTOMOBILE AXLE

On light machines much time and expense can often be saved by using the following method for straightening a bent axle: Place the machine with the axle that is to be straightened directly under and parallel to one of the heavy cross-timbers on the second

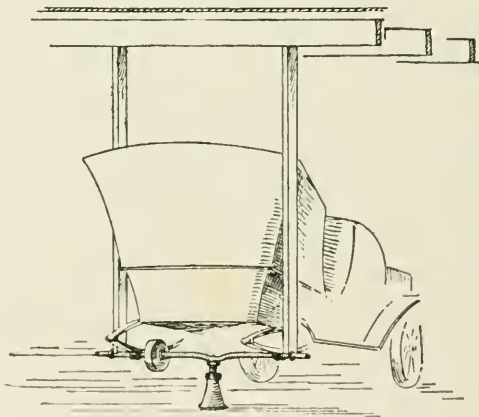

Fig. 326—Straightening a bent axle

floor of the garage. Next take two 4 x 4 inch timbers and cut them just long enough to reach from the top of the axle to the under side of the cross-timber. Place one of the timbers on each end of the axle and drive a small wedge under each to hold them

in place. Now place an ordinary screw jack on the floor directly under the bend and apply as much pressure as is necessary to spring it back into place. The writer has used this method successfully for over a year and the whole job can be done in fifteen minutes. If the axle is very stiff it is a good plan to place a piece of band iron between the timber and the axle to prevent the timber from splitting.—53

TAKING UP THE ENGINE BEARINGS

Taking up bearings is not properly a job for the amateur. Nevertheless, there are times when it is well to know the procedure. Crank-pin bearings are frequently fitted with shims *A A* of thin brass or copper (Fig. 327) and a rough adjustment may be made by taking out one or two shims on each side, being careful to remove the same aggregate thickness from both sides. If it is found that taking out the thinnest shim leaves the bearing tight, shims may be cut from paper to make the bearing turn freely. In case there are no shims, it is necessary to file down the flat surfaces *B B* of the cap. This must be done with great care, otherwise one end or one corner may be filed too much and the cap sprung, or made to bind on the crankpin. After filing a little, the cap must be bolted on, and the shaft turned to ascertain whether enough has been taken off.

The wear of a crankpin is chiefly in the top half. The wear of the main bearings is in the bottom halves, which are usually removable caps. It follows that to refit the main bearings, the bottom caps are simply raised to bring the shaft up

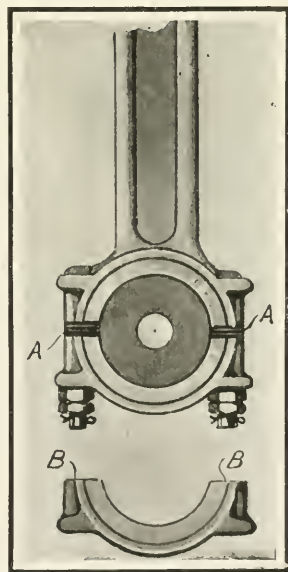

Fig. 327—Taking up crank-pin bearings

against the top halves of the bearings. Fig. 328 shows a crankshaft with both end bearings removed, the crankcase wall and the upper bearings being indicated in section, and the lower half of the crankcase removed. The shaft is held up by the central cap *A*, and the front bottom cap *B* is shown in perspective. If the main bearings have shims similar to *A A*, Fig. 327, it is only necessary to take out whatever thickness is necessary to make the bearing

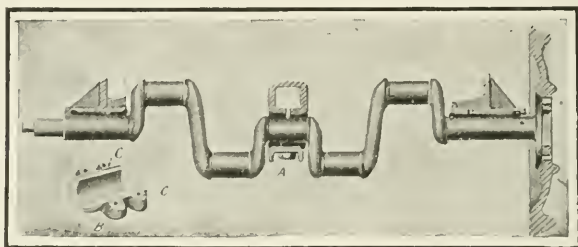

Fig. 328—Tightening the crankshaft bearings

tight. If there are no shims, the flat faces *C C* must be filed. A bearing taken up in this manner is seldom a first-class job, because it rarely results that the shaft has a full bearing all over the surface. Generally the shaft is out of line, or it is cut, or the bearing is cut; and taking up as above described simply enables the car to be run a few hundred miles farther, to save putting it in the shop at an inconvenient time.

TEMPORARY REPAIRS TO BROKEN SPRINGS

A spring is most apt to break in the center, as in Fig. 329. The spring clips *A A* will probably hold it together after a fashion, but the ends will sag and put a dangerous strain on the clips. A hard-wood board *B*, from 1 inch to 2 inches thick, should be procured, and the sides trimmed down so that it will be about 5 inches wide in the center and 2 or 3 inches wide at the ends. Drive nails *C C* in the ends of the board, jack up the frame of the car to take the weight off the spring, put the center of the board on the rubber bumper *D*, or, if there is no bumper, on a suitable block

of wood, and bind the ends down tightly to the spring with leather straps or clothesline.

In case the breakage is toward one end, a block *E*, Fig. 330, should be nailed to the board over the break. The remainder of the operation is substantially as shown in Fig. 329. When clothes-

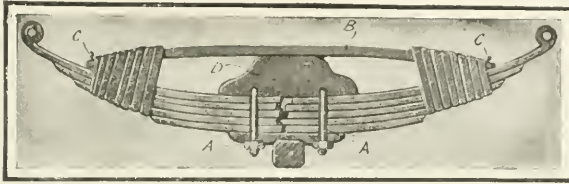

Fig. 329—Repairing a spring broken at the center

line is used, the winding should start at the end of the board, the short end of the rope being tied in a single knot, and led along the board and covered by the subsequent turns.

PUTTING ON A NEW CLUTCH LEATHER

A clutch leather may be cut from a wide piece of leather belting of uniform thickness, usually $\frac{1}{4}$ inch. If the piece chosen is too thick, it will be impossible to release the clutch fully. Take off the

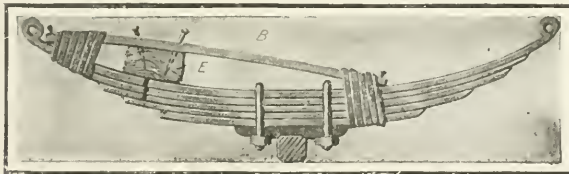

Fig. 330—Repairing a break at one end of the spring

old clutch leather, lay it out flat, and use it as a pattern for the new leather. (See Fig. 331.) As the leather will stretch somewhat, it is not essential to have the new leather curve as much as the old one. Cut the new leather about $\frac{1}{2}$ inch short, and

punch and countersink holes in its ends for the rivets, whose heads should be below the surface of the leather. Soak the new leather in water until it is thoroughly soft. Stretch it over the clutch, and put temporary rivets in the ends. Mark the central rivet hole, remove from the clutch, and punch that hole. Put the leather on the clutch again with temporary rivets, and punch and mark the remaining holes. When all have been punched and counter-

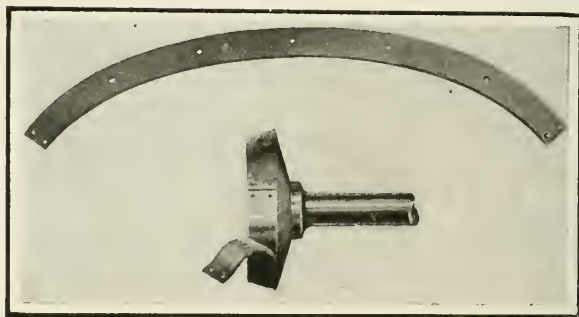

Fig. 331—Putting on a new leather

sunk, rivet the leather in place. For this purpose it is necessary to have a bar whose end diameter is about the diameter of the rivet heads. This bar is used as an anvil against the rivet heads. Two men are necessary, and the whole job, after the leather has been taken out of the water, must be done quickly, else the leather will shrink so that it will not go on.

RELINING THE BRAKE SHOES

There is more to the care of the brake shoes than simply keeping them in proper adjustment. By degrees the materials of the friction surfaces wear away, and the toggle or other mechanism by which the brakes are expanded or contracted reaches the limit of its efficient movement. It then becomes necessary to reline the brakes, or to provide new brake shoes, according to the nature of the friction material. Usually the brake drum is a steel casting,

but the shoes may be fiber, cast iron, bronze, or mixtures of asbestos, camel's hair, copper, and the like. It is easy to tell what to do when replacements become necessary. The important point is to bear in mind that adjustment cannot be indefinitely repeated before the brakes become ineffective.

THE MOTORIST'S ACCIDENT PREVENTER

An ingenious accident preventer is to be seen in the town of



Fig. 332—The mirror prevents accidents at the turn

Woodbridge in Suffolk, England. Attached to the wall at the corner of a narrow thoroughfare leading into the Market Place is a large mirror. In this mirror it is possible to view the traffic coming from either direction, a great advantage to the motor and other traffic passing through the market place. This ingenious

device is growing in favor with the authorities of towns and villages with narrow and dangerous thoroughfares.—83

WHEN A LOST NUT CANNOT BE REPLACED

There are various roadside expedients possible when a nut has been lost and no duplicate is at hand. Usually as good a plan as any is to wind the threads of the bolt tightly with soft iron wire, such as stovepipe wire, of which a coil should always be carried in the tool locker. The winding should start at the end of the bolt, and follow the threads up to the part it is desired to retain. The wire is then wound back in a second layer over the first, and the ends twisted together. If there is a hole in the bolt for a cotter pin, one should be inserted, and the end of the wire twisted around it, so that the improvised "nut" cannot screw itself off from the bolt.

HOW TO CONSTRUCT AND OPERATE A ONE-MAN AIRSHIP

In constructing a small dirigible balloon, the first and most essential thing is to make a perfect envelope, which can only be had after careful labor. Cotton may be used, but silk makes by far the better gas bag. It is three or four times as strong as cotton, and will last indefinitely with proper care.

The silk must first be cut in lengths of from twenty to thirty yards, according to the size it is desired to make the envelope. Next the silk must be given a thorough bath, in either linseed or spar oil, and hung up by one end to dry, so that the oil will run to the bottom and dry evenly. The drying process depends on the climatic conditions, and I have had it take from one week to five months for my silk to dry. The silk must be thoroughly dry before cutting and sewing.

After the silk has been prepared, the next step is to make a pattern for a single gore of the gas bag, or for a half or at least a quarter of such a gore.

In drafting and cutting the pattern, great care should be taken to see that it is absolutely correct in outline, as if there is the slightest irregularity the silk will draw and tear. The edge of each gore should be cut on a curve which is laid out in the follow-

ing manner upon a paper pattern: A strip of paper of the same dimensions as a length of the silk is fastened horizontally on a wall. A string is then suspended from two tacks placed at each end of the strip, midway of its width, and allowed to sag until it touches the bottom of the strip. The line thus formed will be the desired curve. The only point to remember is that the gores must be of the proper width to give the desired circumference at the center and that there must be enough margin left to allow for overlapping the seams. Once the pattern is obtained the cutting is easily accomplished.

I have found the most economical and reliable one-man airship to be one made to the dimensions of my "California Arrow," the length of which is three times the diameter, while three and a half times would still be a good proportion. The seams should all be double stitched. The strips are first sewed together with a plain seam about $\frac{1}{2}$ inch from the edge. The raw edges are then turned under about $\frac{1}{8}$ inch, and sewed down by a second line of stitching $\frac{1}{4}$ inch from the first line, thus forming a lap seam. The sewing should be done with good silk.

About two feet from the bottom center of the envelope, make a large neck, or manhole, so the bag can be turned wrong side out and varnished. Directly above this manhole, in the top, a 14-inch valve may be fitted. Although the valve is merely a matter of personal desire, I do not advise building an airship without one. Should the valve be inserted, there must be a cord coming down to the manhole, so that it can be used if needed. About four feet back of the manhole, put in a small neck about six inches in diameter, for filling the bag with gas.

Now the bag being sewed and ready for the coating of varnish, take a six-inch brush and after the envelope has been blown full of air, so that it will hold its shape, commence at one end and paint one or two gores the entire length of the bag. When these have been very carefully done, take the next two gores, and so on until the entire envelope has had the second coating. After this is absolutely dry, turn inside out and do the same thing over. These coats of varnish must be put on until the envelope is air

tight, and there is no leakage. Be careful to watch the envelope when filled with air, as the change in temperature will cause the air to expand and is liable to burst the bag, but after watching it a day or two, the hours for expansion and contraction will soon be learned.

This envelope should be entirely incased in a linen square mesh netting, and never a diamond shape, as there will be no end of give with the diamond mesh, and it will be difficult to control the airship when in the air. The squares should be about six inches, and for a ship the size of the "California Arrow" there should be about sixty suspension cords of alternately 6 and 8 feet in length, placed some two and a half feet apart and extending the entire length of the frame. There will be two cords on each point of the finished netting, one for the top and one for the bottom of the frame.

The frame, which is about 45 feet long, should be built of 1½-inch Oregon spruce. It is in the form of an equilateral triangle, and it should be braced every three feet with a 1½ x ½-inch strip, the panels thus formed being braced diagonally with piano wire.

The frame should hang about six feet from the bottom of the envelope and should be perfectly adjusted, so that an equal strain will come on each suspension cord.

The propeller should be a two-bladed one, ten feet in diameter, with the pitch about equal to the diameter, and a blade width of 18 inches at the tip. It should be geared to make about 175 revolutions per minute, which is a peripheral speed of the blades of 5,498 feet per minute. The longer the blade and the slower the speed, the more efficient is the propeller within certain limits. The propeller shaft should be made of 16-gage, 1¼-inch seamless steel tubing. The rudder should contain a surface of 36 square feet.

A 7-horse-power air-cooled motor of about 50 pounds weight is sufficient power for this size airship, as the full power of a larger engine cannot be used, and for the novice a 7-horse-power engine is quite sufficient. The motor should be placed about one-third of the distance from the front of the framework and suitably geared

to the propeller. A clutch can be fitted if desired, but this is not absolutely necessary. The engine should be carefully watched at all times, as the success of an airship depends upon the motor. The engine should be rigidly inspected each time before going in the air, and special attention should be given to its lubrication, which must be very thorough.

During 1907 I made ninety-two starts, returning to the exact starting point ninety-one times. On the one trip from which I did not return under my own power, the wind came up stronger than the thrust of the propeller, and therefore I was helpless, but my valve gave me the means of a safe descent. Never go into the air when the wind has more power than you have, and you will have little or no trouble. An eight-mile-an-hour wind is a safe limit, although an experienced operator can operate in a wind of from twelve to fifteen miles an hour. Accidents are not necessary if the operator is sure that everything is in working order before he makes an ascension, for when you are once in the air, and things go wrong, it is then too late to remedy them and you will have to take the consequences.

Following are the dimensions of the "California Arrow," which may be used as a pattern: Length, 52 feet; diameter, 17 feet, with a capacity of 9,000 cubic feet. Made of the best Japanese silk, coated with linseed oil varnish. Irish linen netting. Frame, equilateral triangle, 45 feet long by 3 x 3 feet wide, and equipped with a Curtiss 7-horse-power motor of 50 pounds weight. Two-blade screw propeller, 10 feet in diameter and 10-foot pitch, with 18-inch width of blade at tip; peripheral speed, about 5,000 feet per minute. Shaft connected with a countershaft, but no clutch is used. The speed is controlled by a rod eight feet long extending forward from operator to motor and connected to the throttle. The rudder contains 36 square feet of surface. The tiller rope is continuous and passes around a pulley in front of the operator. The rudder can thus easily be controlled by one hand. One thousand cubic feet of gas will lift 65 pounds. The formula for making the gas is 1,000 pounds of sulphuric acid, 1,000 pounds of iron, 5,000 pounds of water, which should generate 3,500 cubic feet of gas.

After the frame and engine and all connections are finished, the airship is ready for its first flight. The airship, of course, is supposedly under cover and protected from bad weather while waiting for the start. The very last thing to do before leaving the aerodrome is to ballast the airship. Mount the frame and arrange things so that the center of balance is about 5 feet back of the motor. Add or take from the ballast until there is about three pounds of ascensive power, and then you are ready for a flight. This should be done about fifteen or twenty minutes before the time of ascension, so that there will be no delay whatever when the minute arrives. After stepping from the frame and having the ship anchored, walk around and look carefully over everything. The manhole and inflating neck should be made into a safety valve, by taking up several inches and twisting an elastic band around several times, so that in case high altitude or heat from the sun's rays causes expansion, the bands will blow off and give warning before the envelope will rip.

A large open field is preferable for the trial flight. Two saw horses about $4\frac{1}{2}$ feet high will be needed to set the airship on, before the flight, so that when starting the engine the propeller will not strike the ground. Now the airship, we will say, is in the field and you are on the frame with the engine working all right. The rudder ropes are free, and everything all ready. You should have a drag rope of 100 feet attached to the frame about one-third from the back end. This should be carefully laid on the ground free from everything, so that when you rise it will not become entangled. You take your seat slightly back of the center of balance, with the engine running, and when you give the signal, the saw horses are knocked out from under the frame, and you ascend at an angle of about 10 degrees by stepping back a foot or two upon the frame which you are straddling. You now must use your own judgment about your flight, as to how long it will be and where you will try to go, but be careful not to turn your rudder too quickly. This should be operated by two tiller ropes, one in each hand. Move slightly forward for descent, and backward for ascent. The spark and throttle control rods run

back along the frame, and can be operated at all points where you stand. In coming down stop the motor about 25 or 30 feet from the ground, and have some one to catch the frame and save the propeller from striking the ground. With proper judgment the airship should come back to the exact starting point, even as close as one or two feet. After the flight is ended, take the airship back to the aerodrome, guy it down carefully, shut off the gasoline, disconnect the spark, and watch the gas bag for expansion. With proper care the airship should stay in that condition indefinitely, and be ready for another flight when you so desire.—81

HOW TO BUILD A CHANUTE-TYPE GLIDER

Many forms of glider have been tried, but the one which has so far given the most general satisfaction is known as the "Chanute" type.

Either bamboo or spruce may be used for the framework, although the latter material is the more convenient to work with.

If spruce is decided upon, the following materials will be required:

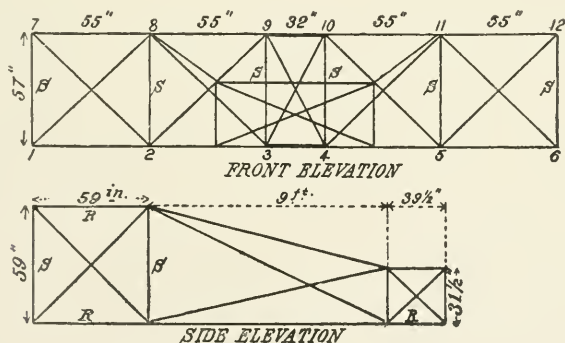

Fig. 333—Dimensions of the frame

92 feet 8 inches of spruce 1 inch square in 8 pieces, 11 feet 7 inches long.

59 feet of spruce 3/4 inch square in 12 pieces, 4 feet 11 inches long.

57 feet of spruce $\frac{3}{4}$ inch square in 12 pieces, 4 feet 9 inches long.

Also 50 feet of spruce $\frac{3}{4}$ inch square in 4 pieces 6 feet 7 inches long, 4 pieces 3 feet $3\frac{1}{2}$ inches long, and 4 pieces 2 feet $7\frac{1}{2}$ inches long, for framework of rudder.

3 square feet of sheet iron $\frac{1}{8}$ inch thick.

24 $\frac{1}{2}$ feet of mild steel rod $\frac{3}{16}$ inch diameter.

11 dozen $\frac{3}{16}$ -inch nuts.

Ball of strong twine.

About 5 $\frac{1}{2}$ pounds of steel piano wire, No. 16.

About 40 yards of unbleached muslin 1 yard wide.

The framework should be clamped together, as holes in the sticks would seriously weaken the joints. Two suitable forms of clamp are shown in Fig. 334.

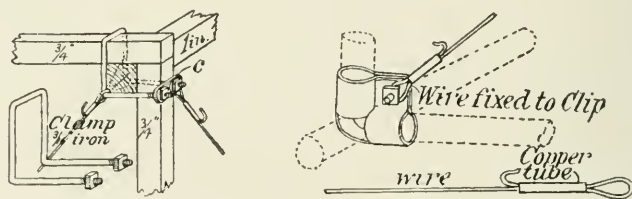

Fig. 334—Clamps for square and round sticks

To make the clamp for square sticks, cut off a piece 8 $\frac{3}{4}$ inches long from the $\frac{3}{16}$ -inch steel rod and thread the ends for a distance of one inch, using a $\frac{3}{16}$ -inch stock and dies. Clamp the rod vertically in the vise at exactly 4 inches from one of its ends, and bend the projecting 4 inches over at right angles to the rest of the rod, using a hammer and making the bend as sharp as possible. Treat the other end in the same manner, taking care not to injure the thread on the ends. You will thus have bent the rod into the form of a letter U with a flat bottom, the sides of the U being 4 inches long and $\frac{3}{4}$ inch apart. Take a piece of the $\frac{3}{4}$ -inch spruce and see that it fits accurately between them. Now clamp the U so formed vertically in the vise with its two legs projecting exactly 2 $\frac{1}{4}$ inches above the vise jaws. Bend them

over at right angles in the same manner as before, and you will thus get the form shown in Fig. 334. For the clamp plate *C* cut from the sheet iron a piece $2\frac{1}{4}$ inches long by $\frac{3}{4}$ inch wide.

To make the clamp for round sticks cut from $3\frac{1}{32}$ -inch sheet iron a piece $6\frac{1}{2}$ inches by $5\frac{1}{4}$ inches, and then trim to the form shown in Fig. 335. As bamboo varies considerably in section from point to point, it is desirable to make each clamp to suit the dimensions of the bamboo at the point which it is to occupy. The dimensions given are therefore only approximately correct. The method of applying the clamp is shown clearly in Figs. 336 and 337, the two cross pieces of the T embrace the vertical and horizontal struts, while the stem portion passes round the long hori-

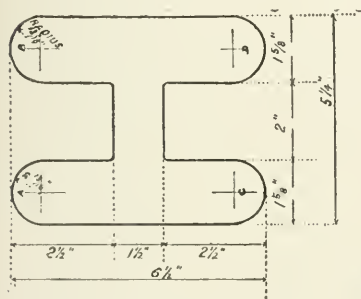

Fig. 335—Lay-out of clamp for bamboo

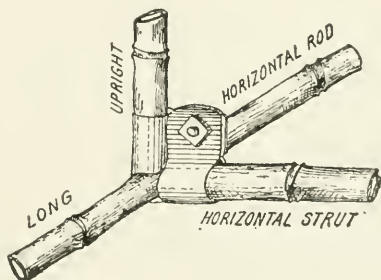

Fig. 336—Clamp for bamboo sticks

zontal rod. The clamp should be bent to shape as shown, a piece of 1-inch bamboo being used to mold the circular portions. The final adjusting of the clamp should be made when it is placed in position. The two flaps of one of the T pieces pass between those of the opposite one when bolting the clamp together.

We are now ready to assemble the frame, which for convenience should be made in two sections.

Take two of the 11-foot 7-inch lengths of spruce (one being the upper edge of one side of the frame and the other the lower edge diagonally opposite) and mark off on each distances of 4 feet 7 inches and 9 feet 2 inches from one of the ends. At each

of the points so found, and also at the end from which the distances were measured, clamp one of the 4-foot 11-inch and 4-foot 9-inch lengths of spruce in the manner shown in Fig. 334. To the free ends of the uprights and cross pieces attach the other two 11-foot 7-inch lengths in precisely the same manner. A rectangular cage or frame 9 feet 2 inches long by 4 feet 9 inches high will

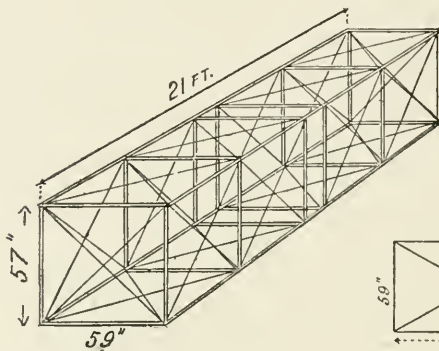

Fig. 337—General view of main frame

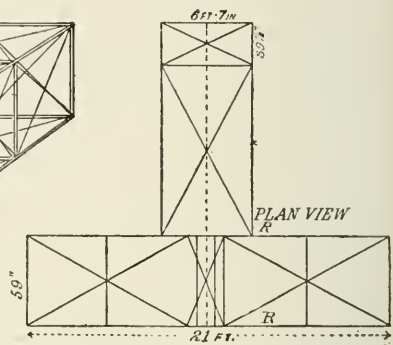

Fig. 339—Plan view of the complete frame

thus be formed, with the free ends of the longitudinal rods projecting 2 feet 8 inches from the end. Construct a similar cage out of the remaining rods. Place the two portions of the frame thus formed together so that the free ends of the longitudinal rods overlap, and lash each pair of the free ends together with strong



Fig. 338—An improvised turnbuckle

twine, making the framework 21 feet in length, 4 feet 9 inches in depth, and 4 feet 11 inches wide. (See Fig. 337.)

The guy wires necessary to strengthen the frames can now be attached. Cut a number of $\frac{3}{4}$ -inch lengths of small copper tubing. Take one of these, pass one end of the piano wire through it and

back again, forming a loop; bend over the free end of the wire and snip it off, leaving a small hook on the end to prevent it slipping back through the tube (Fig. 334). Pass the loop over one of the screw ends of a clamp, and run the wire to the clamp diagonally opposite, securing it there in precisely the same manner. The wires running diagonally across the frame can be fastened to the clamps by passing their ends between one of the sides of the clamp and the longitudinal rods in the manner shown in Fig. 334.

It is important that all the wires should be strained to approximately the same extent, and, as this requires some little skill to accomplish, it may be as well for the beginner to provide means for adjusting the tension of the wires after they are placed in position. An ordinary bicycle spoke introduced into the length of each wire, in the manner shown in Fig. 338, makes a good turn-buckle. One end of the divided wire is wrapped around the hub end of the spoke, the other end being secured to the spoke by a strip of thin sheet steel looped over the spoke nipple, as shown. The tension of the wire can then readily be adjusted by turning the spoke nipple.

The frame is now ready to receive the fabric. Three pieces of this must be prepared from the muslin, one 21 feet 3 inches by about 5 feet 2 inches, and the other two 5 feet 2 inches by 9 feet 6 inches. About 40 strips of spruce are required for the ribs. They should be about $1\frac{1}{2}$ by $\frac{1}{4}$ inches and 5 feet long. Lay the ribs on the fabric parallel to each other and spaced at equal intervals of about one foot. Strips of muslin should now be laid over them longitudinally and stitched down to the fabric, thus forming a sort of pocket, open at both ends, in which the ribs can slide. The large surface with ribs in position can now be laid on the upper deck of the frame, and the ribs lashed to the longitudinal rods by their ends at the front edge and at the point where they cross the rear portion of the frame. They will thus overhang the rear edge by about 1 foot. These overhanging portions are connected at their extremities by twine or piano wire, round which the rear edge of the fabric is lapped and glued. When this is dry

the cloth can be strained into position, the front and end edges being glued to the main frame. If strong glue is used this should prove sufficient fastening, but, if desired, the fabric can be tacked to the frame as well, using small tacks. The two other pieces of cloth are secured to the lower deck in precisely the same manner, a space of about 2 feet being left between them at the center. Two pieces of spruce $\frac{3}{4}$ inch by $1\frac{1}{2}$ inches should now be laid across this space from front to back about 18 inches apart and parallel to each other, and lashed to the frame with cord. They form the arm rests which support the operator. The glider is now complete with the exception of the tail, which is constructed in exactly the same manner as the main planes, the two sides, however, being covered with cloth in addition to the top and bottom. Its dimensions are given in Fig. 333. No ribs are required for the tail. It is connected to the main planes by the four rectangular rods of spruce $\frac{3}{4}$ inch square. The lower rods are lashed to the front and rear edges of the main plane about 2 inches apart, the rods being parallel to each other and spaced at equal distances on either side of the center of the plane. The other two rods are lashed to the rear edge of the upper plane and to the front edge of the tail. The tail is further braced to the main body by the piano wire in the manner shown in Fig. 333.

Curved surfaces, although not essential in a glider, can be produced in the following manner: Slightly taper the front portion of each rib for about $\frac{1}{3}$ of its length from the front end. If the front ends of the ribs are now lashed to the frame first, and the ribs are then pushed slightly forward by their rear ends before being fastened to the rear edge of the frame, they will assume a parabolic curve. Strong glue should be applied to all lashed joints to prevent them from working loose.

If bamboo is the material selected for the frame the following lengths will be required:

- 8 pieces, 11 feet 10 inches long.
- 12 pieces, 4 feet 11 inches long.
- 12 pieces, 4 feet 9 inches long.
- 4 pieces, 6 feet 7 inches long.

4 pieces, 2 feet $7\frac{1}{2}$ inches long.

2 pieces, 18 feet long.

A ground suitable for the practice of gliding must have a gentle slope of about 1 in 10, if possible in the direction of the prevailing wind. If due precautions are taken, there is little danger in the art of gliding provided the beginner commences cautiously and takes sufficient time to master the balancing of his machine before attempting long glides. While learning, it is best to have two ropes about 6 feet long attached to the lateral extremities of the machine, each rope being held by an assistant. The glider is thus prevented from ascending to a dangerous height above the ground, while the novice is learning to balance it. At first there is a tendency to place the weight of the body too far back, but this difficulty is soon overcome. Steering is effected by moving the legs. To turn to the right swing both legs in that direction, and *vice versa*. To stop the flight, move the weight of the body backward and at the same time swing the legs forward. This will cause the machine to tilt up in front and settle down.—87

AN INEXPENSIVE ICE YACHT

The following description of a junior ice yacht is not taken from a published article, or a design suggesting how to make a good boat, but is a description of one which has been already made, and

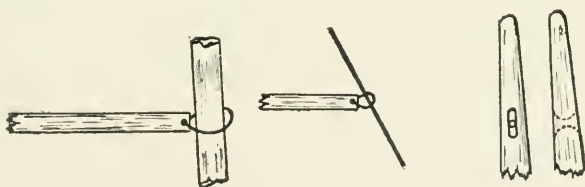

The mast and gaff rings and detail of the mast head

proven a marked success. While there were many boats alongside, made of all manner of designs and material, from the first-class boats designed by experts to the yachts made by the farmer boys, from fence rails and ice skates, with a table cloth or bed

sheet for sails, this particular one outclassed them all, for speed at any rate.

The material can be easily procured, in most cases from the lumber pile in the back yard or wood shed. But in any case it should cost but a few dollars complete.

The general view of the yacht is shown in Fig. 340, with the

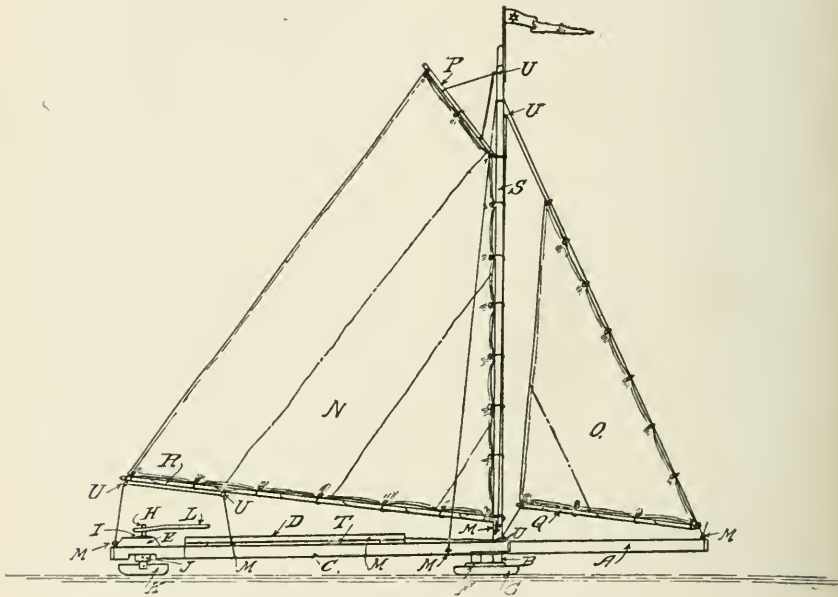

Fig. 340—General view of the ice yacht

various parts lettered to correspond with the details on Fig. 341, and the plan of boat shown in Fig. 342.

The backbone *A* is made from 3 by 4-inch pine, notched where shown, for the cross arm or runner plank *B* and the rudder *K*. The cross arm *B* is made from 2 by 8-inch timber. Two parallel saw cuts are ripped up the ends, 3 inches apart and 2 feet in length, one foot of which is cut away as shown. The other foot is to give pliability to the boat, should the side runners strike any

object when racing. The 2 by 1/4-inch recess at either end is to fit over the piece marked *I*, which bears on the upper side of the

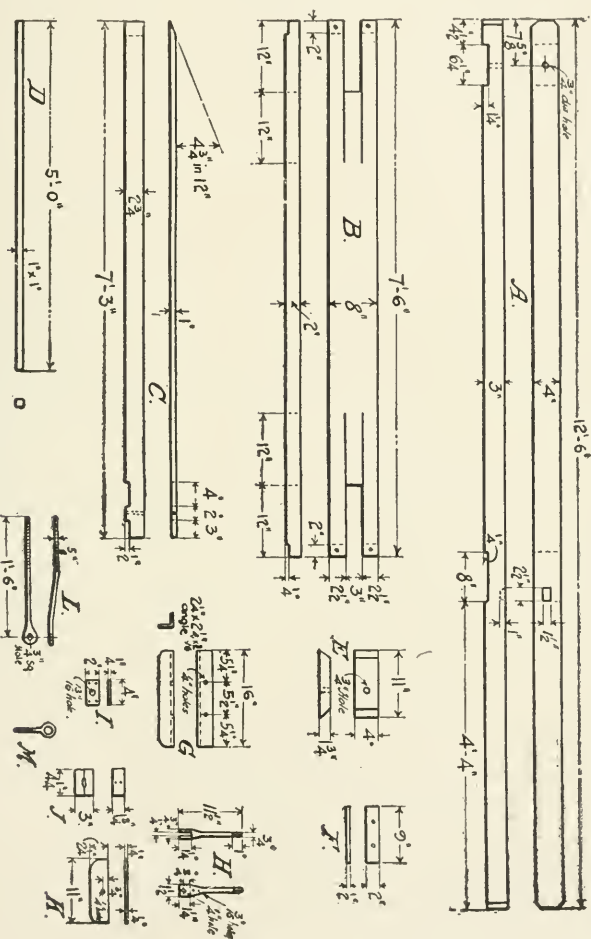

Fig. 341—Details of the yacht frame

runners *G*. Holes for 1/4-inch bolts are bored and drilled through each, as indicated. Find the middle of the cross arm, and secure

it to the backbone with spikes. A notch for the mast, one inch deep, is cut in the backbone with a chisel, and a $\frac{3}{4}$ -inch hole is bored in the end for the rudder.

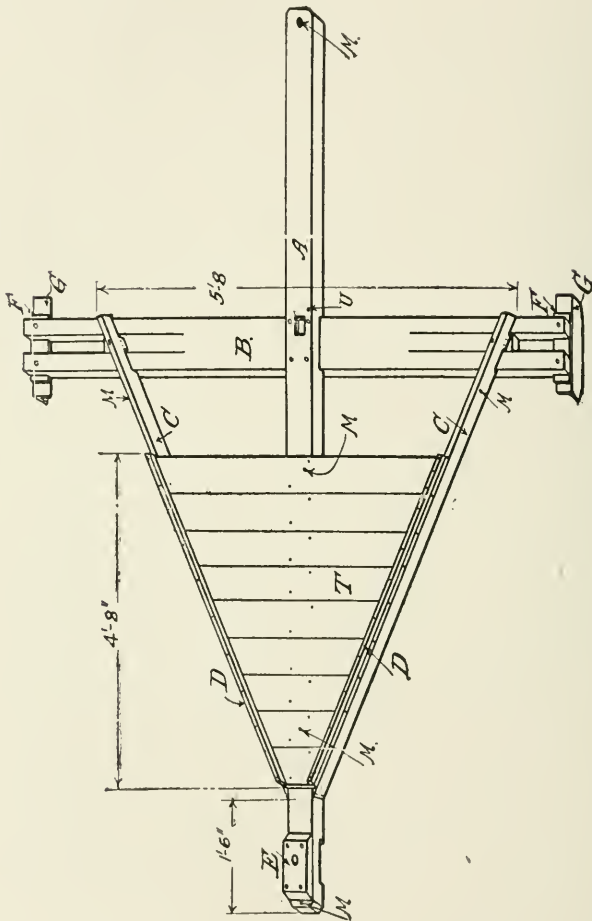

Fig. 342—Plan view of the frame

The side frames *C* are made from hardwood chamfered at one end $\frac{3}{4}$ inches in one foot. Care must be taken to make them right and left, or else cut the notches at the other end, the last

thing. These notches must be carefully cut, to escape the free ends of the cross arm when they spring. Referring to Fig. 342, their location will be seen. Secure the chamfered ends 18 inches

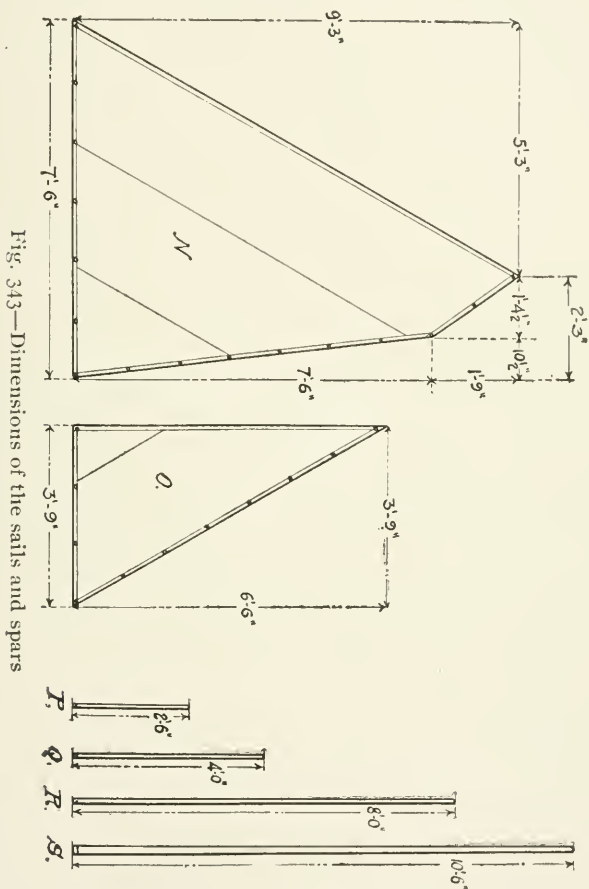

Fig. 343—Dimensions of the sails and spars

from the end of the backbone, spreading them 5 feet 8 inches apart, on the cross arm *B*, and nailing them to the 3-inch tongues with a single nail driven from the top, and with small toe nailing. Holes should be bored for the former. The flooring *T* can be

made from almost any kind of boards nailed to the sides *C*, and finished off with railing strips *D*, 1 inch square.

The side runners *G* are made from $2\frac{1}{4}$ by $2\frac{1}{4}$ by $3\frac{1}{16}$ -inch angles, though a piece of steel or iron, bent into shape, or even an old pair of skates will do. The heel and toe should be rounded off at the corners, the bearing edges being sharpened to a 45-degree V point.

The rudder blade *K* is made from a piece of steel $2\frac{1}{4}$ by $3\frac{1}{16}$ or $\frac{1}{4}$ inch thick, served in the same way as the side runners. A $\frac{1}{4}$ -inch hole is drilled as shown, for the jaw of the rudder stem *H*. The stem *H* had better be made by a blacksmith, from $\frac{3}{4}$ -inch round iron, flattened and split at the lower end to take the runner *K*. Two small holes are drilled a little above the jaw, for $3\frac{1}{16}$ -inch bolts, to connect the wooden block *J*, which is in two parts, and nailed together when in position, as clearly shown assembled in Fig. 340. A block of wood *E*, $1\frac{3}{4}$ by 4 by 11 inches long, tapered at the ends, is secured in position over the rudder stem, and the small plate *I* screwed down before the tiller *L* is put on.

The tiller is made from a $\frac{5}{8}$ -inch round iron, flattened at the end, and provided with a square hole, to fit the end of the rudder stem *H*. The other end can be wrapped with string or cloth to make it comfortable for the hands. Eight screw-eyes *M*, shown in Figs. 340 and 342 can be used to fasten the free ends of the ropes.

Fig. 343 shows the spars and plan of sails. The latter can be laid out on the floor of a room, using the corner to get the right angle necessary. The jib *O* is a right-angled triangle, having complementary angles of 30 and 60 degrees, but it will be well to lay out the sail by using the sides, 3 feet 9 inches and 6 feet 6. The mainsail *N* is laid out in the same manner, by using the corner of the room to obtain the right angle, and stepping back from the wall $10\frac{1}{2}$ inches and 2 feet 3 inches, to obtain the intersecting points. Allowance must be made for turning over, and eyelets can be worked in, about 12 inches apart. The sails can be made from ordinary sail cloth, linen, or, as in this case, of linen floor covering: care being taken to get the seams as shown, or the sail will not hang well.

The gaff *P* and the jib-boom *Q* can be made from dowel sticks or light curtain poles. A rope can be used in place of the jib-boom if desired. The main-boom *R* can be a pine stick, about $1\frac{1}{2}$ inches in diameter by 8 feet in length. Make the mast from spruce or yellow pine, $2\frac{1}{2}$ inches diameter at the heel, tapered at the top to about $1\frac{7}{8}$ inches. The heel is to be shaped to fit the $2\frac{1}{2}$ by $1\frac{1}{2}$ -inch mortise in the backbone *A*. With a pair of wire nippers and pliers, the mast hoops and sail rings can be made from copper wire. Holes should be bored in the ends of the booms and gaff for a ring, as illustrated.

Five small sheaves or blocks, with screw attachment, are connected at various points, marked *U* in Figs. 340 and 342, for the sheets and halyards, the free ends of which can be fastened to screw-eyes. Holes can be bored through the masthead for these ropes, as shown in the sketch, instead of using blocks, although the latter will give more satisfaction.

The shrouds and stay for the mast are fastened to the latter, about 1 foot from the top, and drawn through the screw-eyes when the mast is set up. The mainsail and jib are drawn up by ropes passing over sheaves or blocks *U*, and fastened to cleats, or else screw-eyes, on both sides of the lower end of the mast. About 65 feet of rope will be necessary all told, which should be of the finest quality for the mast shrouds and jib-stay. The pennant can be attached either to the head of the mast or at the end of the gaff *P*.

When sailing on smooth ice, the runners should be set to a sharp edge, but when the ice is soft, the edges need to be dulled a little. The mainsail need seldom be swung out of line too much, and great care should be taken when sailing before the wind. It will be well to take a few lessons before venturing out on too large a sheet of ice.

While it is a nice thing to be able to sail an ice yacht, it is a useful, and often necessary, accomplishment to know how to stop one. The boat should be thrown up into the wind, i. e., turned around to face the direction of wind, and the rudder turned at right angles to the side runners *G*. When turning around to go

in an opposite direction, a firmer hold should be taken, to avoid accident; it being no unusual sight to see a novice flung out of the cockpit at a tangent, and skimmed across the ice on all fours.—3

HOW TO BUILD A SCOOTER

The rudderless amphibious ice yacht called the "scooter" is a product of the sailors of the Great South Bay, Long Island. In former years, when the bay would freeze over solid, the regular ice yacht was a very familiar sight. Recently, however, the mild winters produced so little ice fit or safe for sailing that the sport almost died out. The conditions caused by these winters have been met successfully in that new and ingenious type of ice boat, the scooter. Roughly, the scooter is a Barnegat "sneak box" mounted on runners.

This craft will sail in the water as well as on ice, consequently the sailor does not fear soft ice or air-holes, but sails merrily along taking ice or water, whichever happens to be in his course. It is sailed without a rudder by simply trimming the sails and shifting position in the boat so that the point of contact of the rockered runner upon the ice is just under the center of effort of the sails. A single occupant sailing the boat sits about amidships, and holding the jib sheet in his hand pulls in or slacks out until the boat heads just as desired. When two are in the boat they spread their weight about an equal distance from the center; one shifts as required, while the other tends the sails.

A pole with a spike and a hoe is carried, a slight scratch of the former being sufficient to get the boat on her course, while the latter is used to pull the boat out of the water in case the wind dies out. An oar is also carried to steer while in the water, but this is not necessary when crossing an air-hole less than forty or fifty feet, as the speed of the scooter, with a good wind, is sufficient to carry her across and out on the ice again in jig time. This ability to pop in and out of the water constitutes a novel sensation and makes scootering a very fascinating sport.

Notwithstanding appearances to the contrary, the scooter is a

very speedy little craft and can make 30 miles an hour in a good steady breeze, running up to over 50 in a heavy puff.

The cost of a scooter is between \$100 and \$125, but it could be built at home by an amateur for about \$50.

The scooter shown in the accompanying plans is 14 feet in length and 4 feet beam. The sail area may be from 80 to 130 square feet, according to speed required and local weather conditions. The sail area in the plan is 114 feet and should make a good average rig. The construction is fairly heavy, making a serviceable boat. For pure racing it could be lightened considerably. Study the plans carefully before beginning work.

The first step in constructing the boat is getting out the side planks and spring them around "molds," which are simply temporary forms, to hold the elemental construction in place until it can stand alone and keep the boat in shape. The inner side planks are of $\frac{7}{8}$ -inch white pine and of the dimensions shown in Fig. 344 at *A*. The molds are next made, of $\frac{7}{8}$ -inch pine, and dimensioned according to Fig. *A*. The curves are arcs of circles and care should be taken to get the sides perfectly plumb, or else they will throw a twist in the side planks, and the upper edges will not lie in the same plane. The transom is $\frac{7}{8}$ -inch oak and the stem of oak, size as shown in Fig. *B*. It has a double rabbet, the inner for the inside plank and the other for the outer or covering plank. Screw the side planks to the stem and spring them around the molds and screw to transom. The molds are spaced 2, 4, 7, 10, and 12 feet from the stem head. This gives the rough form. Put the boat upside down on three saw horses and spring on the oak keel, which is 4 inches wide and $\frac{5}{8}$ inch thick. This makes a fair line for the frames, which are next put in. Make them of oak $1\frac{1}{4}$ inch thick and $1\frac{1}{2}$ inch deep, increased to about 2 inches along the center line of bottom in cockpit. They are spaced 10 inches on centers. Beginning, start the spacing 5 feet from the bow and 3 feet from the stern in order to come right for the cockpit opening. Then turn the boat over and put in the deck beams by the same method. They are $1\frac{1}{4}$ by $1\frac{1}{2}$ -inch spruce spaced 10 inches and fastened to the side and ribs by oak braces $\frac{3}{4}$ by 4

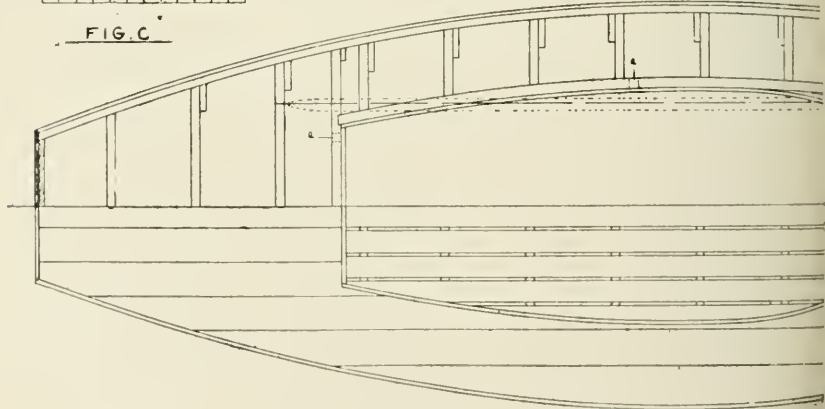
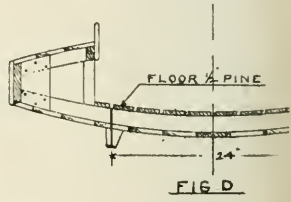
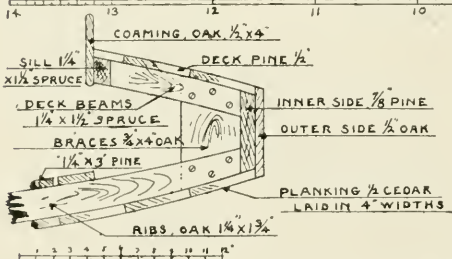
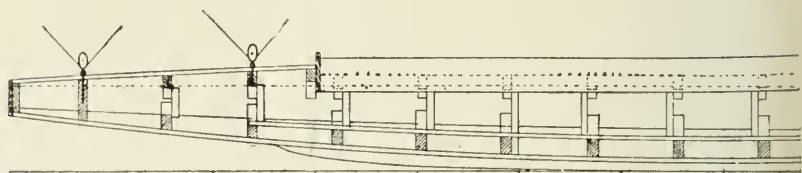
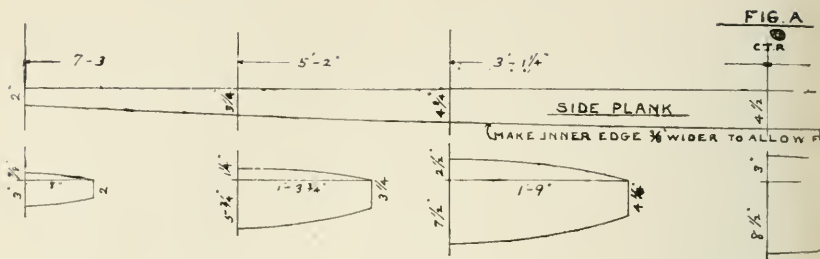

Fig. 344—Construction

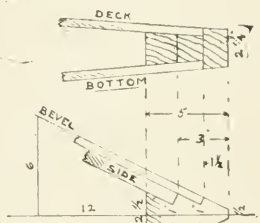
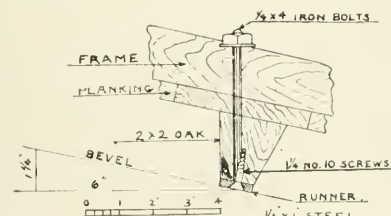
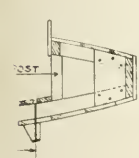
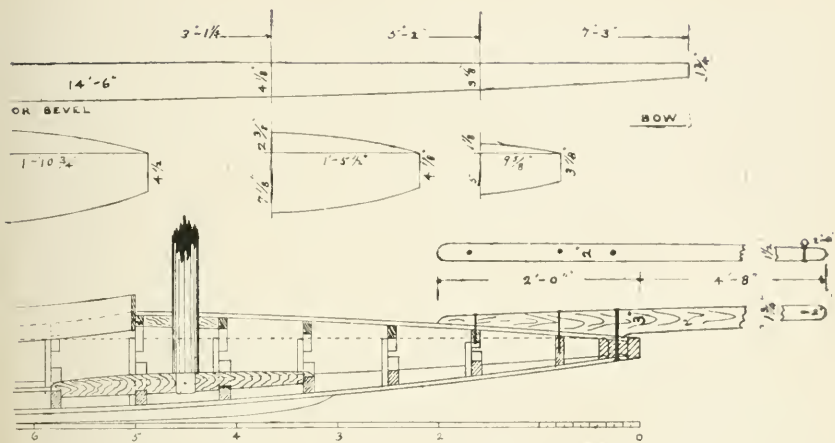
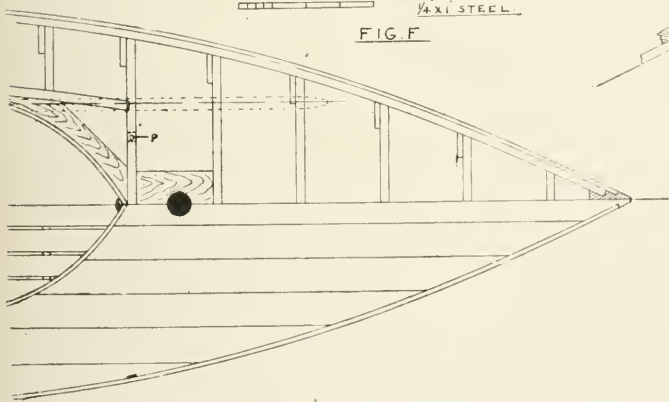

FIG. F

FIG. B



plan of the scooter



Fig. 345—Dimensions of the runners

inches, securely screwed together. Fig. C shows this clearly. A sill or stringer of $1\frac{1}{4}$ by $1\frac{1}{2}$ -inch spruce is run along cockpit side and a backing piece at the forward end is put in to take the curve of cockpit coaming. Posts are put in at the places marked *P*, to bind the deck and bottom together. The mast step is now put in. It is of oak, 2 inches deep and 5 inches wide, jogged over and $\frac{1}{2}$ inch into four frames and securely fastened thereto. A backing piece of oak $1\frac{1}{4}$ by 8 inches wide is also put in between two deck beams to take the strain of the mast. Now turn the boat bottom up and proceed to plank her. The planking is of white cedar $\frac{1}{2}$ inch thick laid in straight strips 4 inches wide. It is fastened to the frames with either brass screws or $1\frac{1}{2}$ -inch galvanized nails countersunk and puttied. The bottom is then carefully planed and sandpapered smooth, the seams calked with two threads of candle wicking and the whole given three coats of good lead paint. The runners are next put on, and with these be very careful. See that they are absolutely parallel and of the correct rocker and bevel. The distance between centers of runners should be 2 feet. They are of oak and shaped as shown in Fig. 345. The runner commences 3 feet from the bow and runs aft $8\frac{1}{2}$ feet. It is 2 inches deep amidships and reaches up at the ends. The middle 6 feet of the runner should have a rocker which is the arc of a circle with $\frac{1}{2}$ -inch curve in 6 feet. Referring to Fig. *F*, the outer edge of the oak stands plumb and is 2 inches wide at planking, tapering to 1 inch at face. The runner plank is fastened on with $\frac{1}{4}$ by 4-inch iron bolts set up on top of every frame. Carefully face up the runners by laying a straight edge across them both and fitting a bevel board. The bevel of the runners is $1\frac{1}{4}$ inch in 6

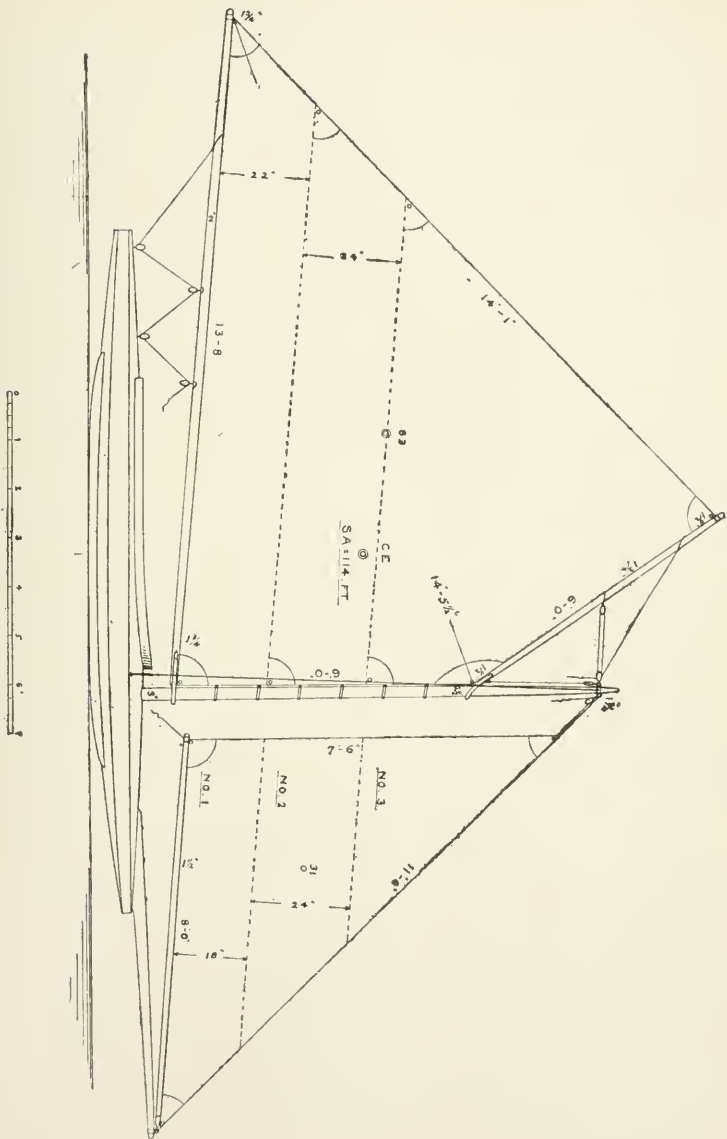

346—Sail plan of the scoter

inches or about $11\frac{1}{2}$ deg. Put on the shoes, which are of $\frac{1}{4}$ by 1-inch steel and 7 feet long. Bend them at ends so there will be no undue strain upon the screws, which are $1\frac{1}{4}$ inch, No. 10 size. The screws should be countersunk until they are flush with the runners, and their slots lie fore and aft. The steel shoe should be very smooth, with sharp, square edges.

Now turn the boat right side up and start finishing up the deck and cockpit. An oak partner piece $\frac{1}{2}$ by 5 inches is laid on center line of deck. A 3-inch hole is bored for the mast $4\frac{1}{2}$ feet from the bow. The bowsprit is next put in. This is of spruce, of the dimensions shown, and fastened with three bolts as indicated in the plan.

The deck is now laid. This is of $\frac{1}{2}$ -inch white pine or cedar laid in about 4-inch strips fastened and treated same as the bottom. Next the cockpit coaming is sprung in. It is of oak scant $\frac{1}{2}$ inch thick, 4 inches wide, and stands 2 inches above deck. Fasten to stringer with $1\frac{1}{2}$ -inch No. 10 brass screws countersunk and plugged with oak plugs. Lay a light flooring of pine in the cockpit in $2\frac{1}{2}$ -inch strips $\frac{1}{2}$ inch apart.

Now plane up the edges of the bottom and deck flush with the inner side plank and then put on the outer side plank. This is of $\frac{1}{2}$ -inch oak and comes flush with the deck and bottom. It is also carried around the transom, thus covering up the raw edges of the ends.

Now for the rig. All spars should be of straight-grained spruce. Mast $10\frac{1}{2}$ feet from step to truck, 9 feet 8 inches above deck, and 9 feet 3 inches from deck to center of band at top. To be $1\frac{3}{4}$ -inch at head, $2\frac{1}{2}$ inches at gaff, and 3 inches at deck. Make all the spars with a swell or barrel taper. Boom 14 feet, $1\frac{3}{4}$ inch at ends, 2 inches along middle. Gaff 6 feet 2 inches, $1\frac{1}{2}$ inch at ends, $1\frac{3}{4}$ inch in center. Jibboom 8 feet 2 inches, and about $1\frac{1}{2}$ inch tapering to $1\frac{1}{4}$ inch at ends. Fit wooden jaws to gaff and boom and use six mast hoops. A sliding rig is neater, but would cost a little more. Use a single $\frac{1}{4}$ -inch wire shroud with turnbuckles, the chain plate of steel $\frac{1}{4}$ by 1 by 7 inches long, to be fastened with rivets through the side planks. Eight small

$\frac{3}{8}$ -inch bronze yacht blocks are needed and can be obtained from a yacht chandler. Rigging to be of $\frac{3}{8}$ -inch rope. The sails should be of about No. 4 yacht duck. The mainsail to be fitted for two reefs, the first taking off 22 inches and the second 24 inches. Have a permanent forestay and put the jib on with snap hooks. For reefing, get two extra jibs as shown in sail plan and set them with a small sprit, if necessary.

The boat may be finished all over with three coats of spar varnish or painted white with buff-colored decks and varnished cockpit and coaming, which makes a very good finish.—50

A SIMPLE METHOD OF TAKING SPILINGS

A good device for taking spilings may be made by taking a thin batten marked *A* $\frac{1}{4}$ inch thick and 4 inches wide, 12 or 15 feet in length or more. Make a ruler ribbon the same length, $\frac{3}{8}$ inch thick and $\frac{1}{2}$ inch wide. Next take some brass wire *II* or *12*

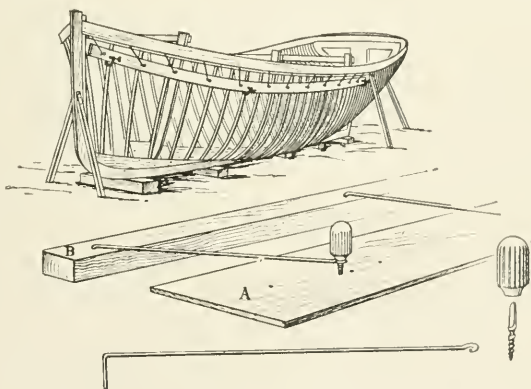

Fig. 347—A device for taking spilings

gage, cut about fourteen pieces into lengths about 7 inches long, bend one end at sharp right angles, which will just go through the ruler ribbons marked *B* and can be riveted with a small hammer so that it will not draw out. The other end is bent into a small eye, which is closed around a small screw. The screw has a groove filed around to receive the wire. It is best made out of a

screw hook, the hook being cut off, and just above the groove you have filed, flatten and drive on a small knob, which makes a thumb-screw like that illustrated. In manipulating the device, lay the batten on the boat frames so that it lies free and natural and take about three little clamps to hold it there. The ruler ribbon is engaged with the bottom edge of sheer strake and its entire length is easily held in place by connecting rods and thumb screws. This is very quickly and accurately done. The whole thing is removed, placed on a flat cedar board, and is quickly outlined along the ruler ribbon with a pencil. This gives an accurate joint for your plank. The usual way of determining the sweep of the plank is by laying on the thin batten and measuring distances along the edge of the sheer strake with dividers or a foot rule, which is a little complicated, not nearly as accurate, and considerably slower.—6

FORGING A MAST HEAD OR BOOM RING

On account of the severe strains to which the lugs on a mast-head are subjected, they and the ring are usually made from one

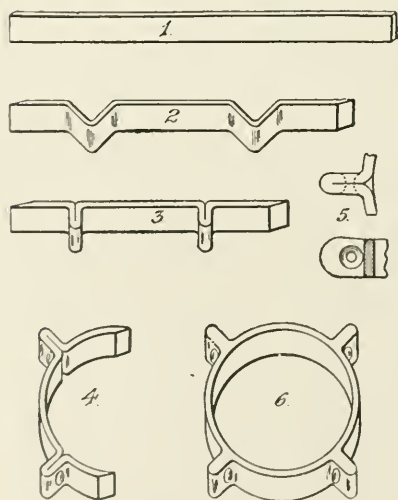

Fig. 348—Progressive steps in the forging of a masthead

and the same piece of iron, instead of the former being welded on after the ring is made. The ring is made in two halves, the iron being cut sufficiently long to make two lugs, and go half way round the masthead or ends of main or jib boom. The comparative length of the iron is given in Fig. 348 at 1. The diameter of the bands, of course, varies, and the section of iron used is in proportion. The position of the lugs is marked out, and the bar heated and bent into shape (2), the ends being shaped for welding, when the

two halves are brought together, to form the circle. The lugs are closed and welded on the next heat (3). At 4 is shown the half band, a similar one being made in the same manner. The holes for the wire ropes are countersunk on both sides, and are made at the roots of the lugs, close up to the bands. They are flattened out when being welded, their depth being a little more than the depth of the band, to give more metal in the direction of the pull.

To give a smooth surface on the inside of the band, a piece of metal called a "fish" is welded in the "gutters" formed at the roots of the lugs. These several details are shown at 5. The two halves are next welded, as shown in the completed band (6). The outside edges of the band, top and bottom, are rounded off, and all sharp corners on the lugs removed, to prevent any accidental wear on the ropes. The top of the mast or ends of the booms are cut down to a shoulder, the thickness of the bands in width, and the bands driven on.—3

TO INSTALL A MOTOR IN A SMALL BOAT

Small marine engines can be bought so reasonably now that many owners of small craft, skiffs, and canoes would install an

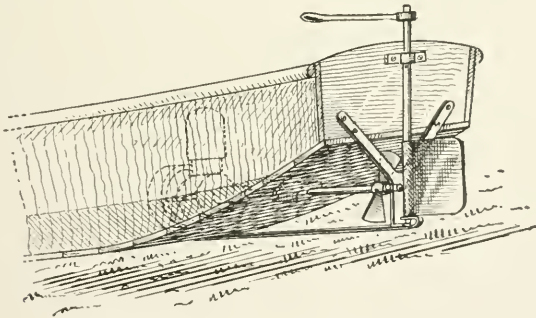

Fig. 349—Shaft bearing for a small boat

engine were it not for the trouble and expense of putting on a skag and shaft log. An easy way to overcome this difficulty is shown in the diagram. It has been tried by the writer, and is a success.

A shaft bearing is made of iron, in the form of a Y, and fastened to the stern of the boat to support the shaft. A longer piece is fastened to this and to the bottom of the boat to protect the propeller. A projection of this in the rear will carry the rudder. A small shaft log is fitted inside the boat, with the stuffing box on the inside, which can easily be packed from the inside without removing the boat from the water.—75

SIMPLE SUPPORT FOR BICYCLE

A very convenient device which may be attached to the side of a house or any other support, to hold a bicycle, is shown in the accompanying drawing. It consists of a gate hinge with one

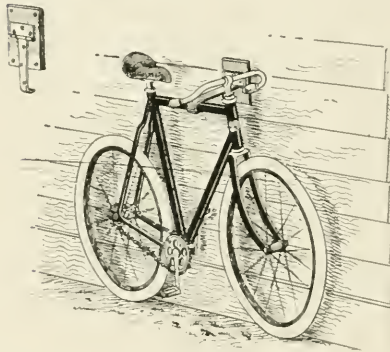

Fig. 350—Simple support for bicycles

leaf secured to a block. The block is nailed to the side of the house. The other leaf of the hinge, which should be a very long one, is bent over at the end to form a hook. This is caught over the upper horizontal bar of the bicycle frame. The bicycle wheels are placed close to the house, so that the upper part leans outward, and is held from falling by engagement with the hook.

HANDY METHOD FOR REPAIRING A PUNCTURED TIRE

The accompanying sketch shows a handy device for mending punctures in bicycle tires. It consists of a common darning needle of a large size and with a large eye, with its point inserted into a wooden handle. There are two pins also in the handle, projecting from opposite sides, and the top of the needle is cut off, leaving the end of the eye open.

To mend a puncture, stretch elastic rubber bands over the pins and through the slot in the end of the needle as tightly as possible until judgment shows that there is enough rubber to fill the punc-

ture. Then insert needle and rubber through puncture in tire, throw the rubber off the pins and withdraw the needle. The rubber being tightly stretched will contract when released, filling the puncture and leaving a small lump inside and outside of tire. This

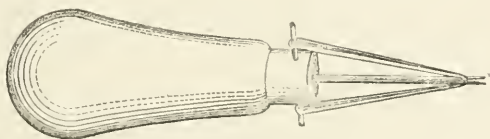

Fig. 351—A tool for repairing punctures

will wear off outside in a very short time. It is advisable to ream the hole smooth before applying the rubber. This can be done by heating the needle with a match and then searing the edges of the hole.—49

BICYCLE COASTING SLED

The accompanying drawing and photograph illustrate a new type of coasting sled built on the bicycle principle. This coaster is simple and easy to make. It is constructed of a good quality of pine. The pieces marked *S* are single, and should be about 1

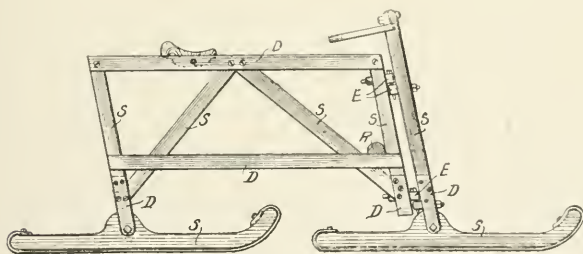

Fig. 352—Construction of the sled

by $1\frac{1}{2}$ inches; the pieces marked *D* are double or in duplicate, and should be about $\frac{1}{2}$ by $1\frac{1}{2}$ inches. The runners are shod with iron and are pivoted to the uprights as shown, double pieces being secured to the uprights to make a fork. The seat is a board, to

the underside of which is a block, which drops down between the two top slats and is secured with a pin. A footrest *R* is provided, consisting of a short crosspiece secured to the front of frame and



Fig. 353—Bicycle type of sled

resting on the two lower slats. The frame and front fork are hinged together with four short eyebolts *E* with a short bolt through each pair as shown.—20

COASTING SKATES

There are more ways than one of enjoying an icy hill. The accompanying illustrations show a pair of coasting skates. These skates can be well made by any amateur at little or no expense.

The base *1* is of hard wood and is 20 inches long. It is 3 inches wide at the middle, and tapers to 1 inch at either end. It is $1\frac{1}{4}$ inch thick and dressed off on the under side, as clearly shown at *2a*, leaving a flat section $\frac{5}{8}$ inch wide along the center line. The front end is curved upward, and a strap of iron or thin steel *2* is fitted to the flat section and serves as a runner. The ends of the runner are turned over upon the top of the base and held by

screws. No screws are necessary in the bottom. In use the ball of the foot rests at a point approximately midway in the length of the skate. A stiff strap, 3, preferably of metal and designed to fit over the toe of the shoe, is screwed or otherwise secured to the base at this point. This strap may be wrapped with padding if desired, but if properly shaped the padding is not necessary. A U-shaped iron as 4 is fixed to the base as shown, so as to prevent sidewise movement of the heel.

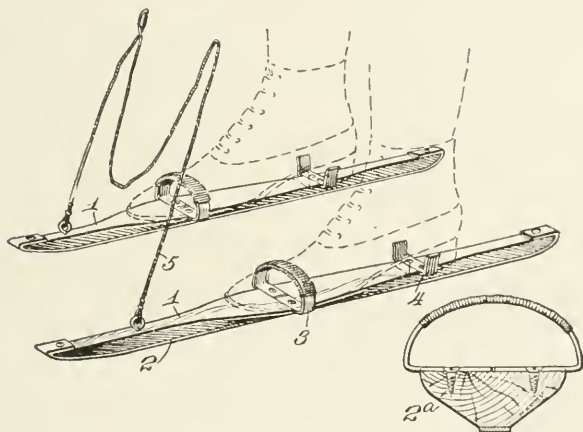

Fig. 354—Coasting skates

It will be appreciated that these skates may be readily removed from the feet after a coast down hill, and as readily readjusted at the top of the hill. To facilitate the use of the skates, a guide rope 5 is used. The opposite ends of this rope are secured to eyes, one in each of the skates at the forward end. When coasting, the rope is grasped in one or both hands, and held taut from the eyes.

—33

TWO WAYS OF IMPROVING A SLED

The accompanying illustrations show how an ordinary sled may be converted into a dirigible sled, and how it may be combined with a boy's hand car to make a motor sled.

THE DIRIGIBLE SLED.

Unlike the ordinary sled, that is steered by digging in the heels, or dragging the feet in the snow, from one side to the other, thereby checking the speed of the sled, the sled here shown has flexible runners, which may be curved to one side or the other by a steering bar, causing the runners to follow smoothly in the curving

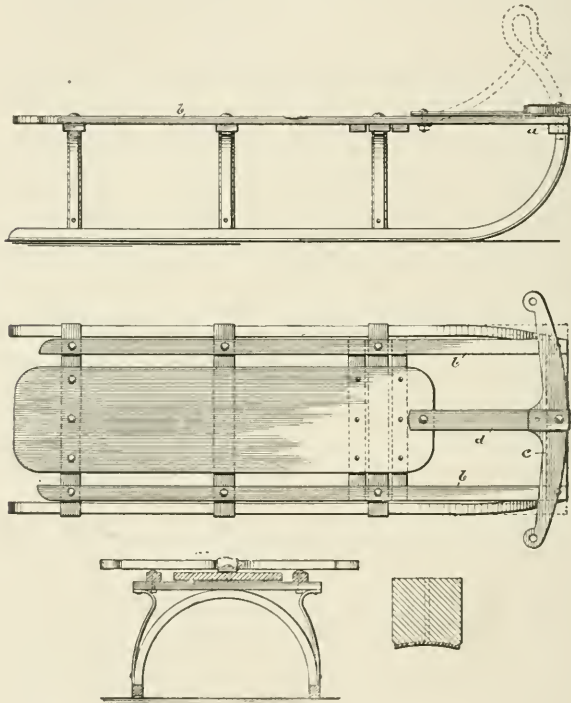

Fig. 355—A dirigible sled

tracks. The sled should be built low and narrow, and the runners should extend well forward and rearward, which will materially add to the speed of the sled when coasting down a hill.

Fig. 355 shows an ordinary girl's sled, which is made into a flexible or dirigible sled. The top part of the runners, shown

in dotted lines, is cut off on a level with the seat and the ends are fastened together with a transverse bar *a*, made of iron or wood. From this bar, and fastened thereto, are bars *b*, one on each side of the seat and parallel therewith. These bars are fastened to all the standards of the sled. On the front bar is fastened a steering lever *c*, which is fulcrumed by the rearwardly-extending arms *a* to the front part of the seat of the sled. It is now evident that

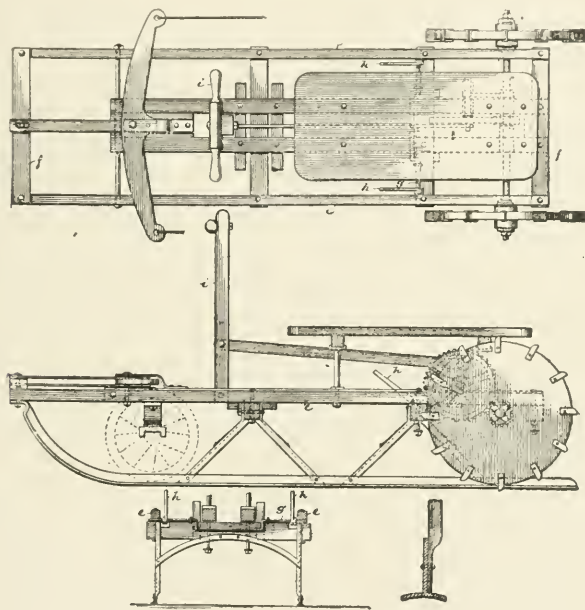

Fig. 356--The hand-motor sled

when the operator wishes to steer to the right, he presses the lever with the left foot, and *vice versa*. As the steering lever is thus moved, it will be noticed that it moves the transverse bar to one side or the other, thereby curving the runners in the same direction, which will then follow smoothly in the curved tracks.

It will be noticed from the plan view that the end standard is bolted to the seat of the sled, and that the other two standards

are not, so as to allow a free movement of the runners when operated upon by the steering lever.

Two pieces of wood should be fastened under the seat, a short distance each side of the forward standard, to allow for side movement.

The old iron shoes on the wood runners should be taken off and curved or hollowed as shown or may be replaced by new ones. By referring to Fig. 357, it will be seen how this curving of the shoe may be accomplished. A shallow groove is made in a block of hard wood, over which the thin steel shoe is placed. A short piece of round iron is laid on the shoe top; the latter is then hammered into the groove, assuming the hollowed or concave form.

Rivet the shoe on the runner, which should be hollowed out a little to fit. The object of the concave form of runners is the same as that of hollow ground skates. The outside edges have a tendency to dig into the ice or snow, and keep the sled in its course, or in "the same rut"; but when thrown out of line with the steering lever, they seem to take hold of the snow and change the course of the sled.

THE HAND-MOTOR SLED

The motor sled, which should appeal to almost any boy, is made by combining a flexible sled with an ordinary hand car, such as sold by toy dealers. The rear wheels are taken off and substituted for a pair of traction wheels, which may be thrown in or out of commission by a suitable lever, within the reach of the operator.

The sled may be of any steerable kind now on the market, or it can easily be built by almost any amateur, to suit the hand car to be used. The material may be bought from almost any hardware dealer. The runners are made for an ordinary size sled, from $\frac{1}{2}$ -inch by $\frac{5}{8}$ -inch T iron or steel, or they may be made from two angle irons riveted together. The base of the T should be bent or curved downward, so as to make it slightly dished out in the center. This can be done as before described.

The runners are now ready to be bent to suit the height of the sled. There may be two or more standards, according to the length of the sled. They can be made of angle iron, riveted to the runners, and fastened to transverse bars of wood at the top, and braced together if found necessary, so as to make them stiff.

To these standards are fastened, one on each side, and directly

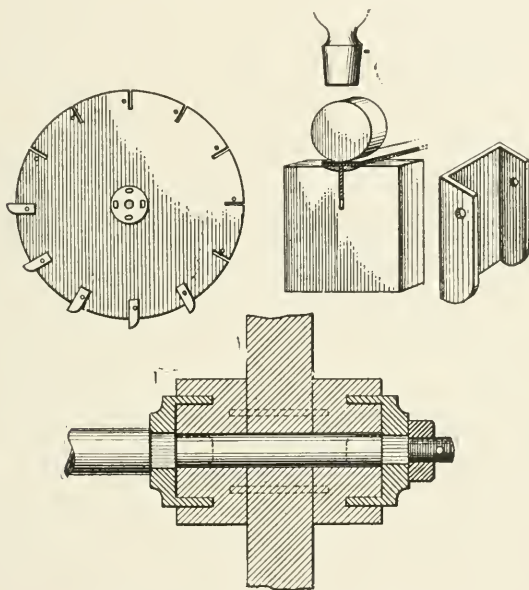

Fig. 357—Details of the motor sled

on top of each respective runner, wooden rails *e*. These rails are fastened together with transverse bars *f*, at the front and rear ends. Directly over the rear standard, and journaled into the outside rails *e*, is a crankshaft *g*, provided with suitable handles *h*. At the front end, and directly over the front axle, the steering lever is fulcrumed, and two extending arms fastened thereto, which are connected with the front bar *f* by a bolt passing through slots in the arms.

The sled is now ready to receive the hand-car, which is placed in the center of the same. The front end is fastened to the outside rails *e* with a long bolt, forming a hinge for the car.

Long bolts with nuts at their lower ends are now passed through the frame of the car into the rear transverse bar, also into the rear standard. Two pieces of wood may be nailed or screwed to the rear standard, forming a guide for the up-and-down movement of the car.

It will now be seen that by moving the handle *h* to the rear, the crank *g* will lift the rear end of the hand car relatively to the sled, thereby elevating the traction-wheels from contact with the ice or snow. It will also be seen that the handle *b* will rest on top of the standard, and that the crank *g* has passed the center of the shaft, and is consequently locked in this position.

The traction wheels are made of hard wood. First cut out a disk (see Fig. 357) about the same size as the wheels of the car. Then cut a number of radial slits in the periphery of same, into which are inserted small galvanized-iron buckets, and riveted thereto. Small round disks are now fastened to either side of the large disk, so as to make the proper length of the hub. Into these small disks are made four elongated recesses, to fit the four outward-extending prongs of the fixed collars on the shaft, and when screwed together with the nut on the outer end thereof, will keep the large disk fast on the shaft, and will rotate with the same.

The sled may be propelled by operating the handle *h*, and steered by means of the foot-lever, like the sled described above.

It will be possible to propel the sled up a hill, or go a round-about way to get there. Then by throwing the lever *h*, the traction wheels may be elevated above the runners, so they will not interfere with coasting down hill.—5

REDUCING THE RANGE OF A RIFLE

The country has recently been flooded with old model Springfield rifles. While these are very fine guns, they have too long a range for use in a thickly-populated region. As the writer could

not use a rifle that carried over two hundred yards, he reduced the range by the following method:

Taking an empty regulation shell, 0.45 caliber, the head was bored out so that a 0.44 caliber revolver cartridge would fit snugly. Then the head of the regulation shell was turned out, so that the



Fig. 358—Reducing the range of a rifle

head of the revolver cartridge would be flush, as shown in accompanying sketch. The writer is using these cartridges up to a hundred yards with good results.—57

ANOTHER METHOD OF REDUCING THE RANGE OF A SPRINGFIELD RIFLE

First pull out the ounce ball that comes in the loaded shells. Then clean out the powder, and reload with 20 grains if black powder is used. Cover this with a tight-fitting wad. Then fill the shell with fine sawdust, coarse cornmeal, or something of that nature. Next force in a round ball of 44 caliber with a patch of strong cloth that is thick enough to make a snug fit. The benefit of the patch is that it prevents leading of the rifling. The government loading tool crimps the shell at the muzzle. This crimp must be taken out before reloading the shell. The sawdust and wad clean the gun at every firing.—41

CHAPTER IX.

MODEL TOY FLYING MACHINES

A SIMPLE MONOPLANE

As it now has been proven beyond doubt that the flying machine is no longer a thing of the imagination, but has come to stay as a fixture for future Wrights, Bleriot and Curtisses to improve upon and make it a thing of commercial use, so now is the time to think of the flying machine as a source of instruction to the young folks as a toy or model.

We already have numerous small models on the market which will fly after a good deal of experimenting, coaxing and alterations, but as a source of pleasure are absolutely out of reason with the young folks.

Small machines can be made by anyone familiar with the principle of flight, and having made several small aeroplanes, two of which were very successful, I will endeavor to explain how I made them, so that anyone interested can make a small aeroplane that will fly.

There are several successful types of aeroplanes, but for models or toys two have proved most satisfactory, the monoplane and the biplane. Although I made one triplane, which was fairly successful, I still think the monoplane or biplane more satisfactory. Which of the two is the better must be left to the option of the intending maker. As in the real flyers, both have their advocates, and both types are successful in flying. We have the recent flight across the English Channel of Bleriot and the endurance trials of Latham for the monoplane, and the very successful demonstrations of the Wright brothers for the biplane, but, as a question of construction for the young beginner, I think the monoplane is the simpler and more easily made.

Personally, my first small real flyer was a monoplane: it was a

very simple flyer and took but a few hours to make. To be sure, I had to do a good deal of experimenting so as to make it fly in a given course, regardless of the direction of the wind. I had always been very fond of kite flying, and it was only the thought of being ridiculed that kept me away from kites. Now, here was a chance to try something new. I came to the conclusion that I could make a monoplane to use as a kite without much trouble.

I first procured a piece of straight-grained whitewood, 12 inches long and $\frac{1}{4}$ inch square, smoothed it down until it was

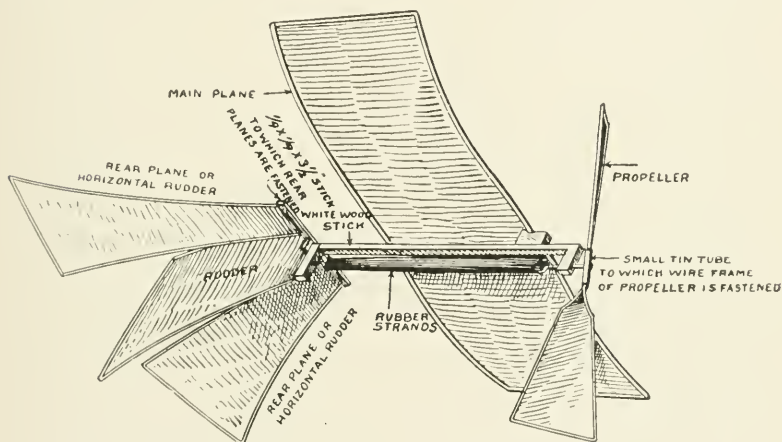

Fig. 359—Details of the monoplane flying machine

straight and true. To this stick I nailed two small blocks $1\frac{1}{2}$ inches long, 1 inch wide and $\frac{1}{4}$ inch thick, to form the body of my aeroplane. (See Fig. 359.) Then I took some round $\frac{1}{8}$ -inch rattan, and after soaking it a short time in hot water to make it more pliable, I bent it to the shape of the main plane. The ends of the rattan, where they meet in the center, were fastened together by a small piece of very thin tin $1\frac{1}{2}$ inches long and $\frac{1}{2}$ inch wide. I rolled it into a sort of tube. The tube was slipped over the ends of the rattan and two pins were driven through the tin and rattan, fastening it to the body of the aeroplane.

Over this rattan frame I spread white silk, cut very carefully to the proper size, allowing $\frac{3}{16}$ inch for turning it over the rattan, and sewed the silk on with a fine hemstitch. The rattan was very soft and still very damp, which would leave the silk in a wrinkled and drawn condition. To overcome this I squared my corners as nearly as the rattan would allow me and fastened the plane to a flat board with broad thumb tacks, leaving it to dry thoroughly. When it was perfectly dry, the few remaining wrinkles were ironed out and the plane was perfect.

Next, I secured some stiff wire, such as is used by milliners, bent it to the shape of the two horizontal and vertical rudders, and covered it with silk, allowing $\frac{1}{8}$ lap. The silk was glued on with thin diluted fish glue. The vertical rudder was stiffened by covering it with a coat of diluted glue on both sides, then the whole was set aside to dry. The rudders were fastened at the rear of the aeroplane, the two horizontal rudders to serve as rear planes and at the same time to control the up and down motion, and the vertical rudder to guide the motion left or right.

The aeroplane was now complete, and it took but a few trials to ascertain the proper place to fasten the string to make it soar like a kite. It would go up in the air without any difficulty, and remain steady, no matter how hard the wind blew. It made a very pretty effect when up in the air, giving no trouble, such as an ordinary kite would, and when one gave a steady downward pull, as in winding up the cord, it would circle around, the circles growing smaller and smaller as the aeroplane came down to the ground.

To convert it into a power-driven machine, I bought some rubber strands, $\frac{1}{16}$ inch square and about 1 yard long. A small hook was screwed into the block at the end of the body and a small hole through the block at the front.

The latter was faced with a piece of tin. A piece of wire forming a loop hook at one end was passed through the front block and formed the propeller shaft. The propeller was made like the rudder, of silk stitched over a wire frame. It was a two-bladed affair and was given three coats of glue, making it very stiff. The rubber strands were now fastened together at the ends and

looped over the two hooks. The rubber was then twisted by turning the propeller in the opposite direction to that in which the aeroplane should turn to make the aeroplane go forward; then when the propeller was released, the rubber strands untwisted, making the propeller revolve in the right direction to force the aeroplane forward through the air.

The aeroplane was now a finished flyer, and for the first trial

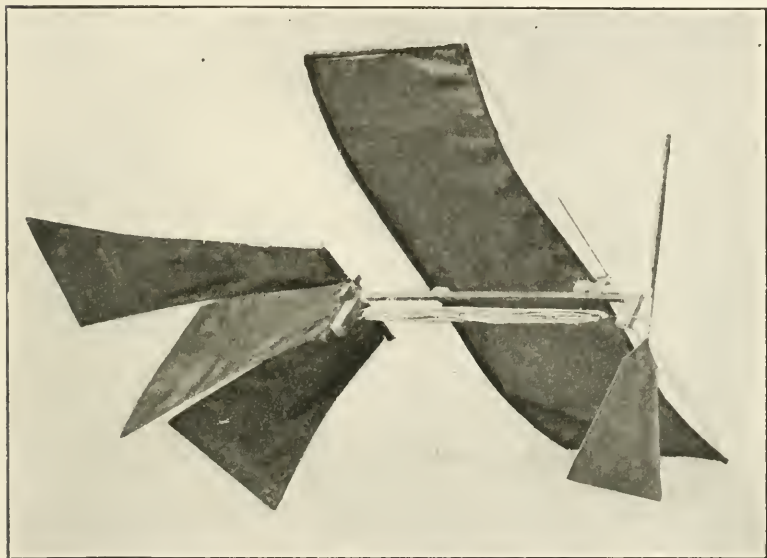

Fig. 360—A model monoplane flying machine

I twisted the rubber strands about 50 turns, released the propeller, and watched it fly away from me. Needless to say it almost smashed itself against the house, but after a few trials the proper adjustment for the rear planes and rudder was found, the toy flew easily from 100 to 150 feet in any direction, and at a height of about eight feet or more. By bending the rear planes up and down the elevation of the aeroplane could be varied, and the vertical rudder was used to make it go to the left or right.

If everything is made as described, and the main plane exactly centered on the body, the forward end slightly raised by a small block 1 inch long, and tapering from $\frac{1}{2}$ inch high at the front end to $\frac{3}{16}$ inch at the rear, fastened at a point near the front end of the body, there will be no need of a balancing weight to make the machine stay right side up.—93

DIVIDED MONOPLANE

Among various toy monoplanes on the market is one with a divided main plane, designed to rise from the ground after running along on three wheels until it has gathered sufficient momentum. A rubber tube is used, in place of rubber strands, to propel it, for the reason, probably, that it does not take so many turns to get enough power to run the machine. While rubber strands take more turns when winding up, they give more power to the propeller, even after being more than half spent, because of their greater elasticity.

Although the design may be criticised because of its heavy construction and the fact that the main plane is divided, the details of the machine are given herewith for the amateur to improve upon or experiment with. By closing the gap between the plane with very light silk I got a flight of over 100 feet before I made any other adjustments. I also found that by using a lighter body frame and a larger propeller I could get greater flights, though no higher than five feet from the ground.

The body of this aeroplane is constructed of wood, as shown in Fig. 361. The front brace measures 11 inches long, $\frac{1}{2}$ inch wide and $\frac{3}{16}$ inch thick, the rear brace $7\frac{1}{2}$ inches long, $\frac{1}{2}$ inch wide and $\frac{3}{16}$ inch thick, and the three bamboo sticks 15, 16 and 17 inches long by $\frac{1}{4}$ inch thick. To support the planes, an umbrella rib is used, while the wheel support and propeller guard are made of stiff wire. After making the braces, bore a hole $\frac{1}{4}$ inch diameter in the front brace at $\frac{1}{2}$ inch from one end and another hole 8 inches from the same end. Bore $\frac{1}{4}$ inch hole in the rear brace as well, $\frac{1}{2}$ inch from end, and also one in the center; then bore another $\frac{1}{4}$ inch diameter hole on a slight slant $\frac{3}{4}$ inch

below the center hole. These holes are for the bamboo sticks. Take the 16-inch bamboo stick and insert it into the upper hole (8 inches from the end) of the front brace, and into the center hole of rear brace. Should the fit be too loose, take a few turns of paper around the sticks and force them into the holes, using fish glue if necessary to hold them firmly. Now take the 17-inch stick and insert it into the lower ends of both front and rear brace. The stick will have a slight curve, which will be found necessary,

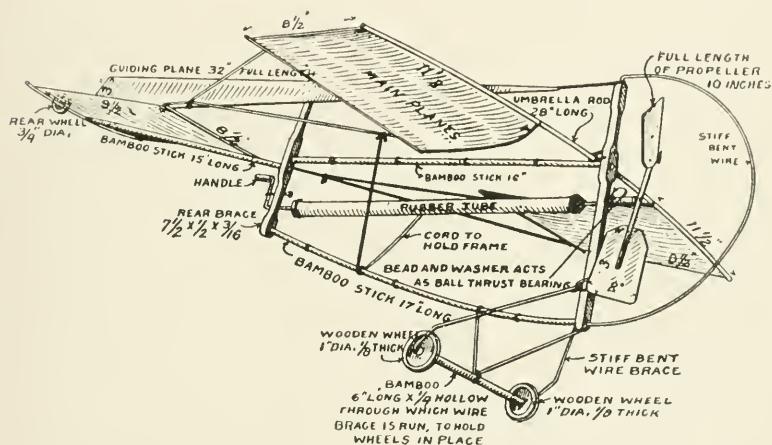

Fig. 361—Construction of the monoplane with divided front plane

for without this curve one cannot use the rear wheel as a means of support for the aeroplane while rolling along the ground in starting. Put the 15-inch stick into the hole below center of the rear brace and you now have the body complete.

Before proceeding any further, look around for an old useless umbrella and take out a rod not less than 28 inches long. If longer cut it to size with a pair of cutting pliers, and carefully open up the rod where the pliers pinched it together in cutting. Cut also two pieces of $11\frac{1}{2}$ and two pieces $8\frac{1}{2}$ inches long; then two pieces of silk 12×9 inches for the front planes and 10×9 inches

for the rear plane; the extra $\frac{1}{2}$ inch allows for all seams, which should be sewed with finest hemstitch possible.

After the silk has been sewn as directed, fasten the center of the 28-inch rod to the front brace and over this slip one of the large planes at one end, sew it into position, then take the 11 $\frac{1}{2}$ -inch length and insert in the opposite end; do the same with the other side and you have your main plane finished. Now take the small 8 $\frac{1}{2}$ x 9 $\frac{1}{2}$ -inch plane and at each end insert the 8 $\frac{1}{2}$ -inch rod, which is the width of the rear plane, fasten it to the extreme end of the 15-inch rod. Get what is termed cable cord (any other strong cord will do just as well) and run it from right end of the main plane to the right end of the rear plane and back to the opposite or left end of the main plane. Do the same with the other main plane and you have completed (except for the power mechanism) the aeroplane.

To make the propeller, take a rod 7 inches long, drill a small hole through the exact center and flatten the rod at each end for about $\frac{1}{2}$ inch. Then take stiff tin and cut out two 2 x 3-inch blades for the propeller. At 1 $\frac{1}{2}$ inches from the end of the blade cut a slot to receive the end of the rod which is bent over and hammered down. Bore two small holes near the inner end of the blade end for a piece of copper wire, which is looped over the rod to secure the blade. Run a stiff piece of wire through the hole in the center of the rod and fasten it. This is the propeller shaft. Pass the wire through a piece of bamboo 1 $\frac{1}{2}$ inches long, then insert an ordinary glass bead and small copper washer. The bead and washer will act as a ball thrust bearing when the rubber is twisted to give power. The wire shaft is then passed through a hole at the center of the front brace and bent to form a hook.

Another piece of stiff wire is bent to form a crank handle and is threaded through a bead and washer, after which it is passed through the small hole bored at 2 inches from the lower end of rear brace, and a hook is formed on the inner end. The rubber tube is now looped over the two hooks.

For the wheels, almost any circular article will do. Large 1-inch buttons can be used to good advantage, or any small and light

wheels from some broken toy. Make the axle of wire, inserted through a piece of bamboo 6 inches long. Bend the wire as shown in the photograph and fasten the wire to the front brace. To brace the wheel, tie the axle in the position shown. At the extreme end of the rear plane fasten another wheel, and the aeroplane is complete, as shown in Fig. 362.

To make the aeroplane fly, turn the handle (holding the propeller at the same time) about 50 to 75 times if rubber strands

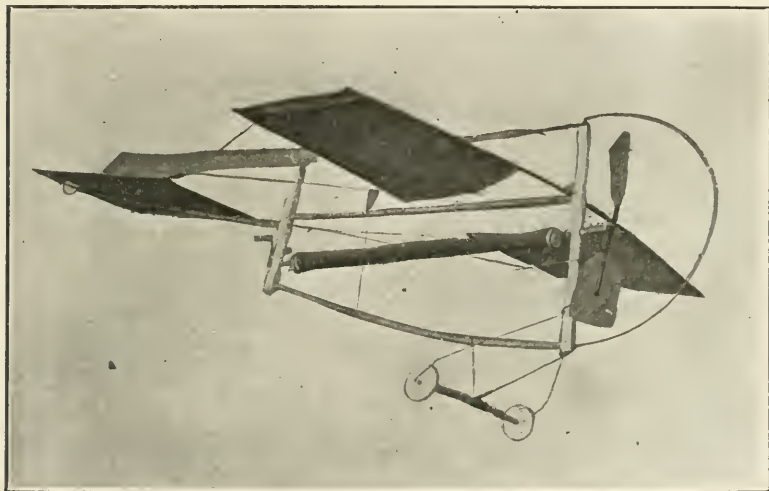

Fig. 362—A monoplane with divided front plane

are used, and if tube is used about 20 to 30 times are enough for the first trial, release the propeller after having placed the aeroplane in position on the ground, and it will then fly, if everything is adjusted properly.

A good help in experimenting will be to bore a small hole a little below the handle and insert a small wire to act as a stop. Such a stop may also be used to a good advantage for the propeller. The guiding plane at the top of the aeroplane is made from silk 3 inches wide and 32 inches long, and it is used to help

keep the aeroplane on a straight course. It also may be done away with entirely, as it is not absolutely necessary. After a few trials the maker will know just what proper adjustments are



Fig. 363—A monoplane model in flight

necessary for the best results. Fig. 363 shows one of these toys in flight. An excellent view of one of these machines is also to be seen in our frontispiece.—93.

"WRIGHT" BIPLANE

One of the finest looking little aeroplanes that has as yet been offered by toy dealers is almost an exact duplicate in miniature of the "Wright" flying machine. It will fly from 20 to 40 feet, according to the skill of the operator in launching it into the air. One must master the knack of sending it out into the air properly before he can hope for any great length of flights, and he will find it at first a very awkward proposition.

The motive power is a wooden propeller mounted on a wooden shaft 24 inches long and $\frac{3}{8}$ of an inch diameter, which fits into a hollow handle. This handle is the launching gear. Near the end of the shaft, about $1\frac{1}{4}$ inches from the end, is a small hole through which a string is threaded; the propeller is then turned until the string is wound upon the shaft, and then, when ready to fly, the cord is given a long, steady, and yet swift pull. This revolves the propeller with great rapidity and forces the aeroplane into the air. After a few trials, to determine the force necessary to launch the little flyer, one can become quite expert in the knack of making it go.

In this little flyer there is a great deal of room for experimenting, as it is of the lightest construction, and yet is strong enough to withstand those hard knocks it is subject to receive when landing. For instance, one can alter it very slightly to have it driven by rubber strand power. It would simply be necessary to brace it with a small $\frac{1}{8}$ or $\frac{1}{4}$ -inch rattan stick, running from the front to rear, then attach the propeller to rubber strands and twist them, as is done with the other types. I did this with one and got flights of from 60 to 100 feet without any trouble.

The construction of this aeroplane is very simple and at the same time strong. The materials used are rattan, silk, and small, very thin pieces of brass.

For the main planes, take $\frac{1}{8}$ -inch rattan and cut four pieces 23 inches long, and twenty-four pieces 3 inches long. Out of very thin light brass cut the corner braces to the shape indicated at *A*, in Fig. 364. Bend them at right angles, along the dotted line, so

as to form three-way braces, as seen at the corners of the aeroplane in Figs. 365 and 366. Eight of these corner braces will be enough to make the main planes. The brace is wrapped around the meeting ends of the rattan. First make two oblong planes out of

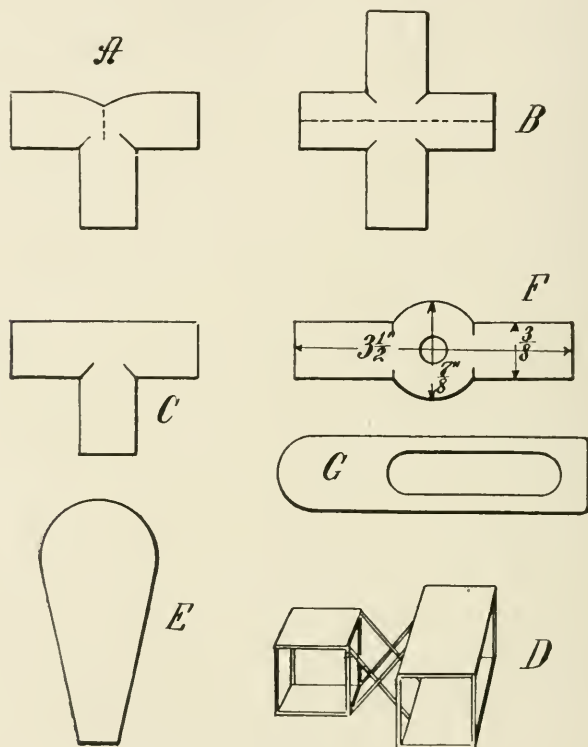

Fig. 364—Details of the biplane

the four 23-inch strips and four of the 3-inch strips and cover them with silk. Fasten the two planes together at corners with 3-inch lengths. If the corner braces were properly made you will find at each corner two little pieces of brass for the end struts. Fasten by bending the brass around the strut. Put in the first

brace 5 inches from the end of the plane. To do this, cut out of light brass 16 small holders of the form shown at *B* (Fig. 364). This makes a four-way holder. Place the cross-shaped piece of brass against a longitudinal strip along the dotted line and bend the brass around the rattan tightly. This leaves two pieces for the

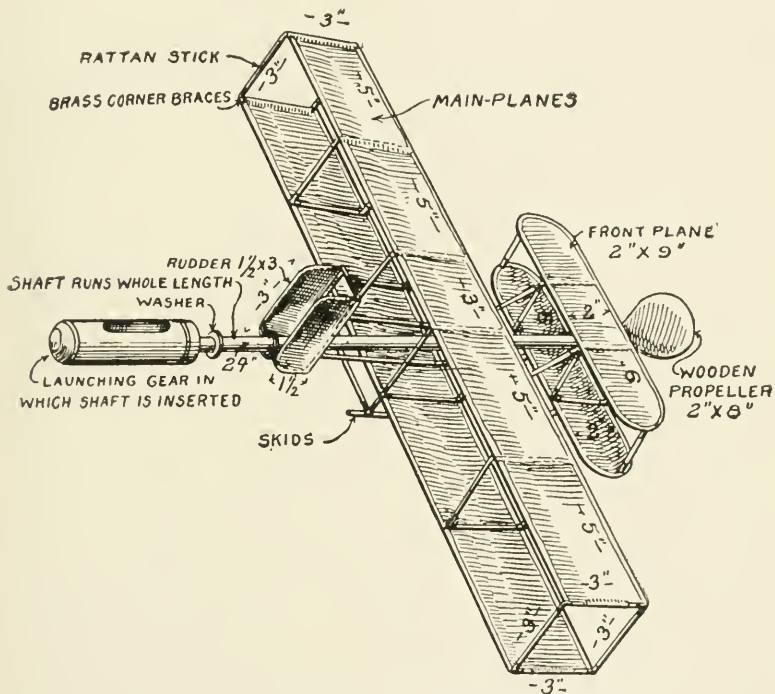

Fig. 365—Dimensions of the biplane flying machine

vertical and horizontal 3-inch lengths. The two frames are similarly braced at 10 inches from each end.

To make the front planes (2 by 9 inches) take two pieces of rattan $9\frac{1}{2}$ inches long, and at each end fasten a two-way holder, made from a piece of brass cut as at *C* (Fig. 364). The rattan will then take the shape of the front plane shown. After having fast-

ened the rattan firmly, cut a piece of silk to the proper shape and sew it in position. Make the bottom plane in the same way. At 3 inches from the end put in the struts, as in the main plane, except that the small piece of rattan across the front plane will be but 2 inches long. Put in another set of struts at 3 inches from

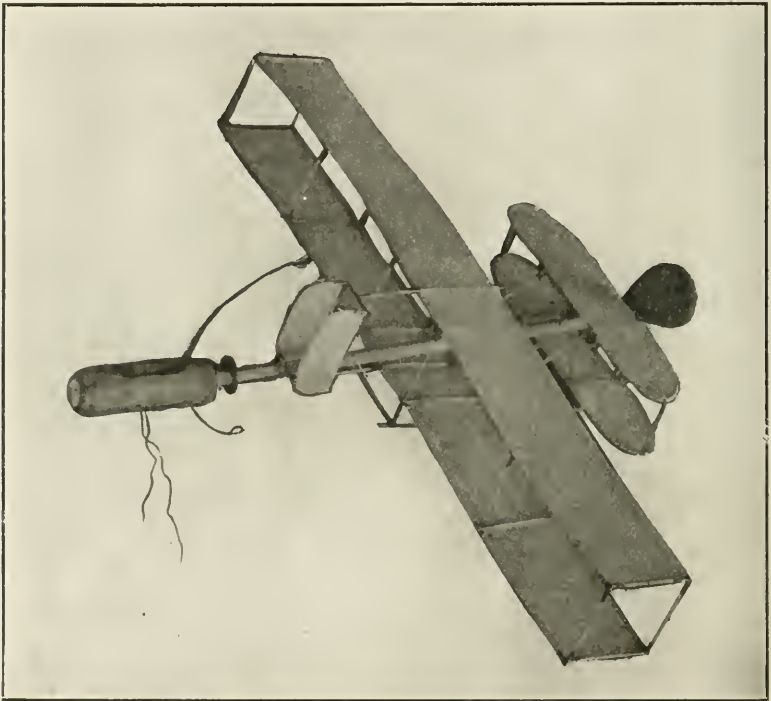

Fig. 366—The toy "Wright" biplane

the first set. Now fasten in place at each end the remaining strut shown in Fig. 365, and the front planes are finished. To fasten the front planes to the main planes, take four pieces of rattan, 6 inches long, and connect each end to the main plane, and to the front plane, so that they cross each other, as at *D* (Fig. 364).

The center 3-inch section of the main plane should be opposite the 3-inch section of the front planes.

For the rudder, take a piece of rattan $4\frac{1}{2}$ inches long and another piece 3 inches long. Bend the longer piece and fasten it to the 3-inch piece with a three-way brass holder. The frame will take the shape of the capital letter D. Cut two pieces of rattan $1\frac{1}{2}$ inches long and, after making the second D-frame, fasten them as shown in Fig. 365, and sew on the silk. This done, cut two more pieces of rattan 5 inches long, fasten them to the front end of the main plane frame, so that they will pass over the rear end of the frame, and extend 2 inches beyond. To these two pieces of rattan fasten the rudder with a two-way holder. Of course, the rudder is absolutely in the center of the aeroplane.

To make the propeller, take a small wooden disk $\frac{3}{4}$ inch diameter and $\frac{1}{2}$ inch thick, make the edge absolutely smooth and flat, in the exact center bore a hole $\frac{3}{8}$ inch scant, then cut in a slanting direction from one edge to the other a small saw cut about $\frac{3}{32}$ inch deep and reaching from edge to edge $\frac{3}{4}$ inch. The two cuts must be exactly opposite each other, and exactly in the same direction, for this is the hub of the propeller, and the cuts are to hold the two blades. Take a piece of $\frac{1}{8}$ -inch thick whitewood and mark out the shape of the blades, which should be 2 inches wide at the top, $\frac{3}{4}$ inch at the bottom and 4 inches long. Make the top slightly rounded, as indicated at *E*, (Fig. 364), and cut them out carefully. Sharpen the edges and sandpaper them until they are as smooth as glass, then glue them on the saw-cuts in the hub. For the shaft, get a piece of very straight doweling, $\frac{3}{8}$ inch diameter and 2 feet long, sandpaper it smoothly and fasten the propeller at one end with a small screw, so it can be taken off the shaft whenever desired. Bore with a gimlet a small hole about $1\frac{1}{4}$ inches from the end, opposite the propeller. Procure an iron washer with a $\frac{3}{8}$ -inch hole, and force it out to the shaft about 3 inches—this is to serve as a bearing against the handle that is used as the launching gear. To fasten the shaft and propeller, cut from thin brass two holders shaped like *F* (Fig. 364). Cut a hole a little larger than $\frac{3}{8}$ inch through the center.

Fasten one of these braces to the lower end of the rudder, just above the curve, and the other brace at a point between the upper and lower frame of the front planes.

The launching handle is a piece of round wood $1\frac{1}{2}$ or 2 inches in diameter and 3 inches long. Bore a hole through the center from end to end. This hole should be about $\frac{7}{16}$ or $\frac{1}{2}$ inch in diameter. Enough play should be given to let the shaft revolve very freely. After the hole is bored, take a small scroll saw and cut lengthways along the handle, starting from a point about $\frac{1}{2}$ inch from the end, make a sort of long, oval cut, coming back to the starting place, as indicated at *G* (Fig. 364). One end should be rounded so that it will not hurt the hand when in use. Around the other end loop a piece of strong, stiff wire; make the ends long enough, so that when the shaft is inserted into the handle the ends of the wire come under the main planes. By looking at Fig. 365 one can clearly see how the handle and wire are used when ready to launch the aeroplane.

To complete the aeroplane, take the propeller off the shaft and inserting the shaft through the shaft braces at the rudder and front planes, then fasten the propeller on the shaft at the front.

To manipulate this little aeroplane, hold it by the handle, and see that the wire rests are underneath the machine, then take a piece of strong cord about a yard long and, by turning the propellers in a reverse direction, wind up the cord on the shaft; the cord will all be contained inside the handle (if the handle is cut as described). Pull the cord steadily and hard, and the propeller will revolve with great speed, and when a sufficient momentum is gathered the machine will glide away into the air.

It will take quite a few trials before flights of any length can be obtained, but with patience and a little experimenting as to the best positions to hold the aeroplane, one will be surprised at the results he can obtain with this little flyer.—93

THE AEROPLANE KITE

One of the cheaper variety of toy aeroplanes is made to resemble the biplane, and is used as a kite. It has a very simple construc-

tion and will give good satisfaction in flight, if rising into the air at the end of a string can be called flight. It will rise in the slightest breeze, and if properly adjusted, so as to let the wind strike the planes at an angle, will need no balance to keep it from "dodging" around as a tailless kite would. With the kite there is furnished a small bag of sand weighing about 3 or 4 ounces. This is tied to a long string and serves, in case of necessity, as a "tail" or balance in high winds.

To construct, cut four sticks 25 inches long, $\frac{1}{4}$ inch wide and $\frac{1}{8}$ inch thick, and four 28 inches long, $\frac{1}{8}$ inch thick, $\frac{1}{4}$ inch wide.

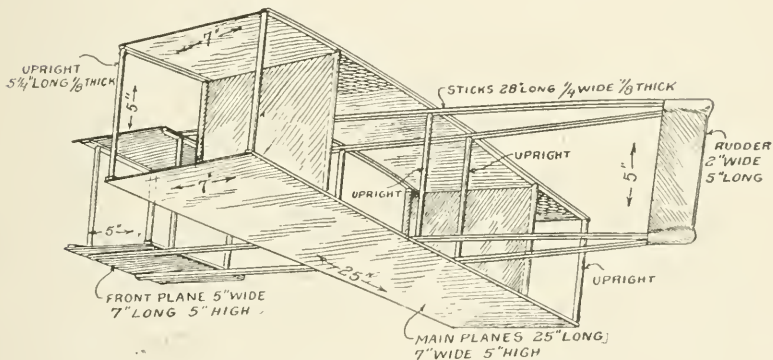

Fig. 367—Details of the aeroplane kite

Get some $\frac{1}{8}$ -inch round dowling and cut thirteen pieces 5 inches long. Take the four 25-inch sticks and bore a $\frac{1}{8}$ -inch hole $\frac{1}{2}$ inch from each end. In two of the sticks bore another $\frac{1}{8}$ -inch hole 11 inches from each end. These two sticks form the rear edges of the main planes. Now, in the other two 25-inch sticks bore two more $\frac{1}{8}$ -inch holes $10\frac{1}{2}$ inches from each end. Cut from some good, light quality muslin two planes, 7 by 25 inches. Glue the cloth to the sticks with a good fish glue, being careful to get the sticks exactly at the edge of the cloth. While the main planes are drying, make the front planes. Cut four small sticks 7 inches long, of the same width and thickness as the other sticks, then

bore a $\frac{1}{8}$ -inch hole $\frac{1}{2}$ inch from each end. Take some more of the muslin and cut the front planes 5 inches wide and 7 inches long, gluing them to the frame sticks. Now, take the four 25-inch sticks, and at each end bore a $\frac{1}{8}$ -inch hole. Bore another hole in each stick 5 inches from one end. These sets of holes serve to receive the 5-inch upright struts. Now, again bore another $\frac{1}{8}$ -inch hole 6 inches from the last hole bored, and still another 7 inches from the last, and the parts are ready to be assembled.

First, take the front planes, and after having inserted the four

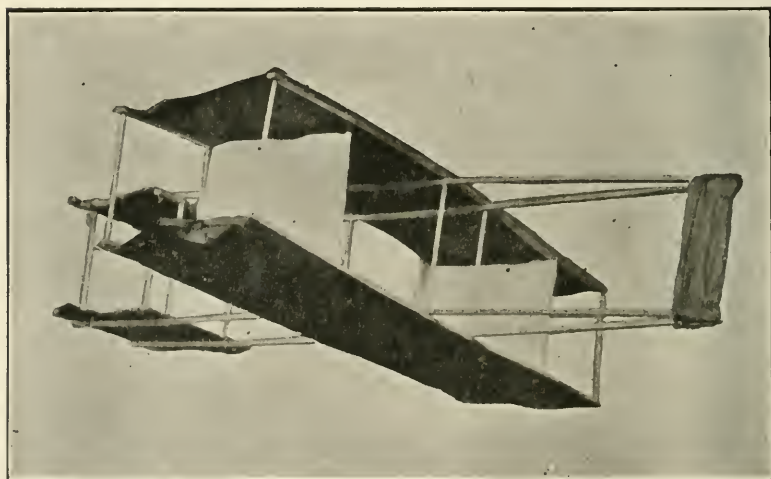

Fig. 368—An aeroplane kite

5-inch upright struts in the holes, take the four 28-inch sticks, and at the ends where the holes are 5 inches apart, insert the 5-inch uprights, the cloth of the planes being cut to let the upright come through the 7-inch sticks into the 28-inch sticks. The two main planes are similarly connected with 5-inch struts, the four center ones passing through the 28-inch pieces as well. The latter pass between the planes, as shown in Fig. 367. The rudder frame sticks will come together at the rear. Cut a piece of muslin 4

inches wide and 5 inches long. Fold it lengthwise and sew it together at each short end, leaving the 5-inch edge open. This forms a sort of a pocket, which is to be slipped over the rear end of the 28-inch sticks and sewed in position to form the rudder. The forward side of the pocket should be left open, and it serves to steady the aero-kite in the wind, at the same time serves as a drag to make it fly front end first.

To fly this kite, fasten a loose loop just a little in front of the main planes. The exact position must be found by experiment, as each kite has its own peculiarities. To this loop fasten the kite string and proceed as with any ordinary kite.—93

N. B.—We are indebted to John Wanamaker, New York, for the use of the models described and illustrated in the four foregoing articles.

A NOVEL MONOPLANE MODEL

The model monoplane, illustrated herewith, was designed and built by Mr. Jas. K. Dalkranian, of Weehawken Heights, N. J. It is the most successful model of this type of machine that has been flown at the meetings of the Aeronautic Society. When started from the gallery in the great banquet hall in the club house of the Automobile Club of America—at a height of about 20 feet—it would frequently travel the entire length of the hall—100 feet—with perfect stability.

The body of this model consists of a rectangular frame $43\frac{1}{4}$ inches long by $2\frac{1}{2}$ inches wide. About 6 inches back of the front edge of the frame and 4 inches above it the main plane, $31\frac{1}{2}$ by 7 inches in size, is placed. It is mounted upon V-shaped verticals that extend down to a keel 10 inches below the body. An oval horizontal rudder, $8\frac{1}{2}$ by $4\frac{3}{4}$ inches in size, is pivoted out in front of the center of the panel. This rudder can be set horizontal at the start while the model is running along the floor. A strip releases and allows a spring to turn it upward slightly when the machine has attained speed enough to soar.

The tail is placed about 6 inches from the rear end of the main frame. Its dimensions are $17\frac{1}{2}$ by 6 inches. The V-shaped surface

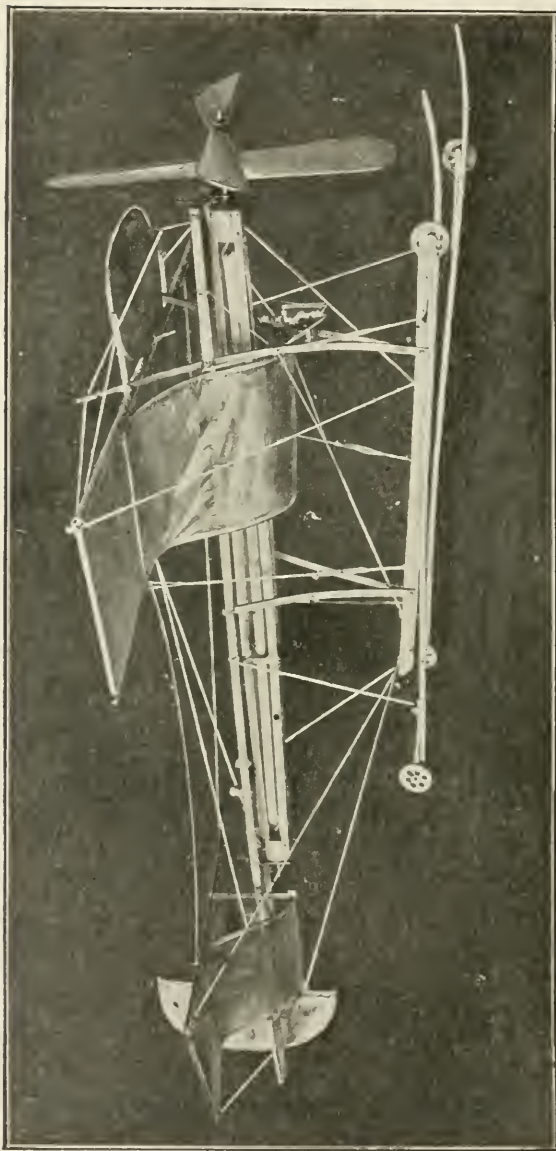

Fig. 369—A novel monoplane model.

below it extends downward 4 inches and has a projected surface of 10 by 6 inches. The corresponding V in front extends downward about 6 inches and has a projected surface of 15 by 7 inches. The vertical rudder is 8 inches high by 4 inches wide. It has a surface of about 20 square inches.

The motive power consists of a single rubber tube having its two ends joined so as to form a band 18 inches long, which is stretched to about 2 feet. This tube is about $\frac{1}{8}$ of an inch thick and $\frac{3}{8}$ of an inch in diameter. It is stretched upon two rubber-covered hooks. The hook at the rear is securely fastened in the block, forming one end of the elastic frame, while the one at the front passes through a tube in the forward block and carries the front propeller, which, of course, is secured to it. The tube through which it passes is secured to the front block of the elastic frame and carries the rear propeller. To wind up the elastic, hold one propeller and turn the other. The propellers are $13\frac{1}{4}$ inches in diameter. The blades have a projected width at the tips of 2 inches, while their real width is $2\frac{3}{16}$ inches. They are $\frac{7}{8}$ inch thick at the hub. The pitch of these propellers is about 18 inches. Each propeller makes about fifty turns, and the machine travels 100 feet.

The machine is mounted upon skids 29 inches long and 10 inches apart. These are split at the ends, the light halves having wheels. Ordinarily the weight can be supported on the wheels, but when the machine strikes ground the split ends give and the main skids take the shock. There are also elastic braces from the body to the skids, and a number of strong guys running to the keel.

THE "DIABOLO" FLYING MACHINE

Some ingenious Frenchman has conceived the idea of modernizing the game of "Diabolo" to the extent of using a toy aeroplane instead of the top or double cone. The scheme is illustrated in Fig. 370, which clearly shows the construction of the apparatus. The body of the aeroplane is a wooden stick, which is curved upward by means of a bow string. A bird's head at one end of the stick gives weight to the forward part of the aeroplane, and

also provides an attractive headpiece for the device. The device is of the divided monoplane type, the main plane consisting of two sails attached to a pair of steel wire stretchers. The forward

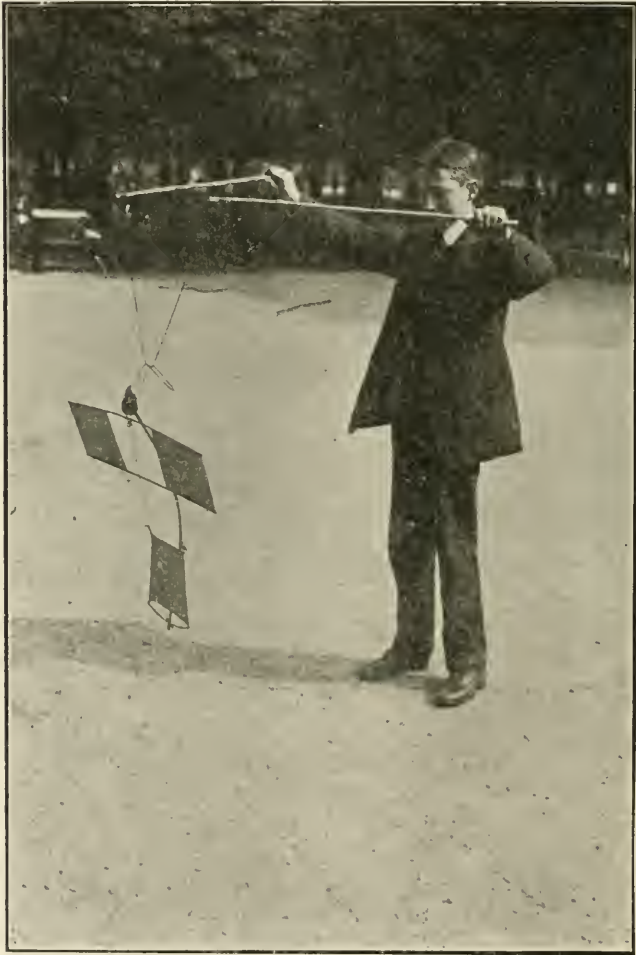

Fig. 370—The "Diabolo" flying machine

stretcher is tied to the head of the aeroplane, while the rear stretcher is connected to the forward corners of the rear sail planes by means of four light cords. A light metal crosspiece is secured to the rear end of the machine, and to this crosspiece the rear plane is made fast. The forward end of the rear plane is tied down to the body stick, giving the sail planes a concave or dished set, which tends to direct the machine upward when it is launched in the air. A large wire hook is attached to the prow of the machine, and the device is slung into the air after the manner of the "Diabolo" by means of a cord caught under the hook and fastened to two light sticks that are held in the hand. The hook is quite open, so that it will readily clear the string when the aeroplane is slung off. The game consists of throwing the device in the air and catching it again on the string as it returns, only to throw it up again. The device describes a very graceful curve in the air, and may be thrown to a height of sixty feet or more. It makes a very fascinating game, and requires considerable dexterity to catch the aeroplane on the string as it is falling to earth.

INDEX

	PAGE	PAGE
A		
Accident preventer, the motorist's	395	
Aeroplane, kite.....	448	
Aeroplanes, model, toy.....	434	
Airship, one-man, how to construct	396	
Air thermometer, home-made.	189	
Alternating current, experiments with, using direct current motor	306	
Alternating current motor, home built.....	263	
Aluminium and gold solder... 152		
Aluminium, how to solder... 153		
Aluminium solders	150	
Anchoring work to be soldered	110	
Anemometer, electrical.....	192	
Anti-freezing outside faucet..	362	
Appelbaum's compositions....	138	
Augers, gage for.....	90	
Automobile axle, straightening	390	
Automobile house, portable..	369	
Automobile, to convert buggy into	378	
Autotransformer	283	
Axle, bent, straightening....	390	
B		
Babbitting, how to support a shaft when	101	
Bag, tool, boiler maker's....	76	
Ball, turning of	105	
Balloon, dirigible, how to construct	396	
Barometer, home-made	184	
Barometers, scale for.....	188	
Batteries, electrolytic rectifier for	283	
Battery, dry, how to make... 261		
Battery, dry, restoring.....	262	
Battery, storage, without chemicals	258	
Battery, voltaic, handy form of	261	
Battery, weak, getting home with	387	
Bearings, engine, taking up..	391	
Bell circuits, transformer for.	279	
Belting, substitute for leather.	90	
Bench hook	13	
Bicycle coasting sled.....	425	
Bicycle, gyroscope made from	195	
Biplane, "Wright".....	443	
Bismuth solder	129	
Bismuth solders, mold for... 132		
Blast, continuous	113	
Blow pipe	114	
Blow pipe, home-made.....	121	
Blue roses	210	
Boat, to install motor in....	423	
Boiler, cast iron, how to mend	341	
Boiler, hydraulic test for....	174	
Boiler maker's tool bag.....	76	
Boiler, method of patching..	174	
Boilers and radiators, cast iron, mending	342	

	PAGE
Boilers, patch for.....	340
Book rest, or music stand....	314
Boom ring, or mast head....	422
Bottle, cracked, mending.....	355
Bottle, heat retaining.....	334
Brake shoes, relining.....	394
Brass solder	137
Brick, to drill through.....	94
Broiling pan, double bottomed	339
Broken screw, to replace.....	82
Broken springs, temporary repairs to	392
Bronze aluminium, a solder for	152
Buckled castings, straighten- ing	175
Buggy, to convert into motor buggy	378
Bushings for locomotive cyl- inder, boring	170
Butt joint, nailing a.....	83

C

Cabinet, a corner	15
Cam groove, cutting with a lathe	158
Carbon disulphide, some ex- periments with.....	206
Carbon, scraping from the piston heads	388
Carpenter's clamp	51
Carpet stretcher, an improved	326
Castings, buckled, straighten- ing	175
Cellars, flooded, ejector for draining	358
Center of a shaft, method of finding	101
Centering work under a mill.	167
Centers of round work, device for finding	100

	PAGE
Channte-type glider, how to build	401
Chemical experiment with io- dine	214
Chemical perfume, home- made	211
Chemical puzzles.....	203
Chest, a shoulder.....	18
Chuck with spring-actuated collet	159
Clamp, a quick.....	55
Clamp, carpenter's.....	51
Clamp, clothes-pin.....	64
Clamp, saw.....	55
Clamp, saw, an improved....	57
Clamps, two handy.....	52
Cliché alloys.....	134
Clinching a nail.....	84
Clock mechanism for opening furnace drafts.....	345
Clock springs, device for punching holes in.....	98
Closet, convenient hanger for.	325
Clothespin on the handy man's workbench	64
Clutch leather, putting on a new	393
Coasting skates.....	426
Coasting sled, bicycle.....	425
Coffee pot, electric.....	338
Coil, a simple medical.....	250
Coil spring, another method of making.....	70
Coil spring, spaced, how to wind	69
Coils, machine for winding...	256
Compass, a clothespin.....	64
Cooker, fireless, an electrical.	330
Cooker, fireless, cheaply con- structed	328
Cork, simple method of pull- ing	351
Corner cabinet.....	15

	PAGE		PAGE
Crank-pin bearings, taking up.	391	Drilling holes in marbles.....	93
Crankpin turning device....	168	Drills, holder for broken.....	90
Crankshaft bearings, tightening	392	Drills, simple driver for.....	91
Crate, tabouret made from...	316	Driver for small drills.....	91
Curves traced by elastic pendulum	196	Driving a nail.....	82
Curves traced by rotagon apparatus	219	Dry battery, how to make....	261
Cylinder bushings, boring....	170	Dry battery, restoring.....	262
D			
D'Arcet's metal.....	130	Earthquake, locating.....	228
Decorations from paper pulp.	321	Earthquake recording instrument	223
Desk or drawing table.....	20	Ejector made of pipe fittings..	357
Detector, a simple wireless telegraph	294	Elastic pendulum.....	196
Detector, electrolytic.....	296	Electric coffee pot.....	338
Detector, magnetic, construction of.....	300	Electric engine.....	249
"Diabolo" flying machine....	453	Electric light globes, chemical flasks from.....	178
Die sinker, cutting keyways on	165	Electric motor, oscillating....	233
Die, thread cutting without...	68	Electrical anemometer, how to make	192
Direct current motor, experiments with alternating current	306	Electrical fireless cooker:....	330
Dirigible balloon, how to construct	396	Electrical laboratory.....	230
Distilling fresh water from sea water.....	180	Electrical paradox.....	309
Dog for lathe, correct shape..	161	Electricity, static, ringing bell.	247
Dog, handy planing.....	63	Electrolytic detector.....	296
Dog, lathe, as a pipe wrench..	74	Electrolytic rectifier, for charging ignition batteries	283
Dovetail joint, self-locking..	81	Electrostatic illuminations....	238
Dowel plate, an improved....	104	Engine, a simple electric.....	249
Drafts, clock mechanism for opening	345	Engine bearings, taking up....	391
Drawing table.....	20	Exhaust pipe, muffler for....	172
Drill clearance.....	91	Experiment in static electricity	247
Drill for brick and soft stone.	94	Experiment, interesting, and its explanation.....	214
Drill press.....	46	Experiments for the induction machine	238
Drill press, home-made.....	49	Experiments with carbon disulphide	206
		Extension for speed lathe beds	33
		Extension leg, ladder.....	87

F	PAGE		PAGE
Factory, handy man in.....	156	Glider, Chanute-type, how to build	401
Fans on machine tools.....	172	Glue pot as a metal pot and ladle	102
Faucet, anti-freezing.....	362	Glycerin and carbon disul- phide, side by side.....	209
Filing round work.....	67	Goblet, luminous.....	240
Fire hose, belting.....	90	Gold solders.....	147
Fire lighting apparatus.....	343	Grater	47
Fire pot, replacing.....	344	Grinder, a simple foot power..	24
Fireless cooker, an electrical..	330	Grinder for small tools.....	97
Fireless cooker, cheaply con- structed	328	Grinders, holder for.....	164
Fisherman's bend knot.....	354	Grindstone	23
Fishnet, how to mend.....	353	Grindstone, a simple foot power	24
Flasks, chemical, from electric light globes.....	178	Grindstone, artificial.....	24
Flower pots, paper.....	367	Groove, cutting, with a lathe..	158
Flying machine, "Diabolo"....	453	Groove of 42-inch pitch, cut- ting	157
Flying machines, model, toy..	434	Guide for drilling horizontal holes	92
Fountain, Hero's, as a table ornament	324	Gyroscope made from a bi- cycle	195
Fresh water, to obtain from sea water.....	180		
Frost, making, with carbon disulphide	207	H	
Furnace drafts, let the clock open	345	Hammock, how to mend.....	353
		Hanger for the clothes closet.	325
G		Handle, simple method of con- structing	65
Gage for augers.....	90	Handy man about the house..	314
Gage for weather boards.....	86	Handy sportsman.....	360
Gage, the handy man's.....	95	Hard solders.....	135
Gas engines, muffler for.....	172	Heat motor.....	216
Gas fire-lighting apparatus....	343	Heat motor, ornamental.....	217
Gas heater for soldering irons	115	Heat retaining bottle.....	334
Gas regulator, electrically con- trolled	181	Hero's fountain as a table or- nament	324
Gas soldering iron.....	120	Holder for broken shank drills	90
Geometrical figures produced by elastic pendulum.....	196	Holder for grinders.....	164
Geometrical figures produced by "rotagon" apparatus..	219	Holder for sandpaper.....	66
German silver solder.....	141	Holder for small tools.....	97

	PAGE		PAGE
Holes in metal, device for		L	
sawing	99	Laboratory, electrical.....	230
Hook, the bench.....	13	Laboratory, experimental....	178
Horizontal holes, guide for		Ladder extension leg.....	87
drilling	92	Ladder, to support, on a roof.	87
Horses, trestles or stools....	60	Ladle	102
Hose as substitute for leather		Lamp rheostat.....	290
belting	90	Lamp shade, metal.....	318
Hose, how to mend.....	365	Lamp shade of brass cut with	
Hose reel on a hydrant.....	363	acid	320
Hose, to repair leak in.....	367	Lamps, tungsten, adjustable	
House, the handy man about.	314	socket for.....	289
Hydrant, hose reel on.....	363	Lathe	27
Hydraulic test for the boiler..	174	Lathe, a portable polishing....	162
		Lathe, accurately setting the	
I		slide rest.....	161
Ice yacht, inexpensive.....	407	Lathe beds, extension for....	33
Iceless refrigeration.....	336	Lathe chuck.....	159
Illuminations, electrostatic....	238	Lathe, cutting a cam groove	
Induction machine, interesting		with	158
experiments for.....	238	Lathe dog as a pipe wrench..	74
Influence machine, stratifica-		Lathe dog, correct shape for..	161
tion in vacuo.....	244	Lathe, milling attachment for.	156
Iodine experiment.....	214	Lathes, screw-slotting attach-	
		ment for.....	166
J		Lawn sprinkler, home-made...	364
Jar, Leyden, unbreakable....	230	Leader made of tin cans.....	356
Jar top, unscrewing.....	352	Leather, clutch, putting on...	393
Jars, Leyden, substitute for		Level, a builder's.....	2
tin-foil	230	Leyden jar, unbreakable.....	230
Joint, self-locking dovetail...	81	Leyden jars, substitute for tin-	
Joint, solid, for the work		foil	230
bench	11	Lilac, synthetic, apparatus for	
Joint that can be tightened...	12	making	212
Joint, two intermeshing pieces	314	Lipowitz's metal.....	135
		Locomotives, boring cylinder	
K		bushings for.....	170
Karmarsch's composition....	138	Lubricating cup, automatic....	173
Keyways, cutting, on a die			
sinker	165	M	
Kite, the aeroplane.....	448	Machine tools, fans on.....	172
Knot, fisherman's bend.....	354	Magnetic detector, construc-	
		tion of.....	300

	PAGE		PAGE
Magneto machine for physio- logical effects.....	252	Needle, rag carpet....	327
Marbles, drilling holes in....	93	Net, how to mend.....	353
Mast head, or boom ring....	422	Newton's metal.....	130
Matches, waterproof.....	351	Nut and screw made without a lathe.....	71
Medical coil, a simple.....	250	Nut lost, substitute for.....	396
Mending a cracked bottle....	355		
Metal pot.....	102	O	
Micrometer attachment for a milling machine.....	167	Onion crate, tabouret made from.....	316
Micrometer, home-made.....	103	Open-circuit telegraph system.	291
Milk bottle, how to keep cool.	337	Oscillating static-electric motor.....	233
Milk testing without appa- ratus.....	349		
Milling attachment for the lathe.....	156	P	
Milling machine, micrometer attachment for.....	167	Painters' platform bracket....	88
Mirror to prevent accidents..	395	Pan, broiling, an improvement for.....	339
Miter-box.....	50	Paper, cutting wood with....	201
Monoplane, a simple.....	434	Paper flower pots.....	367
Monoplane, divided.....	438	Paper hanger's adjustable templet.....	89
Monoplane model, a novel..	451	Paper pulp, decorations from.	321
Motor, alternating current....	263	Paradox, an electrical.....	309
Motor buggy, to convert horse-drawn buggy into..	378	Patch for kitchen boilers....	340
Motor, direct current, experi- ments with alternating current.....	306	Pendulum, elastic.....	196
Motor, heat.....	216	Perfume, chemical.....	211
Motor, heat, ornamental.....	217	"Perrikon" detectors, zincite for.....	214
Motor, oscillating, static-elec- tric.....	233	Physiological effects, magneto machine for.....	252
Motor sled.....	430	Picks, railroad, repairing....	176
Motor, to install in small boat.	423	Pipe, polished, vise for.....	67
Muffler for gas engines.....	172	Pipe valve, an emergency....	75
Music stand, or book rest....	314	Pipe vise, an improvised.....	75
		Pipe wrench, substitutes for..	74
N		Piston heads, scraping carbon from.....	388
Nail, chisel point.....	85	Pitch, 42-inch, cutting a groove of.....	157
Nail, the driving of a.....	82	Planing and shooting board..	13
Nail, to prevent from splitting the wood.....	85	Planing dog.....	63
		Platform bracket, painters'...	88

	PAGE		PAGE
Platinum and aluminium		"Rotagons"	219
solder	152	Round work, device for find-	
Poles for telephone lines, ways		ing centers of.....	100
to brace.....	292	Round work, how to file....	67
Polishing lathe, portable.....	162	Router	46
Portable automobile house....	369		
Pots of paper, flower.....	367	S	
Pouring invisible vapor.....	208	Sand paper, convenient holder	
Precht's composition.....	138	for	66
Preventer, accident, the mo-		Saw blades, device for punch-	
torist's	395	ing holes in.....	98
Punching holes in saw blades,		Saw buck.....	59
clock springs, etc.....	98	Saw clamp.....	55
Punctures, tool for repairing..	424	Saw clamp, an improved.....	57
Puzzles, chemical.....	203	Saw filing vise.....	57
Puzzling bit of woodwork....	315	Sawing holes in metal.....	99
		Scaffold, a simple support for.	88
R		Scale for barometers.....	188
Radiators and boilers, mend-		Scientific American as a cut-	
ing	342	ting tool.....	202
Rag carpet needle.....	327	Scooter, how to build.....	414
Railroad picks, repairing.....	176	Screw and nut made without	
Range of rifle, reducing.....	432	a lathe.....	71
Range of rifle, reducing, an-		Screw-slotting attachment for	
other method.....	433	lathes	166
Reamer, an emergency.....	94	Screws, remedy for loose....	86
Rectifier, electrolytic, for		Scroll-saw	34
charging ignition bat-		Scroll-saw guide.....	48
teries	283	Scroll-saw, tool grinder,	
Reel for hose on a hydrant... 363		router, and drill-press....	39
Refrigeration, iceless.....	336	Sea water, how to obtain	
Regulator, gas, electrically		fresh water from.....	180
controlled	181	Seismograph, home-made....	223
Replacing a fire pot.....	344	Selenium cell, construction of.	312
Rheostat, lamp, a cheap.....	290	Shade, home-made metal lamp	318
Rifle, reducing range, another		Shade roller brackets, handle	
method	433	made of.....	65
Rifle, reducing range of....	432	Shaft, how to support when	
Rod threader, substitute for..	71	labbitting	101
Roller jack.....	60	Shaft, method of finding the	
Roof, to support ladder on... 87		center	101
Roses, blue.....	210	Sheet alloy.....	133
Rose's metal.....	130	Shoe stretcher, improvised... 353	

	PAGE		PAGE
Shooting board.....	13	Solders, aluminium.....	150
Shop, building the.....	1	Solders and soldering agents.	107
Shop kinks.....	64	Solders, Applebaum's compo- sitions	138
Shoulder chest.....	18	Solders, bismuth and tin, mold for	132
Silver solders.....	145	Solders, brass.....	141
Siphons, starting device for...	179	Solders, classification of.....	124
Skates, coasting.....	426	Solders, copper.....	135
Sled, bicycle, coasting.....	425	Solders, formulas for.....	123
Sled, dirigible.....	428	Solders, German silver.....	141
Sled, hand-motor.....	430	Solders, gold.....	147
Sled, two ways of improving.	427	Solders, half white.....	139
Slide rest, accurately setting..	161	Solders, hard.....	135
Socket, adjustable, for tung- sten lamps.....	289	Solders, Karmarsch's compo- sition	138
Soft solders.....	125	Solders of brass and zinc.....	141
Solder, aluminium and gold..	152	Solders, Prechtl's composition	138
Solder aluminium, how to....	153	Solders, prepared from pure metals	141
Solder, brass.....	137	Solders, silver.....	145
Solder, bismuth.....	129	Solders, soft.....	125
Solder, Cliché alloys.....	134	Solders, soft, manufacture of.	131
Solder, D'Arcet's metal.....	130	Solders, soft, special use of..	133
Solder, fluid.....	128	Solders, white.....	140
Solder for aluminium bronze.	152	Solders, yellow, hard.....	138
Solder, Lipowitz's metal.....	135	Spark plug, cleaning the.....	390
Solder, Newton's metal.....	130	Spark plug, the handy man's.	387
Solder, platinum and aluminium	152	Spilings, simple method of taking	421
Solder, Rose's metal.....	130	Splitting the wood, to prevent the nail from.....	85
Solder, sheet alloy.....	133	Sportsman, the handy.....	369
Solder, strong soft.....	128	Spring, another method of making	70
Solder, tin.....	124	Spring, spaced coil, how to wind	69
Solder, weak soft.....	128	Spring winder, home-made...	70
Solder, Wood's metal.....	135	Springs, broken, temporary repairs to.....	392
Soldering, anchoring work....	110	Sprinkler, lawn.....	364
Soldering apparatus.....	109	Star, electric, produced with interrupted conductor....	242
Soldering, blow pipe.....	114		
Soldering, continuous blast apparatus	113		
Soldering flame.....	111		
Soldering, hints on.....	117		
Soldering, incasing the work..	110		
Soldering iron, gas, made of pipe fittings.....	120		
Soldering irons, heater for...	115		

	PAGE		PAGE
Starting device for siphons...	179	Tire, punctured, method of re-	
Static electric motor, oscillat-		pairing	424
ing	233	Tool bag, boiler maker's....	76
Static electricity, ringing bell.	247	Tool grinder.....	45
Steam-box	62	Tool rack made of clothes	
Stock bit, a guide for.....	92	pins	64
Stone, to drill through.....	94	Transformer for bell circuits.	279
Stools, trestles, horses or....	60	Trestles, horses, or stools....	60
Stop-cock of glass tubing....	179	Tungsten lamps, adjustable	
Storage battery without chem-		socket for.....	289
icals	258	Turnbuckle, home-made.....	77
Straightening an automobile		Turnbuckle, improvised.....	404
axle	390	Turning of a ball.....	105
Straightening buckled cast-			
ings	175	U	
Stratification in vacuo.....	244	Universal joint.....	78
Stretcher for shoes, improv-		Unscrewing a jar top.....	352
vised	353		
Striation produced with influ-		V	
ence machine.....	245	Vacuo, stratification in.....	244
Synthetic lilac, apparatus for		Vacuum cleaner, home-made..	358
making	212	Valve, pipe, an emergency....	75
T		Vapor, invisible, pouring....	208
Tabouret made from an onion		Vise for polished pipe.....	67
crate	316	Vise, pipe, an improvised....	75
Tap, improvised.....	82	Vise, saw filing.....	57
Tap wrench.....	93	Vise screw, method of repair-	
Telegraph system, open-circuit		ing	71
Telephone lines, ways to brace		Voltaic battery, handy form of	261
poles for.....	292		
Telephones, a test for.....	291	W	
Templet, paper hanger's ad-		Water, how to obtain fresh,	
justable	89	from sea water.....	180
Test for telephones.....	291	Waterproof matches.....	351
Testing milk without appa-		Weatherboard gage.....	86
ratus	349	Weather boards, tracing a	
Thermometer, air.....	189	profile of.....	6
Thread cutting without a die.	68	Wimshurst machine.....	231
Threader, substitute for.....	71	Wimshurst machine, stratifica-	
Tin can leader.....	356	tion in vacuo.....	244
Tin solder.....	124	Winding coils, machine for...	256
Tin solders, mold for.....	132	Wireless telegraph detector, a	
		simple	294

	PAGE		PAGE
Wireless telegraph detector, electrolytic	296	Work bench, joint that can be tightened	12
Wireless telegraph detector, magnetic	300	Work bench, the	8
Wood, cutting with paper....	201	Work shop, fitting up a.....	1
Wood's metal.....	135	Wrench, a handy tap.....	93
Wood screws, remedy for loose	86	Wrench, pipe, substitutes for..	74
Work bench, a solid joint for the	11		\
		Z	
		Zincite, artificial.	214

AUTHORS' INDEX

(See foot note page 8.)

- | | | | |
|----|----------------------------|----|------------------------|
| 1 | Allen, John R. | 38 | Kenny, Frank J. |
| 2 | Bailey, James | 39 | Hoopcs, William |
| 3 | Bayley, I. G. | 40 | Hoster, Mrs. T. G. |
| 4 | Bennett, W. M. | 41 | Huggins, George E. |
| 5 | Bergstrom, J. A. | 42 | Henry, K. R. |
| 6 | Bishop, Alfred F. | 43 | Kavanaugh, S. J.-I. J. |
| 7 | Blake, Thaleon | 44 | Kerr, J. Edwin |
| 8 | Bourne, C. S. | 45 | Kimmell, G. G. |
| 9 | Bonson, Herbert H. | 46 | Laker, John W. E. |
| 10 | Brachvogel, John K. | 47 | Laurence, A. C. |
| 11 | Bradley, R. E. | 48 | Lee, O. Ivan |
| 12 | Brockman, Robert H. | 49 | Lincke, George F. |
| 13 | Brophy, J. A. | 50 | Lord, Frederick |
| 14 | Brouillet, J. O. | 51 | Lurcott, Charles |
| 15 | Brownell, Baker | 52 | M'Caughrey, L. W. |
| 16 | Carter, O. D. | 53 | Marquardt, G. A. |
| 17 | Chapman, H. D. | 54 | McDermott, Jr., F. P. |
| 18 | Cristadoro, Charles | 55 | M'Kenzie, William C. |
| 19 | Clark-Raymond, Jr., George | 56 | Mekeel, Stephen E. |
| 20 | Clock, E. E. | 57 | Menken, August |
| 21 | Cotterell, W. J. | 58 | Michaud, Prof. Gustave |
| 22 | Curtis, Clifton, J. | 59 | Morgan, Albert P. |
| 23 | Cheney, C. D. | 60 | Naylor, George W. |
| 24 | Dailey, H. B. | 61 | Newland, James G. |
| 25 | Dobree, B. E. | 62 | Nichols, Howard M. |
| 26 | Fagan, Arthur | 63 | Osborn, A. E. |
| 27 | Fagan, T. | 64 | Packard, John C. |
| 28 | Fenwick, Thomas | 65 | Pabody, Jr., E. F. |
| 29 | Goebel, W. J. | 66 | Clinton, R. S. |
| 30 | Graves, W. D. | 67 | Parkhurst, W. and K. |
| 31 | Gage, Edward G. | 68 | Parsons, S. J. |
| 32 | Hutchins, C. C. | 69 | Paulmier, J. Carlton |
| 33 | Handy, L. Gessford | 70 | Pearse, R. W. |
| 34 | Harrison, Walton | 71 | Dunlap, P. |
| 35 | Heron, George | 72 | Pitkin, Carroll A. |
| 36 | Heuser, R. V. | 73 | Place, Jr., William H. |
| 37 | Hopkins, George M. | 74 | Prather, Albert |

- 75 Rader, Morris
76 Ragan, Kennard
77 Reid, E. Emmet, Dr. Ph.D.
78 Brecht, Charles
79 Riggs, Prof. Henry H.
80 Royan, William M.
81 Baldwin, Capt. Thomas S.
82 Searing, Jr., A. V.
83 Lavell, E. J.
84 Asher, James
85 Spears, J. R.
86 Sweet, F. D.
87 Strong, Henry
88 Bastin, S. Leonard
89 Van der Veer, A. R.
90 Thorpe, Edward
91 Tiede, Edw. J.
92 Tuttle, Jr., Eugene
93 Von Sparr, Jr., R.
94 Whiteley, Franklin L.
95 Ward, Frederick E.
96 Warner, Fred. G.
97 Welter, J. S.
98 Whitemore, H. L.
99 Woolley, Claude L.
100 Worts, George F.
101 Baker, Thomas R., Dr.
102 Translated for the Scientific
American Supplement
from Edmund Schlosser's
"Das Löten und die Bear-
beitung der Metalle."
103 Kosmos.

TOOLS

AND LABOR SAVING DEVICES FOR AMATEUR
AND PROFESSIONAL MECHANICS

OUR CATALOG

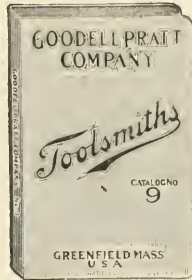

FREE

IT SHOWS TOOLS NOT FOUND IN EVERY
HARDWARE STORE

Goodell-Pratt Tools enjoy a very high reputation for design, finish, durability and general excellence.

Some few styles will be found in almost every hardware store, but no dealer can carry the complete line.

Get our Catalog and you will be sure to find tools you don't know about; perhaps just what you need.

GOODELL-PRATT COMPANY

Toolsmiths

GREENFIELD, MASS., U.S.A.

PATENTS

THE WEALTH OF NATIONS

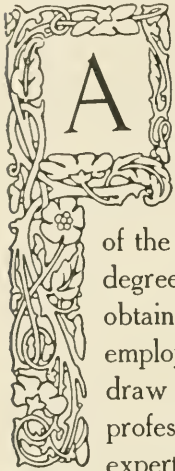

PATENT gives you an exclusive right to your invention for a term of seventeen years. You can sell, lease, mortgage it, assign portions of it, and grant licenses to manufacture under it. Our patent system is responsible for much of our industrial progress and our success in competing in the markets of the world. The value of a successful patent is in no degree commensurate with the almost nominal cost of obtaining it. In order to obtain a Patent it is necessary to employ a Patent Attorney to prepare the specifications and draw the claims. This is a special branch of the legal profession which can only be conducted successfully by experts. For nearly sixty years we have acted as solicitors for thousands of clients in all parts of the world. Our vast experience enables us to prepare and prosecute Patent cases and Trade Marks at a minimum of expense. Our work is of one quality and the rates are the same to rich and poor. Our unbiased opinion freely given. We are happy to consult with you in person or by letter as to the probable patentability of your invention. Hand Book on Patents, Trade Marks, etc., sent free on application.

MUNN & COMPANY . . . SOLICITORS OF PATENTS
BRANCH OFFICE MAIN OFFICE
625 F Street, Washington, D. C. 361 Broadway, New York

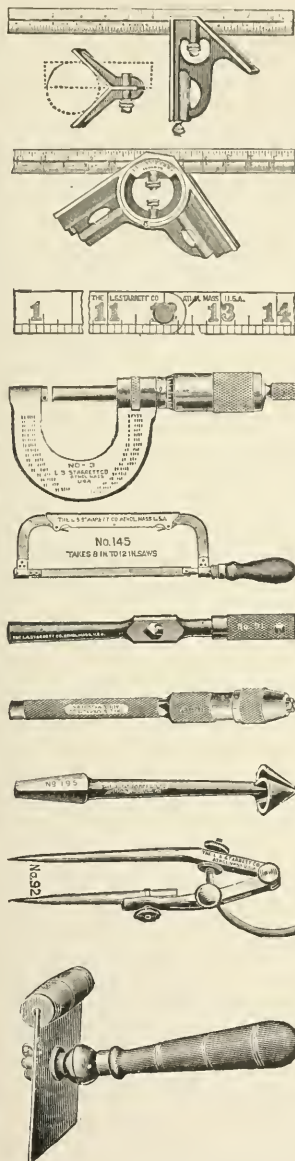

The Handy Man

can do a good deal with only a hammer, a saw and a plane; but he can do a lot more and do it quicker and better, and have much more fun in doing it, if his workshop is equipped with

Starrett Tools.

A Starrett Combination Square is indispensable, and —well, get the catalog and see how many things you can't do without.

CATALOG FREE

The L. S. Starrett Co.

ATHOL, MASS., U. S. A.

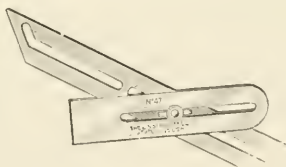



Scientific American Trophy for Heavier-Than-Air Flying Machines

THE SCIENTIFIC AMERICAN contains exactly the kind of information about the world's industrial progress which you want to obtain. The Scientific American is neither dry nor heavy but is filled with interesting, new and timely matter of value to all. You may like to read about airships, automobiles, machinery, railways, steamships, or any one of the countless things with which we have concerned ourselves. For over sixty years every important item of news concerning the scientific and technical development of the world has been faithfully chronicled in its pages. A year's numbers contain nearly 1,000 large folio pages equal

to 4,000 ordinary magazine pages, and 1,500 beautifully printed engravings. The Scientific American is read by all the family; the variety of matter suits everyone. The Notes and Queries department places a corps of trained experts at the disposal of the subscribers. The service is free to all those whose names are on our books. Those who are not familiar with this publication are invited to send for a specimen copy or better yet send \$3.00 for an annual subscription. Subscriptions for six months accepted at \$1.50.

MUNN & CO., INC., PUBLISHERS

SCIENTIFIC AMERICAN OFFICE

361 BROADWAY, NEW YORK



Scientific American Medal Awarded Annually for Devices for Safeguarding Life and Limb

The Best Benches

FOR ALL WOODWORKERS



*Designed by
Bench experts.
Made of the
most carefully
seasoned MICHIGAN
HARD MAPLE.
Built by Skillful, well-
paid workmen—not boys.
Recognized for years
as leaders.*

No. 104 shown in the illustration has conveniently fitted drawers and cupboard for the safe keeping of valuable tools and unfinished work. All are fitted with strong locks. A rugged, substantial bench which is giving splendid service and satisfaction.

Your bench needs should be supplied by selecting from our very complete and well illustrated catalog. A line from you to-day will bring it to-morrow.

GRAND RAPIDS HAND SCREW COMPANY

900 Cottage Grove Avenue

GRAND RAPIDS, MICHIGAN

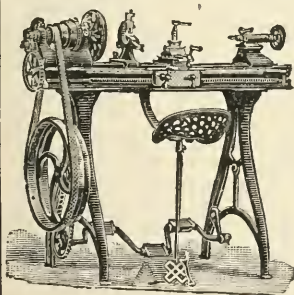

BARNES

No. 4½ Lathe

This lathe has 9" swing over face plate and 25" between centers. Cuts right and left hand threads; has set-over tailstock for taper turning and takes 3/8" rod through spindle. No toy, but an honest, accurately

built tool especially adapted for experimental and repair work.

AN OFFER:—For \$80.00 cash f. o. b. cars Rockford; 4½" Lathe with following tools: 5" Champion scroll chuck, set of 9 lathe tools, 1/2" lathe arbor, 3 common lathe dogs (3/8, 3/4, 1") and set of twist drills 1/16 x 1/2 x 32^{nds}. \$80.00 net cash.

SEND FOR LATHE CATALOG

W. F. & JOHN BARNES COMPANY

1999 Ruby St., Rockford, Ill.

AMERICAN HOMES AND GARDENS

THE HIGHEST TYPE OF MAGAZINE
MAKING ◻ A MONTHLY DEVOTED
TO THE HOME AND COUNTRY LIFE



HIS publication appeals to every one who has a country place or is thinking of building one, and to those who love country

life. It claims the attention of all members of the family, including the women of the household, because of its practical suggestions in regard to the house, its decoration, the arrangement of furniture, the garden and how it can best be laid out.

Besides articles of a utilitarian character, many others are published which stamp "American Homes and Gardens" as *the* magazine of country life and nature. The articles on houses are particularly important. The illustrations are made from houses which have been actually constructed, and represent the most advanced types of the modern American Home.

Each number contains an illustrated account of a personal visit to some noted mansion. These articles are accompanied by floor plans drawn to scale. Each number has a three-color process cover which changes with each month. The broad character of the publication accounts for the great popularity which it has attained in a comparatively short time. Each issue is beautifully printed on coated paper, contains seventy-two pages, and measures 10½x14 inches. The subscription price is \$3.00 a year; single numbers 25 cents.



ESTABLISHED 1905 MONTHLY

MUNN & CO., Inc., Publishers, 361 Broadway, N. Y. City

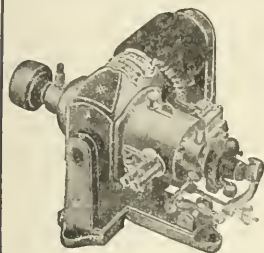

MOTSINGER (DYNAMO) AUTO=SPARKER, \$16.00

For all kinds of Gas Engine Ignition—
Will charge Batteries, run Lights, etc.

Motsinger D. C. Magneto, \$10.00

MADE BY

MOTSINGER DEVICE MFG. COMPANY

342 Main St., Pendleton, Ind., U. S. A.

LUFKIN

MEASURING TAPES AND RULES

Appeal particularly to those who appreciate absolute accuracy
and expert workmanship. Our catalogue is a valuable addition to
the "Handyman's Book." *Sent on Request.*

THE LUFKIN RULE CO.

Saginaw, Mich., U. S. A.—New York—London, Eng.—Windsor, Can.

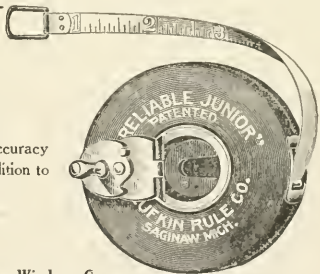

Our Book Department



WE offer our patrons and subscribers the advantages of a long established and widely experienced department, devoted to the publication and distribution of modern up-to-date books pertaining to all branches of Engineering, Mechanics, Chemistry, Science, Industrial Arts, Trades and Manufactures.

We shall be glad to aid our patrons in the proper selection and purchase of books on the subject in which they are interested.

Our 112-page catalogue of general scientific and technical books will be mailed free to any address upon application.

SOME OF THE SCIENTIFIC AMERICAN PUBLICATIONS

The Scientific American Reference Book, compiled by A. A. Hopkins, 12mo., cloth, 516 pages, illus.	\$1 50
The Scientific American Boy, by A. R. Bond, 12mo., cloth, 317 pages, 320 illustrations	2 00
Home Mechanics for Amateurs, by George M. Hopkins, 12mo., cloth, 370 pages, 326 illustrations	1 50
Experimental Science, by George M. Hopkins, 2 volumes, 1,100 pages, 900 illustrations	5 00
The Scientific American Cyclopedia of Receipts, Notes and Queries, edited and compiled by Albert A. Hopkins, revised edition, containing 15,000 selected formulas, 734 pages	5 00
Magic, Stage Illusions and Scientific Diversions, by A. A. Hopkins, 8vo., cloth, 556 pages, illustrated	2 50
The New Agriculture, by T. Byard Collins, 8vo., cloth, 374 pages, 106 illustrations	2 00
Industrial Alcohol, Its Manufacture and Uses, by John K. Brachvogel, 8vo., cloth, 516 pages, 107 illus.	4 00
Practical Pointers for Patentees, by F. A. Creese, 12mo., cloth, 144 pages	1 00
American Estates and Gardens, by Barr Ferree, quarto, 11x13½ inches, 340 pages, 275 illustrations	10 00
The Design and Construction of Induction Coils, by A. Frederick Collins, 8vo., cloth, 295 pp, 155 illus.	3 00
The Technological Dictionary, Spanish-English, English-Spanish, by N. Ponce De Leon,	
Vol. 1, Ingles-Espanol	8 50
Vol. 2, Spanish-English	7 50, two vols. 16 00

Full descriptive circulars of the above books will be mailed free upon application.

MUNN & CO., Inc., Publishers, 361 Broadway, New York City, N. Y.

The Scientific American Boy at School

By A. RUSSELL BOND

12mo.

338 Pages.

314 Illustrations.

Price \$2.00 postpaid



HIS book is a sequel to "The Scientific American Boy," many thousand copies of which have been sold, and has proven very popular with the boys. The main object of the book is to instruct how to build various devices and apparatus, particularly for outdoor use. The construction of the apparatus is fully described and the instructions are interwoven in a story, a feature which has assisted in making the "Scientific American Boy" so popular and interesting to the boy.

It takes up the story of "Bill" and several of his companions at boarding school.

They form a mysterious Egyptian society, whose object is to emulate the resourcefulness of the ancients. Their Chief Astrologer and Priest of the Sacred Scarabeus is gifted with unusual powers, but his magic is explained so that others can copy it. Under the directions of the Chief Engineer, dams, bridges and canal-locks are constructed. The Chief Admiral and Naval Constructor builds many types of boats, some of which are entirely new. The Chief Craftsman and the Chief Artist also have their

parts in the work done by the Society, over which Pharaoh and his Grand Vizier have charge. Following is a list of the chapters:

Chapter I. Initiation; Chapter II. Building a Dam; Chapter III. The Skiff; Chapter IV. The Lake House; Chapter V. A Midnight Surprise; Chapter VI. The Modern Order of Ancient Engineers; Chapter VII. A "Pedal-Paddle-Boat"; Chapter VIII. Surveying; Chapter IX. Sounding the Lake; Chapter X. Signaling Systems; Chapter XI. The Howe Truss Bridge; Chapter XII. The Seismograph; Chapter XIII. The Canal Lock; Chapter XIV. Hunting with a Camera; Chapter XV. The Gliding Machine; Chapter XVI. Camping Ideas; Chapter XVII. The Haunted House; Chapter XVIII. Sun Dials and Clepsydras; Chapter XIX. The Fish-Tail Boat; Chapter XX. Kite Photography; Chapter XXI. Water-Kites and Current Sailing; Chapter XXII. The Wooden Canoe; Chapter XXIII. The Bicycle Sleigh; Chapter XXIV. Magic; Chapter XXV. The Sailboat; Chapter XXVI. Water Sports, and Chapter XXVII. A Geyser Fountain.

Concrete Pottery & Garden Furniture

By RALPH C. DAVISON

Assistant Secretary Concrete Association of America

16mo.

196 Pages

140 Illustrations

Price \$1.50 postpaid



HIS work should appeal strongly to all those interested in ornamental concrete, as the author has taken up and explained in detail in a most practical manner the various methods of casting concrete in ornamental shapes. The titles of the thirteen chapters which this book contain, will give a general idea of the broad character of the work. They are entitled:

I. Making Wire Forms and Frames; II. Covering the Wire Frames and Modeling the Cement Mortar Into Form; III. Plaster Molds for Simple Forms; IV. Plaster Molds for Objects Having Curved Outlines; V. Combination of Casting and Modeling—An Egyptian Vase; VI. Glue Molds; VII. Colored Cements and Method Used for Producing Designs with Same; VIII. Selection of Aggregates; IX. Wooden Molds—Ornamental Flower Pots Modeled by Hand and Inlaid with Colored Tile; X. Concrete Pedestals; XI. Concrete Benches; XII. Concrete Fences; XIII. Miscellaneous, Including Tools, Waterproofing and Reinforcing.

The first two chapters explain a most unique and original method of working pottery which has been developed by the author. The chapter on color work alone is worth many times the cost of the book inasmuch as there is little known on this subject, and there is a large and growing demand for this class of work. The author has taken for granted that the reader knows nothing whatever about the material and has explained each progressive step in the various operations throughout in detail. These directions have been supplemented with half-tones and line illustrations which are so clear that no one can misunderstand them. The amateur craftsman who has been working in clay will especially appreciate the adaptability of concrete for pottery work, inasmuch as it is a cold process throughout, thus doing away with the necessity of kiln-firing, which is necessary with the former material. The book is well gotten up, and is printed on heavy glazed paper and abounds in handsome illustrations throughout, which clearly show the unlimited possibilities of ornamentation in concrete.

MUNN & CO., Inc., Publishers, 361 Broadway, N. Y. City

REVISED EDITION

The **SCIENTIFIC AMERICAN**
CYCLOPEDIA of RECEIPTS
NOTES and QUERIES

15,000 RECEIPTS

730 PAGES

Price \$5.00.

Mailed to Any Part of the World

Leather Bindings as follows:

Sheep, \$6.00

Half Morocco, \$6.50

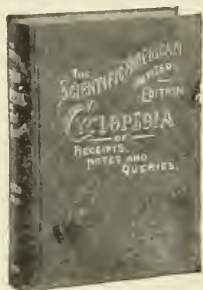

ONE of the most useful books ever published. Invaluable in the factory, office, or home. Over 15,000 selected receipts are here collected, nearly every branch of the useful arts being represented. It is much more than a receipt book, as in most cases it gives the standard and special formulas which enable the reader to find a receipt which fits his peculiar needs. The alphabetical arrangement with abundant cross references makes it an easy work to consult. This book was first published in the Fall of 1891 and it has had an unprecedented sale. It has been used with equal success by chemists, technologists and those unfamiliar with the arts, and it is a book which is useful in the laboratory, factory or home. The new edition which has been revised and brought up to date will undoubtedly prove even more valuable than the preceding editions. A complete Table of Contents sent on request.

MUNN & CO., Inc., Publishers

Scientific American Office,

361 BROADWAY, NEW YORK

Twenty-fifth Edition

EXPERIMENTAL SCIENCE

By GEORGE M. HOPKINS

Revised and Greatly Enlarged
1,000 Pages

Two Octavo Volumes
900 Illustrations

Cloth Bound, Postpaid, \$5.00

Half Morocco, Postpaid, \$7.00

Or Volumes Sold Separately :

Cloth, \$3.00 per Volume

Half Morocco, \$4.00



EXPERIMENTAL SCIENCE is so well known to many of our readers that it is hardly necessary now to give a description of this work. Mr. Hopkins decided some time ago that it would be necessary to prepare a new edition of this work in order that the many wonderful discoveries of modern times might be fully described in its pages. Since the last edition was published, wonderful developments in wireless telegraphy, for example, have been made. It was necessary, therefore, that a good deal of new matter should be added to the work in order to make it thoroughly up-to-date, and with this object in view some 200 pages have been added. On account of the increased size of the work it has been necessary to divide it into two volumes, handsomely bound in buckram. It may be interesting to note the following additions that have been made to these volumes :

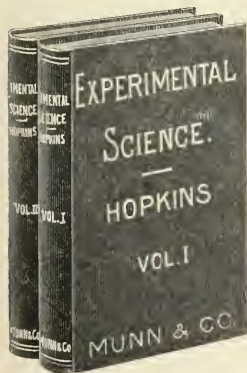

Volume I contains in addition to a large number of simple, well illustrated experiments, a full description of a $\frac{1}{4}$ H. P. electric motor made expressly for illustration in this edition of "Experimental Science." It is an enclosed self-regulating electric motor for a 110 volt circuit. It can be operated by a current from a 110 volt lamp socket, yielding a full $\frac{1}{4}$ H. P., or it may be used as a dynamo, furnishing a current capable of operating three 16-candle-power, 110 volt incandescent lamps. The construction of the machine is perfect enough to admit of enlarging or reducing its size if desired.

Volume II contains much on the general subject of electricity, besides new articles of great importance. Among these the subject of alternate current machinery is treated. Wireless Telegraphy and Telephony receive attention. Electrical Measuring Instruments, The Electric Clock, The Telegraphone, Experiments in High Voltage, The Nernst Lamp, and Measuring the Heat of the Stars are all thoroughly illustrated and described.

The unprecedented sale of this work shows conclusively that it is the book of the age for teachers, students, experimenters and all others who desire a general knowledge of Physics or Natural Philosophy.

Send for Descriptive Circular.

MUNN & CO., Inc., Publishers, 361 Broadway, NEW YORK

HOME MECHANICS FOR AMATEURS

By GEORGE M. HOPKINS

Author of "Experimental Science"

12mo.

370 Pages.

320 Illustrations

Price \$1.50 postpaid

THE book deals with wood working, household ornaments, metal working, lathe work, metal spinning, silver working; making model engines, boilers and water motors; making telescopes, microscopes, and meteorological instruments, electrical chimes, cabinets, bells, night lights, dynamos and motors, electric light, and an electric furnace. It is a thoroughly practical book by the most noted amateur experimenter in America.

MAGIC

STAGE ILLUSIONS AND SCIENTIFIC
DIVERSIONS, INCLUDING TRICK
PHOTOGRAPHY

By A. A. HOPKINS

568 Pages

420 Illustrations

Price \$2.50

THE illusions are illustrated by the highest class of engravings, and the exposes of the tricks are, in many cases, furnished by the prestidigitateurs themselves. Conjuring, large stage illusions, fire-eating, sword-swallowing, ventriloquism, mental magic, ancient magic, automata, curious toys, stage effects, photographic tricks, and the projection of moving photographs are all well described and illustrated.

MUNN & CO., Inc., Publishers, 361 Broadway, NEW YORK

GETTY CENTER LIBRARY



3 3125 00140 2573

