

萬有文庫

第一集一千種  
王雲五主編

營造法式

(六)

李誠編修



商務印書館發行

萬有文庫

第一集一千種

總編纂者  
王雲五

商務印書館發行

上海圖書館藏書



A541 212 0004 0532B

營 造 法 式

(六)

李 誠 編 修



國 學 基 本 叢 書

營造法式卷第二十九

通直郎管修蓋皇弟外第專一提舉修蓋班直諸軍營房等臣李誠奉

聖旨編修

總例圖樣

園方方園圖

壕寨制度圖樣

景表版等第一

水平真尺第二

石作制度圖樣

柱礎角石等第一

踏道螭首第二

殿內闕八第三

鉤闌門砧第四

流盃渠第五

總例圖樣

圓方方圓圖

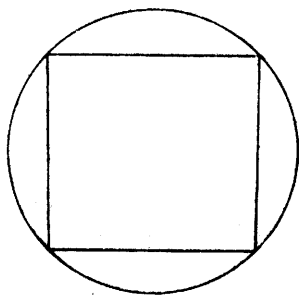

圓方圖

方圓圖

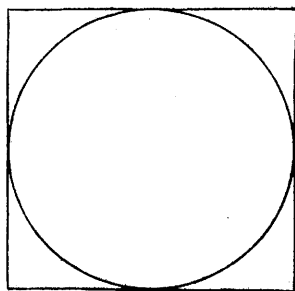

壕寨制度圖樣

景表版等第一

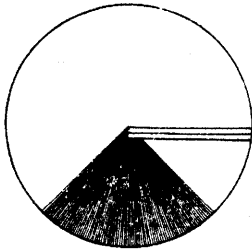

景表版

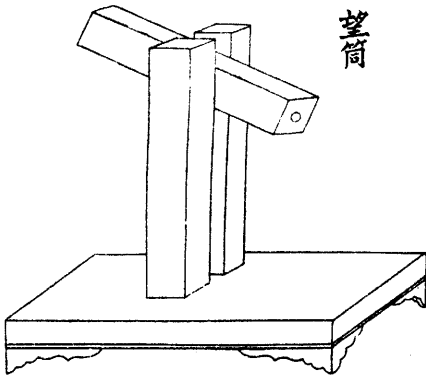

望筒

水池景表

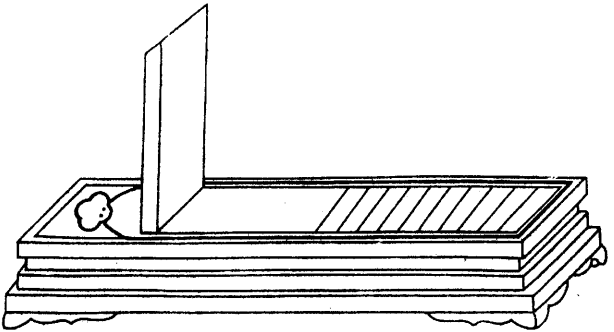



水平

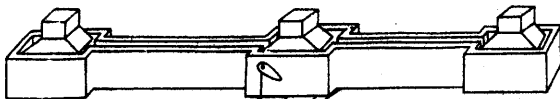
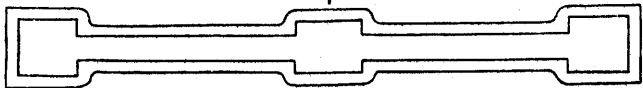

水平真尺第二

真尺

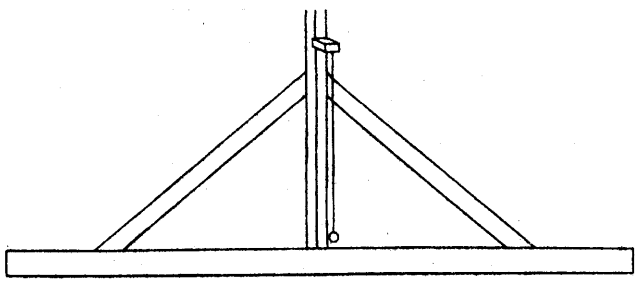

石作制度圖樣

柱礎角石等第一

柱礎

剔地隱起  
海石榴華

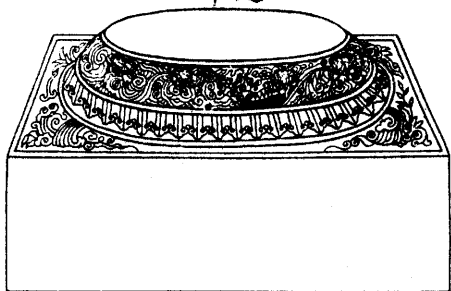

龍水



壓地隱起  
牡丹華

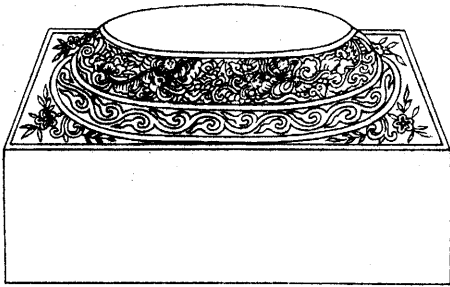

寶相華

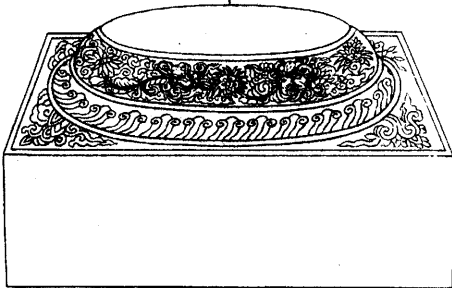

仰覆蓮華

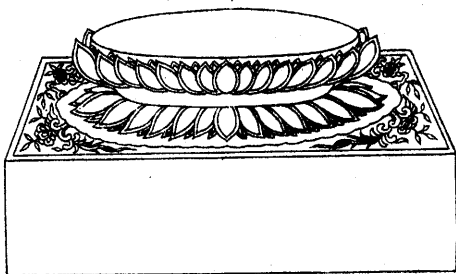

寶蓮華

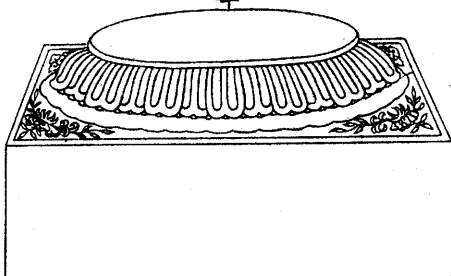

鋪地蓮華

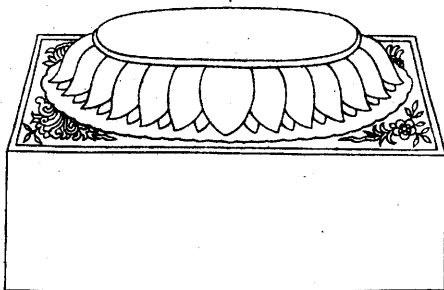

減地平  
銀華



角石

剔地起突雲龍

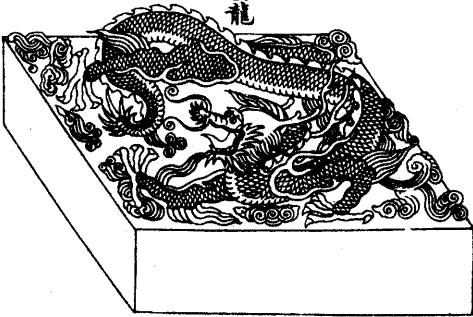

盤鳳

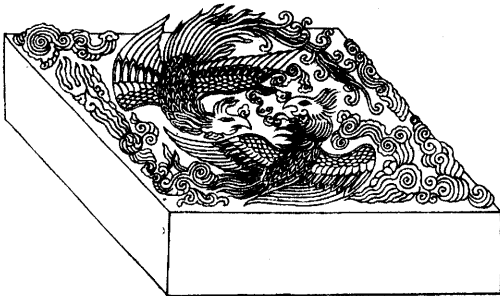

剔地起  
突師子

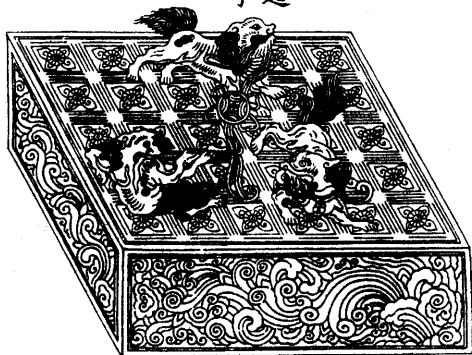

壓地隱起  
海石榴華





階基疊澁坐角柱

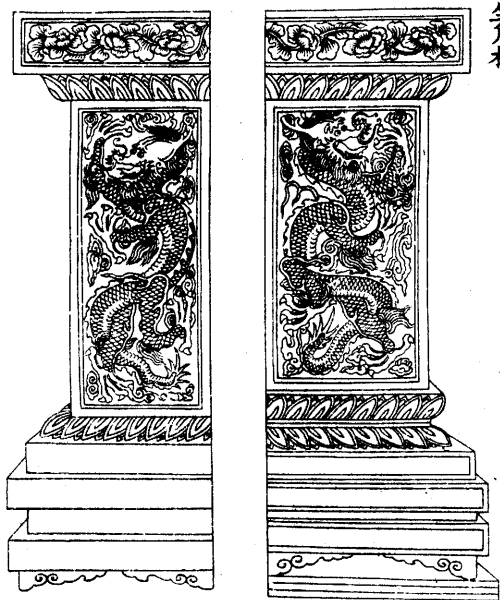

角柱

剔地起突雲龍

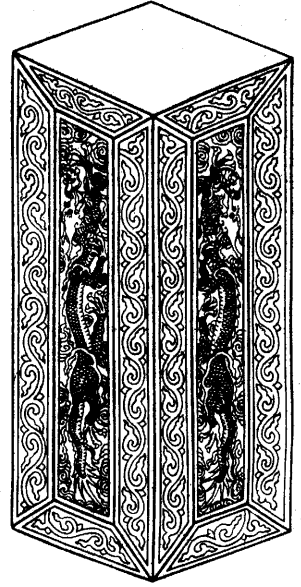

壓地隱起華

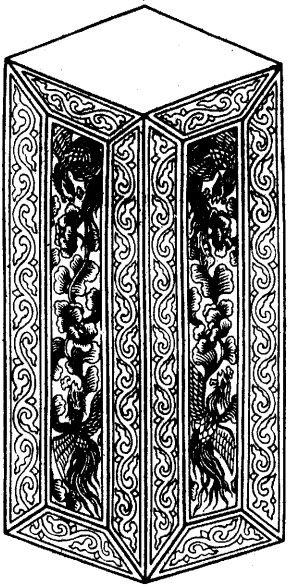

營造法式

六

卷二十九

十五

壓闌石

剔地起突華

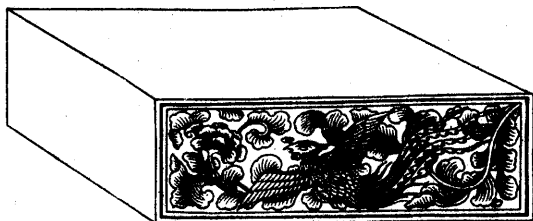

壓地隱起華

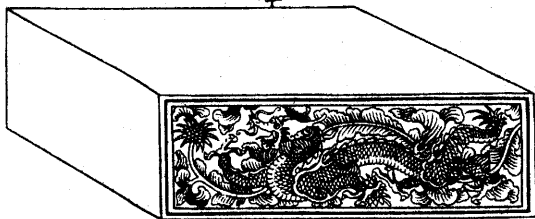

踏道螭首第二

踏道

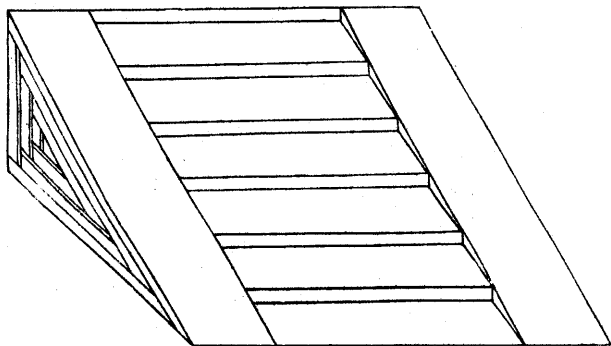

螭首

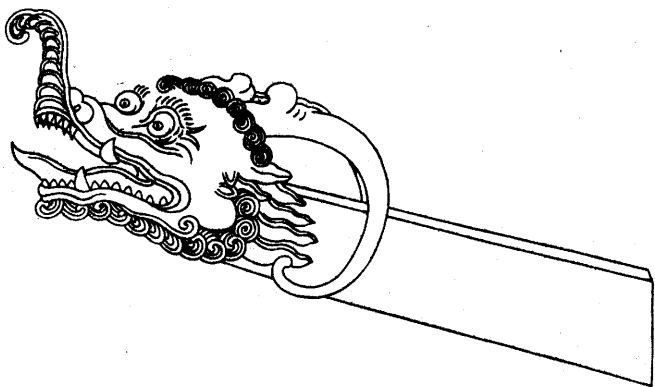

殿內關八第三

殿堂內地面心關八

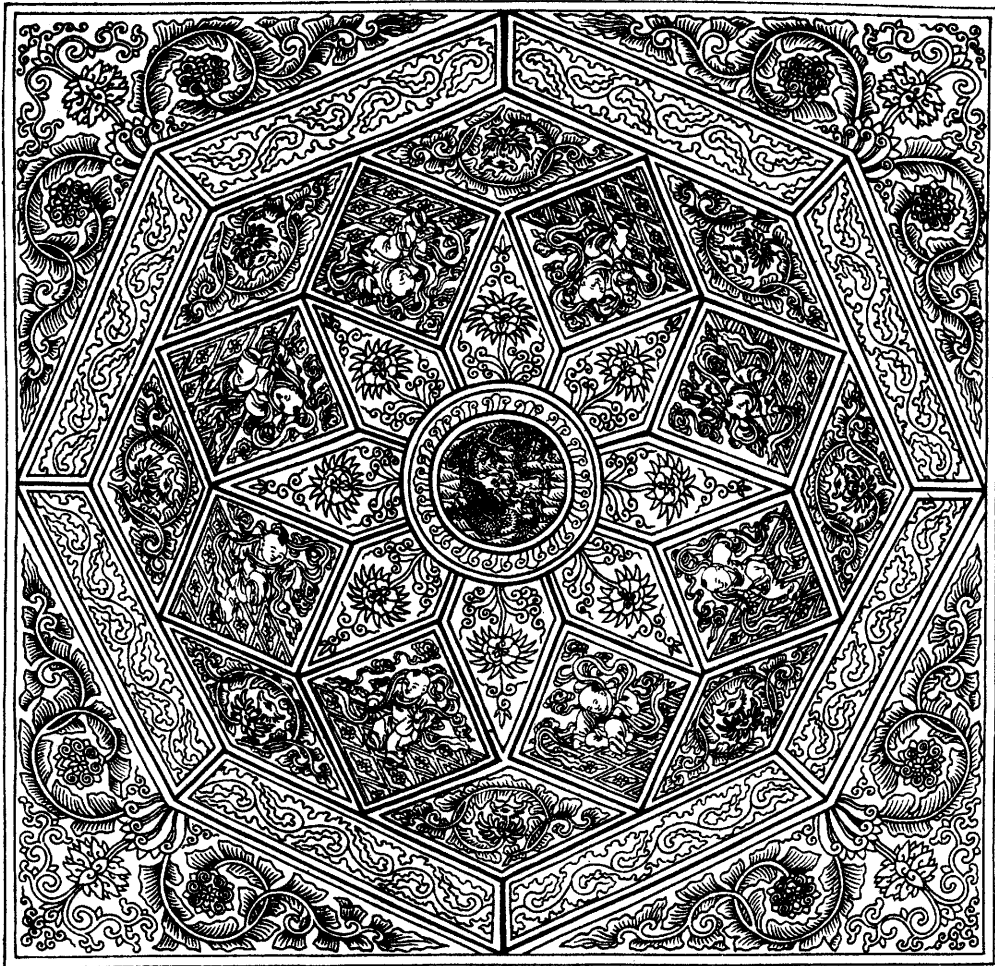

此  
页  
空  
白

鉤欄門砧第四

重臺鉤欄

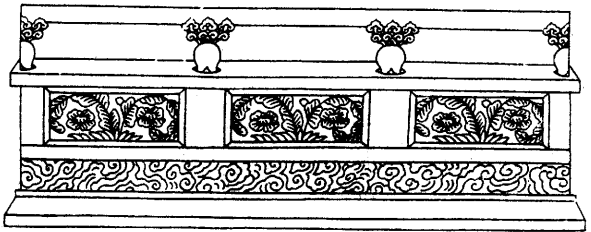



單鉤闌

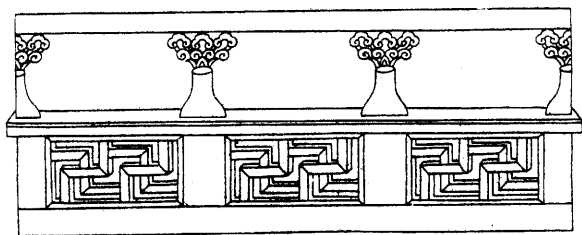

望柱

減地平級華

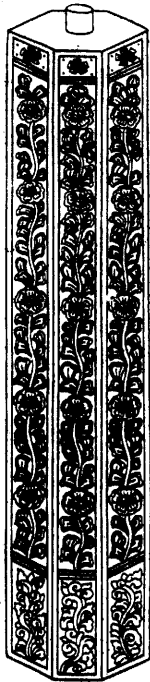

剔地起突  
纏柱雲龍



壓地隱起華



望柱頭獅子



望柱下坐

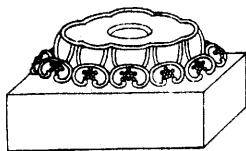
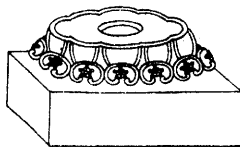

門砧

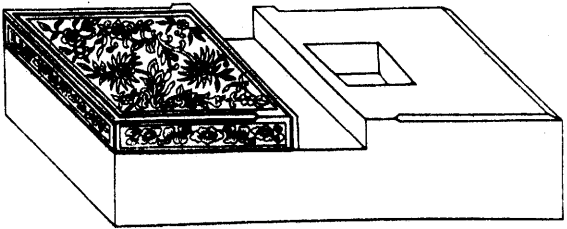
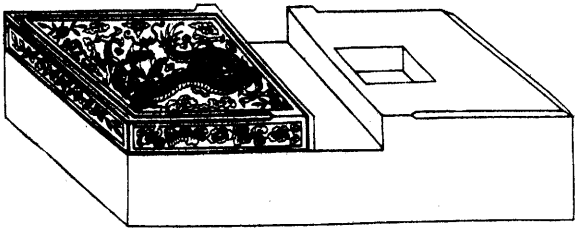

地袱

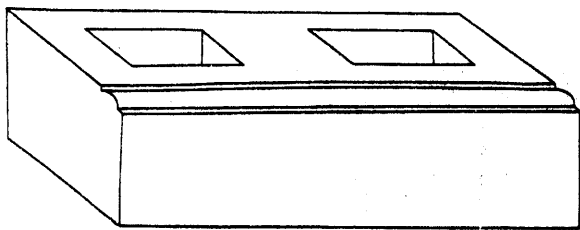

流五渠第五

國字流五渠

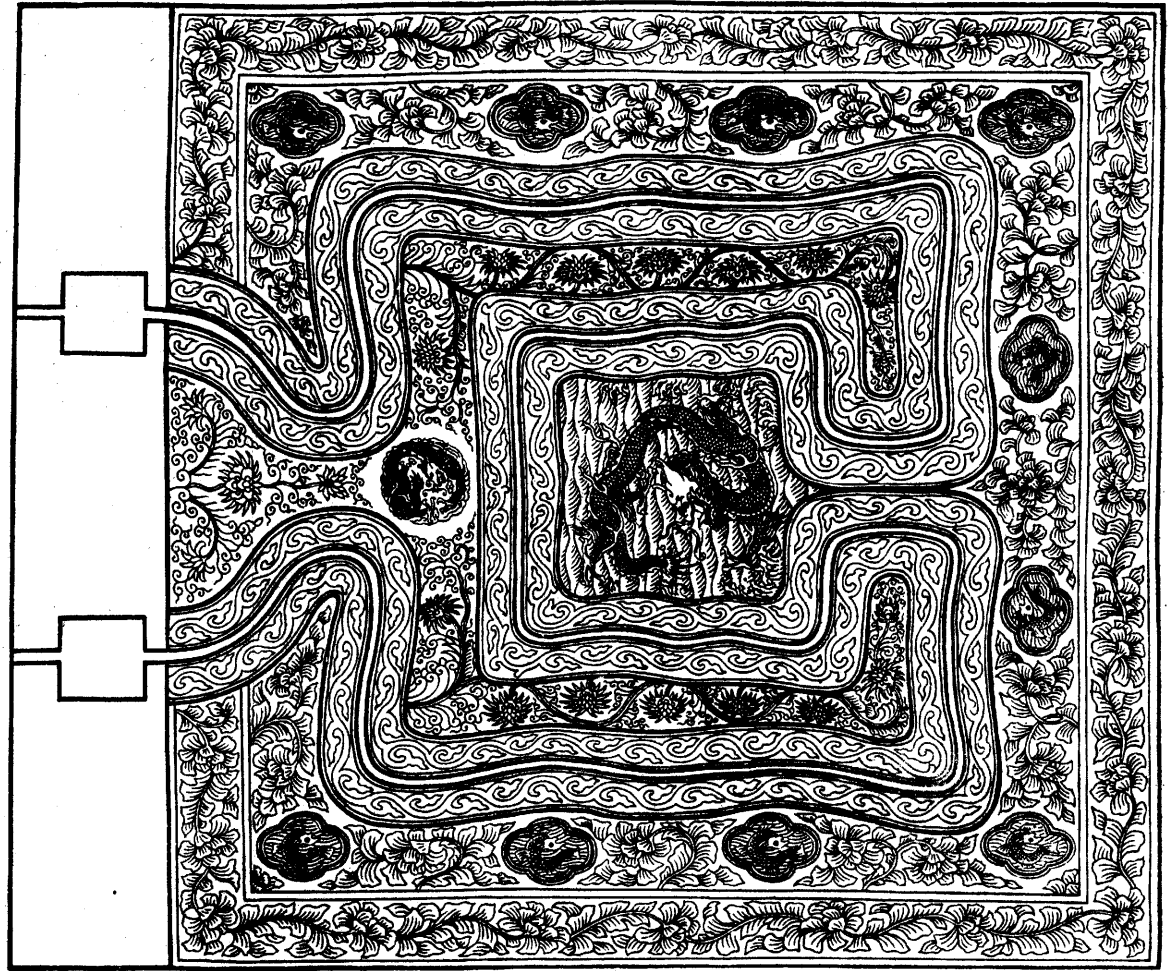

此  
页  
空  
白

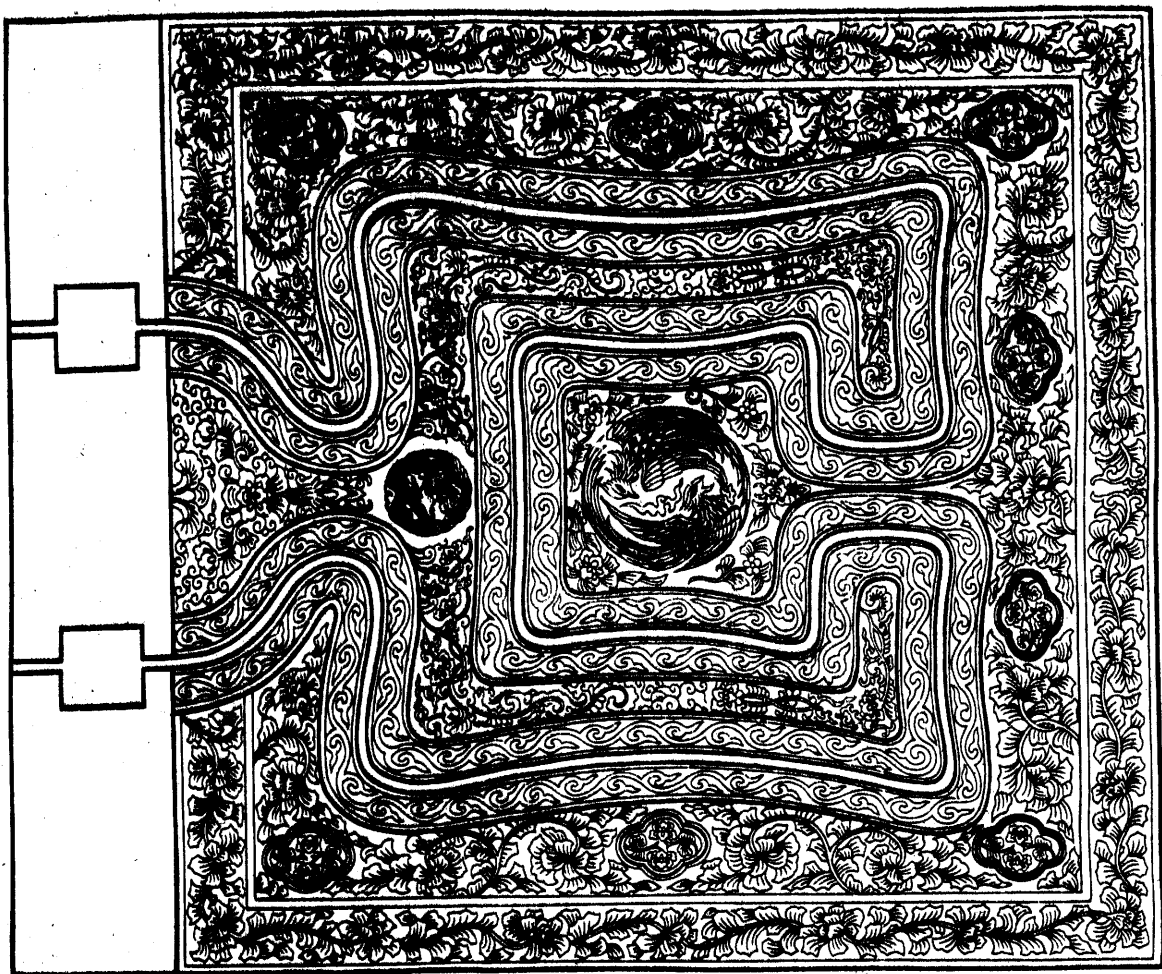



此页空白

營造法式卷第二十九

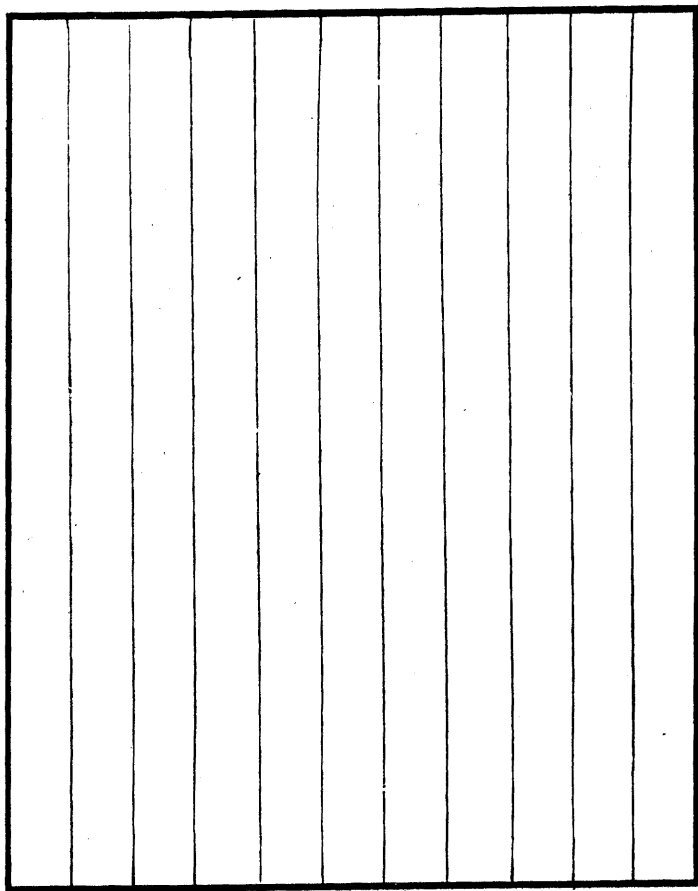

營造法式卷第三十

通直郎管修蓋第外第專一提舉修蓋班直頭軍營房等臣李誠奉

聖旨編修

大木作制度圖樣上

拱料等卷殺第一

梁柱等卷殺第二

下昂上昂出跳分數第三

舉折屋舍分數第四

絞割鋪作拱昂料等所用卯口第五

梁額等卯口第六

合柱鼓卯第七

搏縫襻間第八

鋪作轉角正樣第九

大木作制度圖樣上

拱科等卷殺第一



華拱

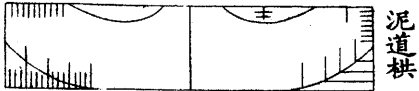

泥道拱



慢拱

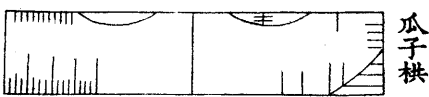

瓜子拱

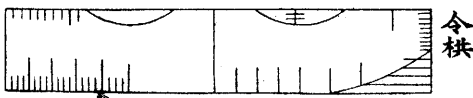

令拱

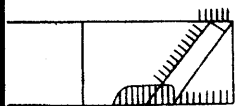

要頭

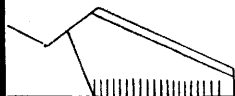

下昂尖

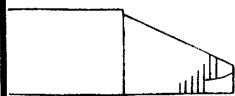

華頭子



替木頭

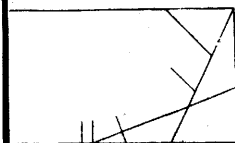

梁椽頭

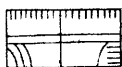

交互料

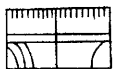

齊心料



散料

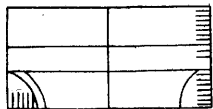

椽料

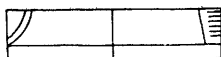

柱磧

月梁

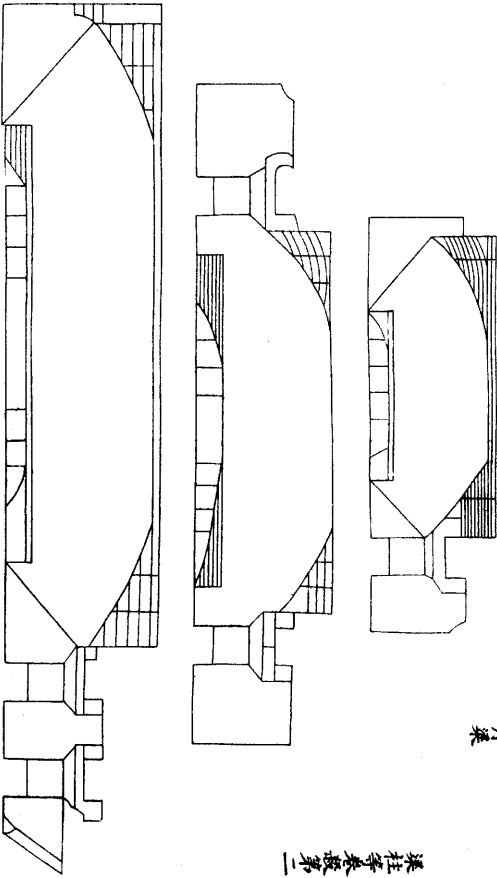

梁柱卷第一



額肚并柱樣

下檐額肚

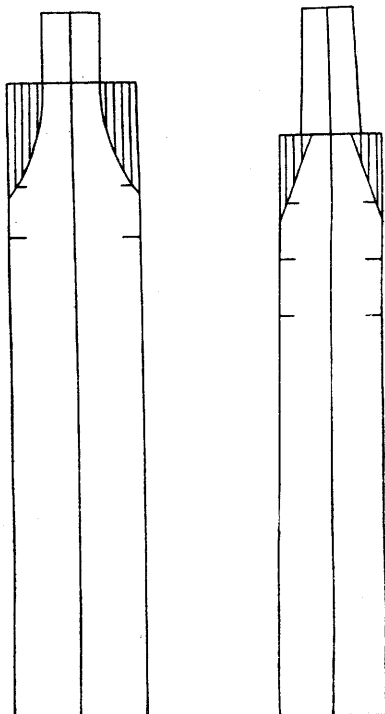

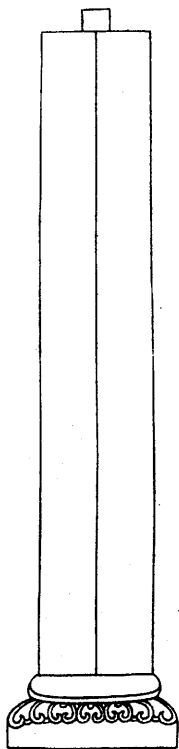

直柱

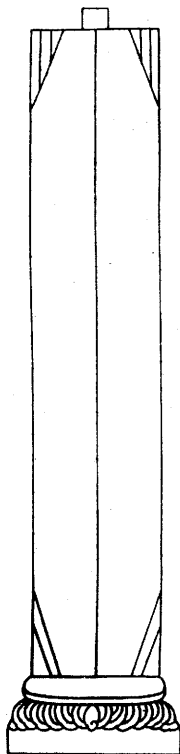

梭柱

子角梁

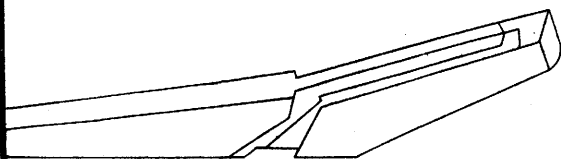

大角梁  
三辨頭或  
只作路頭

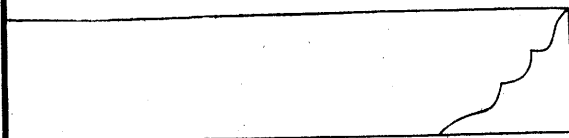

搭頭綽幕

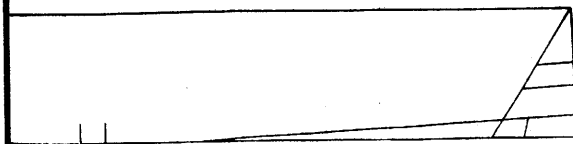

蟬肚綽幕

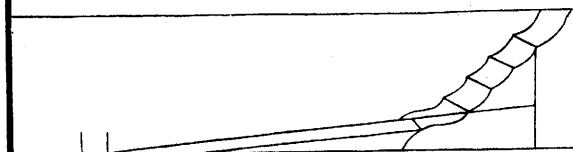

鷹背駝峯三辨

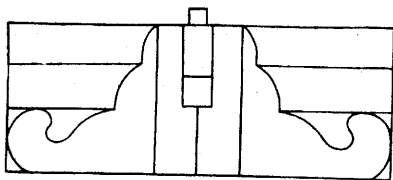

兩辨駝峯

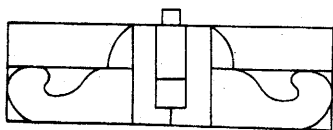

指辨駝峯

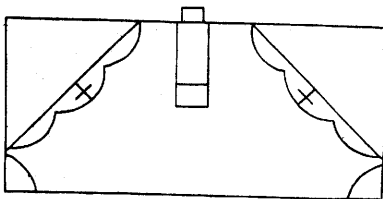

甌笠駝峯

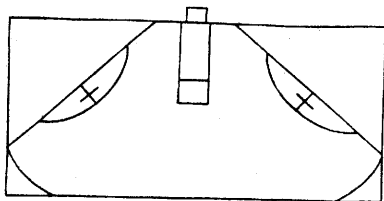

下昂上昂出跳分數第三

四鋪作裏外並一抄  
卷頭壁內用重棋

下昂側樣

五鋪作重棋出單抄單下昂裏  
轉五鋪作重棋出兩抄並計心

六鋪作重棋出單抄雙下昂裏  
轉五鋪作重棋出兩抄並計心

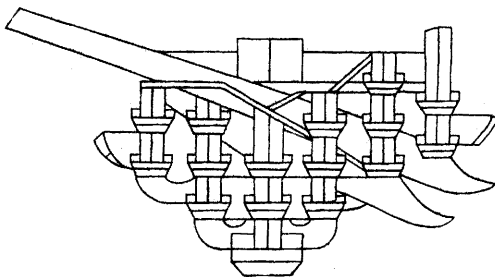
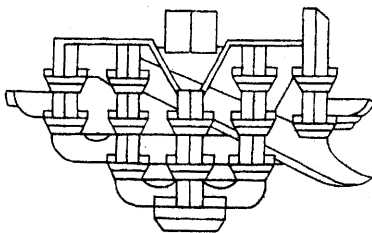
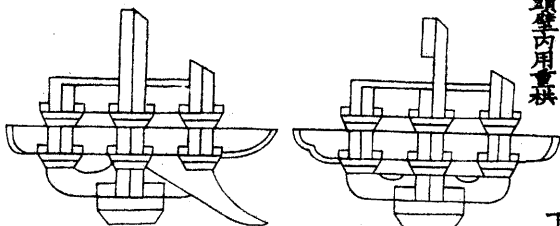

七鋪作重拱出雙杪雙下昂裏  
轉六鋪作重拱出三杪並計心

八鋪作重拱出雙杪三下昂裏  
轉六鋪作重拱出三杪並計心

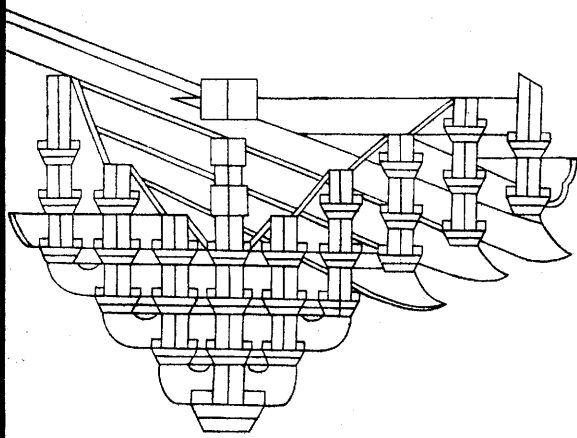
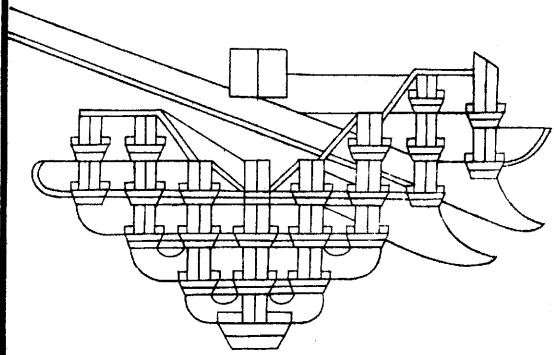

上昂側樣

五鋪作重拱出  
上昂並計心

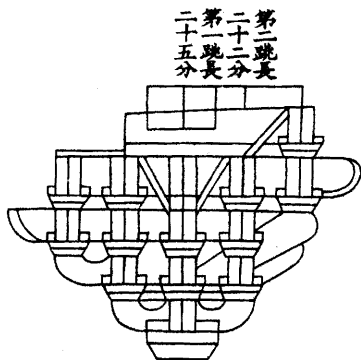

第二跳長  
二十二分  
第一跳長  
二十五分

六鋪作重拱出上昂偷  
心跳內當中施駢料拱

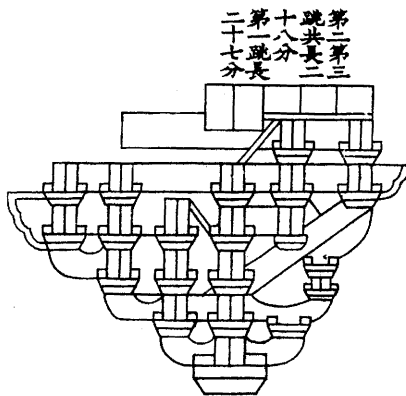

第二第三  
跳共長二  
十八分  
第一跳長  
二十七分

第三第四  
跳共長三  
十五分  
第二跳長  
一十五分  
第一跳長  
二十三分

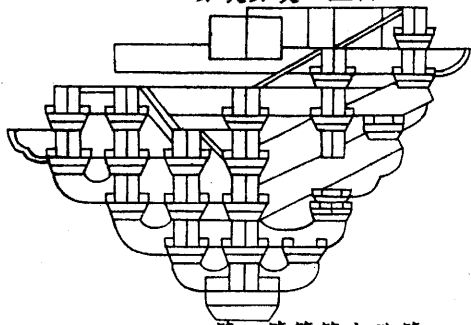

七鋪作重拱出上昂偷  
心跳內當中施騎料拱

第四第五  
跳共長二  
十六分  
第三跳同  
第二跳長  
一十六分  
第一跳長  
二十六分

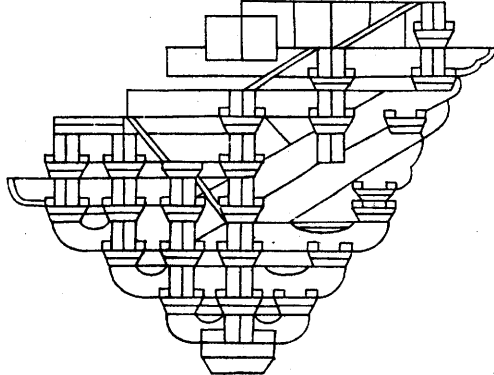

八鋪作重拱出上昂偷  
心跳內當中施騎料拱



第四分舍屋折

朱紋為第一折  
中紋為第二折  
華紋為第三折

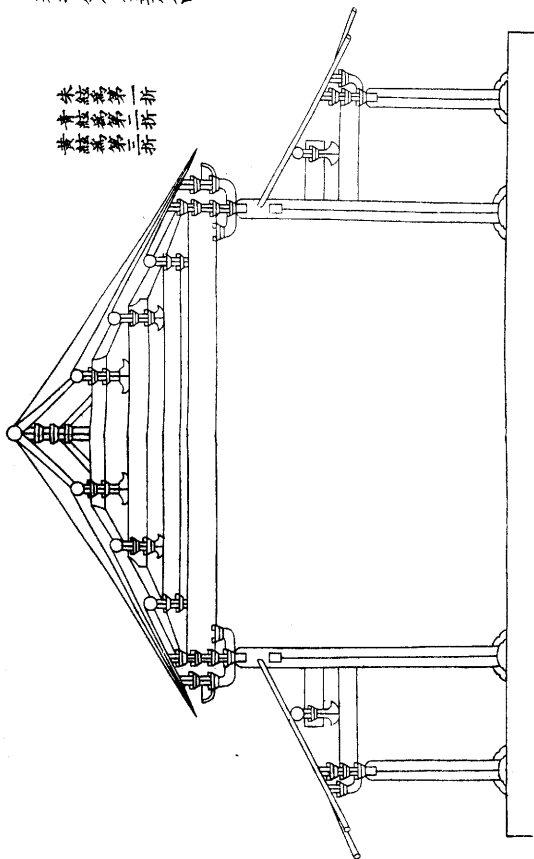

本機關公用第五號

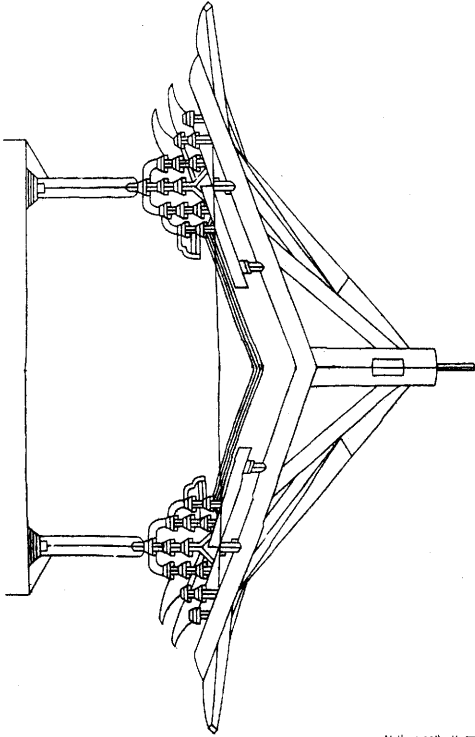

木榑圖式用為瓦榑者

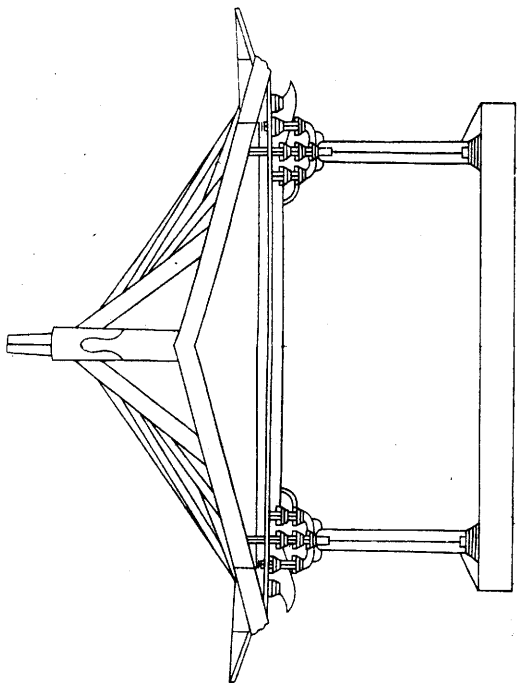

絞割鋪作拱昂料等所用卯口第五

以五鋪作名件卯口為法其六鋪作以上並隨跳加長

華拱第二跳外作華頭子如第三跳以上隨跳加長

華拱  
足材

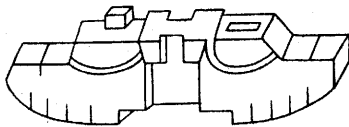

華拱  
昂材

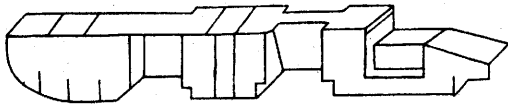
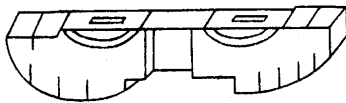

關梁

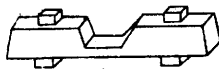

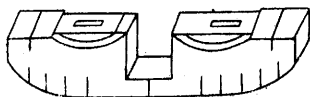

泥道拱  
上施  
開渠

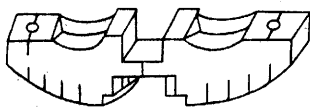

瓜子拱  
外施



瓜子拱  
裏施

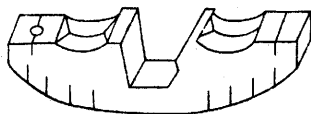

瓜子拱  
絃拱

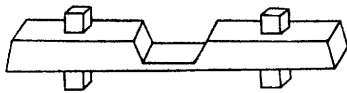

慢拱  
堂內用上

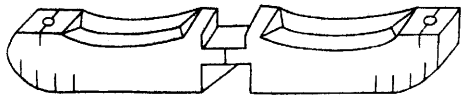
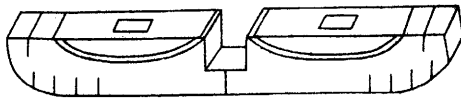

慢拱  
外殿騎  
昂用

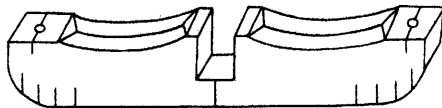

慢拱  
裏用

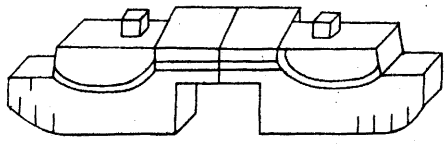

慢拱  
足材  
拱用

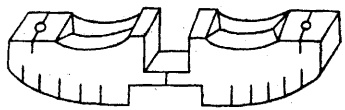

令拱  
外  
拱用

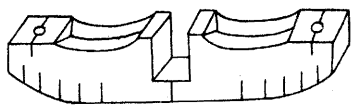

令拱  
裏  
拱用

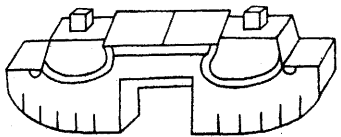

令拱  
足材  
拱用

華棋與泥道棋相列外用

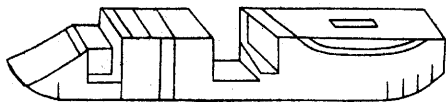
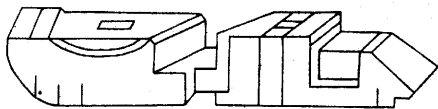
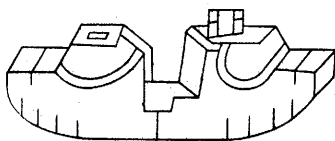
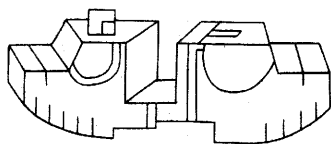

慢棋與華頭子相列外用六鋪作  
以上應加長



瓜子拱與小拱頭相列外跳用

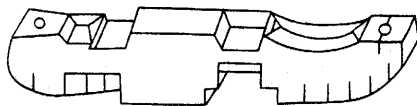
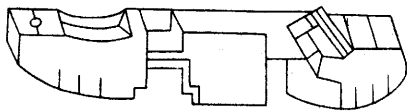

慢拱與切几頭相列外跳用

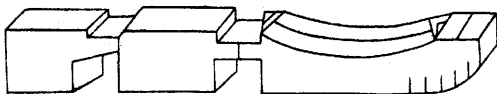
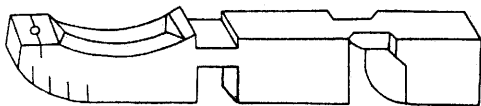

瓜子拱與令拱相列  
外說當考字音也六  
 編作以上並用瓜子拱

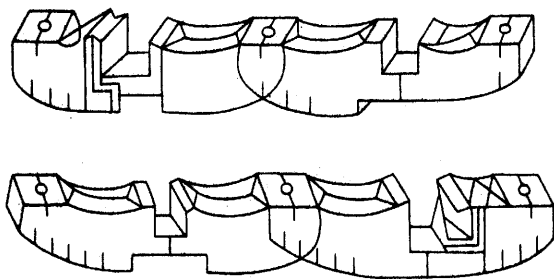

慢拱與切几頭相列  
用

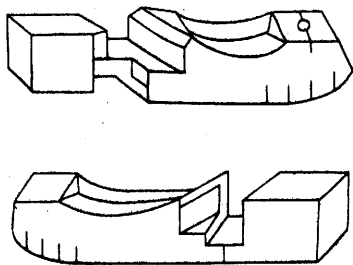

瓜子拱與小拱頭相列裏用

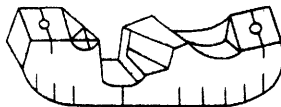
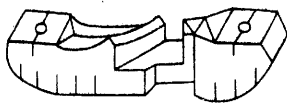
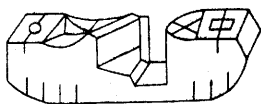
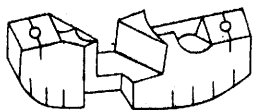

令拱與小拱頭相列裏用

柱頭或補間鋪作內第二跳下昂第三跳以上隨跳加大

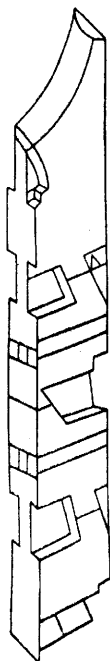

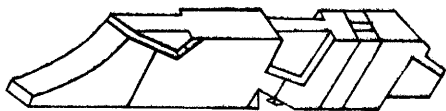

合角下昂  
角內用六鋪作  
 以上隨跳加長

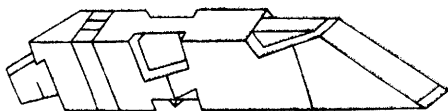

要頭  
外跳昂  
 上用

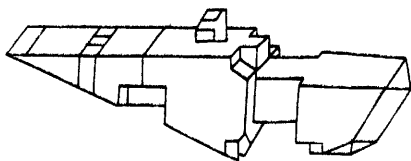

要頭  
裏跳上用七鋪作  
 以上隨跳加長

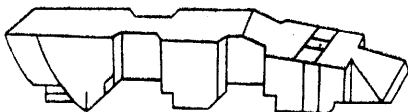

視方頭

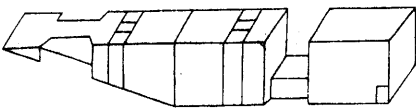

華拱一跳用

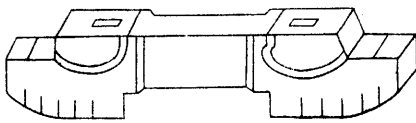

華拱角內第二跳用七鋪以上隨跳加長

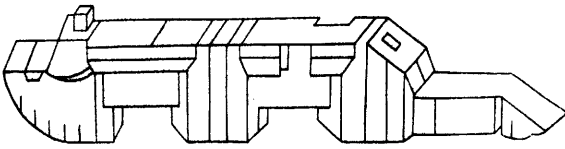

耍頭角內用七鋪以上隨跳加長

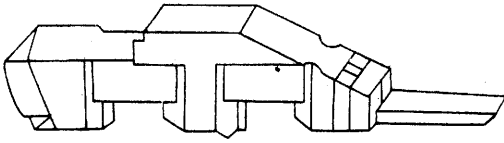

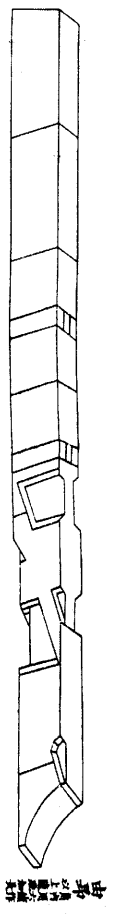

由形  
以上圖示  
打

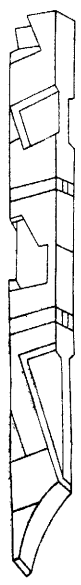

下形  
以上圖示  
不作

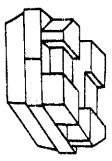

方鐵  
以上圖示

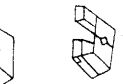

平鐵  
以上圖示

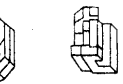

齊心  
以上圖示



齊心  
以上圖示

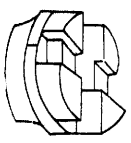

圓鐵  
以上圖示

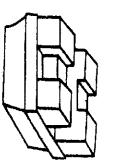

方鐵  
以上圖示



軟料  
以上圖示



齊心  
以上圖示



交互  
以上圖示



軟料  
以上圖示



平鐵  
以上圖示



齊心  
以上圖示

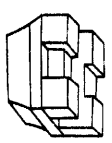

軟角  
以上圖示



圓鐵  
以上圖示

# 梁額等卯口第六

梁柱偏口  
鼓卯

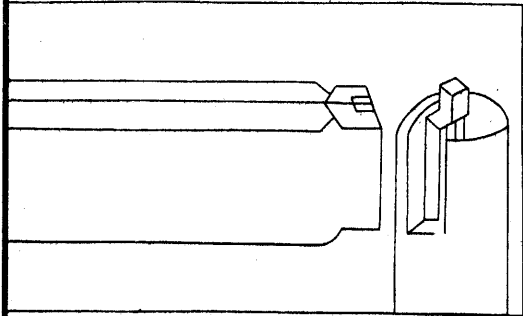

梁柱鼓卯

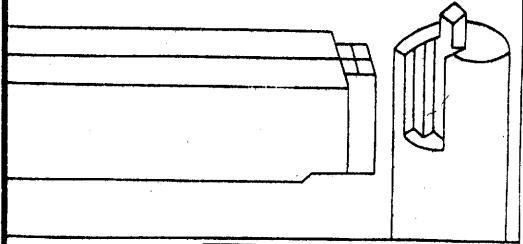

梁柱對卯  
鼓卯  
普通字

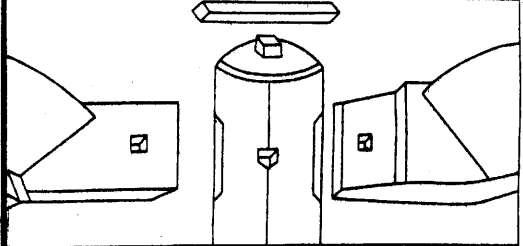

棟間縫  
棟端  
頭口

普拍方間縫  
棟端  
頭口

普拍方間縫  
勾頭  
樣字

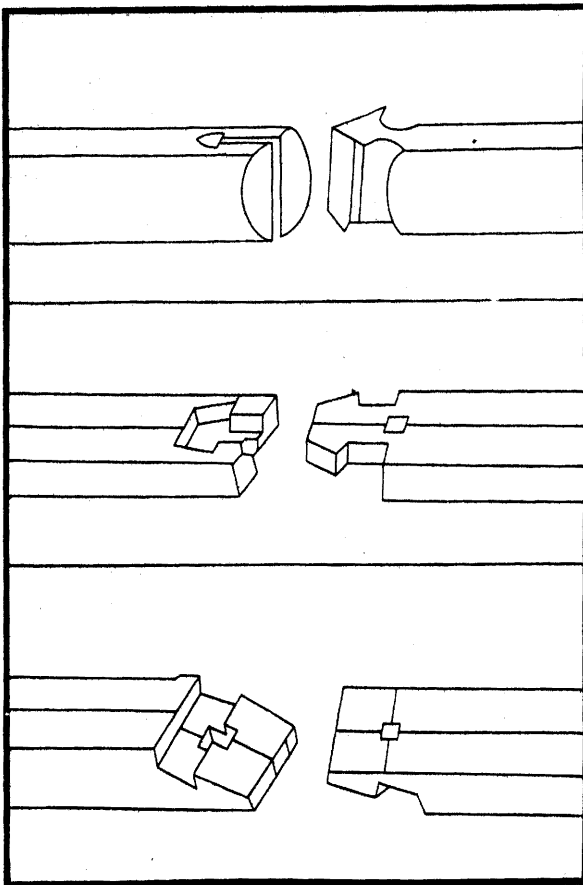



合柱鼓卯第七

兩段合

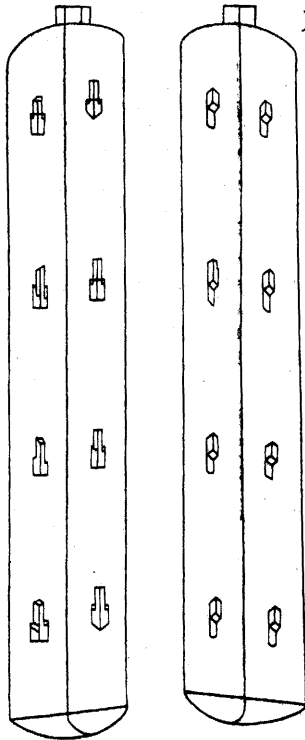

暗鼓卯



正樣

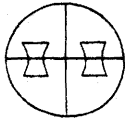

蓋鞠明鞠  
鼓卯



橫楔

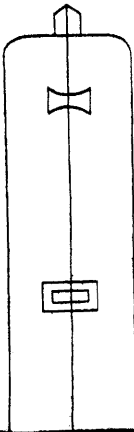

三級合口段

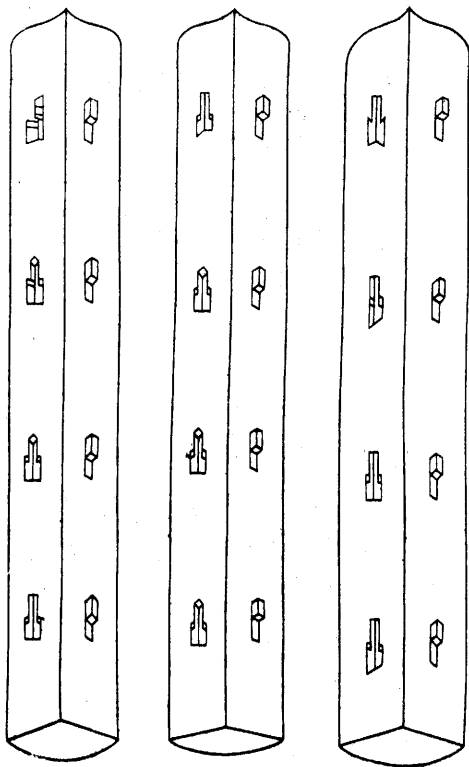

棹梁間第八

梁間

梁間

合榱

梁間

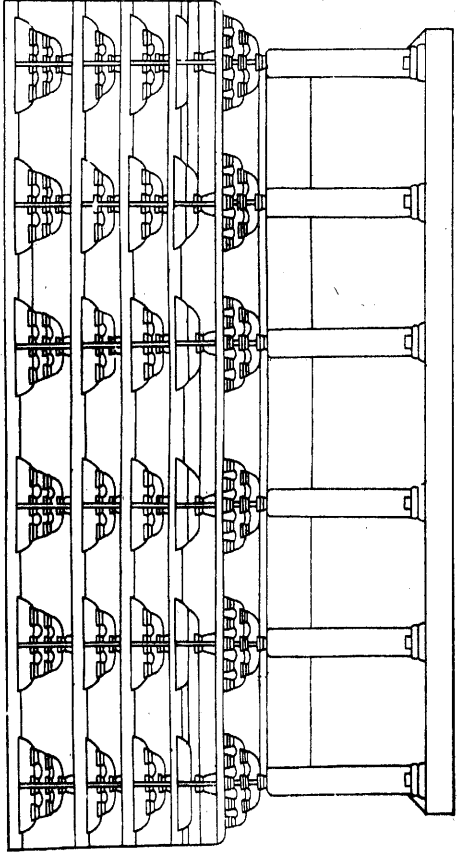

鋪作轉角正樣第九

殿閣本榑等轉角正樣四  
鋪作壁內重拱插下昂

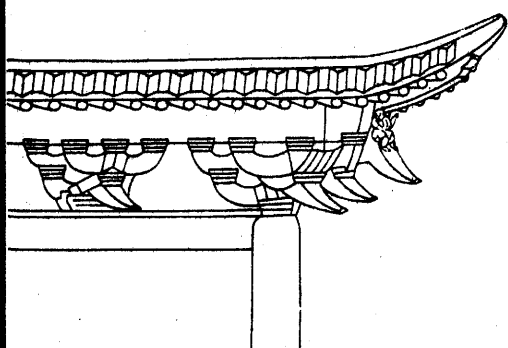

殿閣本榑等轉角正樣五鋪作  
重拱出單抄單下昂連點計心

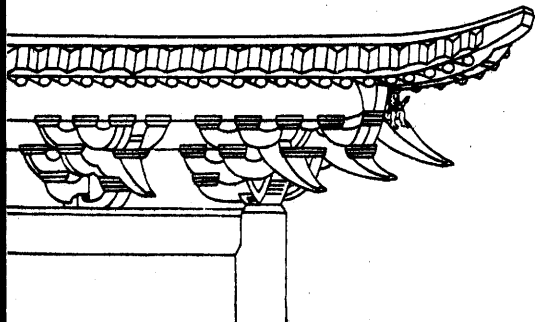

殿閣斗栱各轉角正樣六鋪作  
重栱出單抄兩下昂逐跳計心

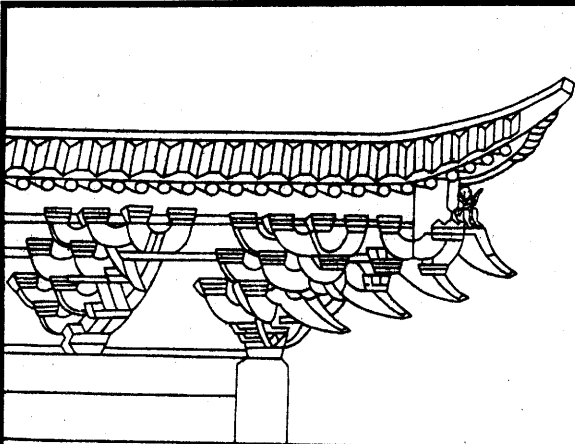

殿閣斗栱各轉角正樣七鋪作  
重栱出雙抄兩下昂逐跳計心

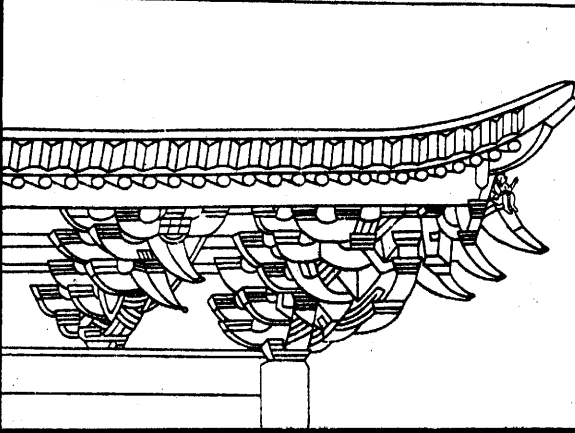

殿閣亭榭等轉角正樣八鋪作  
重拱出雙抄三下昂逐跳計心

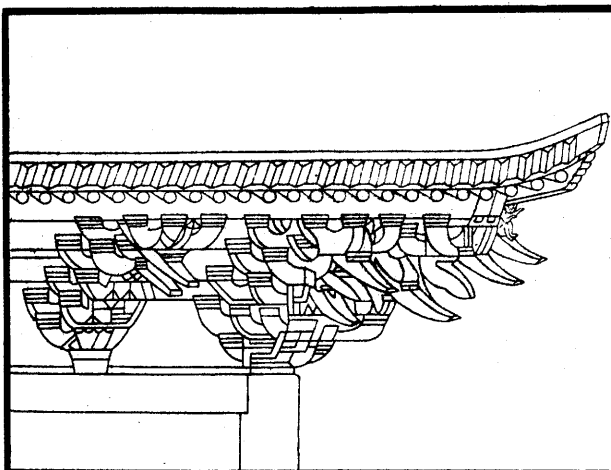

樓閣平坐轉角正樣六鋪  
作重拱出卷頭並計心

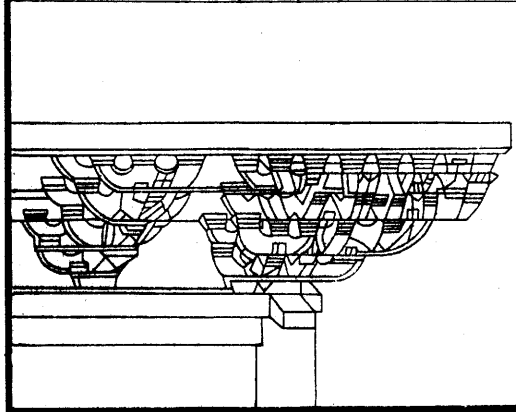

檼間平坐轉角正樣七鋪  
作重棋出卷頭並計心

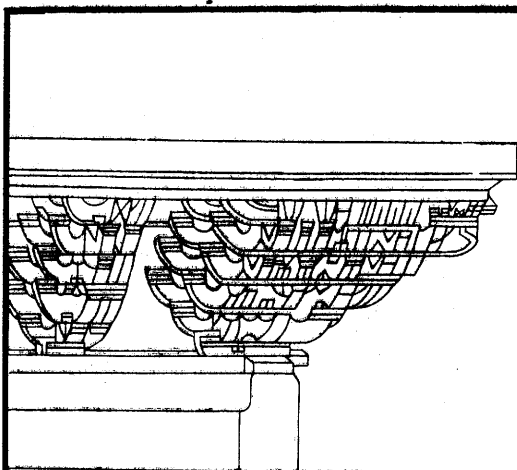

檼間平坐轉角正樣七鋪作重棋  
出上昂偷心跳內當中槐膝科拱

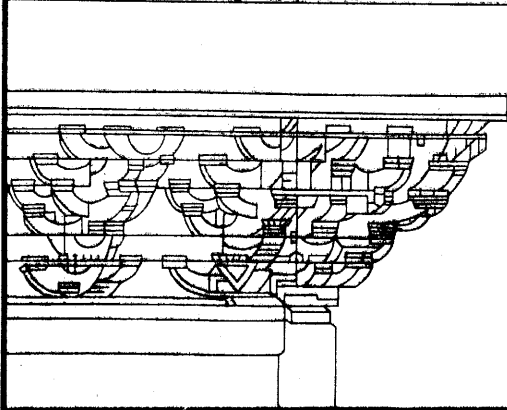

營造法式卷第三十





# 拱斗等卷殺第一

斗科相傳規矩以斗口尺寸為定論如斗口柳拱一吋應定瓜拱長六寸二分萬拱應長九寸二分廂拱應長七寸二分此三種拱子用於柱外為外拽單彩瓜拱外拽單彩萬拱外拽廂拱此不惟單彩者惟此三俱以心萬拱柱長同單彩惟按二斗口定高二寸以斗口一份定厚一寸○柱內裏拽單彩各拱子相同外拽尺寸○正心瓜拱正種拱子而已惟分別裏外拽頭層二層名稱庶免相混以上拱子等件係用於宮殿正而○柱中心正身上之側面斗科統謂之出彩料件○坐斗以斗口二份定高二寸以三份定長三寸以斗口一寸加三份定進深一寸三分○出彩頭

二層上下翅頭出彩頭

二層上下昂及要頭揀

頭俱以斗口二份定高

二寸以斗口一份定厚

一寸槽桁椽定長厚同

出彩料高以椽架定之

說見 出彩各料以幾彩

幾拽架定長○拽架以

斗口一十三份定之每

拽架應寬三寸○螞蟻

頭六分頭麻葉頭等以

一拽架定長○正心枋

同正心拱子裏外拽枋

同單彩拱子定高厚以

面闊定長○瓜三萬四

廂五言之以分定拱灣

之辨也起二回三搭拉十而定昂背之斜垂也

以升展二份三份定之餘仿此

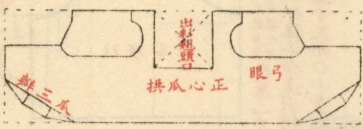

角料十八斗以平身  
 科尺寸相同惟見方  
 加斜以斗口一寸應  
 加斜四分一厘升腰  
 四份共八分應加斜  
 三分二厘八毫定之  
 應方二十五分三厘  
 餘仿此

槽升子以斗口一寸加  
 二升腰定女每升腰二  
 分應長寬俱一十四分  
 高一寸

平身十八斗以  
 斗口一寸加四  
 升腰前見定長  
 一寸八分高寬  
 同槽升子

坐斗  
 前見

柱頭音貫柱下石今稱柱頂石以柱徑二份  
 定厚三份定方如柱徑一尺二寸應厚二  
 尺四寸方三尺六寸

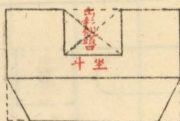
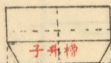
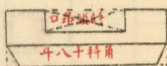

要頭上下昂及六分頭以出杉料找架定前見○替木頭以柱內卯榫定之如卯寬三寸卯即柱中之眼勿論已透未透皆謂之卯應厚二寸九  
 分後字入也以口二份定高六寸兩頭用釘向上釘之○三岔頭大者用於箍頭枋以枋至角柱上頂卯榫十字通出頭仍  
 同枋身大小相同者謂大三岔頭枋身以柱徑定之如柱徑八寸即寬八寸每尺收三寸定厚五寸五分○小者由柱  
 卯內穿出向外露之榫前見用此謂之小三岔頭餘仿此

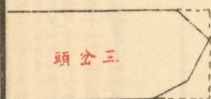
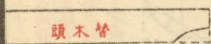
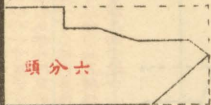
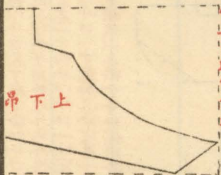

斗栱抱不  
代梁者仍據  
抱栱如代  
斗栱者以柱  
徑寬厚加柱  
徑半應加  
一寸定寬一  
尺以厚每尺  
加半定寬  
一尺半如  
代斗栱者同  
換梁總厚半

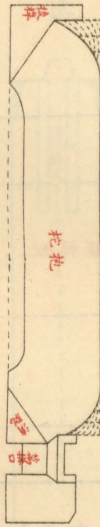

月梁者以柱式或圓形者呼之曰  
深者曰定抱。小者以此梁本或有圓  
柱者亦如十月式謂之月梁以下抱收二  
寸定如柱一尺半即外一尺一寸每  
尺半寸者一尺四寸五分以此

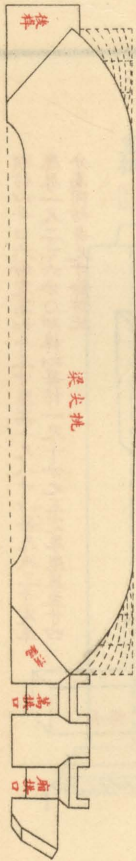

換梁總厚  
斗栱抱不  
照梁寬之  
換梁厚半  
口六寸半  
如斗口半  
斗栱者一  
尺應加半  
定寬五寸  
十六分

額枋并柱樣

額枋以斗口六份定高如斗三寸應高一尺八寸以每尺減三十定厚  
 應厚一尺二十六分○卯榫以每枋一尺十分之三定厚應厚五十四  
 分高同枋身尺寸餘仿此

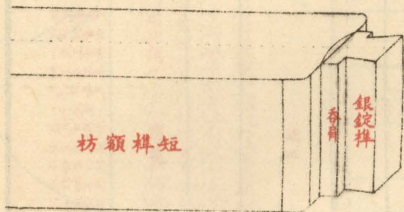

枋額榫短

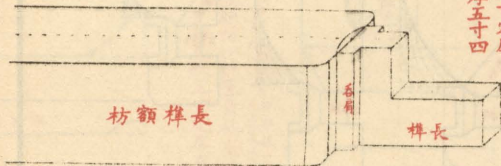

枋額榫長

榫長

直柱

今名  
楹柱

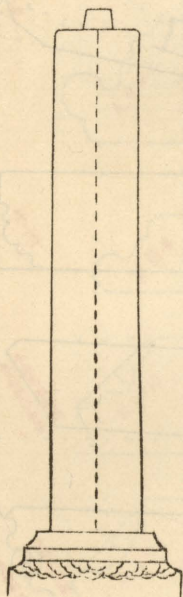

梭柱

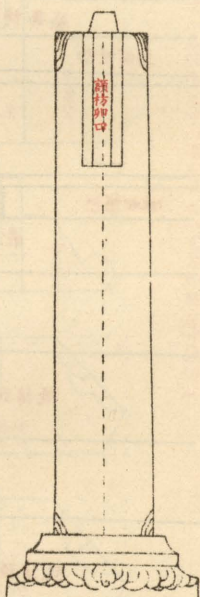

梭柱式以上下消腮之謂也直柱即今楹柱式○楹柱以斗口六份定圓徑如斗口三寸  
 即應徑一尺八寸以斗口六十分定高即高一丈八尺柱上下每高一丈應小一寸謂之槩卯榫見餘仿此

梓角梁以樣  
徑二份寬厚  
如樣徑三寸  
即厚六寸以  
三份定高即  
九寸外加斜  
加長之法如  
步架七尺見  
後加出檐六  
尺九寸加銜  
三椽徑九寸  
共長一丈四  
尺八寸即以  
此每丈加斜  
長四尺一寸  
即定長二丈  
零八寸六分  
八厘外加榫  
頭

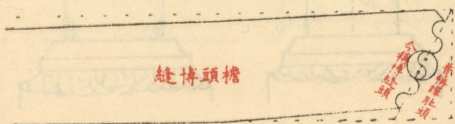
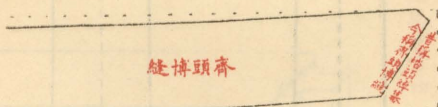
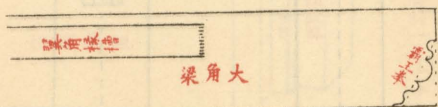

大角梁高厚同梓角梁定長應退減一粗飛樣頭斜長三尺二寸四分三厘再  
退減二斜樣徑八寸四分六厘共斜長一丈六尺七寸七分九厘外加榫  
檐頭博縫以步架出檐加舉見定長如步架五尺出檐三尺六寸外加頭當

一椽徑定厚即厚二寸五分蟬肚頭斜一半分七份凸凹圓式為之博縫內定標  
中立正之線法以博縫寬定標中斜線如五舉每尺斜五寸六舉每尺斜六寸將博  
縫立起時標中上下即正博頭線兼指管標即今齊頭博縫同檐頭博縫餘仿此

一檐徑  
二寸五  
分共通  
長八尺  
八寸五  
分再加  
舉長以  
每尺加  
長二寸  
統長一  
丈零六  
寸二分  
以七椽  
徑定寬  
應寬一  
尺七寸  
五分以

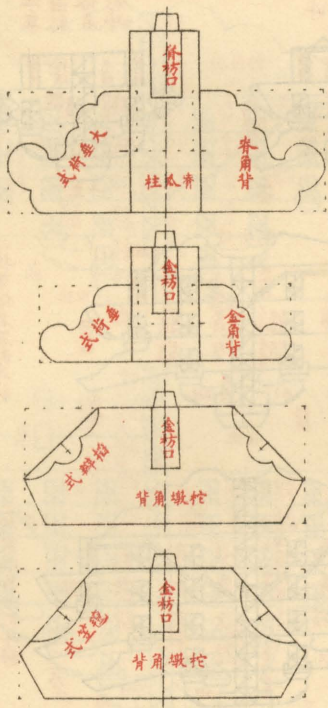

挖墩角背背背以舉架定高代如舉高二尺削去上平水五寸下挖背三寸五分應定高一尺一寸五分以一步架定長後如步架二尺五分即定長二尺五分以挖厚一尺每尺收三寸定厚即厚七寸瓜柱角背除長同挖墩角背以瓜柱二份定高如瓜柱高一尺六寸五分應高一尺一寸以瓜柱徑九寸以徑三分之一定厚即厚三寸餘仿此



### 下昂上昂出跳分數第三

下昂側樣

昔云幾鋪  
今云幾彩

正名品字單  
翹斗科出彩  
一拽架俗名  
品字三彩斗  
科

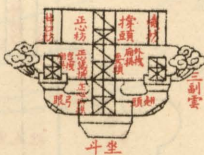

正名單昂斗  
科出彩一拽  
架俗名三彩  
斗科

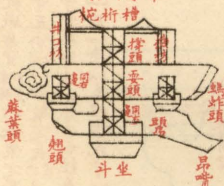

正名單翹單昂斗科出彩  
二拽架俗名五彩斗科

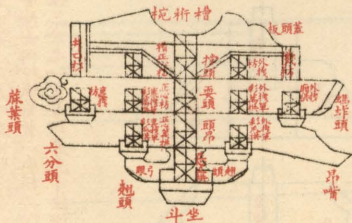

正名單翹重昂斗科出彩  
三拽架俗名七彩斗科

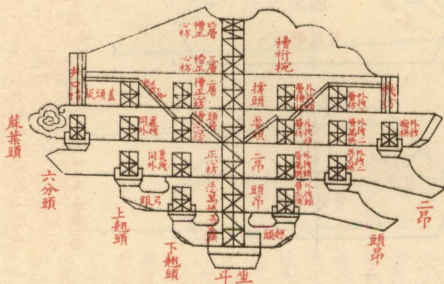

斗科側面長料昔云出跳今云出彩左列各升斗以每橫側面繪之逐件標註名稱所有瓜拱萬拱廂拱及出彩昂翹架各件之規矩詳見前二篇

正名重翘重昂斗  
科出彩四拽架俗  
名九彩斗科裏由  
撐頭斜起枰杆至  
金枋相交托之名  
曰溜金斗科

正名重翘三昂斗  
科出彩五拽架俗  
名十一彩斗科裏  
由撐頭斜起枰杆  
至金枋相交托之  
名曰溜金斗科

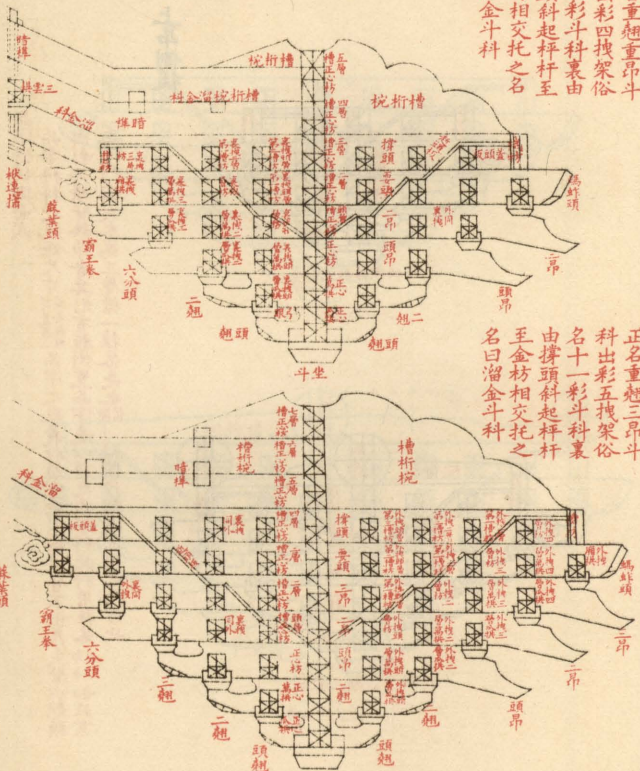

上昂側樣

品字科科側面式

品字科科之規矩尺寸詳見第一編各說明品字之取義以所有出彩科件皆不出昂尖皆以翹頭  
 出彩兩頭皆無昂者其形有類倒置品字是以謂之品字科此科用挂落即平如北京  
 正陽門樓大木為三層檐一挂落是也即平殿閣內部或亦用之餘仿此

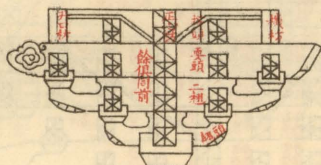

科科字品超二彩五

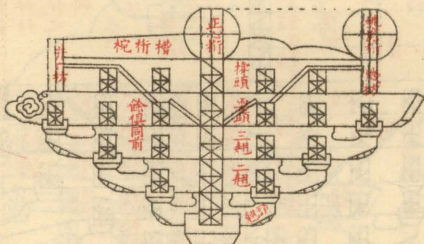

科科字品超三彩七

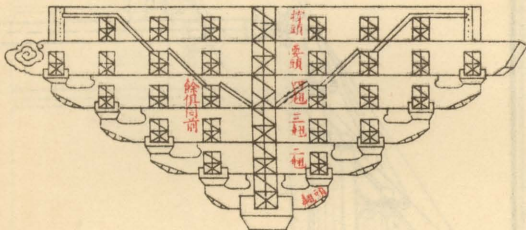

科科字品超四彩九

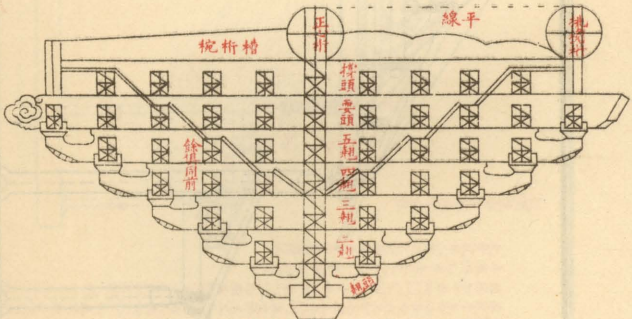

科科字品超五彩一十

聚折屋脊第四折

集折全圖  
斗架集折

木柱為第一折

青柱為第二折

黃柱為第三折

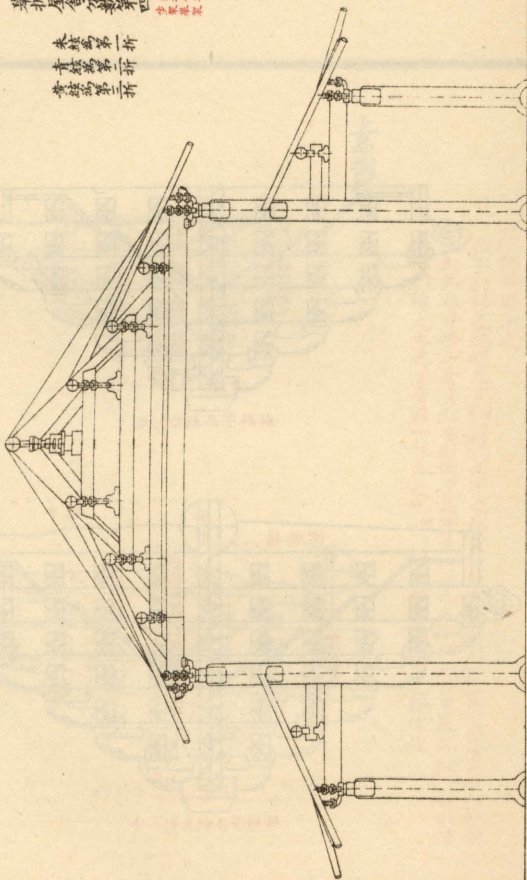

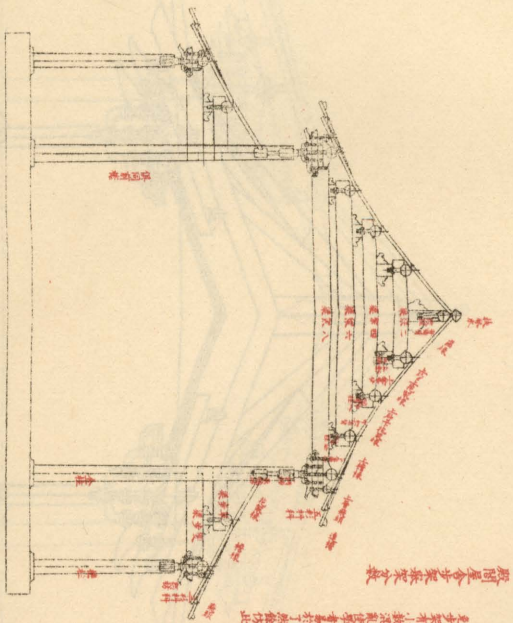

殿閣屋脊架梁架

大脊者料者尺半以內之如料口三寸者料口六寸定柱即應入寸以料六十  
 份定柱而即應一丈八尺者料口定柱加二定厚即二尺厚即二尺厚即二尺六寸  
 其二按樣式以一成或減按樣式料口二分定厚即先正心枋以枋四分定厚即一尺五  
 寸者以枋口二分定厚之即不圓四寸五分者枋二分者以枋口二分定厚之即應六尺九寸  
 增柱步架者由前柱至後柱全各半份動者十步架由端正心枋至後枋動者十步架者十  
 步架步架即每步六尺初架按樣式定者即每二尺一按六尺者即每步三六寸三  
 步架即每步六尺至四尺二十步者每步四尺至五寸四分者每步四尺至五寸四分者  
 步架即每步六尺至四尺二十步者每步四尺至五寸四分者每步四尺至五寸四分者  
 步架者小款深淺後者者於下處修此

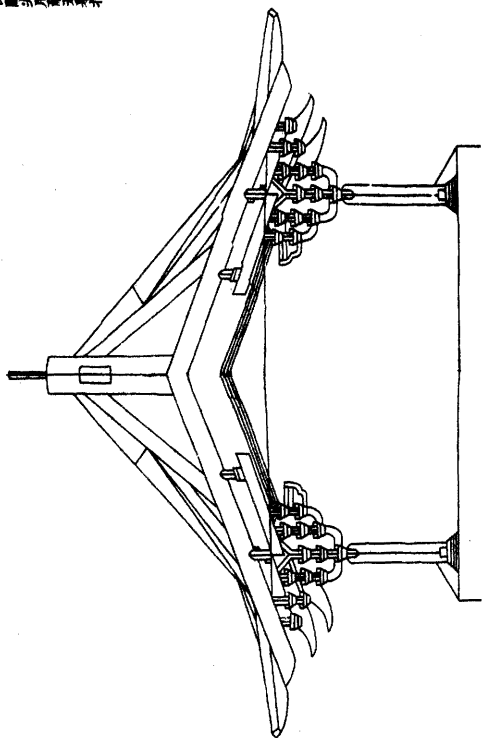

木構圖式屋瓦架

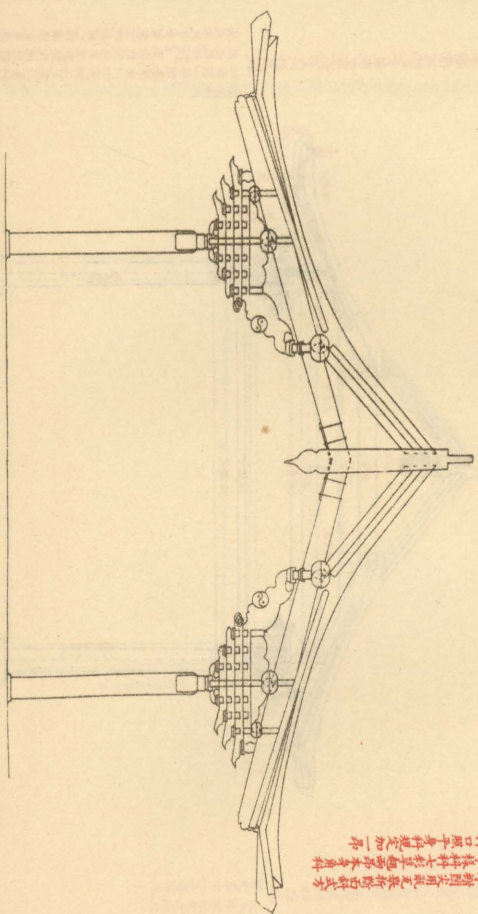

其精則用瓦瓦要折防百料方  
 亦係料木杉木樹木木魚料  
 料口平者料規定加一升



其大木尺寸步架架規矩前已詳明惟大角架柱與  
 架之規矩<sup>即此</sup>亦與前大角架動換柱徑同標柱而  
 以步架一節受其柱角以柱徑加二皮厚以厚加三皮  
 高餘仿此

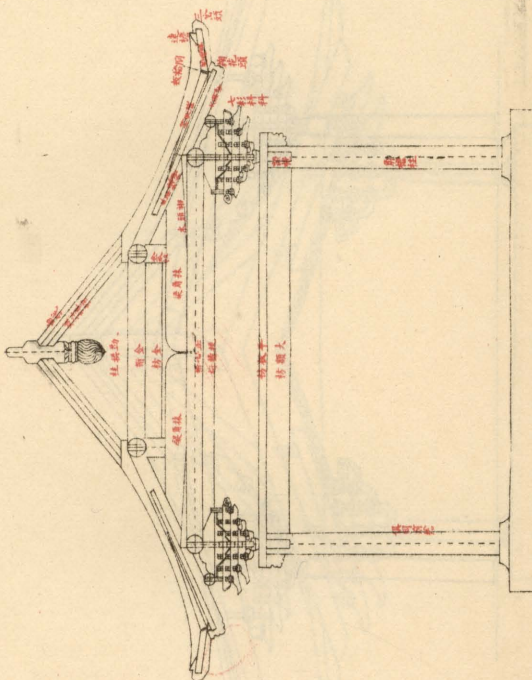

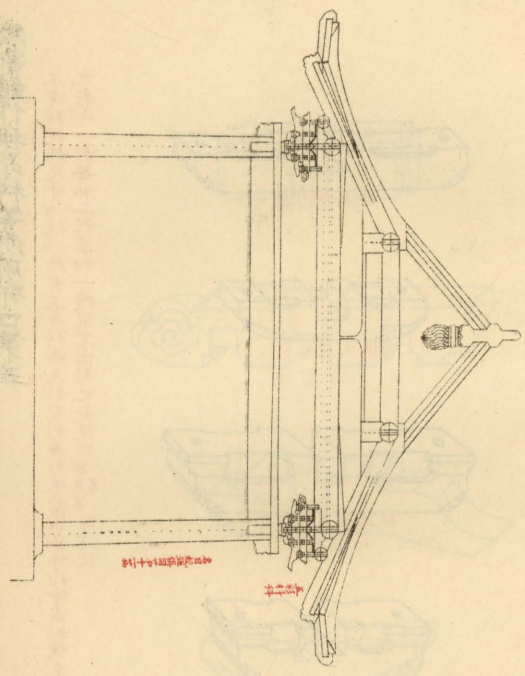

木構屋架之種類及構造式  
 大木架屋架之種類  
 詳見十卷條例

# 絞割鋪作拱昂料等所用卯口第五

正身科規矩尺寸詳見前篇所有正身科由三彩五彩七彩應需各分件均繪圖如後至  
 九彩十一彩每加二彩須加一拽架定出彩之長規矩詳見前篇餘仿此

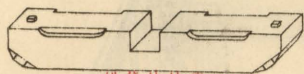

拱萬拽外裏

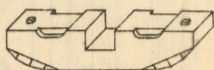

拱瓜拽外裏

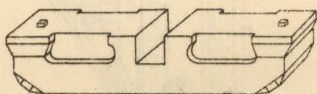

拱萬心正科耳正

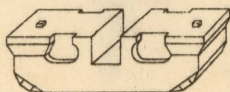

拱瓜心正科身正

正身科出彩料所用料口各分件

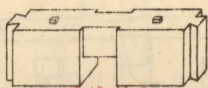

頭撐彩三

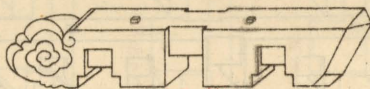

頭耍彩三

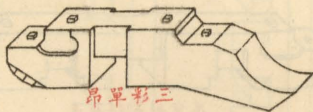

昂單彩三

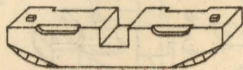

拱廂拽外表

正身科出彩料所用料口各分件

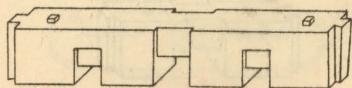

頭撐彩五科身正

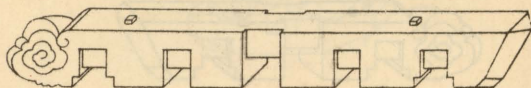

頭耍彩五科身正

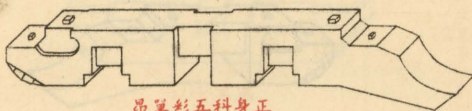

吊單彩五科身正

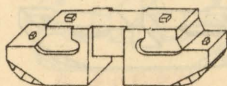

頭翹彩五科身正

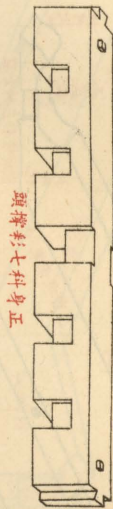

頭攢彩七科身正



頭耍彩七科身正

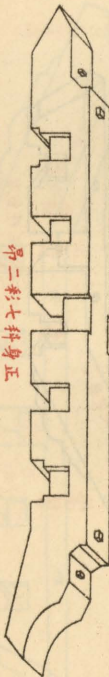

頭二彩七科身正

溜金科規矩以柱內裏後尾起枋杆以托定金桁為止以舉架定之詳舉法其餘以柱外面如三彩者同三彩科科五彩者同五彩科科餘仿此

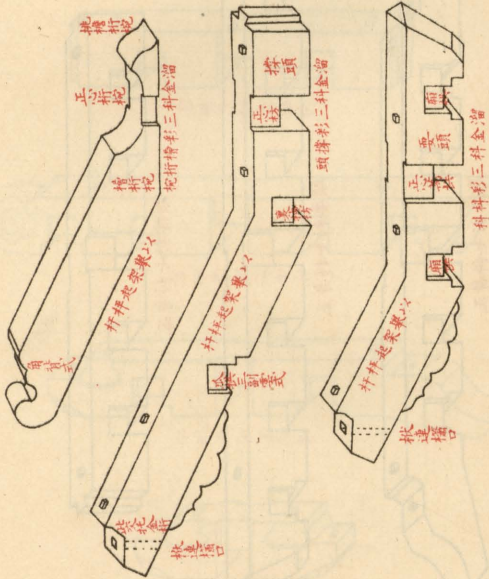

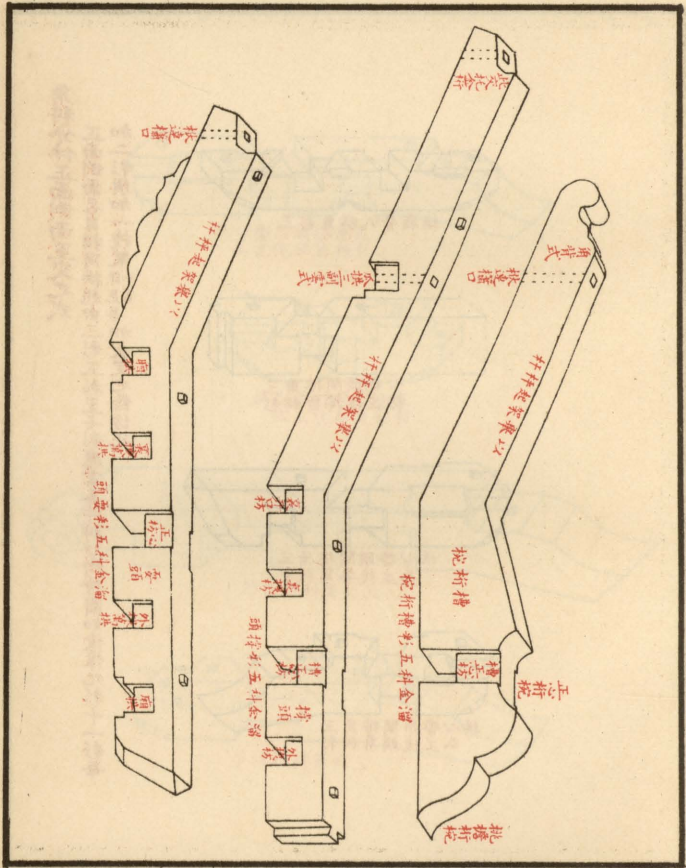



角科分件正面側面互交之式

正面側面名目相同拱起由三彩五彩至七彩應當各件料口均繪圖如後惟九彩十一彩每加二彩須加一拽架詳見第一篇加長定之餘仿此

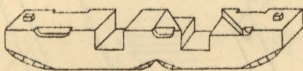

拱廂背八科角彩三

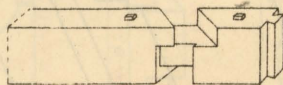

三彩角科搭角  
三彩角科搭角  
心帶頭間搭角三  
枋正後撐角科

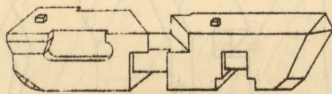

三彩角科搭角  
三彩角科搭角  
拱心帶頭間搭角三  
萬正後要角科

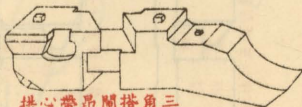

三彩角科搭角  
三彩角科搭角  
拱心帶昂間搭角三  
瓜正後頭角科

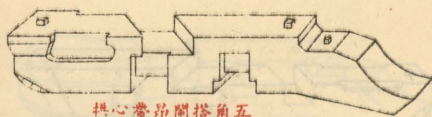

五脚搭閣昂帶心拱  
彩角單後正萬

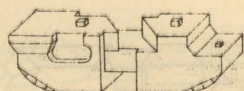

五脚搭閣起帶心拱  
彩角單後正瓜

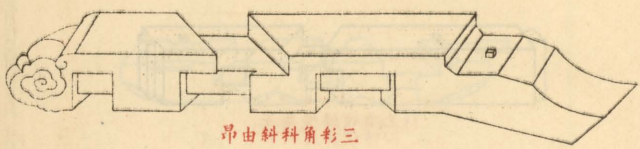

三彩角科斜由昂

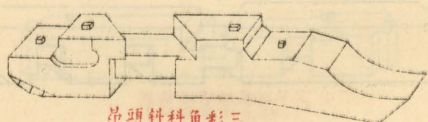

三彩角科斜頭昂

角科分件

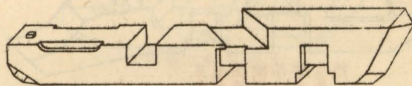

萬單後單單搭角五  
拱彩帶頭彩角科彩

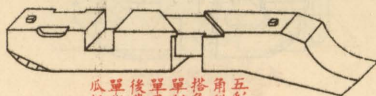

瓜單後單單搭角五  
拱彩帶吊彩角科彩

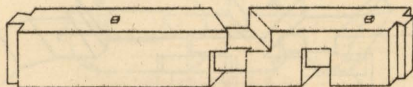

枋正帶頭闌搭角五  
心槽後撐角科彩

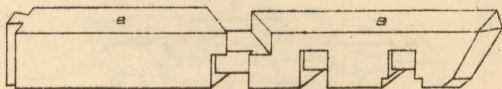

心帶頭闌搭角五  
枋正後要角科彩

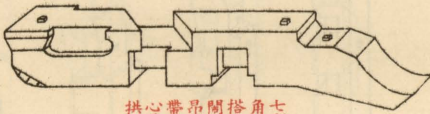

拱心帶昂閭搭角七  
萬正後頭角彩

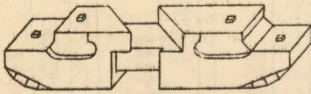

頭翅斜科角彩五

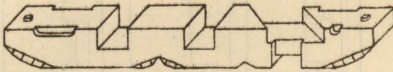

拱廂背八科角彩五

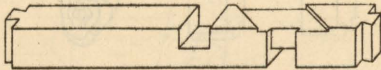

枋外後揀單搭角五  
搜帶頭彩角科彩

角料分件

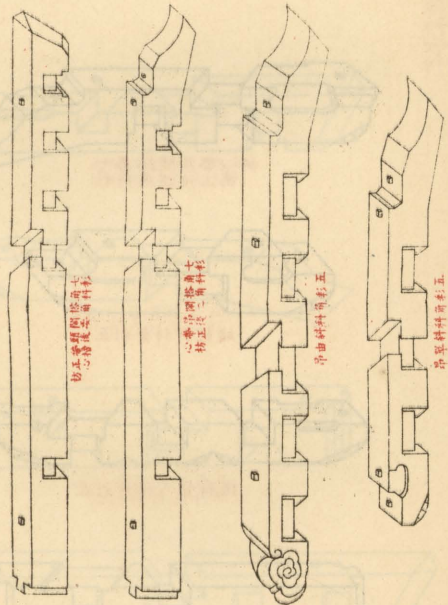

物五帶額圓餘高七  
心增廣云角料形

心帶帶圓餘高七  
物五波二角料形

昂曲料角形五

昂單料角形五

角科外件

帶頭科疊外角科  
枋孔腹架疊頭科

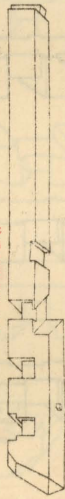

昂出科枋腹科七



昂二科枋腹科七



枋五帶頭圓枋角科  
枋心枋腹

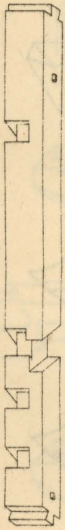

角科分件

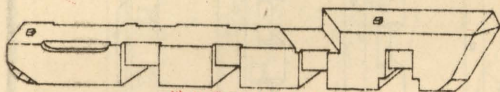

拱彩帶頭彩層外角七  
萬單後安單二科彩

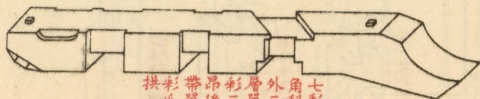

拱彩帶昂彩層外角七  
瓜單後二單二科彩

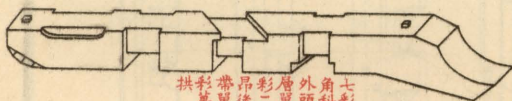

拱彩帶昂彩層外角七  
萬單後二單頭科彩

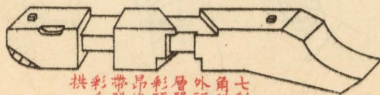

拱彩帶昂彩層外角七  
瓜單後頭單頭科彩

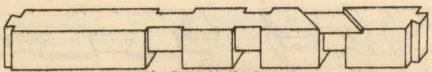

七角外層彩帶頭携  
彩科二單撐後外枋



七角彩科八背廂拱

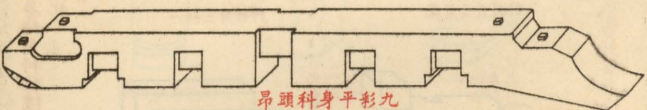

九彩平身科頭昂

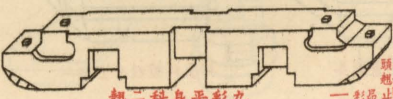

九彩平身科二翹

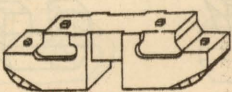

九彩平身科頭翹

料科規矩三彩者一携架五彩者二携架七彩者三携架九彩者四携架十一彩者五携架此以柱外柱算柱內相二彩者即一五拱一萬拱二須加一携架此科科各彩分件列表由三彩起至七彩所有平身科角科應有各件互相通用全行齊備惟九彩者僅繪此三件形式列表以證明相同各彩如加彩惟須次第加携架此九彩頭翹同五彩單翹同七彩頭昂十一彩此九彩頭昂同七彩頭昂十一彩此三件表明每加二彩須加一携架互相通用之法餘仿此



科科分件尺寸規矩詳見第一篇所有平身科角科柱檣科各坐科十八科  
槽升子升耳等件規矩俱同前餘仿此

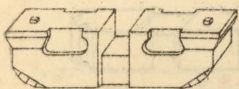

耳升點子升二葉蘇件分

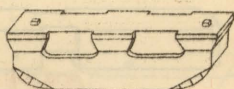

耳升點子拱升三科一件分

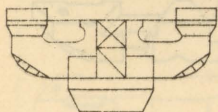

科科升二葉蘇

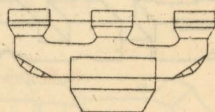

科科升三科一

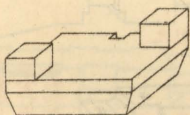

科坐科角彩各

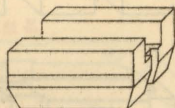

科坐科檣柱升三科一

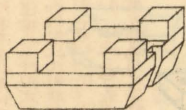

科坐科檣柱彩各

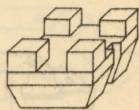

科坐科身平彩各

坐料十八枓槽升子升耳及溜金科椽連櫺寶瓶等各分件式寶瓶者  
用於角科由昂上以頂托角梁之立木也



耳斗十各  
升八彩



耳升科角彩各



耳科正各  
升身彩



子升槽彩各



連科溜  
檣椽金



升帶各  
子槽彩



瓶寶科角彩各



子槽角各  
升科彩

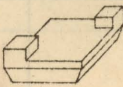

枓八十科角彩各

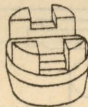

枓坐科椽圓



枓八十彩各

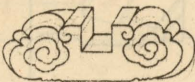

頭雲葉蘇升二葉蘇件分

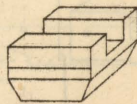

枓坐科身平升三枓一

# 梁額等卯口第六

梁枋檐柱  
鑄口  
鼓卯

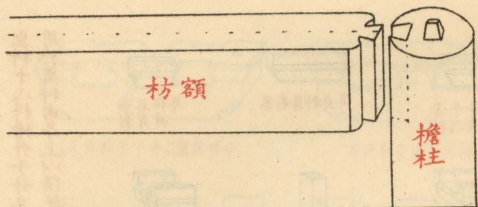

額枋檐柱  
吞口  
鼓卯

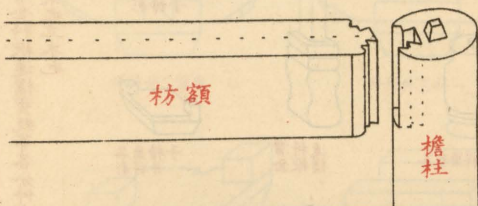

梁柱對卯  
鑄批接掌  
溝眼穿串

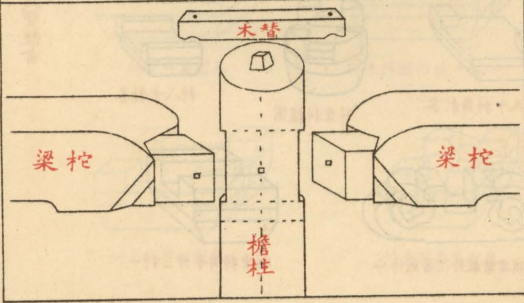

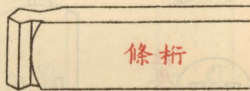

桁條間縫  
頭口

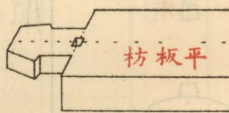
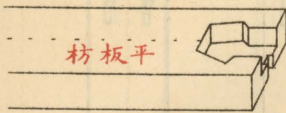

平板枋間縫  
頭口

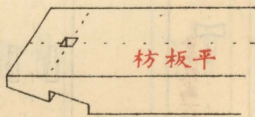
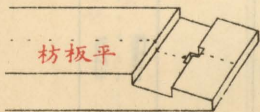

平板枋間縫  
勾頭

# 合柱鼓卯第七

兩段合  
如柱木尺子有數用者則以兩段合法為一柱餘仿此

榫暗



暗鼓卯



柱底正式



木眼錠



柱榫

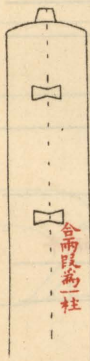

合兩段為一柱

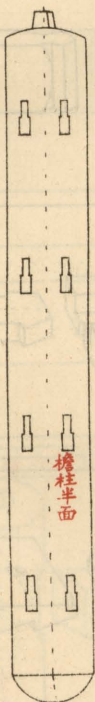

檐柱半面

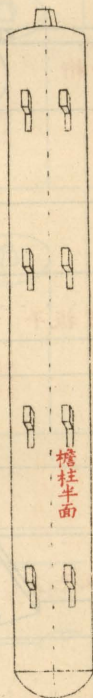

檐柱半面

三段合殿

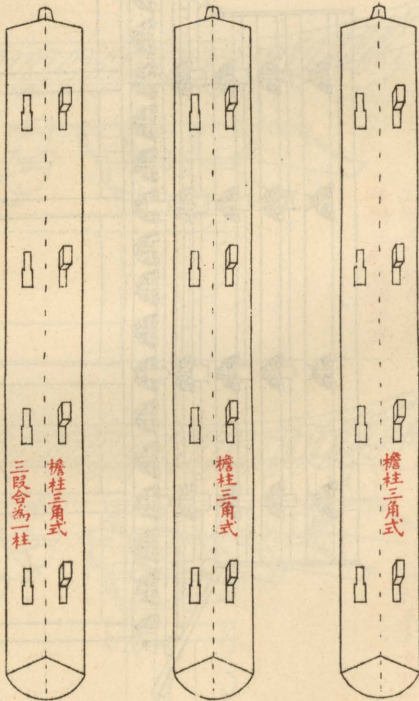

大間椽縫接

石礎  
木架  
木椽  
木梁  
木柱

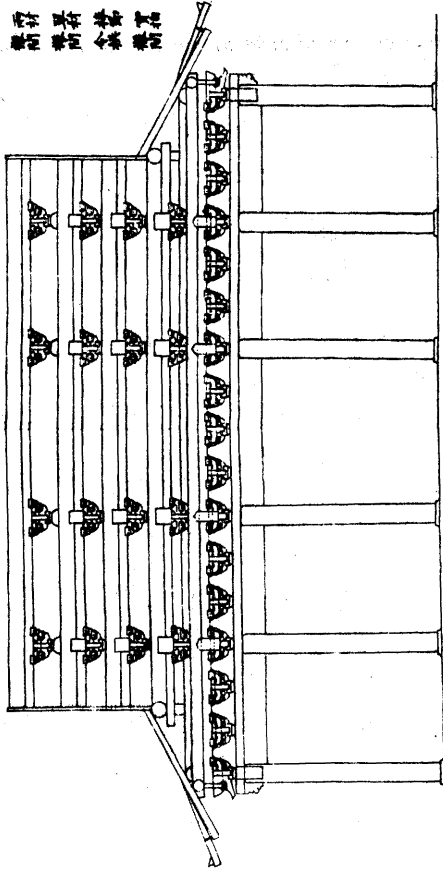

鋪作轉角正樣第九

殿閣亭等轉角正樣  
斗科三彩重拱單昂

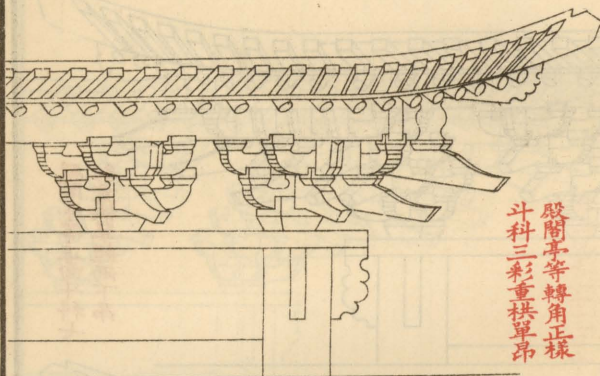

殿閣亭等轉角正樣  
斗科五彩重拱一昂

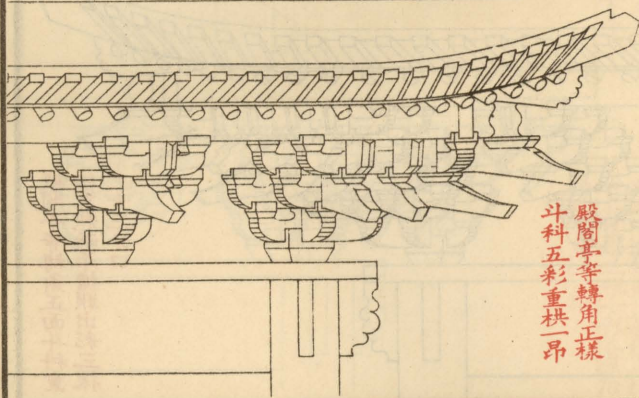



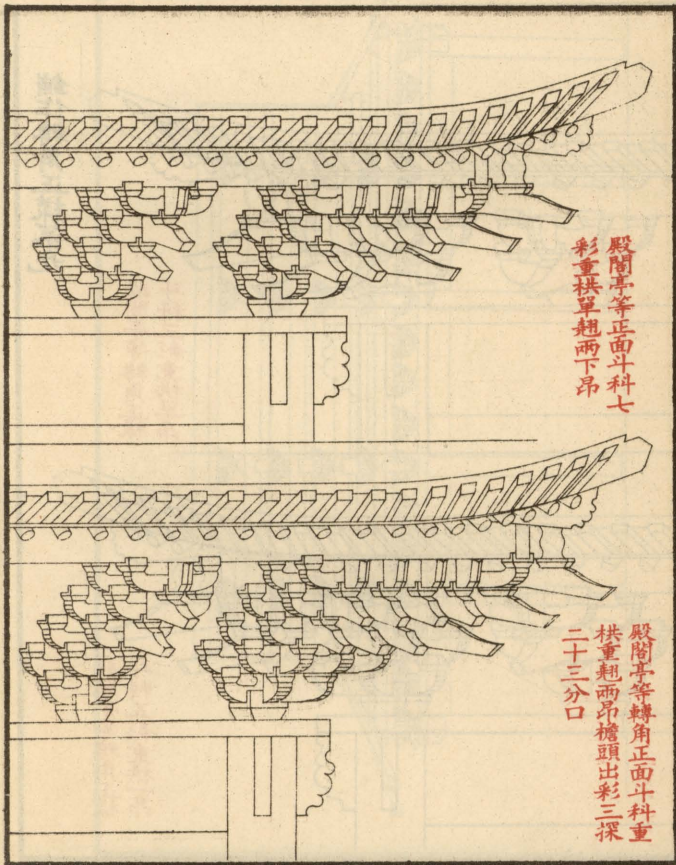

殿閣亭等正面斗科七  
彩重拱單起兩下昂

殿閣亭等轉角正面斗科重  
拱重起兩昂檐頭出彩三探  
二十三分口

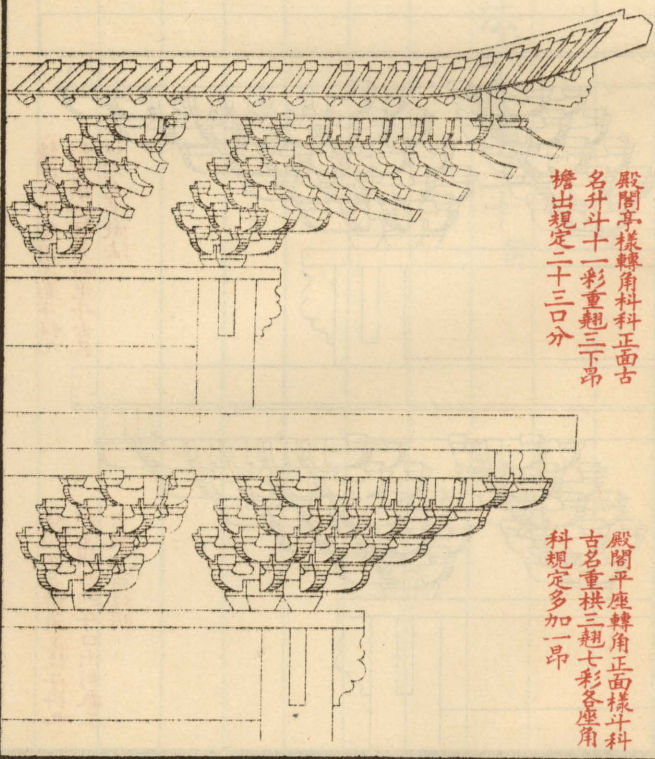

殿閣亭樣轉角科正面古  
 名升斗十一彩重翹三下昂  
 檐出規定二十三口分

殿閣平座轉角科正面樣斗科  
 古名重拱三翹七彩各座角  
 科規定多加一昂

樓閣平座轉角正面斗科九  
 彩重棋四翅角科坐斗古名  
 規定連半做法

樓閣平面轉角正樣斗科九  
 彩重棋四翅斗口出彩卷三  
 十第三篇註明

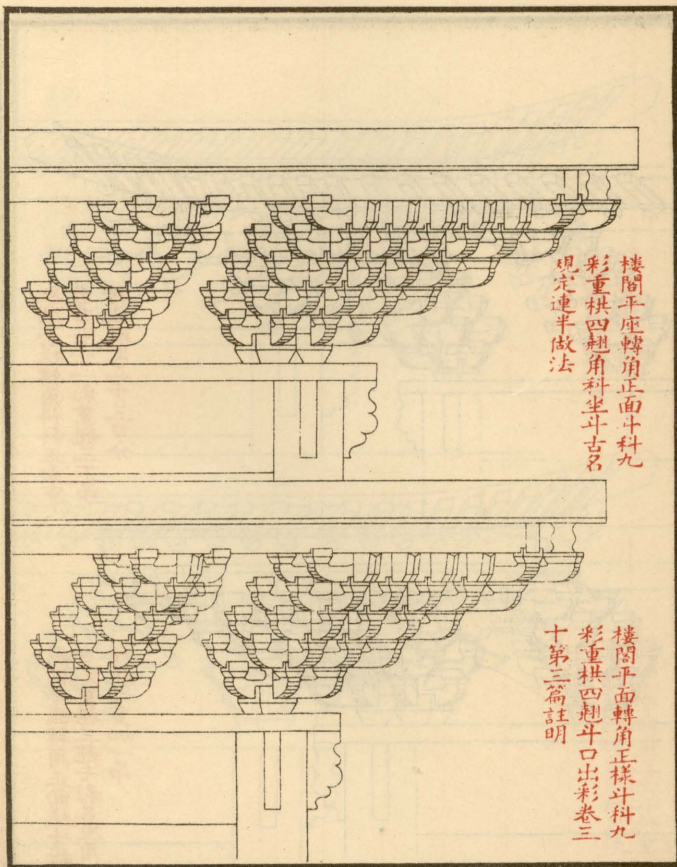

營造法式卷第三十附

虹口法院移交  
陳公博案內圖書

營造法式

六

卷五十四

一百十四

上海图书馆藏书



A541 212 0004 0532B

上海圖書館

