

554

SCIENTIFIC LIBRARY



UNITED STATES PATENT OFFICE

GOVERNMENT PRINTING OFFICE

11-8625





THE ARTIZAN:

A Monthly Record of the Progress

OF

CIVIL AND MECHANICAL ENGINEERING,

SHIPBUILDING, STEAM NAVIGATION, THE APPLICATION OF CHEMISTRY
TO THE INDUSTRIAL ARTS, &c.

EDITED BY W^M. SMITH, C.E.,

F.G.S., F.C.S., F.R.G.S., &c.

LIBRARY

VOL. XIII.,
NEW SERIES.

VOL. XIX.
FROM THE COMMENCEMENT.

U. S. PATENT OFFICE

London:

PUBLISHED AT THE OFFICE OF THE "ARTIZAN" JOURNAL,
19, SALISBURY STREET, STRAND, W.C.

1861.

EXAMINED BY

T
I

.A8

LONDON:
PRINTED BY JAMES HENRY GABALL,
AT THE "SCIENTIFIC PRESS," No. 3, RUSSELL COURT, BRIDGES STREET, COVENT GARDEN, W.C.

21.288

INDEX TO VOL. XIX.

THE ARTIZAN JOURNAL, 1861.

A

Accidents in Paris, 20
 Address read at the British Association Meeting, 223
 Address to readers, 1
 Aerometry, by J. Bennett, 207, 255
 Air propulsion of vessels, 96
 Air pumps, foot valves, and their proportions, 67
 Alps, proposed tunnel through the, 120
 Alumina, production of, 194
 American government experiments, on the expansion of steam, 54
 American lake steamers, 20
 American Notes, 20, 41, 43, 46, 70, 95, 96, 122, 169, 262
 American steamers, dimensions of 61
 American screw pile lighthouse, Pamlico Sound, 269
 Anchors and cables, testing, 192
 Annual report of Musketry, 289
 Anvil block, cast at Newcastle, 70
 Applications for letters patent, 146, 170, 195, 219, 243, 267, 291
 Arches and chains, paper on, 125
 Armour cased ships of war, 5, 15, 20, 42, 84, 96, 120, 163, 192, 215, 239, 263, 287
 Armour cased ships, C. Atherton on the speed of, 23
 Armstrong guns, 43, 72, 121, 194, 216, 249, 264, 289
 Armstrong R., on the measures of the resistance of steam vessels at high velocities, 107
 Arsenal at Woolwich, 18, 20, 265
 Artesian wells, 22, 46, 98, 170
 Atherton C., on freight as affected by differences in the dynamic properties of steam ships, 233
 Atmosphere, iodine in the, 46
 Atmospheric post, 20

B.

Barometrical indications, value of, 6, 42,
 Barracks for the army, 214
 Bateson's feed-water heating apparatus, 277
 Beacons, B. B. Stoney on the construction of floating, 111
 Bennett J. on Aerometry, 207, 255
 Bidder G. P., on coast defences, 189
 Birkenhead penny ferry, 143
 Bitumenized paper pipes, 192
 Boat lowering apparatus, 96

BOILERS:

Cheap boiler plates, 46
 Elder's cylindrical spiral, 30
 Incrustation in, prevention of, 20
 Notes on the construction of, 199
 Notes on the nature of steam, in relation to, 162
 Strength of, correspondence on the, 91, 115, 140, 165
 Strength of, J. Mc F. Gray on the, 26
 Boiler explosions, 22, 46, 73, 193, 218, 242

Boiler explosions, Association for the prevention of, 22, 46, 73, 98, 121, 145, 169, 218, 242, 266, 290
 Books, new, or new editions of, 67, 91
 Bourne-mouth, pier at, 260
 Bowditch Rev. W. R. on coal gas, 30
 Brickmaking machinery, 287

BRIDGES:

Blackfriars, 265
 Clifton suspension, 217
 Fairbairn W. on the effects of vibratory action upon wrought iron bridges and girders, 228
 Lambeth, 145, 217
 London, 22
 New Westminster, 122, 197
 Niagara suspension, 22
 Railway bridge over the Rhine, 98, 122
 Russian railway, 265
 Spanish railway, 145
 Turner and Gibson's improvements in, 77
 York, fall of a bridge at, 265
 British Association for the Advancement of Science, 223, 256, 277
 Bronze, new kind of, 74
 Brown's armour plates, 289
 Buckingham palace, improvements in, 95
 Building stone in the United Kingdom, 21

C.

Cables, Locwenstein's apparatus for submarine, 55
 ——— W. H. Preece on the maintenance of, 13
 Caloric engines for America, 18

CANALS:

Accident on the grand junction, 242
 Bridgewater canal, bursting of the, 98
 Bursting of a, 217
 East Indian Irrigation and Canal Company, 217
 Grand Junction Canal Company, 22
 Illinois and Michigan, 22
 Indian, 169
 Suez, 265
 Weir for canals and other similar works, 131

Cartridges and projectiles, Krutzch's improvement in, 54

Casella's patent mercurial minimum thermometer, 259
 Casting in Glasgow, 18
 Cast platinum, 73
 Casting in Rotherham, 95
 Cement for rendering joints steam tight, 167
 Census of America, 262
 ——— England and Wales, 166
 ——— Ireland, 192
 ——— Paris, 214

CHEMISTRY:

Action of carbonate of soda on cast iron, 122
 ——— nitrates on vegetation, 170

CHEMISTRY:

Action of sulphurous acid on metals, 145
 Albumen used for dyeing, 23
 Analysis of manures, 23
 Application of oils in the manufacture of earthenware, 23
 Atomic weights, reciprocal relations of, 243
 Boiling points of different liquids, 195
 Carbonic acid in the soil, 99
 Chlorine, 290
 Cyanide of potassium for soldering metal, 170
 Disinfection of sewage, 266
 Dissolution of oxygenated water in ether, 23
 Electro-zincing, 23
 Estimation of iodine and bromine in mixture, 99
 Formation of fuming acid, 243
 Gilding porcelain, 266
 Green colours, 195
 Hydrated oxide of iron, 290
 Hydrate of Baryta, preparation of, 266
 Insoluble matter of zinc, 74
 Juices of india-rubber and gutta-percha, 23
 Manufacture of oxygen gas, 23
 Mineral collodion, 290
 Mineral Green free from arsenic, 99
 Molybdenate of ammonia, a test for sulphur, 99
 Monohydrated sulphuric acid, 46
 New aniline colours, 266
 New green colour, 23
 Nitro-prusside of sodium as a re-agent, 46
 Peroxide of lead, preparation of, 23
 Phosphorescence, 290
 Preparation of rosolic acid, 219
 Preparing nitrate of silver, 218
 Preparation of saltpetre, 266
 Purification of acetic-ether, 266
 Rubasse, a new stone, 243
 Sulphurous acid, manufacture of, 266
 Synthetic formation of a saccharine substance, 290
 Tyndall, J. on the physical basis of solar chemistry, 209
 Civil and Mechanical Engineers' Society, 90, 164, 212, 253, 279
 Clark, D. K., on steam, 55, 82, 101, 142
 Clay's breech-loading cannon, 149
 Clay, shipbuilding on the, 71, 283
 COAL:
 Coal hewing machinery, 290
 Compressed, 218
 Indian and Australian, 145
 Mines of, 21, 46, 194
 Peculiar products from some coal oils, 170
 Supply of, 73, 122, 192, 218
 Working of, important discovery, 74
 Coast defences, 97, 121, 144, 169, 189
 Coining at the Mint, 213
 Coinage for India, 192

Colliery accidents, 21, 266
 Committee on steamship performance, report of the, 256
 Compass in iron and other vessels, deviation of the, 115
 Copper and zinc alloys, 218
 Copper, new alloy of, 145
 Cornish mines, W. Gill on, 280
 Cotton manufactures, 214
 Craues, steam travelling, 119
 Cranes, steam, 70, 214
 Criticism on practical papers for practical men, 285
 Cumberland blacklead, 73
 Current Topics, W. Tite on, 280
 Cylinders, iron, for foundations, J. B. Walton on the various methods of sinking, 279

D.

Damper for copying letters, 185
 Danchell's water test apparatus, 185
 Dcroscope, the, 192
 Distances on the field, on the determination of, 142, 159
 Diving apparatus, 214
 Diving bell boat, 239
 DOCKS:
 Birkenhead, 73, 122
 Carlisle, 168
 Dry dock at Pembroke, 73
 Grand Surrey, 122
 Liverpool, 289
 Rennie's, G. B., floating pontoon, 50
 Dredger for Greenock, 217
 Dredging machine, launch of a, 121

E

Earth's crust, W. Fairbairn on the temperature of the, 162
 Elastic force of vapours, M. V. Regnault on the, 9
 Elder's cylindrical spiral boiler, 30
 Electric cables, 12
 Electric postage, 239
 Engineering field work, W. J. M. Rankine on the application of transversals to, 37
 Engine drivers' short hours movement, 20
 Engineers, naval, appointments of, 193, 215, 263, 287
 ENGINES:
 Auxiliary engines of the Great Eastern, 101
 Double winding engine for the coal trade, 120
 Ericsson's caloric, 20, 41
 Grande's rotatory, 167
 High pressure engines and boilers, 167
 Lenoir's gas engine, 262
 Loss by friction of load in the principal parts of the, 245, 272
 New motive power, 214
 Notes on the construction of, by L. O., 131, 876, 199
 Steam engines in Great Britain, estimated horse power of, 41
 English and American inventions, 141
 English coinage, 20
 Exhibition for 1862, 20, 71, 95, 143, 167
 Expansion of steam, 38, 53
 Experiments (various), 42, 70, 72, 73, 169, 217, 240, 262, 289
 Export trade, 167

F.

Facility in coal lading, 46
 Fairbairn W., address to the British Association at Manchester, 223
 Fairbairn W. on the temperature of the earth's crust, 162
 Fairbairn W. on the effects of vibratory action upon wrought iron bridges and girders, 228
 Feed water heating apparatus, Batesou's, 277
 Figures, cutting and shaping, 214
 Filter, improved chemical, 42

FIRE ARMS:

Whitworth's, 121
 Westley Richard's rifle, 144, 216
 Fire insurance duty, 192
 Fire engines, C. B. King on steam, 279
 Foreign notes, 21, 22, 41, 70, 71, 95, 97, 99, 119, 239, 262, 265, 286, 288
 Foundry swallowed by a coal mine, 262
 ———, A. F. Yarrow on the, 90
 Fox F. on the results of trials of varieties of iron permanent ways, 111
 Frankland E. on some phenomena attending combustion in rarefied air, 188
 Freight as affected by differences in the dynamic properties of steam ships, 233
 French opera house, 19
 Froude W. on the junction of railway curves at transitions of curvature, 33

G.

Gases, J. Tyndall on the action of, on radiant heat, 186

GAS:

Bowditch, Rev. W. R., on coal gas, 30
 Cardiff Gas Company, 98
 Consumption of, in Paris, 122
 Dividends of gas companies, 21, 218, 242
 Explosive of, 21, 73, 242
 Gasometers at Hackney, 98
 Gas on railways, 73, 145
 Gas on steamers, 46, 122
 Glycerine in gas meters, 21
 Indique fuites, 21
 Lighting of, S. Hughes on, 128, 151, 180, 200
 Lighting steamers with, 21
 New gas companies, 21, 169
 New gasometers, 265
 New gas meters, 98, 265
 Preventing gas pipes from rusting, 41
 Purifying coal gas, 21, 25, 46
 Reductions in the price of, 21, 122
 Report of Dr. Lethaby on, 169
 Gearing, J. Robertson on frictional, 185
 Geometry of the slide valve, by J. Mc F. Gray, 16
 Gill, W., on cornish mines, 280
 Girders, paper on comparison of, 197, 270
 ———, wrought-iron bridges and, effects of vibratory action upon, by W. Fairhairn, 228
 ———, paper on continuous, 78
 ———, paper on lattice, 101
 ———, paper on proportioning, 149, 173
 ———, testing for the Manchester corporation, 221
 ———, strength of, 49
 Glue, new marine, 262
 Government appointments, 95, 193
 Government dockyards, 42, 73, 96, 98, 145
 Government troop steamer for the Indus, 29
 Grantham, J., on the classification of iron ships, 163
 Gray, J. Mc F., on the strength of boilers, 26
 Great Eastern steam ship log returns, 137, 179, 206
 Great Eastern steam ship, auxiliary engines of the, 101
 Gunpowder, F. Hudson on white, 216

GUNS:

Armstrong, 43, 72, 121, 194, 216, 249, 261, 289
 Clay's breech loading, 149
 Experiments with, 43, 72, 194, 241, 249, 264, 265, 289
 For the navy, 19
 Lancaster cast-iron, 264
 New guns for the Government, 121
 Time gun at Edinburgh, 120
 Warry's breech-loading, 144
 Whitworth, 43, 72
 Gyroscope governor, 93, 117

H.

Hammer, compressed air, 18
 Hammers, large steam, 119, 192, 263
 Hammering rolled copper, 99

HARBOURS:

Blythe, 98

HARBOURS:

Brean Down, 288
 Falmouth, 289
 Great Harbour, Malta, 98
 Holyhead, 145
 New harbour bills, 98
 Portsmouth, 290
 Refuge, 145
 Sebastopol, 265
 Swansea, 217
 Harwich, redonht at, 143
 Haswell, C. H., on the strength of materials, 7, 157, 183, 248, 275
 Haswell, C. H., on the resistance of wrought iron tubes to external and internal pressure, 134
 Higgin's railway break, 12
 Hindostan Copper Company, 290
 Hooghly and the Mutla, J. A. Longridge on the, 278
 Houses of Parliament, 191
 Hughes, S., on gas lighting, 128, 151, 180, 200
 Hull, trade at, 289
 Hydrogen gas for illuminating, 20
 Hyperbolic logarithms, 252

I.

Ice, density of, 42
 Institution of Naval Architects, 84, 113, 163
 Institution of Civil Engineers', 13, 62, 110, 161, 189, 277
 Institution of Mechanical Engineers', 211
 Institution of Engineers in Scotland, 43, 87
 International Exhibition for 1862; 20, 71, 95, 143, 167
 Irish industry, museum of, 266

IRON:

Bryson, W., on the strength of pillars of, 253
 Cementation of, 74
 Conversion of, into steel, 50, 83
 Discovery of ore, 73
 Haswell, C. H., on the resistance of wrought iron tubes to external and internal pressure, 134
 Iron church for Southport, 119
 Plated ships of war, 5, 15, 20, 42, 84, 89, 120, 165, 168, 192, 215, 239, 263, 287
 Mixing cast, with nickel, 21
 New plan for rolling, 263
 Passivity of, 46
 Preservation of, from decay, 120
 Shields, F. W., on iron construction, 231
 To distinguish iron from steel, 290

J.

Jones's targets, experiments with, 216, 240
 Joule, J. P., on the surface condensation of steam, 33
 Joule, Dr., remarks on some researches of, 103

K.

King, C. B., on steam fire engines, 279
 Kruttsch's improvements in cartridges and projectiles, 54

L.

Landing stage, Kew, 263
 Lading stage, Newport, 167
 Leaky vessels, apparatus for, 97

LEGAL DECISIONS:

Austen v. Asphaltum Company, 191
 Bawer v. Mackay, 213
 Blyth v. Samuda, 69
 Burgess v. Wickham, 191
 Clapham v. Langton, 142
 Cottam, v. Metropolitan Railway Company, 286
 Freemantle v. London and North Western Railway Company, 94
 Glass v. Boswell, 119
 Grist v. Colyer, 18
 Howard v. Ledger, 18
 Howes v. the great Ship Company, 69, 119
 Newall v. Elliot, 18

LEGAL DECISIONS:

Neville v. Wright, 94
Pym v. Great Northern Railway Company, 166
Rae v. Thames Iron Works Company, 70
Russell J. Scott v. Great Eastern Steamship Company, 18, 41, 119
Schlumberger v. Salt, 70
Thames Iron Works Co. v. Royal Mail Steam Packet Co., 191
Smith v. Bowers, 191
Smoking in a coal pit, imprisonment for, 18
St. Thomas's Hospital v. Charing Cross Railway Company, 94
Train v. Lambeth vestry, 261
Warden of Dover Harbour v. Loudon Chatham and Dover Railway, 95
Young v. Gillespie, 166

Letters, damper for copying, 185
Lifeboat services, 287
Life belt of the national lifeboat institution, 164

LIGHTHOUSES:

American screw pile, Pamplico Sound, 269
On the Atlantic coast, 7
Welsh coast, 290
West Gavo Island, New South Wales, 20

Lime light, 95, 214, 221, 247, 286
Liverpool, trade of, 192

Loch Katrine, temperature of air at, 73
Loch Lomond lake, survey of, 170

LOCOMOTIVES:

American wheel tyres for, 239
Bill to regulate road, 213
Goods engine locomotive for the great North of Scotland Railway, 173
Locomotives on common Roads, C. B. King on, 164
Passenger locomotive for the Edinburgh and Glasgow Railway, 77
Plate frames for, correspondence on, 165
Steam breaks for, 20
Winans Locomotive Engines, 19
Loewensteins apparatus for submarine cables, 55
Logarithms, table of Hype rholic, 252
Log returns of the Great Eastern Steamship, 137, 179, 206
London association of foremen engineers, 62, 211
Londou streets, 239
Longridge J. A. on the Hooghly and the Mutla, 278
Loss by friction of load in the principal parts of the steam engine, 245, 272
Lucifer matches, manufacture of, 239

M.

Machinery and engines, notes on the construction of, by L. O., 131, 175, 199
Mail steam packets for the Holyhead and Kingston service, 6
Magnetic hammer, 41
Manchester corporation, testing girders for the, 221
Manchester Literary and Philosophical Society, 162, 279
Martin's liquid iron shells, 241
Mastic for setting boilers, 143
Materials, strength of, by C. H. Haswell, 7, 157, 183, 204
Mechanics' Institution at Wolverton, 214
Mercantile marine fund, 191
Merchant service of Great Britain, 214
Metropolitan sewers, 22, 99, 122, 145
Metal, fusible, 170
Meters, Shaw's improvements in, 222
Midland Waggon Company, 71

MINES:

Coal, 21, 46, 194
Copper, 21
Cornish mines, W. Gill on, 280
Gold, 21, 122, 194, 263
Lead, 99
Mining in Australia, 170
Mining in Turkey, 218
Spanish, 21
Ventilation of, 195
Mirrors, manufacture of, 120

Moorsom, Admiral, death of, 141
Mulley's auxiliary rudder, 96
Museum of Irish Industry, 266
Musketry, annual report of, 289

N.

Naval engineers, appointments of, 193, 215, 239, 263, 287

NAVY:

American, 42
Austrian, 96
British, 19, 42, 70, 71, 96, 120, 143, 167, 192, 215, 239, 263, 287
French, 19, 42, 70, 95, 168
Prussian, 287
Russian, 19, 168
Sardinian, 42
Spanish, 20, 42, 96

New metallic alloy, 170
New surveying chain, 71
New exchange for Liverpool, 143
New motive power, 41
Nickel, properties of, 74
Notes on the construction of engines and machinery, by L. O., 131, 175, 199
Notices to correspondents, 18, 40, 69, 94, 118, 142, 165, 191, 213, 238, 260, 286
Notice to our readers, 17

O.

Oar, on the, 258
Oil wells of America, 41, 242

P.

Paper from wood, 262
PATENTS:
Applications for letters patent, 146, 170, 195, 219, 243, 267, 291
Applied for with complete specifications deposited, 24, 48, 76, 100, 124
Provisional protection obtained, 23, 47, 74, 99, 123
Patera's process for extracting silver from its ores, 13
Photographs of microscopic objects, 239
Pier at Bombay, 22
Pier at Bournemouth, 260
Pier at Southport, 110
Pillars, strength of iron, 253
Pipes or tubes, uniting, 167
Platinum coating for porcelain crucibles, 214
Pneumatic tube experiments, 262
Postal Service, 143
"Pouhatan," power required to overcome the resistance of the feed pumps of the, 138
Practical papers for practical men, 49, 78, 101, 125, 149, 173, 197, 270, 285
Prevention of over winding, 73

PROPELLORS:

Disc wheel, 19
Griffiths's, 5
Young's, patent, 120
Public libraries, 262
Purification of coal gas, 24
Pyronome, to supersede gunpowder for blasting, 143

Q.

Queens yacht, and the Holyhead mail packets, 207, 212

R.

RAILWAY ENGINEERING:

Accidents on railways, 18, 22, 41, 43, 70, 73, 98, 121, 144, 168, 193, 215, 241, 264, 288,
American, 19, 43, 97, 121
Ashton under Lyne and Guide Bridge junction railway, 72
Australian Railways, 72

RAILWAY ENGINEERING:

Breaks, Higgins improved, 12
Martins improved, 193
Caledonian railway, 72
Canadian railways, 19, 43, 120
Charing Cross railway, 72
Dividends of, 19, 241
Exeter and Exmouth, 97, 144
Floating railway across the Forth, 101
French, 72, 168
Fyen, railway through the island of, 43
Great Northern Railway, 97
Indian, 72, 97, 121, 144, 168, 193, 215, 264, 288
Junction of railway curves at transitions of curvature, 33
Lahore to Umritsir, 264
Lancashire and Yorkshire, 72
Liverpool and Garston, 97
London and Bristol, 288
Chatham and Dover, 288
and North Western, 72, 122
Luxembourg and Treves, 215
Lym and Hunstanton, 288
Metropolitan, 121, 286
Newcastle and Derwent, 168
New bills, 19, 43
Norwich and Spalding, 288
Perth and Inverness, 588
Prevention of accidents, 288
Prussian, 97
Railway bridges, 22, 77, 98
Railway capital, 215, 241
Railway curves, paper on, 87
Railways in progress, 19, 72
Railway signals, 241
Russian, 87, 193
Saxby's improved railway signals, 110
Seville and Cadiz, 193,
Sheffield and Chesterfield, 288
Shrewsbury and Welshpool, 67
Signals for railway carriages, 288
Smyrna and Aden, 121
Spanish, 193, 241
Stratford-on-Avon, 97
Street railways, 19, 43, 97, 120, 121
Tenbury and Shrewsbury, 215
Traffic on railways, 19, 241
Tunnel at Mont Cenis, 20, 214
West Riding and Grimsby, 288

Rankine, W. J. M., on the application of transversals to engineering field work, 37
Rankine, W. J. M., on the resistance of ships, 231
Rarefied air, E. Frankland on some phenomena attending combustion in, 188
Reaping and mowing machines, 167
Remarks on some researches of Dr. Joule, 103
Rennie's, G. B., patent floating poutoon or dock, 50
Report of the committee on steamship performance, 256

REVIEWS AND NOTICES OF BOOKS:

Bowditch, Rev. W. R., on coal gas, 91
Bourne, J., a treatise on the steam engine, 142
Boyd's railway bridge between France and England, 66
Burnell, G. R.—The Builder's and Contractor's Price Book for 1861, 65
Campin, F.—Diagrams to facilitate the calculation of Iron Bridges, 237
Campin, F.—The practice of hand turning in Wood, 166
Chalmers, J.—The Channel Railway for connecting England and France, 260
Dirks, H.—Perpetuum Mobile, or search for self-motive Power, 66
Engineer's Pocket Book for 1861, 66
Fairbairn, W.—Useful information for Engineer's 64
Fairbairn, W.—Treatise on Mills, 118
Ganot, Professor.—Elementary treatise on Physics, 260
Gesner, A.—A Practical Treatise on Coal, Petroleum, and other distilled oils, 65
Gill, J.—An Essay on the Thermo-Dynamics of Elastic Fluids, 66
Hughes, S.—Gas Legislation, 260
Hull, E.—The Coalfields of Great Britain, 90
Humber, W.—Treatise on Cast and Wrought iron Bridge Construction, 212

REVIEWS AND NOTICES OF BOOKS:

- King, W. H.—Lessons and practical notes on Steam 65, 118
 Lamborn, Dr. R. H.—A Rudimentary Treatise on the Metallurgy of Silver and Lead, 166
 Laxton's Price Book for 1861, 90
 Miller, T.—Catechism of the Marine Steam Engine, 90
 Moore, R.—A sectional view of the Lanarkshire Coal Measure, 65
 Murray, A.—The Theory and Practice of Ship Building, 142
 Nystrom, J. W.—Pocket-book of Mechanics, 142
 Oppermann, C. A.—Portefeuille Economique des Machines de L'Outillage, 142
 Plimsoll, T.—Our Black Diamonds, 260
 Russell, J. Scott.—The Fleet of the future, Iron or Wood, 65
 Shields, F. W.—The strains on structures of Iron, Work, 118
 The Electrician, 260, 286
 The Popular Science Review, 286
 Transactions of the Institution of Naval Architects 67
 Walker, W. M.—Notes on Screw Propulsion, 66
 Wordsworth, C.—Summary of the Laws of Patents, 90
 Young, C. F. T.—The Economy of Steam Power on common roads, 63
 Young, J. R.—A Course of Elementary Mathematics, 90
- Robertson, J.—On Frictional Gearing, 185
 Roscoe, H. E.—On Spectrum Observations, 187
 Royal Institute of British Architects, 280
 Royal Institution of Great Britain, 89, 186, 209
 Russell, J. S.—On the Wave-line principle of Shipbuilding, 163
 Russian military works, 19

S

- Sawing machine, new, 263
 Saxby's improved railway signals, 110
 Scale of terrestrial divergence for the long range, 284
 Scientific notes, 20, 73, 120, 122, 143, 194, 214, 217, 218, 242, 262, 287
 Shaw's improvements in gas meters, 222
 Shears for Sebastopol, 70
 Shells, liquid iron, 169
 Shields, F. W., on iron construction, 231
 Shipbuilding on the Clyde, 71, 283
 Shipbuilding, J. S. Russell on the wave line principle of, 163
 Shipbuilding and repairing, 70
 Shipbuilding on the Tyne, 71

SHIP LAUNCHES:

- Actif, 145
 Ajax, 73
 Amalia, 21, 97
 Battalion, 145
 Bristol, 73
 Chanticleer, 72
 China, 264
 City of New York, 121
 Hebe, 215
 Lady Nyassa, 145
 Lord of the Isles, 96
 New Brunswick, 264
 North Eastern, 215
 Olympus, 288
 Palakari, 21
 Polynia, 72
 Prince of Wales, 168
 Rapid, 21
 Resistance, 121
 Rio Jerome, 21
 Scotia, 190
 Speedwell, 73
 St. Andrew, 215
 Talca, 240
 Undaunted, 43
 Vasco Audaluz, 215
 Village Blacksmith, 168
 Volunteer, 145
 Warrior, 120

SHIPS (STEAM), DIMENSIONS OF:

- City of New York, 193

SHIPS (STEAM), DIMENSIONS OF:

- Daniel Drew, 61
 Fire Dart, 61
 Guayaquil, 29
 Hankow, 61
 Hansa, 215
 John P. Jackson, 62
 John P. King, 61
 New Brunswick, 61
 Primeira, 61
 Reliance, 62
 Resolute, 62
 Scotia, 190
 Semiuele, 61
 Zouave, 61

SHIPS, TRIALS OF:

- Barossa, 71
 Black Prince, 193, 287
 Briton, 263
 Chanticleer, 263
 Eugenie, 288
 Gibraltar, 120
 Howe, 20, 192
 Leander, 287
 Linnet, 42
 Lord of the Isles, 143
 Meeaué, 120
 Minos, 144
 Octavia, 284
 Pelican, 71
 Penelope, 19
 Philomel, 71
 Prince of Wales, 241
 Rangoon, 19
 Results of trials, in H.M.'s ships and vessels, 245
 Rinaldo, 168
 Rosario, 96, 287
 Scarus, 120
 Sentinel, 19
 Taganrog, 19
 Troop steamer for the Indus, 29
 Trusty, 192
 Undaunted, 239
 Wanderer, 71
 Warrior, 263, 284
 Western, 168

SHIPS, ACCIDENTS TO:

- Cleopatra, 22
 Collisions at sea, 22
 Fiel, 41
 Great Eastern, 222, 240
 H. R. W. Hill, 19
 Queen Victoria, 97
 Shannon, 22
 St. Louis, 42
 Tasmanian, 22

SHIPS, LOSSES OF:

- Alarm, 168
 Canadian, 168
 Empire, 22
- Shipping losses of the United Kingdom, 20, 70
 Ship Ventilating Committee, 239
 Ships, unsinkable iron, 193, 264
 Ship's pumps, trials of, 70
 Ships, resistance of, W. J. M. Rankine, on the, 231
 Signal lanterns for the Admiralty, 143
 Silver from its ores, Patera's process for extracting, 13
 Sir William Cubitt, death of, 260
 Smoke, apparatus for prevention of, 96
 Smelting iron ore, 21

SOCIETIES, PROCEEDINGS OF:

- British Association for the Advancement of Science, 223, 256, 277
 Civil and Mechanical Engineer's Society, 90, 164, 212, 258, 279
 Institution of Naval Architects, 84, 113, 163
 Institution of Civil Engineers, 13, 62, 110, 161, 189, 277
 Institution of Mechanical Engineers, 211
 Institution of Engineers in Scotland, 43, 87
 London Association of Foreman Engineers, 62, 211
 Manchester Literary and Philosophical Society, 162, 279
 Royal Institute of British Architects, 280

SOCIETIES, PROCEEDINGS OF:

- Royal Institution of Great Britain, 89, 186, 209
 Royal Society, 30
 Society of Engineers, 167
- South Foreland, lime light at the, 221, 247
 Spectrum observations, H. E. Roscoe on, 187
 Speed of armour-cased ships, C. Atherton on the, 28
 Stability, paper on, 81
 Steamboats in Russia, 42
 Steamship capability, 17, 40, 92, 237
 Steamship performance, report of the Committee on, 256
 Steamship performance, 116, 140, 165
 Steam shipping, duties on, 20
 Steamship paddle floats, 71
 Steam vessels at high velocities, R. Armstrong on the measure of the, 107
 Steam shipping notes, 71, 193, 215, 240, 264, 288
- STEAM;
- Clark, D. K., on, 55, 82, 104, 142
 Expansion of, 38, 53
 Generation of, by means of gas, 167
 Stimers, A. C., on the relative economy of using steam with different measures of expansion, 138, 154
 Surface condensation of, 33
 Tables of the properties of saturated, 203
- STEAM NAVIGATION COMPANIES:
- China and Japan Navigation Company, 143
 Company for the Navigation of the Yang-tse, 120
 East India and London Shipping Company, 19
 Great ship company, 144, 193
 Inter-colonial Royal mail steam packet Company, 143
 Peninsular and Oriental Steam ship Company, 19
 River Salado, 167
 Royal Mail steam packet Company, 19, 218, 264
 Steam Navigation Company new, 71
- Steel, conversion of cast iron into, 50, 83, 237
 —, from cast iron, manufacturing, 20
 —, manufacture of, 145, 170
 —, from New Zealand, 21
 Stone breaking machine, 70
 Stoney B. B. on the construction of floating beacons, 111
 Straw paper, new kind of, 41
 Street lighting, improvements in, 214
 Street railways, 19, 43, 97, 120
 Strength of materials, by C. H. Haswell, 7, 157, 183, 204, 248, 275
 Sulphide of potassium, 21
 Sun, structure of the luminous envelope of the, 162

T.

- Tables of the properties of saturated steam, 203
 Targets, Brown's, 241
 —, Fairbairn's and Robert's, 211
 —, Jones's, 216, 240

TELEGRAPH ENGINEERING:

- Atlantic telegraph, 97, 144
 Australian telegraphs, 265
 Bagdad to Teheran, 43
 Electric telegraph progress, 43
 France to Algeria, 121
 Holyhead to Howth, 19
 Indian telegraphs, 97, 217
 London and Paris, 72
 Loudon district, 72
 Malta and Alexandria, 72, 97, 121, 144, 169, 241, 265
 Malta and Corfu, 265
 Mediterranean telegraph extension company, 217
 Ocean telegraph, new scheme, 92
 Otranto and Sidari, 72
 Oxydation of telegraph wires, 265
 Private telegraphs, 43
 Red Sea Telegraph, 19, 72, 289
 Report of Committee on submarine cables, 169
 Russian telegraphic lines, 43, 144, 169, 241
 Submarine telegraphs, 43
 Telegraph improvements, 265
 Telegraph at Oldham, 43
 Toulon and Corsica, 169
 Telescope in New York, 119

Tempering steel, 122
Thames embankment, 143, 192
Thames Tunnel Company, 95
Thermometer, Casella's patent mercurial minimum, 259
Timber from New Zealand, 20
Tin streaming in Spain, 122
Tite, W., on current topics, 280
Trials made in H.M.'s Ships, results of, 245
Tunnel at Mont Cenis, 20, 214
Tunnel through the Alps, proposed, 120
Turner and Gibson's improved bridges, 77
Tyndall, J., on the action of gases on radiant heat, 186
——— on the physical basis of solar chemistry, 209

V

Valve, geometry of the slide, 16

Vapours, elastic force of, Regnault on the, 9
Viaduct over the Tay, 265

W

Walton, J. B., on the various methods of sinking iron cylinders for foundations, 279
Wandle, F. Braithwaite, on the rise and fall of the river, 62
War, armour-cased ships of, 5, 15, 20, 42, 84, 96, 120, 168, 192, 215, 239, 263, 287
Ward's signal lamps, 20
Warrior, correspondence on the performance of the, 285
——— trial of the, 263, 284
Water test apparatus, Danchell's, 185
——— as a fuel, 287
——— effect of pressure on, 287
——— notes on the freezing and thawing of, 162

WATER SUPPLY:

Lyme Regis Water Works, 98
Metropolitan, 98, 265
Nelson's water elevator, 95
New River Company, 217
Stockton and Darlington Company, 22
Whitehaven, 73
Weather prognostications, 262
Weir for canals and other similar works, 131
Westminster Bridge, 122, 197
Williams, C. W., on unsinkable iron ships, 163
Wood, J., death of, 40
Woolwich, arsenal at, 18, 20, 265
Wheel for lifting water, 211

Y.

Yacht, the Queen's, and the Holyhead mail packets, 207, 212
Yarrow, A. F., on the foundry, 90

LIST OF PLATES.

- | | |
|--|---|
| <p>184. Plans and Section of the Steamships "Guayaquil" and "San Carlos."
185. Railway Curves, by Professor W. J. M. Rankine.
186. Geometry of the Slide Valve.
187. Boilers of the Steamships "San Carlos" and "Guayaquil."
188. Iron Floating Dock, designed by Mr. G. B. Rennie, M.I.C.E.
189. Passenger Locomotive for the Edinburgh and Glasgow Railway.
190. Illustrations of Various Papers.
191. Illustrations of Various Papers.
192. Auxiliary Engine of the "Great Eastern" Steam-ship.
193. Weir for Canals and other similar works.
194. Determination of Distances on the Field.</p> | <p>195. Diagrams from Feed Pump of U.S. Steamer "Powhatan."
196. Clay's Breech-loading Cannon.
197. Determination of Distances on the Field.
198. Indicator Diagrams, by A. C. Stimers.
199. Goods Engine of the Great North of Scotland Railway.
200. Frictional Gearing.
201. Elevation, Plans, and Sections of Westminster Bridge.
202. Testing Girders for the Manchester Corporation.
203. Ratio of Breaking Weights—Weight and Span of Tubular Girder Bridges.
204. American Screw Pile Lighthouse.</p> |
|--|---|

TO THE BINDER.

Plate No. 201.—Elevation, Plans, and Sections of Westminster Bridge to face title-page.

The "Artizan" Patent Office

IS NOW REMOVED TO

19, SALISBURY STREET, STRAND, W.C.

OFFICE FOR
BRITISH AND FOREIGN
PATENTS



AND THE
REGISTRATION OF
DESIGNS.

All Business Relating to British or Foreign Letters Patent may be transacted at this Office.

PATENTS SOLICITED. PROVISIONAL PROTECTION OBTAINED. SEARCHES MADE FOR SPECIFICATIONS, AND ABSTRACTS OR COPIES SUPPLIED. SPECIFICATIONS DRAWN OR REVISED. MACHINERY DESIGNED AND DRAWINGS MADE BY COMPETENT DRAUGHTSMEN. PROLONGATIONS AND CONFIRMATIONS SOLICITED. DISCLAIMERS ENTERED. ADVICE ON THE PATENT LAWS. OPINIONS ON INFRINGEMENTS. THE NOVELTY OF PATENTS ASCERTAINED. ORNAMENTAL DESIGNS, DEVICES, AND PATTERNS, AND THE CONFIGURATION OF ARTICLES OF UTILITY, PROTECTED COMPLETELY OR PROVISIONALLY.

To ENGINEERS AND OTHERS.—This Office offers peculiar advantages to Mechanical Inventors desirous of securing their Inventions by Letters Patent, it being under the direction of an eminent Consulting Engineer, of great practical experience in scientific Patent matters. It possesses all the advantage of having the assistance of an eminent Practical Chemist; there is also a staff of experienced Mechanical Draughtsmen upon the premises.

Having a complete List of all the Patents granted from A.D. 1617 to the present date, as also every information upon the subject of Patents under the Act 15 & 16 Vict., c. 83, and the Registration of Designs, every assistance can be afforded to Inventors.

An extensive Library of Scientific Books may be consulted.

A Circular of Information, containing full particulars as to the cost, &c., of British and Foreign Patents, the Designs Act, &c., will be forwarded upon application.

The Charge of this Office for the Provisional Protection of an Invention (under the 15 & 17 Vict., c. 83), including Government Stamp, Agency, &c., is £10 10s.

Artizans having Inventions of merit will be treated liberally and advantageously as to payments

Address to the Proprietor---"THE ARTIZAN" Patent Office, 19, Salisbury Street, Strand, London.

Free by Post for Two Stamps,

HINTS TO INVENTORS
INTENDING TO OBTAIN LETTERS PATENT FOR THEIR INVENTIONS.

BY AN EMINENT PATENT-LAW BARRISTER.

ine

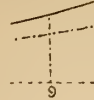

$w = 1$ Che
 ←-----



FIG 3.

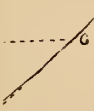

7.



PLANS AND SECTION OF THE PACIFIC STEAM NAVIGATION COMPY'S SCREW STEAM SHIP

50 GUAYAQUIL

FIG. 1. LONGITUDINAL SECTION

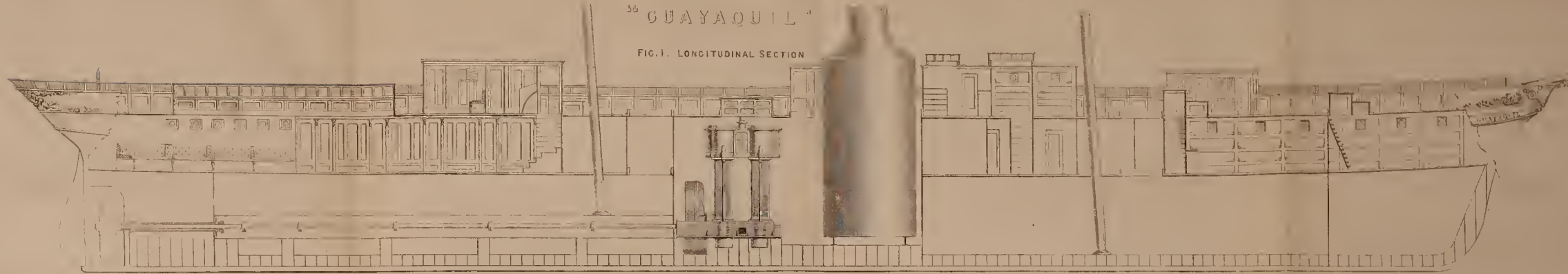
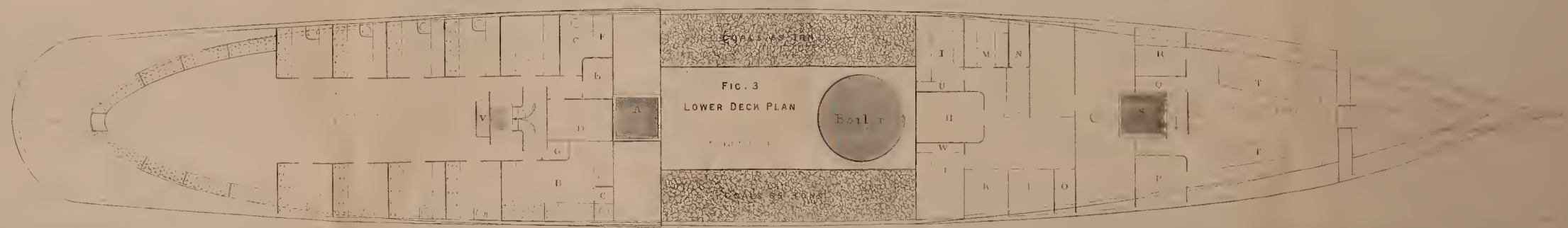

FIG. 2. UPPER DECK PLAN



FIG. 3. LOWER DECK PLAN



BE

MACE

Patent
the adv
premis

under t

upon a

Agency
Ar

A

RAILWAY CURVES.

By Prof. W. J. Macquorn Rankine

FIG 1.

Scale $\frac{1}{2}$ in = 1 Chain

a a' Circle of Curvature at 9. $R = 18.52$
 b b' 6 $R = 27.78$
 c c' 3 $R = 55.55$

FIG 2.

Scale $\frac{9}{10}$ in = 1 Chain

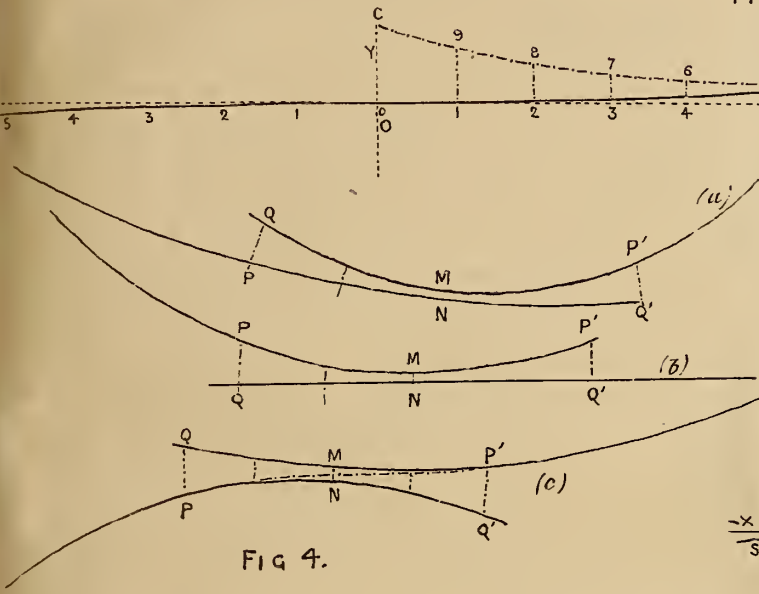
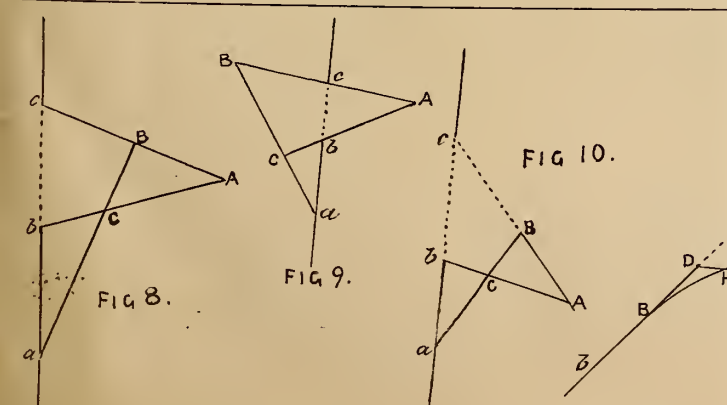
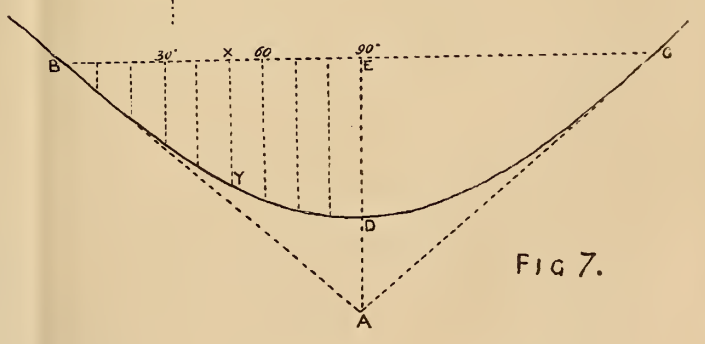
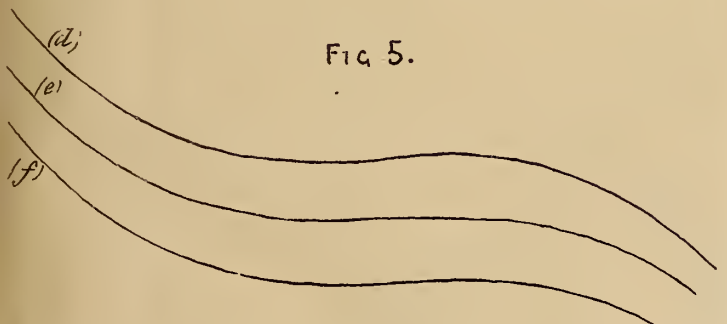
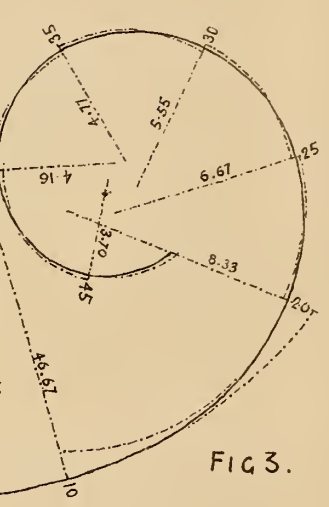
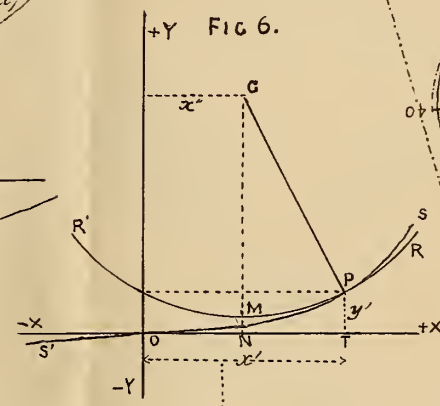

FIG 6.



APPLICATION OF TRANSVERSALS TO RAILWAY LINES.

By Mr Wm Froude.

FIG 10.

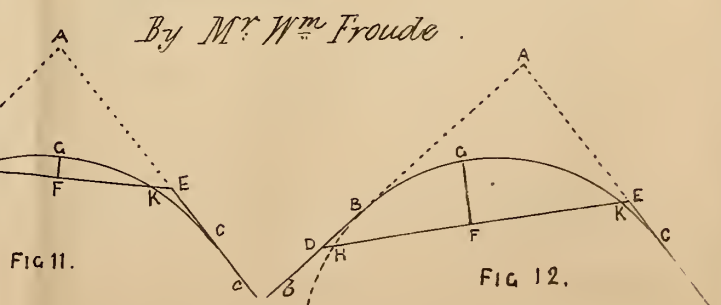

GEOMETRY OF THE SLIDE VALVE,

Stroke of Piston . 4. 6
 Connecting Rod . 7. 6
 Travel of Valve 0. 7
 Eccentric Rod 10. 9

Note.. The lines in Full, shew the Correct Diagram.

Front end \rightarrow

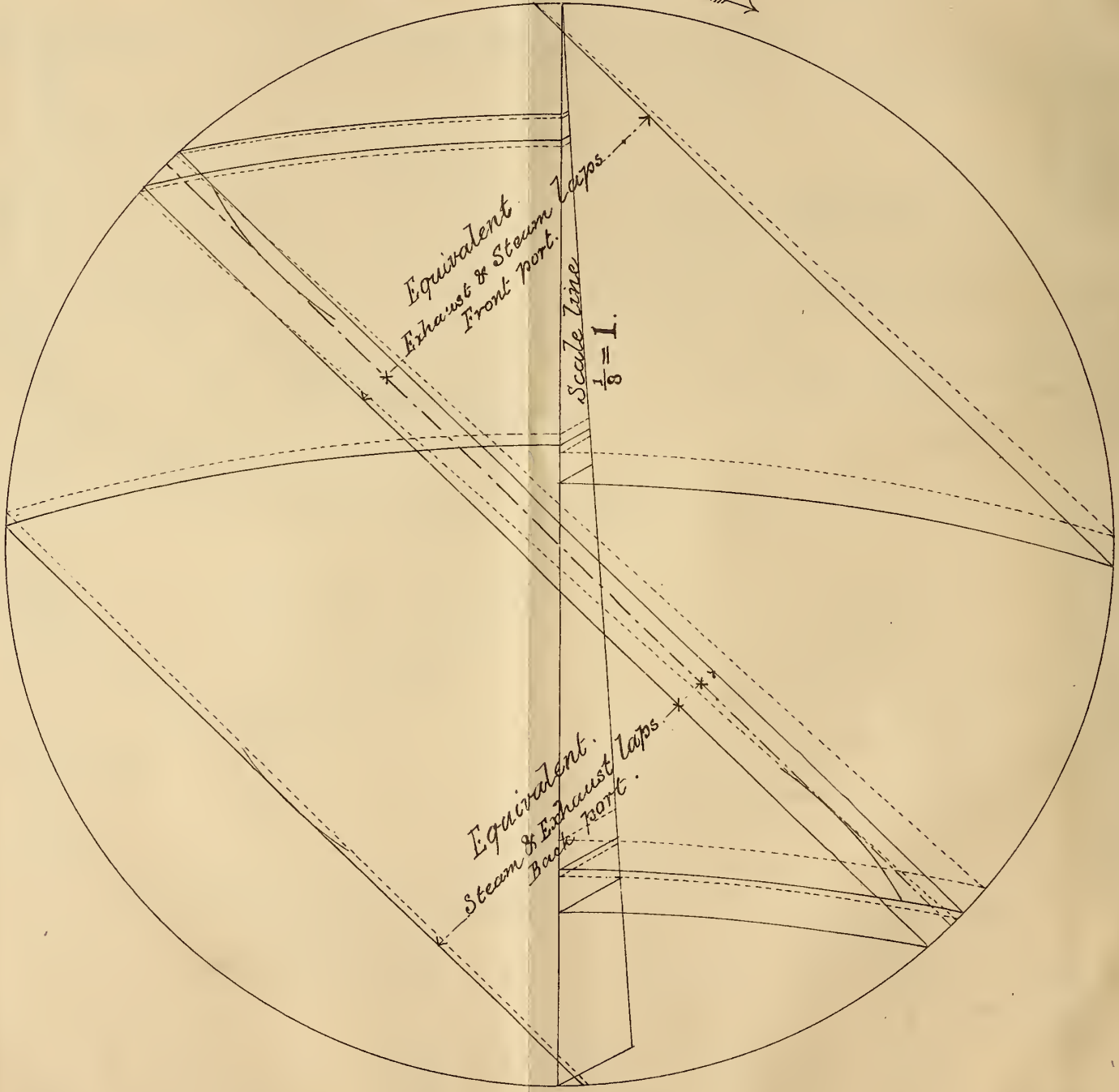

THE ARTIZAN.

No. 217.—VOL. 19.—JANUARY 1, 1861.

“ARTIZAN” ADDRESS, 1861.

WITH the advent of a new year comes a duty which for several years past has devolved upon us, and which we have endeavoured to perform to the best of our ability within the limited space which can be spared in any one number of our journal, and we shall not on this occasion depart from a practice which has given satisfaction to our friends, if we may fairly assume the reiterated expressions of satisfaction to be sincere. We will therefore at once to our task, and, in as small a space as is consistent with only a moderate glance at past and passing events, and a hasty sketch of things we deem interesting, we will sum up what we have to say.

During the year 1860, we are glad to find that the number of our friends and supporters has increased steadily; and it is satisfactory to find that, whilst we are thus progressing, our contemporaries, monthly and weekly, are also, we believe and hope, advancing in public favour; for it has been our study, knowing there is room enough for all, to welcome, and, as far as we have been permitted, to hold out the right hand of good fellowship to our younger brethren, “and to old friends with new faces;” although we are sorry to perceive that some of our brethren connected with those journals are dreadful sufferers from occasional but severe attacks of bile, which prevent them living in peace and harmony, and on terms of good fellowship with the rest of their fellows; but we are happy to say that, like Lord Derby’s “coal-heaver,” in his celebrated reply to the attack upon him by the Duke of Argyll,—*If it amuses them it does not hurt us*

Satisfactory as has been our progress or increase during the past year, we need scarcely remind our friends, that by affording us increased support, by every means in their power, they will thereby benefit themselves, by enabling us to extend the sphere of our usefulness, increase the quantity of information, and the number of the plates and illustrations during the year; and it is with no small amount of pleasure and pride that we are able to point to what we have already done, and to challenge comparison with any other scientific journal throughout the world for the amount of valuable information, and the number and expensive character of the illustrations; remembering that our sheets of engraved illustrations are not mere fancy sketches, illustrative of ingenious mouse-traps or circular portable steam-engines; nor mere puffing advertising pictures of every senseless stupid invention, advertised for business purposes, for the sake of gain. But, gently; we fear biliousness is contagious, and we are warned not to stray from our original purpose. We shall, therefore, simply thank our friends for the support they have hitherto afforded us, and ask them not only to continue, but to extend their support, and by their influence in every available channel, to induce their friends to become our friends and supporters; and thus a mutual column of support will be raised of permanent advantage to all.

What we have done for our subscribers during the past year may in part be briefly summed up as follows:—We have given them the most valuable and recent series of experiments on the strength of steel and wrought-iron, ever made; and these, together with the large sheet of illustrations accompanying them, will be found in the January number, in addition to the usual quantity of valuable information. We have given the

only published series of views of the new Westminster Bridge, and the various details connected with its construction, accompanied by textual descriptions of the whole of the works. The continuation of the valuable series of plates illustrative of the highly economical and much-approved engines, boilers, and machinery of the several ships fitted by the eminent firm of Randolph, Elder, & Co., of Glasgow, has been hailed with the greatest enthusiasm in all parts of the continents of Europe and America, as being a greater boon to steam-ship owners and others interested in economic ocean steam navigation; and we have reason to know that it has been highly instrumental in stimulating marine steam engineers to do better things than they had previously done, and perhaps to induce them, for the first time, to study the philosophical questions involved in the economic generation and use of steam as a motive power; whilst we hope it has also had the advantage of bringing before the public in a prominent manner, merit of the highest scientific order, in combination with practical engineering skill, and has shown that there is at least one firm on the Clyde, who do not make marine engines “by rule of thumb,” and as mere shapers of material. On the 16th of July we published a supplemental number, double our usual size, containing a vast amount of valuable tabulated matter, collected by the British Association Committee on Steamship performance; and we produced exclusively all the more important scientific papers read at the British Association, in the Mechanical Section, in the numbers of July 1st and 16th, and August 1st. In the November number we gave a large extra sheet, printed on both sides, containing tables arranged for laboratory reference, for which we have received very complimentary letters from many of our subscribers, particularly in the manufacturing districts. Besides these large sheets of engravings and valuable tabulated matter, we have had recourse to both sides of the sheets upon which our plate illustrations have been printed, so as to enable us to give the greatest number of figures or diagrams without trenching upon the letter-press portion of our journal. Amongst the series of papers given during the past year, those on the laws of steam and on the geometry of the slide valve, with the great circle diagrams and other illustrations, have been found of great practical value; and the series of papers on coinage, as “Golden Days at the Mint,” &c., have been of interest to a large number of our readers; the various other papers and articles contributed to the Journal, and the selected letters from correspondence, have, it is hoped, afforded that amount of useful information which we are at all times desirous of imparting in return for the support of our friends. The selection of “Notes and Novelties” might be made of still greater interest, if our friends would act upon the suggestion which they will find printed every month at the head of that division of our work; and we must here repeat how much obliged we shall be for whatever contributions they will forward to us of recent scientific events, and matters of interest which come under their own observation.

During the past year, railway works have been extending steadily throughout Great Britain and elsewhere, and a heavier or stronger description of road has been found necessary on most of the trunk lines

to withstand the increase of weight of engines and higher speed of travelling. Coal is rapidly displacing coke as fuel for locomotive engines, and it is being economically and successfully substituted; and, on some lines it is consumed without producing smoke—the engine illustrated in the April number, fitted with D. K. Clark's patent apparatus, is one of the best examples. Giffard's injector has been extensively applied, and, as an addition to existing feed-pumps, we think it may be usefully employed for feeding locomotive engines with water of moderate temperature and good quality. A more perfect system of breaks than those generally in use is still much required, and means should be provided for discharging the sand from the sand-box in front of the driving wheels by means of a handle worked from the foot-plate, and larger sand-boxes should be provided, and kept constantly filled. We recently witnessed a case in which several thousand pounds would have been saved to a railway company had these precautions been taken. Ramsbottom's ingenious contrivance for supplying tenders with water whilst in motion deserves special mention.

The local requirements for working the Metropolitan Underground Railway, necessitate, it is said, an arrangement of engine, or other means of giving motion to the trains, by which the emission of coal smoke or vapour from a coke fire is to be avoided; and although this will not, if attained, dispose of the exhaust steam emitted from the blast pipe, an English engineer—Mr. Gregory, of Barreira, near Lisbon—made some successful experiments for the same object about twelve months ago, when he ran an engine and train some 10 kilometres without fuel, after having heated a fire-brick cone, and lining within the furnace, to a red heat, and raised the steam in the boiler to a pressure of 100lbs. on the square inch.

In working railway traffic, the London and North-Western Company have introduced in some of their tunnels a second pair of rails upon the same sleepers, and a few inches only apart, so as to reduce the greatly increased wear and tear which would otherwise arise from the concentration of the traffic from off two or three lines of rails upon one line only, and also to save the necessity for, and risk from working facing points, as the traffic thus worked is enabled self-actingly to run in and out. The numerous accidents which have occurred upon the principal lines in the kingdom point to the greatly increased traffic and crowded state of those lines converging to London; but they also strongly direct attention to the absolute necessity for a more vigilant system of supervision, and regulation of the traffic between stations, and the employment of the independent electric signals or telegraph instruments, by which the state of the line between one station and another may with certainty, at any time, be known; and such instruments as those which have been specially designed by Mr. Geo. Sandys, the electric engineer, for the purpose of meeting these requirements, deserve to be immediately pressed upon the attention of railway companies. It has frequently occurred to us that every train despatched from a terminal station might be made to automatically record its progress towards its destination, and exhibit its exact position at any moment upon a board in the office of the superintendent at each end of a line of rails, by means of a very simple arrangement of electric apparatus. Too great a reliance upon the constant burning of oil lamps in distant or auxiliary signals has been a source of great mischief and loss; and where gas cannot be used for such signals, proper means should be taken for preventing the possibility of the light being extinguished by accident, and without the knowledge of the signal-man. The importance of enabling the guard or official in charge of the train to gain ready access to any carriage, is now becoming better understood, and we hope, in the course of time, to see such modifications in the external construction and arrangement of the carriages, and in their mode of connection, as will facilitate communication

between one part and another. One great source of accidents, to which the metropolitan lines more especially have been subjected, and to which all lines of railway crossing each other are subject, at their junctions or intersections, will, we believe, in future be rendered impossible by the adoption of a very ingenious, yet simple and very inexpensive arrangement for working points and signals, invented by Mr. Saxby, of Brighton, and introduced at the New Victoria Station of the Brighton Railway Company.

The Parliamentary Session of 1861 promises to be pretty fully occupied with railway matters, if we may judge from the large crop of railway bills deposited; and London seems to be specially favoured, and the region of Finsbury, about the most favourite spot in the metropolis, to which the attention of railway engineers, surveyors, lawyers, and Parliamentary agents seem to have been devoted; and whilst the Metropolitan Railway and other junction lines are projected, central stations are each being advanced for public support. The connecting chain, by which the lines on the north and south sides of the River Thames in the regions east of Blackfriars-bridge is much required, and should not be neglected, whether or not the Thames Tunnel be at last made of some practical use by being made available for this purpose; and as the Great Western and the other broad gauge lines in connection with it are, we believe, now inevitably settled to be relaid as narrow gauge lines, and so brought into the general railway system of Great Britain, we shall then hope to see the value of Great Western property materially improved.

In Portugal, the 4ft. 8½in. gauge is, it is said, to be altered to the 5ft. 6in. Spanish gauge; it is supposed, as a preliminary step to other changes in that country.

The railway system is extending rapidly over most parts of the earth's surface; and a reference to our monthly notes, &c., will show how rapidly and how generally the railway system is extending. The completion of the Great Victoria Bridge in Canada, across the River St. Lawrence, has been one of the most important events of the year.

In marine steam engineering, our pages have recorded all that is worthy of note, and we refer to the various papers, notices, and illustrations to be found in THE ARTIZAN during the last twelvemonths for the only true and thoroughly reliable epitome of progress in this important branch of engineering; but we cannot dismiss this portion of our task without directing especial attention to the very useful labours of the Committee on Steamship Performance, reappointed by the British Association at the meeting held at Oxford in June last, and to express the opinion, that if the objects which the Committee have in view were better understood by steamship owners as well as the builders of ships and engines, the store of thoroughly reliable and useful facts which the Committee would be able to accumulate and publish would be of the greatest possible advantage to the cause of progress in this branch of practical science. Surface condensation is, as we long ago and almost singly predicted, becoming extensively introduced into our mercantile marine; but the Admiralty, who are always slow to move, and difficult to be made to understand anything out of the most common way, have not yet thought it worth while to "run the risk of failure;" for although surface condensers might answer very well in a commercial ship, it is no reason why they should answer or be conducive to economy on board H.M.'s ships, very much for the same reason that Silver's Marine Engine Governors were objected to at the Admiralty as "things unnecessary." Dr. Joule, of Manchester, has done good service by experimentally investigating the question of surface condensation, although we should have preferred that his experiments should be conducted on a much larger scale. Early in the year we look forward to some interesting results to be derived from the introduction of

a radical change in the form and arrangement of steam machinery on board of three of H.M.'s ships, of about the same size, by which two of the old marine engineering firms of the Thames are to compete with a more modern engineering firm of the Clyde. Changes, too, are likely to be made in the Administrative and Executive Departments of the Admiralty, especially in the Steam Department, where quaint and obsolete views obtain about important practical questions, and scientific subjects, which, within the region of Spring Gardens, it has been supposed unnecessary to embarrass themselves with the state of modern knowledge; and, perhaps, the day is not far distant when the department charged with the construction and equipment of steam ships of war—more especially—will be presided over by men of advanced intelligence in their respective spheres of action.

Griffiths's recent improvements in the screw propeller, to which we have referred elsewhere in the present number, promise to be the means of extending the use of that instrument for vessels of shallow draft.

In naval architecture it is to be hoped great progress will be made, since the establishment of an important association—the Institution of Naval Architects—which we were right glad to see inaugurate the commencement of its career with so excellent a display of good names and excellent papers.

Iron, as a material for building ships of war, has once more been permitted by the naval authorities, and the *Warrior*, iron-cased frigate, and the sister ships are in rapid progress towards completion; and possibly before this number of THE ARTIZAN meets the eye of our country subscribers, H.M. ship the *Warrior* will have been launched from the building-yard of the Thames Iron Company, at Blackwall. As it is generally known, she is an iron frigate of large size, intended to be cased with thick plates of iron upon her wall like sides. The Imperial French frigate *La Gloire*, about which so much has been written, is a wooden hull, iron-plated or cased, and with vertical sides also. Recent experiments, made with great care, and on a suitably large scale, have shown the superiority of placing iron plates in the position of angular or inclined sides instead of vertically, as they are usually designed to be in H.M.'s ships; but elsewhere we have referred to this subject. One thing which struck us forcibly when examining the designs of the *Warrior* class of ships was the unmechanical and uneconomical disposition of the material to attain the greatest amount of strength and permanent character of structure, with the least weight of material. For the shell, or covering plates of ships, steel plates do not appear to have been successful; whilst for steam boilers, where they have been substituted for Bowling plates, they have utterly failed. The punching of plates and angle-irons, and such-like articles for ship-building purposes, is likely in future to be performed in a very superior manner, and at considerably less cost by means of very ingenious machinery, invented by Mr. Richard Roberts, of Manchester, whose world-wide celebrity as a mechanic, is a guarantee for the thoroughly practical character of his inventions.

In steam navigation, the establishment of new ocean lines, and the improvement of existing lines, by the introduction of larger, more powerful, and more economical steam-ships, will give an impetus to the commerce of nations, and keep employed the shipbuilders and engineers for some time to come; and although our old friend, the *Great Eastern*, is for the present "laid up in ordinary," we entertain the hope that early in the coming spring proper opportunities will be afforded for testing her capabilities thoroughly. The establishment of a new line of screw steamers, with auxiliary power only, between this country and India and China, *via* the Cape, is, we believe, a thing done; and as the present costly route is only available for first-class passengers, the bulk of the passenger traffic and cargo, carrying trade, seems pretty certain to be destined for the auxiliary screw steamers. The accounts received of the continued pros-

perity attendant on the introduction of steamers on the rivers of India, and the great commercial success achieved, leads us to believe in the rapid extension of steam navigation on the inland waters of India and China.

The extension of dock accommodation, and improvement of harbours in this country and abroad, is, like the introduction of railways, though somewhat slower, advancing to meet the necessities of extended trade; and engineers have still a wide field of enterprise before them in this branch of the profession. We are glad to see that Mr. Thos. Page, C.E., has identified himself with the increase of dock accommodation, in that finest of English harbours—Milford Haven. Mr. G. B. Rennie has admirably contrived a novel arrangement for docking ships in places where there is no rise and fall of tide, and where a shallow shelving beach or roadstead prevents the formation of permanent docks in masonry available in all states of the tide; part of the arrangement is applicable in connection with any of the existing descriptions of docks.

Submarine telegraphy has been associated with want of success to which, too commonly, great operations dependent on scientific knowledge, are liable when undertaken by those who are mere tradesmen. Nearly every cable made by, and laid under the direction of Messrs. Newall & Co. has continued to work satisfactorily, whilst a dozen competitors have started up who were only capable of performing satisfactorily the twisting of wire into toasting-forks. The scientific investigation, by Government officials, of the various kinds or forms of cables for submarine telegraph purposes, ought to have been productive, ere this, of correct knowledge connected with this important subject; and if we are to judge exclusively from reports, the use of gutta-percha as an insulator, and of exterior protective coatings of iron wires, will cease to be the favourite forms of telegraph cables; and light materials, and non-metallic external coatings, are likely in future to be preferred. The North Atlantic route of communication between England and America has been surveyed, and favourably reported upon by eminent navigators and other scientific men; and we sincerely hope, for the interests of commerce, and to remove the reproach from practical science at the present day caused by the failure of the Atlantic Telegraph Cable, that some practical route will be speedily opened for conveying intelligence between this country and our Anglo-Saxon Transatlantic brethren. It is curious to note that the Submarine Telegraph Company are daily in the habit of communicating between London and Berlin, through the entire length of the Dutch cable, quickly and regularly, with a surprisingly small amount of battery-power. What would have been the value, during the late Chinese war, of direct communication between this country and India and China? It behoves the public to press upon the Government the absolute necessity of expediting that important and desirable work, ere another difficulty may arise in our Eastern possessions.

Military engineering, ordnance, and other matters of a kindred nature, have received a larger share of public attention during the last year than perhaps during any previous period in the history of this country. Fortifications and works of defence are most properly being planned and executed in many parts of these islands, particularly the neighbourhood of the naval arsenals and harbours around the coast. The Armstrong rifled ordnance has at last been put to practical test of actual warfare, and with what success the able letters of the late lamented correspondent of *The Times* has made the public familiar; and with the experience gained by the practice of making them, and in their daily use, there is no doubt that the manufacture of the Armstrong gun, under the great practical skill of so eminent a mechanic as Mr. John Anderson, of Woolwich Arsenal, will be thoroughly perfected and made to meet the requirements of every unprejudiced artillery officer; and with the extensive means which have been placed at his command by the erection of the magnificent works at Woolwich Arsenal—the exact method of construction once settled—our means of producing rifled ordnance will exceed the united capabilities of the whole of the governments of the civilised world. The Whitworth cannon, which have been tried with so much success at long ranges, will also, no doubt, be improved so as to meet the objections of practical

artillerists; and now that the making of ordnance and projectiles for long ranges, and as instruments of precision, has engaged the attention and practical skill of the mechanical engineers of this country, the achievement of perfect success is only a work of time; and every modification or new form, or new mode of constructing either cannon or projectiles, is a stimulant to rival inventors, and promotes useful competition. The very ingenious and accurate sights for ordnance, introduced by Sir William Armstrong, have much to do with the precision of firing which has been obtained. In mortars, a very great improvement has been effected by a very simple but ingenious means—the invention of M. Krutzsch, a talented German mechanic: the flight of shells projected from mortars may be vastly increased with only the ordinary charge of powder, and by means of this invention, the mortar is made to keep pace with its new military companion—the rifled cannon. In small arms, but few improvements have been effected within the last twelve months, and the War Department still persist in ignoring the advantages to be obtained from the use of breech-loading fire-arms. The vast extension of the Volunteer movement in so brief a period has surprised foreigners more than any other event connected with this country, and the rapid attainment of an accurate knowledge of target practice has been rendered much more easy by a very ingenious contrivance,—the electric target, by which the necessity for a marker, mantlets, &c., is superseded, and the record of the firing is instantaneously effected.

Street railways, and steam on common roads, during the past year obtained for themselves an amount of public attention which had never previously been devoted to them. An enterprising American gentleman, Mr. G. F. Train, possessed himself of the notion, that as the citizens of several of the American States had street railways, and the English people not having them, and therefore not knowing the comfort and other advantages which their existence would afford, undertook to agitate the matter, and insisted upon our having street railways; and the Commissioners of Birkenhead, in Cheshire, were induced to allow Mr. Train to inaugurate his system of street railway communication; and it seems very probable that Mr. Train's talent and persistence will be rewarded with success. Mr. Thomas Wright, Mr. W. B. Adams, and others, years ago attempted to occupy the same field; but lacking those qualities which are likely to carry Mr. Train through many a difficulty, they did not succeed in inducing the public and others interested to follow them. The Marquis of Stafford and the Earl of Caithness have successfully worked steam pleasure carriages on common roads, and through streets, without railways; and the latter nobleman, and the charming Countess, his wife, recently performed several days' journey uninterruptedly along the steep and hilly roads of the Scottish highlands. Mr. J. Taylor, of Birkenhead, has also been most successful in constructing admirable and most powerful steam engines for common roads, to draw, at moderate speeds, a train of several heavily-loaded trucks—each engine he has made being an improvement on the preceding one.

In agricultural machinery, and the application of steam power and machinery to agriculture, there seems to have been a lull during the past year, although the quality of the steam engines and machinery manufactured for these purposes has undergone considerable improvement, and we find the *Boydell* description of portable steam engine—which is better suited for agricultural purposes than for common roads—is being but slowly introduced, owing, as we believe, to its being manufactured in an unmechanical and imperfect manner. Steam ploughing and cultivating is being gradually extended, and we are glad to see that Mr. Romaine is still devoting himself to the subject. Circular rotating harrows are being successfully used and gradually substituted for the ordinary kinds of harrows hitherto employed; and generally, scientific agriculture and the substitution of steam power and mechanical contrivances for hand labour, and the ordinary means in use, is being received with greater favour by even the less enlightened amongst the agriculturists of this country. The introduction of bituminized paper pipes will beneficially affect the extension of systematic drainage and irrigation, and the distribution of sewage and liquid manures: their lightness, and their ability to withstand

careless removal and rough usage, fit them for many purposes for which neither cast-iron nor earthenware pipes could be advantageously employed.

The purification of coal gas has been further materially improved by a very simple, and, it is said, very successful process, discovered by the Rev. Henry Bowditch, and by which the chief objection to the use of gas for lighting and heating in private houses, and generally in close apartments, is obviated—the gas being entirely freed from the sulphurous acid vapours so prejudicial to health when inhaled, and so destructive to interior decorations. In London, the utmost dissatisfaction is being expressed by consumers of gas at the generally unsatisfactory manner in which the Metropolitan Gas Companies are manufacturing and supplying gas; for not alone is the illuminating power generally inferior, and the prices charged too high, but in consequence of the private compacts, and the territorial arrangements entered into between the various Metropolitan Gas Companies, it is a universal complaint that they have become more arrogant and exacting, and less scrupulous than formerly,—not that London Gas Companies were ever celebrated for either their honesty or their liberality to their consumers,—and we hear that it is in contemplation in several districts to introduce numerous private gas works to supply a number of consumers, combined together for that purpose.

Amongst the several staple manufacturers and industrial operations of this country, the metal trades continue to increase in extent and importance; and as the manufacture of steel by the Bessemer process has come into extensive operation in this country and abroad, the gradual cheapening of steel, with equal excellence of quality, must be the means of substituting it most beneficially where previously it could not be afforded. The improved processes which have been introduced since the reading of Mr. C. Binks's paper upon the manufacture of steel, at the Society of Arts, has led to the manufacture being undertaken by numerous parties, under various designations, as "cyanogen steel," &c.; but there is little doubt that Binks was the first who experimented and wrote upon the subject, and understood correctly the true chemical nature of the process. In some recent investigations into the respective merits of different makes of Yorkshire and Northern and Midland Counties iron, used in the construction of steam-boilers, Bowling iron seems to possess superior structural character, and uniformity of quality and strength, which are very important considerations, especially for those portions of steam-boilers subjected to intense or long-continued action of fire.

The rapid extension of trade and commerce between Great Britain and all parts of the world will certainly be materially augmented by the opening of Japan, and the opening up of commercial intercourse with the Chinese throughout the length and breadth of that vast empire,—which will, it is certain, afford enormous outlets for our manufactures, and new fields of enterprise for the professional engineer, as well as for the artizan, whose habit it now is, to follow up the military successes of our arms, however remote the corner of the world in which such successes are achieved; and we hope ere long to hear of the introduction into China of steam engines and machinery of British manufacture for the service of his Imperial Majesty; and that whether Mr. G. F. Train, with his street railways and cars, be the pioneer, or they jump at once to the more permanent kind of work, the Chinese will allow us [to civilise them with our railways, locomotive engines, and railway carriages, and our electric telegraphs on land, and steamers, for their inland navigation and for coasting; and that we give them the benefit, by a rope's end, of direct submarine telegraphic communication.

With the gradual removal of onerous Excise duties at home, and Customs duties on our manufactures abroad, and the extinction of those restrictions upon manufacturing processes which impede their healthy development and extension, and with the establishment of better commercial, and more friendly political relations between ourselves and our continental neighbours, and other sections of the human family, and with a continuation of the blessings of peace, and the enjoyment of plentiful harvests, and ample employment for the industrious, we look forward, under the Divine Providence of the Great Architect of the Universe, to times of plenty peace, and contentment in 1861.

SCREW PROPELLERS.

AMONGST those to whom credit is due for the introduction and improvement of the screw propeller, Mr. Robert Griffiths deserves the foremost place; for, as a practical experimentalist, he has laboured hard for the improvement of this description of propelling instrument, and his labours have been eminently productive of advantage to ocean steam navigation, and we believe in some degree pecuniarily profitable to himself. Be this latter point, however, as it may, we cannot but observe that the Admiralty have exhibited so much confidence in the soundness of his views respecting the forms and mode of applying screw propellers for ships of war, that they have on many occasions granted him, most readily, permission to make experiments, and have placed at his disposal ships, men, and materials, to enable him to prosecute experiments on that large scale which alone is of practical value, and each occasion has given rise to modifications which, when applied in practice, have been of advantage to the service, and have aided the advancement of scientific knowledge in connection with the application of the screw propeller generally, and thus been of great public good.

Very recently an exceedingly interesting series of experiments have been made on H.M.S. *Cygnet*, of 80-horse power. They were made at Portsmouth during the last month, under the superintendence of Mr. Lynn, of the Steam Department, and Mr. Eames, Inspector of Machinery Afloat.

These experiments were undertaken with the view to ascertain whether the screw propeller could not be reduced in diameter by the application of a recent improvement patented by Mr. Griffiths, without reducing its propelling effect.

It has been a serious objection to the application of the screw propeller, to vessels of shallow draught, that the top edge of the propeller was of but little value from being so near the surface, or not submerged; and in every case it is of consequence to have a propeller of the smallest diameter, capable of giving out usefully the power of the engine. This has been more apparent since the almost universal introduction of direct-acting engines for driving the screw, and with the increase of power put into ships of light draught, engineers are now well aware that if they are obliged to increase the pitch of the screw beyond about $1\frac{1}{2}$ times its diameter, the power is not usefully exerted, and want of economy is the result.

A screw propeller, which when working at its most useful speed, has a velocity of, say about 3000ft. per minute at its periphery, and the velocity taken at the middle of the blades, as one half of that number of feet. At the periphery, the blades strike the water at an angle of about $22\frac{1}{2}^\circ$, and at the middle about 45° ; and it appears the greater the velocity, and the less the angle at which the water is struck, the quicker it recedes from the surface of the blade by which it is struck, and consequently any amount of surface at that part of the blade where the water recedes from it becomes of no value for propelling effect; neither does an increase of the number of blades give any useful effect, for when the water is struck, and set in motion, the next blade following in the same course or thread, as it were, finds more or less of a void, or nothing to strike against; hence the explanation: that blades made narrow at their extremities, and wide at their roots or nearest to the boss, resist the engine power, and propel the vessel much as when made three or four times as wide at the extremities, and that screws with two blades thus formed have the same hold on the water as those made with three or four blades of the ordinary form.

The alteration made in the screw of the *Cygnet*, which after due trial has been found so successful, is an additional piece on the after edge of each blade; it is an angular surface set throughout its whole length at the same, or nearly the same angle to the propeller shaft as that of the widest part of the blade near to the boss; this angular surface, added to the after edge of the blade, commences at or springs from the widest part near the boss, and gradually increases in width as it extends outward to the periphery of each blade, where it stands at an inclination to the after

face of the propeller blades, and as the propeller blades rotate, the water, which has been acted upon by each blade, is again struck or acted upon a second time by the angular piece.

We can only, for the present, give the results of one or two trials; but these will enable our readers to judge of the advantages obtained through the introduction of Mr. Griffiths's last improvement. With a screw 9ft. in diameter and 13ft. 6in. pitch, a speed of 10·7 knots was obtained. When the screw was removed, cut down to 7ft. 6in. diameter, and the pitch reduced to 12ft., and the addition made to the after edge of 9in. wide at the point, tapering down to nothing at the boss, an average speed of 10·8 knots was obtained, the power exerted in each case being the same. The blades were then reduced to 7ft. diameter, the pitch being 12ft., and the width of the pieces on the after edges was increased to 10½in. at the point, the speed then obtained was 10·5 knots; but there is little doubt had the screw been made of the right shape and the proper proportions for a 7ft. diameter, the detrimental effect of the stern-post, which was 12in. wide, would have left the result equal to the 9ft. diameter screw.

The propelling area of the 9-ft. screw, after deducting the centre sphere or boss, was say $9 \times 9 = 81 - 8 = 73$ feet; whilst the propelling area of the 7ft. screw, making the same reduction for the boss, was only 41ft.

We hope soon to be able to place before our readers the details connected with this interesting series of experiments.

ARMOUR-CASED SHIPS.

WE regret to find that the article on this subject, contained in our last number, has been the cause of a most unprovoked, ungentlemanlike, and scurrilous attack upon us, by a weekly periodical called *The Engineer*, which, in its impression of the 7th ult., devotes a leading article to our annihilation.

This paper, we may inform our readers, is a weekly publication, professing to be an authority on engineering and scientific matters generally; but is, unfortunately for its pretensions, "edited" by a person who is *not an engineer at all!* and is also assisted by a person who is said to be one of the editors of another rival weekly scientific journal. An old proverb says, "Too many cooks spoil the broth;" and we think this is well proved in their paper of the 14th ult., where we find the textual description of one engine appended to an engraving illustrating another; in fact, such is the lack of capability for original writing, that in several instances the same leaders and matter have been given twice over; and entire articles are copied "bodily" from other papers—in fact, being "got up on the cheap!"

This paper might have occupied a respectable position amongst scientific and practical men could it have been kept from degenerating into a mere advertising sheet; and it can only be considered as an advertising medium, and a vehicle for puffing the wares of those who advertise in it. To prove the truth of these remarks, we would refer our readers to the impression of the 14th ult., where, in an extremely able report of the Smithfield Club Cattle Show, he will find ample ground for the truth of these remarks.

For a sample of the amount of scientific and practical knowledge possessed by the "editor," the reader will find amongst the useful information for practical men that, whilst at the Smithfield Club Cattle Show, this "editor," or his assistant, becomes captivated with what—why, a mouse-trap! and forthwith devotes a considerable portion of a column to its description! Surely so important a subject deserved a block Shade of Peter Pindar, this is "Solomon and the Mouse-trap" with a vengeance!

The next discovery he makes is a "CIRCULAR Portable High Pressure Steam Engine!" but what this is we must leave our readers to discover, as we must bow to such high scientific attainments as are exhibited throughout that article, and the paper generally.

We must now make a few remarks on the matter which gave rise to this outburst from our talented contemporary and, having blown off some

of the "froth" of this polite and gentlemanlike effusion, see what he really is writing about. We find that our having urged "the adoption of the best plan, whether the sides be vertical or inclined," is where the shoe pinches; and our not having "told us which is the best plan" makes our suggestion "a little imperfect." Now, we beg to say that we did not, as our contemporary has done, write down, or at least attempt so to do, any particular plan; but we do say that, as far as we can judge, the inclined side is a much better form for resisting the impact of shot fired from low elevations, than a vertical one.

If our talented contemporary will recollect the hurry and push on the part of the Government to get in the tenders from several builders by a certain hour on a given day, to construct a certain number of these *Warriors* on a similar plan, and the sudden manner in which it was decided not to construct them with vertical sides, we think he will find that there still exists some doubt in the minds of the "powers that be" in regard to the "vertical side" being "undoubtedly to be preferred;" and we have yet to learn that "the inclined side has but an equal resisting power with a vertical"—which is so dogmatically asserted by our contemporary. We remarked that, if a shot-proof vessel can be constructed with vertical sides, we do not see any advantage to be gained by the adoption of angulated sides; and we may remark that, if the "sapient man of science" had less "dullness," or "something worse," he could not fail to see in the indecision of the Government every proof that they were in doubt on the matter, and that we were perfectly right in hoping that the *best* plan might be adopted; especially, as we find in most Government matters, that this is not always the case.

We can quite understand, for example, a Dockyard apprentice objecting *in toto* to Iron as a material for constructing ships—especially ships of war; for, as Wood is at their head, so is it the limit of their "ken" for such purposes; indeed, everything with them, or about them, or belonging to them, is "wooden;" but to expect that "inclined sides" would "square" with the notions of one educated at a Dockyard School of Naval Architecture is too unreasonable; and we cannot but feel surprised, now that we have time for a calm and deliberate reconsideration of the matter, that we should have even hinted at the possibility of any other arrangement of materials being better capable of resisting shot, than vertical iron sides for ships of war.

Apologising to our talented friend for presuming to "undertake to correct" so important and unerring a periodical as the *ENGINEER*, we would just call his attention to the fact, that the correct orthography of the great French Naval Architect is *not* De Lolme, but De Lôme; and we must again, in conclusion, reiterate our hope as to "the adoption of the best plan," and finish by assuring the "silly scribblers" who "have striven hard to gain our notice, and to have been not very choice in their means of securing it," that we cannot bestow further attention upon their "puny efforts."

We may, however, refer to a letter published elsewhere, which was originally addressed to the editor of *The Engineer*, but which has not been published in that journal. In the letter referred to, the writer takes nearly a similar view to ourselves in respect to angulated sides; and although there appear to be several "Richmonds in the field," each the "Simon Pure" from whom the original idea emanated, we care not whose plan be followed, so as we secure the "adoption of the *best plan*," and "whether the sides be vertical or inclined."

THE NEW MAIL STEAM-PACKETS FOR THE HOLYHEAD AND KINGSTOWN SERVICE.

We have awaited patiently the official announcements respecting the actual performances of the four new ships during their experimental trips, and also whilst in actual performance of their daily work at sea; but, unfortunately, there has been much more mystery and desire for concealment than is usual even in Admiralty trials. Why, ere this, the public should not have been furnished with accurately recorded details respecting the performance of their machinery, the actual power developed

to propel each ship at accurately noted speeds, and the quantity of fuel consumed in each case in giving out the requisite power, is a matter of surprise to all interested in steam-ship economy.

No scheme could have been better devised for testing the comparative merits of the machinery supplied to each ship, as also the qualities due to the forms given to the vessels by their respective builders, than that which the distribution of the orders for the building of the ships, and for their steam machinery, have put it in the power of the owners of these vessels to arrive at with accuracy; and such results, thus obtained, would be of the greatest possible value to the owners of steamships, to engineers, and ship-builders.

The inference which we are compelled to draw from the studied concealment to which we have referred to is, that, up to the present time, neither of the four ships have realized the expectations of their owners, the requirements of the service, or the conditions of the contracts. Be this as it may, we were not a little surprised to observe that several of those important improvements which we naturally anticipated finding combined in these most modern specimens of express steamship construction are absent. Among other improvements the absence of which we noticed, was any successful apparatus or contrivance for preventing smoke; this we naturally expected to find applied on board these steamships.

Having ourselves witnessed the denseness of the smoke emitted during nearly the entire time of the voyage between Holyhead and Kingstown in these new steam-vessels, and the fearful waste of fuel which must be the result, we cannot avoid adding, that we think Mr. C. W. Williams is called on, not only for the sake of the public, but in his own justification, to explain the cause of these serious defects in vessels constructed under his own eye, as the chief managing director of the company, and now under his own immediate control.

So far from these new steam-vessels presenting, as was universally anticipated, all that could be done in the way of improvement, we infer they are the very reverse, as regards the important consideration of economy in fuel, and freedom from the waste and nuisance of smoke and consequent deposit of soot.

Mr. Williams was awarded the Prize Medal by the Society of Arts for the best Essay on the Prevention of Smoke.

The judges, also, at Newcastle awarded him the £500 premium for the best method of avoiding the issue of smoke in marine tubular boilers.

In the printed report now before us made by Sir William Armstrong, Dr. Richardson, and Mr. Longridge, we find the following remarks, speaking of Mr. Williams's system (p. 54):—"The results show a large increase above the standard in every respect." (P. 55.) "The prevention of smoke was, we may say, *practically perfect*, whether the fuel burned was 15 or 27lbs. per sq. ft. per hour. Indeed, in one experiment we burned the extraordinary quantity of 37½lbs. of coal per sq. ft. per hour, upon a grate of 15½ sq. ft., giving a rate of evaporation of 5½ cubic feet of water per hour per sq. ft. of fire-grate, without producing smoke." (P. 56.) "No particular attention was required from the stokers. In fact, in this respect the system leaves nothing to desire, and actual labour is even less than that of the ordinary mode of firing." (P. 57.) "Mr. Williams's system is applicable to all descriptions of marine boilers, and its extreme simplicity is a great point in its favour."*

Under these circumstances, then, we ask, why do the boilers in Mr. Williams's own steamers present so remarkable a contrast? Why does his theory and his practice at Newcastle present so extraordinary a difference with that in the steam-vessels under his own management?

We believe the speed attained by these ships, under the most favourable circumstances, to be rather less than was expected by their designers; and, as is usual, or most frequently the case, the shipbuilders and the engineers are not agreed as to which of them is really at fault. But, as to the *cost* of attaining the maximum speed in either of the ships, we are quite in the dark, and are forced to the conclusion that, had the performances of these ships been as satisfactory, economically, as the public were at first led to believe, they would long ago have been blazoned forth as triumphs of science and art.

* See. p. 19 of Report.

VALUE OF BAROMETRICAL INDICATIONS.

On the occasion of the burricane which swept the Island of St. Kilda, in the Hebrides, on the 3rd October last, and inflicted such distressing loss on its poor inhabitants, the following were the indications of a new verified barometer, on board Her Majesty's steamer *Porcupine*, then off the island, as reported by her commander, Captain Otter, R.N. The rapid and regular fall of the mercury, to the extent of 1½ inch, between 8 a.m. on the 2nd October, and 3.26 a.m. on the 3rd, at which latter time the hurricane began, and its then rapid rise of nearly an inch, are interesting verifications of the certainty by which coming weather is indicated by this valuable instrument, which is at this moment deservedly attracting so much public attention:—

A SPECIMEN OF A DAILY BAROMETER DIAGRAM FOR NOVEMBER, 1860.

DAYS OF THE MONTH.

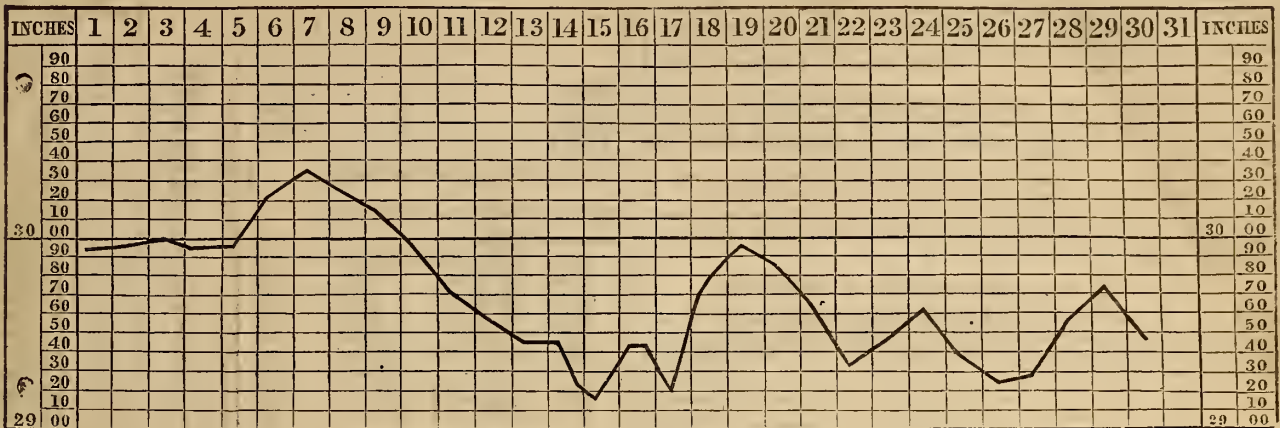

		Inches.
Oct. 2	8.0 a.m.	mercury 30.32
	8.0 p.m.	" 29.75
	8.15 p.m.	" 29.70 wind S.
	8.45 p.m.	" 29.62 SSW.
	10.0 p.m.	" 29.34 SSW.
	11.30 p.m.	" 29.26 SW.
	11.40 p.m.	" 29.22 SW.
Oct. 3	0.15 a.m.	" 29.16 SW, heavy squalls.
	0.45 a.m.	" 29.10 SW, "
	2.0 a.m.	" 28.96 SW, "
	2.40 a.m.	" 28.87 SW, nearly calm.
	3.20 a.m.	" 28.87 SW, westerly.
	3.26	NW, hurricane began.
	5.30 a.m.	" 29.52 N, NNW, gale.
	6.10 a.m.	" 29.65 NNW.
	7.15 a.m.	" 29.65 N, nearly calm.
	Noon.	" 29.87 NW by N.
	2.30 p.m.	" 29.87

Admiral Cator recently reported to the National Life-Boat Institution, that while at Calleroats, near Shields, in the beginning of October last, the fishermen of that place had expressed to him their gratitude for the barometer which the Duke of Northumberland, President of the Institution, had presented to them. A fearful gale from the westward had about that time somewhat suddenly sprung up. The fishermen were preparing to go to sea. Some of them observed the fall of the barometer, while others disputed its utility and even treated it with derision. The majority of the fishermen, however, decided that they would not go to sea while the barometer was falling, although it was quite fine at the time. A few hours afterwards a terrific gale of wind came on from the westward, when they expressed their firm conviction that every one of them would, if they had gone to sea, as most assuredly they would have gone, in the absence of the barometer, probably have perished by being blown far into the ocean, and there overwhelmed.

The diagram annexed is for the month of November just passed. The accompanying one-inch diagram, by Mr. James Glaisher, F.R.S., is an illustration of the two-inch diagram, which will be placed by the side of the barometers of the National Life-boat Institution on various parts of the coasts of the United Kingdom. An inspection will show that, till the fifth day, the deviations from a horizontal line are very small; then there is an ascending line to the 7th, when the highest point in the month is reached; from this time till the 12th the barometer reading was constantly decreasing; on the 13th there was scarcely any change; on the 14th two points are laid down, as the reading decreased from 29.46 in., in the morning, to 29.28 in., in the evening; on the 15th the lowest reading in the month took place; on the 16th the reading was steady all day; it then decreased during the night to 29.30 in.; on the following morning there was a rise of half an inch between the 17th and 18th; and the increase continued till the 19th; there was then a decrease to the 21st; and alternately an increase and decrease about the point 29.5 in. till the end of the month.

Now, if day by day such curves be laid down, and be watched in connection with the direction of the wind, and the Barometer Instructions by Admiral Fitzroy, F.R.S., they will certainly tend to save many lives, and to preserve much valuable property from destruction. We may add that the gallant Admiral, as well as Mr. Glaisher, F.R.S., are cordially co-operating with the Royal National Life-Boat Institution in the establishment of thoroughly efficient barometers on the coast.

STRENGTH OF MATERIALS: DEDUCED FROM THE LATEST EXPERIMENTS OF BARLOW, BUCHANAN, FAIRBAIRN, HODGKINSON, STEPHENSON, MAJOR WADE, U. S. ORDNANCE CORPS, AND OTHERS.

By CHAS. H. HASWELL, Civil and Marine Engineer.

TRANSVERSE STRENGTH.

The Transverse or Lateral Strength of any Beam, Rod, Bar, &c., is in proportion to the product of its breadth, and the square of its depth; and in like sided beams, bars, &c., it is as the cube of the side, and in cylinders as the diameter of the section.

When one end is Fixed and the other projecting, the strength is inversely as the distance of the weight from the section acted upon; and the strain upon any section is directly as the distance of the weight upon that section.

When both ends are Supported, only, the strength is four times greater for an equal length, when the weight is applied in the middle between the supports, than if one end only is fixed.

When both ends are Fixed, the strength is six times greater for an equal length, when the weight is applied in the middle, than if one end only is fixed.

The strength of any rod, bar, &c., to support a weight, in the centre of it, when the ends rest merely upon two supports, compared to one when the ends are fixed, is as 2 to 3.

When the weight or strain is uniformly distributed, the weight or strain that can be supported, compared with that when the weight or strain is applied at one end or in the middle between the supports, is as 2 to 1.

In metals, the greater the dimension of the side of a beam, &c., or the diameter of a cylinder, the less its proportionate transverse strength.

The strength of a Cylinder, compared to a Square of like diameter and sides, is as 4⁷1 to 8.

The strength of a Hollow cylinder is to that of a Solid cylinder, of the same length and quantity of matter, as the greater diameter of the former is to the diameter of the latter; and the strength of hollow cylinders, of the same length, weight, and material, is as their greatest diameters.

The strength of an Equilateral Triangle, having an edge up, compared to a Square of the same area, is as 22 to 27; and the strength of an equilateral triangle, having an edge down, compared to one, an edge up, is as 38 to 23.

NOTE.—In these comparisons, regarding the triangle, the beam or bar is considered as one end being fixed, the weight suspended from the other. In Barlow, and other authors, the comparison is made when the bar or beam rested upon supports. Hence, the stress is contrariwise.

Detrusion is the resistance that the particles or fibres of materials oppose to their sliding on each other, under a detrusive strain. Punching and shearing are detrusive strains.

Deflection.—When a beam, bar, &c., is deflected by a cross strain, the side of the bar, &c., which is bonded by the concave surface is compressed, and the opposite side is extended.

The Neutral Line, or Axis of Equilibrium, is the line at which extension terminates and compression begins.

In Stones and Cast metals, the resistance to compression is greater than the resistance to extension.

In Woods, the resistance to extension is greater than the resistance to compression.

The general law regarding deflection is, that it increases, *ceteris paribus*, directly as the cube of the length of the rod, bar, &c., and inversely, as the breadth and cube of the depth.

The Resilience, or toughness of a body is a combination of flexibility and strength.

The resistance of Flexure of a body at its cross-section is very nearly nine-tenths of its tensile resistance.

Relative Stiffness of materials to resist a transverse strain:—

Wrought Iron,	1.3	Oak,	.095
Cast Iron,	1.	Ash,	.089
White Pine,	1.	Beech,	.073
Yellow Pine,	.087	Elm,	.073

The strength of a Rectangular Beam in an *Inclined position* to resist a vertical stress, is to its strength, in a horizontal position, as the square of radius to the square of the cosine of elevation; that is—as the square of the length of the beam, to the square of the distance between its points of support, measured upon a horizontal plane.

Beams of cast metal, having small dimensions, are stronger *pro rata* than those having larger dimensions, in consequence of their having a greater proportion of chilled surface compared to their elements of strength resulting from dimensions alone.

Experiments upon bars of cast iron, 1, 2, and 3 inches square, give a result of 447, 348, and 338 lbs., respectively; being in the ratio of 1, .78, and .756.

The strongest rectangular beam that can be cut of a cylinder, is one of which the squares of the breadth and depth of it, and the diameter of the cylinder, are as 1, 2, and 3, respectively.

TABLE OF THE TRANSVERSE STRENGTH OF MATERIALS.

Deduced from the experiments of U. S. Ordnance Department, Barlow, Rennie, Stephenson, Hodgkinson, Fairbairn, Pasley, Hatfield, and the Author, and reduced to a uniform measure of *One Inch Square and One Foot in Length; Weight suspended from one end.*

MATERIALS.	Specific gravity.	Breaking weight.	Weight borne while the elasticity was perfect.	Value of W for general use.
WOODS.				
Teak745	lbs. 206	lbs. 65.5	60
Oak, English934	140	43.8	35
Do. do. superior748	188	...	45
Do. Canadian872	146	49.5	36
Do. American, superior	230	...	50
Do. Dantzic756	122	43.8	30
Do. African982	208	...	50
Ash760	168	49.5	55
Beech696	130	33	32
Birch711	160	...	40
Elm553	{ 82	27.5	25
		{ 170	45	40
Pitch Pine660	136	33	45
Ditto American777	160	...	50
White Pine553	92	33	30
Ditto American	130	...	45
Riga Fir753	94	27.5	30
Norway Pine577	123	44	40
Locust936	295	...	100
Deal, Christiana698	137	...	45
Larch556	93	33	25
White wood	116	...	38
Maple	202	...	65
Hickory	250	...	55
Chestnut	160	...	53
Riga Fir, Wet632	107	...	30
Ditto Dry330	96	...	30
METALS.				
Cast-iron, American { means of 5 divisions of grades..... }	{ 7.087	507	...	125 to 160
	{ 7.182	632	...	155 ,, 210
	{ 7.246	733	...	180 ,, 240
	{ 7.270	762	...	190 ,, 250
	{ 7.340	772	...	192 ,, 250
Ditto, Mean by Major Wade.....	7.225	681	...	170 ,, 225
Ditto, West Point Foundry, extreme	...	980	...	250 ,, 325
Ditto, English, Low Moor, Cold blast	7.055	472
Ditto, Gartsherrie, Hot blast	7.017	447	...	110 ,, 140
Ditto, Carron, Cold blast	7.094	443
Ditto, Muirkirk, Hot blast	6.951	418
Ditto, Ponkey, Cold blast	7.122	581	...	145 ,, 190
Ditto, Hot blast, mean	500	...	125 ,, 165
Ditto, Cold blast, mean	516	...	130 ,, 170
Ditto, Ystalyfera, Cold blast	770	...	195 ,, 255
Ditto, Mean of 65 kinds	500	...	125 ,, 165
Steel, greatest	7.862	1918	...	400 ,, 500
Wrought Iron.				
American	1500	Permanent bend. { 700 } { 650 } { 600 }	...	160 ,, 210

MATERIALS.	Specific gravity.	Breaking weight.	Weight borne while the elasticity was perfect.	Value of W for general use.
English	1000	lbs. 400	lbs. ...	100 ,, 130
Ditto	1080	520	...	130 ,, 170
Ditto	1200	550	...	135 ,, 180
Swedish*	665	...	165 ,, 220
English, stress applied horizontally	...	{ set. '001 in. } 190	...	180 ,, 240
Mixture of Cast & Wrought Iron, &c.				
Cast-iron, Blaenavon	575	145
Ditto 10 per cent. of wrought ..	703	175
Ditto 20 ditto ditto ..	842	210
Ditto 30 ditto ditto ..	920	230
Ditto 40 ditto ditto ..	767	195
Ditto 50 ditto ditto ..	727	185
Ditto and 2½ per cent. of Nickel } } mean } Ditto Stirling, 2nd quality	693	173
Ditto ditto 3rd ditto	750	188
	623	154
	499	125
STONES, AMERICAN.				
Flagging, Blue	2.707	31
Freestone, Little Falls, N. Y.	2.326	24
Ditto Belleville, N. J.	2.300	{ 20.1 } 17.8
Ditto Connecticut	2.462	13
Ditto Dorchester	2.289	10.8
Ditto Anbigny	2.472	9.3
Ditto Caen	2.218	6.1
Granite, blue, coarse	2.604	18
Ditto Quincy, Mass.	2.658	26
STONES, ENGLISH.				
Yorkshire Blue Stone	26
Ditto Paving	10.4
Ditto Landing	22.5
Caitness Paving, Scotland	68
Valentia ditto, Ireland	68.5
Welsh ditto	157
Arbroath	17
Craighleith Sandstone	2.266	10.7
Hailes	7.4
Felling	7.5
Kentish Rag	35.8
Cornish Granite	22
Portland Oolite ..	2.145	11.2
Bath	5.2
Bangor Slate	90
Llangollen Slate	43

MATERIALS.	Breaking weight.
CONCRETES (English).	
Aberthaw lime 1, gravel 7	8
Hydraulic lime and gravel (old) ..	2
Fire brick beam, Portland cement ..	3.1
Ditto ditto sand 3 parts, lime 1 part ..	7
CEMENTS (English).	
Portland	{ 37.5 } 30.4
Portland 1 part, sand 2 parts	{ 10.2 } 10
Blue clay 5 parts, chalk 4 parts ..	{ 14.3 } 5.8
Blue clay and chalk	{ 5.4 } 5
Sheppy	5
BRICKS (English).	
Fire brick	11
Stock brick, well burned	5.8
Ditto inferior burned	2.5
Old brick ..	9.1
New brick } (English)	{ 10.7 } 18.1
Best stock }	









COMPARATIVE TRANSVERSE STRENGTH OF A PRISM OF LIME AND CEMENT MIXED WITH VARIOUS PREPARATIONS OF GRAVEL AND SAND (SIR C. W PASLEY).

One Inch Square, and One Foot in Length, the Weight being suspended from one end.

MIXTURE.	Days immersed in water.	Age in days.	Breaking weight.
Chalk lime 1, sand 3·25	19	396	lbs. '81
Ditto 1 { gravel 3 } 1 { sand 4 }	446	'156
Ditto 1 { gravel 6 } 1 { sand 3 }	32	446	'39
Halling lime 1, sand 3	342	1'40
Ditto 1 { gravel 6 } 1 { sand 2 }	18	457	1'62
Ditto 1 { gravel 6 } 1 { sand 3 }	32	453	1'43
Blue Lias lime 1 { gravel 6 } 1 { sand 3 }	345	'80
Rosehill lime 1, sand 2	342	1'56
Sheppy and Harwich cements 1, gravel 1'5, and sand 2'0	385	'93
Chalk 5 } Gravel 1'5, sand 2'0	385	'156
Blue clay 2 }
Chalk 5 } Gravel 5, sand 2	439	'41
Blue clay 2 }
Chalk 5 } Gravel 3, sand 4	18	431	'76
Blue clay 1 }
Chalk 5 } Gravel 6, sand 2	18	431	1'03
Blue clay 1 }
Chalk 6 } Gravel 5, sand 4	16	429	'45
Blue clay 1 }
Chalk 7 } Gravel 5, sand 4	16	429	'44
Blue clay 1 }
Chalk lime 1, screened ballast 5	270	1'12
Ditto 1, ditto 10	256	'27
Halling lime 1, ditto 3	270	1'40
Ditto 1, ditto 10	270	'42
Blue Lias lime 1, ballast 6	239	1'08
Ditto 1, ditto 10	268	'33
Sheppy and Harwich cements 1, ballast 2	143	1'04
Ditto ditto 1, ditto 7	234	'12

TABLE OF THE TRANSVERSE STRENGTH OF CAST IRON BARS AND OAK BEAMS OF VARIOUS FIGURES,

Having a Uniform Sectional Area of One Square Inch, One Foot in Length, fixed at one end, Weight suspended from the other.

Form of Bar or Beam.	Breaking Weight.
Cast Iron.  Square	lbs. 673
 Ditto, diagonal vertical	568
 Cylinder	573
 Hollow cylinder, greater diameter twice that of less	794
 Rectangular, 2in. deep x 1/2in. thick	1456
Ditto 3in. " x 1/2in. "	2392
Ditto 4in. " x 1/2in. "	2652
 Equilateral triangle, an edge up	560
 Ditto ditto an edge down	958
 2in. deep x 2in. wide x .268in. thick	2068
 Ditto ditto ditto	555



Oak. 	Equilateral triangle, an edge up	114
	Ditto ditto an edge down	130

TABLE OF THE TRANSVERSE STRENGTH OF SOLID AND HOLLOW CYLINDERS OF VARIOUS MATERIALS,

One Foot in Length, Weight suspended from one end.

MATERIALS.	Specific gravity.	Solid external diameter in inches.	Hollow internal diameter in inches.	Breaking weight in lbs.	Breaking weight for 1in. external diameter, and proportionate internal diameter.
WOODS (English):					
Fir*	'588	2'	...	772	97
Ash	'590	2'	...	685	86
"	'580	2'	1'	604	75
"	'601	2'	'75	625	78
"	'586	2'	'50	636	79
White Pine, American	...	1'	...	75	75
"	...	2'	...	610	76
METALS:					
Cast iron, cold blast	...	3'	...	12,000	444
STONE WARE:					
Rolled pipe of fine clay	...	2'87	1'928	190	8

* An inch square batten from the same plank as this specimen, broke at 139lbs.

RESULT OF EXPERIMENTS ON THE TRANSVERSE STRENGTH OF SCARPHED BATTENS (BARLOW).

Battens 4 feet in length, fixed at one end, and loaded at the other.

[Note.—Dimensions of battens not given.]

Scarph, 12in. in length, small end up, and 1in. from face of fulcrum	Broke in the neck of the scarph, close to the fulcrum	lbs. 87
Scarph, 12in. in length, large end up, and 1in. from face of fulcrum		Fastenings of small end of scarph drew out
Scarph, vertical	Broke in the scarph	211

(To be continued.)

ON THE ELASTIC FORCE OF VAPOURS.

BY M. V. REGNAULT.

(From the Journal of the Franklin Institute.)

I presented to the Academy, in August, 1854, the principal results of the experiments which I had made to determine the laws which exist between the elastic forces of vapours and the temperatures to which they are subjected. This work is a portion of a long series of investigations, the first part of which was published in 1845,* the principal object of which is to collect the physical elements necessary to calculate the theoretical work which can be obtained from a substance, either when it is transformed into an elastic fluid by means of a known quantity of heat, or when the elastic fluid, losing a certain quantity of heat, develops a known moving power, either in resuming the liquid state, as in the condensing steam engine, or simply in increasing in volume, as occurs in high pressure steam engines and in hot-air engines.

The law which connects the elastic forces of gases and vapours with their temperature necessarily plays an important part in this general question. Moreover, it appears that it ought to be one of the simplest of the theory of heat, because it depends only upon two elements which are clearly defined and susceptible of precise determination, the temperatures and the pressures which the elastic forces balance.

This announcement will explain the interest which I attached to an investigation of this sort, and the perseverance with which I collected its elements. In fact, my work extends from gases which have been liquefied by compression, to substances, such as mercury and sulphur, whose boiling-points are not so high

but that they may be kept in ebullition, under high pressures, in apparatus which can now be constructed.

The Memoir which includes the whole of these observations has been printed for several years; it forms a part of vol. xxvi. of the "Memoirs of the Academy." The publication has been delayed by circumstances beyond my control, and particularly by the necessity of myself tracing upon the plate, as I did for steam ("Memoirs of the Academy," vol. xxi.), the points determined by each separate experiment, and the curves which exhibit their connexion.

This Memoir, as I announced in 1854 ("Comptes Rendus," vol. xxxix. pp. 301, 345, 397), is divided into five parts:

1st. The first includes my examinations into the elastic forces of saturated vapours through a great range of temperatures.

2nd. The second treats of the elastic forces of vapours emitted by saline solutions, and of their boiling point under different pressures.

3rd. In the third, I study the elastic forces of these same vapours in the air and in other gases.

4th. The fourth treats of the elastic forces of vapours from two volatile liquids, either dissolved in one another, or simply superposed when they exercise no mutual dissolving action.

5th. Finally, in the fifth, I endeavour to determine whether the solid or liquid state of the same body exercises any influence for the same temperature over the elastic force of the vapour which it emits.

I shall not here again allude to the last four parts of the Memoir; the general conclusions which I thought could be drawn from my experiments appear to be sufficiently expressed in the "Comptes Rendus" of 1854. I ask of the Academy only the permission to give it some developments of the first part, that which treats of the elastic forces of saturated vapours *in vacuo*, of which I could cite but a few examples in my communication in 1854.

The various apparatus which I used in these researches are described in the Memoir; I shall not dwell upon them; remarking only that they are referable to two different methods.

The first, which I call the *static method*, consists in determining the pressure which equilibrates the elastic force of the vapour, *at rest*, which a liquid in excess emits at various temperatures. In the second method, which I call the *dynamical method*, the vapour is always in motion, and we determine the temperature of the vapour which the liquid *continually* emits when boiling under different pressures.

These two methods give results which are identical:

1st. When the liquid is perfectly homogeneous. It is not so when it is impure; the presence of the smallest quantity of a volatile foreign body shows itself immediately by the non-superposition of the two graphical curves belonging to the two methods.

2nd. When the liquid has not a great molecular attraction. In the opposite case the liquid boils intermittently with violent starts, and the determinations by the dynamical method become very uncertain.

The two methods could be successfully applied to the greater part of the volatile substances which were submitted to my experiments, and they have enabled me to determine their elastic forces from the lowest temperatures up to those which correspond to pressures of from 12 to 15 atmospheres. The greatest part of the gases liquified by pressure give liquids which possess great molecular attraction and resist ebullition notwithstanding their extreme mobility. Their elastic forces can only be certainly determined by the statical method. When we wish to apply the dynamic method, the thermometer cannot be placed in the vapour of the boiling liquid unless the boiling-point is above the temperature of the surrounding air; for if it be inferior, the vapour may become overheated, and the indications of the thermometer will be wrong. If the thermometer is placed in the boiling liquid, it does not show a constant temperature during ebullition, although the pressure remains the same. The indications of the thermometer change much according to the manner in which the heat is applied. The boiling is not continuous; it takes place with violent shocks, which are attended by a sharp noise, like that of the water-hammer when it is suddenly inverted. These effects vary much with the pressure under which the boiling takes place. Certain liquids present them even under pressures below that of the atmosphere; in others they appear only under high temperatures.

The limits to which I am obliged to confine myself in this *résumé* do not allow me to state the individual observations which I have made on each substance, nor even to explain the method of graphical construction, nor the formulae of interpolation by which I endeavoured to express the results of my experiments in the best way. I will remark only, that of all the modes of interpolation which were successively tried, the formula by exponential series proposed by De Prouy and applied by M. Biot to the vapour of water under the form

$$\text{Log. } F = a + bat + c\beta t$$

is the one which applied most exactly to all the substances studied. This formula has, besides, the advantage of containing five constants, for the determination of which, five points of the graphic curve, having equidistant abscissae, may be selected, so that the curve represented by the formulae can vary but very little from the curve traced through the intermediate points. Moreover, I show in my Memoir that for a great number of the substances studied we may, by a convenient adjustment of the fixed points which serve to calculate the constants, without sensibly departing from the data of direct observation, calculate a formula with two exponentials

$$\text{Log. } F = a + bat + c\beta t$$

in which the term $c\beta t$ introduces only quantities less than the errors of observation so that it may be reduced to the more simple one,

$$\text{Log. } F = a + bat$$

This consideration, and the great resemblance which the curves traced for the different substances have to each other, when the ordinate is taken equal to $\frac{F}{760}$, leads me to think that the law of the elastic forces and temperatures would

present itself under a very simple form, if for the variable independent we should assume not the temperature as we define it in an entirely arbitrary manner, but another element which should be immediately connected with the constitution of each body, and whose origin should be fixed for each one of them.

I have in the following tables presented the elastic forces of the different vapours, calculated for temperatures varying by 5°, according to the formulae which I calculated from my experiments. The temperatures are those of the mercurial thermometer which I used. In my Memoir I also give the corresponding temperatures taken by the air-thermometer. The reduction of the temperatures from the mercurial to the air-thermometer was determined by especial experiments.

TABLE No. I.

LIQUIDS OF MEAN VOLATILITY.

BOILING POINT BETWEEN 14° AND 150° CENT.

	Alcohol.	Ether.	Sulphuret of Carbon.	Chloroform.	Benzine.	Chloride of Carbon. C ₂ Cl ₄ .
T.	F.	F.	F.	F.	F.	F.
deg.	m.	m.	m.	m.	m.	m.
- 25	2:37	...
- 20	3:34	67:49	43:48	...	4:94	...
- 15	4:69	87:89	60:91	...	8:62	...
- 10	6:58	113:35	81:01	...	13:36	...
- 5	9:21	144:82	104:40	...	19:30	...
0	12:33	183:34	131:98	...	26:62	30:55
+ 5	17:73	230:11	164:53	...	35:60	40:09
10	24:30	286:40	203:00	...	46:59	52:08
15	33:02	353:62	248:40	...	60:02	67:09
20	44:48	433:26	301:78	160:47	76:34	85:49
25	59:35	526:93	364:24	199:40	96:09	107:94
30	78:49	636:33	436:97	245:91	119:89	135:12
35	102:87	763:27	521:36	301:13	148:37	167:73
40	133:64	909:59	616:99	366:20	182:27	206:51
45	172:14	1077:22	729:72	442:37	222:37	252:31
50	219:88	1271:12	856:71	530:96	269:51	305:39
55	278:61	1484:59	1000:87	633:36	324:61	367:63
60	350:26	1728:52	1163:73	751:01	388:62	439:66
65	436:99	2002:13	1346:86	885:41	462:57	522:26
70	531:21	2307:81	1551:84	1038:09	547:51	616:48
75	665:52	2647:75	1780:28	1210:62	644:59	723:29
80	812:76	3024:41	2033:77	1404:57	756:63	843:70
85	985:97	3440:30	2313:90	1621:52	879:55	978:71
90	1188:43	3898:05	2622:23	1863:12	1019:96	1129:04
95	1423:52	4400:55	2960:30	2130:90	1177:10	1296:47
100	1694:92	4950:81	3329:54	2426:52	1352:27	1481:19
105	2006:34	5552:18	3731:37	2751:23	1546:59	1684:45
110	2361:63	6208:37	4167:18	3106:83	1761:29	1907:21
115	2764:74	6923:55	4638:14	3494:69	1997:48	2150:47
120	3219:68	7702:20	5145:43	3916:17	2256:26	2415:23
125	3730:41	...	5690:08	4372:73	2538:66	2702:54
130	4301:04	...	6273:03	4865:65	2846:66	3013:49
135	4935:40	...	6895:06	5396:23	3178:18	3349:28
140	5637:00	...	7556:88	5965:76	3537:05	3711:23
145	6410:62	6575:41	3923:00	4100:81
150	7258:73	7226:49	4336:70	4519:73
155	8185:02	7920:19	4778:69	4969:97
160	8657:72	5249:43	5453:88
165	9440:40	5749:26	5974:28
170	6278:40	6534:58
175	6837:04	7138:90
180	7425:66	7792:33
185	8042:41	8501:02
190	9272:67
195	10116:74

TABLE No. I.—continued.

LIQUIDS OF MEAN VOLATILITY.

BOILING POINT BETWEEN 14° AND 150° CENT.

	Chlorhydric Ether.	Bromhydric Ether.	Iodohydric Ether.	Methylic Alcohol.	Acetone.
T.	F.	F.	F.	F.	F.
deg.	m.	m.	m.	m.	m.
- 30	110:24
- 25	145:01
- 20	187:55	6:27	...
- 15	239:60	9:29	...
- 10	302:09	13:47	...
- 5	376:72	19:17	...
0	465:18	...	41:95	26:82	...
+ 5	569:32	...	54:14	36:89	...

	Chlorhydric Ether.	Bromhydric Ether.	Iodohydric Ether.	Methylic Alcohol.	Acetone.
T. deg.	F. m.	F. m.	F. m.	F. m.	F. m.
10	691.11	...	69.20	50.13	...
15	832.56	...	87.64	67.11	...
20	996.23	380.30	110.02	88.67	197.89
25	1184.17	463.30	136.95	115.99	226.27
30	1398.99	559.81	169.07	149.99	281.00
35	1643.24	671.31	207.09	192.01	345.15
40	1649.58	799.35	251.73	243.51	420.15
45	2230.71	945.56	303.77	306.13	507.52
50	2579.40	1111.65	364.00	381.68	602.86
55	2668.43	1299.41	433.21	472.20	725.95
60	3400.54	1510.69	512.25	579.93	860.48
65	3878.52	1747.43	...	707.33	1014.32
70	4405.03	2011.57	...	857.10	1189.38
75	4982.72	2305.24	...	1032.14	1387.62
80	5614.11	2630.45	...	1238.47	1611.05
85	6301.61	2989.38	...	1470.92	1861.81
90	7047.51	3384.22	...	1741.67	2141.66
95	7853.92	3817.11	...	2051.71	2452.81
100	8722.76	4290.33	...	2405.15	2797.27
105	...	4806.11	...	2806.27	3177.00
110	...	5366.67	...	3259.60	3593.96
115	...	5974.26	...	3769.80	4050.02
120	...	6631.08	...	4341.77	4546.86
125	...	7339.33	...	4980.55	5086.25
130	...	8101.15	...	5691.30	5669.72
135	...	8918.64	...	6479.32	6298.68
140	...	9793.86	...	7337.10	6974.43
145	8308.87	...
150	9361.35	...

TABLE No. II.
LIQUIDS BOILING ABOVE 150° CENT.

Essence of Turpentine.		Essence of Lemon.		Methyloxalic Ether.	
T. deg.	F. m.	T. deg.	F. m.	T. deg.	F. m.
0	2.07	98.99	69.80	109.41	117.26
10	2.94	115.40	129.39	109.53	117.46
20	4.45	115.10	129.09	125.98	222.67
30	6.87	124.85	178.31	126.06	222.87
40	10.80	125.03	179.01	136.45	320.11
50	16.90	137.00	263.42	145.14	423.37
60	26.46	147.35	357.04	155.70	591.36
70	40.64	155.52	449.23	164.30	761.35
80	61.30	165.08	576.50	188.92	1589.81
90	90.61	174.25	748.67	192.37	1589.81
100	131.11	174.16	749.69	217.16	2958.68
110	185.62	201.60	1439.68	228.95	3875.95
120	257.21	223.30	2328.04	237.16	4849.72
130	348.98	236.65	3213.49	164.48	763.48
140	464.02	239.70	4374.42	242.86	4867.83
150	605.20	253.53	6203.14
155	686.37
160	775.09
165	871.27
170	975.42
175	1090.11
180	1207.92
185	1336.45
190	1473.24
195	1618.26
200	1771.47

The experiments on the essence of turpentine were carried to much heavier pressures, but I judged it useless to transcribe them here, because they had reference only to an essence completely modified in its molecular constitution. I have in my Memoir described the series of researches by which I studied the isomeric modifications which the essence successively undergoes by its boiling under various pressures.

When these experiments were ended, the essence of lemon showed the same boiling point at atmospheric pressure as before, but it had completely lost its power of rotating polarized light.

The boiling of methyloxalic ether is pretty steady under pressures, but little above that of the atmosphere, but under heavy pressures it becomes very irregular and produces violent starts.

TABLE No. 3.

	Mercury.
T. Deg.	F. MM.
0.0	0.0200
10	0.0268
20	0.0372
30	0.0530
40	0.0767
50	0.1120
60	0.1643
70	0.2410
80	0.3528
90	0.5142
100	0.7455
110	1.0734
120	1.5341
130	2.1752
140	3.0592
150	4.2664
160	5.9002
170	8.0912
180	11.00
190	14.84
200	19.90
210	26.35
220	34.70
230	45.35
240	58.82
250	75.75
260	96.73
270	123.01
280	155.17
290	194.46
300	242.15
310	299.69
320	368.73
330	450.91
340	548.35
350	663.18
360	797.74
370	954.65
380	1136.65
390	1346.71
400	1587.96
410	1863.73
420	2177.53
430	2533.01
440	2933.99
450	3384.35
460	3888.14
470	4449.45
480	5072.43
490	5761.32
500	6520.25
510	7353.44
520	8264.96

TABLE No. 4.

VERY VOLATILE LIQUIDS, LIQUEFIED GASES.

	Sulphurous Acid.	Ammonia.	Sulphydric Acid.
T. Deg.	F. MM.	F. MM.	F. MM.
0	...	157.95	441.42
10	...	528.61	...
20	...	684.19	...
30	...	876.58	2308.57
40	373.79	1112.12	3508.02
50	479.46	1397.74	4273.01
60	607.90	1740.91	5090.18
70	762.49	2149.52	5945.00
80	946.90	2632.25	6822.74
90	1165.06	3162.87	7709.27
100	1421.14	3854.47	...
110	1719.55	4612.19	...
120	2064.90	5479.86	...
130	2462.05	6467.00	...
140	2915.97	7581.16	...
150	3431.80	8832.20	...
160	4014.78	10144.00	...
170	4670.23	11776.42	...
180	5403.52
190	6220.01
200	7125.02
210	8123.80
220	9221.40

NOTE TO TABLE 3.—The temperatures here recorded are those of the air-thermometer. The boiling of the mercury is pretty steady under pressures below that of the atmosphere. At the atmospheric pressure the starts begin; they become more and more violent as the pressures augment, and under the pressure of 10 atmospheres the shocks are so strong as to produce a noise as loud as that of a forge-hammer striking upon the anvil. The apparatus appeared in danger of flying in pieces.

The condensation of the gases was effected in the same apparatus which was to serve for the determination of the elastic forces, and which was so arranged that it could be completely purged afterwards of every trace of air or other gas which might be in it. The liquefaction of sulphurous acid was easily effected under the ordinary pressure of the atmosphere when the apparatus was plunged into a freezing mixture. For ammonia and sulphuretted hydrogen, the apparatus was plunged into a mixture of ice and crystallized chloride of calcium, and the gas was then compressed by a hand-pump. Only, care must be taken to replace the ordinary grease for the pump by fixed non-saponifiable oils. A pressure of 2 or 3 atmospheres is sufficient to liquify as much ammonia as is desired; but for sulphuretted hydrogen the pressure must be carried to 7 or 8 atmospheres.

As I have had occasion to liquefy these gases on a large scale for researches of which I will soon present the results to the Academy, and especially for the determination of the latent heat of volatilization under different pressures of very volatile liquids, and for the examination of the quantities of heat which their vapours absorb during their expansion, I will here briefly indicate the process which I employed.

I prepare carbonic acid gas by supplying in a continuous and regular stream properly diluted chlorhydric acid to fragments of marble enclosed in a very large glass vessel. The solution deprived of the acid and charged with chloride of calcium flows out as fast as it forms; the carbonic acid gas passes over to a gas receiver of a cubic capacity of 1 cubic metre. A condensing pump with several barrels, moved by my steam engine, draws the gas from the receiver, and having caused it to pass over drying materials, it forces it into a first recipient of 3 or 4 litres capacity which serves only as a regulator; thence the gas passes freely into the apparatus in which it is to be condensed, which is buried in a freezing mixture.

of ice and crystallized chloride of calcium. The gas which does not condense passes into a second closed recipient of 5 litres capacity. Into this last vessel the air and other more condensable gases pass, and from it they may from time to time be discharged by opening a stop-cock.

The same arrangement will serve to liquefy large quantities of protoxide of nitrogen, or sulphuretted hydrogen. But for these gases, which are easily rendered impure by contact with the grease and pistons of the pump, I employ a peculiar forcing-pump, in which the gas is in contact only with mercury. This pump is composed of two equal cast-iron cylinders, united in the form of a U. The first cylinder is turned, and contains a solid piston which, in its movement, acts only on a quantity of mercury, which fills exactly one of the pump cylinders. The suction and compressing (foot and head) valves are attached to the second cylinder. It will be seen that in this arrangement the gas never comes into contact with the piston or the greasy sides.

Liquid ammonia particularly occupied my attention, owing to its great capacity for heat, its great latent heat of evaporation, and the ease with which it is prepared and collected after it has assumed the gaseous state. I determined to use it principally for obtaining very stationary low temperatures by boiling it under different pressures. I prepare the ammonia as a gas by passing continuously a thread of a concentrated solution of ammonia into a copper tube enclosed in a small boiler containing water, which is kept boiling by a gas-light. The ammonia flows in a spiral along the walls, and the liquid, nearly deprived of ammonia, escapes by a tube below, which enters to a depth of several decimetres into the liquid which has previously flowed out.

The gaseous ammonia sucked by the pump traverses several copper recipients filled with soda lime. The pump itself regulates the production of the gas, and delivers it into the receiver, which is buried in a freezing mixture of ice and hydrated chloride of calcium. By means of this arrangement, several litres (quarts) of liquid ammonia may be obtained in a few hours.

To submit an apparatus to a stationary low temperature, it is hermetically adjusted in the condenser, and the liquid ammonia is condensed in this receiver buried in a freezing mixture. When it is sufficiently filled with the liquid, the freezing mixture is removed and the receiver placed in communication with one of my large air-reservoirs, in which the pressure is kept rigorously stationary, either above or below that of the atmosphere.

The ammonia thus distils under pressures as light as are desired, which are easily kept perfectly constant, provided the ammoniacal gas is prevented from reaching the air-reservoir. For this purpose, in front of this reservoir is placed a cylindrical vessel containing pieces of ice, which, as they liquefy, almost entirely redissolve the ammonia, and after this another cylinder filled with large pieces of pumice stone soaked with acid.

I thus hoped to obtain, by means of this apparatus, low temperatures which should be perfectly stationary, but I was not successful, for reasons which I have explained before. A certain amount of steadiness can only be obtained by passing a continual current of small bubbles of air through the liquid ammonia, which thus continually stirs up the liquid and destroys its viscosity. An air-thermometer should be placed in contact with the apparatus experimented on, and plunged entirely in the liquid ammonia; by means of a regulating screw, the current or air-bubbles is controlled so as to keep the thermometer stationary.—*Comptes Rendus de l'Academie des Sciences de Paris*, 11 Juin, 1860.

HIGGIN'S IMPROVED RAILWAY BREAK.

We have received the following description of Mr. Higgin's Improved Railway Break from a Manchester correspondent, who, as an engineer, considers this invention to be one deserving the serious attention of railway companies, railway carriage builders, &c. :—

The plan patented by Mr. James Higgin, of Hopwood Avenue, in this city, differs considerably from any of the existing methods. Mr. Higgin proposes to increase the friction surface on each break-carriage at least a hundredfold, as compared with the present 4-wheel break. To secure this and other improvements some rather considerable change is made in the construction of the carriage or portions of it. For the existing small wheels it is proposed to use wheels about 6ft. diameter; but the carriages, so far from being higher, will run much nearer the rails, the object being to obtain the break power by causing the carriage to settle down upon the rails like a sledge, a suitable under-surface being provided for that purpose. This consists of two iron plates, each about 23ft. long (supposing the carriage to be 33ft. in length), one under each of the main beams of the carriage immediately over the rails, and furnished with inner flanges similarly to the wheels. When the carriage is in motion these plates will be about four inches above the rails, and there is a mechanical arrangement, under the control of the engine driver, for lowering the carriage these few inches. The axle-bearings are made with screw nuts, in which work strong screws for the raising or lowering, and the screws are turned by bevil wheels, actuated by a shaft running under the carriage, and receiving its power from a small donkey engine attached to, and of course receiving steam from, the locomotive. This auxiliary engine has two cylinders, and it works a crank shaft running from it to the break carriage or carriages. Whenever, therefore, it is wished to stop the train, this engine is started, and it revolves the shaft extending beneath the carriages; the shaft turns the bevil wheels—which are, in fact, the heads of the screws,—and the carriage is gradually and softly lowered (the work of two or three seconds) until the long friction plates come in contact with the rails, on which, it is easy to perceive, they will not glide very far. The donkey engine is like some real donkeys—it takes care not to do too much. As soon as the carriage is lowered sufficiently it shuts off its own steam, and it does the same when, by reversing the motion, it has again raised the carriage to the proper working level. To avoid the possibility of mistake, an index shows the height of the plates above the rails. There is an arrangement to allow for the expansion and contraction of the buffers, and for conveniently joining the carriages; while there is sufficient play to admit of turning curves without straining the joints of the shafting.

Mr. Higgin calculates the relative increase of break-surface as 825in. in his carriage, to 5in. in the present one. The best breaks now in use do not, we believe, profess to stop a quick train in less than 200 yards, and that is a great advance on former times—but the patentee, arguing from the immense increase of rubbing surface, concludes that a rapid train would be brought to a stand in less than half as many feet. Many persons will be apt to suppose that this could not be accomplished without the passengers suffering a serious shock; but there is no cause for apprehension on that ground, where

the retardation is gradual, as it must be when resulting only from friction. This has been clearly proved by the experiments with centrifugal railways. After descending from a considerable altitude, a line of rails placed at an angle of 45°, an immense speed is attained, yet the passenger (and it happens that the writer can speak from experience, having made one of those whirling journeys) is so gradually retarded, by passing round the circle and then running up an incline, that he is safely brought to rest in a distance of 40 or 50ft.—which is less than a foot per mile of rate. This fact must have been witnessed by hundreds of people.

The increased size of the wheels would add much to the comfort of travelling; as wheels of something like double the diameter of those in general use must pass over more smoothly, make rough places plain, and do far less injury to the rails. The concomitant circumstance of the carriages hanging from the springs at a lower level will, it would seem, be also attended with some advantage; as much of the oscillation, which at high speeds is sometimes alarming,—especially when the carriages are not tightly coupled together,—will be materially reduced, and the danger of swinging off the rails avoided, while the carriages will be more convenient for ingress and egress. The patentee's idea is, that the principle (as new carriages are made) should be applied to the whole of the train, but that, in the first instance, such a break-carriage at each end of a train would be far more efficient than anything at present adopted—an opinion which we should think most practical men will be inclined to endorse.

Many of the serious accidents—fatal to life, and destructive to railway property—which have occurred through collision, would not have happened had the break power been sufficient to bring up the train when danger became visible. In such cases the stoker applies the break, the engineer reverses the engine, then (having done all they can) both leap for their lives; whereas, with such a break as this promises to be,—and we see no reason why all that is assumed of it should not be realised,—the engineer might stand courageously to his post, confident that the amount of friction at his command would overcome the momentum of the train before reaching the point of danger. The recent destructive collision at Leigh would not have happened, had such an amount of break-power as this been at command, as the danger was known within what would have been a safe distance. The great loss of life, destruction of property, and sacrifice of not less than £5000 for compensation, resulting from the calamity at Helmsshore, also could not have occurred, since, if the last-carriage had been resting upon the rails (according to this plan), that portion of the train which broke loose could not have run backwards down the incline. Very many instances, unfortunately, might be enumerated of accidents arising from deficiency of break-power.

ELECTRIC CABLES.

The Examiner gives the following:—"The question of electric cables was the subject of two nights' discussion at the last meeting of the Institution of Civil Engineers, and was debated with all the scientific and practical skill to be expected from the inheritors of the knowledge and inventions of Watt and Stephenson. The discussion took place on a very able paper on the 'Channel Islands Cable,' by its engineer, Mr. Preece. We give a few of the results. The Channel Islands cable extends from Weymouth to Alderney, Guernsey, and Jersey. The submerged portion of the cable is 93½ miles long, and the underground portion 26 miles, making the whole length of the electric wire little short of 120 miles. It has been in action about seven and twenty months, and within this short period the marine portion of it has been broken eleven times, five times by ships' anchors, and six by rocks and tides. The government has guaranteed an interest of six per cent. on £30,000, but the original subscriptions are exhausted, and the stock pays no dividends. When such is the result at our own doors, it may easily be supposed what is to be expected from cables ten times the length, and at a distance of 5000 and 12,000 miles from home. All the long electric cables have proved dead and irretrievable failures. The Atlantic cable, which was to bring the Old and New World into proximity, has utterly failed. So has the Red Sea cable, which was to have brought the Nile and the Indus within call of each other. The Dutch have not been more successful than ourselves. They laid a telegraphic cable between their fine island of Java and the nearest British possession, the colony of Singapore. The distance is 600 miles, and much of it through narrow straits with strong tides. For the first few days it was in working condition, but has never been so since, for the friction of the cable over sharp coral rocks has broken it a dozen times over, and its condition is already hopeless. Even the cables of the Mediterranean, which are for short distances, are constantly getting out of order. At the cost of our government a cable was constructed to connect Malta and Gibraltar, but the Mediterranean being found too deep for it, it is destined for India, to connect Rangoon with Singapore, which are distant from each other by fifteen degrees of latitude and nine of longitude, probably not less than 1100 miles, some 800 of which are through innumerable islands, with coral and granite reefs and strong tides, to say nothing of a temperature at least twenty degrees higher than that of the sea for which the cable was fabricated. Of course it will be a sure failure; and the sum which it cost, £400,000, might just as well be pitched in sovereigns into the Bay of Bengal and Straits of Malacca. The North Atlantic has been just surveyed with the view of connecting Britain with Labrador, by the route of the Orkneys, Iceland and Greenland. Besides rocks and currents, there will be here the obstacles of glaciers and icebergs; but probably after the failure of our ambitious experiments elsewhere we shall be saved from this one. Even in the narrow seas that connect us with the continent the short cables require constant attention and frequent repairs, and, in fact, they last but three or four years. Not only is the external wire liable to abrasion by rocks, and to fracture by oxidation, but the gutta-percha to decomposition. Our ambition to span oceans must be given up. The pride of science, in truth, has had a great fall; and such notions as wafting sighs, from India to the Pole' must, as heretofore, be left to the poets.

Beset as it was by projectors, encouraged by the public, we can hardly blame the government for the thousands it has committed to the deep; for to disabuse the nation, and bring it to its sober senses, the costly trials which have been made were, perhaps, indispensable."

PATERA'S PROCESS FOR EXTRACTING SILVER FROM ITS ORES.

BY CLEMENT LE NEVE FOSTER.

The process in question was originally suggested by Dr. Percy, F.R.S., of the Government School of Mines, and has been of late years taken up and carried out on a large scale by one of the most celebrated metallurgical chemists in Austria, viz., Herr von Patera. This process is of special interest, on account of the analogy it presents with the well-known "fixing" in photography, which is nothing more than dissolving out the chloride of silver (which has not been acted on by light) by means of hyposulphite of soda.

In the metallurgical process this property is made use of in the following manner:—The ores which contain the silver in combination with sulphur, or with sulphur and arsenic, are roasted with green vitriol and common salt, and thus is produced a chloride of silver which may be dissolved out by a solution of hyposulphite. The silver can then be precipitated by sulphide of sodium, falling down as sulphide of silver. All that is necessary to be done then is to heat the sulphide in a muffle in contact with the atmosphere; the sulphur escapes in the form of sulphurous acid, and the silver remains in the metallic state. It is then melted in plumbago pots and cast into ingots for the mint. Such is a rough outline of the process which is now, and has been for some years in operation at Joachimsthal, on the northern frontier of Bohemia. The ores which are subjected to this process are rich in silver, containing on an average two per cent., but often as much as 10 per cent. Ores containing less than one per cent. are melted down with pyrites in a cupola blast furnace for regulus or *matte*, which is then treated as the ore.

The advantages of this process are manifold; 1stly. Ores containing large amounts of arsenic can be thus successfully treated, when Ziervogel's process would fail. 2ndly. The expense of heating a strong solution of salt, as in Augustin's process, is got rid of, as the hyposulphite is used cold. 3rdly. The hypo-sulphite filters quicker and better than the brine in Augustin's process, for the dissolving power of hyposulphite being great, a weak solution may be used. 4thly. The solution of hyposulphite may be used over and over again, for it is being continually renewed, and as this is one of the peculiar points in the process it deserves particular attention. The precipitation of the silver is effected, as has been before stated, by sulphide of sodium, and this is a polysulphide, for it is prepared by calcining soda with sulphur and then boiling it with sulphur. In this manner a polysulphide of sodium is formed, but in contact with the air some hypo-sulphite of soda is generated, and thus, each time that the silver is precipitated, some hyposulphite of soda is added to the solution. In this way Herr von Patera, who commenced with 14 lbs. of hyposulphite of soda (and who yearly extracts more than 3000 lbs. of silver), has never needed a fresh supply, and has, in fact, been obliged to throw away quantities of solution, as his stock was always increasing. The expense of this process is not great; the extraction of a pound of silver from the ore costs, on an average, only 9s. 9d., whilst by the method of smelting formerly in use, the cost of production of a similar quantity of metal was no less than 16s.

INSTITUTION OF CIVIL ENGINEERS.

November 27, 1860.

JOHN HAWKSHAW, Esq., VICE-PRESIDENT, IN THE CHAIR.

The Paper read was "On the Maintenance and Durability of Submarine Cables, in Shallow Waters," by Mr. W. H. Preece, Assoc. Inst. C.E.

Referring to an opinion expressed by the late Mr. Robert Stephenson, unfavourable to the durability of Submarine Cables, the Author hoped, by detailing his own practical experience in the maintenance of the Cable connecting the Channel Islands with England to elicit a discussion which, by tending to solve that important question, might prove beneficial to the Profession, and serviceable to the progress of Submarine Telegraphy.

The geographical position of the Channel Islands, their rocky and rugged structure, and their exposure to storms, the strong currents by which they were swept, and the nature of the bottom of the sea by which they were approached, were fully described; and it was stated that they were all calculated to try, to the utmost extent, the qualifications, for permanence and durability, of a submarine cable connecting these islands with the main land. The Channel Islands Telegraph Company was formed under the Limited Liability Act, with a capital of £30,000, and a conditional guarantee of 6 per cent. from Government. The contract for the whole undertaking was let to Messrs. Newall and Co., who had submerged the cable, constructed the land lines, and handed them over to the Company, before the author was appointed Engineer. The route and con-

struction of the line, submarine and underground, from Weymouth, through Alderney, and Guernsey, to Jersey, and its excellent working condition, were then described. The whole length of submarine cable submerged was 93½ miles. The length of underground work was 23 miles. The underground work consisted simply of a gutta-percha covered wire, coated with tarred yarn, and laid in a creosoted wooden trough, buried about 20 inches in the ground. The cable comprised two portions—the sea part and the shore ends. The sea part was a No. 1 gutta-percha covered wire, served with tarred yarn, and protected by ten No. 6 iron wires. It weighed 2½ tons to the mile. The shore ends were similar, but were protected by ten No. 2 iron wires. They weighed 6 tons to the mile. The line was opened to the public in September, 1858.

The interruptions which had occurred to the working of the line, and the plans adopted to remedy the defects, were then successively enumerated. In approaching rocky shores, swept by fierce currents, and in landing the ends upon such points, great care was required to avoid danger. It was also necessary to protect the cable from detrimental exposure to the surf, spray, and atmosphere. The chief accidents to this cable had been peculiar, and were different to all previous ones with other cables, which were the result of well known causes. With the exception of one instance, these accidents arose quite unexpectedly, without any previous symptom of weakness or decay having been given. Since the submersion of the cable, in August, 1848, the cable had been ruptured in eleven different places. Two of these accidents were the results of carelessness in landing the end of the cable on the Jersey shore; four were caused by ships dragging their anchors: and five were produced by the abrasion of the slender wire upon the rocky bottom. The accidents arising from ships' anchors took place between Jersey and Guernsey. Those resulting from abrasion occurred between Alderney and Portland. Between Guernsey and Alderney there had not been a single failure. The constant interruptions of this line were attributable to two causes—weakness of cable, and error of judgment in selecting the route pursued.

Although the cable was in the Author's opinion too weak, yet he did not attribute the failure of the system, so much to that cause, as to the route selected. In justice to those who laid the cable, it should be known, that if reliance had been placed on the Admiralty Charts, there was an explanation of the reason why this particular route had been chosen. But, unfortunately, in describing the nature of the bottom, these official charts were altogether incorrect, as they not unfrequently showed rock where sand was found, and sand and gravel where there were rocks. Cables should, however, never be trusted to the unseen and unknown action of the bottom of the sea, without the course having first been most carefully surveyed.

The author next proceeded to point out the oxidation and decay of the cable in different localities; showing how, in sand and mud, when it had become buried, it was in perfect preservation, while on rocky ground, where swept by the tides, it was being rapidly corroded. The extra difficulty and expense in repairing decayed cables, and the necessity of retaining their strength unimpaired, were adduced as imperative reasons for adopting some outer protecting coating to the present form of submarine cables.

In designing a cable, its durability and maintenance should be primarily considered. The present heavy cables were believed to have been erroneously constructed; and it was recommended that in future the outer wire of cables should either be stranded, or else be surrounded with two servings of smaller sized wires.

The plan adopted in repairing the numerous breaks to the Channel Islands cable was then described. The system of grappling, buoying, picking up, &c., having been previously brought before the Institution (*vide Minutes of Proceedings*, vol. xvii., p. 262), allusion only was made to the method adopted in testing, and in calculating the distance and position of faults and breaks. This could now be accomplished with such accuracy, that instances were mentioned, in which Messrs. Varley, G. Preece, and the author, had indicated the exact spot of faults, though 30, 50, and 60 miles distant. The principles employed in testing were divided into two classes, according as they were dependant upon the laws of resistance, or upon the laws of induction. The basis of all resistance

tests, was the fundamental law of Ohm, expressed by the formula, $R = \frac{L \cdot C}{S}$, where R was the resistance, L the length of the wire, C the specific resistance of the material employed, and S the sectional area. The advantage of expressing, in units of resistance, the insulation and conduction of substances, was considered. The construction of resistance coils, the various standards of resistance employed by different individuals, and the manner in which one standard could be reduced to another, were described. The instruments employed in measuring resistances,—the differential galvanometer of Becquerel, Wheatstone's parallelogram, and the author's "Multiplying Differential,"—were then noticed. By the last instrument, resistances could be measured from small fractions to high multiples. From the standard coils attached to it, the resistance of any other standard, or any cable, could be read, without going through the usual arithmetical calculation. Another system by which much higher multiples could be read was shown.

The laws of induction were next considered, and their various formulæ given; showing how the charges and discharges, in different wires, were regulated, and could be compared. The basis of all induction was the law expressed by the following formula, $C = \frac{n \cdot S \cdot R \cdot s}{d}$, where C was the induced charge, n the battery

power, S the surface of the wire, R the resistance of the conductor, s the specific inductive capacity of the insulator, and d the ratio of the distance between the inside and the outside coatings. The difference between discharge and return current was pointed out. The instruments employed in measuring and registering the discharge were described, including the author's "Reduction Inductometer," which could measure the discharge of any wire of any length, from one mile and upwards. The errors that tests were liable to, such as the resistance of ends and faults, and the occurrence of partial faults in different localities, with the plans adopted to detect and allow for these discrepancies, were fully de-

tailed. The various kinds of faults to which a cable was subject, were then adverted to.

In conclusion, it was remarked, that there was no imperfection which could not be detected and no accident which could not be provided against. But when experience was ignored, and when the errors that had been committed by those who had hitherto had the control of Submarine Cables, were considered, it could not be wondered at, that opinions should be expressed unfavourable to the progress of Submarine Telegraphy.

December 18, 1860.

GEORGE P. BIDDER, Esq., President, in the Chair.

ANNUAL GENERAL MEETING.

In presenting an account of the proceedings during the last twelve months, it was remarked, that the principal duty of the Council had been to carry out, and persevere in, the practice and regulations established during previous years, which had been found to contribute so much to the steady growth and increasing importance of the Institution.

On this occasion a short account was given of the state of engineering in a few distant countries, and, particularly, in some of the British Colonies; because those undertakings might not be generally so well known, and because attention had previously been chiefly directed to engineering progress in the United Kingdom, and on the continent of Europe.

At the Cape of Good Hope, a railway, the first undertaking of the kind in that colony, had been commenced, which would run from Cape Town, through Stellenbosch, to the Paarl and Wellington, a distance of about 58 miles. The first section of this line would, it was expected, be opened shortly. At Cape Town arrangements would be made to connect the railway with the harbour works now being carried out, under an Act passed by the Colonial Legislature, in 1858. These works comprised a pier, or breakwater, running from the western shore of Table Bay, in a north-easterly direction, for a length of 3250 feet, which would provide refuge accommodation, and commercial facilities, at an estimated cost of £400,000. In order to procure materials for the breakwater, which would be formed by a rough rubble mound, a basin was to be excavated having an area of 10½ acres, with a depth of 20 feet at low water of spring tides; and there would be about 4100 feet of quays. An outer basin, 4¼ acres in extent, would be available for trade, it was thought, in about two years and a-half.

The principal engineering works in progress in Australia were roads, telegraphs, and railways. Telegraphic communication was established between the capitals of the three colonies, and Tasmania had been connected by a submarine cable which was now unfortunately damaged, between King's Island and the Hummocks. The telegraph wires, which were carried overground, might be seen wherever there were towns, as would be gathered from the statement that there were now 1000 miles in operation in Victoria, about 1000 miles in New South Wales, and nearly 500 miles in South Australia. The railways, with the exception of two or three short lines near Melbourne, all belonged to government, and had been carried out by means of loans; the only private undertaking of any magnitude, the Geelong and Melbourne line, having lately been purchased by government for about £750,000, at par. In South Australia, a proposal had recently been made to inaugurate a fresh policy. Two new railways were projected—a short suburban line, to which it was proposed to give a limited guarantee; and a more important line, towards which a donation of land was offered. Unfortunately, a uniform gauge had not been adopted, as it should have been in all the colonies; for, whilst in Victoria and in South Australia, the rails were laid to a gauge of 5ft. 3in., in New South Wales the gauge was 4ft. 8½in. This was likely to cause considerable inconvenience in the future, when the main trunk lines to connect the capitals of the respective colonies were completed.

The railways in progress in New South Wales were:—1, The Great Southern; 2, the Great Western; 3, the Great Northern. The Southern, or main trunk line from Sydney, ultimately intended to join the Victorian system of railways at the river Murray, had been opened as far as Campbelltown, a distance of thirty-four miles. Up to Paramatta, 13½ miles, there were two lines of way, and beyond, only a single line. A further length of twenty miles, as far as Picton, was expected to be completed in a few months. The cost of the double line, including rolling stock and machinery, and workshops at the terminus, had amounted to upwards of £40,000 a mile, and of the single line about £10,000 a mile. Trial surveys had been made, and estimates prepared of the cost of extending this line to Goulburn, from which it appeared that the natural difficulties were such as would necessitate an expenditure greatly in excess of that hitherto incurred.—The Western, starting from the Southern, 1½ mile west of Paramatta, was opened as far as Blacktown, on the Windsor-road, a distance of 8 miles, in August last. The cost had averaged about £10,500 a mile of single line. The works were now in progress up to Penrith, a further distance of 12 miles. This line was at present proposed to be carried to Bathurst, and extensive surveys and explorations had been made of the country between the Hawkesbury and that place, including the valley of the Grose, in order to discover a practicable route by which to pass the range of the Blue Mountains.—The Northern Railway started from Newcastle, about 60 miles north of Sydney, between which places there was steamship communication daily. The line was opened two years ago to East Maitland, and subsequently to West Maitland, a distance of 20 miles; and in August last to Lochinvar, a further length of 8 miles. From Lochinvar to Singleton, 23 miles, the works would be finished in the middle of 1861. The expenditure had amounted to about £12,000 a mile of single line. The country was under survey beyond as far as Muswellbrook, 70 miles. It abounded in minerals, particularly in coal, from which all the Australian colonies, as well as India and China, might be supplied.

In the thriving colony of Victoria, the railways now open were the Geelong and Melbourne, a single line, 40 miles long, passing through a level country, in connection with which there were extensive piers and wharves at Williamstown,

the port of Melbourne. Also the Suburban Railways, which had been constructed by private companies, in whose hands they still remained. These were:—1, Melbourne and St. Kilda; 2, St. Kilda and Brighton; 3, Melbourne to Richmond, Hawthorne and Brighton; and 4, Melbourne and Hobson's Bay, a double line, 3 miles in length. The great lines to the interior were:—1, Melbourne and Mount Alexander, to Castlemaine, Sandhurst, and Echuca, on the river Murray, a length of 152 miles. The main line had been opened to Sunbury, 22 miles, and also the branch to Williamstown. The portion of the line from Sunbury to Woodend, 28 miles, was expected to be finished early next year. 2, Geelong and Ballarat, a length of 53 miles, of which no part is yet open. The estimated cost of these two lines, both of which would consist of a double way, was seven millions (upwards of £34,000 a mile), of which three millions sterling had been already raised and expended. With respect to the general character of the country, it was described as rising regularly from the coast to the dividing range,—with the exception of one sudden step of 300 feet,—to a height of about 2000 feet in 40 miles. There were occasional chasms, or ravines, 100 to 500 feet in depth, and 660 to 3300 feet in width, through which the water falling on the higher ranges was discharged with impetuous velocity. But there was a total absence of those great leading valleys which were found in England. The larger rivers, creeks, and ravines had been crossed generally by viaducts constructed with abutments and piers of bluestone masonry, and wrought-iron superstructures. The permanent way was of the most substantial character, consisting of a double-headed rail, weighing 80lbs. per yard, fished, and laid in chairs in the ordinary way, on native timber sleepers.

In South Australia, a double line of railway, from Port Adelaide to Adelaide, a distance of 3½ miles, had been opened for three or four years, and a single line from thence to Gawler, 29 miles, for two years and a half. From Gawler to Kapunda, 16 miles, the line was opened this year. It was proposed to extend this line northwards.

The oldest railway in Canada, a short line called the Laprairie and St. John, was opened for traffic in July, 1836. From that period until the year 1849, little progress was made in the extension of railways. At the commencement of 1857, there were 1402 miles of line in operation, and at the present time the mileage was 2093, and the number of railways fifteen, all which, with one exception, had been constructed between 1852 and 1860. The three principal lines were the Buffalo and Lake Huron, the Great Western, and Grand Trunk. They ran longitudinally through separate divisions of Canada, and were constructed with a view to secure a share of the large traffic in passengers, goods, and agricultural produce, which found its way from the Western States to the Atlantic seaboard, and *vice versa*. The Welland Railway (25 miles long), was constructed two years ago, mainly for the transportation of grain in bulk, and heavy goods, in opposition to the Welland canal, which had an ascent of upwards of 300 ft. of lockage to overcome between Lakes Ontario and Erie. All the other lines depended chiefly upon local traffic. The Canadian railways had nearly all a uniform gauge of 5ft. 6in., and were all single lines. The average cost per mile of the main lines had been about £15,000, inclusive of rolling stock and other expenses. The cost of the branches had ranged from £6000 to £10,000 a mile. The bridges were generally built of timber, which it was thought cheaper to renew every ten years than to build at first in stone or iron. But on the Grand Trunk, the bridges consisted chiefly of tubular iron girders, and on the Great Western main line there were also some wrought-iron bridges.

The capital embarked in Canadian railways amounted at present to about £26,000,000 sterling, of which £4,161,150 might be considered as the contribution of the province of Canada, inasmuch as the interest on that amount (£249,669) was an annual charge upon its revenue.

The only other Engineering works constructed in Canada during the last few years, were the deepening and improvement of the river St. Lawrence, between Montreal and Quebec, the erection of lighthouses in the Gulf of St. Lawrence, and works for the supply of water to Quebec, Montreal, and Hamilton.

During the past three or four years, there had been great stagnation in the extension of railways in the Northern and West States of America. In Michigan, the Grand Trunk (of Canada) had constructed 55 miles, and the Great Western (of Canada) had contributed largely towards the completion of the Detroit and Milwaukie Railway, 186 miles in length. The other American railways in progress at present in the North Western States were all westward of Chicago, and had all the common object in view of opening up new territories west of the Mississippi and Missouri rivers.

In Russia, the St. Petersburg and Warsaw Railway was commenced, as a government undertaking, about the year 1851; but in 1856 it was ceded, with others, to the Grand Russian Railway Company. The length of this line was about 670 miles, one half of which was completed, though many of the works were merely temporary. A branch to connect this line with the Berlin-Königsberg Railway was being vigorously pushed forward, and the portion to the Prussian frontier was already open for traffic. The Riga-Dunaberg Railway, 140 miles long, running from Riga towards the producing districts, and by its junction at Dunaberg with the Berlin and Warsaw Railways, connecting Riga with the network of European railways, was rapidly approaching completion; the earthworks and permanent masonry having almost all been completed before the close of the last season. The Moscow and Nijni Novgorod line, which would connect the western ports with the extreme European end of that vast Empire, by means of those important thoroughfares for goods, the rivers Kama and Volga, was making rapid progress, and one-half of this line was expected to be ready for traffic next summer.

The improvements which had been made in the iron manufacture during the last few years, and the changes that were now taking place, were then referred to; and it was stated that the result had been, that whereas the annual "make" of a blast furnace in the year 1750 was only about 300 tons, now it ranged from 5000 to 10,000 tons per annum; and, in a few cases, amounted even to 15,000 tons per annum. In reference to wrought iron, it was said that the plan of

reversing the rolls had been considerably extended, and occasionally a second pair of rolls was placed close to the first, running continuously in the opposite direction, so that the iron could be rolled either in coming forward, or in going back. Plates $1\frac{1}{2}$ in. thick, by 3 ft. wide and 20 ft. long, and plates $4\frac{1}{2}$ in. thick by 3 ft. wide and 15 ft. long had been rolled, as well as bars up to 72 ft. long. Most of the improvements in the manufacture of steel had been introduced within the last half-century. Cast steel bells, weighing 53 cwt. each, had been made in this country, and castings of steel weighing 100 cwt. in Austria. Large plates and very heavy bars had also been made of puddled steel, produced direct from cast-iron; and, lastly, steel wire, when hardened to about a deep blue temper, was found capable of carrying 130 tons per square inch. More than one process had been used in the production of cheap steel, which had been found by recent experiments to possess nearly double the strength of ordinary iron, accompanied by other valuable properties. With regard to the applications of iron, a new era commenced with the construction of the Conway and Britannia bridges; as the elaborate experiments made prior to their construction tended to prove that previously received theories were in some respects erroneous. Again, the building erected for the Great Exhibition in 1851, from its lightness and security, called attention to the hitherto undeveloped capabilities of the combined use of cast and wrought-iron for such purposes.

The improvements in the Artillery and Projectiles of the present day, which had resulted from the efforts of Civil Engineers, were calculated to lead to important changes in modern warfare. Simultaneous with the rapid advance in the destructiveness of weapons of offence in attack, there was a necessity for a corresponding alteration in the means of resistance. These subjects had led to elaborate researches and experiments for ascertaining the best qualities of metals to resist the enormous strains and concussion which had to be encountered, and the best dispositions in which to employ them. Iron-coated ships had for some years been regarded as a probable coming necessity; but it was not until about the end of the year 1858, that the Admiralty for the first time seriously considered the subject. This resulted in the designs on which the *Warrior*, and *Black Prince*, were now being constructed. The problem was one of great difficulty. An enormous weight of armour had to be added to the weights hitherto carried. At the same time greater speed was demanded, and that involved increased weight of engines and a larger supply of fuel. Then, again, the weight was top-weight and wing-weight, which had to be carried on fine lines for speed. To reconcile these conditions with the practical points in a war vessel, and to give such a ship good seafaring qualities, to make her a good cruiser, and also well-suited for a voyage, and for the probable conditions that would attach to a European war was a problem which might well employ the professional skill of naval architects, and of every Member of the Institution.

The principal papers read during the session were then noticed; and it was remarked that there were still many important executed works, some even possessed of great novelty, which had not yet been brought forward at the meetings. It was hoped that accounts of these undertakings would still be brought before the members. The intense interest which the discussion upon Mr. Longridge's paper "On the Construction of Artillery" excited, was referred to. On this occasion Sir William Armstrong and Mr. Whitworth—Members of Council—each exhibited a 12-pounder gun on his system, described its mode of manufacture, and explained its working; and the Council thought that both these gentlemen were entitled to the best thanks of the Members.

It was stated that the library was now occupying the attention of a Committee of the Council, with a view to ascertain what was required to render it as complete a collection as possible of works on engineering and the allied sciences, as well as of books of reference on general scientific subjects. The Members were urged to assist in procuring copies of all treatises, reports, and documents relating to professional matters; as this was the natural place for their reception and preservation, where they could be consulted by all. At the same time steps were being taken to have completed the set of the Ordnance maps of the United Kingdom, and to procure copies of the maps illustrating the geological survey of the British Isles and the trigonometrical survey of India. Endeavours were also being made to obtain copies of the reports of all the different Railway Companies, as such a collection would be, it was believed, of great interest and value.

The deceases during the year were:—William Alers Hankey, Honourary Member; William Blackadder, Terence Woulfe Flanagan, Colonel William Niarne Forbes, B.E., Robert Grundy, Joseph Locke, M.P., Charles May, Joseph Miller, Thomas Penson, Robert Berthon Preston, John Geale Thompson, William Francis Isherwood West, and Francis Mortimer Young, Members; Captain William Fullarton Lindsay Carnegie, R.A., Lieut. Edward Fraser, B.E., Robert Hughes, James Wardrop Jameson, William Sayce, William Simms, and Archibald Slate, Associates.

The resignations of one Member and five Associates were announced. The number of members of all classes now on the books was 930, being an effective increase in the year of 36.

By the death of Mr. Locke, the Institution was deprived of the services of a valuable and influential member, who was most solicitous to do all in his power to advance the common interests, and to maintain the dignity and social position of the profession. The suddenness of his removal, while in the enjoyment of apparently sound health, and following so immediately after the deceases of his friends Brunel and Stephenson, tended to render this loss even more severely felt.

The abstract of accounts showed that the receipts for subscriptions and fees amounted to £2550, and the expenditure to £2100, the outlay for Minutes of Proceedings being much less than in previous years. There being thus a balance in favour of the Institution, in addition to the £1000 already placed on deposit at the Union Bank, it was thought advisable that an investment should be made, and accordingly £1100 Norfolk Debenture Stock bearing 4 per cent. interest was purchased. During the recess the Stephenson and the Miller Bequests of £2000 and £3000 respectively had been received. Thus, the funded property of the Institution now amounted to upwards of £12,000; in addition to which there was a further sum of £2000 to be received under the will of the late Mr. Joseph Miller in which a relative had a life interest.

It was thought, that so munificent a benefactor as Mr. Miller deserved some memorial; and it was considered that none more appropriate could be devised than a portrait to be placed on the walls of the meeting-room. The Council had confided the task to Mr. Boxall, A.R.A., who would, it was presumed, produce a good picture of our late member.

In conclusion it was observed, that the steady progress which had marked the career of the Institution from its commencement, and the estimation in which it was held both at home and abroad, should induce the members of all classes, by unanimity and energy, and by earnest co-operation, to study to maintain its high reputation, and to increase its sphere of usefulness.

After the reading of the Report, Telford Medals were presented to Messrs. J. A. Berkley, and R. B. Grantham; a Watt Medal to Mr. J. A. Longridge; Council Premiums of Books to Messrs. E. L. Williams, E. B. Webb, F. C. Stileman, J. R. Walker, and D. K. Clark; and the Manby Premium, in Books, to Mr. J. A. Longridge.

The thanks of the Institution were unanimously voted to the President for his attention to the duties of his office; to the Vice-Presidents and other Members and Associates of Council, for their co-operation with the President, and their constant attendance at the meetings; to Mr. C. Manby, Honorary Secretary, and to Mr. James Forrest, Secretary, for the manner in which they had performed the duties of their offices; as also to the auditors of the accounts and the scrutineers of the ballot, for their services.

The following gentlemen were elected to fill the several offices on the Council for the ensuing year:—G. P. Bidder, President; J. Fowler, C. H. Gregory, J. Hawkshaw, and J. R. McClean, Vice-Presidents; Sir William Armstrong, J. Cubitt, J. E. Errington, T. E. Harrison, T. Hawksley, G. W. Hemans, J. Murray, J. S. Russell, G. R. Stephenson, and J. Whitworth, Members; and Capt. Galton, R.E., and H. A. Hunt, Associates.

The meeting was then adjourned until Tuesday, January 8th, 1861, when the Monthly Ballot for Members would take place, and the discussion upon Mr. Preece's Paper, "On Submarine Telegraph Cables," would be resumed.

CORRESPONDENCE.

We do not hold ourselves responsible for the opinions of our Correspondents.

IRON-PLATED SHIPS OF WAR.

To the Editor of THE ARTIZAN.

SIR,—The following letter was addressed to the Editor of *The Engineer*, and intended for the columns of that journal. As it has not yet appeared, and bearing as it does directly upon the subject of your article in last month's number, will you do me the favour to find space for it in the *ARTIZAN* for January 1st?

Yours respectfully,

A—C—.

To the Editor of THE ENGINEER.

SIR,—I have been a reader of your Journal since its commencement, and I am also a reader of the *ARTIZAN*. I have, therefore, seen the articles on "Iron-plated Ships of War," which have appeared in both, and have studied them with considerable interest. In your article of Nov. 16th you couple Mr. Jones with some other "inventors (!) of the inclined side." I am one of these inventors. In the week that the Allies landed at Eupatoria, I forwarded drawings of my plans to the Admiralty; but I am not one of the dozen known to you, who have received absolute promises from the authorities that their plans shall be carried out; indeed the only answer I received was a formal one, that my plans would not be of use to the Service. The rejection of my proposals was not a refutation of the principles on which they were founded, and I have always been confident of their adoption as the basis of our naval defences. Although I have no pecuniary interest in the question beyond that levied on me for income-tax, I have taken it upon me to defend the principle of the inclined side in opposition to your articles, if you will give me space in your columns.

This is the first time I have advocated publicly this principle, and I would not have intruded on your space now had your article of Dec. 7th dealt fairly with the answers given in the *ARTIZAN* to your objections, formerly urged. I must confess that I did not perceive the absurdity you have discovered in the recommendation to adopt the best plan, whether the sides be vertical or inclined, for in yours of Nov. 16th I find the following:—"It seems to us incredible that the Government can even entertain the project of building frigates with sides tumbling home at angles of 40° or 50°." Let us suppose, now, that in an American paper we read—"It seems to us incredible that the citizens of the United States can even entertain the project of raising a negro to the Presidency." Then, suppose another paper to comment upon the statement in these words—"So far from sharing these sentiments, we, on the contrary, would urge the election of the best man, whether his skin be black or white." Would you think the comment at all an absurd one? that in the *ARTIZAN* is quite as reasonable, for you have rejected the inclined side for about the same reason that a Yankee would reject a black president, merely because he is black. Every objection to the inclined side can be removed but

one, which is apparently the greatest one in your eye—the simple fact that they are inclined. But it is not upon such quibbles that I propose to argue the question.

You say, on December 7, "It is well known that Mr. Jones and others claim, as the primary advantage of the inclined side, its enormous power of resisting shot, as compared with the upright side. To show that this advantage is illusive, we pointed out the fact that a given height of side must be defended, and that, weight for weight of metal, the thickness of the metal must decrease with the inclination, the rate of this decrease being pretty nearly identical with that of the decrease of the rending force of the shot." I am not known to Mr. Jones, but as one of the others who claim this advantage for the inclined side, I am also ready to defend the assertion. If the ball were indestructible and incompressible, and if the plates had the same qualities, the force of impact of the ball would be as the square of the sine of the angle of incidence, and the ball would fly off at an equal angle with undiminished velocity, having been but an instant in contact with the plate; its action on the plate would have no *duration*, and would be confined to one spot of the plate. But neither ball nor plate have these qualities; both are compressible and then destructible. The action is not confined to an *instant*, but has the quality of *duration* measured by the time the ball takes to make the indentation on the plate. When the ball first strikes the plate, it is that part of its motion only which is perpendicular to the surface which tells on the plate,—that component is measured by the sine of the angle of incidence; but the other component, which is parallel with the surface and is measured by the cosine of that angle, is unaffected at first by the impact, and carries the ball over the surface of the plate during the impact, thus distributing the effect of the shot; and in this is the success of the inclined side. I do not know to what "Mr. Jones and other inventors" may have looked for success; but this is the feature which always satisfied me of its final adoption, and this advantage is quite independent of and in addition to the other, in which you admit that the rending force of the ball will be the same upon equal weight of plate in equal height, whatever be the inclination of the side. It must be apparent, then, that a distribution of this force over a considerable surface must neutralize the destructive effect of the shot. Reasoning, as you apparently do, on mathematical grounds, and resolving the force of the ball according to the parallelogram of forces, you fail to perceive any advantage in the inclined side, because that process of reasoning supposes one component of motion to be merely harmless, by reason of its being parallel to the plate; but if you examine the question as an engineer, you will find that the inclined side goes a step beyond this, and turns this component of the motion to good account, employing it to carry the ball over the surface during impact. It is only during the first instant that the angle of incidence is that of the motion of the ball, because any work done upon the plate destroys an equivalent part of the velocity of the ball in the direction in which that work is done. The velocity destroyed is part of that represented by the sine of the angle of incidence. This is the destructive component of the original motion of the ball, and this must be entirely destroyed by the plate. Here the other component comes into action, and carries the ball over the surface during impact; whereas on the vertical plan the horizontal shot strikes perpendicular to the surface, and its destructive effort is concentrated on one spot of the plate.

How much will you allow as the amount of this advantage? I consider it to be under-estimated when we attribute to it a reduction of the destructive effect of the shot in the ratio of the sine of the angle of incidence. Much will depend upon the nature of the material both of ball and plate; for if both were of tempered steel the impact would be instantaneous, and there would be no appreciable translation of the ball. As the sine of the angle of incidence to a horizontal shot is inversely as the area of surface on the incline to unity of surface placed vertically, we may define this advantage thus: *With equal weight to equal height, the power of resisting a single shot will be as the areas of the surfaces.* But it is not by a single shot that these plates will be penetrated, but by repeated impacts and concussions. The total effect of these will be measured by the number of concussions received per square foot of plate. You say that an equal height is to be defended in either case, therefore the visual area will be the same in each. The number of shots which will take effect will be directly as the visual area, or the same in each. The concussions per foot of plate will be inversely as the area of surface: therefore in an action the impenetrability of plated vessels will be still further increased in the ratio of the area of their surfaces; or, including the principle of translation, the impenetrability of the structures will be as the squares of their surfaces. If two vessels were constructed, one with vertical sides, the other with a tumble home of 50°, with equal height and equal weight of sides, the angle of incidence will be 40°, and the ratio of surfaces would be 1.55 to 1; this would be the ratio of impenetrability to a single shot, and in an action the impenetrability would be as the square of this, or as 2.4 to 1. But in this estimate I have supposed equal weight in equal height; but this does not amount to equal weight per foot of the length of the vessel, for by inclining the sides we are reducing the breadth of the deck; and if the lives of our men are to be protected, as well as the hulls of our vessels,

we must have a bomb-proof deck; and the reduced breadth of the decks of the vessel with the inclined side would render that vessel of *less weight* per foot of length. If the vessel have 60 feet beam and a height of 12½ feet above the water, the tumble home would reduce the breadth of top deck to 30 feet; and from the reduced length of deck beams, this deck could be rendered bomb-proof, with the same weight as the ordinary deck of the vertical side. Therefore a vessel can be constructed with inclined sides which will have only the same weight per foot of length as those with vertical sides, and possess in an action about 2½ times the indestructibility of hull, and have a bomb-proof deck. Again, with vertical sides, when a plate is broken, the pieces either fall off, or the next shot which strikes them drives them through the side of the vessel; but with the inclined side the pieces would not fall off, and they cannot be driven through the side, for the cracks are always at right angles to the surface of the plate; and although they were laid on the packing loosely, as paving stones, with an upper and lower course attached, with equal weight to equal height, they would still have a great advantage over the vertical system.

I write in behalf of a principle; and I hope that if my views meet with opposition in your paper, that opposition will manifest the same spirit.

A—, C—.

"GEOMETRY OF THE SLIDE VALVE."

(*vide Plate No. 186.*)

To the Editor of THE ARTIZAN.

SIR,—Whilst thanking you for the notice you have taken of my humble communication, I ask pardon for having, through an error in a former construction, made a wrong statement in my last letter, viz., the difference between those given by the diagram and actual measurements. I stated it to be greater than I have since found to be the case, on striking out afresh a new one. The error was my carelessness in taking *half* the length of connecting-rod and eccentric-rods, as radius, instead of the whole length. The amended diagrams I beg to enclose. With reference to the differences which appear between the enclosed and actual measurements, I may state, that, considering the measurements were not *my own*, but given to me by the "out-door engineer" who took them; that a slight want of carefulness, on his part, combined with the extreme smallness of the scale, sufficiently account, to my mind, for the differences; and that I regard the "Great Circle Diagram" as decidedly the best exposition of the movement of the slide valve which has hitherto come to my notice.

I am, Sir, yours very truly,

AMATEUR.

December 11th, 1860.

[Our Correspondent wrote last month, complaining that he had applied Mr. Gray's mode of constructing and setting the valve-gear of two small engines, but that he had failed to apply it successfully; whereupon we forwarded this letter to the author, which has produced the explanation to be found in Mr. Gray's letter (and the illustration accompanying it), and above is our correspondent's reply. We are glad to perceive that he is now satisfied of the correctness of Mr. Gray's views, and of the practical value of the series of papers we have published. The following is Mr. Gray's letter.—ED. ARTIZAN.]

To the Editor of THE ARTIZAN.

"Amateur" writes with reference to the accuracy of the *Great Circle Diagram*, "It is mathematically correct, but in practice its apparent accuracy will only be proportionate to the care with which the construction is made." Constructions for three sets of dimensions have been forwarded: instead of referring to all of them it will be better to examine the one which shows the greatest discrepancy. The dimensions of that are—

	ft.	in.
Stroke of piston	4	6
Travel of valve	0	7
Steam lap, mean	0	2½
Lead	0	0½
Connecting rod	7	6
Eccentric rod	10	9
Exhaust lap	0	0½

The engine is a horizontal one with short piston rod, and the valve is worked by an intermediate lever. In the diagram constructed by "Amateur" there is no lead shown at the back port, and the steam lap is drawn of equal amount at each end of the valve, whereas the lead was one-eighth of an inch at each port, and with equal lead there must be some difference between the laps: its amount can be determined thus:—

$$\frac{2\frac{3}{8} \times (7 - 2\frac{3}{8})}{129} = .085, \text{ or } 1\text{-}12\text{th of an inch.}$$

If he constructs another diagram, taking these into account, he will succeed; but the positions measured from the engine are not correct for the dimensions given. An example of the calculation of these positions will not be out of place here.

In the December number of this journal, rules were given for this computation, but that given for the exhaust points is unnecessarily tedious: it is perfectly correct, but there is an approximation which does not sensibly differ from its results: it should have been introduced there; it is this:—

$$x = \frac{1}{2} \left\{ 1 - (\sqrt{1 - C^2} + Cl) \right\}$$

$$y = \frac{1}{2} \left\{ 1 - (\sqrt{1 - C^2} - Cl) \right\}$$

Or, in words:—The distance from the middle of the stroke at which the exhaust opens is half of the square root of (the difference between 1 and the square of the COVER) added to half the product of (the COVER multiplied by the exhaust lap).

And the distance from the middle of the stroke at which the exhaust shuts is found thus:—Deduct half the product of (the COVER multiplied by the exhaust lap) from half of the square root of (the difference between 1 and the square of the COVER).

$$c = \frac{2\frac{3}{8} + \frac{1}{16}}{3\frac{1}{2}} = \frac{2.4375}{3.5} = 0.696$$

$$0.696^2 = 0.4844 \times \frac{26.157 + 5.4}{5.4} = 4.047 = \frac{30.204}{26.1424} = \frac{27.89}{22.110} = z \text{ on backward stroke.}$$

$$180 \times \frac{27.89}{22.110} = 22.110 = z \text{ on forward stroke.}$$

Before calculating the exhaust points, the exhaust lap must be corrected for obliquity of eccentric rod.

$$\frac{5}{32} = 0.1562, \quad 3.5 + 0.1562 = 3.6562$$

$$\frac{3.6562 \times (7 - 3.6562)}{258} = 0.0474$$

$$0.1562 + 0.0474 = 0.2036 = \text{value of exhaust lap on front port.}$$

$$0.1562 - 0.0474 = 0.1088 = \text{ditto ditto on back port.}$$

$$C = \frac{2.5}{3.5} = 0.714, \quad \text{or } \frac{0.2036}{3.5} = 0.582 \text{ on front port.}$$

$$l = \frac{0.1088}{3.5} = 0.0311 \text{ on back port.}$$

CALCULATION FOR FRONT PORT.

$$0.714^2 = 0.5097$$

$$1 - 0.5097 = 0.4903$$

$$0.700 = \sqrt{0.4903} = 0.700$$

$$0.0415 = 0.714 \times 0.0311$$

$$1 - 0.7415 = 2) 0.2585$$

$$0.12925 \times 2 = 0.2585$$

$$54 - 6.9768 = 47.0232$$

$$180) 328.07$$

$$\frac{1.823 + 6.977}{180} = 0.0415$$

$$x \text{ on backward stroke} = 8.800$$

$$1.0415 - 0.700 = 2) 0.3415$$

$$\frac{0.1707 \times 54}{54} = 0.1707$$

$$\frac{9.2178 \times 54}{54} = 9.2178$$

$$54 - 9.2178 = 44.7822$$

$$180) 412.79$$

$$\frac{2.2939 + 9.2178}{180} = 0.0623$$

$$y \text{ on forward stroke} = 6.9239$$

CALCULATION FOR BACK PORT.

$$0.700$$

$$0.022 = 0.714 \times 0.0311$$

$$1 - 0.722 = 2) 0.278$$

$$\frac{0.139 \times 54}{54} = 0.139$$

$$7.506 \times 54 = 405.324$$

$$54 - 7.506 = 46.494$$

$$180) 348.98$$

$$\frac{1.9388 + 7.506}{180} = 0.0463$$

$$x \text{ on forward stroke} = 5.5672$$

$$1.022 - 0.700 = 2) 0.322$$

$$\frac{0.161 \times 54}{54} = 0.161$$

$$\frac{8.694 \times 54}{54} = 8.694$$

$$54 - 8.694 = 45.306$$

$$180) 393.89$$

$$\frac{2.1883 + 8.694}{180} = 0.0599$$

$$y \text{ on backward stroke} = 10.8823$$

These results may be arranged thus, measuring all the positions from the end of the stroke.

	From Calculation.	From Engine.	From "Amateur's" Construction of Great Circle Diagram.
Forward stroke:			
Steam shut off, z	22.110	22.75	21.5
Exhaust shuts, y	6.924	7.5	6.25
Exhaust opens, x	5.567	6.0	5.0
Backward stroke:			
Steam shut off, z	30.204	31.375	27.5
Exhaust shuts, y	10.882	12.125	9.5
Exhaust opens, x	8.800	10.5	7.5

The calculated results are within one-sixteenth of an inch of the actual positions of the piston for the data given. If "Amateur" constructs another diagram carefully, he will find that it will agree with these. The positions measured from engine are either inaccurate, or the data of the valve are not correctly given.

The illustration, Plate 186, shows, combined in one view, a "small circle diagram" to these dimensions, and agreeing with the calculation, and a test diagram, constructed from the positions measured on the engine. It shows that they are inaccurate, as the chords of the circle must be parallel with each other; but it will be seen they are not so in the diagram. The dotted lines thus are the lines of the test diagram.

These calculations have not been got up to prove the principles of the "Geometry of the Slide Valve," but are presented as examples of their application.

J. MC F. GRAY.

STEAMSHIP CAPABILITY.

To the Editor of THE ARTIZAN.

SIR,—Mr. Atherton's reply to my proposition does not agree with his manifold professions in the cause of steamship economy. This reference to the Reports of the British Association is merely a prevarication. I have searched them, and have failed to discover the best means by which the co-efficient of a bad performance may be improved. It may pertinently be asked, what are the practical uses of a formula, if we cannot by the results enable the naval architect to produce in every steam-vessel the highest practical co-efficient?

It was for this purpose that I asked Mr. Atherton, in the November number of THE ARTIZAN, to assign his reasons for the variation of the co-efficients in the *Miranda*, *Rattler*, *Flying Fish*, *Victor*, and *Pioneer*—vessels nearly identical in form. If Mr. Atherton will supply the public with a direct answer to this problem, or point out how the co-efficients of all steam-vessels may be made to equal 250, his actions will be more in accordance with his manifold professions, and, at the same time, rendering a service to the science of steamship economy.

Yours obediently,

December 21st, 1860.

R. ARMSTRONG, Naval Architect.

NOTICE TO OUR READERS.

We are unavoidably compelled at the last moment to omit the insertion of the "Series of Tables for Calculating the Speed of Steam Vessels," which we promised last month; as also several important papers, reviews and notices of new books, and other matters which have been prepared for the present number.

PLATE 184.

THE PLANS AND SECTION OF THE PACIFIC STEAM NAVIGATION COMPANY'S STEAMSHIPS "GUAYAQUIL" AND "SAN CARLOS."

Having been frequently asked for plans and particulars of these vessels, we have much pleasure in presenting our readers with the large folding plate, No. 184; but, in consequence of want of space, we must defer for the present giving the textual description.

PLATE 185.

The papers "On the Application of Transversals to Engineering Field Works," by Prof. J. Macquorn Rankine; and "On Railway Curves," by Mr. Wm. Froude, illustrated by this Plate, are, from want of space, unavoidably deferred until next month.

NOTICES TO CORRESPONDENTS.

- ERRATA.**—In Plate 185, the two Papers illustrated have the authors' names misplaced: the Paper "On Railway Curves" is by Mr. Wm. Froude, and the Paper "On Transversals" by Prof. W. J. M. Rankine.
- APPRENTICE, C. B. J., and ARGUS.**—Your communications will receive attention before the issue of the next number.
- DELTA.**—We do not know the formula for which you inquire.
- J. (Plasisa, Carnarvon).**—You will find your inquiry replied to.
- J. HART.**—We have frequently given the particulars of the *Rattler's* trials. Look through the back volumes. The mean thrust of screw as shown by dynamometer was about 8000lbs.; it has been stated by us to be 8038lbs., as a mean of five trials made in Yarmouth roads in 1845.
- D. S.**—We believe that Professor Rankine, Mr. Sterling, and other Scotch engineers are still engaged in constructing air-engines, with a view to supersede the use of steam. Mr. Patriek Sterling has promised a paper on the subject of air-engines for the Institution of Engineers in Scotland.
- AMATEUR.**—We hope your inquiries have been satisfactorily answered.
- D.C.L.; ENGINEER, R.N.; J. T. (Paris); T. C. (Ronen); RY. (Havre); and YOUNG ENGINEER.**—Address Mr. Henry Wright, Hon. Sec. Steamship Committee, Salisbury-street, Strand.
- J. M. (Wigan); T. G. (Ormskirk); and D. (Liverpool).**—The three analysts to whom we can recommend you with confidence are, for the liquid and oily matters, Mr. Thomas Keates, F.C.S.; for the metallie investigations, Dr. A. Matthiessen; for the general investigations, Dr. T. L. Phipson—as perhaps having more leisure to devote to the careful consideration of the questions. Dr. R. H. Collyer has had considerable practical experience in connection with the production of paper-makers' stuffs.
- NAUTICUS.**—Apply to Capt. Robertson, Board of Trade, Whitehall. Mr. R. Galloway is the gentleman referred to.
- VAPOUR.**—The engine and machinery referred to were patented by M. du Tremblay, of Paris. They were fitted on board of vessels of various sizes employed on trans-Atlantic and Mediterranean voyages, and in river navigation on the Seine and other rivers in France. It was Mr. Howard, of the King and Queen Works, Rotherhithe, who patented the mercerial steam generator; it was fitted on board the *Mercery*, and tried for a considerable time in the Thames. Mr. A. Smith employed a shallow-metallie bath, traversed by a gradually increasing coil of pipes, terminated at the larger end by a series of steam receivers; excellent economic results were obtained, but they were not successful in constructing sound vessels of a permanent kind for containing the fusible metal, nor could the oxidation of the fusible metal be perfectly arrested.
- SPOUT.**—Such patterns are usually first made in wood; but for the purpose of making clean castings, as well as for sake of economy where large numbers of castings have to be produced, metal patterns are made.
- R. S. and T.; D. CAMPBELL.**—The method of propelling boats for equal and river navigation, by means of chains, has recently been revived by Mr. W. Robertson. He exhibited his plan at the Aberdeen meeting of the British Association. In his boat he has an endless chain set in motion by an engine; it passes over or through the bow and stern of the boat, and is sufficiently long to touch the bottom for about the same length as the distance between the two suspending pulleys fitted on board. He depends upon the friction between the chain and the bottom of the canal or river for the transmission of the power, the chain being picked up at the stern passes over the engine-barrel, and is hauled forward by its own weight, and passes over the bow to again come in contact with the bottom. A trial of the *Vulcan*, thus fitted, was made on the Irwell navigation, near Manchester, on the 18th December, in the presence of the Hon. A. Egerton, M.P., Sir H. de Trafford, and others, when a speed of four miles was obtained, but at what cost we do not know. The late Mr. E. Galloway, the Hon. Capt. Fitzmorris, Capt. G. Beadon, R.N., Mr. A. Smith, and others, have patented and tried chain and rope-traction schemes for hauling boats or trains of boats along canals.

RECENT LEGAL DECISIONS

AFFECTING THE ARTS, MANUFACTURES, INVENTIONS, &c.

UNDER this heading we propose giving a succinct summary of such decisions and other proceedings of the Courts of Law, during the preceding month, as may have a distinct and practical bearing on the various departments treated of in our Journal: selecting those cases only which offer some point either of novelty, or of useful application to the manufacturer, the inventor, or the usually—in the intelligence of law matters, at least—less experienced artizan. With this object in view, we shall endeavour, as much as possible, to divest our remarks of all legal technicalities, and to present the substance of those decisions to our readers in a plain, familiar, and intelligible shape.

THE "GREAT EASTERN" ARBITRATION AWARD CASE, which was disputed by the company, has resulted in cross rules, granted by the Court of Queen's Bench to J. Scott Russell, Esq., on one side, and the company on the other. It is stated, however, that before the case comes on for argument, an application will be made to one of the Equity Courts which will open up the past management of the company.

TELEGRAPHIC CABLES.—*Newall v. Elliott.*—The Vice-Chancellor gave judgment in this case on Wednesday. He said the plaintiff was the patentee of an invention for laying down telegraph wires, consisting of a cylinder, and a species of cone, round which the cable was coiled. It appears that in paying-out cables there were two essentials in order to prevent kinking; first, it was necessary to have a large radius for the coil, and next to prevent the rope from becoming slack. This was formerly prevented by men, who kept the rope taut. The plaintiff's invention had for its object to do away with the necessity of these men, and for this purpose he introduced the cone into the cylinder. The defendants had also introduced an internal stay into their cylinder, and this was the matter of which complaint was made. In reply to the complaint, it was stated that the defendant's plan simply amounted to packing the cable: that it was a matter of that simplicity that it could not be the subject of a patent. But it appeared in fact that this packing was not to be taken away before paying-out commenced, but that it was to be used in course of paying-out. And although it appeared from the evidence that the packing was but put in

for the purpose of paying-out, yet in no place was it said that paying-out would not, in point of fact, be made easy by it. Upon the whole case, therefore, his honour came to the conclusion that an injunction must be granted.

SMOKING IN A COAL PIT.—At the Aberdeen Police Court, a few days since, James Jones was sentenced to seven days' imprisonment for smoking tobacco, in Messrs. Powell's colliery. Mr. Fowler, in passing sentence, said that the Act of Parliament gave the fullest power to the magistrates to punish all who violate the rules so necessary for the safety of the lives of persons employed in mines. The sentence would have been much heavier had it not been for the previous good character of the prisoner.

On the evening of the 7th ult. an inquiry was held at Canterbury, by the City Coroner, into the circumstances connected with the death of John Mather, a sub-contractor of the works in the course of construction for the London, Chatham, and Dover Railway, in the neighbourhood of Canterbury. About half-past eleven o'clock that day the deceased was on the New Brickfield Bridge over the above railway, engaged moving some earth from behind one of the abutments. By some means the earth, about a waggon load, slipped from the rear of the abutment and knocked him off, and completely covered him up. Assistance was promptly obtained, and in about six minutes he was extricated. On medical assistance arriving life was extinct. The jury returned a verdict that the deceased was accidentally suffocated.

AT THE COURT OF QUEEN'S BENCH, on the 6th ult., Mr. Howard, an eminent manufacturer of agricultural implements, at Bedford, brought an action against Mr. Ledger, an ironfounder, of East Retford, for having fraudulently used the plaintiff's trade-marks upon certain parts of ploughs. On behalf of the defendant it was proved he had made articles for a Mr. Curtis with the name of Howard upon them, Mr. Curtis being at one time agent for Mr. Howard at East Retford. But there was no doubt that Mr. Ledger sold to the traveller of Mr. Howard pieces of a plough with the name and marks of the plaintiff upon them. The jury found that Mr. Ledger sold the goods knowing them to be spurious, and intending to pass them off as Mr. Howard's manufacture. Verdict for the plaintiff. Damages 40s. The Chief Justice certified that it was a fit action to be tried in superior court, and by a special jury.

IN THE COURT OF EXCHEQUER, on the 10th ult., an action was brought by Mr. Grist to recover from Mr. Colyer, of Whitechapel, certain sums of money for the working, &c., of patents for manufacturing casks, under certain agreements. The defendant pleaded that he had performed his part of the contract. It appears that in 1853 and 1854 the plaintiff invented certain machines for manufacturing casks (all except hooping them), without manual labour, except what was necessary to work the machines, the effect of which would be to materially lessen the cost of production. In 1854, the defendant applied to the plaintiff with a view to purchase the inventions, which resulted in an arrangement, whereby the plaintiff, in consideration of £200, to be paid by instalments, assigned the patents to the defendant, stipulating that the plaintiff should give his undivided attention to their completion, and that the defendant should forthwith proceed to carry them out in a co-operation on a large scale. The plaintiff was also to have a salary of £100 for the first year, £150 for the second, and so on, with 15 per cent. on the profits on the saving of manual labour resulting from the working of the patents, and 50 per cent. on all licences to work the patents; the defendant finding the money requisite for perfecting the patents. In 1855 and 1856 the plaintiff made further improvements, and other patents were taken out, which were assigned to the defendant on certain conditions. In 1857, the defendant put up two or three of the machines, which proved satisfactory, and entered into negotiations for working the patents by a company. The defendant informed the parties with whom he was treating objected to his retaining his interests in the patents, and requested Mr. Brooman, the patent agent, to give his opinion what should be awarded to the plaintiff to relinquish them. Mr. Brooman named £350 for the purchase of plaintiff's 15 per cent. on the profits, or £1000 for his entire interests in the patents. The defendant approved of it, and sent it to the plaintiff, who subsequently agreed to it, when the defendant gave notice of abandonment. At this stage of the proceedings, the learned counsel conferred together, and informed his lordship that they had agreed to a verdict for the plaintiff of £400, subject to terms. The jury accordingly returned a verdict for the plaintiff for £400, on terms.

NOTES AND NOVELTIES.

OUR "NOTES AND NOVELTIES" DEPARTING.—A SUGGESTION TO OUR READERS.

We have received many letters from correspondents at home and abroad, thanking us for that portion of this Journal in which, under the title of "Notes and Novelties," we present our readers with an epitome of such "events of the month preceding," as may in some way affect their interests, so far as their interests are connected with any of the subjects upon which this Journal's view. This epitome, in its preparation, necessitates the expenditure of much time and labour; and as we desire to make it as perfect as possible, more especially with a view to benefiting those of our engineering brethren who reside abroad, we venture to suggest to our subscribers, from which, if acted upon, we shall derive considerable assistance. It is to the effect that we shall be happy to receive local news of interest from all who have the leisure to collect and forward it to us. Those who cannot afford the time to do this would greatly assist our efforts by sending us local newspapers containing articles on, or notices of, any facts connected with Railways, Telegraphs, Harbours, Docks, Canals, Bridges, Military Engineering, Marine Engineering, Shipbuilding, Boilers, Furnaces, Smoke Prevention, Chemistry as applied to the Industrial Arts, Gas and Water Works, Mining, Metallurgy, &c. To save time, all communications for this department should be addressed "19, Salisbury-street, Adelphi, London, W.C." and be forwarded, as early in the month as possible, to the Editor.

MISCELLANEOUS.

THE HOMOGENEOUS METAL introduced some time since at Woolwich Factory for boilers, is ordered by the Admiralty to be applied experimentally in the manufacture of chains, links, and similar purposes, and to be reported on accordingly after being carefully tested.

COMPRESSED AIR HAMMERS.—As an improvement upon the ordinary mode of constructing steam hammers, it is proposed to place beside the ordinary hammer cylinder another cylinder, which is connected with the hammer cylinder by a tube at bottom. The ascent of the piston of the other cylinder, by compressing the air, causes the piston of its companion to rise, and vice versa.

MESSRS. RANDOLPH, ELDER, & Co., of Glasgow, engineers and ship-builders, have successfully completed the largest casting in the world. It is the sole-plate, containing the cranking, framing, condenser, air-pumps, and pillow blocks for the valve gear;—all cast in one solid mass—a work of no ordinary difficulty. It measures 21ft. 8in. by 20ft. 6in. broad, and 8ft. in height; weighs over 59 tons; was cast in the open air; and will be fitted up in a Government vessel (the *Constance*) by the above firm.

CALORIC ENGINES, to the number of nine, 32in. and 24in., have been ordered in New York, for Spain. A manufactory of these engines has been established on a large scale at Bockan, near Magdeburg, by the Hamburg Magdeburg Engine Company, and placed under the charge of a machinist, who was sent to America on purpose to study their construction.

THE "LION," SCREW LINE OF BATTLE SHIP of 90 guns, and 400 horse-power, was tried on the 5th ult. The mean speed attained with 20lbs. steam, 25in. vacuum and 66 revolutions, was 10.911 knots, the ship drawing 17ft. 10in. forward, and 21ft. 6in. aft. The engines worked at 1700 horse-power. This vessel was launched in 1847 as a sailing ship, and was converted into a screw about two years since.

The ship, drawing 20ft. 3in. forward, and 23ft. aft, with a mean of 56 revolutions with 20lbs. steam and 25in. vacuum, gave as an average mean of six runs a speed of 12.296 knots. The engines worked remarkably well, without any heating of the bearings.

THE "ORPHEUS," screw corvette, 21 guns, 400 horse-power, was tried at the measured mile on the 4th ult. The vessel attained a mean speed of 12.8 knots per hour, with a mean of 66 revolutions. Her new machinery was found to work in the most satisfactory manner.

IT IS STATED that the third naval power in Europe intends not to be behind-hand in putting on her armour, now that England has her *Warriors*, and France her *Gloires*. The Russian Admiral, Count Putiatine, left London a few weeks since for St. Petersburg, taking with him, for Imperial approval and satisfaction, the drawings and contract for an iron vessel of war, which is to be built forthwith in the Thames.

THE "H.R.W. HELL," whilst on her voyage to New Orleans, on the 31st October last, struck on a snag; but after having been run on the shore to stop the leak, again started on her trip, and on arriving within fifty miles of New Orleans the larboard boiler exploded, the head of which was blown through the engine-room and the after-part of the boat, followed by a tremendous rush of steam, killing and scalding every one who happened to be in its course. It appears that 30 persons were killed, and between 40 and 50 wounded.

THE "FREDERICK WILLIAM," screw, 86 guns, laid down in 1842, from designs by Sir Wm. Symonds as a sailing three-decker, but now converted into a screw, gave on her trial, on the 29th inst., with no masts or stores on board, a speed of 11.782 knots as the mean of six runs, with and against tide, with a mean of 72 revolutions. Her bow retains the form originally designed by Sir Wm. Symonds for a sailing three-decker, and consequently she raised a very heavy sea forward when under full steam. She drew 17ft. 6in. forward, and 23ft. 6in. aft.

THE ROYAL MAIL STEAM-PACKET COMPANY own 24 ships, of an aggregate tonnage of 44,345 tons, and 11,730 horse-power. They expended for coals on the half year to June 1860, £101,945 17s. 3d. The repairs in the ships for the six months amounted to £22,554 10s. 7d.; and on the machinery, £19,955 12s. 6d.

THE "TITANIA," IRON YACHT, designed and built by J. Scott Russell, Esq., for the late Robert Stephenson, Esq., the celebrated engineer, has been purchased by the Earl of Rosse.

THE PROPELLERS of the ships *General Admiral* and *Niagara* are so arranged, that should any accident occur to them while at sea, they can be raised out of the water and so fixed that they can be readily attended to without delay, or the necessity of going into port for repairs.

THE "ARGUS," French screw despatch boat, lately built at St. Cloud, has a novelty connected with her boilers, which are heated by means of a jet of fire carried into the water itself by means of a metal worm. After having been submitted to various experiments before the Minister of Marine, and a body of scientific engineers, she will be sent to Cherbourg, there to be fitted out for sea.

THE FRENCH MINISTER OF MARINE has issued an order, directing that all vessels constructing for his government are to be built under shelter.

THE SCREW STEAMER "RANGOON," one of three steamers of 1800 tons each, built by Messrs. Palmer, Bros. and Co., of Jarrow, for laying the Rangoon and Pcnang cable, is now in the Thames, taking the cable on board. Her engines are by Messrs. Robert Morrison and Co., of Newcastle, on the direct-acting principle, with expansive valves and steam superheater. The nominal power is 250 horse; diameter of cylinders, 55in.; length of stroke, 2ft. 9in. On her passage from the Tyne to the Thames, she averaged 60 strokes per minute; and her consumption of coals was 20 cwt. per hour—the temperature of the steam in the superheater being 310°; pressure of steam in the boilers, 25lbs; indicated horse-power, 1000.

THE BEAUTIFUL screw steam yacht *Penelope*, built by A. Leslie and Co., of Newcastle, made her trial trip on the measured mile in the Thames on the 24th of November last. Her average rate of speed was twelve and a half miles per hour. Her engines, built by Robert Morrison and Co., of Newcastle-on-Tyne, are upon the high-pressure direct-acting principle, with all recent improvements. They worked most satisfactorily, making 150 revolutions per minute; pressure of steam, 50lbs. per square inch on the boiler; nominal power, 20 horse; consumption of coals, 3 cwt. per hour.

THE HANDSOME screw steam yacht *Taganrog*, built by C. Mitchell and Co., Newcastle, for the Russian Government, made a trial trip on the Tyne at the measured mile on the 8th of December. Her average speed was eleven miles per hour. Her engines are by Robert Morrison and Co., of Newcastle, of 30 horse-power nominal; pressure of steam in the boilers, 20lbs; number of strokes, 120 per minute; consumption of coals, 4 cwt. per hour.

THE THAMES IRONWORKS COMPANY, it is stated, have received an order from the Russian Government for an iron-cased frigate of the *Warrior* class, but larger, say 6320 tons, hullers' measurement. Other vessels of the same class are to be built from year to year; the vessels to be fitted with engines of 1250 horse-power.

A DISC-WHEEL PROPELLER for steam-boats has lately been fitted to the *Saucy Jack*, steam-tug. It consists of a solid plain circular disc of metal or wood, or both in combination, with plain edges, made as thin as possible, consistently with its being strong enough to be turned rapidly in the water without "buckling" or breaking. One of these at the stern, or one at each side, will propel a boat. In the *Saucy Jack*, two wheels or discs replace the ordinary paddles; each wheel consists of four metal discs, open in the centre, about 14ft. in diameter, and dipping a little more than 2ft. in the water. With 47 revolutions a minute; 6lbs. steam in the boilers, and a consumption of 12½ cwt. of coal per hour, the speed was 6 knots; the usual speed of the boat with ordinary radial paddles being 8 knots.

THE "METEOR," floating battery, is still having her plates removed. When the iron plates and planking are taken off, the outside of the vessel presents a remarkable aspect, owing to the black and sodden state of her timbers, &c., an inspection of which might go far towards elucidating the important question of the best mode of applying wood and iron in the future constructing of iron-cased vessels.

THE "WARRIOR," floating battery, is to be exposed to every conceivable trial which the Whitworth and Armstrong guns can furnish, and is to be taken to Shoehuryness for that purpose. If the result of these trials is satisfactory, the entire navy of England will be adapted to meet the altered conditions of warfare suggested by these results; if, on the contrary, the system of floating batteries should prove a failure, we shall not regret that the Admiralty have exercised their discretion in suspending all future contracts.

THE "SENTINEL," iron screw steam-vessel, has just had her trial trip at Newcastle, which was considered to be satisfactory. She is intended for the Newcastle and London trade; her dimensions are—length, 152ft.; beam, 24ft.; depth, 15ft.; tonnage O.M., 140; register, 389 tons; capacity for cargo, about 500 tons; draught of water, laden 12ft.; nominal horse-power of engines, 100. She was built, with many excellent improvements, by Palmer Brothers, of Jarrow-on-the-Tyne, and her engines were fitted by Messrs. Hawthorne, of Newcastle.

THE COST OF FUEL to the Peninsular and Oriental Steamship Company for the past year has amounted to the enormous sum of £850,000.

A PROSPECTUS has been issued of the East India and London Shipping Company, formed for the purpose of establishing a fast line of inexpensive vessels direct to India,

the only port of call being Madras. The fleet secured for the service comprises the large and well-known auxiliary screw steamships formerly on the Australian route, *Golden Pleece Jason*, *Queen of the South*, *Calcutta*, *Indiana*, and *Hydaspes*, which are to be transferred to the company at about one-third of their original cost. These vessels will be employed as sailing clippers, steam being used only in case of calms and on nearing port; and the duration of the voyage will, it is hoped, not exceed 70 days out, and 65 days home.

RAILWAYS.

IT IS STATED IN THE UNITED STATES that India-rubber will soon be abandoned altogether in that country, as a material for railroad springs. It is found that unless a very large quantity be used, it does not have a sufficient range of action, and it becomes hard by use. Most of the rubber now made becomes soft in very hot weather, and freezes in very cold.

IN THE UNITED STATES, 24,000 miles of railway have cost only £216,000,000 sterling, whilst, in England, 9000 miles have cost £300,000,000 sterling! From this it would seem that law expenses and compensation are much more reasonable in the States.

CAST-IRON TYRES are on the wheels of every engine on the Baltimore and Ohio Railroad; and it is stated by the locomotive manager, that of more than 1600 tires in regular use under the 235 engines owned by the company, but two broke during the last winter, and these were defective castings.

THE RAILWAY CALLS for the year 1860 amounted to a total of £14,193,391. DURING the last 19 weeks of the past year the traffic on the 22½ miles of the Brighton line has produced an increase of revenue of £25,000 over the average.

THERE IS NOW a continuous chain of railroads from Bangor to New Orleans, in the United States, composed of eighteen independent roads, costing in the aggregate, for 2244 miles of road, about £10,000,000, or nearly one-tenth of the whole railway system in the United States.

FOUR YEARS AGO there was not a mile of street railroad out of New York; now all the principal cities in the United States have them. In Philadelphia, alone there are 155 miles of this description of railway.

THE LONDON, CHATHAM, AND DOVER RAILWAY from London to Canterbury was opened for traffic with metropolitan termini for the first time in the early part of the last month. The works have been carried out in a very good and efficient manner.

IN WILM'S LOCOMOTIVE ENGINES, the draw-bars are upwards of ten feet long, and three, or three and a-half, inches in diameter, the engines having no footboard; the draw-bar connects to the frame in front of the fire-box, and runs through the ash-pan, which is seven and a-half feet long. As hot coals drop upon the bar it is occasionally heated red-hot and drawn in two.

THE "QUEBEC INDICATOR," referring most severely to the "extravagant, reckless" management of the Grand Trunk Railway of Canada, says:—On one section of the line a large bonus is paid to a steam-boat owner, to huy off competition; on another section, the road is leased out to private parties, who are paid a large premium for keeping it open, although it is notorious they make the road pay a handsome profit. The London creditors of the Grand Trunk Railway may as well understand, so intimately are the affairs of the road bound up with the corruption and malpractices of the Canadian governing system, that to repair the one will likely put an end to the other; that the severance of the tie which binds the twain will be something akin to the granting of a new constitution to Canadians.

A RUMOUR which has lately been in circulation in the North of England, that the Midland and Lancashire, and Yorkshire Railway Companies were about to amalgamate, has received a contradiction "on the most positive authority." It is added that no proposal of such a nature has been made, or even discussed by the directors. The rumour has probably arisen from the fact that negotiations have been taking place for some alterations and improvements in the traffic arrangements between the two companies.

[AT A MEETING of the Manchester City Council, it was stated that Mr. Train, finding so many difficulties thrown in his way, has come to the conclusion not to construct his railway in Manchester until Parliament has given him power to lay down lines, with such powers of reservation over them, which he considers he has a right to have.

AN INVENTION for warming street cars has lately been applied to the cars on the railroads of the United States. A furnace is attached underneath, on which are placed draft-tubes, regulated by the motion of the car, so that there is certain to be a strong draft in either direction. Pipes extend from the drum of the furnace up through the floor of the car and along the whole length of the seats, from which sufficient heat radiates to warm the interior comfortably. These pipes are so adjusted as not to consume any of the space required for the convenience of the passengers.

NEW RAILWAY WORKS THROUGHOUT THE COUNTRY.—From the notices in *The London Gazette* it will be found that not fewer than 262 railway hills—all new, or next to new—will be ready for the consideration of Parliament in the forthcoming session, if the promoters perform the necessary preliminary conditions. Many of the lot, doubtless, will not go beyond publication in the *Gazette*, or hut a few steps further, but still a good balance will remain to give employment to committees, engineers, lawyers, &c. Two hundred and sixty bills are a formidable number, but it will be found that few are heavy enterprises.

A PROSPECTUS has been issued of the Regent's Canal Railway, with a capital of £650,000, in £10 shares. The proposal is to enlarge the basin of the Regent's Canal at Limehouse, and to build a steamboat pier and a railway along the Canal from Limehouse to Maiden-lane. It will pass through Stepney, Mile-end, Hoxton, and Islington, and connect with the London and North-Western, the Great Northern, the Metropolitan, and the Blackwall railways at King's-cross and Camden-town. The railway will not interfere with the working of the Canal, and is expected to bring additional business to it.

MILITARY ENGINEERING.

IN 1779, 68-pounder cannonades, cast by the Carron Company, having a bore equal to the 8-inch howitzer, were introduced into the British Navy.

IN 1810, the large howitzers introduced by Napoleon I. at the siege of Cadiz, threw shells over that town into the harbour—a range of 6000 yards.

SEBASTOPOL is being restored. General Todleben, the distinguished Russian military engineer, is on the spot, and has been directing his skill towards the repair of the fortifications damaged by the play of the French and British cannon.

TELEGRAPHIC ENGINEERING.

IN THE NEW FRENCH OPERA HOUSE, about to be erected, the electric telegraph is intended to play a very prominent part. An instantaneous line of communication is to be established between the cabinet of the Minister of State and that of the director of the theatre; a wire will also run from the box-office to the principal hotels, so that strangers will be able to engage places immediately on their arrival in Paris.

THE ELECTRIC AND INTERNATIONAL TELEGRAPH COMPANY have successfully relaid their cable from Holyhead to Howth, and there is once again a second line of communication between the two countries. There is not, however, as yet so thorough or complete or economical a system of telegraphing in Ireland as might be carried out, and as it is to be hoped will be soon done.

THE STEAMER "DANUBE" has arrived at Malta, with nearly all the Red Sea Telegraph Company's staff of telegraph clerks, who are returning homewards. From this it would appear that the Red Sea Telegraph Company intend abandoning the cable for the present. Measures are being taken for the immediate completion of the Corfu and Otranto section of the Mediterranean Extension Telegraph line.

UNDER the celebrated tariff now being arranged between this country and France, the duties on shipping will be as follows:—Ships and boats in wood, 25 francs per ton in 1860, and 20 francs in 1864; iron ditto, 70 francs in 1860, and 60 francs in 1864; hulls of ships in wood, 15 francs in 1860, and 10 francs in 1864; hulls in iron, 50 francs in 1860, and 40 francs in 1864.

FROM a statistical return, published in Paris, it appears that 700 people are killed, and 5000 wounded every year in the streets of Paris by the carriages and other vehicles. According to the calculation (made by M. Poursageaud), the carriages in Paris kill and wound more people than all the railways in Europe, and more than the 4,000,000 of carriages in all the rest of France. The number of victims is 400 in Paris to one in the provinces!

THE NIGHT SIGNAL LAMPS of Mr. Ward having been much improved, and had their weight reduced from 40lbs. each to 8lbs., have been lately tried again by order of the Board of Admiralty. They can now give 178 signals without the working lines, a convenience never before attained in the code of night signals. The committee united in congratulating the inventor on the success which he had finally accomplished, and expressed their opinion that no alteration or improvement could by any possibility be further desired.

THE ENGLISH GOLD COINAGE is 22 parts pure gold to 2 parts of alloy. One thousand pounds of American gold coin contain 900 pounds pure gold, 50 pounds of silver, and 50 of copper. The English coin is the finer.

THE number, tonnage, and class of vessels in actual employment on the American lakes in 1858 and 1859 were as follows:—

1858.		Number.	Tons.
Paddle steamers	...	130	72,108
Screw	...	182	65,271
Barks	...	57	22,817
Brigs	...	97	27,121
Schooners	...	974	200,323
		1442	387,740
1859.		Number.	Tons.
Paddle steamers	...	131	66,834
Screws	...	197	66,793
Barks	...	59	22,604
Brigs	...	99	27,908
Schooners	...	1001	192,518
		1487	376,557

It is understood that the increase in the past year has been very great.

THE LARGEST RAFT that ever came down the Mississippi, arrived the other day at Dubuque. It contained 1,100,000ft. of lumber, and 950,000 shingles and lath.

IN CALORIC ENGINES and improvements Captain Ericsson is still progressing, as he has lately obtained another patent, of a very voluminous character, for several new improvements in hot-air engines.

AT OTTAWA, ILL., U.S., a large structure, known as the Aqueduct Mills, is to be moved across the canal at that place, and taken to a place about one mile distant.

THE TUNNEL WORKS at MONT CENIS are said to be suspended; some say from want of funds; others, from unexpected difficulties in the execution.

THE AIR ENGINE, although much younger than the steam engine, has had an immense amount of attention paid to it, no less a number than 200 and 300 patents having been taken out for improvements in it in this country, and 35 in the United States.

FOR BOILER LAGGING on the Mine Hill and Schuylkill Haven Railroad they use a composition of plaster of Paris, asbestos, and soapstone, mixed in gum shellac. This mixture is applied in a thin layer over and around the boiler, which is afterwards covered with binders' board, varnished on the outside.

WATER TUBE GRATE BARS are coming into extensive use in the United States for coal-burning engines; those on the Reading Railroad answer perfectly. They are ten in number for a fire-box 42 in. wide, and screwed into the inside sheets. In every third or fourth interval is placed a round solid grate bar, which can be immediately withdrawn for cleaning the fire. The tubes are say 2½ inches in diameter, No 10 iron, and open in the front and back water spaces.

ON THE PRAIRIES OF THE U.S. the commerce is carried on by means of "prairie schooners." These are waggons four times as large as common road waggons, the bed of each being fourteen feet long, four feet wide, and six feet between the bottom of the bed and the haws, and the entire waggon weighs 2000 lbs. when empty, and carries from 5500 to 6000 lbs. To these monster road ships are usually hitched ten or twelve head of cattle, or as many mules; and upon an average twenty or twenty-five waggons go together in one train, employing twenty-eight or thirty men.

FOR PREVENTING INCrustation IN STEAM BOILERS, a M. Boulard, of Paris, proposes to employ what may be called an inner wire gauze boiler. He states that the deleterious matter is deposited on the gauze, and may then be easily removed. The gauze is kept off the sides of the boiler by brackets, and in order to facilitate the placing of the protecting gauze in position, he proposes to make it in pieces, which may be passed through the man-hole, and then connected together.

SOME EXTRAORDINARY TIMBER has lately been purchased at Liverpool. It consisted of two New Zealand pine logs from Kauri, where immense forests of probably centuries growth have been discovered. The logs were of the following dimensions,—the first 5½ feet long, 26½ inches square, containing 246½ feet of timber. The other 26 feet long, 28 inches square, containing 142 feet. Some of the logs obtained were from 70 to 80 feet in length. The timber is of a fine hard texture, and remarkably free from knots. Trees may be seen in the forests of 90 feet in clear length, and more than 26 inches square.

ATMOSPHERIC POST.—There is a great question at this moment of adopting in Paris a new system for transporting letters and despatches by means of long tubes, from which the air is exhausted at one end. This process was tried, and patented in 1854 by Mr. Laifmer Clark, Engineer of the Electric Telegraph Company of Lothbury. It was tried on a large scale in 1857 between Moorgate-street and the General Post Office; the results were so good, that this mode of carriage will doubtless soon be generally adopted. It is, however, very afflicting to see our French neighbours profit, as they frequently do, by an Englishman's invention, before the latter can persuade his own country to adopt it.

FOR THE INTERNATIONAL EXHIBITION of 1862 the guarantee list includes 662 persons, and the sum guaranteed now amounts to £366,800. The Commissioners for the Exhibition of 1851 have granted a site for the building on their estate at South Kensington.

THE NOVELTY INOX WORKS at New York lately completed one of the largest and heaviest pieces of wrought-iron ever made in that country. It consists of a wrought-iron crank shaft and four cranks (two air-pumps and two-main engine), for the steamer *Golden Gate*, of the Pacific Mail Steamship Company's line. The cranks weighed in the rough, as they came from the forge, individually 956 lbs.; the air-pump cranks are cut from a solid block of metal, weighing, each block, 14,338 lbs.; the pin of these cranks (a nice little affair to handle), 6614 lbs.; the two shafts amount in the aggregate to 16,413 lbs. These pieces are all bored out and turned to fit their several places, and the amount necessary for shrinkage; they are then expanded by heat, and inserted in their proper positions; the contraction of the metal to its original size, and the addition of two keys in each shaft, secure the whole fabric beyond the possibility of detachment, whatever strain it may be submitted to. The job, as finished, is a perfect specimen of

workmanship, being without flaw or boteh in the various stages of its construction. The forging was also done in New York, and is a handsome piece of smithing.

IN MANUFACTURING STEEL from cast-iron, a new process has been patented in New York. Cast-iron, in the form of thin bars or plates, is packed in an iron box, or other suitable receptacle, with sufficient carbonate of soda to completely cover the bars when the salt is in a melted state. The box, with its contents, is subjected to a bright red heat for several hours, the time varying with the thickness of the bars. The soda salt acts both as a purifier of the iron and as a decarbonizing agent. The carbon of the cast-iron is gradually eliminated, through its affinity for the oxygen of the soda, and passes off as carbonic oxide. Sodium is set free and volatilised, and may be collected beneath the surface of liquids, which contain no oxygen in their composition (melted paraffin is a suitable liquid for this purpose). It is more convenient, however, to allow the sodium to become re-oxidised by admitting just air enough to effect the purpose through a small opening in the top of the containing vessel. Soda is thus reproduced for future use. The process of decarbonisation is arrested at such a stage of the operation that there will be left in the iron just the amount of carbon requisite for good steel. The impurities of the cast-iron—silicon, sulphur, and phosphorus—are also eliminated, and consequently, the silicate of soda and the sulphide and the phosphide of soda are in the residuum after the completion of the process. The condition of the iron and the progress of the operation may be determined at any time by withdrawing a bar and testing it. The carbonate of potash may be substituted for that of soda in this process. If they make use of a combination of the carbonates of potash and soda, in the proportion of their equivalents, the mixture will retain its fluidity at a lower temperature than soda alone; and, therefore, would be sometimes preferable. The oxides of iron and zinc may be used with good effect in combination with the carbonate described. The hydrates of potash and soda may be used instead of the carbonates, but neither so conveniently nor economically. After the carbonates have become very impure by continued use they may be purified by pulverising, mixing with saw-dust, and exposed to a red heat. The resulting material is dissolved in water and re-crystallised. The bars converted into steel by this process may be worked directly under the hammer and rolls, or it may be melted, cast into ingots, and hammered. This process presents these essential advantages: it ensures the manufacture of a uniform article, it removes silicon, sulphur, and phosphorus—impurities that are only partially removed in the preparation of the best bar-iron for the ordinary steel process, and it diminishes materially the cost of manufacture of both the common and the superior kinds of steel.

AT WOOLWICH DOCKYARD orders have been received from the Admiralty to cease working on the job and task system after the 1st of February next; and that all persons holding acting appointments as measurers and writers are to return to their former situations. Vacancies in the factory for clerks to be filled up by writers. The exertion money of one shilling per week allowed to labourers is also to cease—thus reducing the wages of these men to twelve shillings per week.

THE "ENGINE-DRIVERS' AND FIREMEN'S SHORT-HOURS' MOVEMENT" is still being agitated. A few days ago, at a meeting held at Leeds, there were about 100 men present. The chair was taken by one of the London and North Western men, who described at some length the objects of the movement, which were either by an arrangement with the directors of the various lines of railway, or by a legislative enactment, to fix the number of working hours per day at the uniform rate of ten, instead of, as at present, indefinitely ranging from fourteen to sixteen, and, at times, eighteen hours. The meeting was addressed by a deputation from Manchester, who described the steps which had already been taken towards effecting the object which the association had in view. Several members of Parliament and other persons of influence had expressed themselves as favourable to the movement. Amongst the rest, the Earl of Shaftesbury had said that he was willing to aid them by every means in his power. Lord Shaftesbury, however, advised them to exhaust every other means in their power before applying to Parliament. This they had endeavoured to do. They had addressed respectful memorials to locomotive superintendents, and, failing to get any redress by that course, they also memorialised the directors. Some advantage had been gained by the latter course, as the president said the locomotive superintendents of the Lancashire line had received orders to carry out the ten hours' system as soon as possible, and with this view several new locomotives had been ordered to be made. On other lines, however, especially the Great Northern, the directors said it was impossible to carry out the system. Resolutions in favour of an application to Parliament were adopted.

A LIGHTHOUSE is to be placed on the shore, near Gavo Island, New South Wales, and the cost is estimated at about £20,000.

THE STEAM BREAK for locomotives was patented by Richard Roberts, the well-known engineer, in April, 1832. The late Mr. Robert Stephenson also patented the steam break for locomotives, in October, 1833.

HYDROGEN GAS was used for illuminating in 1733. Clayton's demonstration of gas lighting by coal gas was before the public in 1792. Dr. Watson produced and burned coal gas in 1767. Murdoch lighted his house at Redruth, in Cornwall, with gas in 1792, and made an extensive gas apparatus at the Soho Works in 1798, the works being illuminated at the declaration of peace in 1802. Pall Mall was lighted with gas, made under Winsor's patent, in 1804.

THE NUMBER OF WRECKES reported during the month of October was 276. In the month of January there were 229; in February, 154; in March, 166; in April, 133; in May, 124; in June, 146; in July, 60; in August, 96; and in September, 103,—making total during the present year of 1487.

THE "CORRESPONDENCIA" OF MADRID gives the following as the naval force of Spain, as fixed for the coming year:—A sailing ship of 84 guns, a frigate of 42, 2 corvettes carrying together 60 guns, 2 brigs with 32 guns between them, and two transports of 2748 tons. Screw Steamers.—Three frigates, mounting in all 115 guns, and with machinery of the force of 1460 horse-power; 4 schooners, with ten guns and 340 horse-power; and 6 transports of 7300 tons and 1310 horse-power. Six paddle-steamers, carrying together 40 guns, and moved by machinery of 1330 horse-power. In addition, the Coastguard Service of the Peninsula includes 2 screw-steamers, with 4 guns, and of 76½ horse-power; 2 despatch boats, with 4 guns; 2 luggers, with a gun each; 25 feluccas, and 73 other craft. The total force of Spain, then, colonies not included, may be taken at 25 armed vessels, carrying 393 guns, 10 transports, together of 10,000 tons burden, and 97 auxiliaries. The number of men to be provided for the navy and naval stations is given as follows:—4919 marines, 571 guards for the arsenals, and 7176 sailors—in all 12,661.

COMBUSTION CHAMBERS in locomotives, as now used in the two forms patented by McConnell, were patented by Stuhbs & Gryll in 1846.

A THROTTLE VALVE, or cock, in the exhaust pipe of a steam engine, for retarding or stopping its motion, was patented by W. H. James in 1824.

STEAM SHIPPING.

THE "RHADAMANTHUS," paddle-wheel steam vessel, has commenced taking in the boilers and machinery intended for the screw steamship *Black Prince*, now building at Greenock. The engines will be of 1250 horse-power, and it is expected their transport will occupy the services of the *Rhadamantus* throughout the winter, and extend over seven or eight voyages.

THE SCREW STEAMSHIP "HOWE," 121 guns, was tried at Plymouth, on the 4th nit Her engines are of 1000 horse-power, working up to 4050 horse; they are trunk engines, and are worked by eight boilers, the four forward of 600 horse-power, and the four aft of 400 horse-power, together, 1000. The diameter of the screw is 22ft., and the pitch 28ft.

LAUNCHES OF STEAMERS.

THE "AMALIA," screw steam frigate, built for the Greek Government, was launched on the 16th ult., in a highly successful manner, at the premises of Mr. Henry J. Pitcher, Northfleet Dockyard. The *Amalia* is intended to carry thirty-six guns, and is of 1000 tons burthen. She is to be fitted with her screw machinery and completed forthwith, in order to be forwarded to her destination. After the launch, which took place about half-past two o'clock, a numerous party, at the invitation of Mr. Pitcher, adjourned to the mould-loft, which had been fitted up in a very attractive manner, and where a *déjeuner* was provided.

THE "RAPID," SCREW SLOOP, 11 guns and 150 horse-power, was launched at Deptford in the early part of last month. Her armament will consist of one 58-pounder, 32-cwt. pivot gun, and ten 30 cwt. 32-pounder guns.

THE "AMALIA," a large iron screw steamer, built by Messrs. J. & G. Thomson for the Liverpool, Constantinople, and Syria trade, was recently launched from their shipyard at Govan. The *Amalia* is about 2000 tons burthen, with engines of 300 horse-power; this is the sixth vessel built by Messrs. Thomson for the same trade. The progress and extent of the Mediterranean steam trade will be appreciated when it is stated that not many years ago only two small steamers were employed in this trade, and that now upwards of fifty large screw steamers sail from Liverpool for the various ports in Italy, Greece, Syria, &c.

THE "RIO JEROME," a screw steamer of 580 tons, has been launched from the building yard of Messrs. Scott & Co., at Carls-dyke; her dimensions are—200ft. long, 23½ft. broad, and 25½ft. deep, within the hold; the same size and model as the *Bocciochi*, which was launched about two months ago, and for the same owners, at Marseilles.

THE "PALIKARI," an iron screw steamship, was launched, a few days since, from the yard of Messrs. Richardson & Duck, at Stockton-on-Tees. She is intended for the London and Mediterranean trade, and is the largest vessel ever built on the Tees, her dimensions being—length over all, 250ft.; breadth, 31ft. 6in.; tonnage O.M., 1200; burthen, 1500 tons; nominal horse-power, 180; effective, 600. The engines are by Richardson & Sons, of Hartlepool.

GAS SUPPLY.

THE LOUTH GAS COMPANY have declared a dividend of 10 per cent. The 6 per cent. guaranteed on the additional capital raised a few years since has also been paid. The same dividend was paid last year.

IN LIGHTING STEAMERS WITH GAS, the Birkenhead Commissioners are trying the experiment. They are using gas to light the cabins of their river steamers, a quantity being carried on board each steamer daily.

A REPORT on the recent explosion in St. Mary's Church, Oxford, by Mr. Siemens, C.E., of London, attributes it to gas accumulated under the flooring, where a workman had thrown down a burning match. The gas main had been broken whilst laying pipes for the hot water apparatus.

ON THE 7th ult. a remarkable explosion of gas took place in a small house, No. 1, Elizabeth-place, Wandsworth, which blew up the walls, and has necessitated the entire re-building of the house. It is stated that, through defective pipes, the gas had accumulated between the lowest floor in the front of the house. A woman and some children were in the back room, where the floor remained uninjured, and they contrived to escape. The furniture in the house was blown to pieces. It is remarkable that the persons in the adjoining house, who were slightly injured, did not hear the explosion, although the whole neighbourhood were alarmed by it.

IN PURIFYING COAL GAS it is proposed to apply sewage containing sulphuret of iron; pickle waste may be applied for the same purpose, and the residuum may be treated to produce salts of iron, which may be again used for the purification of gas.

THE GAS AND COKE COMPANY, Swindon-lane, have reduced the price of gas to 6s. 6d. per 1000.

FOR THE TOWN OF PEWSEY, Wilts, a gas and coke company is being formed. THE SHIPLEY GAS CONSUMERS are agitating for a reduction in the price of gas, to which the gas company object, that, taking an average of years, their dividends have not exceeded 5½ per cent. Meantime, not only are the street lamps unlighted at night, but a third part of the shopkeepers do not use gas.

GLYCERINE IN GAS METERS.—Now that the cold weather seems to have set in, it will perhaps be useful to name here a very ingenious application of glycerine. It is known that the water in the gas meters, being subject to freeze, often causes a great deal of trouble in private dwellings and shops. Last winter, during three days of very hard frost, we saw most of the shops on the Boulevard des Italiens, at Paris, taken by surprise, and remain for some time without light in the evening, on account of the water freezing in the gas meters. This was remedied to a certain degree by mixing spirits of wine or brandy with the water. But that is expensive; and in summer another drawback is met with: the water evaporates very rapidly during the hot days, and is obliged to be constantly replaced. Now, M. Fabian has proposed glycerine to be used instead of water in gas meters. It does not evaporate, like water, with the summer heat, nor has it been known to freeze in winter, however intense the cold. The commercial glycerine, which marks on Baumé's areometer from 15 to 17 degrees, and which contains 40 to 45 per cent. of pure anhydrous glycerine, may be cooled down to 20 and 25 degrees (Centigrade) below zero without becoming solid. It appears that this substance was formerly proposed and its use patented in Paris by M. Barreswil, who had experimented with it successfully during the hard frost of last winter, when the thermometer actually marked 26° below zero (Centigrade).

INNIQUE-PUTES.—This name has been given to an ingenious apparatus invented by M. Cantagrel, and destined to show when there exists an escape in gas-pipes. It is essentially composed of a pear-shaped bladder of caoutchouc, called *la poire*, and of a sort of small recipient called *l'éprouvette*; these two objects are connected by a tube having in its centre a tap, which establishes or shuts off the communication between the *poire* and the *épreuvette*, and also between the gas-pipes and the apparatus. When the *poire* is compressed by the hand, the transmitted pressure causes the *épreuvette* to swell as long as the pressure is maintained, and if there be no escape in the tubes, the *épreuvette* remains in this state the whole time. If, however, the least escape of gas is taking place, the *épreuvette* soon returns to its primitive volume; and the time that it takes to do this will give an idea of the extent of the damage. If it takes about 5 minutes, the holes by which the gas is escaping are of sufficient importance to require immediate attention.

MINES, METALLURGY, &c.

A return of the Russian gold mines for 1858 and 1859 gives the following results:—1859, 38,556 lbs., value £1,927,800; 1858, 41,514 lbs., value £2,075,700.

THE MINERAL WEALTH OF SPAIN is enormous, and comparatively undeveloped. From a recent survey, it is estimated that the coal region covers 120 square leagues, containing 2,300,000,000 tons of coals of a quality but little inferior to our own. In France the consumption of coal amounts to 60,000,000 of tons annually.

IT IS STATED as a singular geological circumstance that it is not very uncommon in the prairies of the United States to find, in the grass, smooth round copper boulders, weighing from one cwt. each, upwards, solid pieces of pure virgin copper. How they came there it is impossible even to conjecture, for though large stray stone boulders are met with here and there, there is, of course, nothing like rock in the whole district, either above or below the soil.

IN 1859 there were 216 collieries at work in Scotland, from which 5,700,000 tons of coal were raised. The number of deaths from accidents, including explosions, was 8·2 per million of tons of coal raised.

THE TOTAL VALUE of the earthy minerals of the United Kingdom raised per year amounts to £7,954,075. The total value of metals, metalliferous minerals and coals, produced per annum amounts to £31,266,932. Thus our annual mineral produce has the enormous value of £39,221,007.

The following shows the annual 'output of coal, and the number of deaths resulting from its raising:—

	Tons of coal raised.	Number of deaths.
1855	64,307,459	956
1856	66,645,450	1027
1857	65,394,707	1122
1858	65,008,649	931
1859	65,500,000	905
	326,856,265	4941

From this it appears that upon the average during the five years, and including the whole of the collieries in Great Britain, one life has been lost for every 66,150 tons of coal raised, whilst during 1859 upwards of 72,000 tons were raised for each death—the improvement being nearly 10 per cent.; or, in other words, during the five years the average number of lives lost for each million tons of coal raised was 15·11, whilst during 1859 the loss of life has been less than 14 for each million tons raised—the improvement being equal to 6 per cent.

THE TOTAL PRODUCE of building and other stones is estimated at 15,764,200 tons; 7,500,000 were raised in England; 3,500,000 tons were raised in Wales; 4,750,000 tons in Scotland; and 14,200 tons in Jersey; and 800,000 tons in Ireland.

THE GREAT BULK of the tin and copper ores raised in the world are smelted or refined in this country, affording an immense trade to the shipping and coal mining interests.

SULPHIDE OF POTASSIUM is now believed to be the residuum of gunpowder which we see giving a reddish colour to mortars after shell practice. It has also been considered to be a proof that the powder has been adulterated with fulminating mercury to increase its strength.

FROM THE NEW ZEALAND STEEL, obtained from a black sand, which, when smelted, yields 66 per cent. of pure steel, a poniard, made from some of the samples, was driven through two penny pieces, one over the other, without any injury to the edge. Some half a dozen individuals in London have subscribed the capital required to work a grant of the district where the sand is found.

PUZZOLANA is found in the greatest abundance at Puteoli, in Italy, now called Pozzuoli. It is of the lava genus, magnetic, and easily melts into a black slag. It suddenly hardens when mixed with one-third of its weight of lime and water, forming a cement of great durability under water. Its constituents are said by Bergman to be 55 to 60 parts of silicious earth, 20 of argillaceous, 5 or 6 of calcareous, and from 15 to 20 of iron. The expense attending the importation of the volcanic puzzolana has led to the production of several efficient substitutes.

SMELTING IRON was practised in England during the Roman occupation. Roman coins have been found in many beds of cinders, the remains of ancient iron works. Remains of ancient furnaces have been found in Yorkshire, Staffordshire, and Lancashire, but the principal seats of manufacture appear to have been in Sussex and the Forest of Dean. The art of working in steel was much practised before the Norman conquest. The army of Harold was well supplied with defensive weapons both of steel and iron; even the horses had covers of iron armour. Every chief officer maintained a smith at his own expense, whose duty it was to take charge of the armour of his master, and keep it in repair.

IRON ORE abounds in the mountains surrounding Bilbao, and gives considerable employment to native industry, and is exported to a large extent to France. This branch of industry commenced in 1850, and was prospering materially, English vessels being employed to convey cargoes of the ore to England. In 1852, however, the Spanish Government imposed an export duty on the article, and a differential duty on such of it as was carried in English bottoms, and at once stopped the trade with England. The ore in question is used in the iron manufactures of Biscay, and to a large extent in the iron foundries adjoining Bilbao.

IRON ORE.—The discovery of a considerable field of iron ore at Hof, on the Bavarian-Saxon frontier, gave rise in 1854 to an association for carrying on extensive iron works there, which are to be worked with coals brought from Zurekaw. It is estimated that the yield of iron from the ore is 35 per cent. A railway direct from Zurekaw would, it is said, give complete success to the undertaking.

COPPER ORE is found in the Provinces of Biscay (Spain), and mines of it are now worked, the ore being shipped to Swansea for smelting.

CANNEL COAL.—An American paper says, "This coal has been in our market for several years, but until recently it has not received much attention from consumers, and even now it is difficult to remove the early prejudices that were formed against it. The leading commendable qualities of this fuel are:—1. It is clean, makes no soot, but little smoke, and no cinders. 2. It ignites freely, and burns pleasantly. The only objection to it is the presence of small particles of slate, which cause it to fly occasionally; this objection is gradually being overcome, for as the mines are penetrated the slate disappears. For cooking purposes it is almost equal to wood, and, of course, a great deal cheaper. It would be a grand feature if Cannel coal could be supplied in sufficient quantities to insure its general use for household purposes."

ON MIXTURES OF CAST-IRON AND NICKEL.—The 15th vol. of the *Memoirs of the Literary and Philosophical Society of Manchester* contains a long paper by Mr. W. Fairbairn, upon the effect of nickel upon the properties of iron. Meteoric iron contains often about 2½ per cent. of nickel, and it is well known that this iron possesses peculiar properties. In order to determine whether it would be possible to obtain an artificial compound of this nature, and to ascertain the effect produced by mixing a certain proportion of nickel with cast-iron, some experiments were made. They consisted in the extraction of the nickel from the ore found in the mines of the Duke of Argyll, near Inverary, purifying it by repeated meltings, and mixing it with cast-iron in such proportion as to form a compound containing about 2½ per cent. of nickel. The mixtures were fused in crucibles, and run into ingots or bars, which were then tested in regard to their mechanical powers of resistance to transverse strain. Meteoric iron is remarkable for its ductility; but the ingots prepared as above differ widely from it in this respect. To sum up the results of these investigations, it is evident that an admixture of nickel in the proportion of 2·50 per cent. does not increase, but diminish the tenacity of cast-iron. Mixtures of the two metals used in this proportion are decidedly inferior to the pure metal in the power of resistance to a transverse strain, and to impact. Besides this, another object was aimed at in these experiments, namely, to produce a metal of increased tenacity suitable for the casting of cannon, and heavy ordnance. During the last two years innumerable experiments have been made for this purpose with more or less success; but the ultimate result appears to be, that for the construction of heavy artillery there is no metal so well calculated to resist the explosion of gunpowder as a perfectly homogeneous mass of the best and purest cast-iron, free from sulphur and phosphorus.

A COLLIERY EXPLOSION of a terrific and fatal character occurred on the 2nd ult., at the Black Vein Pit, at Risca, near Newport, South Wales: 135 men and boys, and 28 horses have been destroyed by this accident.

COLLIERY ON FIRE.—For the purposes of ventilation, a fire-lamp was placed two weeks ago in one of the levels of the Arthur Pit of the Elgin Colliery, near Dumferline. The position of the lamp being close to the coal, during the night the coal took fire, and in spite of every effort to extinguish it, the fire has not yet been brought under. It is

intended, however, to raise the water in the level over the burning coal. In attempting to extinguish the fiery mass, much danger has been encountered, but fortunately no accident has hitherto occurred. The number of men thrown idle by the fire is considerable, but the whole have been employed, either at some other pit in the colliery, or in trying to extinguish the fire.

RAILWAY ACCIDENTS.

THE TRENT VALLEY FATAL ACCIDENT on the London and North Western Railway at Atherstone will, it is estimated, with its compensations, losses, and the expenses incidental to the inquiry, cost the North Western Company upwards of £20,000.

A FATAL RAILWAY ACCIDENT occurred on the North Eastern Railway, between Pelaw Main and Usworth, on the evening of the 8th ult. A gentleman had got out of a train at the former station, and was walking along the line towards his residence, when he was struck by the engine, and so severely injured that he died shortly afterwards.

ANOTHER of those many accidents arising from carelessness took place on the 15th ult., at the Commercial Dock Junction on the North Kent Railway, by which many passengers were severely shaken and some injured. The express due at London Bridge at 8.45 overtook an engine on the up line, and thus a collision. It is said by the South Eastern directors that their system of telegraphs and signals are perfect. Witness the Lewisham accident, the Grove Ferry accident, and the above.

On the night of the 16th ult., about ten o'clock, a fatal accident occurred to a man, at present unknown, on the Eastern Counties Railway, near the North Woolwich Station. It appears that the deceased was on the line of rails at the time that a down train was about to enter the station, when he was knocked down, and the entire train passed over his body, which was literally crushed to atoms. From some papers found in his possession, it is believed that the deceased came from Lambeth.

ON THE MIDLAND RAILWAY, an accident of an alarming character occurred on the 16th ultimo. Two passenger trains came into collision at Swinton, where the Sheffield and Doncaster Branch joins the main line, and the engine of one train was hurled down the embankment. The coupling chains connecting the carriages with the engine fortunately snapped; the driver and stoker saved themselves by jumping off; and there was, singular to relate, no loss of life, although many persons were very severely shaken and bruised, and the plant and engines were a good deal destroyed. The collision occurred thus: at the junction of the Doncaster Branch with the main line, there is only one signal post, the signals being used by the trains on the two lines. About 100 yards on the Doncaster Branch, is fixed what is called the back signal, used in case of necessity for the Doncaster trains. The Leeds and Doncaster trains chanced to whistle in token of their approach almost at the same moment; and the pointsman lowered the main signal as an indication to the Leeds train to proceed, but did not lower the back signal for the Doncaster train. The driver of the Doncaster train, however, seeing the main signal lowered immediately he whistled, supposed that it was intended as an intimation to him to proceed, though the back signal still remained at danger; he accordingly continued at the speed usual at that point, until the Leeds train came within sight, when he instantly reversed his engine. It was, however, too late to prevent the collision; the Doncaster engine, in striking the end of the parapet of the bridge, moved the whole length of the masonry from its position; and it is probably owing to its coming in contact with the parapet, which instantly arrested it, that the carriages were not dragged down the embankment.

ANOTHER MISHAP TO THE SCOTCH MAIL has occurred on the London and North-Western line, somewhat similar to the Atherstone disaster. Early on the morning of the 12th ultimo it came into collision with a goods and cattle train, which was being shunted at Rugby Station, and so great was the force of the concussion, that both trains were thrown off the line. Several of the cattle trucks were completely shattered, and many of their live freight killed. Fortunately, however, it was unlike the Atherstone disaster, as there was no loss of human life on this occasion; nor does it appear that any one sustained any serious personal injury.

CASUALTIES TO STEAMERS.

THE "TASMANIAN," Royal Mail steamship, on the 3rd of December, having left Southampton, with mails and passengers for the West Indies, went on shore the same evening in Tottenhill Bay, just inside the Needles. She was got off the same evening, but a hawser having become entangled round her screw-shaft, which it was impossible to remove even by the assistance of divers, she was taken back to Southampton to be docked, and her mails and passengers transferred to the *Oneda*, which sailed on the 5th.

THE "SHANSON," Royal Mail steamship, with the outward mails of October 17th, did not reach St. Thomas's until November 9th, twenty-three days out, in consequence of having broken her port paddle-shaft outside the hull, and cracked her starboard one. The accident occurred on the 23rd, when she had been six days at sea.

THE "EMPIRE," screw steamer, 400 tons, of London, from Greenock to Bordeaux, was totally wrecked on the 26th of November off the Scilly Islands; crew saved.

THE "CLEOPATRA," African Royal Mail steamship, having broken her screw-shaft, has been obliged to come home under sail.

THE "SATELLITE," Cunard steam tender, on the 23rd of November last, came into collision with the ferry steamer *Lord Morpeth*, both vessels receiving considerable damage.

THE "OLYMPUS," screw steamer, whilst leaving the Liverpool Docks on the 10th ult., to proceed to Constantinople, came into contact with the *Lurline*, from St. John's, N.B., and received such damage to her port quarter as to render it necessary to detain her for repairs.

BOILER EXPLOSIONS.

A BOILER AT DANN, BROTHERS'S, Coach Factory, New Haven, Connecticut, exploded on the 1st of November, killing a boy and demolishing the whole building.

THE STEAM-BOAT "H. M. HILL," when near Baton Rouge, on the Mississippi, on the 2nd November exploded her boilers, by which thirty-nine persons were killed and twenty wounded.

THE TOW-BOAT "BALEIC" exploded her boilers in Mobile Bay, on the 3rd November, by which several persons (exact number unknown) were killed and wounded.

THE BOILER of a small steam pleasure-boat exploded at Antwerp at the end of October last. One lad was instantly killed, and another severely injured. The boat was blown to atoms, and the accident was attributed to want of water in the boiler.

IN THE EXPLOSION OF THE "TONNING'S" boilers, the jury, after patiently hearing the evidence found, "That the several deceased were killed by the explosion of the boilers on board the steamer *Tonning*, but there is not sufficient evidence to show the cause of such explosion.

ASSOCIATION FOR THE PREVENTION OF STEAM BOILER EXPLOSIONS.—At the last monthly meeting of the executive committee, held at Manchester, Mr. H. W. Harman, chief inspector, presented his report, from which the following are the extracts:—During the month we have made 209 visits, examined 586 boilers, and 426 engines; of these, 3 visits have been special; 5 boilers specially, 11 internally, and 31 thoroughly examined: 11 cylinders have been indicated at ordinary visits. The principal defects met with are as under:—Fracture, 8 (1 dangerous); corrosion, 4; safety valves out of order, 20; water-gauges out of order, 15; pressure-gauges out of order, 12; feed apparatus out of order, 2; blow-off cocks out of order, 7; fusible plugs out of order, 4; furnaces out of shape, 7 (2 dangerous); blistered plates, 4; total 83 (3 dangerous). Boilers without glass water-gauges, 3; boilers without pressure-gauges, 5; boilers without blow-off cocks, 16; boilers without back pressure-valves, 26. Other defects might be enumerated; but as they are not of an important character, they need not be further alluded to.

ONE OF THE BOILERS at Hallenbeagle mine burst on the night of the 10th ult., and the engine-man, Samuel Moyle, was very severely scalded.

A DRYING CYLINDER in a paper manufactory at La Combe, in France, blew up with a terrific explosion, on the 26th of October. Two of the workmen only were slightly scalded and bruised. The cylinder weighed nearly two tons, and some months will elapse before the works can be carried on.

BRIDGES.

IN THE YEAR 1205 the expense of building two arches of London Bridge was £25! THE WIRE used in the Niagara Suspension Bridge was tested by being strained over an opening of 400 feet until the deflection was reduced to 9 inches. This is equivalent to straining the same wire over a space of four miles until the deflection was equal to 1 in 30.

A RAILWAY BRIDGE OF IRON, of six spans of 260ft. each, is to be built at Warsaw, on the Vistula, in Poland: to be completed in 1862.

DOCKS, HARBOURS, CANALS, &c.

THE ILLINOIS AND MICHIGAN CANAL, which connects Lake Michigan with the Illinois River, is 60ft. wide and 6ft. deep, with locks 105ft. long and 17ft. wide. At one time, there were a half-a-dozen steam propellers running on this canal, but they have all been laid aside. No difficulty was experienced from the washing of the banks, but the machinery and fuel occupied so much room as to leave too little for freight, and when the propellers were used for towing, the boats were too apt to be blown ashore by side winds.

AN IMMENSE QUANTITY of fine plumbago, or black lead ore, has lately been discovered in the Huron Mountain District, Lake Superior.

IT IS STATED that the Grand Junction Canal Company have brought into use steam power for canal navigation, which, if successful, will materially reduce the cost of conveyance. The peculiar feature in the steam-boats employed between London and Birmingham or Manchester is a form of screw propeller, invented by Mr. Burch, of Macclesfield. This "waggle-tail" propeller is said to have the advantage of keeping all the disturbance of the water immediately behind the stern of the boat, instead of spreading it right and left, thus securing the canal banks from being damaged by the wash, and economising the motive power. On a recent trial trip the *Pioneer*, an ordinary fly-boat, 75ft. long by 7ft. extreme breadth, 25 tons burthen, and drawing 2½ft. of water, with an engine of 6 horse-power, was the boat employed towing another fly-boat, which was laden with a general cargo to go to Wolverhampton. The two boats were able to go through the locks at one, floating side by side, and thus saving much delay. It is stated that the *Pioneer* when tried at Manchester proved able to draw six loaded barges at one, with a total burden of no less than 300 tons. Four miles an hour, allowing for the locks and other hindrances, it is estimated, will be the average rate of steam performance, instead of two miles an hour, the usual speed obtained by horse towing. The steamboat has stowage-room for two and a half tons of coal, which will carry her from London to Birmingham and half-way back. This water locomotive is estimated to be nearly 30 per cent. cheaper than railway carriage.

A DEEP-WATER PIER has been projected at Bombay, at which vessels may load and unload. The capital required is £600,000. This undertaking is one of considerable importance to the shipping interest.

SEWERAGE WORKS.

THE FLOW OF SEWAGE-WATER AT CROYDON varies, with the state of the weather, from 600 to 1400 gallons per minute; the whole amount discharged being from 800,000, to 1,400,000 gallons during the twenty-four hours; a part of this, discharged during the night, being clear water.

AT RUGBY it has been discovered that half the expenditure, to apply the sewage to half the area of land, would have been wiser and more profitable. The population is about 7000; the area over which the power of irrigation has been extended is some 400 statute acres. The proprietor, by years of experience, finds that 200 acres would be sufficient. The Croydon scheme would irrigate 7000 acres, at one person to each acre; or take adults, and say 2000 acres—that is, ten times the area experience warrants.

AN ADDITIONAL LOAN of £10,000 is about to be raised for the heavy sewerage works at West Ham.

AT THE METROPOLITAN BOARD OF WORKS MEETING, held on the 6th ult., the following report was presented as to the progress of the main drainage works:—"During the past month little progress has been made in the main drainage works on the north side of the Thames. Works to the value of about £2500 have been executed in the Northern High-level Sewer; but they are for the present at a standstill, for reasons already under consideration of the board. The Northern Outfall Sewer cannot be commenced until we have obtained possession of the land, which at present we have been unable to do. The tunnelling under Hyde Park and Kensington Gardens for the Ranelagh Storm Overflow progresses satisfactorily, the work, approximating to the value of £4300, having been completed, and another length of 1072 ft. of under-pinning of the Old Ranelagh Sewer has been finished at a cost of £2300. The Southern Outfall Sewer works progress satisfactorily. The pumping engines for the Erith Marshes and the tunnel under Woolwich have turned out remarkably good, and the work is going on well. The value of the works completed is £967,000. Little progress has been made in the Low-level Sewer, under the Surrey Consumers' Gas Company's yard, owing to the defective construction of a rotary engine erected by Mr. Aird, who is confident he has now surmounted the difficulty, and entertains no doubt as to its ultimate efficiency. The East Outlet works progress slowly, but satisfactorily, and may now be valued at about £3000. The Southern High-level Sewer contract does not progress so rapidly as we could desire, nor are the bricks supplied so good as we could wish, and as we expect to obtain, although there is reason to believe the contractors desire to give satisfaction. The work completed in this contract is rather more than three miles, and its value is about £54,000."

THE COST OF THE SEWERAGE WORKS on the south side of the Thames will amount to upwards of half a million of money, of which about £120,000 worth in value is now completed. They will comprise more than a million of cubic yards of earthwork, about 200,000 cubic yards of brickwork, and an equal quantity of concrete. Upwards of 70,000,000 of bricks, 2,000,000 bushels of lime, and 1,000,000 bushels of cement will be used, besides timber, iron-work, masonry, stone-ware, and other materials. More than 3,000 men are employed on the works south of the Thames at the present time.

WATER SUPPLY.

THE STOCKTON AND DARLINGTON WATER COMPANY have expended nearly £235,000 in water supply for their several towns. Their head is equivalent to 50lbs. pressure per square inch.

THE ARTESIAN WELL at COLUMBUS, Ohio, has now reached a depth of 2575ft. A few days since, a Walford's thermometer, placed in a glass tube filled with water, and this enclosed in a strong iron case also filled with water, was lowered to a depth of 2475ft., where it remained for twenty-five hours. It was then sunk to the bottom of the well, where it remained for forty minutes. When drawn up, it was found to have registered 88 degrees, Fah. Assuming this to be the temperature at the bottom of the well, and also assuming as correct the statement that the temperature is uniformly 53 degrees at a depth of 70ft., we have an increase of 1 degree, Fah., for every 7ft.

AT SAGINAW, Michigan, a well 669ft. has been sunk, passing through the coal measures, and reaching to the top of the Devonian. Its water is half saturated with salt, and has the temperature at the surface of 54 degrees, Fah. At Grand Rapids, Michigan, on the Grand River, there is a salt-well 61ft. deep; but, as it begins 445ft. lower down than that at Saginaw, the whole section presented by the two is over 1100ft.

MESSRS. COLMAN, starch manufacturers and millers, of Carron, near Norwich, have been for some time engaged in sinking an Artesian well on their premises. The depth at present attained is about 1000ft.

APPLIED CHEMISTRY.

DISSOLUTION OF OXYGENATED WATER IN ETHER.—Oxygenated water, or peroxide of hydrogen, has often been used to cleanse old pictures, to restore old blackened engravings, &c. It is very probable that in some cases a dissolution of peroxide of hydrogen in ether would act even better than the peroxide itself. M. Schoenbein has lately shown that this curious liquid can be dissolved in ether in the following manner:—A given weight (say 1 gramme) of binoxide of barium is decomposed by enough hydrochloric acid to saturate the baryta, and the mixture is shaken with about forty parts (forty grammes) of ether. After the whole has been allowed to rest, the ether forms a thick stratum of liquid above the chloride of barium formed, and may be easily decanted off. The ethereal solution possesses all the properties of oxygenated water. If it be shaken with water, the latter takes up the whole of the peroxide of hydrogen, leaving nothing but pure ether, which swims at the surface of the liquid.

ON THE JUICES OF FIGUS ELASTICA (INDIA-RUBBER PLANT) AND THE ISOCANDRA GUTTA (GUTTA-PERCHA).—A long and interesting paper upon this subject is being published in *The Chemical News*, by Dr. A. Adriani. The author has analysed the fresh juice of the India-rubber plant, and finds that it contains 82.30 per cent. of water, 9.57 of caoutchouc, 1.58 of resin, with some other organic substances and mineral salts not well determined, making up 100 parts. This analysis differs from Faraday's; in which 31.70 per cent. of caoutchouc was found; but Faraday did not experiment on the fresh juice; but upon that brought over to Europe. The author has also determined by experiment, the elastic force of gutta-percha. Our space will only allow us to call the attention of those whom it may concern to this long dissertation.

ON THE ANALYSIS OF MANURES.—M. Girardin has lately published in the *Comptes Rendus* of the Academy of Sciences, of Paris, a long paper upon the composition of the manure known as *engrais flamand*, and which consists principally of night-soil. Some of the samples gave very satisfactory results as to the amount of nitrogen and phosphate of lime which they contained. Others, on the contrary, were so diluted with water as to become almost valueless, though sold at the same prices as the former. Great losses are constantly befalling the farmer who purchases these substances without a knowledge of their chemical composition; whilst considerable gain awaits him on purchasing upon analysis. M. Girardin observes, that liquid manures should be tested with an areometer before their price is fixed; as they are richer in organic matter, phosphates, and nitrogen as their density increases. The same skilful agricultural chemist has proved that in the manures termed *vidanges*, or *engrais flamand*, by the French, the quantity of nitrogen differs from 9 to 1 per cent.

ON THE APPLICATION OF GAS-TAR, BITUMEN, AND OILS IN THE MANUFACTURE OF PORCELAIN, EARTHENWARE, &c.—In the ceramic arts great difficulties present themselves when there happens to be a want of adhesiveness or cohesion in the different pastes employed for making hardwares. Thus, it is impossible to manufacture these like the better kinds of porcelain, termed *faience* by the French; nor can we preserve the form of plates, dishes, &c., during the baking, from want of a proper degree of cohesion existing in the paste. The same inconvenience exists in the manufacture of porcelain buttons, &c., with dry pastes. In order to preserve the form of the buttons when they leave the model, it has been found necessary to add something to their composition; and in most cases linseed oil has been preferred. From numerous and prolonged researches on this subject, M. Brocchi has proved that linseed oil, and all the other matters generally employed to give adhesiveness to porcelain pastes, can be advantageously replaced by tar, or by some of the light oils obtained from it, as oil of naphtha, sossist oil, oil of resin, and bitumen. The quantity of these substances which it is necessary to use in order to produce the desired effect varies according to the degree of cohesion manifested in the paste itself. It is generally sufficient to add 6 per cent. to the button paste, and 4 per cent. to the plastic pastes used to manufacture hardware.

MANUFACTURE OF OXYGEN GAS.—A paper has been read upon this subject before the Paris Academy by M. H. Deville. The author has succeeded in producing large quantities of oxygen gas from sulphuric acid, sulphate of zinc, and other salts which contain a large per cent. of oxygen, by submitting them to heat in contact with the metal platinum. Sulphate of zinc, which is obtained in such large quantities by the use of the galvanic pile, is a substance not much employed at the present time. All its elements may, however, be utilised in the following manner:—By calcining it alone in an earthen vessel, it is transformed into a light, white oxide, which, when the sulphate is pure, can be used in painting; which is now applied to numerous purposes; or, lastly, into pure oxygen. Sulphuric acid is decomposed at a red heat into sulphurous acid, water, and oxygen, in a very simple apparatus, consisting of a small retort holding five litres, filled with thin leaves of platinum (which in larger vessels may be replaced by pieces of brick), or, better still, a worm of platinum filled with sponge of this metal, and made red-hot. Into this vessel is introduced, by a S tube in communication with a reservoir at a constant level, a stream of sulphuric acid. The gases which escape pass first through a refrigerator, which

separates the water from them, and then into a washer, which absorbs the sulphurous acid, leaves the pure oxygen. Sulphate of zinc and many other salts may be made to yield their oxygen in a similar manner; and M. Deville has proved that, even if the sulphurous acid produced in the above operation be entirely lost, the method described is the cheapest process known for procuring oxygen gas, which may one day be very much more extensively used than it is at present.

PREPARATION OF PEROXIDE OF LEAD.—This oxide, employed in the manufacture of matches, is now in great demand. In its preparation Mr. Boetger recommends that acetate of lead should be boiled with an excess of solution of chloride of lime. Peroxide of lead, chloride of calcium, and acetate of lime are the result; the precipitate is washed until the chloride is removed. The same oxide may be obtained also by passing a current of chlorine gas through water, holding minium in suspension; or better still, by fluxing the minium with a combination of nitrate and chlorate of potash; but this process may give rise to explosions which are dangerous.

ON A NEW GREEN COLOUR.—According to the *Repertoire de Chimie*, Dr. Phipson has discovered a new green colour, produced when oxalate of iron is partially decomposed by ferrocyanide of potassium. The oxalate of protoxide of iron is a brilliant yellow powder, which the author has analysed and found to contain one atom of ferrous oxide, 3 atoms of oxalic acid, and 4 atoms of water. It is precipitated after some time, when an excess of oxalic acid is added to a solution of sulphate of iron. The oxalate of peroxide of iron, which Dr. Phipson has lately analysed also, forms beautiful green crystals, containing 1 atom of peroxide of iron, 5 atoms of oxalic acid, and 15 atoms of water. Light has a peculiar action upon this green salt, whether in crystals or in solution; under the influence of the solar rays, the crystals are blackened, and, when dissolved, leave a residue of yellow oxalate of protoxide; the solution also deposits the yellow oxalate when exposed to the sun, and becomes colourless in the course of a few days; from these properties, it is probable the salt in question will be some day employed in photography.

ELECTRO-ZINCING BY MM. PERSON AND SIRE.—The following process has been adopted by the authors:—In 100 parts of water dissolve 10 parts of alum and 1 of oxide of zinc; this zinc-bath should be kept at a temperature of 15° (Centigrade). The pieces of metal which are required to be coated with zinc being previously well cleaned, are arranged so as to form the negative pole of a battery, and for the positive pole one or more pieces of zinc are introduced, according to the shape of the article to be covered with this metal, and having as near as possible the same amount of surface. Contact with the battery being established by the current from one pair of plates, the dimensions of which should vary according to the surface to be coated, the precipitation of zinc proceeds as easily as that of copper in the ordinary electrolytic process, the deposit taking place indifferently on any metal—on platinum as well as on copper or iron. When copper, coated with zinc, is heated, there is produced a coating of brass. This transformation is likely to receive many applications; the elevation of temperature of the zinced iron augments the adhesion of the surface of zinc. MM. Person and Sire state that the thickness of the layer which is deposited increases in proportion to the time occupied in the deposition; that the reduced zinc has all the properties of the purest metal, and that it completely prevents the oxidation of the metal which it coats.

ON ALBUMEN USED FOR DYEING.—The use of albumen of eggs in dyeing entails such a heavy expense that it has become a great desideratum to replace this substance by others less costly. M. Leuchet has found a substitute in the albumen of blood, and in the roe of fishes. To extract the albumen from blood, the latter is collected, immediately the animal is killed, in a flat-bottomed vessel furnished with taps at different heights in its sides, care being taken to disturb the blood as little as possible. After the expiration of 10 or 15 hours, the serum is separated from the clot by decantation, and exposed to the air for 6 or 10 hours. A deposit is formed, which also is separated by decantation; the liquid is next placed in a room heated to 104°; a solution of sugar is then added to that portion of the serum which is coloured red, exposed to the air a sufficient time, then decanted; it is then mixed with a concentrated portion of fish glue (isinglass), gently stirred, and left to clarify for a day or two. At the expiration of this time, all the colouring matter is separated, and the clear liquid may be decanted and concentrated. The albumen of blood, thus prepared, has all the properties of that obtained from eggs. The preparation of albumen from the roe of fish can be effected: 1stly, from the dry roe, as found in commerce; 2ndly, from the roe of the fish as soon as it is caught; and 3rdly, from salted roes, or from the roes of salted fish. When dried roes are employed, they are coarsely ground, and the mass dissolved in water; the water is then decanted, and the residue dried at 140° Fahr. It is better to operate upon fresh roes, as thereby the expense of drying, salting, and carriage is saved. The roes are first treated with water, and pressed, and after decanting and evaporating the water, the mass is dried in a stove. The same process is followed with salted roes, except that they are first washed to remove the salt. The small quantity of fatty matter that the roes contain is in no way injurious in the application to dyeing, but, on the contrary, gives more brilliancy to the colouring material.

LIST OF NEW PATENTS.

APPLICATIONS FOR PATENTS AND PROTECTIONS ALLOWED.

- Dated August 28, 1860.*
- 2075. F. C. Calvert, Manchester—Saving certain products given off or emitted during the manufacture of coke. *Dated October 17, 1860.*
- 2524. W. Ramsell, 218, Evelyn-street, Deptford—Manufacture of boiler plates. *Dated October 27, 1860.*
- 2624. E. Booth and Major Booth, Manchester—Apparatus for finishing cotton, silk, and other fabrics. *Dated October 29, 1860.*
- 2648. W. Clark, 53, Chancery-lane—Railway break apparatus. *Dated October 31, 1860.*
- 2661. T. G. Chislin, 24, Southampton-row, Russell-square—Adapting certain articles of vegetable production called *Eiklonia-hincinalis*, *Proteacea*, *Juncus Serratus*, *Juncus Trista*, and *Amaryllidææ*, to further new purposes of manufacture. *Dated November 1, 1860.*
- 2670. M. A. J. Dahmen, Peckham—Protecting ships and other vessels. *Dated November 2, 1860.*
- 2679. J. C. Delarothière, 4, South-street, Finsbury—Stocking frames. *Dated November 3, 1860.*
- 2691. J. H. M. V. Hinsbergh, Breda, Holland—Cleaning and preparing pork's wool (l), so as to give it the elasticity of horse-hair.
- 2694. J. Armour, Perceton Fire Clay Works, Kilmarnock, North Britain—Dies employed in the manufacture of sewerage pipes and hollow bodies of clay.
- 2696. W. White and J. Parly, Great Marylebone-street—Colouring surfaces in relief.

- 2698. R. B. Pilliner, 4, Hatfield-street, Stamford-street, Blackfriars-road—Machinery for compressing black lead. *Dated November 6, 1860.*
- 2714. W. Green, New Bond-street—Fire-arms.
- 2718. T. W. Rammell, 6, Victoria-street, Westminster—Centrifugal discs revolving in air, water, and other fluids.
- 2730. G. Wilson, York—Stopped bottle.
- 2732. E. Salisbury, Preston—Mixture or solution to be applied to pickers, picking-bands, straps, sole leather, and such like materials, in order to harden them and render them more lasting. *Dated November 7, 1860.*
- 2734. P. W. Renel, Plumstead, Kent—Apparatus for treating green, semi-green, or undried vegetables or plants, in order to reduce their fibrous portions to a pulp. *Dated November 8, 1860.*
- 2746. J. Cutts, Liverpool—Apparatus for ascertaining or indicating the number of persons that may pass through or over any particular place.
- 2750. W. F. Henson, New Cavendish-street, Portland-place—Fabrics made of alpaca or mohair. *Dated November 9, 1860.*
- 2760. J. W. Wallis, Fenchurch-street—Book indexes.
- 2762. D. B. Lewis, Cheltenham—Apparatus for propelling steam vessels. *Dated November 10, 1860.*
- 2764. W. C. Forster, Gibson-street, Lambeth—Manufacturing soluble silicate of potash.
- 2766. T. B. Daft, 2, Queen-square, Westminster, and W. Polc, 3, Storey's-gate, Westminster—Fish-joints of railways.
- 2768. E. B. Wilson, Parliament-street—Manufacture of railway wheels, tyres, axles, and points of crossings.

- Dated November 12, 1860.*
- 2770. F. Walton, Haughton Dale, Denton, near Manchester—Insulating telegraphic conductors.
- 2772. V. V. Williams, 13, Crosby-road, Walworth-road—Constructing stands for cameras, telescopes, surveying and other instruments. *Dated November 13, 1860.*
- 2774. D. Thomson, Grosvenor-road, Pimlico—Rotatory pumps.
- 2776. M. A. F. Menoons, 39, Rue de l'Echiquier, Paris—Motive mechanism of cabinet organs.
- 2778. M. A. F. Menoons, 39, Rue de l'Echiquier, Paris—Construction of organ pipes.
- 2780. A. V. Newton, 66, Chancery-lane—Feathering paddle-wheel.
- 2782. T. Hughes, Wolverhampton—Spittoons. *Dated November 14, 1860.*
- 2788. R. W. Waitman, Bentham, Yorkshire, and J. Waitman, Manchester—Manufacture of cords, twines, and similar articles.
- 2790. E. E. Sharp, 3, Gloucester-terrace, Blackheath—Portable rifle battery.
- 2792. J. S. Crossland, Johnson Brook, near Hyde—Steam engines.
- 2794. R. H. Gratrix, Salford—Obtaining colouring matters for dyeing and printing.
- 2796. J. A. Bruce, Leynington, Warwickshire, and G. H. Cottam, St. Pancras Iron Works, Old St. Pancras-road—Hay racks. *Dated November 15, 1860.*
- 2798. J. Schofield, Oldham, Lancashire, and M. Schofield, same place—Apparatus for doubling yards of cotton or other fibrous materials.
- 2799. J. Matthews, Burton-upon-Trent—Brewing.

2300. J. Crooke, Manchester—Method or means for packing merchandise by means of the hydraulic press.
2301. P. Unwin, J. Unwin, and J. U. Askham, 124, Rockingham-street, Sheffield—A saloon barrel pistol knife.
2302. A. Henry, Edinburgh—Rifled fire-arms.
2303. G. Bagshaw, Preston—Arrangement of the flues of steam boilers for consuming smoke.
2304. W. H. Ralston, Keele, Staffordshire—Manufacture of soda ash.
2305. G. R. B. Amott, Queen-street, Ross—An improved plough.
2306. A. V. Newton, 66, Chancery-lane—Sewing machines.
2307. R. A. Brooman, 166, Fleet-street—Manufacture of steel and wrought and cast iron.
2308. R. A. Brooman, 166, Fleet-street—Sword bayonets and other swords.
2309. J. Ridley, Stagshaw, Northumberland—Method of effecting the combustion of fuel.
- Dated November 16, 1860.*
2311. C. Stevens, 1b, Welbeck-street, Cavendish-square—Sheet-iron tiles.
2313. C. W. Williams, Liverpool—Steam boilers for increasing the evaporative effect thereof.
2314. H. G. Drewe, Chelsea—Propelling vessels.
2315. J. Stockley, Newcastle-on-Tyne—Apparatus for grinding, smoothening, and polishing plate-glass.
2316. J. B. Mourguet, 6, Rue Boucher, Paris—Fire-arms and ordnance.
2317. E. B. Wilson, Parliament-street—Manufacture of railway wheels.
2318. R. Bodmer, 2, Thavies-inn, Holborn—Apparatus for folding, and for folding and stitching sheets of paper and other material.
2319. B. Fleet, East-street, Walworth—Apparatus for cutting and rounding wood.
2321. R. A. Brooman, 166, Fleet-street—Joining or connecting together pipes and tubes.
2322. W. H. Woodhouse, Parliament-street—Instrument for measuring distances.
2323. W. L. Thomas, Southsea, Hants, and H. P. de Bathe, Colonel Scots Fusilier Guards—Construction of plates or shields for the purpose of resisting shot and other projectiles.
2324. M. L. J. Lavater, Guildford-street, York-road, Lambeth—Portable or syphon filters.
2325. M. A. J. Dahmen, Park-road, New Peckham—Treating vegetable fibrous substances in the manufacture of paper.
2326. G. Glover, 8, Queen-square—Apparatus used in measuring gas.
2327. A. Morrison, Nottingham—Locks.
- Dated November 17, 1860.*
2329. B. Blackburn, York-buildings, Adelphi, and H. Carr, Victoria-street, Westminster—Axle boxes.
2330. T. M. Jones, Finchley-common—Apparatus for containing, igniting, and holding wax taper and other matches.
2332. H. MacFarlane, Glasgow—Cameras such as are used by photographers.
2333. B. Barrett, St. Giles-road, Norwich—Treatment of natural and artificial stone.
2334. J. Hogg, Edinburgh, J. Hogg, jun., and J. Hogg, of London—Ornamenting the edges of cloth-bound books.
- Dated November 19, 1860.*
2337. O. Vandenberg, New York—Projectiles to be used in guns and ordnance.
2339. W. Butlin, Northampton—Apparatus for stamping and ramming.
- Dated November 20, 1860.*
2340. W. E. Newton, 66, Chancery-lane—Apparatus for supplying air to the furnaces of steam vessels by means of the paddle wheels.
2341. T. T. Macneill, Mount-pleasant, Dundalk, Ireland—Obtaining adhesion on railways for ascending inclines.
2342. R. A. Brooman, 166, Fleet-street—Stoppers for bottles, jars, and other like articles, parts of which are applicable as fastenings.
2343. J. Hamilton, jun., Liverpool—Tubular wrought-iron telegraph posts.
2345. A. V. Newton, 66, Chancery-lane—Construction of spring hinges.
2346. H. D. Pochini, Oakfield House, Salford—Material for building purposes.
- Dated November 21, 1860.*
2347. J. Marland, Ivy Cottage, Hunslett, Leeds—Warping and sizing yarn and thread.
2348. G. H. Cail, Southampton—Manufacture of manure.
2349. J. H. Johnson, 47, Lincoln's-inn-fields—Manufacture of boots and shoes.
2351. H. Dearden, Roehdale—Apparatus for punching washers, for giving the necessary drag or friction to the spindles and bobbins of spinning machinery.
2352. J. Crossley, Tordmoren—Apparatus for moulding iron or other metals.
2353. W. Cooke, Charing-cross—Ventilating.
2354. J. Howden, Glasgow—Steam engines and boilers.
2355. W. Cope, W. G. Warde, and E. Cope, New Basford, near Nottingham—Lace machinery.
2357. C. Myring, Walsall—Manufacture of covered harness furniture, buckles, slides, and other similar articles.
2356. L. Heinemann, Broad-street Buildings—Means by which persons in charge of railway trains may obtain information for increased safety in travelling.
- Dated November 22, 1860.*
2359. J. Henry, Buchanan-street, Glasgow—Printing warps and apparatus for the same.
2360. T. H. Keble, Margate, Kent—Fire-arms.
2361. W. H. Ralston, Keele, Newcastle-under-Lyne—Manufacture of hydrate of soda.
2362. R. Jobson, Dudley—Moulding articles of earthenware or porcelain.
2363. W. F. Lovick, Thorpe, near Norwich—Bridle-bit.
2365. D. Auld, Glasgow—Regulating the pressure and flow of fluids.
- Dated November 23, 1860.*
2366. J. Venables, Burslem, Staffordshire—Modes of ornamenting the surfaces of earthenware.
2367. G. E. Derring, Lockleys, near Welwyn, Herts—Permanent ways of railways.
2368. J. F. Carosin, 4, South-street, Finsbury—Treating cane-trash.
2369. E. Monkhouse, 6, Caledonian-terrace, Cooks-ground—Manufacture of circular and polygonal heel-plates for boots, shoes, and clogs.
2371. E. Keirby, Gatehead Mill, Greetland, near Halifax—Covering insulating and preserving telegraphic wires and cables.
2373. J. Anderson, 92, Farringdon-street—Preparing potatoes for boiling or cooking.
2375. C. Humfrey and C. Humfrey the younger, both of Wareham, Dorsetshire—Distilling coal and peat.
2376. G. Bartholomew, Linlithgow, North Britain—Boots, clogs, and goshes.
2377. E. Izod and R. Beech, 13a, Grocer's Hall-court, Poultry—Manufacture of stay cloth.
2378. T. Gamble and E. Ellis, both of Nottingham—Machinery for producing looped fabrics.
2379. T. Hale, 21, Barnsbury-row, Park-road, Islington, and A. Wall, Canton-street, East India-road—Arrangement of furnaces and manufacture of clays and bricks.
2381. A. A. Dalglish, Glasgow—Engraving or producing printed surfaces.
- Dated November 24, 1860.*
2382. W. R. Bowditch, St. Andrew's, Wakefield, York—Purification of coal gas and coal oils.
2383. R. Harrison, Bacup, and G. Taylor, Lancashire—Apparatus for preparing cotton and other fibrous substances for spinning.
2384. C. R. N. Palmer, Southampton, Hants—A new portable and improved fixed signal apparatus.
2385. S. Walker, jun., Edgbaston, Warwickshire—Machinery to be used in the manufacture of twisted and other ornamental metallic tubes.
2386. J. H. Johnson, 47, Lincoln's-inn-fields—Sewing machines.
2387. T. Benton, Sheffield—Manufacture of bells.
2389. J. Fowler, jun., R. Burton, and D. Greig, Leeds—Apparatus for raising, lowering, and hauling weights.
2391. W. Leigh, Goulden-terrace, Richmond-road, Dalston—Indicator for railway carriages.
- Dated November 26, 1860.*
2393. W. Pearson, W. Spurr, and T. Smith, Bristol—Looms for weaving woollens.
2395. G. F. Train, Liverpool—Steam carriages.
2396. T. Moy, Clifford's-inn—Direct action steam engines and pumps.
2397. W. R. Shirtcliffe, Spring-lane, Sheffield—Warm baths.
2398. J. Birkett, Pemberton Village, near Wigan—Musical instruments.
2399. S. Roberts, Hull—Harrows.
2400. G. Mackenzie, Paisley, Renfrew, North Britain, and J. Hamilton, Glasgow—Bobbins, or holders for textile materials.
2401. R. Oxland, Plymouth—Manufacture of gunpowder.
2402. P. Hugon, Paris—Mode of firing or igniting explosive gaseous compounds in motive-power engines.
2403. C. H. Jacquet, Lyons—Calendar clock.
2404. I. Sharp, and W. Bulmer, Middlesbrough—Apparatus for the manufacture of bricks.
2405. F. Seiler, Paris—Apparatus for preventing the dangers of shipwreck at sea or in rivers.
2406. G. Ennis, Jersey—Construction of oyster dredger.
2407. J. S. Manton and T. Islip, Birmingham—Compositions useful for many purposes in connection with the arts and manufactures.
- Dated November 27, 1860.*
2409. R. Robertson, Glasgow—Apparatus for preparing asphalt.
2410. V. Wanostrocht, Parkstone, near Poole—Manufacture of mineral tar.
2411. J. Fowler, Waterford, Ireland—Boots, shoes, gaiters, leggings, and overshoes.
2412. J. Smethurst, Guide Bridge, Lancashire—Slide valves of steam engines.
2413. F. S. Beatty and T. Alexander, Dublin—Production of photographic proofs.
2414. T. Pape, Nottingham—Circular frames for manufacturing glove and other fabrics.
- Dated November 28, 1860.*
2415. J. B. Lecomte-Alliot—Machine for waxing and rubbing apartments.
2417. J. Sidebottom, Harewood, near Mottram—Reeds.
2418. R. Thomas, Bath-street, Tabernaacle-square—Venetian blinds for windows.
2419. D. Mardell, York-terrace, York-square, Commercial-road East—Steam engines.
2421. H. Grafton, 80, Chancery-lane—Machinery for cultivating land.
2422. J. Reeves, Brooklyn, New York—Construction of the ships.
2423. H. Gillett, Regent-street—Ornamentation of the edges of the leaves of photographic albumns.
2424. N. Ager, 77, Upper Ebury-street, Pimlico, S.W.—Apparatus for raising building materials.
2425. T. Holmes, Anlaby-road, Hull—Preparing and tanning hides and skins.
2426. S. Thomson, Motherwell, Lanark—Manufacture of iron.
2427. J. Jeyes, 17, Cheyne-walk, Chelsea—Manufacture of boots and shoes.
- Dated November 29, 1860.*
2429. H. Gilbee, 4, South-street, Finsbury—Welding.
2430. H. Hirsch, Bridge-road, Lambeth—Screw propellers.
2431. W. Darley, Bishop Bridge, Market Rasen—Portable steam engines.
2432. R. E. Offord, jun., 79, Wells-street, Oxford-street—Adaptation of india-rubber and compounds thereof to wheels.
2433. W. M. Storm, New York, U.S.—Construction of breech-loading fire-arms.
2434. J. A. Jaques, and J. A. Fanshawe, Tottenham, and G. Jaques, Bromley—Apparatus for cooling liquids.
2436. T. Cole, and D. Gardner, Coventry—Looms for weaving ribbons and other fabrics.
- Dated November 30, 1860.*
2439. E. C. Perry, Sedgley, Staffordshire—Preventing accidents in orat mine shafts.
2440. G. Parsons, Martock—Construction of wheels.
2441. E. T. Hughes, 123, Chancery-lane—Manufacture of metal tubes.
2443. J. Pelegrin, Bordeaux, France—Inodorous basins and descent pipes of glass.
2444. R. C. Newbery, 5, President-street West, Goswell-road—Manufacture of collars and wristbands.
- Dated December 1, 1860.*
2446. H. Greaves, 22, Abingdon-street—Construction of railways.
2448. C. Farmer, and W. Farmer, Birmingham—Machinery for the manufacture of the hooks used principally as dress fastenings.
2449. W. S. Losh, Wreary Syke—A new method of preparing sulphurous acid in solution.
2450. W. L. Tizard, Mark-lane—Fastening threaded nuts and bolts.
2451. R. Marsden, 22, Anson-street, Park, Sheffield, and W. Lambert, 9, Castle Hill, Sheffield—Horses' shoes.
2453. J. Austin, Millisle Mills, Donaghadee, Down, Ireland—Apparatus for ploughing or cultivating land.
2455. W. Clark, 53, Chancery-lane—Looms.
2456. A. Leonhardt, Manchester—Preparation of indigo for dyeing and printing.
- Dated December 3, 1860.*
2457. W. P. Piggott, 16, Argyll-street, Regent-street—Manufacturing submarine telegraph cables.
2459. W. Pilkington, Windle Hall, within Windle, Lancashire—Furnaces for melting glass.
2461. T. Richardson, Newcastle-upon-Tyne—Manufacture of paper.
2463. E. T. Hughes, 123, Chancery-lane—Treating and decomposing fatty matters.
2465. R. A. Brooman, 166, Fleet-street—Valves for closets and other receptacles.
2467. G. MacFarlane, Draycott-street, W. E. Newton, 66, Chancery-lane, and R. Carte, Charing-cross—Wind musical instruments.
- Dated December 4, 1860.*
2469. W. R. June, 4, Flower-terrace, Camberwell-road, Bow—Manufacture of kamptulicon or covering for floors.
2471. E. H. Higginbotham, and A. Beech, Macclesfield, Cheshire—Apparatus for the prevention of explosions of steam boilers, arising through deficiency of water or over-pressure of steam.
2473. W. T. Walter, Long-acre, and C. Henry, Batholomew-place, Hertford-road, Kingsland—Process for obtaining ornamental and other devices or effects on metal, glass, stone, and earthenware.
2475. F. Michaux, Anzin, Nord, France—A new sort of safety lamp for mines.
2477. G. F. Stidolph, J. Stidolph, Ipswich, and T. Simpson, R. Morley, Woodbridge—Construction of crates and other packing cases.
2479. J. B. Payne, Chard, Somersetshire—Machinery for the manufacture of fishing and other nets.
- Dated December 5, 1860.*
2481. G. W. Hart, 9, Stanley-terrace, Southsea—Embrasures of fortifications.
2483. C. W. Lancaster, New Bond-street—Sights for rifles and other fire-arms.
2485. E. Morewood, Enfield—Coating metals.
2487. G. C. Lingham and J. Nicklin, Newhall-street, Birmingham—Improvements in belt-fastenings.
3039. A. Vervey, 3, Croydon-grove, Croydon—Proportions of ingredients and mode of manufacture of a chemica compound for softening water.

INVENTIONS WITH COMPLETE SPECIFICATIONS FILED.

2488. S. A. Varley, 7, York-place, and C. F. Varley, 4, Fortress-terrace, Kentish Town—Regulation of heat.
2492. C. Stevens, 1b, Welbeck-street, Cavendish-square—Smoke consuming furnaces.

WIL

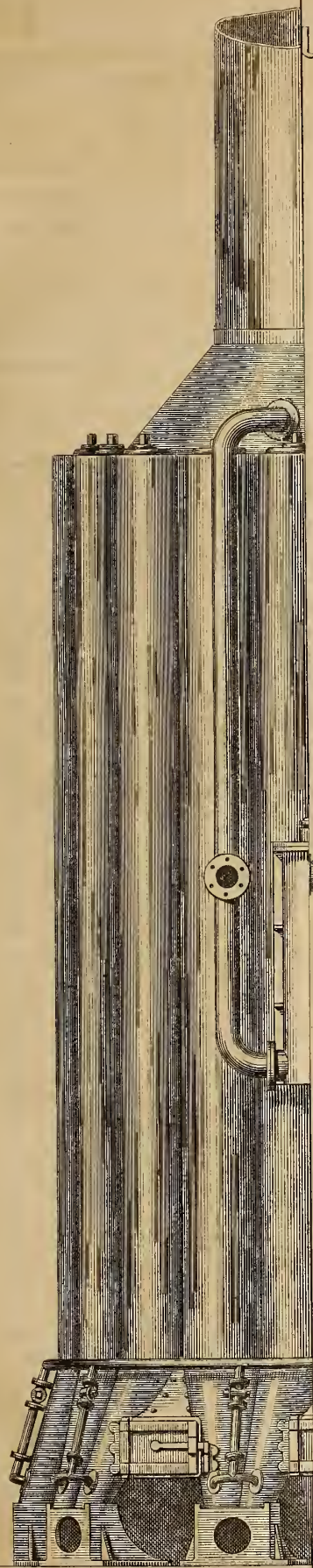

FIG. 1.

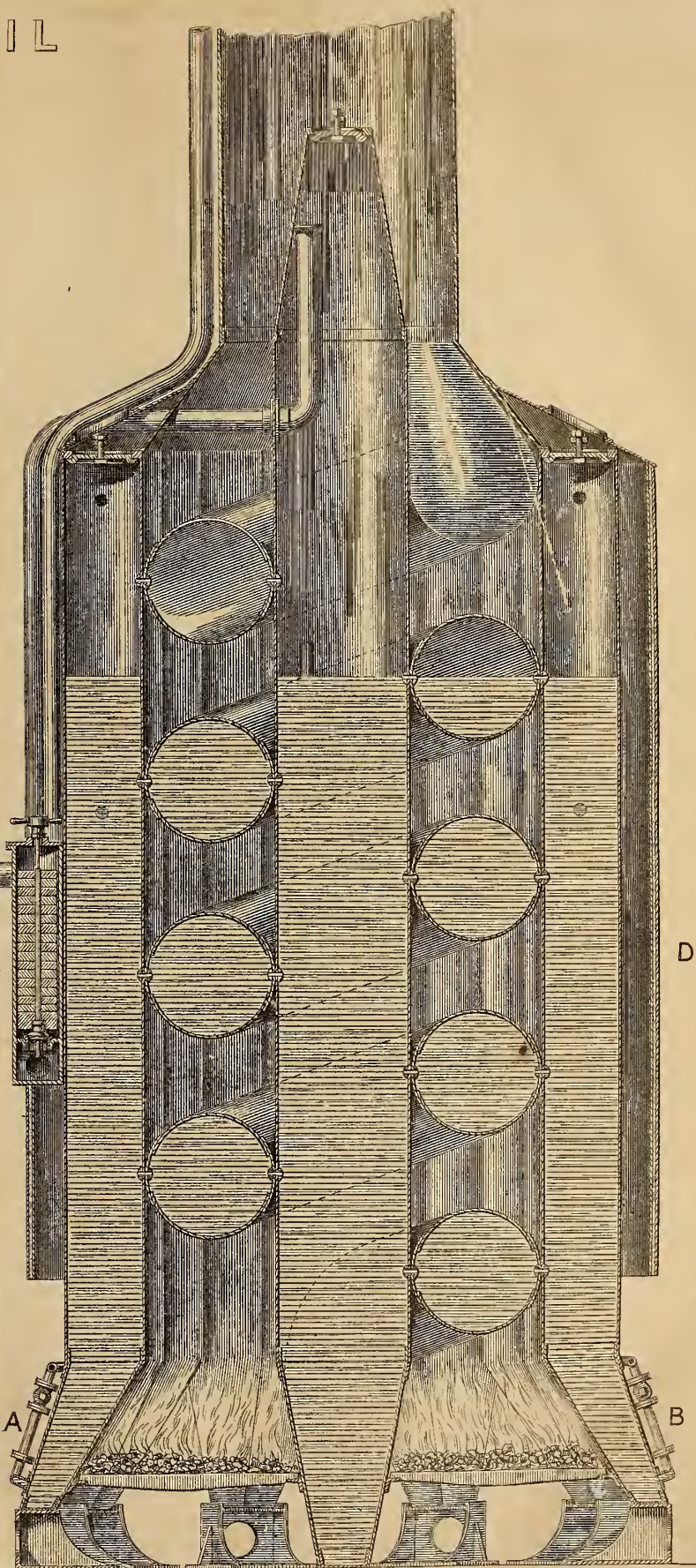

FIG. 2. SECTION

25 Feet

BOILERS OF THE S.S. SAN CARLOS AND GUAYAQUIL

By Messrs RANDOLPH, ELDER & CO ENGINEERS, GLASGOW.

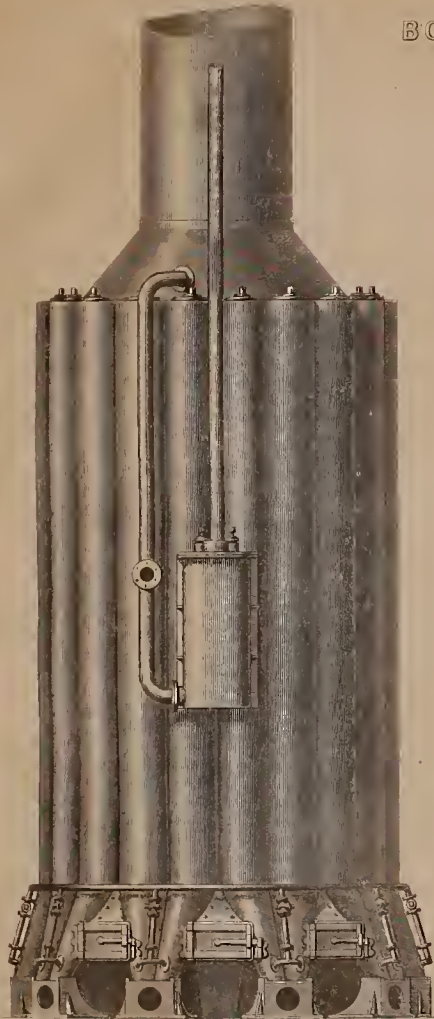

FIG. 1. ELEVATION



FIG. 3. PLAN AT A. B.

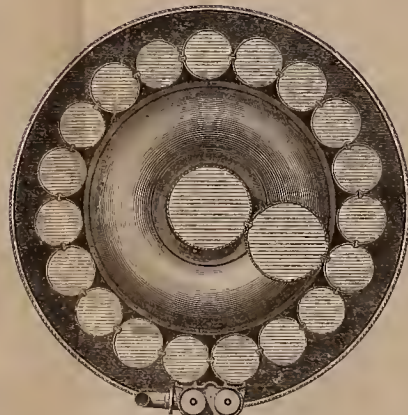

FIG. 4. PLAN AT C. D.

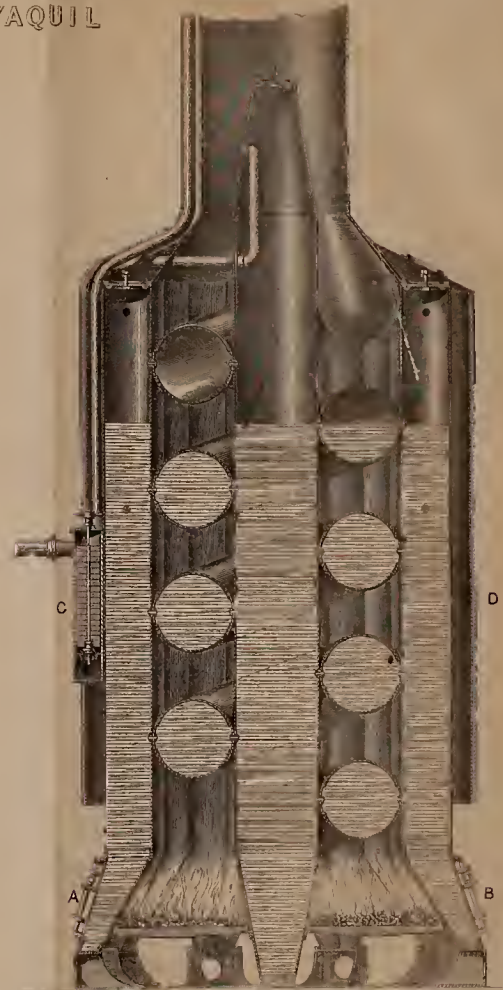

FIG. 2. SECTION





THE ARTIZAN.

No. 218.—VOL. 19.—FEBRUARY 1, 1861.

PURIFICATION OF COAL GAS.

ONWARDS, ever onwards! This may indeed be correctly regarded as the prevailing sentiment of the time in which we live; it is the one idea to which all our efforts seem to be attuned; and the practical progress of the world is in accordance with this desire to be constantly achieving fresh victories over the materials and powers of nature, in rendering these daily more subservient to our necessities and conveniences. In the domain of science, the multitude of discoveries, and new practical applications of known principles, which spring up about us unceasingly, is confusing in their number and variety; and it is a strange thing to speculate upon the enormous tension of human intellect through which is elaborated the thousands of projects intended to help the world forward a little faster than its wont. Projects, bold in their conception, ingenious in their design, laborious in their execution, but often destined, alas! too often, to melt away like the waxen wings of Icarus, when subjected to the fiery test of practical experience, consigning their authors to misery and destruction. It is wonderful to note how, in this 19th century, discoveries crowd upon each other, changing the phases of manufactures, the second often having the effect of rendering the first obsolete almost before it has emerged from babyhood, and being compelled, in its turn, to yield the palm to the ever-encroaching novelties which rapidly succeed to it.

In another part of the present number of our Journal will be found an abstract of a Paper recently read before the Royal Society, containing an account of the method proposed by the Rev. W. R. Bowditch, of Wakefield, for the removal of bisulphide of carbon and other sulphur compounds from coal gas. This is a remarkable discovery, and at the present time as appropriate as remarkable; it is, moreover, a curious instance of the ever-changing character of the relationship between the actual state of applied science, and what may, at any moment, be fructifying in the teeming brains of the thousands of active labourers in the field of invention.

It is probably known to most of our readers that, after common gas has been brought to the highest state of purity that can be attained by the means employed at the present time in gas manufactories, there still remains in the gas (purified, so to say,) a certain proportion of sulphur in a peculiar state of combination, in a condition indeed, in which it is practically inattackable by means known before the date of Mr. Bowditch's invention. It has been a usual thing among chemists to say that the sulphur thus left in the gas exists in the form of bisulphide of carbon; but, in all probability, there are other sulphur compounds besides bisulphide of carbon present in coal gas as it is sent from the gas works. Be that as it may, the important fact is that purified gas (so called) contains sulphur, which, as the gas burns, is oxidised into sulphurous acid gas, and so passes away into the atmosphere with the other products of combustion. It has been a problem, and a most important one too, to gas-makers to devise some method of removing these last portions of sulphur. A few months since a Gas Bill passed into law, regulating, among other things, the quality of the gas supplied to the public by the various gas companies of the metropolis. Under this law it is provided that the quantity of sulphur may amount to, but must not exceed 20 grains in 100 cubic feet of gas. At first sight, it seems strange that the law should recognise the principle of allowing the sale of an article admitted to be impure, and to contain a noxious impurity; but it is obvious that there is no help for the difficulty. The choice is simply between gas with this residual

sulphur, or no gas at all; for the scientific authorities agreed, at the time of the passing of the Bill, that there were no known means of practically removing from gas sulphur in the state in which it exists after the gas has been properly purified in the usual manner. The only remedy was prevention. The bisulphide of carbon is known to be greatly increased in quantity when the coals are distilled at a very high temperature. The obvious course, therefore, was to distill at a lower; but the range of heats in gas-making is limited, and, commercially speaking, gas cannot be manufactured at a low temperature; besides, there are some coals which yield abundance of the bisulphide at the lowest temperature at which gas can be made, and although, therefore, by careful manufacturing, the quantity of this injurious substance may be diminished, its formation cannot be avoided; and after all, the only effectual way of dealing with such an enemy is to attack and subdue him without compromise, as Mr. Bowditch's invention seems likely to do.

The application of coal gas to illumination is unquestionably one of the greatest discoveries of modern times. When indeed, we consider that an ample and economical supply of artificial light is one of the prime necessities of civilised life, we shall perhaps be inclined to class gas-lighting as only next in importance to the various means of obtaining food and fuel. There has however, always existed a strong prejudice against the introduction of gas into private houses. It will be admitted that a good deal of this objection consists in mere prejudice, and those best acquainted with the subject, know that properly manufactured and purified coal gas can be used under all ordinary circumstances with just as much advantage, and superior economy, over any other source of light in private dwellings as in other localities. The prejudice against its use does however exist, and the gas companies, in combatting this prejudice, labour under the disadvantage of being obliged to acknowledge that, in spite of all their efforts to make the gas pure and innoxious, there does continue to exist in it, at the time of its being burned, sulphur, which is converted into sulphurous gas in the act of combustion. That this is an evil which has been greatly exaggerated, every candid person who is competent to judge will at once admit; the statements which have occasionally been put before the public, from an interested point of view, have given rise to a feeling in connection with this matter which is not only erroneous, but which is at variance with the facts of the case. Nevertheless, a strong prejudice exists in the public mind against the use of gas in private rooms; and nothing has so much tended to foster, and indeed, to firmly establish this, as the fact that coal gas, as sent to the consumer, does beyond question contain a considerable quantity of sulphur, which produces a noxious product when burned.

The time seems however to have arrived when the gas companies may be placed in a situation to effectually battle with and overcome an opposition which has kept closed against them a field of profit, compared with which that at present open, is comparatively small. It only remains for the companies themselves to meet this question in a fair and liberal spirit, and to work cordially in endeavouring to apply the invention of Mr. Bowditch in a practical manner. Under the late Act of Parliament already alluded to, the gas companies are permitted to supply gas containing at the maximum 20 grains of sulphur per 100 cubic feet of gas; but this state of things was allowed only as a matter of necessity. It would have been absurd to pass a law requiring gas to be perfectly purified from sulphur in the face of evidence that such purification was at the time impossible.

The case is now however altogether different. Mr. Bowditch points out the method, and public opinion—and if that be not sufficiently strong, the law—must be invoked requiring the gas companies to avail themselves of this invention, which there is every reason to believe is of a practical character, and not the mere dream of a sanguine inventor.

The details of this process will be found in Mr. Bowditch's Paper; and it must be at once confessed that it would be difficult to conceive one which *a priori* would appear more easily adaptable to practical purposes. In this opinion we are strengthened by the authority of the eminent chemists, Dr. Frankland, Mr. Brande, Dr. Lætheby, Mr. Keates, and Mr. Warrington, all of whom have reported favourably of the invention, and of its adaptability to the purification of gas on the large scale. Should however difficulties occur in applying the invention in its present form, there can be no doubt that the first step has been taken towards the removal of a great obstacle to the more extended employment of gas. The path has been indicated, and—by means of Mr. Bowditch or some other of the active intelligences which his discovery will set to work—the time cannot be distant when gas will be delivered to the consumer as free from the residual sulphur as it can already be made from sulphuretted hydrogen, ammonia, or any other noxious constituent.

ON THE STRENGTH OF BOILERS.

By J. MC. F. GRAY.

Fairbairn's experiments on the strength of boiler plates, of internal flues, of flat surfaces, and of rivetted joints have afforded the engineer precise data on which to base his rules for boiler construction. These experiments are described in "Useful Information for Engineers." In making notes from that work for my private use, I have chosen simple co-efficients for bursting strains, taken away the logarithmic character of the formula for collapsing of flues, and based a general law on the experiments on flat surfaces. The following rules, therefore, yield the same results as the various tables of the above work, and they have been framed so that they could be easily remembered, and the most of them calculated mentally. The law for the strength of flat surfaces is similar to that for the collapsing of tubes; and although it has not been pointed out as a law by Mr. Fairbairn, yet it is to his experiments we are indebted for its practical demonstration. As this law is here published for the first time, and may surprise some, I will be more explicit with it than with the others, to show that it is theoretically correct, and that it is also in every respect confirmed by these experiments.

Taking the tensile strength of wrought iron plates at 23 tons per square inch, and the value of a riveted joint at 0.56 of the solid plate, or 28,750 pounds per square inch, Mr. Fairbairn ascribes a tensile strength of 34,000 pounds per square inch to the shell of a cylindrical boiler, as these boilers have the joints arranged to break band with each other. In the following rules for cylindrical shells I have adopted 34,000 as the standard of maximum strength. At the beginning of each rule the degree of approximation to this standard which is attained by using the co-efficients in the rule is indicated by a fractional quantity, in which the numerator is the ultimate strain per inch, and is as near as possible to 34,000. The denominator is the factor of safety for which the rule is constructed. Mr. Fairbairn gives *six* as the factor of safety for new boilers of good construction; this factor is to be taken as a limit to the pressure which a new boiler will bear with safety, and not as a rule for the regular working pressure of the boiler. To allow for deterioration, the bursting pressure of a boiler when new should be at least *eight* times the pressure at which it is intended that the boiler should be used. It is his opinion that "every description of boiler used in manufactories or on board of steamers should be constructed to a bursting pressure of 400 to 500 lbs. on the square inch; and locomotive engine boilers which are subjected to a much severer duty, to a bursting pressure of 700 to 800 lbs.

At page 43 there is a table for thickness of the plates of a cylindrical boiler in decimal parts of an inch for a bursting pressure of 450 lbs. to the square inch, strain 34,000 lbs. per square inch: on examining the figures it appears to be calculated to a strain of 32,400—or, otherwise, that the pressure is not 450 but 472. The first of the following rules gives a result corresponding to that table.

CYLINDRICAL SHELLS—INTERNAL PRESSURE.

(Diameter in feet, thickness in inches, pressure in pounds per square inch.)

1. $\left(\frac{32400}{1}\right)$ The thickness of the shell in inches for a bursting pressure of 450 lbs. per square inch is the diameter in feet divided by 12.

2. $\left(\frac{33600}{8}\right)$ The working pressure is 700 times the thickness divided by the diameter.

3. $\left(\frac{33600}{8}\right)$ The thickness of plates required for a cylindrical boiler is equal to the (product of the diameter by the working pressure) divided by 700.

4. $\left(\frac{33600}{8}\right)$ The greatest diameter of shell with a given thickness of plates and a given working pressure is 700 times the thickness divided by that pressure.

5. $\left(\frac{34000}{8}\right)$ For the working pressure of cylindrical boilers constructed of $\frac{3}{8}$ plates, divide the number 263 by the diameter of the boiler in feet.

6. $\left(\frac{34000}{8}\right)$ For the working pressure of cylindrical boilers constructed of $\frac{1}{2}$ -inch plates, divide the number 354 by the diameter in feet.

COLLAPSING OF INTERNAL FLUES.

The experiments conducted by Mr. Fairbairn under the sanction of the Royal Society enabled him to establish a formula of strength for internal round flues. That formula is

$$P = 806,300 \frac{K^{2.19}}{LD}$$

Where P is the bursting pressure, K the thickness of the plate in inches, L the length of the flue, and D its diameter, both in feet.

This formula cannot be used but with the aid of logarithms, because of the index 2.19. Instead of this I have constructed the following rules.

7. The collapsing pressure of an internal cylindrical flue is 66 times the square of (one less than the number of thirty-seconds of an inch in the thickness of the plate), divided by the (product of the length by the diameter), both in feet.

8. The square root of the (product of the collapsing pressure, by the length, by the diameter, divided by 66) increased by 1, is the thickness of the plate in thirty-seconds of an inch.

The degree of approximation attained by this rule is, it is one-five-hundredth part of an inch below the thickness in the table for a flue 10 feet long, 1 foot diameter; and it is one-fiftieth of an inch above the thickness for a flue 30 feet long, 4 feet diameter, the collapsing pressure being 450 lbs. per square inch in both. The two rules agree when the plates are $\frac{1}{2}$ of an inch thick, also when the plates are $\frac{2}{16}$ of an inch thick; between these, this rule gives thinner plates, the greatest difference being when the plates are about $\frac{3}{8}$ of an inch thick; this rule gives the thickness $\frac{1}{300}$ of an inch less than is found by the logarithmic formula. For all other thicknesses this rule errs in excess of strength, and may thus be used for all plates from $\frac{3}{16}$ of an inch to $\frac{1}{2}$ of an inch thick.

STRENGTH OF FLAT STAYED SURFACES,

Such as the sides of the fire-box of a locomotive boiler, the stays being screwed into the plate without nuts.

From an examination of the sketch of the boxes experimented on by Mr. Fairbairn, showing the bulging of the plates, it appears that before the box burst, by one of the stays being drawn through the plate, the bulging of the plate was continued close up to that stay *without contrary flexure*, forming a conical surface around the stay. The plate gives way first at the insertion of the stay; at the inner edge of the hole the plate will be in a state of extension, and at the outer edge in a state of compression; and the *ultimate angular deflection* of the surface of the plate around the stay will be the same for equal thickness of plate whatever be the distance between the stays. The ultimate angular deflection at the stay being thus a constant, the ultimate linear deflection midway between the stays will be *simply as the distance of the stays*. If the conditions of the strains were such that the box would burst by the plate's rending at the middle of the bulgings, or midway between the stays, the ultimate pressure would be such that the total load on a square contained by four stays would be the same, whatever the distance of the stays might be. The ultimate linear deflection would then be as the square of the distance of the stays, as in beams of equal depth. In a beam the deflection is proportional to the load. If equal loads would produce deflections proportional to the square of the distance, loads which are *inversely as the distance of the stays* would produce deflections proportional to the distance *simply*. But the stay is drawn through the plate when the linear deflections are as the distance *simply*, therefore the ultimate load upon each square will be *inversely as the distance between the stays*.

The pressure per square inch is the total load per square between four stays, divided by the square of the distance between the stays; therefore the ultimate pressure per square inch will be *inversely as the cube of the distance between the stays*, for equal thickness of plates. For a different thickness of plates the pressure will be proportional to the square of the thickness of the plate.

It may appear from the tables of the progressive swelling of the sides of

the boxes that the bulging did not follow this law. I apprehend that the bulging noted in the table with the first experiment is the swelling of the iron plate, not of the copper one. It was the copper plate that failed, and the sketch appears to agree with my reasoning on the subject.

Having now arrived at the form of the law, these experiments will afford us co-efficients, and will enable us to confirm the above principles.

As in the rule for the strength of internal flues I have taken the thickness in thirty-seconds of an inch, I will do the same here.

9. The bursting pressure of stayed flat-iron plates is 720 times the (square of the thickness in thirty-seconds of an inch) divided by the (cube of the distance of the stays in inches).

10. The distance from centre to centre of the stays is equal to the cube root of {720 times the square of the thickness in thirty-seconds of an inch} divided by the bursting pressure.

11. The thickness of the plates in thirty-seconds of an inch is equal to the square root of {the product of the (cube of the distance of the stays) multiplied by the bursting pressure, divided by 720}.

12. For working pressures use 90 instead of 720. For copper plates use 400 for bursting pressure and 50 for working pressure.

These rules agree thoroughly with the experiments, and, as a corroboration of the principle, we can examine the ratio between the co-efficient for iron and that for copper. These co-efficients are to each other as 100 to 55½. The tensile strength of iron and copper stays were, by an experiment in the same appendix, found to be as 28,760 to 16,265, or as 100 to 56½. It may, however, be fairly objected that relative tensile strength is no criterion of these co-efficients. At page 129 of the above work the

strength of wrought iron plates and of copper plates is given both for tension and compression, and the sum of the tension and compression in iron is to their sum in copper as 35 is to 19 or as 100 to 54½.

This rule does not apply when the plates are stiffened by angle irons or washer plates, but it shows the necessity of these when the stays are not as close as this rule would demand.

ROUND STAYS.

The tensile strength of wrought iron is taken at 23 tons, or 51,520 lbs. per square inch. The strain upon the section of each stay ought not to exceed one-eighth of this in fresh water boilers, that is, 6440 lbs. In boilers using salt water the factor of safety should be at least ten, or, the strain per square inch should not exceed 5152 lbs. In the following rules the co-efficient 5000 for fresh water gives a strain equal to 6361 lbs. per square inch. The co-efficient 4000, to be used for salt water, gives a strain equal to 5089 lbs. per square inch.

Note.—When the boiler is for salt water, use 4000 instead of 5000 in the following rules:—

13. The working pressure per square inch is 5000 times the (square of the diameter of the stay) divided by the (square of the distance of the stays).

14. For every given pressure there is a constant ratio between the distance of the stays and their diameters. That ratio is the square root of (5000 divided by the working pressure per square inch).

15. If the ratio of distance to diameter be given, the pressure is found by dividing the number 5000 by the square of that ratio.

TABLE OF FORMULÆ FOR STRENGTH OF BOILERS.

		D = Diameter in feet. L = Length in feet. T = Thickness in inches. t = Thickness in thirty-seconds. d = Diameter of stays in inches, at smallest part.			B = Bursting pressure in pounds per square inch. C = Collapsing pressure ditto P = Working pressure ditto S = Distance between stays in inches. R = Distance between stays in diam. of the stay.
Cylindrical Boilers		Strain per inch. $\frac{32400}{1}$	$B = 450$	$T = \frac{D}{12}$	$D = 12 T$
Ditto ditto		$\frac{33600}{8}$	$P = \frac{700 T}{D}$	$T = \frac{D \cdot P}{700}$	$D = \frac{700 T}{P}$
Ditto ditto		$\frac{34000}{8}$	$P = \frac{263}{D}$	$T = \frac{3}{8}$ -inch.	$D = \frac{263}{P}$
Ditto ditto		$\frac{34000}{8}$	$P = \frac{354}{D}$	$T = \frac{1}{2}$ -inch.	$D = \frac{354}{P}$
Internal Flues, from $\frac{2}{10}$ in. to $\frac{3}{2}$ in. plates		$\frac{34000}{1}$	$C = \frac{66 (t - 1)^2}{L D}$	$t = 1 + \sqrt{\frac{C L D}{66}}$	$D = \frac{66 (t - 1)^2}{C L}$
Stayed Flat Surfaces, such as the sides of the fire-box of a locomotive boiler, the stays being screwed into the plates without nuts	Iron	$\frac{31520}{1}$	$B = \frac{720 t^2}{S^3}$	$t = \sqrt{\frac{B S^3}{720}}$	$S = \sqrt[3]{\frac{720 t^2}{B}}$
		$\frac{51520}{8}$	$P = \frac{90 t^2}{S^3}$	$t = \sqrt{\frac{P S^3}{90}}$	$S = \sqrt[3]{\frac{90 t^2}{P}}$
	Copper	$\frac{28622}{1}$	$B = \frac{400 t^2}{S^3}$	$t = \sqrt{\frac{B S^3}{400}}$	$S = \sqrt[3]{\frac{400 t^2}{B}}$
		$\frac{28622}{8}$	$P = \frac{50 t^2}{S^3}$	$t = \sqrt{\frac{P S^3}{50}}$	$S = \sqrt[3]{\frac{50 t^2}{P}}$
Round Iron Stays, with fresh water..		$\frac{50928}{8}$	$P = \frac{5000 d^2}{S^2}$	$d = S \sqrt{\frac{P}{5000}}$	$S = d \sqrt{\frac{5000}{P}}$
Ditto ditto ditto ...		$\frac{50928}{8}$	$P = \frac{5000}{R^2}$	$d = \frac{S}{R}$	$R = \sqrt{\frac{5000}{P}}$
Ditto with salt water.....		$\frac{50928}{10}$	$P = \frac{4000 d^2}{S^2}$	$d = S \sqrt{\frac{P}{4000}}$	$S = d \sqrt{\frac{4000}{P}}$
Ditto ditto		$\frac{50928}{10}$	$P = \frac{4000}{R^2}$	$d = \frac{S}{R}$	$R = \sqrt{\frac{4000}{P}}$

The following table gives these ratios, which are the distances between the stays expressed in diameters of the stay. Thus at 50 lbs. pressure in a fresh water boiler, the distance between the centres of two stays is ten times the diameter of a stay.

Ratio.	Pressure, fresh water, lbs. per sq. in.	Pressure, salt water, lbs. per sq. in.
4	312	250
5	200	160
6	139	111
7	102	81
8	78	62
9	61	49
10	50	40
11	41	33
12	35	30
13	30	24
14	25½	20
15	22	17
18	15½	12½

16. The diameter of the stay is equal to the distance between the stays divided by the square root of (5000 divided by the working pressure).

17. The distance between the stays is equal to the diameter of the stay multiplied by the square root of (5000 divided by the working pressure).

In the rule for flat surfaces I have assumed that the strength would vary as the square of the thickness of the plate. The experiments referred to do not enable us to test the truth of this, because the plates were of the same thickness in both experiments. In the collapsing of flues the strength increases in a higher ratio than that of the square of the thickness; but again, in experiments on the resistance of wrought-iron plates to pressure by a blunt instrument at right angles to the surface, it was found that the strengths were simply as the thickness. If this holds good in the case of flat surfaces submitted to steam pressure, the formula would be:

$$B = \frac{8666t}{S^3}, \text{ for iron plates.}$$

$$B = \frac{6370t}{S^3}, \text{ for copper plates.}$$

And here again we have co-efficients which are proportional to the tensile strength of iron and of copper, so that these data do not determine whether the strength is as the thickness, or as the square of the thickness of the plates. For ¾ inch iron plates or for ½ inch copper plates, either rule will give the same result.

THE SPEED OF ARMOURD SHIPS.

BY CHARLES ATHERTON, CHIEF ENGINEER OF H.M. DOCKYARD,
WOOLWICH.

The properties of armoured ships as respects the desirableness of high speed having engaged public attention, and popular impressions with reference to the conditions under which progressively increasing rates of speed are to be obtained being extremely indefinite and generally erroneous, I beg to offer a few remarks, in the hope of elucidating this subject, for which purpose the data of construction and equipment of the *Warrior*, as published in the *Times* of the 29th ultimo, afford an eligible opportunity. Assuming these data to be authentic, it appears that the load displacement of the *Warrior* will be 9000 tons; that the engines, of 1250 nominal horse-power, will weigh 950 tons; that the stowage for coal, 950 tons, is enough for rather more than 6 days' consumption, say 6½ days, being at the rate of 152 tons per day, or 126·66 cwt. per hour, and that the speed of the ship is expected to be at the rate of fourteen knots per hour.

These data assign to the *Warrior* prospectively a very high scale of dynamic duty with reference to the consumption of fuel, for when judged of by the formula $\frac{V^3 D^{\frac{3}{2}}}{w} = C$ (w being the consumption of coal per hour expressed in cwt.), the co-efficient C becomes $C = 9333$, which is, I believe, higher than has hitherto been realised by the continued sea-service of any ship, and is identical with that on which Coal Table No. 3, "Steamship Capability," p. 96, has been calculated, demanding a combination of excellence in hull and engine construction of which it is to be hoped the *Warrior* will be an example.

It also appears that the weight of armament of the *Warrior*, which, combined with the endurance of the ship at full speed, may be regarded as the measure of the effectiveness of the ship for aggression will be 1500 tons; consequently, the weight of the hull of this armoured ship of 9000 tons load displacement, after deducting weight of engines, coals, and armament, will be 5600 tons, or 62 per cent. of load displacement of the ship, being from 15 to 20 per cent. heavier than ships of the same load displacement of ordinary build, and this it is which, in combining high speed with long endurance under steam, causes the necessity of unusual magnitude in the construction of armoured ships.

Seeing, now, that various steamships attain the speed of 18 knots per

hour—for example, the Holyhead and Dublin mail packets—and that high speed has been much insisted upon as essential to the efficiency of armoured ships, my object now is to demonstrate the conditions of construction as respects size and power which would be required in order that an armoured ship of the *Warrior* type might attain the speed of 18 knots per hour and carry an armament of 1500 tons weight, and coal enough to steam at the reduced speed of 14 knots per hour continuously for 6½ days, thus possessing the same aggressive power, and the same steaming endurance at 14 knots per hour as the *Warrior*, but in addition commanding the speed of 18 knots per hour, when so required, so long as her coals will last.

To increase the speed from 14 to 18 knots per hour may appear, at first sight, to be a simple matter—merely demanding that the engine power should be increased in the same proportion—but the fact is, that the engine power, and consequently the weight of the engine, would be required to be increased in the proportion of the cubes of the speeds, thus demanding an increased size of ship, as measured by load displacement, to carry the increased weight, and this increased ship again demanding still further increased power to attain the required speed; thus the problem becomes complicated, but the following calculation, chiefly deduced from the tables before referred to ("Steamship Capability," page 96, second edition,) shows that, in order to realise the before-mentioned conditions, the load displacement of our armoured ship requires to be increased from 9,000 to as much as 15,000 tons. For example: assuming 15,000 tons to be the required displacement, the weight of the hull at 62 per cent. will be 9,300 tons; the engine-power required to propel this ship of the *Warrior* type, at the speed of 18 knots per hour, will, by received rules in steamship dynamics, be three times that required to propel the *Warrior* of 9000 tons at 14 knots per hour; and the weight being increased in the same proportion, we have 2850 tons as the weight of the engines; also, by the formula $\frac{V^3 D^{\frac{3}{2}}}{w} = 9333$, the assumed co-efficient of the *Warrior*, the weight of the coal (w) to propel this ship of 15,000 tons displacement at 14 knots per hour will be 178·33 cwt. per hour, or 214 tons per day, at which rate the quantity required for 6½ days' consumption will be 1338 tons. Hence, we have weight of armoured hull 9300 tons; weight of armament 1500 tons; weight of engines for steaming at 18 knots per hour, 2850 tons; coal for 6½ days' steaming at 14 knots per hour, 1338 tons; making the total load displacement 14,988 (say 15,000) tons. The displacement of the Holyhead and Dublin Mail Packets, when steaming at the speed of 18 knots per hour, is understood to be about 2500 tons; but in this case the weight of hull probably does not exceed 40 per cent. of the load displacement; the cargo consists merely of a few passengers and mail-bags, and the coal is only required to be sufficient for about six hours' consumption, which conditions are altogether different from those required in armoured ships of war.

The comparative steaming endurance of the two ships now under consideration would be as follows:—

"WARRIOR,"

as constructed for 14 knots speed, with 9000 tons displacement. Coal, 950 tons.

At 10 knots, the consumption would be 55·6 tons per day, lasting 17 days.

At 12 knots, the consumption would be 96 tons per day, lasting 10 days.

At 14 knots, the consumption would be 152 tons per day, lasting 6½ days.

Above 14 knots not attainable, the engine-power being limited to that speed.

"WARRIOR," ENLARGED

if constructed for 18 knots speed, with 15,000 tons displacement. Coal, 1338 tons.

At 10 knots, the consumption would be 78·2 tons per day, lasting 17 days.

At 12 knots, the consumption would be 135 tons per day, lasting 10 days.

At 14 knots, the consumption would be 214 tons per day, lasting 6½ days.

At 16 knots, the consumption would be 320 tons per day, lasting 4 days.

At 18 knots, the consumption would be 456 tons per day, lasting 3 days.

Thus we see that the steaming endurance of the two ships would be equal up to 14 knots per hour, but that, in order to attain the superior capability of steaming for three days, at the speed of 18 knots per hour, we require to increase the size of the armoured ship from 9000 to 15,000 tons load displacement, and to treble the engine power, whereby the cost of the ship would be probably doubled—or two such ships as the *Warrior*, limited to 14 knots speed, would be built for the cost of one ship constructed for 18 knots, though limited to the same amount of armament—1500 tons—and the same steaming endurance, viz., 6½ days at the speed of 14 knots per hour. The question therefore becomes, whether two ships of the capabilities of the *Warrior*, as now constructed for 14 knots speed, would, in their co-operation, be more or less effective than one ship constructed for 18 knots speed, but carrying only the same armament—a

question most interesting to naval men—but in regard to which my object has been merely to open up the mechanical considerations of the case. Practically, there is no limit to magnitude and speed; it is a mere question of money; and, whether ships be built of wood or of iron, is, practically, a mere question of appliances and tools.

GOVERNMENT TROOP STEAMER FOR THE INDUS.

On Wednesday, the 23rd of January, a satisfactory trial trip took place on the Thames of a very peculiarly constructed steamer, intended for the conveyance of troops upon the Lower Indus, and which still further carries out the "spoon-ended" principle of construction, described and fully illustrated in THE ARTIZAN of July, 1860. A numerous company of persons interested in marine engineering were present on board, among whom may be mentioned Mr. Dinnen, the Admiralty Inspector of Machinery; Mr. Luke, Admiralty Surveyor of Shipping; Captain Robertson, of the Board of Trade; Mr. Blake, of the firm of Messrs. James Watt and Co.; Mr. Pearce, of the firm of Messrs. M. Pearce and Co.; Mr. Atherton, Chief Engineer of H.M. Dockyard, Woolwich; Mr. Henry S. Pitcher, of Northfleet Dockyard, and many others. This vessel is one of a series of various dimensions, recommended by a commission appointed by Government in 1857 to investigate the subject of river navigation, and to report on the best class of vessels for service on the rivers of India. The commission consisted of the late Colonel Crawford, of the Indian Engineers; Captain Balfour, of the Indian Navy; and Mr. T. B. Winter, Consulting Marine Engineer. The rivers of India are usually broad, although their best channels are at various places comparatively narrow. In general, these rivers are tortuous, shallow, very rapid in flood seasons, and abound in shifting sand-banks. The form of boat recommended by the above commission as best adapted to meet these circumstances is popularly known as "spoon-ended," dispensing entirely with any approach to an angular form at either end of the vessel, in order to counteract, as far as possible, the difficulties to steering caused by the cross currents of the rivers, and also to reduce the labour of hauling the vessel off a sandbank, should she at any time run aground. For ordinary purposes tug-vessels, with barges attached thereto, were recommended, but for the all-important service of the speedy conveyance of troops, the necessity for which was so apparent during the late Indian rebellion, vessels of the class about to be described were advised. Mr. T. B. Winter, the engineer member of the commission, was subsequently instructed by Government to prepare the plans and specifications of the various vessels above referred to, and was then intrusted with the charge of superintending their construction in this country. The vessels are sent out to India in pieces and completed there; but one tug, and now this larger steamer, have been finished for previous trial in this country.

The hull of the present troop steamer has been built by Messrs. M. Pearce and Co., of Stockton-on-Tees, where the vessel was "cotted" together, and afterwards was brought up in pieces to the Victoria (London) Docks, where she has been rivetted and finished. The engines are by Messrs. James Watt and Co., of London and Birmingham. The dimensions of the steamer are:—Length over all, 377ft.; beam, 46ft.; breadth over paddle-boxes, 74ft.; depth, 5ft.; ditto, at paddle shafts, 12ft.; ditto, to top of arched girders, 18ft.; working draught of water, 2ft.; displacement at 2ft. draught, 739 tons; tonnage (old measurement), 391 tons. Accommodation is provided on board for about 800 troops and their officers. The engines are 220 nominal horse-power, having horizontal cylinders of 55in. diameter and 6ft. stroke. The diameter of the paddle-wheels is 26ft., and the breadth of the floats, or paddle-boards, 12ft. There is a separate pair of small oscillating engines, intended to assist in maintaining a vacuum for the main engines when the navigation becomes intricate. These engines likewise work crabs for hauling the vessel off sand-banks. The hull of the troop steamer is constructed entirely of puddled steel, made by the Weardale Company, near Durham, and the average tensile strength of which is 42 tons per sectional square inch, or double that of boat-plate iron. The vessel is built throughout of excessively light scantlings; and, although she is of necessity less rigid than a ship intended for sea service, she is rendered strong by means of the class of framework adopted. She is strengthened longitudinally by four arched girders—two at the sides, rising to the height of 12ft., to carry the paddle-wheels, &c., and extending about 130ft. in length on deck. The other two, or main girders, run fore and aft, about 10ft. from the sides of the vessel; these are 18ft. high in the centre, and extend nearly the whole length of the ship. In walking fore and aft on the maindeck you pass underneath the paddle-shafts. Athwartships, the vessel is strengthened through the engine and boiler space by twelve overhead beams or girders, extending the whole breadth of the vessel and carrying the stays by which the sponsons are suspended. Beyond the space occupied by the engines and boilers, she is framed again athwartships by trusses under the maindeck, repeated every three feet, and which resemble in principle the framework of an iron roof.

She is steered at each end by means of "blades," which, instead of being worked from side to side in the ordinary manner of rudders, are caused to rise or lower into the water at the proper angle. When out of action these blades are completely within boxes or wells formed for their reception. Both sets are actuated simultaneously by steering wheels, placed towards the head of the vessel, and provision is made to work one set only should an accident occur to the other. The principle of this ingenious arrangement is patented by the inventor, Mr. A. Chaplin, of Glasgow. There are two tiers of cabins placed one above the other; and these, as on board American river steamers, are houses rising above the vessel's maindeck. They are entirely surrounded with Venetian panels for the admission or exclusion of air. The tops of the upper tier of cabins form the chief promenade-deck. The saloon and state rooms for the officers are at the fore end of the vessel. No attempt at ornamental work has been made; everything being as plain as possible. The berths for the troops are composed of frames of galvanized iron covered with perforated sheet zinc, for the free circulation of air. In each main troop room there is an officer's cabin partitioned off, and the accommodation for the troops is divided into five compartments, so as to permit of separation in case of sickness. Fresh air, drawn from the paddleboxes, in order that it may absorb moisture, is supplied to the cabins (by fans worked with the steam power) in sufficient quantity to change the whole amount in each troop room every half-hour. These fans are independent of the engines, and can be worked while the ship is lying to for the night, as all navigation on the Indus ceases at dark. The engineers' cabins are placed on the extensive sponsons, where are also bath-rooms and other accommodations, poultry-houses, sheep-pens, &c. The whole vessel is covered with an awning of the strongest sailcloth, the area of which may be estimated by the fact of its weighing three tons. The extensive framework for supporting this awning has received especial attention, and while every care has been taken to reduce weight by making all the stanchions and stays tubular, they are, nevertheless, very substantial. The handrails all round the main and promenade decks are also tubular, and advantage has been taken of this form to make it serve as a speaking tube from the pilot to the engine-room. The engineering difficulty in the construction of this vessel was, to adopt such a class of framework that, while still possessing great strength, the quantity or weight of metal used in building her should be so small as to ensure the excessively limited draught of two feet. In principle, the general arrangement, and also many of the plans for stiffening and strengthening this vessel resemble the American river steamers, very many of which nearly approach it in the dimensions of length and beam, and one of which is believed to be about 30ft. longer and 4ft. wider. Some vessels on the Rhone are 100ft. longer than this troop steamer, but not so wide. The draught of water, however, both of the larger American and Rhone boats is seldom so little as 4ft., or double that of Mr. Winter's design. The cabins of the American boats frequently rise from 40 to 50ft. above the maindeck, whereas those of the *Indus* troop-steamer do not exceed 15ft.; so that, although the hold on the water due to the 2ft. draught is less than that of the American boats which have so long and successfully navigated the Hudson and the Mississippi, the troop steamer has proportionately less top hamper. The vessel was tried up and down on the measured miles in Long-reach and Gravesend-reach, the average speed attained being 10·26 knots = 11·80 statute miles per hour, the engines running on an average twenty-five revolutions per minute; the indicated horse power was calculated as very nearly 1250; when working without condensation (for which express provision is made) they ran from 15 to 17 revolutions per minute, and the ship made 9½ statute miles per hour. Her steering qualities are very good, and the ease and rapidity with which she is turned round is remarkable; notwithstanding her great length she was found to turn completely round in a circle, the diameter of which was less than one-and-a-half times her length, in three minutes and forty-four seconds. The prevalent opinion of the many competent authorities acquainted with the requirements of the Indian service was, that this troop steamer for the navigation of the *Indus* would effectively fulfil the purpose for which she is intended. We trust, however, that the swell of the Indian rivers will not injure or affect the stability of the structure of this vessel.

PLANS AND SECTION OF THE PACIFIC STEAM NAVIGATION COMPANY'S SCREW STEAMSHIP "GUAYAQUIL."

(Illustrated by Copper-plate Engraving, No. 184.)

Having been frequently requested for detailed particulars of the above vessel, as fitted by Messrs. Randolph, Elder, and Co. with their improved engines, boilers, and machinery, we presented our readers in our last issue with the above plate—the reference to which, and other useful information in connection with the performance of the *Guayaquil*, we now append; this vessel and the *San Carlos* being sister ships. An article upon the latter vessel will be found in THE ARTIZAN vol. for 1860, pp. 68, 69; and a highly-finished copper-plate engraving, No. 187, illustrative of Mr. Elder's patent cylindrical spiral boiler, as fitted on board these screw steam-

ships, will be found in our present number. Our readers, will, doubtless, be thoroughly familiar with this latter subject from the report of Mr. Elder's very able paper upon the cylindrical spiral boiler, read before the British Association at the Oxford meeting last year, which we gave *in extenso* in our British Association Supplementary Number, July 15th, 1860; and in the tables, which will be found in the same number, appended to the report of the Steamship Committee, will be found arranged in a very convenient manner for reference;—full, and very detailed particulars, as to dimensions, performances, &c., of the several vessels of the Pacific Steam Navigation Company's fleet, which have been fitted with Messrs. Randolph, Elder and Co.'s improved engines, boilers, and machinery. In addition to which we have, in various numbers of THE ARTIZAN, published of late, presented our readers with a very valuable series of plates illustrative of the engines, boilers, and machinery of these vessels, as also various engravings of the vessels themselves.

On reference to plate 184 of the *Guayaquil*—Fig. 1 is the longitudinal sectional elevation; fig. 2, upper deck plan, and fig. 3, lower deck plan thereof. In fig. 2, A is the binnacle; B, capstan; C, captain's room and office; D, skylights; E, mast; F, steam winch; G, main hatch; H, engine skylight; I, range; J, scullery; K, galley; M, baker; N, second officer's cabin; O, chief engineer's cabin; P, chief officer's cabin; Q, mast; R, steam winch; S, cargo hatch; T, skylight; U, stock; W, butcher's cabin; X, boatswain's stores; Z, skylight. In fig. 3;—A, main hatch; B, ladies' cabin; C, W. C.; D, pantry; E, bar; F, bath; G, napery; H, luggage; I, second and third engineers' cabin; J, carpenter and boatswain's cabin; K, officers' cabin; L, chief steward's cabin; M, purser's cabin; N, mails; O, napery; P, state-room; Q, pantry; R, state-room; S, cargo hatch; T, tables; U, tables; V, sideboard; W, stores.

The *Guayaquil* and the *San Carlos* are both iron-built vessels. The chief dimensions, as given in the table before referred to, are as under, viz.:—Length between perpendiculars, 195ft.; breadth, 30ft.; area of greatest section on actual sea performance (Dec. 31st, 1859, to Feb. 21st, 1860), 310 sq. ft.; draft of water, forward, 13ft., aft, 14ft. 1in.; displacement, 935 tons. She is fitted with inverted direct-acting screw engines upon Messrs. Randolph, Elder, and Co.'s patent double cylinder expansion principle. There are two large or low pressure cylinders 53in. diameter, and two small or high pressure cylinders, 31in. diameter. The length of stroke is 4ft; the total weight of engines, 70 tons. She is fitted with one of Mr. John Elder's patent spiral flued boilers of the same general dimensions as the *San Carlos*, illustrated (by plate 187), and described in the present number.

We may add that from reports recently received, the sea-performance of this vessel in the Pacific is highly satisfactory.

THE CYLINDRICAL SPIRAL BOILER.

BY MR. JOHN ELDER.

(Illustrated by Copper-plate Engraving No. 187).

We present our readers this month with a copper-plate engraving of Mr. John Elder's patent cylindrical spiral boiler, as fitted on board the screw steamships *San Carlos* and *Guayaquil*.

We repeat here the advantages which this kind of boiler appears to possess over the ordinary marine boiler—viz.:—

1. A form of boiler capable of carrying higher pressure, and presenting more heating surface, and of a more effective description from a given weight of material.

2. A boiler capable of being easier cleaned and repaired in both water and fire spaces.

3. A boiler capable of producing, without any extra apparatus, superheated steam to any practical temperature.

4. A less average specific gravity of water whilst working at sea with the usual amount of feed and blow-off, and a more perfect combustion chamber, and better formation of flue surface.

5. The pressures being altogether internal, the boiler is not liable to collapse—a danger of late so ably demonstrated by Mr. Fairbairn; and as the diameters of the various cylinders are reduced to the minimum size for permitting the workmen to pass through, clean, and repair them, the boiler when formed of ordinary thickness possesses enormous strength without stays.

6. The expense of the boiler per square foot of heating surface is about the same as the ordinary boiler, and is capable of carrying five times the pressure.

For any further description of this boiler we refer our readers to THE ARTIZAN (Supplement), July 16, 1860.

In our plate, No. 187, Fig. 1 is a vertical elevation of the cylindrical spiral boiler, as fitted on board the Pacific Royal Mail Company's Steamships *San Carlos* and *Guayaquil*, by Messrs. Randolph, Elder, and Co., the exterior casing which surrounds the circumferential vertical

tubes (and which are shown in Figs. 2 and 4) being in this view removed. Fig. 2 is a vertical section of the same. Fig. 3 is a section across the line A B. Fig. 4 is a section across the line C D.

The principal dimensions and particulars of this boiler are the following:—

Diameter of boiler	12ft.
Height of ditto	24ft.
Weight of boiler, empty	30 tons
Total weight of boiler, with water	55 "
Content of steam room	1000 cubic ft.
Ditto of water room	1200 "
Number of furnaces	1
Content of furnace and combustion chamber... ..	600 cubic ft.
Grate surface	74 square ft.
Heating surface... ..	2200 "
Distance from fire-bars to spiral	from 2ft. to 7ft.
Ditto from fire-bars to bottom of ashpit	from 2ft. to 1ft. 6in.
Actual air space through fire-bars... ..	20 sq. ft.
Diameter of ebimney	5 ft. 4in.
Load on safety valve... ..	52lbs. per sq. in.
Average consumption of fuel per hour	1120lbs.

THE ROYAL SOCIETY.

ON COAL-GAS.

BY THE REV. W. R. BOWDITCH. COMMUNICATED BY PROFESSOR WILLIAM THOMSON.

A distinguished Fellow of the Royal Society discovered coal-gas, when Rector of Crofton, about two miles from my present parish, and nearly all our knowledge of this complex substance is derived from the labours of chemists who have been, or are, Fellows of the Society. I feel assured, therefore, that an attempt to extend the knowledge of the reaction of coal-gas with various substances will be favourably received, and that the application to practice of the facts made known, will not render a memoir less acceptable to the Society which rewarded alike the abstract researches of Leverrier and the practical ones of Arnott.

Six years ago I introduced the use of clay into gas-works, for the purpose of improving the purification of coal-gas, and now,—after so long an experience, the purification of many hundreds of millions of feet of gas, and the use of many thousand tons of the refuse as manure,—I venture, for the first time, to submit the ground upon which my process is based.

Coal-gas may conveniently be considered under the heads of carbon compounds required for the production of heat and light, which generate water and carbonic acid by their combustion; and sulphur and nitrogen compounds which are not necessary for heat and light, and ought to be removed from gas on account of the injurious nature of the substances produced by their combustion.

The former of these classes will be treated of incidentally; the latter class forms the principal subject of this paper. When speaking of *gas*, I always refer to that which has undergone the ordinary condensation of gas-works, wherefore no mention is made of the complex compounds removed by condensation.

When coal is distilled, its nitrogen is evolved in some forms of combination which are generally familiar, while others are almost unsuspected. Under certain conditions of distillation, much nitrogen leaves the retorts and passes the condenser as ammonia or some of its salts. These are all removed from gas by clay, so that no trace of ammonia can be discovered after gas has passed through purifiers charged with an adequate quantity of clay, and with lime or some equivalent substance to move sulphide of hydrogen. Clay is thus entitled to be classed with acids and some metallic salts as a purifier of gas, for these, of course, remove ammonia and its salts. But between clay and acids there is an important difference, in regard to the action which takes place upon the most valuable light-giving constituents of the gas; acids remove a large quantity of these, clay does not. We have experimental proof that clay does not remove the valuable hydrocarbon vapours from gas, in the fact that strong spirit of wine digested upon foul clay for days, does not thereby become much more luminous than it was before being so treated. The very slight light-giving power which it has obtained is due to tar; for if the spirit be evaporated, and the tar so obtained be redissolved in fresh spirit, the same kind of flame will be obtained as before; whereas the addition of a small portion of coal-oil to spirit gives a flame of considerable illuminating power. To this I may add, that long and extensive experience shows that the employment of clay in the purifying process improves the light-giving power of gas, by removing substances which are not otherwise removed, and which, if allowed to be burnt with the gas, lessens its illuminating power. These light-damaging compounds are produced during the later portion of the distillatory process, as I have proved by experiment. The same retort was charged twice with the same weight of the same coal. The gas produced by one charge was purified by lime only, that produced by the other charge was purified by lime and clay. The illuminating power of the gas passing at each half-hour's end was determined, and it was found that the purification made no difference for the first three or four half-hours. About the middle of the charge, that purified by my process had slightly the advantage, and at the close the difference in favour of that purified by the addition of clay has been found as much as ten or twelve per cent. Thus it is shown that the compounds removed by clay from gas produced during the early stages of distillation—however objectionable on other accounts—do not lessen the light-giving power of gas, whereas those removed during the later periods of distillation reduce the light-giving powers considerably.

If conjecture be allowable, I would venture an opinion that cyanogen compounds and other nitrogenised substances with which foul clay abounds, are those which lessen light. My own investigations lead directly to this inference, and, I think, explain an old table by Dr. Henry in this sense. In the "Philosophical Transactions" for 1808, he shows that the gas produced from 112lbs. of Cannel coal contained, after purification, the following quantities of nitrogen:—

Hours from commencement of distillation.	100 measures of purified gas contain measures of nitrogen.	
$\frac{1}{2}$ an hour.	20	} Due chiefly to atmospheric air. Probably the time when ammonia was principally produced.
1 hour	$4\frac{1}{2}$	
3 "	5	
5 "	15	
7 "	15	
9 "	15	} Probably vapour of water was present in very small quantity, and cyanogen and related compounds were produced in increasing quantity.
$10\frac{1}{2}$ "	20	
12 "	20	

Without assuming the absolute accuracy of these figures, we may regard them as valuable indicators, pointing, I think, in the direction I have ventured to conjecture.

A beautiful reaction furnishes experimental proof of the damage done to gas by acids. Clean deal sawdust is well moistened with pure sulphuric acid, diluted with five or six volumes of water, so that the sawdust may not be discoloured, and gas is passed through it in a slow stream. With rich gases, which give the light of from twenty to twenty-five sperm candles for a consumption of five feet an hour, the sawdust instantly changes to a most beautiful pink colour, and the tint gradually deepens until the whole becomes of a dark mahogany. With poor gases, which give the light of from ten to twelve candles, this colouration is exceedingly faint at first, and deepens very slowly. The differences of colouration are so considerable and constant, that I have no doubt of the possibility of thus determining the value of gas as an illuminant. By using a standard acid, the same kind of sawdust, a uniform volume of gas, and the same sized U-tubes, notation of time and depth of colour would give a close approximation to the illuminating value of the gas. At all events, the sources of error are not greater than those of photometry in the hands of all but the most experienced, and the process is quite as close an approximation to truth as an ultimately analysis of gas, containing, as it does, impurities which render skill and precaution useless. A comparison of the analysis of coal-gas given in *Bunsen's Gasometry*, with the substances now known to exist in gas, will convince us that at present we cannot attach any value to such analyses.

To determine the substances in gas which produce this colouration, some of its chief illuminating constituents were prepared and passed separately through the acid sawdust.

Olefiant gas made in the usual manner, and carefully purified, reddens the acid sawdust. Either vapour does not affect it, and therefore need not be removed from the gas for this experiment.

Propylene, produced by passing the vapour of fusel-oil through a red-hot combustion-tube filled with east-iron nails, but kept at so low a temperature that a small portion of oil passed over without decomposition, reddened the acid sawdust.

Commercial benzole, with the exception of one specimen, reddened the acid sawdust.

I have not yet had leisure to prepare and test acetylene.

The coloration of fir-wood, moistened by hydrochloric acid, has been mentioned by Williams as characteristic of pyrrole.

To show that the colour was produced by illuminating matter abstracted, some sawdust was treated with acid strong enough to char it slightly;* and gas, which instantly reddened the clean sawdust and dilute acid, was passed first through the black and then through the clean acid sawdust. No colour was produced in the latter, though the flow of gas continued for an hour.

Hydrochloric may be substituted for sulphuric acid so far as that gas colours sawdust moistened with it, but it is liable to a considerable disadvantage. If gas contain ammonia, the vapour of the acid unites with it in the tube before the gas comes into contact with the sawdust, and the result is a deposit of chloride of ammonium on the surface of the sawdust where the colour commences, which renders the observation less precise and easy. Olefiant gas likewise does not redden this acid sawdust, and therefore cannot be estimated by it.

Nitrogenised compounds in coal-gas present the greatest difficulty in the way of efficient purification, and the almost impossibility of obtaining them in a state fit for examination, renders their investigation laborious and unsatisfactory. Much nitrogen is contained in gas as cyanogen, which can be separated from the clay used in purification. Probably not much less exists as sulphocyanogen, which can be separated from the foul clay with ease, and the presence of further quantities in combination with sulphuretted hydrocarbons and tar can be demonstrated. The bodies formed by this combination of elements are, I believe, unknown at present.

By placing clay in a purifier through which crude gas passes from the condenser of a gas-works, and treating the saturated clay with spirit, a solution is obtained, of a brown colour, which has no effect upon litmus, turmeric, or lead-paper, which de-colourises a solution of iodine, and from which nitrate of silver throws down a white or brownish white precipitate, and acetate of lead a white precipitate. The aqueous solution possesses the same properties, and, like the solution in spirit, is always neutral: Litmus paper, immersed in either

of the solutions and exposed to the air, becomes quickly, strongly, and permanently reddened. Soluble sulphides have been tested for repeatedly with nitroprusside of sodium, as well as with acetate of lead, but have never been found; yet a sulphur compound exists in solution which possesses the power of forming a sulphide with metallic mercury. The spirit solution, digested on mercury, with occasional shaking, produces the black sulphide of mercury, while the aqueous solution, similarly treated, produces the red sulphide. Insoluble sulphides, however, exist in foul clay, and evolve sulphide of hydrogen on the addition of an acid. These insoluble sulphides are oxidized rapidly by exposure of the clay to atmospheric action.

A solution of clay in spirit was treated with an excess of powdered acetate of lead, and the white precipitate filtered off. The brown filtrate was supersaturated with ammonia and filtered. The clear brown filtrate, diluted with twelve times its bulk of water, became milky, and with much difficulty was obtained clear by filtration. Part of the spirit was then distilled off, to ascertain whether it would bring over a volatile sulphur compound, but the spirit was quite free from sulphur. The remaining fluid was then acidified with nitric acid, which caused effervescence and a strong smell of hydrocyanic acid. Nitrate of silver was added as long as it continued to produce a precipitate; the precipitate, dried and heated, gave off cyanogen, which burnt with its characteristic flame. The clear filtrate, slowly evaporated to dryness, left a pale yellow crystalline mass, which did not change colour by several days' exposure to light. Part of this, burnt in a porcelain crucible, gave off nitrous fumes, and left a considerable residue blackened by oxide of silver. Water was added to this residue, and the oxide of silver filtered off, and an abundant precipitate of sulphate of baryta obtained, with a salt of baryta. The remainder of the yellow salt was redissolved in water, with a view to separate a granular portion which was mixed with the more perfectly crystalline salt, but an accident unfortunately spoilt the remainder, and rendered any further progress impossible.

Sulphocyanide of ammonium may be obtained in considerable quantity from an alcoholic solution of foul clay. Upon one occasion I obtained nearly an ounce in a fair state of purity, from less than a quart bottle of foul clay; and so tenaciously does clay retain this compound, that from some clay which had been exposed to the full action of the weather in a field for two years, I obtained a considerable colouration with perchloride of iron. Sulphocyanide of ammonium may be obtained from gas which has been purified by oxide of iron, by passing the gas through spirit of wine and evaporating.

When common yellow brick-clay is used in the purification of coal-gas, the solutions from it always contain salts of iron, but they never become of a blood-red colour until a mineral acid is added. When, however, the solutions are evaporated, and the deliquescent residue is exposed to the air, moist, and sometimes all of the iron is peroxidized and yields the well-known reaction.

The nitrogen in tar may be shown from the spirit-solution of foul clay. The spirit, evaporated to dryness and allowed to stand, deposits tar and a mixture of deliquescent crystalline salts. They were allowed to deliquesce, the fluid was removed, and the residual tar well washed with water. Subsequently it was dissolved in hot spirit, precipitated by water, and well washed. When nothing more was removed by washing, the tar was heated, and evolved sulphide of hydrogen and ammonia. Contrary to every other compound in gas with which I have experimented, this tar gave off sulphide of hydrogen before ammonia. In other instances I have found the nitrogen compound evolved at a lower temperature than the sulphur one.

Mineral matter derived from the clay is found in all solutions; but as my object in this paper is to speak only of substances in gas, I purposely omit those united with them derived from the clay. For the same reason I make no mention of the value of the foul clay as a manure.

Sulphur compounds in gas purified so as not to affect basic acetate of lead, and their removal.

A recent Royal Commission on lighting picture galleries, has stated the large quantity of sulphur found in some London gas, and has intimated a doubt about the possibility of its removal. Dr. Letheby concludes, from seven years' examination of gas in London, that though quite free from sulphide of hydrogen, it contains, on an average, 200 grains of sulphur in 1000 cubic feet; and Dr. Frankland, in the new edition of *Ure's Dictionary of Arts*, part iv. pp. 730, 731, writes, "It is probable that volatile organic compounds of sulphur are produced by the action of this element with carbon and hydrogen simultaneously; although we have as yet no positive evidence of their presence in illuminating gas. . . . When once generated with coal-gas, all attempts to remove these constituents have hitherto proved ineffectual, and there seems little ground for hope that any practicable process will be devised for their abstraction." I have now the honour to submit evidence of the existence of these sulphurised compounds, and also a practical process for their removal. My attention was specially drawn to this subject by a conversation with the manager of a London gas-works. He informed me that he not unfrequently filled his gas-holders with gas which would not affect acetate of lead, and that after the gas had been stored a few hours, it became so foul as to blacken lead-paper the instant it was applied. He sought an explanation of this phenomenon; and as the water of his gas-holder tanks was clean, and there were no accidental sources of sulphide of hydrogen, I concluded that an organic compound containing sulphur and hydrogen had been broken up, and that the sulphide of hydrogen was thus produced. I learnt also, by other observations, that gas which went to the gas-holders free from ammonia, sometimes became ammoniacal if kept, and joining this fact with the former one, inferred that the compound which thus broke up contained nitrogen as well as sulphur and hydrogen. Subsequently I observed that the saturated clay taken from the purifiers of gas-works, contained a quantity of foul naphthalin. This led me to procure a quantity of (so called) naphthalin which had been taken from the main of a London gas-works, and which therefore must have been deposited by purified gas. Some portions of this naphthalin were white, but others were slightly darkened by the presence of carbonaceous matter, and the whole was in *fine powder* aggregated together by the process of deposition. The tendency to

* This acid was of the same strength as that used in some gas-works.

form exceedingly small crystals seems a constant characteristic of naphthalin which has been deposited in gas-pipes, for by no amount of care and trouble have I been able to obtain it in large crystals, though the solutions from which it has crystallized have been months in evaporating. With naphthalin from tar, on the contrary, I have obtained, from an ethereal solution, crystals an eighth of an inch thick, nearly half an inch broad, and more than half an inch in length. The supposed naphthalin from gas-pipes dissolves wholly in ether and hot alcohol, and crystallizes from the spirit on cooling as pure naphthalin does. The solutions are neutral to test-papers. Boiled with an alcoholic solution of potash it evolves no ammonia, and with hydrochloric acid no sulphide of hydrogen. Heated alone, it evolves first ammonia, and then sulphide of ammonium, mixed, I think, with a trace of bisulphide of carbon, and then distils. Several samples began to give off their ammonia at 388° Fahr., and sulphide of hydrogen at 422° Fahr., leading to the hope that here was a compound of definite composition which would admit of correct analysis and perhaps of formulation; but some more of the naphthalin, produced, like the other, from Newcastle coal, but at another gas-works, possessed such different physical properties as to convince me that very much more must be known of this substance before any reliable analyses can be published. The latter sample gave a neutral solution in spirit, like the other, but of a considerably browner colour. When heated alone it gave off ammonia with ebullition at 218° Fahr., and then became tranquil. When the temperature reached 375° Fahr., it began to evolve sulphide of hydrogen, which continued to increase in quantity up to 390° Fahr., when it nearly ceased, and quite ceased at 410° Fahr. The proportion of tar in this sample was much greater than I have seen it in any other. Subsequently I obtained some more naphthalin which had been deposited in the pipes of another London gas-works, and this, like the former, contained both nitrogen and sulphur, which were evolved upon distillation as sulphide of hydrogen and ammonia.

Having thus obtained one sulphurized hydrocarbon, and determined the temperature at which its sulphur and nitrogen could be obtained as easily removable compounds, I was prepared to advance towards a better purification of gas with great probability of success. Another well-confirmed observation helped to guide me. Gas freed from every trace of sulphide of hydrogen always blackens lead-paper strongly when passed through clay; and if it be subsequently passed through lime, it affects turmeric though quite free from ammonia when taken for experiment. This process may be repeated through a series of ten or twelve purifiers containing clay and lime placed alternately, the test-papers being less affected at each purifier, until at length they are not discoloured at all. This experiment has been made upon gas produced in various parts of England and Scotland from many kinds of coal, and I think the number of instances sufficient to justify the conclusion that *all* gas, as sold, contains the compound from which clay liberates sulphide of hydrogen. I have not yet been able to separate the compound upon which clay thus acts. I have, however, ascertained that the clay which has liberated sulphide of hydrogen from gas which did not affect test-papers when taken for experiment contains tar, which may be dissolved out by alcohol, and may be obtained alone by evaporating the solvent.

Although collateral matter has been carefully excluded from this paper, I cannot refrain from remarking that the property of clay here mentioned is in fact the announcement of a new property of soils, and one which will help to account for the formation of many natural metallic sulphides. I hope soon to have some investigations of this subject ready for publication.

To ascertain whether this property of breaking up a sulphurized compound in purified gas and removing tar was possessed by clay alone, or shared by other substances used in purification, some purified gas was passed through a considerable chemical excess of all the substances employed in purification, viz. lime, precipitated peroxide of iron, sulphate of iron, chloride of calcium, and dilute sulphuric acid, all but the lime being mixed with moist sawdust. Upon passing the gas next through a purifier filled with clay, it darkened lead-paper, and affected turmeric when it had passed a subsequent purifier filled with lime. This proves the power of clay to break up one or more sulphurized compounds which no other substance used in purification effects; and if this sulphur were not liberated from the impure naphthalin compound already mentioned, it seemed certain that gas which had been previously purified by clay might be much improved, if not rendered pure, by a removal of the sulphur of the naphthalin. There is strong experimental evidence that the compound from which clay liberates sulphide of hydrogen is not the sulphurized naphthalin one; for if hydrogen be passed through a vessel containing this substance, then through clay, and subsequently over lead-paper, no trace of sulphide of hydrogen is found, though the gas passing smells strongly of impure naphthalin. This gas and vapour burn with a lightless flame. Subsequently some naphthalin was heated to ebullition, and a current of hydrogen sent through it and then burnt. The flame was lightless as before. I mention this fact to remove the popular error that naphthalin, as it exists in coal gas, is a good illuminant. Even Dr. Frankland thus regards it; and both in Clegg's book on coal-gas, and in the new edition of Ure's Dictionary, states that the hydrocarbons in gas are valuable in proportion to the carbon they contain, and that naphthalin is the most valuable as containing the largest proportion of carbon. The above-mentioned experiments evince the contrary. On another occasion I determined the illuminating power of some gas, and then, without alteration of the quantity passing, sent the gas through a U-tube containing naphthalin from the London gas mains. The character of the flame was changed from white to red, but the photometer indicated no difference in the light given. Two other persons conversant with photometry were present at this experiment and agreed in the result, though up to that time they had held the prevailing opinion as to the value of naphthalin in gas without testing the statements made upon the subject.

Another sulphur compound is said always to be present in coal-gas and to be irremovable, and which, like those I have hitherto spoken of, does not affect lead-paper, viz., bisulphide of carbon. To ascertain the presence of bisulphide of carbon, I pass gas through strong spirit of wine (methylated spirit answers perfectly) kept at about 160° Fahr. The gas and vapours pass out of the flask

which contains the spirit up a long tube into an inverted flask, so that all which is condensed may run back into the spirit. It then passes into another flask for additional condensation, and thence forward to a gas-holder or burner. Bisulphide of carbon dissolved in spirit becomes precipitated as a white cloud which settles to the bottom of the vessel, when the spirit is copiously diluted with water. The white cloudy precipitate escapes slowly by single bubbles through the diluted spirit, and at length leaves a solution perfectly clear. The spirit through which gas has passed, and from which it has abstracted bisulphide of carbon, acts in precisely the same manner upon dilution, and no one who has seen the reaction once or twice can possibly mistake it. The study of other compounds led me to conclude, that if this substance exist *as such*, and not merely *by its elements*, in gas, it could be removed almost as easily as the naphthalin compound could be purified, and that the same process could be made available to remove the sulphur of both. I thought that under certain conditions the affinity of hydrogen for sulphur would exceed that of carbon for sulphur, and therefore that I might obtain the sulphur of bisulphide of carbon as a sulphide of hydrogen, about the removal of which there is no difficulty. Experiment confirms the reasoning. When hydrogen mixed with vapour of bisulphide of carbon is passed through a tube filled with slaked lime or clay which has been dried at 400° or 500° Fahr., and is kept between 400° and 600° Fahr. during the passage of the gas and vapour, not a trace of bisulphide of carbon passes from the tube, but sulphide of hydrogen does pass. The lime is darkened by a deposit of carbon, and a sublimate of sulphur is found in the exit tube. A considerable excess of hydrogen should be used, or else a portion of the bisulphide of carbon vapour is carried over by the current and escapes decomposition. That this reaction is not the result of heat merely, but is a truly chemical one which the base under the influence of heat effects, and the remarkable fact that slaked lime when heated forms, but does not unite with, sulphide of hydrogen, receives illustration from the following experiments.

Hydrogen and vapour of sulphide of carbon were passed through—1st, cold slaked lime; 2nd, cold clay; 3rd, hot oxide of iron used at a gas-works in purification; 4th, hot broken bricks; 5th, hot broken glass, without in any instance producing sulphide of hydrogen. On the contrary, when passed through (1) hot lime and (2) hot clay, sulphide of hydrogen was formed and passed over immediately, and continued to pass as long as the current was kept up. The lime, when cooled out of contact with the air, gave no sulphide of hydrogen upon being supersaturated with dilute sulphuric acid, but clay when thus treated gave off much.

The hydrogen used was in all cases passed through lime and over lead-paper, to secure its being free from sulphide before use. On one occasion, when the clay had been imperfectly dried before heating, I observed much sulphurous acid instead of sulphid of hydrogen. I therefore passed hydrogen, bisulphide of carbon vapour, and steam over hot clay which had been properly dried. At first sulphide of hydrogen passed over alone, then mixed with sulphurous acid, which at length passed alone. Subsequently sulphide of hydrogen passed, and at length sulphurous acid ceased. As the one gas increased, the other diminished, and throughout the experiment sulphide of carbon vapour passed undecomposed. It is shown by this experiment that hot clay in the presence of more water than forms a hydrate, acts very differently from the same clay when dry, and the whole subject deserves a full investigation.

Action of Sulphide of Hydrogen upon clay and lime, cold and hot.

Well-washed sulphide of hydrogen passed into cold slaked lime (obtained from Buxton) in a tube, colours the lime green as soon as it comes into contact with it, and the progress of the gas along the tube corresponds with the colouration. Lead-paper is not affected until the lime becomes coloured close up to the exit.

The same gas, passed into a tube containing slaked lime kept about 600° Fahr. at the middle, but cool at both ends, acts differently. The cool lime at the inlet end becomes coloured; the hot lime in the middle remains white, and the cool lime at the exit end becomes coloured, and lead-paper is stained as soon as these two cool portions are saturated, while the middle portion remains unchanged in colour.

The same gas, passed into a tube containing hot lime only, causes no discolouration, but instantly blackens lead-paper placed at the exit end; and upon being conducted into a tube of cold lime, colours it as if it had just passed from the vessel in which it is produced.

The same gas was passed into a tube containing lime which had been thoroughly dried at 600° Fahr., and cooled out of contact with the air. No discolouration of the lime took place, but the gas passed unaffected by the lime, and blackened lead-paper. Water added to the lime gives it the power of decomposing the gas as if it had not been heated. The presence of more water than is necessary to form hydrate of lime (Ca O, H O), is thus shown to be required for the decomposition of sulphide of hydrogen by slaked lime.

Sulphide of hydrogen passed into a tube of cold clay is taken up in considerable quantity, and the clay becomes black from formation of sulphide of iron. The blackening begins at the inlet end, and progresses with the passage of the gas towards the exit end of the tube.

The same gas, passed into clay, heated to 500° or 600° Fahr., gives the same reactions; but when the clay has been heated and well-dried, and cooled in the closed tube, it takes up a very small quantity of the gas.

Coal-gas, quite free from sulphide of hydrogen, when passed through hot lime, blackens lead-paper, showing that masked and hitherto irremovable compounds have been so altered as to be easily removable. The lime does not take up sulphide of hydrogen, but becomes gradually, yet very slowly, darkened by the deposition of tar and carbon from vapour of bisulphide of carbon. The reaction with previously dried slaked lime commences at 108° Fahr., and continues through the whole range of temperature up to redness. At a red heat the sulphur of the bisulphuret of carbon and other sulphur compounds unites with the lime and forms sulphide of calcium. Practically very high temperatures are needless, as the hydrocarbons of gas begin to be decomposed about the melting point of

lead, and deposit their carbon upon the hot lime. Fortunately, injurious temperatures are not required. I have frequently freed gas from every trace of sulphur so that upon combustion no sulphurous acid was generated, by employing lime so heated as not to deposit any carbon, and removing the sulphuretted hydrogen evolved in the hot tube by ordinary hydrate of lime.

The same gas passed through hot clay gradually darkens the clay by forming sulphide of iron, and, when the blackness has reached the end of the tube containing the clay, lead-paper is blackened by the passing gas. The clay treated with an acid evolves sulphide of hydrogen. Carbonic acid is evolved in both cases. It is thus proved that bisulphide of carbon, in the presence of hydrogen passing over hot hydrate of lime, is decomposed, and that its sulphur becomes united to hydrogen. Coal-gas always contains a considerable quantity of hydrogen, so that, if it contain a vapour of bisulphide of carbon, the process I have the honour to describe will effect its removal. The same process will break up the impure naphthalin compound and convert its sulphur into sulphide of hydrogen; and the employment of clay in the ordinary purifiers, before the gas passes through the hot ones, will so arrange the elements of certain other sulphur compounds as to enable the manufacturer to remove their sulphur as sulphide of hydrogen. Sulphocyanide of ammonium is decomposed by the heated lime, and its sulphur is liberated as sulphide of hydrogen. The only requisite for complete success was that no injury should be done to the light-giving materials of gas while removing the impurities. I have passed the principal illuminating constituents of coal-gas through the hot lime and clay, and find that they are not injured. The temperature which suffices for purification is not high enough for injury. The photometer shows that coal-gas is not injured.

The quantity of tar in gas as supplied to consumers, and the evil of its presence as a source of sulphur, are not considered as, I think, they deserve to be. It is exceedingly rare to find gas free from tar, and I never yet met with tar which did not contain both nitrogen and sulphur. Part of this tar is combined with ammonia in some manner, and may be obtained by passing gas through a bottle containing pebbles moistened with hydrochloric acid. Part is united to naphthalin, as I have already mentioned: part is united to benzole vapour, and part to other hydrocarbon vapours, such as paraffin, if two instances within my own knowledge be sufficient to justify a statement in reference to gas in general. In one instance I passed gas through a metal vessel filled with a number of wire-gauge diaphragms, and kept below 32° Fahr. Some cakes of solid paraffin were found floating upon the water which had been placed in the vessel before commencing the experiment, and a mixture of tarry oils which had deposited the paraffin. In another instance, an old gas-holder was about to be replaced by a new one, and on the water of the tank in which the old gas-holder had worked, there was found upwards of a thousand gallons of a dark-coloured fluid. All but two carboys was sold to a tar distiller. These two carboys were left exposed to the air without corks for some time, and when the manager of the gas-works went to get me some of the fluid for examination, he found that the whole contents had evaporated. I had previously, however, obtained about half an ounce of the mixture. It contained paraffin, naphthalin, and the oils which accompany paraffin. Nearly a fifth of its weight of solid pitch was obtained by distilling off the hydrocarbons. A quantity of sulphide of hydrogen and ammonia were evolved during the distillation, and some of the most stinking compounds I ever met with produced from coal. From these two instances it is clear that some, or perhaps all, of the volatile hydrocarbons in gas possess the power of upholding tar with them in their vapours, and it is proved that this tar is no inconsiderable source of the sulphurous acid produced by the combustion of gas as at present purified. I have obtained tar containing sulphur from every specimen of commercial benzole I have examined; and as this will evaporate at common temperatures without leaving a residue, we are justified in the presumption that tar thus united to benzole exists in gas.

The best method of showing the tar in gas is to pass it through or over well-purified coal-oil, and subsequently through a good condensing arrangement. I have known colourless coal-oil become of a dark mahogany colour, and have separated sulphuretted hydrogen, ammonia, and solid pitch by distillation.

ON THE SURFACE-CONDENSATION OF STEAM.

By J. P. JOULE, LL.D., F.R.S.

(Abstract.)

In the author's experiments steam was passed into a tube, to the outside of which a stream of water was applied, by passing it along the concentric space between the steam-tube and a wider tube in which the steam tube was placed. The steam-tube was connected at its lower end with a receiver to hold the condensed water. A mercury gauge indicated the pressure within the apparatus. The principal object of the author was to ascertain the conductivity of the tube under varied circumstances, by applying the formula suggested by Professor Thomson,

$$C = \frac{w}{a} \log \frac{V}{v},$$

where a is the area of the tube in square feet, w the quantity of water in pounds transmitted per hour, V and v the differences of temperature between the inside of the steam-tube, and the refrigerating water at its entrance and its exit. The following are some of the author's most important conclusions.

1. The pressure in the vacuum space is sensibly the same in all parts.
2. It is a matter of indifference in which direction the refrigerating water flows in reference to the direction of the steam and condensed water.
3. The temperature of the vacuum space is sensibly equal in all its parts.
4. The resistance to conductivity must be attributed almost entirely to the film of water in immediate contact with the inside and outside surfaces of the tube, and is little influenced by the kind of metal of which the tube is composed, or by its thickness up to the limits of that of ordinary tubes.
5. The conductivity increases up to a limit as the rapidity of the stream of water is augmented.
6. By the use of a spiral of wire to give a rotary motion of the water in the concentric space, the conductivity is increased for the same head of water.

The author, in conclusion, gives an account of experiments with atmospheric air as the refrigerating agent; the conductivity is very small in this case, and will probably prevent air being employed for the condensation of steam except in very peculiar circumstances.

ON THE JUNCTION OF RAILWAY CURVES AT TRANSITIONS OF CURVATURE.*

By Mr. WILLIAM FROUDE.

Illustrated by Plate 185.

It is usually admitted, and will be here assumed, that in laying the permanent way of such portions of a line as lie on a curve, the outer rail should be elevated above the inner, by a quantity proportioned directly to the curvature, or, what is the same thing, inversely to the radius of the curve.

This elevation is termed the "cant;" and, if it be calculated in terms of the centrifugal force of the passing trains, on the assumption of some average velocity, V , and neglecting the other considerations which in a minor degree affect it, its value is given by the expression—

$$\text{Cant} = \text{gauge of line} \times \frac{V^2}{32r}$$

V being the number of feet traversed by the train in one second; r the number of feet in the radius of the curve; and the "gauge" and the cant being expressed in feet.

[It may be remarked in passing that as a practical rule for the use of the "plate-layers," the "cant" may be determined by stretching a line of given length, as a chord to part of the curve, and measuring the length of the offset at the middle point: the length of the chord depending on the gauge of the line and the assumed average velocity of trains, would, with a 7 feet gauge, be the space travelled by the train in 1.32 seconds; with a 4.6 gauge, the space travelled in 1.06 seconds.]

It follows from this view that a sudden change in the radius on which a curve is laid, involves a sudden change or discontinuity in the cant; though this conclusion, however obvious when stated, is apt to be disregarded, from the circumstance that mere change of radius involves no break in the tangential direction of the curve, the appearance of which, therefore, fails to suggest the discontinuity of curvature which really exists.

Thus, if there be a sudden transition from a curve on which a cant of six inches is due, to one on which a cant of only three inches is due, the outer rail, if laid accordingly, must suddenly drop three inches at the point where the change of radius occurs. And if, instead of a mere change of radius, a contrary flexure or reversal in the direction of the curve be introduced, and specially when this occurs, as it often does, where the curves are sharp, the discontinuity of cant becomes so much larger in amount that it cannot but be regarded as of serious importance.

Practically, the difficulty is usually dealt with according to methods suggested by the "rule of thumb." When a simple change of radius occurs, the maxim which governs the proceeding is "humour it in." But when the direction of the curvature is reversed, the expedient of "putting in a bit of straight," as a common tangent to both circles, is usually thrown into the bargain to "make things pleasant." And thanks to the experienced eyes and skilful hands that are usually engaged in the operation, the result obtained is, for the most part, not unsatisfactory.

It seems better, however, that the process should be governed by some definite and well-grounded rule; such as will follow from and embody, as near as may be, the same mechanical conditions as those which determine the amount of cant on the arcs which have to be connected. And it is obvious that we shall accomplish this if we arrange that circular arcs of different radii shall not meet each other directly, but shall be connected by an intermediate length of curve, having a graduated change of curvature; the gradations being so arranged that the curve shall have the same radius of curvature (or as it is termed osculate) with each circle, where it runs into them respectively, and in its intermediate part shall possess successively every intermediate degree of curvature. We can then at every point along the connecting curve adopt that amount of cant which is appropriate to the degree of curvature at the point.

The simplest law of gradation, and that which earliest suggests itself as the one in accordance with which we should desire the cant to vary, is that it should vary uniformly along the connecting curve. That is to say, that the level of the outer rail should change by a uniform gradient (so to call it) from its elevation at one point to its elevation at another. And on reflection this arrangement seems to be very nearly such as to "minimise" the mechanical difficulty which the case involves.

For this difficulty lies principally in the circumstance, that while the outer rail is changing its level, the inner and the outer rails no longer lie in the same plane, or quasi plane, but are "winding" with reference to

* In Plate 185, in our last number of THE ARTIZAN, the names of the two authors were by mistake transposed; for "By Prof. W. J. Macquorn Rankine," read, "By Mr. Wm. Froude," and vice versa.

each other, so that an engine or carriage resting on them becomes unequally supported cornerwise; the leading and the trailing wheels on one diagonal, having an excess of support, those on the other diagonal having a deficiency. Now, if we determine that the whole inequality of level—the whole difference of cant—is to be adjusted in a given length of line; that is, that the connecting curve shall extend over that length, we shall find that the minimum degree of “wind” will be secured, if we make it uniform throughout. For the degree of wind is in exact proportion to what was termed the gradient of the outer rail. And if this be so arranged as to be less steep and involve a less degree of wind in one part of the connecting curve, it must be more steep and involve a greater degree of wind in some other part of it, since a given amount of change in all is to be effected.

On this supposition then the problem resolves itself into that of finding and applying a curve, the curvature of which shall vary *uniformly* in terms of its length of arc. And the most complete solution of this problem will result in a curve which shall commence with an infinite radius of curvature, or a curvature = 0, and shall possess every subsequent point, a curvature directly, or a radius of curvature inversely proportioned to the length of arc which intervenes between that point and the commencement of the curve. Having discovered the curve, we shall have merely to assign to it such dimensions, and select such a portion of it, as will best suit the circumstances of the case to which we desire to apply it.

A proper discussion of the conditions on which the problem rests, shows that the curve which satisfies them approximates very closely to the cubic parabola; or conversely, that the cubic parabola may be used so as to satisfy the conditions with a very close approximation.

The mathematical part of the discussion is better suited to an appendix, and it will accordingly be given there. It may, however, be observed as illustrating mechanically the truth of the conclusion, that the conditions on which it is based are closely analogous to those which govern the flexure of a parallel-sided beam or plank, when it is rigidly fixed at one end and strained transversely at the other. For the curvature at each point in the beam will be directly as the stress, and this again will be directly as the leverage at the point; that is to say, as the distance along the beam between this point and the point where the transverse strain is applied. And it is well known that the elastic curve thus produced is approximately the cubic parabola.

In the application of the curve to the practical operations which are the subject of the present inquiry, the approximation is so close that the curve may be used unreservedly, and, on a full examination of its properties, the application turns out to be as singularly easy as its results are elegant; whilst the properties themselves form instructive illustrations of the mathematical theory of curvilinear contact, and deserve to be studied on that account alone. But in this case also the mathematical part of the discussion will be more suitably given in the appendix, and it will be sufficient here to state the properties *seriatim*, and to point out the method in which it has been found easiest to apply them.

(1). The cubic parabola is ordinarily described by the equation $y = m x^3$, or, in general language, the interval between the curve and the base from which it takes its departure varies at the cube of the distance from the point at which the curve commences. Thus, for instance, if we take a series of these distances, in chains, and assign .001 chain (or one-tenth of a link), as the ordinate or interval at the end of the first chain, the intervals at the end of the second, third, fourth chains, and so on, will be .8, 2.7, 6.4 links, and so on; multiplying in each case the primary unit (.1 link) by the cube of the number of chains. The term, m , in the equation, will in fact equal .001. It will be observed the curve forms two branches, having a contrary flexure in the origin of co-ordinates; since negative values of x give also negative values y .

(2). The radius of curvature, at any point in the curve within the compass which will be involved in the proposed practical application of the system, is given by the expression $r = \frac{1}{6m} \times \frac{1}{x}$. Thus, for instance, in the curve of the dimensions just given, when $m = .001$, we should have for the radius of curvature at the end of the first chain, where $x = 1$, $r = \frac{1}{6 \times .001} = 166.67$ chains; half of that, or 88.33 chains at the end of the second chain; one third of it, or 55.55 at the end of the third chain, and so on. Fig. 1, Plate III., shows the curve, plotted on a scale of half an inch to a chain, with the circles of curvature added at the ends of the third, sixth, and ninth chains. The curve is shown in a full line, the circles of curvature in dotted lines.

(3). For the purpose we have in view, it will be found convenient to determine the series of ordinates which measure the interval between the curve, and the circle of curvature which belongs to it at any point.

Now, it follows from the mathematical theory of curvature and contact, that whatever be the curve we deal with, the interval between it and its circle of curvature varies approximately as the cube of the distance from the point of osculation, measured along the arc; so that for a short distance on either side of this point, either the curve or the circle may be

regarded as a cubic parabola, when referred to the other as a base; and this law is characteristic of what is called contact of the second order; just as it is characteristic of contact of the first order (the contact of a curve and a straight line), that the interval varies approximately as the square of the distance from the point of contact.

The peculiarity which distinguishes this general relation, as it exists in the particular curve under consideration, is that at whatever point in the curve we place its proper circle of curvature, the series of cubically growing ordinates which mark the interval between the curve and circle on either side of the point of osculation, is the same series as that which marks the interval between the curve and the base on which it is described, if we assign to these ordinates in the former case the same distances from the point of osculation, measured along the arc, as belong to them in the latter case, measured from the commencement of the curve.

Thus, in fig. 2, let $P'' O P'$ be the cubic parabola, and $C P C'$ a circle of curvature osculating it at any point, P .

Let a series of distances, 1, 2, 3, &c., be marked out along the line, $O X$, measured from O , and a series of equal distances along the curve, each way measured from P ; then it will be found that the intervals between the curve and its circle of curvature at any one of these points, will be the same as that between the curve and the line, $O X$, at the corresponding point; and this proposition is a general one, and is true for any position of P , so long as it is placed within the limits of the approximation; it is equally true whether the ordinates are measured from a flat circle of curvature, osculating the curve near the origin, or from a circle of smaller radius osculating it at a proportionally greater distance.

The rationale (so to call it) of the proposition depends on the condition, that in the curve to which it refers, the curvature varies *uniformly*. For this implies that equal increments of curvature accrue to the curve throughout, in equal lengths of arc. Now, just as the absolute amount of curvature in a line at any point, is measured by the rate at which it departs from a rectilinear tangent, for short distances on either side of that point taken as the point of contact, so the variation in, or growth of its curvature at any point, is measured by the rate at which it departs from its circle of curvature on either side of that point taken as the point of osculation. If, therefore, the curvature grows uniformly, this rate of departure from the circle of curvature must be everywhere the same; and as the original tangential line, $O X$, is identical with the circle of curvature belonging to the vertex of the curve, where its radius is infinite, the rate of departure of the curve from this line will be identical with that of its departure from its circle of curvature at any other point; and since the series of ordinates marks the rate of departure, this series must be everywhere the same.

It should be remarked in reference to the range, within which this proposition is approximately true, that the amount of error which it involves, depends on the difference between the length of arc up to any point and the length of the corresponding portion of the base, $O X$; and the error will be sensible when the difference becomes considerable. But no such difference will arise within the range of curve which will be called into use by the practical application of it now proposed; and, moreover, be range of safe approximation may be extended considerably farther, if the distances to which the successive terms in the series of cubically growing ordinates are assigned, be measured not along the base line, but along the arc of the curve itself, an arrangement which it is always easy to make in dealing with a curve geometrically, though analytically it for the most part involves serious difficulties. But farther, a little consideration shows that, in dealing with the subject geometrically, it is easy, by help of the proposition under discussion, and relying only on such an extension of it as introduces no appreciable error, to lay down as far as we desire, a curve of uniformly varying curvature, and this with as close an approximation to the truth as we please.

For if, at a point in the curve at which the error has not begun to be appreciable, we describe the circle of curvature, we may continue the curve for a second such length, using the circle as the base (instead of continuing to work from the original base); we may then again describe a fresh circle of curvature and repeat the operation as often, and extend the curve length by length as far as we desire; and this is exhibited in fig. 3, the curve being shown in a full line, the circles of curvature in dotted lines.

It is not uninteresting to observe that, if we lay down a segment of such a curve on a narrow ribband of paper, and draw a series of tangents to successive points in it, and then bend the ribband in its own plane, so that every tangent shall become a circle of given curvature, the same throughout, our curve will simply have been converted into a segment of some other portion of its own continuation. For the curvature of that circle will have been simply added to, or deducted from, the curvature of each portion of the original segment; and the law of uniform growth, which its curvature originally possessed, will not have been thus disturbed; since the uniformity of a uniformly growing series is not affected by the addition of a given quantity (the same throughout) to each of its original terms.

(4). Referring back to fig. 2, it is plain that since $OC = PH$, the point where the circle of curvature is nearest to the line, OX , is midway between the point at which the curve osculates its base at starting, and that at which it osculates the circle of curvature; and, *pari ratione*, it is plain that the point at which any two consecutive circles of curvature are nearest to one another, is midway between the points at which they respectively osculate the curve, as is exemplified in fig. 3.

(5). Again, since in fig. 2, the ordinates, 1, 2, 3, &c., measured from the circle of curvature to the curve, are respectively equal to the ordinates similarly numbered, measured from the base, OX , to the curve, it follows that, at the middle point where the circle most nearly approaches the base, the curve will bisect this minimum interval; because the two equal ordinates numbered, 5, meet in the curve at this point, and together span the interval; and, *pari ratione*, the curve will bisect the minimum interval between any two consecutive circles of curvature.

(6). It follows from these propositions, that at the positions where the connecting curve commences and terminates, the interval between the two circles (or the circle and the tangent) which it connects, is four times the minimum interval between them, because the former is the concluding term in the series of cubical ordinates which define the connecting curve, while the latter is double of the middle term in the same series; and since the series is cubical, the middle term must be one-eighth of the concluding term. Hence, in fig. 4, in the examples, a, b , and c , $PQ, P'Q'$, each = $4MN$.

We can thus at once determine the dimensions and position of the curve which will duly connect any two consecutive circles, which have been so placed as to admit of the connection, that is, such as run past each other at a moderate distance without intersecting, as shown in fig. 4; and the same method of proceeding will be found to apply alike, whether the case be that of a reversal of curvatures, as in the example marked, a ; or of a circle running into a tangent, as in the example marked, b ; or, lastly, a change of curvature without reversal, as in the example marked, c .

The points, P , and P' , the beginning and the end of the connecting curve, are determined by a trial measurement, showing the position where $PQ, P'Q' = 4MN$.

Having thus determined the position and length of the connecting curve, this length, PP' , must be divided into a series of spaces (it is convenient to make these spaces equal); and to the end of each of them must be allotted its appropriate term in a series of corresponding cubically-growing ordinates; of which the concluding term is PQ , or quadruple the minimum interval, MN . Thus, if we divide PP' into ten equal spaces, PQ will stand for 1000, and the ordinates at the ends of spaces, 1, 2, 3, &c., will be respectively 1, 8, 27, &c. The ordinates may be set off indifferently from either circle as base, and the resulting curve will be in either case the same.

The operation has been performed in example, f , of fig. 5; and the delicacy of the transition from curve to curve approves itself to the eye better than any mere "rule of thumb" sweep could do; and the perception of this is heightened if, as in fig. 5, we exhibit in contrast, three methods of uniting two circles of given radius at a part of contrary flexure; (1) uniting them by merely securing identity of tangential direction at the point of junction, as at d ; (2) uniting them by the recognised formula of "putting in a bit of straight," as at e ; and (3) uniting them by a segment of cubic parabola, as at f .

In describing the practical process by which the connecting curve is to be applied, it was stated that the circles to be connected must be so placed as to pass each other, by a moderate interval, without intersecting; and it becomes proper to inquire by what rule the magnitude of the interval is to be governed.

The answer to this question depends on the scale of the cant adopted, and on the "gradient of adjustment," as it may be termed (the gradient, namely, according to which the elevation of the outer rail is to be changed), which may be considered proper in reference to the mechanical difficulties which it involves. If these elements of the question are assumed or determined, the interval which must be allotted to the circles at the point of nearest approach, as well as the total length of the connecting curve, are readily deducible.

The deduction is given in a regular form in the appendix, and it will be sufficient briefly to notice its principle here.

It was shown in the earlier part of the paper that if rails be laid on the line of a given cubic parabola (within the limits of approximation assumed in the discussion), the cant due to the curvature will vary by a uniform gradient; and the proposition may be extended throughout to such an extension of the curve as is exhibited in fig. 3.

Now, in the equation, $y = mx^3$, on which the curve is based, the term, m , fixes the gradient, in relation to the scale of cant; for it shows by what length of arc a given curvature, and therefore a given cant, is arrived at. So that the value of m may be made such, that the curve expressed by the equation shall correspond with the proper gradient of adjustment and the proper scale of cant.

In order, then, to determine the proper relative positions for the circles

to be connected, we may, in the first place, determine the length, PP' (fig. 4), in terms of the amount of cant to be lost or gained in the transition, and of the gradient of adjustment; and then, taking the value of m , determined as above, we at once deduce PQ or $P'Q' = mPP'^3$, and $MN = \frac{mPP'^3}{4}$. The circles thus placed, in fact, occupy, with reference to each other, exactly those positions which belong to their counterpart circles of curvature, wherever these stand on the curve.

The scale of cant depends on the assumed average velocity of the passing trains, and this admits only of a rough determination. But if the very sharp curves which are adopted within the limits of stations be put out of the question, 60 feet per second (which is just above 40 miles per hour) is suggested as probably not far from the mark; near enough, at all events, to form the basis of an illustrative calculation.

The mechanical difficulty involved in the "gradient of adjustment" is the fact that, when an engine or carriage rests on the part of the line which is affected by it, the leading and trailing wheel on one diagonal are lifted, relatively to those on the other diagonal; and if the frame of an engine were rigid, and the axles unprovided with springs, one of the wheels on the diagonal of least stress would be out of contact with the rail beneath it, by the amount of rise or fall due to the gradient, within the distance between the leading and trailing wheels.

Practically, the result will appear in the shape of an excess of compression in the springs on one diagonal, and a defect of compression in those on the other—each being compared with the compression they would exhibit were the engine or carriage resting on a line, the rails of which lie in the same plane; and the question is, what degree of inequality may safely be permitted.

It is believed that the average compression of the springs on which an engine rests is about 2 inches, as due to the weight of from 5 to 7 tons on each wheel; and probably 20 feet may be taken as the extreme length of engine or carriage in this country. Now, if in this length we suppose the outer rail to rise or fall one inch, as due to alteration in cant, it follows that the springs on one diagonal will be compressed each half an inch more than those on the other diagonal, or a quarter of an inch more than when in the mean condition; and this will involve a variation in pressure amounting to about one-eighth part of the average load on each wheel. Such a rate of change will involve a "gradient of adjustment" of $\frac{1}{240}$, and probably this is sufficiently within the limits of safety; yet, bearing in mind that this difference of stress comes in addition to that due to casual irregularities of packing, as well as that due to the oscillatory motion which, in a greater or less degree, every engine and carriage experiences, and under which the springs may be seen to work above one inch in many instances, it may be desirable to take the limit a little farther on the side of safety, and call G the gradient of adjustment $\frac{1}{300}$.

A tabular statement at the end of the appendix gives the requisite data for adapting the connecting curve generally to any scale of cant and gradient of adjustment, together with others reduced into simpler terms, on the basis of the scale now suggested; and to illustrate the application of these here given; showing in each case the reversal of a curve of 20 chains radius, founded, however, in the one on data appropriate to the narrow gauge; in the other to the broad; but both adopting the proposed scale of cant and gradient of adjustment.

The particulars are as follows, all dimensions being in chains. The letters of reference are those adopted in fig. 4.

$$r = + 20. \quad r = - 20.$$

$$V = \cdot 91.$$

$$G \text{ (gradient of adjustment),} = \frac{1}{300}$$

	Narrow.	Broad.
Gauge	$\cdot 068$	$\cdot 106$
(m)	$\frac{1}{207}$	$\frac{1}{322}$
It follows that—		
PP'	3.45	5.37
PQ or $P'Q'$198	.485
MN0495	.1212
Cant on each circle00575	.00895

In reference to the general law which governs the value of these terms, as depending on the velocity assumed as the basis for calculating cant, on the gradient of adjustment, and on the gauge, it may be observed that PP' , or the length of the connecting curve, varies directly as the square of the velocity and as the gauge, and inversely as the gradient of adjustment; while PQ or $P'Q'$, and MN , which measure the interval between the circles, vary as the fourth power of the velocity and as the square of the gauge, and inversely as the square of the gradient of adjustment.

It may be observed, in conclusion, that except in those localities in which an enlargement of the interval between the circles at MN can only be obtained by a detrimental sharpening of their general curvatures, there is no reason for adhering to that value of it which depends on the limiting value of the gradient of adjustment, provided it be not made less than that. The value of MN , determined by the steepest admissible gradient

of adjustment, is, in fact, rather a limit not to be transgressed, than a measure to be always adopted; and it will save the trouble of calculation if we take at pleasure such a value of it as we are sure will not be too small. A caution which is easily followed if it be borne in mind that the reversal of a curve of 20 chains radius requires only an interval of 5 links on the narrow gauge, and 12 links on the broad, with cant due to an assumed velocity of 40 miles per hour.

APPENDIX.

In the cubic parabola, whose equation is $y = m x^3$, $\frac{dy}{dx} = 3 m x^2$ and $\frac{d^2y}{dx^2} = 6 m x$. Hence the curve has two equal branches; the one, in which positive values of x give positive values of y ; the other, in which negative values of x give negative values of y . Also, the curve passes through the origin of co-ordinates, running parallel to, or coincident with the axis of x at that point, since $\frac{dy}{dx} = 0$, and having its radius of curvature infinite, with a contrary flexure at the same point, since $\frac{d^2y}{dx^2} = 0$, and changes its sign.

Taking the ordinary expression for radius of curvature, $r = \frac{ds}{dx \cdot \frac{d^2y}{dx^2}}$ it is plain that near the origin of co-ordinates, and with a tolerably extended range of approximation, we may put $ds = dx$ in applying it to our curve, and it follows that $r = \frac{1}{6 m x}$. That is to say, the radius of curvature varies inversely as the value of x for the point to which the radius belongs, through the range of the approximation; and, from the form of the expression out of which the conclusion grows, it is plain that the approximation will be closer, and have a greater range, if we make the equation one between y and s , and say $y = m s^3$.

It is desired to determine the series of ordinates which express the interval between the curve and its circle of curvature, in relation to those which express the interval between the curve and the axis, O X.

Let S' O S, fig. 6, Plate 185, be the arc of the cubic parabola, and R' Q P R its circle of curvature for the point P, whose co-ordinates are x', y' (P Q, P T); whence, its radius of curvature, C R, $r' = \frac{1}{6 m x'}$. If x'' be the value of x for the centre of curvature C, $x'' = x' - r' \frac{dy'}{dx'}$; and, as before, putting $ds = dx$, $x'' = x' - r' \frac{dy'}{dx'}$, the reduction of which expression gives $x'' = \frac{x'}{2}$, whence it follows that O Q = y' .

Let the equation of the circle of curvature be expressed in terms of $x_1 y_1$, and let h be the height, M N, of the vertex of the circle of curvature, above the axis of x . Then, in the first place, by the properties of the circle, $y - h : \frac{x'}{2} = \frac{x'}{2} : r'$, and putting for r' its value $\frac{1}{6 m x'}$, and reducing

the equation, it follows that $h = \frac{y'}{4}$; and, in the next place, deducing the

general relation of $x_1 y_1$ by the properties of the circle, $y_1 = h + \frac{(x_1 - \frac{x'}{2})^2}{2 r'}$,

and putting $\frac{y'}{4}$ for h , and $\frac{1}{6 m x'}$ for r' , and reducing, we have $y_1 = \frac{m x'^3}{4} + 3 m x_1 \left(x_1 - \frac{x'}{2}\right)^2$; then the interval between the curve and the circle of curvature, at any point for which the value of x_1 is given, will be $(y_1 - y)$ where $y = m x_1^3$; hence,

$$(y_1 - y) = \frac{m x'^3}{4} + 3 m x_1 \left(x_1 - \frac{x'}{2}\right)^2 - m x_1^3,$$

which, reduced, gives $(y_1 - y) = m (x' - x_1)^3$.

The interpretation of which equation is, that if we take distances along the arc of the parabola, each way from any point, P, as the basis of a series of ordinates, which connect it with its circle of curvature for P, or rather which express the interval between the curve and circle, this series of ordinates will be the same as that which expresses the interval between the curve and the axis of X, taken at the same distances, measured along X from O. Observing, however, that the proposition is only true within the limits of our approximation, and that the range of its truth is extended, if the equation be in all cases considered as existing between y and s rather than between y and x .

It is desired, in reference to the application of the curve discussed in the to determine the value of m in the equation, $y = m x^3$ or $m s^3$,

which will make the curve such as to correspond with the proper gradient of adjustment, G. Observe, then, that $G = \frac{cant' - cant''}{s' - s''}$, s' and s'' being the lengths of arc measured from the origin of co-ordinates up to the respective points, at which the radii of curvature are r' and r'' , and the corresponding values of the cant are $cant'$ and $cant''$.

The general expression for cant is $Cant = \frac{V^2}{32 r} \cdot gauge$, expressing all dimensions in feet; but for our purpose it is more convenient to take the chain as the unit of dimension, and, making the proper substitutions, the expression becomes $Cant = \frac{66 V^2}{32 r} \times gauge$; and since $r = \frac{1}{6 m s}$, or $s = \frac{1}{6 m r}$, if these values be substituted in the expression for G, we have

$$G = \frac{66 V^2 gauge}{32} \frac{\left(\frac{1}{r'} - \frac{1}{r''}\right)}{\frac{1}{6 m} \left(\frac{1}{r'} - \frac{1}{r''}\right)}, \text{ which, converted and reduced, gives } m = \frac{1}{12 \cdot 37} \cdot \frac{G}{V^2 gauge}.$$

If, as suggested in the paper, we put $G = \frac{1}{300}$, and $V = (60 \text{ ft. per sec.} =) \cdot 91$ chains per sec., and observe that the narrow gauge (4 ft. 6 in.) = $\cdot 068$, and the broad gauge (7 ft.) = $\cdot 106$, the values of m come out respectively as follows:—

$$\begin{matrix} \text{Narrow.} & \text{Broad.} \\ m = \frac{1}{207} & \text{or } \frac{1}{322}. \end{matrix}$$

By help of these values of m , we can determine what must be the values of M N, for any two circles, in order that the relative position may be such, that when the connecting curve is laid down according to the rules given in the paper, G (the gradient of adjustment) shall have the required value.

The corresponding values of P P' (the length of the curve), and of P Q, P' Q' (the reciprocally-placed terminal ordinates), fig. 4, plate III., are determined simultaneously.

$$\text{Observe that } P P' = s' - s'', \text{ and } \therefore = \frac{1}{6 m} \left(\frac{1}{r'} - \frac{1}{r''}\right);$$

$$\text{And putting for } m \text{ its value, } \left. \begin{matrix} P P' = 2 \cdot 06 \frac{V^2 gauge}{G} \left(\frac{1}{r'} - \frac{1}{r''}\right). \\ \text{and reducing the expression,} \end{matrix} \right\}$$

Again P Q or P' Q' = $m (P P')^3$; and substituting for m and P P', and reducing,

$$P Q \text{ or } P' Q' = \frac{1}{1 \cdot 41} \frac{V^4 gauge^2}{G^2} \left(\frac{1}{r'} - \frac{1}{r''}\right)^3;$$

$$\text{and } M N = \frac{P Q \text{ or } P' Q'}{4} = \frac{1}{5 \cdot 64} \frac{V^4 gauge^2}{G^2} \left(\frac{1}{r'} - \frac{1}{r''}\right)^3.$$

The following tabular statement shows all the deductions above at a glance, both in their general form, and as interpreted by the assumed values of V and G, and for the narrow and broad gauges:—

General Expressions.	Assuming $G = \frac{1}{300}$ and $V = 0 \cdot 91$	
	Narrow Gauge.	Broad Gauge.
$m =$	$\frac{1}{207} \frac{G}{V^2 gauge}$	$\frac{1}{322}$
$P P' =$	$206 \frac{V^2 gauge}{G}$	$34 \cdot 5 \left(\frac{1}{r'} - \frac{1}{r''}\right)$ $53 \cdot 7 \left(\frac{1}{r'} - \frac{1}{r''}\right)$
$P Q \text{ or } P' Q' =$	$\frac{1}{1 \cdot 41} \frac{V^4 gauge^2}{G^2} \left(\frac{1}{r'} - \frac{1}{r''}\right)^3$	$198 \left(\frac{1}{r'} - \frac{1}{r''}\right)^3$ $485 \left(\frac{1}{r'} - \frac{1}{r''}\right)^3$
$M N =$	$\frac{1}{5 \cdot 64} \frac{V^4 gauge^2}{G^2} \left(\frac{1}{r'} - \frac{1}{r''}\right)^3$	$49 \cdot 5 \left(\frac{1}{r'} - \frac{1}{r''}\right)^3$ $121 \cdot 2 \left(\frac{1}{r'} - \frac{1}{r''}\right)^3$

ON THE APPLICATION OF TRANSVERSALS TO ENGINEERING FIELD-WORK.

By PROFESSOR W. J. MACQUORN RANKINE.

The illustrious Carnot, eminent at once in war, politics, literature and science, published about the year 1806 a short essay on what he called the "Theory of Transversals;" a branch of geometry at once simple in its principles, and useful in its applications, but little known or studied in Britain.

A transversal, as defined by Carnot, is a line, either straight or curved, which cuts another system of straight or curved lines; and the theory of transversals relates chiefly to the proportions amongst the parts into which the lines belonging to that system are cut by the transversal. He confines his attention in his essay to straight and circular transversals.

The object of the present paper is to describe a few of the simplest applications of the theory of transversals to engineering field-work, by which the operations of ranging and measuring the inaccessible parts of straight lines and circular curves may be facilitated.

SECTION I.—Ranging and Measuring, with the Chain and Poles alone, of inaccessible Portions of a Straight Line.

A long station-line in a chained survey, or a straight part of the centre-line of an intended railway, may have one or more places in its course through which, owing to the intervention of buildings, woods, precipices, water, swamps, or other obstacles, it may be difficult or impossible to chain along the line with accuracy; and in some cases also, it may be impossible to range the line directly across the obstacle. Those difficulties are most readily met by the use of angular instruments; but, in the absence of such instruments, the chain and poles alone may be used; and that is the case supposed in the present paper.

Three kinds of cases may be distinguished:—First, those in which the obstacle can be seen over from side to side, and chained round, but not chained across. Secondly, those in which it can neither be seen over nor chained across, but can be chained round; and thirdly, those in which the obstacle can be seen over, but neither chained across nor chained round.

In the simplest of these three cases, when it is possible to see over the obstacle and to chain round it, it is unnecessary to have recourse to the theory of transversals. The present paper, therefore, considers the two more difficult cases only.

In those two cases also, there are well-known methods by ranging and measuring a straight line parallel and equal to the inaccessible line, by setting out triangles of certain figures, and in certain positions, and the like; but, in all these methods, the surveyor is tied down to particular positions for the auxiliary points and lines, which he ranges and chains. The advantage of the method of transversals is, that it leaves the surveyor at liberty to lay out his auxiliary points and lines in such positions as he may judge to be most convenient, upon consideration of the figure and nature of the ground.

PROBLEM FIRST.—To range and measure a straight line across an obstacle which can be chained round, but neither chained across nor seen over.

In figs. 8 and 9, Plate 185, let a and b be two points in the chained straight line at the near side of the obstacle, about as far apart as the inaccessible distance, $b c$, is judged to be. Mark a station, C , so as to form a well-conditioned triangle with a and b ; prolong the lines, $b C$ and $a C$ until two points, A and B , are reached, through which a straight line can be ranged and chained past the further side of the obstacle.

Fig. 8 represents the case in which the most convenient position for A is at the same side of the obstacle with B and C . Fig. 9 represents the case in which the most convenient position for A is at the opposite side from B and C . (In the latter case, the boundaries of the obstacle may be surveyed by offsets from the sides of the triangle, $A B C$, in which it is included.)

In some cases it may be advisable to begin by choosing the stations, A , and B , then to choose C , and then to range the lines, $B C a$, and $A C b$, as in fig. 8; or, $A b C$, as in fig. 9.

All the sides of the two triangles, $A B C$, $a b C$, are to be measured.

Then to find the point, c , at the intersection of the main straight line with $A B$, compute the distance of that point from B by one or other of the following formula:—

If c lies in $A B$ produced, as in fig. 8—

$$B c = \frac{A B \cdot a B \cdot b C}{C a \cdot A b - a B \cdot b C} \dots (1)$$

If c lies between A and B , as in fig. 9—

$$B c = \frac{A B \cdot a B \cdot b C}{C a \cdot A b + a B \cdot b C} \dots (2)$$

Next, to find the inaccessible distance, $b c$, use the following formula, which is applicable to both figures—

$$b c = \frac{a b \cdot A b \cdot B C}{C A \cdot a B - A b \cdot B C} \dots (3)$$

The same problems may also be solved by plotting the figure, $a b C$ $A B C a$, and producing $a b$, till it cuts $A B$, as in fig. 9, or $A B$ produced as in fig. 8. In a purely mathematical point of view, it is unnecessary to measure both $A B$ and $a b$, as either of those lines might be calculated from the other, but both should nevertheless be chained, as a check on possible errors.*

* The following are the formulæ for calculating $A B$ from $a b$. With the aid of a table of squares it is easy to use them.
In fig. 8—

$$A B = \sqrt{\left\{ B C^2 + C A^2 - \frac{B C \cdot C A}{b C \cdot C a} \left(b C^2 + C a^2 - a b^2 \right) \right\}}.$$

In fig. 9—

$$A B = \sqrt{\left\{ B C^2 + C A^2 + \frac{B C \cdot C A}{b C \cdot C a} \left(b C^2 + C a^2 - a b^2 \right) \right\}}.$$

To compute $a b$ from $A B$, interchange the positions of A and a , B and b , throughout the above formulæ.

PROBLEM SECOND.—To measure a straight line across an obstacle which can be seen over, but neither chained across nor chained round. This is the case of a station-line intercepted by a deep ravine or deep and rapid river. The first operation is, of course, to range and fix a pole at c (fig. 10) in the station-line beyond the obstacle. The next is to find the distance, $b c$, as follows:—On the nearer side of the obstacle range the stations, A , and B , in a straight line with c , making the angle, $b c B$, greater than 30° , and place them so that the intersecting lines, $A b$, $B a$, connecting them with two points, a , and b , in the station-line, shall form a pair of well-conditioned triangles, $a b C$, $A B C$, as in the first problem; measure the sides of those triangles, and compute the inaccessible distance, $b c$, by equation, 3, already given.

As a check upon the position thus found for the point, c , compute also the inaccessible distance, $B c$, by means of equation, 1.

This problem is solved graphically by plotting the figure, $a b C$, $A B C a$, and producing $a b$ and $A B$ till they intersect in c .

The calculation represented by either of the formulæ, 1, 2, or 3, when each of the given distances is expressed by four figures, has been found to occupy about six minutes without the aid of logarithms, and five minutes with logarithms.

The preceding methods are founded on the first proposition of Carnot's theory of transversals, which is as follows:—

If the three sides of a triangle or their prolongations are cut by a straight transversal, there will be formed between the transversal and the three angles of the triangle six segments, such that the product of three of them which have no common extremity is equal to the product of the other three.

For example, in either of the figures, 8, 9, 10, $A B C$ is a triangle whose sides, or their prolongations, are cut by a transversal in the points, a , b , c , forming segments which are related as follows:—

$$A b \cdot B c \cdot C a = A c \cdot C b \cdot B a.$$

The several formulæ already given are consequences of this equation.

SECTION II.—Ranging and Measuring Circular Curves, of which Portions are inaccessible to the Chain.

The method now generally known and practised, of setting-out circular curves by laying off angles at the circumference with the theodolite, was so far by the author of this paper known, first published in a paper which he sent to the Institution of Civil Engineers, and which was read on the 14th of March, 1843. He had begun to use the method, and to teach it to others, in 1841; and as no account of it had been published by any other person, he believed himself for a time to be its only inventor; but he afterwards ascertained that it had been independently practised, though not published, by Mr. William Froude (who was at that time assistant to Mr. Gravatt), and probably also by Captain Vetch, R.E.

Before proceeding to range a circular curve by that method, it is necessary, besides the radius of the curve, to have the following data:—The position of at least one end of the curve, and the direction of a tangent at that end; or else, the positions of at least two points in the curve, and the length of the arc between them; and the more points, tangents, and arcs are previously determined, the greater will be the ease, speed, and precision with which the curve can be set-out.

The use of transversals in connection with setting-out curves is to facilitate the finding of those data, when the point of intersection of the tangents to the ends of the curve is inaccessible, and when part of the curve itself is inaccessible.

PROBLEM THIRD.—Given, the positions of two straight lines whose intersection is inaccessible, and which are to be connected with each other by means of a circular curve of a given radius, r ; it is required to find the ends of that curve, and one or more intermediate points, and the lengths of the arcs between those points.

In figs. 11 and 12, the lines to be chained on the ground are represented by full lines; those whose lengths are to be calculated only, are dotted.

Let $b B$, $c C$ be the two straight lines, meeting at the inaccessible point,

A. Chain a straight line, D E, upon accessible ground, so as to connect those two tangents. The position of the transversal, D E, is arbitrary; but it is convenient so to place it, if possible, that it will cut the proposed curve in two points, as in fig. 11, which may be determined, and used as theodolite stations.

Measure the angles, $\angle D E$, $\angle E C$, which may be denoted by D and E. Then the angle at A is—

$$A = D + E - 180^\circ; \dots \dots \dots (1.)$$

$$AD = DE \frac{\sin E}{\sin A}; AE = DE \frac{\sin D}{\sin A}; \dots \dots \dots (2.)$$

$$DB = r \cdot \cotan \frac{A}{2} - AD; EC = r \cdot \cotan \frac{A}{2} - AE; \dots (3.)$$

and by laying off the distances, D B, and E C, as thus calculated, the ends of the curve B and C are marked, and it can be ranged from either of those stations. But it is often convenient to have intermediate points in the curve for theodolite stations; and of these the points, H and K, of intersection with the transversal and the point, G, midway between those, can easily be found by the following calculations; in making which a table of squares is useful.

Let F be the point on the transversal midway between H and K. If $BD = CE$, the point, F, is at the middle of D E. If B D and C E are unequal, let B D be the greater, then the position of F is given by either of the two following formulæ:—

$$DF = \frac{DE}{2} + \frac{BD^2 - CE^2}{2DE}; EF = \frac{DE}{2} - \frac{BD^2 - CE^2}{2DE} \dots \dots (4.)$$

The points, H, and K, are at equal distances on each side of F, given by either of the following expressions:—

$$FH = FK = \sqrt{\left\{ \frac{DE^2}{4} + \frac{(BD^2 - CE^2)^2}{4DE^2} - \frac{BD^2 + CE^2}{2} \right\}} \\ = \sqrt{(DF^2 + EF^2 - BD^2 - CE^2)} \dots \dots \dots (5.)$$

The equations, 4, and 5, are deduced from the two following, which may be used in order to check the calculations, and are given in a form suitable for the use of a table of squares—

$$\left. \begin{aligned} BD^2 &= DH \cdot DK = \frac{(DH + DK)^2 - (DK - DH)^2}{4} \\ EC^2 &= EH \cdot EK = \frac{(EH + EK)^2 - (EH - EK)^2}{4} \end{aligned} \right\} (6.)$$

The point, G, in the curve is found by setting off the ordinate, F G, perpendicular to D E, of the following length:—

$$FG = r - \sqrt{r^2 - FH^2} \dots \dots \dots (7.)$$

The angles subtended at the centre of the curve by the several arcs between the commencement B and the points H, G, K, C are as follows:—

$$\left. \begin{aligned} \text{Angle subtended at the centre by } BH &= 180^\circ - D - \text{arc sin } \frac{FH}{r} \\ \text{,, ,, ,, } BG &= 180^\circ - D; \\ \text{,, ,, ,, } BK &= 180^\circ - D + \text{arc sin } \frac{FH}{r} \\ \text{,, ,, ,, } BC &= 180^\circ - A = 360^\circ - D - E \end{aligned} \right\} (8.)$$

And the length of any one of those arcs may be computed by means of the formula—

$$\text{Arc} = .0002909 r \times \text{angle at centre, in minutes} \dots \dots \dots (9.)$$

The use of such computations will appear in the next problem.

Cases may occur in which obstacles upon the ground render it necessary to make one or both ends of the transversal, D E, meet the straight tangents beyond the ends of the curve. The whole of the formulæ already given continue to be applicable, with only the following modifications:—

When D lies further from A than B does, as in fig. 12, D B is negative in the first of the equations, 3; that is, A D is greater than $r \cdot \cotan \frac{A}{2}$

and the point, H, as found by means of equation, 10, lies, not on the arc to be ranged, but on the continuation of the same circle beyond B.

When E lies further from A than C does, E C is negative in the second of the equations, 3; that is, A E is greater than $r \cdot \cotan \frac{A}{2}$; and the

point, K, as found by means of equation, 5, lies not on the arc to be ranged, but on the continuation of the same circle beyond C.

The point, G, always lies on the arc to be ranged. The larger the ordinate, F G, is, the more carefully must it be set off at right angles to the transversal by means of an optical square, or of the theodolite.

PROBLEM FOURTH.—To set out a circular curve of a given radius, touching two given straight lines, when part of the curve is inaccessible to the chain.

If the point of intersection of the tangents is accessible, the two ends of the curve can be determined and marked by the ordinary methods, and also the middle point of the curve, unless it lies on the inaccessible ground; and the length of the curve is to be computed by equation, 9.

If the point of intersection of the tangents is inaccessible, the two ends of the curve, and at least one intermediate point, are to be determined and marked by the aid of a transversal, as in Problem Third, and the lengths of the arcs bounded by those points are to be computed by the formulæ, 8, and 9.

A transversal may be useful even when the point of intersection of the tangents is accessible, in order to find numerous intermediate points in the curve.

Each of the points thus marked will serve either as a theodolite-station, or as a station to chain from, or for both purposes; and the stakes, lying between the obstacle and the next station beyond it, are to be planted by chaining backwards from that station.

Such are a few of the applications of the theory of transversals to engineering field-work; and if engineers and surveyors generally were to turn their attention to that branch of geometry, there can be no doubt that many more such applications would be devised. Their tendency is to make the operations on the ground more simple, easy, and precise, at the cost of certain additional calculations, which, however, are by no means difficult or laborious, especially with the aid of a table of squares.

EXPANSION OF STEAM.

At a late meeting of the American Engineers' Association, New York City, the subjoined paper was read by its author, Mr. Louis Koch, Mechanical Engineer:—

QUESTION.—What is the pressure of steam in the cylinder at the end of the stroke when cut off at half-stroke?

This question is easily answered by the experimental tables laid down by the Committees of the French and the Franklin Institutes, by Dr. Lardner, and many others, showing the total pressure in pounds, the corresponding temperature, the volume of steam compared to the volume of water that has produced it, and the mechanical effect of a cubic inch of water evaporated in pounds raised one foot; all of which show conclusively that the pressure of steam in the cylinder at the end of the stroke, when cut off at half-stroke, is *not* one-half of its full pressure, and that this difference becomes greater, first, with the increase of pressure, and, secondly, with the decrease of cutting off; all this is strictly theoretical, without regard to friction or the influence of the atmospheric pressure.

The following are a few examples taken from Dr. Lardner's table:—

Volume of Steam.	Temperature.	Pressure.	Double Volume.	Corresponding Pressure.	Difference.
1281	228.5	20 lbs.	2562	about 9½ lbs.	½ lbs.
2426	192.4	10 "			
679	269.1	40 "	1358	19.2 "	.98 "
1281	228.5	20 "			
470	295.6	60 "	940	28.03 "	1.97 "
883	251.6	30 "			
362	315.8	80 "	724	37.3 "	2.97 "
679	269.1	40 "			
295	332.0	100 "	590	46.34 "	3.36 "
554	283.2	50 "			

There can be no doubt of the existence of a fixed relation between the temperature and pressure of steam by immediate evaporation when it has received no heat except that which it takes from the water, but that relation is not known, and, therefore, empirical formulæ have been proposed, which express, with more or less precision, this relation in different parts of the thermometrical scale.

Mr. Southern proposes the annexed, when the pressure does not exceed one atmosphere:—

$$P = 0.04948 + \left(\frac{51.3 + T}{155.7256} \right)^{5.13}$$

$$T = 155.7256 \times \sqrt{P} - 0.04948 - 51.3.$$

Tredgold proposes, when the pressure is from one to four atmospheres:—

$$P = \left(\frac{103 + T}{201.18} \right)^6 \quad T = 201.18 \sqrt[6]{P} - 103.$$

Dulong and Arago propose, when the pressure is from four to fifty atmospheres:—

$$P = (0.26793 + 0.0067585 P)^5 \quad T = 147.961 \sqrt{P} - 39.644.$$

Other formulæ are given by Biot, Taylor, Gay Lussac, &c.

The same uncertainty exists in the relation between the pressure and the augmented volume, and recourse has also been had to empirical formulæ, of which two, as the most convenient for low pressure engines of every form, as well as for high pressure engines on the expansion principle, are given.

Dr. Lardner proposes

$$v = \frac{3875969}{164 + P'} \quad v = \text{volume per number of cubic inches.}$$

A more accurate formula, when not less than 30 lbs. per square inch is used, is the following:—

$$v = \frac{4347826}{618 + P'} \quad P = 1 \text{ lb. per square foot.}$$

It is well to remark here, in relation to temperature, upon the well-known fact that the sum of the sensible and latent heats is a constant quantity; if water at 32° temperature is converted into steam under a pressure of one atmosphere, or 14½ lbs. per square inch, it is necessary to give it first 180° additional sensible heat, and afterwards 990° of latent heat, making a total of 1170° of imparted heat and 32° of contained heat, or 1202° in all. Should the pressure be two atmospheres, the sensible heat would be augmented to 250°, and the latent heat decreased to 952°; at three atmospheres, respectively 275¼° and 926¼°, and thus continuing, the sensible augmenting and the latent diminishing, as the pressure increases the constant total being 1202° F., 1170° of which are necessary for the evaporation of ice-cold water, which, consequently, would be raised to the temperature of 1202° if evaporation was prevented.

A very easy mode of calculating the volume of steam under higher temperature than that of one atmosphere is the following:

1. It being known that air expands with every degree Centigrade, to 1.270ths of its primitive volume at 0° C., it follows that 270 cubic feet of air when heated from 0° to 100° C., will expand to 370 cubic feet, and that 1 cubic foot of air of 100° C. heated with further (t) degrees will become

$$\frac{370 + t}{370} \text{ cubic feet.}$$

2. It being known that steam expands agreeably to the same law, it follows that steam of 100° C. if its temperature is increased 21.4° C. will increase to

$$\frac{370 + 21.4^\circ}{370} = \frac{391.4}{370} \text{ cubic feet;}$$

therefore, steam from 1 lb. of water, or 1691 cubic feet, will have a volume of

$$\frac{391.4}{370} \times 1691 = 1789.078 \text{ cubic feet.}$$

3. And as it is, lastly, known that, at the same temperature, the pressure of elastic fluids is proportionate to its density, and as saturated steam at 121.4° C. has just double the pressure (or that of two atmospheres), it follows that the before mentioned 1789.078 cubic feet must have double the density, and therefore a volume of 894.539 cubic feet.

Having now conclusively proved that the volume of steam increases with the pressure, it follows that there is a decrease of volume with the decrease of pressure, and it is, therefore, evident that the mechanical effect of steam when cut off at any part of the stroke will not be fully one-half of that of its expansion; all this is nothing new, as many tables have been laid down to this effect, as noted above, but as a basis for further calculations on the advantage or disadvantage of cut-offs generally they are valuable.

Now, let us see if there is an advantage in practice by cutting-off steam at any part of the stroke. We will select a bore of cylinder of 200 inches area, or about 16 inches in diameter and 6 feet stroke. We have, at first, to contend with friction and atmospheric pressure at the exhaust; the first of these (friction) is the most difficult to find a basis for, but it being generally conceded that 2½ lbs. per square inch is sufficient in a well built engine, we will take that as a standard.

The atmospheric pressure at the exhaust is the same in both cases, and in relation to the quantity to be discharged, what is less in one case is made up by velocity in the other. It is to be remarked that when, according to the indicator, we work under 50 lbs. pressure, we actually have 64½ lbs. on the piston (theoretically), the difference of pressure in the boiler and that exerted upon the piston, we will omit, being in both the same, if any, as has been asserted. Let us take 60 lbs. total pressure on the piston, and then find the mechanical effect in following full stroke and cutting-off at one-half, one-third, and one-quarter stroke.

The mechanical effect of full stroke will be 60lbs. per square inch, or 12,000lbs. per 200 square inches, or 72,000lbs. lifted 1ft.
Deducting for friction 2½lbs. per square inch equals 500lbs., or 3000lbs. lifted one foot, and atmospheric pressure 14½lbs. per square inch equals 2950lbs., or 17,700lbs. lifted one foot = 20,700 " "

And there remains a clear effect of 51,300lbs. or 71¼ per cent. It has often been asserted that 85, 90, and 95 per cent. mechanical effect has been obtained, but this is decidedly an error, as the pressure was calculated agreeably to the indicator; the indicator in this case would only show 45¼ lbs. at 200 square inches equals 9000 lbs., or 54,300 lbs. lifted one foot, thus presenting a mechanical effect of nearly 94½ per cent., which is a deception.

The mechanical effect of cutting-off at one-half stroke will be 60 lbs. per square inch or 12,000 lbs. per 200 square inches; 3 feet stroke equals 36,000 lbs. lifted one foot; at the end of the stroke, as has been seen, we have 28.03 lbs. pressure, and, therefore, a mean pressure of 44.015 lbs. per square inch, or 8803 lbs. per 200 square inches; 3 feet stroke equals 26,409 lbs. lifted one foot; adding as above, we have 36,000 + 26,409 lbs. = 62,409 lbs. lifted one foot. Deducting the foregoing friction and atmospheric pressure, 20,700 lbs. lifted one foot, and there remains a clear mechanical effect of 41,709 lbs. lifted one foot, or 57.93 per cent., with half the amount of steam, or 83,418 lbs. lifted one foot, with full steam, being nearly 116 per cent. (115.86 per cent.)

The mechanical effect of one-third stroke will be 60 lbs. per square inch, or 12,000 lbs. per 200 square inches; 2 feet stroke = 24,000 lbs. lifted one foot; we have, as seen at the end of the stroke, 19.2 lbs. pressure, and therefore, a mean pressure of 39.6 lbs. per square inch, or 7920 lbs. per 200 square inches; 4 feet stroke equals 31,680 lbs. lifted one foot; adding as above, we have 24,000 + 31,680 = 55,680 lbs. lifted one foot. Deducting friction and atmospheric pressure 20,700 lbs. lifted one foot, and there remains a clear effect of 34,980 lbs. lifted one foot, or 48.53½ per cent., with one-third the amount of steam, or 104,940 lbs. lifted one foot, with full steam, being 145½ per cent.

The mechanical effect of one-quarter stroke will be 60 lbs. per square inch, or 12,000 lbs. per 200 square inches; 1½ feet stroke = 18,000 lbs. lifted one foot; at the end of the stroke we will have 13.19 lbs. pressure, or a mean pressure of 36.595 lbs. per square inch, or 7319 lbs. per 200 square inches; 4½ feet stroke = 32,935.5 lbs. lifted one foot; adding as above, we have 18,000 + 32,935.5 = 50,935.5 lbs. lifted one foot. Deducting friction and atmospheric pressure, 20,700 lbs. lifted one foot, and there remains a clear effect of 30,235.5 lbs. lifted one foot, or nearly 42 per cent., with one-quarter the amount of steam; or 120,942.0 lbs. lifted one foot, with full steam, being 168 per cent.

Again; let us see if the same proportions exist in a smaller cylinder, shorter stroke, and the same pressure; we will select an area of 50 in., or about 8 in. in diameter, 4 ft. stroke, and 60 lbs. pressure.

1st. The mechanical effect of full stroke will be 60 lbs. per square inch, or 3000 lbs. per 50 square inches: 4 ft. stroke = 12,000 lbs. lifted one foot.

Deducting for friction 2½ lbs. per square inch = 125 lbs., or 500 lbs. one foot, and atmospheric pressure 14½ lbs. per square inch = 737.5 lbs., or 2950 lifted one foot = 3,450 " "

And there remains a clear effect of 8,550 " "

2nd. The mechanical effect of cutting off at half stroke, will be 60 lbs. per square inch, 3000 lbs. per 50 square inches: 2 ft. stroke = 6,000 lbs. lifted one foot.

44.015 lbs. mean pressure per square inch, or 2200½ lbs. per 50 square inches: 2 ft. stroke = 4,401½ " "

Adding, we have 10,401½ " "

Deducting friction and atmospheric pressure = 3,450 " "

And there remains a clear effect of = 6,951½ " "

3rd. The mechanical effect of cutting off at one-third stroke will be 60 lbs. per square inch, 3000 lbs. per 50 square inches: 1½ ft. stroke = 4,000 lbs. lifted one foot.

39.6 lbs. mean pressure per square inch, or 1980 lbs. per 50 square inches: 2¾ ft. stroke = 5,280 " "

Adding, we have 9,280 " "

Deducting friction and atmospheric pressure = 3,450 " "

And there remains a clear effect of = 5,830 " "

or 48.58½ per cent. with one-third the amount of steam, and 17,490 lbs. lifted one foot, or 145¼ per cent. with full steam.

4th. The mechanical effect of cutting off at one-quarter stroke will be 60 lbs. per square inch, or 3000 lbs. per 50 square inches: 1 ft. stroke = 3,000 lbs. lifted one foot.
36·595 lbs. mean pressure per square inch, or 1829½ lbs. per 50 square inches : 3 ft. stroke = 5,489½ ” ”

Adding, we have = 8,489¼ ” ”
Deducting friction and atmospheric pressure = 3,450 ” ”

And there remains a clear effect of = 5,039¼ ” ”
or nearly 42 per cent. with one-quarter the amount of steam, and 20,157 lbs. lifted one foot, or 168 per cent. with full steam.

(To be continued.)

DEATH OF MR. JOHN WOOD.

The death of Mr. John Wood, the eminent steamship-builder, is announced. The deceased gentleman learnt the elements of his profession from his father, who was a ship-builder in Port Glasgow. In 1811, on his father's death, Mr. Wood assumed the responsibilities of the building yard. One of his first engagements was the construction of the steamer *Comet*, which had been contracted for by his father. He likewise built the *James Watt*, which was the first sea-going steamer. Subsequently he built a great number of steam-vessels, mostly large deep sea-vessels. The *John Wood*, *Vulcan*, *City of Glasgow*, *Commodore*, and *Admiral*, of the Glasgow and Liverpool line, were also built by Mr. Wood. Latterly, he built few wooden ships, partly from the fact of these having fallen much into disuse, and partly from his having become a relative of Mr. John Reid, iron ship-builder, Port Glasgow; and as such aided in raising the firm of Messrs. John Reid and Co. to the high reputation it now enjoys.

CORRESPONDENCE.

We do not hold ourselves responsible for the opinions of our Correspondents.

STEAMSHIP CAPABILITY.

To the Editor of THE ARTIZAN.

SIR,—When Mr. R. Armstrong professed to be able to make any existing steamer, tested by the formula $\frac{V^3 D^{\frac{2}{3}}}{\text{Ind. h.p.}} = C$, realise the co-efficient (C) = 250, and challenged me to show how I would effect the same object, I thought fit to take no notice of such pretensions, which for my own part I disclaim, although, as respects the construction of new steamers, I believe that this co-efficient would soon be generally realised in the Merchant Service if stipulated for as a condition of ships being taken off the builders' hands; it being, however, in this case understood that circumstances impose no restriction on the type of form—such, for example, as limitation of draught—and that the building contract include both hull and engines complete, the ship being loaded at her best trial down to the stipulated load displacement. By adopting types of hull and engine construction which have already realised the co-efficient C = 250, I believe that such would, after a short time, be invariably achieved under the contract stipulation above referred to. Also, under such contracts I believe that the co-efficient of dynamic duty with reference to coals, as determined by the formula $\frac{V^3 D^{\frac{2}{3}}}{w} = C = 10,000$ for smooth water, and

8000 for sea service (w being the consumption of coals per hour expressed in cwt.) would soon become generally prevalent—thus effecting an improvement in new ships of about fifty per cent. on the dynamic merits of the average of existing shipping, in which the co-efficients of sea service seldom exceed 6000. I may confidently affirm that various builders are now prepared to undertake such contracts; and if a numerical co-efficient of dynamic duty with reference to coals be recognised as the comparative test of constructive merit, the rivalry of builders will speedily conduce to progressive improvement in ship and engine construction.

Further, with reference to Mr. Armstrong's queries as to the causes of the variations of the co-efficients of vessels, nearly identical in form, I replied to Mr. Armstrong, in your number for December last, to the effect that I have so fully and repeatedly expressed my views as to the general and various disturbing causes which are liable to affect the co-efficients of performance, even with the same ship, on the occasions of different trials and under different states of condition of hull, and management of machinery, that I declined again to recapitulate such statements, but at the same time referring Mr. Armstrong to the published records of the British Association, in which I have taken part, and expressed my views on this subject, irrespectively of my various communications thereon to THE ARTIZAN, *The Journal of the Society of Arts*, and *The Mechanics Magazine*. Mr. Armstrong, however, by his letter in your number for this month, is pleased to designate this reference as a "prevarication," which choice expression obviously imposes on me the propriety of declining further correspondence with Mr. Armstrong; but in thus taking leave of him, I beg to acknowledge his having made himself, by his communications

to THE ARTIZAN, however unintelligible as respects his own theories, instrumentally useful, by affording me the opportunity which I may not otherwise have enjoyed, of promulgating my views on Steamship Capability, and publicly inaugurating a system of calculation under which, as set forth in the preface to my Essay on *Steamship Capability*, published in 1852, the result has been attained of bringing under the domination of figures "the compound combinations of Displacement, Power, and Speed, in relation to the cost of freight, which constitute the Arithmetic of steamship adaptation to the requirements of the mercantile service."

I am, Sir, yours very obediently,
CHARLES ATHERTON.

Woolwich Dockyard, 17th Jan., 1861.

To the Editor of THE ARTIZAN.

SIR,—In your last number on the subject of "The New Mail Steam Packet for the Holyhead and Kingstown Services," you have made some remarks on the performances of those packets, and further, in special reference to myself, personally, as the managing director of the Dublin Steam Company, which call for a reply. You observe that, "the inference you are compelled to draw from the studied concealment to which you have referred is, that, up to the present time, neither of the four ships have realised the expectations of their owners, the requirements of the service, or the conditions of the contract." To these allegations I have to give the most unqualified denial. The expectations of the owners have been fully realised in all the essentials, namely—speed, sea-worthiness, and general efficiency.

With respect to the requirements of the service, or the conditions of the contract, I will content myself on the present occasion by stating, that, after the experience of more than three months, that is, since the 1st of October, when the new service was commenced, and during the unusually severe winter, all the vessels have proved themselves in every way fully equal to its due performance. After the completion of one half-year, all needful information and details will be made public, and which will, no doubt, be considered of far more value, as communicating the results of actual work, rather than such as partial expectants might anticipate from a few trips made under more favourable circumstances.

So far as regards the public. With reference to myself, you then observe,—“Among the improvements, the absence of which we noticed, was any successful apparatus or contrivance for preventing smoke. This we naturally expected to find on board these ships. Having ourselves witnessed the denseness of the smoke emitted during nearly the entire time of the voyage between Holyhead and Kingstown in these new steam vessels, and the fearful waste of fuel which must be the result, we cannot avoid adding that we think Mr. C. W. Williams is called on, not only for the sake of the public, but in his own justification, to explain the cause of these serious defects in vessels constructed under his own eye, as the chief managing director of the company, and now under his immediate control.”

You are here pleased to impute to me personally, and to my management, the denseness of the smoke you witnessed and the fearful waste of fuel which must be the result. After commenting on the success of the boiler at Newcastle, under my management, and on which the distinguished judges reported the system to be "practically perfect," you ask, "why do the boilers in Mr. Williams's own steamers present such a remarkable contrast; and why does his theory and practice at Newcastle present so extraordinary a difference with the steam vessels under his own management?"

On this, and in my own justification, I have merely to state that, so far from being constructed under my own eye, I had no connection whatever with the construction or internal arrangements of any of the boilers in any of the four vessels. That I studiously avoided any interference whatever with the eminent firms who constructed the engines, so that the responsibility for the success of the vessels might rest exclusively with them; and I may add that, up to the present, I have not had a drawing or tracing of the details of any of the boilers in any of the four vessels. I trust, Sir, the above will be a sufficient reply to your remarks.

Yours, &c.,

C. WYE WILLIAMS.

Liverpool, January 21, 1861.

NOTICES TO CORRESPONDENTS.

L. T., J. D. S., and P.—We regret that your communications could not be inserted in the present number, for want of space.

R. D. (Glasgow), J. H. (Kelvin), AMATEUR (Newcastle), and TYRO.—Send your correct addresses, and we will reply by post.

J. F. S.—The papers will be sent.

Q.—Apply to Prof. Rankie, Glasgow; or, if you prefer it, write to us upon the subject in detail, and we will do our best to furnish you with the information sought. We make 6½ knots = 7·776 miles of 5280 feet, the knot or geographical degree being 6082·66ft. The geographical degree is assumed as = 69·121 miles. We cannot reply to the remaining question.

L. (Liverpool).—We were not able to be present at the trial trip, but we have been informed the bull was affected by the swell in the Lower Hope. We disap-

prove of the mode in which the "bow and string" principle has been applied. It is very well suited for supporting a fixed or moving load on the upper side of the platform, the piers or abutments forming the end supports at the feet of the bow; but, for resisting undulating motion or force applied at various points beneath the platform line and tending to raise it upward, and put out of position the various contrivances for strengthening or giving rigidity to the structure, it is not the best form or arrangement of materials. We believe the deck exhibited a little undulatory movement from stem to stern, whilst going at full speed, and when subject to the swell of a passing steamer.

P.—You will find, in the present number, as much information as we are possessed of, respecting Dr. Joule's recent experiments on surface condensation. We consider the experiments to have been conducted on too small a scale to be of any practical value beyond giving indications of the results which may be anticipated, if prosecuted thoroughly.

S. A. and Co., and others.—We have now completed the set of illustrations which were promised, but which have extended, in number, far beyond our original intention.

D. C. L.—You had better induce some engineering firm to allow you to try your plan of boiler in a commercial steamer, before applying to the Admiralty, where the mere mention of a pressure of 200lbs. per square inch would be sufficient to ensure your being politely bowed out. We are certain that you will not successfully realize the expected economy by the mere increase of pressure.

We are compelled to omit several important papers, numerous reviews of new books, and other matters which were prepared for the present number, but which we intend to give in a supplementary sheet with our next.

ERRATA.

In Plate 185, Fig. 6, the letter Q is omitted at the end of the dotted line commencing with P, where it is intersecting the arc R. R.

Page 329, 1st Dec., 1860, in the letter on "Foot-Valves," from "A Marine Engineer," to the Editor of THE ARTIZAN, 18th line, for "old slide-valve system," read "old slide-rule system."

NOTICE.

A copper-plate engraving, concluding the series of illustrations of the engines, boilers and machinery of the *Great Eastern*, will, if possible, be given in the number for March 1st.

The tables for calculating the speed of steam vessels—which were promised in our last—cannot for want of space be given until the April number.

The second plate of the Locomotive Engine, constructed by Messrs. R. Stephenson & Co. for the Great North of Scotland Railway, will, if possible, be given in THE ARTIZAN for March 1st.

RECENT LEGAL DECISIONS

AFFECTING THE ARTS, MANUFACTURES, INVENTIONS, &c.

UNDER this heading we propose giving a succinct summary of such decisions and other proceedings of the Courts of Law, during the preceding month, as may have a distinct and practical bearing on the various departments treated of in our Journal: selecting those cases only which offer some point either of novelty, or of useful application to the manufacturer, the inventor, or the usually—in the intelligence of law matters, at least—less experienced artisan. With this object in view, we shall endeavour, as much as possible, to divest our remarks of all legal technicalities, and to present the substance of those decisions to our readers in a plain, familiar, and intelligible shape.

SCOTT RUSSELL v. GREAT SHIP COMPANY, AND GREAT SHIP COMPANY v. SCOTT RUSSELL. —In the Court of Queen's Bench, on the 17th ultimo, these cross rules, relative to an arbitration with regard to certain work performed by Mr. Scott Russell for the company in fitting up, &c., the *Great Eastern*, were tried. In showing cause in the first rule, it was said the matter arose upon a contract whereby Mr. Scott Russell undertook to do certain repairs to the *Great Eastern* steamship for the new company, after the failure of the company who originally built the ship from the designs of the late Mr. Brunel. After the vessel was launched, and nearly a million of money had been spent upon her, she passed into the hands of the new company to complete her and send her to sea. The new company determined to fit her up at first for 1000 passengers only, instead of for 2500, as she was capable of carrying. Mr. Scott Russell contracted to do the work required for £125,000, to be paid £1000 a week extra for accelerating the work, and to forfeit a corresponding sum if the work was not done within the time specified. On going round to Portland an explosion took place on board the *Great Eastern*, for which Mr. Russell claimed a large sum for extras. A dispute arose between the parties, which went before arbitrators, who made an award, and cross rules had been obtained first on behalf of Mr. Scott Russell, calling upon the company to show cause why they should not pay that gentleman the sum of £18,000 pursuant to that award, or why the award should not be sent back to the arbitrators for reconsideration. Subsequently Mr. Lloyd obtained a rule calling upon Mr. Scott Russell to show cause why the award should not be set aside, on the ground that the arbitrators had dealt with matters which did not properly belong to them, the matters having reference to the extras charged in consequence of the explosion. After hearing the arguments of the learned counsel, which occupied nearly the whole of the day, the Court discharged both the rules.

AN INQUEST, adjourned from the previous day, was held on the 1st ult., on the body of William Southcote, a guard on the Oswestry and Newtown Railway. It appeared that the deceased was engaged at the Oswestry Station in the evening, shunting trucks, when in some unaccountable manner he got between the engine and a luggage wagon belonging to the Great Western Company. The result was that the unfortunate man was absolutely crushed to death, his entrails being forced out, and his arms and legs broken in several places. A verdict of accidental death was returned.

THE INQUEST on the bodies of Sophia Lowe and Mary Jones, who lost their lives through the accident which occurred a few weeks back near the Moreton Station, on the Shrewsbury and Hereford Railway, was resumed and concluded on the 23rd ult. at Hereford. The jury, after about half-an-hour's deliberation, returned a verdict of accidental death, accompanied by recommendations that the Shrewsbury and Hereford Railway Company should use a better quality of iron for tires of the wheels of their rolling stock, and that there should be a communication with the guard and driver.

NOTES AND NOVELTIES.

OUR "NOTES AND NOVELTIES" DEPARTMENT.—A SUGGESTION TO OUR READERS.

We have received many letters from correspondents, both at home and abroad, thanking us for that portion of this Journal in which, under the title of "Notes and Novelties," we present our readers with an epitome of such of the "events of the month preceding" as may in some way affect their interests, so far as their interests are connected with any of the subjects upon which this Journal treats. This epitome, in its preparation, necessitates the expenditure of much time and labour; and as we desire to make it as perfect as possible, more especially with a view of benefiting those of our engineering brethren who reside abroad, we venture to make a suggestion to our subscribers, from which, if acted upon, we shall derive considerable assistance. It is to the effect that we shall be happy to receive local news of interest from all who have the leisure to collect and forward it to us. Those who cannot afford the time to do this would greatly assist our efforts by sending us local newspapers containing articles on, or notices of, any facts connected with Railways, Telegraphs, Harbours, Docks, Canals, Bridges, Military Engineering, Marine Engineering, Shipbuilding, Boilers, Furnaces, Smoke Prevention, Chemistry as applied to the Industrial Arts, Gas and Water Works, Mining, Metallurgy, &c. To save time, all communications for this department should be addressed "19, Salisbury-street, Adelphi, London, W.C." and be forwarded, as early in the month as possible, to the Editor.

MISCELLANEOUS.

AT NEWTON, MAINE, U.S., a cotton mill, called the Androscoggin Mill, is nearly completed. It is 542ft. long, 74ft. wide, and four stories, or 75ft. high. It will contain 45,000 spindles, and they will be driven by two Turbine wheels, 6ft. 6in. in diameter, with a guaranteed horse power of 375 each. The mill will use 9390 bales of 5ewt. each, or 4,695,000lbs. of cotton per annum, and there are only two larger mills in the States. The establishment will cover 5½ acres of ground, and about 5,000,000 of brick, and the same quantity of lumber, have been used in its construction.

STREET ROLLING IN PARIS.—Steam rollers have recently been set to work in some of the streets of Paris, forming a great contrast to those unyielding-looking machines, drawn by eight horses, which every visitor to Paris must have seen at work, crushing down the stones at the Champs Elysées.

THE NEW STEAM FIRE ENGINE DEPARTMENT of Boston, U.S., is now fully organized, and there is not a single hand engine in use throughout the entire limits of the city.

ENGLISH GAS COMPANIES may save some hundred pounds per annum if they will take note of a small item—that is, the discovery of the fact by a French workman, who observed the effect on iron pipes in various soils, that iron gas pipes and water pipes may be kept from rusting by laying them in a bed of clay. The Paris municipal authorities consider this of so much importance that they have given him a handsome income for life as a reward.

STEAM-ENGINES IN GREAT BRITAIN.—Mr. Fairbairn estimates that the labour now performed by steam-power is equal to that of 11,000,000 horses, working ten hours per day. That is—

	Nominal horse-power.
Employed in mining and the manufacture of metal	450,000
" Manufacture	1,350,000
" Steam navigation	850,000
" Locomotion	1,000,000 = 3,650,000

And as these engines are working at an average of three times their nominal power, the above numbers represent a force equivalent to 11,000,000 horses; and taking one person to every nominal horse, we shall then have nearly 4,000,000 people to whom the steam-engine is giving employment in Great Britain and on board our ships. It is no wonder, therefore, that we revere the memory of Watt.

HOW SHIPS ARE BURNT AT SEA.—Two instances of lucifer matches spontaneously igniting were reported at Lloyd's on Saturday. The ship *Fiel*, loading for Havannah, in St. George's Dock, Liverpool, was discovered on Friday to be on fire. It was traced to a case of lucifer matches that had been surreptitiously shipped on board. The case, in a state of ignition, was got up and thrown overboard. Another instance of the dangerous character of such shipments took place at Fresh Wharf, London Bridge. A case, intended for one of the steamers loading at the wharf, was being carried down from a cart, when it fell on the ground, and instantly burst into flames. The case proved to contain lucifers and congreves. Had these vessels sailed for sea with these inflammable stores, it is probable that the most disastrous consequences would have ensued. It behoves Lloyd's to prosecute in all these cases, the character of the shipments being misrepresented.

NEW MOTIVE POWER.—M. Lenoir asserts that, on igniting by the electric spark a mixture of atmospheric air with hydrogen, the compound expands so greatly, as to have an elastic pressure on a piston similar to that of steam, and equally applicable to useful purposes. The proportion of hydrogen to air required, is from 2 to 5 per cent., and it is stated that heat obtainable from coal will answer.

MAGNETIC HAMMER.—Mr. Reinhold Boeklen, of Brooklyn, New York, has just obtained a patent for an exceedingly ingenious and very useful invention, which consists in so magnetising or applying magnetism in connection with a hammer, that it shall be capable of picking up tacks and nails, and enabling them, when so picked up, to be knocked into wood or other material, without the necessity of handling them; thereby affording great convenience for the application of tacks or nails in laying down carpets, or in upholstery, joinery, or other kinds of work.

NEW KIND OF STRAW PAPER.—Specimens of a new paper for printing, invented in Austria, and made entirely from maize straw, have reached Paris. The paper differs little, except in colour, from the ordinary paper in use for the daily journals. It is a shade more yellow, that is all; but the ink turns black, and the printing is perfectly legible. Some of the specimens are as fine as if intended for ladies' correspondence, and support a high degree of glazing. This paper, coloured pink or lilac, cannot be distinguished from the very finest qualities of writing-paper now in use. The advantage in cheapness is more than one-half.

THE OIL WELLS OF AMERICA.—The present yield of the wells in Pennsylvania and New York is more than 85,000,000 gallons a year. Discoveries in other States are reported, and the amount produced may safely be estimated at 15,000,000 gallons more during the present year, making an estimated amount of 100,000,000 gallons, to be gathered up during 1861. This oil readily sells by the wells in its crude state at 25c. per gallon, making the value of the whole amount 20,000,000 dols. In market it sells at 40c., and when purified at 75c., making its commercial value 75,000,000 dols., or more than £15,000,000. This oil is said to be valuable for lubricating purposes, no less than for illuminating. Should this prove the case, it will be exported largely to this country. Adding this article to the United States list of exports will have a strong tendency to keep the balance of trade favourable to that country. It is now sent to Australia, and it promises to rank second only to cotton on the United States list of exports.

ERICSSON'S CALORIC ENGINE.—In America, these motors have lately come into very extensive use, principally owing to their compact form and the small amount of fuel required to keep them in motion. They are employed in working printing presses, warehouse hoists, small mills, and for raising water in houses, mines, ships, &c., and in all

instances with the best success. The characteristics of this engine are, that it is not attended with the perils that attach to the steam engine; it requires no engineering supervision; any person may take charge of it, or it may be kept in action by a few minutes' attention of the workman who is using its power; it consumes a very small amount of fuel, say 33 per cent. of the steam engine, requires no water at all, and does not raise the rate of insurance.

BAROMETRIC INDICATIONS.—At the last meeting of the Royal National Life-boat Institution, held on the 3rd ult., Captain Washington, R.N., hydrographer to the Admiralty, called the attention of the committee to the desirability of erecting large barometer indicators wherever practicable on the coast, so that seamen and fishermen might be warned when in the harbour or offing, about two miles from the land, of a coming storm. Mr. Sopwith, President of the Meteorological Society, who takes great interest in the success of the barometer department of the Life-boat Institution's operations, exhibited at the meeting some fine specimen models of the proposed indicators. The institution decided that barometer indicators should, in the first instance, be placed in Northumberland, in compliment to his Grace the Duke of Northumberland, president of the society; also that one should be stationed at Wick in Scotland, and another at Arklow in Ireland. To carry out effectually this valuable suggestion a large sum would be required by the institution, not only to fit up the indicators, but also to pay persons for carefully and permanently attending to them. When it is remembered that nearly 1000 persons annually perish from wrecks on our coasts, every friend of humanity must rejoice in the establishment of any practicable plan for the mitigation of the fearful misery such a loss of life must cause in the homes of our seamen and others. A good barometer, if carefully watched, is an infallible indicator of a coming storm, and the day cannot surely be distant when a barometer can be made as portable as a pocket chronometer. Mr. Glaisher, F.R.S., verifies each barometer of the Life-boat Institution by the Greenwich standard, and it was decided to request the members not to sell any instruments in its name which had not previously been so verified by Mr. Glaisher, who takes much trouble in performing this important but gratuitous duty.

At a late meeting of the members of the Academy of Sciences in Paris, the Minister of Marine sent in an account, by Lieutenant Laporterie, of the effects of a stroke of lightning experienced on board the *St. Louis* man-of-war, in the roadstead of Gaeta, on the 10th December last. This account was accompanied by the platinum point of the lightning conductor which received the stroke, and a bit of melted copper from the rod of the same conductor. M. Laporterie states that after a violent gale which blew on the 7th and 8th the sky was covered with thick masses of clouds, and a storm broke out on the 10th, chiefly confined to the north-west part of the heavens. At 1.30 p.m., the electric fluid struck the conductor of the mainmast, accompanied by a detonation equal to that of a heavy discharge of artillery. A portion of the platinum point was melted, and the rest broken off from the rod. Curiously enough, the base of this platinum point, in the shape of a cone, had remained uninjured, with the screw in by which it had been fixed to the rod, while the remaining extremity of the rod, where the screw had been snapped off, was melted! The conductors of the fore and mizen masts had received no injury; but a sergeant who was seated near the funnel of the engine, at a distance of 19ft. from the mainmast, felt such a violent shock that he thought he had been struck by some Sardinian projectile which had fallen on board by accident. He thought he felt blood trickling from the wound; and it was only after undressing and submitting to an examination, that he could be persuaded he had not been wounded. At the foot of the mainmast a bluish flame, 2ft. in length, was noticed, but it immediately disappeared. The pocket-knife of one of the sailors was strongly magnetised, and the same was the case with some steel pens in the officers' rooms.

THE DENSITY OF ICE, given by Thomson as 0.940; Berzelius, 0.916; Plücker and Geissler, 0.920; and Kopp (ju 1855), 0.909, has been recently examined by M. L. Dufour, who gives the mean result of his experiments 0.9175; which corresponds to an increase of volume at the moment of congelation of about one-eleventh.

IMPROVED CHEMICAL FILTER.—M. Malapert, Professor of Toxicology at the School of Medicine, of Poitiers, has invented a new kind of filter, which promises to be highly advantageous to chemists. It is well known that the filters used in laboratories generally consist of a sheet of blotting-paper of a peculiar kind, which, after being folded like a fan, is put into a glass funnel resting on a receiver below. Now, it very often happens that if the solution to be filtered is poured in without great precaution, the paper will burst, and a new filter must be made. Sometimes, notwithstanding the greatest care, such accidents will happen on account of some flaw in the paper. M. Malapert obviates this inconvenience by preparing a kind of paper with a piece of linen contained in its very substance. This paper has the further advantage of containing neither lime nor iron, but at most a few traces of chlorine, and much less even of that than any other kind of paper.

STEAM SHIPPING.

THE AMERICAN Pacific Mail Steam-ship Company's new steamer, which is building by W. H. Webb, will be fitted with a single vertical beam engine of 15ft. stroke and 14in. diameter of cylinder. The vessel will have water-tight bulkheads.

THE RESISTANCE, iron steam ram, building at Millwall, is rapidly progressing towards completion. According to the terms of the contract entered into between the builders and the Admiralty, this ship should have been launched and partially fitted with her engines by this time. It is expected she will be afloat some time in March.

THE NEAPOLITAN FLEET, now incorporated with the Sardinian fleet, consists of 2 screw ships of the line of 82 guns, of 2 screw frigates of 55 guns, and 24 paddle-steamers carrying from 6 to 12 guns; giving a total of 411 guns on board steamers. The sailing-vessels are 4 frigates, 1 corvette, 3 brigs, and 1 schooner—carrying 310 guns. The same authority regards the effective strength of the Neapolitan Navy at 19 steamers with 310 guns, and 3 sailing vessels with 122 guns.

THE SARDINIAN FLEET, as it now stands, exclusive of the Neapolitan fleet, consists of 4 screw frigates, with 204 guns, 2 paddle-wheel frigates, 10 guns; 6 other steamers with 4 guns; giving a total of 248 guns in steamers. In sailing-vessels Sardinia has 4 frigates, 2 corvettes, and 6 brigs, with 304 guns. Some of these vessels are out of repair. An Austrian authority estimates the effective strength of the Sardinian navy at 12 steamers, 3 sailing-vessels, and 352 guns.

THE DEFENCE, iron-plated frigate, now building at Jarrow-upon-Tyne, is making very rapid progress, and, though inferior in size to the *Warrior*, she promises to be equally formidable in proportion to her bulk. Upwards of 1000 men are at present constantly employed upon her, and they work almost under cover, while the whole exterior of the fabric is lit up by gas, so that the workmen may prolong their labours after sunset. Notwithstanding all the efforts which are being made to hurry on to completion this gigantic undertaking, it will be fully four months before the work will be complete. A Government inspector is in attendance in the yard to see that the timber which underlies the iron plates, and which consists of Indian teak, is perfectly seasoned.

STEARBOATS IN RUSSIA, twenty-five years since, were comparatively unknown, except on the Neva; and they were but few on that river, and those mostly owned by a Scotchman named Baird, who introduced steamboats into Russia and made a large fortune by so doing. Now it may be observed there is hardly a navigable stream in that country in which steamers are not running. There are many on the Neva, running up to Lake Ladoga; also on the Volga, which is navigable for 1600 miles, and running down to Astracan and the Caspian Sea. On this sea there are many Russian steamers and sailing vessels, and it extends far down into Central Asia.

THE "ISIS," 44, sailing frigate, has been taken into dock, and is now in the hands of the shipwrights and caulkers, being prepared for a coal depot on the Coast of Africa. The interior of her hold is being lined with sheet iron

ADMIRALTY ORDERS have been received at Chatham by the superintendent of that dock yard directing a screw corvette of 21 guns, to be named the *Menai*, be immediately laid down on the third slip, from which the *Undaunted*, 51 guns, was launched a short time since. Immediately the order was received a numerous party of convicts and labourers commenced clearing away the materials remaining on the slip, and the vessel will be at once commenced, orders having been given that she is to be completed with all despatch.

THE FRENCH NAVY.—Orders have been given that three new iron-plated frigates, on the model of the *Gloire*, but with improvements, shall be constructed at Toulon, with the names of the *Provence*, the *Savoie*, and the *Revanche*. The Toulon journals, in announcing this fact, add that seven other frigates on the same model are to be built in the northern ports of France.

STEAM NAVIGATION IN RUSSIA.—A St. Petersburg journal states that, in 1859, the number of steamers navigating the rivers and canals was 353, of which 185 belonged to different companies, 170 to private persons, and three to the Ministry of Marine. Of the total, 93 belonging to the companies, and 122 to private persons, were employed in the navigation of the Volga, and its tributaries. The total steam power is not given, but we learn incidentally that 214 were powered to the extent of 13,175 horse-power. The engines employed are, 112, high-pressure, and 67 low.

ARRANGEMENTS are now being made for a series of experiments on board the Admiralty steam vessel, *Vivid*, in order to test the efficiency of a smoke-consuming apparatus, the invention of Mr. D. K. Clark, C.E., the well-known engineer, which, it is stated, is superior to the several inventions of a similar nature hitherto experimented on by Government.

TWO NEW SCREW STEAM VESSELS, the *Alligator*, 22, and the *Dartmouth*, 36, are to be laid down at Woolwich.

ARRANGEMENTS are now being made for the launch of the *Bristol*, 51, and the *Repulse*, 91, in a forward state.

SEVERAL of the screw gun-vessels built by private firms for the Government have been completed at Woolwich, and four of this class of vessels are in a forward state. The *Britonart* and *Wizard*, built at Newcastle, have been forwarded to Sheerness, and the *Cockatrice* to Portsmouth, for the steam reserve. The *Elipse* and *Star*, built at Millwall, are now under the hands of the shipwrights and carpenters for completion.

THE Drier and *Devastation*, steam vessels, having undergone almost entire re-construction in dry dock, during the past eight months, are now under the hands of the riggers, to be completed for the steam reserve.

THE Bombay, 80, and the *Arctusa*, 51, in dock at Chatham, being converted from sailing ships to screw steamers, have each a large number of shipwrights employed on them, in order that they may be completed with all despatch.

ORDERS have been received at Devonport to supply all first-class ships in the Navy with gigs thirty feet long, instead of twenty-eight feet, as heretofore.

THE KEEL of A SCREW FRIGATE, of 41 guns and 1200 horse-power, which is to be named the *Tetuan*, has been ordered by the Spanish Government to be laid down at the Royal Arsenal of Ferrol.

"ARIEL," 7, screw steam-sloop, commander J. R. Alexander, arrived at Madeira on her way to the Cape of Good Hope, on the 18th of December. She had made the passage out under sail, and proved herself to be a good sea-boat.

"CAMILLA," 16, sailed from Nagasaki on the 3rd of June for Kanagawa, and is supposed to have been lost on the 9th of September.

THE La Plata has been taken into dry dock to have the damage caused by the late fire repaired. To facilitate the work, gas has been introduced into the ship, and relays of men work night and day to get her ready for sea.

"TERMAGANT," 25, screw steam frigate, Captain Robert Hall, was, by letters of the 19th of November, at San Francisco, California. She had happily received very little damage from the tumbling in of the dock, but was extricated from the ruins and debris with very great difficulty. The temptation of the vicinity of the gold diggings was too strong for her loose characters, and she lost forty-two men by running during her stay in this port. She was to embark freight for Panama, to which place her letters by next mails should be directed.

"LINNET," 2, gun-boat, 60 horse-power, left Sheerness on the 8th ult. for a trial of her machinery and speed at the measured mile. The vessel was under the superintendance of Captain Schomberg, of the steam reserve at Sheerness, accompanied by Mr. W. Price, inspector of machinery afloat, and Mr. J. Baker, chief engineer at Chatham Dockyard. The machinery of the vessel is by Messrs. Maudslay, Son, and Field. The results of the trial were successful, both the machinery and the boat giving satisfaction. Draft of water, aft, 7ft. 3in.; forward, 6ft. 5in.; high pressure of steam, 60; revolutions, 150; speed, 8.4. The *Linnet* is one of the vessels on *The Navy List* not honoured with a number by the compilers.

"CYGNET," 5, screw steam-sloop, has been out for repeated trials with propellers, amounting now to over forty runs. On returning up harbour on the 2nd ult., the rapid tide caught her on the bows, and before she could be turned she ran foul of the *Prince of Wales*, 3-decker, and tore away the figure-head and part of her cutwater; not, however, of sufficient consequence to put a stop to the series of experiments commenced in her, and now nearly finished.

"EURYDICE," 26, sailing-frigate, is ordered to be a training ship. She will be commissioned in the spring, probably by Commander Marcus Lowther, with Lieut. George S. Nares as first lieutenant. The *Eurydice* will be chiefly devoted to the purpose of instructing the naval cadets of the *Britannia* in their sea-going duties—a capital move on the part of the Admiralty.

PEED OF AMERICAN STEAMBOATS.—The steamboat *Daniel Drew*, the details of which have already been given in the ARTIZAN, has lately run from New York to Albany, 150 miles, in the unprecedented time of six hours and fifty minutes; tide favourable and equal to 2.3 miles per hour, but wind fresh ahead. Her time to Hudson, 125 miles, was but five hours and five minutes, which is equal to a net speed of 22.3 miles per hour through the water with an adverse wind. The time to Hudson is selected solely for the reason that above that the depth of the river is insufficient to admit of very high speeds. The times of previous quick runs are—

North America	1826	10 hours	20 minutes.
Ditto, lengthened, ...	1832	9 "	21 "
Albany	1840	9 "	27 "
Troy	1841	8 "	10 "
Alida	1849	7 "	45 "
New World	1851	7 "	43 "
Francis Skiddy	1852	7 "	30 "
Armenia	1860	7 "	42 "

ORDERS have been received at the War Department, Portsmouth, to prepare the armament of the new iron screw steamer *Warrior* by the end of March. The guns will be forwarded at an early date from the Royal Arsenal, Woolwich. The armament of this wondrous ship will be—on the main-deck, 34 68-pounders, 95 cwt., 10ft. long; and, on the upper-deck, 2 68-pounders, 95 cwt., 10ft. long, pivots; 4 40-pounders, Armstrong guns 10ft. long.

THE STEAMSHIP Queen Victoria was floated off from the rocks in Barn Pool at 5.45 p.m. on the 28th ult., and at 7 p.m. placed on the beach, where she lies fore and aft, with her head about south.

THE LORDS of the ADMIRALTY have decided on discontinuing the system of job and task work at Chatham Dockyard, which has been in operation at that establishment during the last few years.

RAILWAYS.

RAILWAY AND OTHER BILLS.—The number of private railway and other bills deposited in the House of Commons for the parliamentary session of 1861 are as follows:—Railway bills, England, 177; Wales, 34; Scotland, 34; Ireland 24; total 274; Waterworks bills, 19; Gas bills, 17; Harbour, Dock, and Port bills, 6; Market bills, 4; Road bills, 14; Miscellaneous bills, 63.

GRAND TRUNK RAILWAY, CANADA.—The committee of Bondholders have published a report preparatory to the meeting of the company called for the 2nd of January. It details the constitution and present state of the company, points out that £2,500,000 will be required to meet floating claims (including overdue interest) and to provide rolling stock, and recommends a thoroughly searching investigation in Canada into the history of the undertaking, a recommendation which the London directors will no doubt be desirous to promote.

FOR THE BIRKENHEAD STREET RAILWAY a car has just been completed in Philadelphia.

IN LOCOMOTIVES the greatest length of stroke ever proposed to be used was specified by Mr. Joseph Whitworth, the eminent mechanical engineer who, in his patent No. 7453, obtained in 1837, shows a locomotive with a stroke six feet in length, which, through a rather complicated arrangement of gear and ratchet work, causes the driving wheels to revolve, and thus propel the engine.

THE BERKSHIRE TUNNEL, New England, U.S., now in course of construction, will be four miles in length, and at the deepest part 1800ft. below the surface. The shafts are about a mile from either end, leaving two miles of solid material between them. The rock is all mica and quartz.

MR. JOHN FOWLER, C.E., has been appointed consulting engineer of the Great Western Railway, in the room of the late Mr. Brunel.

THE NEW FORM of street railway, lately invented and called "The Perambulator Street Railway," consists of flat tramways, level with the street, and a middle line with a sunk groove, into which a perambulating wheel, attached to any ordinary omnibus or other vehicle, is made to dip by pressure on a spring with the foot. It is stated by a gentleman who has recently inspected it at Pendleton, that the result will be its early introduction and rapid extension in this country and on the Continent, as an improvement on other plans. He also says the perambulatory apparatus can be attached to existing omnibuses at comparatively small cost, and the gauge of their wheels also adjusted, as they do not vary much from one standard. The driver finds no difficulty in dropping the perambulator into the groove, and the travelling of the 'bus is, of course, much smoother. The cost of the triple line, he adds, is said not to exceed £900 per mile, while Mr. Train's involves an expense of fully three times that amount. What of the middle groove, however; how is it to be kept clear of mud and stones on macadamised roads?

AT THE INSTITUTION OF ENGINEERS IN SCOTLAND, the President observed:—"It would appear now to be considered as a matter not to be questioned that in the present state of locomotive progress and experience, an engine can be made to run and do work satisfactorily on common roads. Several engines at work in England have given considerable promise of success; but there appear still to be some difficulties yet to be overcome in producing a good, serviceable, and durable road-engine. That such a thing is at present required there is no doubt, and the mechanical engineer has a new field to open up in this direction for his skill and industry.

A TELEGRAM has been received from Copenhagen to this effect:—"The Danish Diet sanctioned to-day (25th Jan.) the Government contract for the 18th December, 1860, with Sir Morton Peto, relative to the railway through the island Fyen, the east coast of Jylland, from Aalborg to the South-Slesvig Railway, and from Aarhus towards the west coast.

TELEGRAPHIC ENGINEERING.

ELECTRIC TELEGRAPH AT OLDHAM.—Messrs. Platt, Bros., and Co., the extensive machinists of Oldham, have lately had constructed for them a line of telegraph of a somewhat novel character. The two great branches of this establishment are about a mile and a half from each other, on opposite sides of the town, which is now bridged over by the electric telegraph. The wire, which is of steel, and about two-tenths of an inch in diameter, is supported for its entire length near the summit of six tall factory chimneys at an elevation of 180ft. from the ground, and leaving clear spans of 1000ft. to more than 2000ft. between the supports. The lowest points of the curves ranged from 70ft. to 120ft. above the surface of the ground. To a spectator placed at the extremity of the curve formed by the longer lengths, the wire appears to stretch out like a thread which vanishes in the mist long before the eye reaches the other. The chimneys to which the telegraph is fixed being always at work, and consequently very dry, renders insulation almost unnecessary, access to the tops of the shafts being gained by the means of ropes drawn over with a kite string.

RUSSIAN TELEGRAPHIC LINES.—The telegraphic lines of Russia have advanced into Asia, and are progressing with a rapidity that is extraordinary. Siberia will soon be traversed with them; and it is reported that the Russian Government propose to connect Siberia with America by means of a submarine line along the Aleutian islands. It is not altogether impossible, therefore, that our American, as well as our China news may come to us through Russian channels.

ELECTRIC TELEGRAPHY.—M. Verard de Saint-Anne, a short time ago, sent a paper to the Academie Francaise on a project for establishing a belt of electric telegraphs all round the world. In the United States the network of telegraphic lines comprises a length of 70,000 kilometres, or 47,250 English miles; and when the New York and San Francisco line is completed—the line over Europe and Asia being supposed to exist—there would only be 3500 leagues of cable to be sunk in order to enable Paris and London to receive intelligence from Canton in one hour and fifty minutes, from New York in two hours and twenty minutes, and from Valparaiso in three hours and a quarter. A considerable number of partial lines, which, according to the author, may easily be collected into one great whole, are already in existence, or about to be established. Thus, in Japan, the lines have been granted to a company, and one of them is in course of construction; New Zealand is already connected by a cable with Australia, Melbourne with Sydney, and Batavia with Singapore; the whole continent of India, thanks to English enterprise, is now being intersected with telegraphic lines.

ELECTRO-TELEGRAPHIC PROGRESS.—Dr. L. Bradley, of New York, has invented a plan by which he can transmit 15,000 words per hour, using the signs constituting the Morse alphabet. This is at the rate of four words per second, the highest number reached by the ordinary method of operating being only thirty-three words per minute. He has discovered a relay magnet capable of acting at the rate of 10,000 words per hour.

PRIVATE TELEGRAPHS.—The first electric telegraph devoted to private use, it is believed, in the south of England, has just been erected at Southampton, connecting the two establishments of Messrs. G. Phillips and Co., situated respectively in the High-street, near the Bar-gate, and in Cannt-road, opposite to the entrance to the docks. The primary object of the firm in the erection of this telegraph was to effect speedy communication between their two establishments, but arrangements have been made with the Electric Telegraph Company to enable the public generally to avail themselves of its use. An office will be opened at the High-street establishment, in all respects under the same regulations as to privacy, rates, charges, &c., as the company's offices, for the transmission of messages to and from the docks, and all parts of the world. As it is situated in the centre of the town, in the immediate neighbourhood of the banks, solicitors' offices, &c., it will be a great accommodation to the public. The wire extends over the house-tops, a total distance of about a mile, and has five supports, each post being fitted

up as a flagstaff, and is carried into the Electric Telegraph Company's establishment at the railway terminus.

THE NEGOTIATIONS commenced at Constantinople for the prolongation of a telegraphic line from Bagdad to Teheran are approaching a conclusion, and the line is to form part of a vast network which will place Persia in communication with Turkey and the different States of Europe.

OF SUBMARINE ELECTRIC TELEGRAPHS not 1200 miles are in working order out of the 12,000 miles that have been laid!

MILITARY ENGINEERING.

THE ARMSTRONG GUN.—One of the cast-iron experimental guns, strengthened according to a principle suggested by Sir W. Armstrong, in order to prove their capability of being rifled for service, was lately tested at the Royal Arsenal butt, Woolwich. An order having been given to increase the charges and continue firing so as eventually to burst the gun, the experiment was carried out in a bomb-proof shed recently constructed for that special purpose. The chamber of the gun was solidly imbedded in a coating of gun-metal three inches in thickness, which was incrustated over the entire portion subject to the greatest amount of shock from the explosion, and extended over the headpiece, leaving the casable ring only visible, down to the trunnions. Several rounds were fired with exceedingly heavy charges, and at length the gun itself gave way under the excessive charge, and was torn into fragments, but the coating of gun-metal remained entire.

WOOLWICH ARSENAL.—**THE ARMSTRONG AND WHITWORTH GUNS.**—Colonel Ladanni, an officer of the Sardinian cavalry, entrusted with a special mission to this country, for the purpose of entering into negotiations for the manufacture of English ordnance for the Sardinian Government, visited Woolwich Arsenal lately, accompanied by Mr. Pegg, one of the contractors, with a view of making arrangements for proving at the Government butt a number of the guns and mortars already completed. A few of each description were received at the arsenal some days ago, but, in consequence of the pressure at the present moment on the proof department it was stated that a delay of some ten or fourteen days must necessarily ensue before the request could be complied with, due notice of which would be forwarded to the Sardinian Embassy in London.

ONE OF THE HEAVIEST ARMSTRONG SIEGE GUNS manufactured in Woolwich arsenal, under the superintendance of Mr. John Anderson, was lately tested at the proof butt. The gun was fired two rounds, each time with a charge of 25lb. of powder and a 100lb. shot. The trial was perfectly satisfactory, and the gun was forthwith stored with others of that class proved during the preceding days of the week, to be issued for service. A couple of the Whitworth cannon were afterwards subjected to the ordinary test. The first was a 12-pounder, which stood the trial exceedingly well, and was very much admired. The power of the gun was of such an extraordinary nature that the shot penetrated completely through the mound of earth against which it was fired. The second, an 84-pounder, was then fired—two rounds with a charge of 24lb. of powder and a service shot. After the second round it was observed that the joints had started, showing a crevice at that part of the gun where the junction of the segments is effected. The crevice, although exceedingly slight, was clearly perceptible when pointed out by those accustomed to that duty.

LAUNCHES OF STEAMERS.

THE SCREW FRIGATE "UNDAUNTED," 51 GUNS.—The first of the squadron of large and improved screw frigates now building for the British Navy, all of which have been laid down under the auspices of the present Board of Admiralty, was successfully launched at Chatham dockyard on the 1st ult., in the presence of a large number of spectators. The *Undaunted* has been a little more than a year in building, and immediately the order was given for her construction every effort was made to have her completed with the utmost possible dispatch. She was designed by Rear-Admiral Sir Baldwin W. Walker, the late Surveyor of the Navy, and has been built under the direction of Mr. O. Lang, the master shipbuilder at this dockyard, and his assistants. The following figures show the principal dimensions of this fine frigate:—

	Feet.	In.
Length between perpendiculars.....	250	0
Length of keel for tonnage.....	214	9
Breadth, extreme.....	52	1
Breadth for tonnage.....	51	7
Breadth moulded.....	50	9
Depth in hold.....	18	10

Burthen in tons, 3399 44-94ths.

Her armament will be an exceedingly heavy one, and will consist of 51 guns, which will be arranged as follows:—On the main deck 30 8-inch guns, each 65cwt., and 9ft. long; on the upper deck, 20 32-pounders, each 55cwt., and 9ft. 6in. long; and one 68-pounder pivot gun, of 95cwt., and 10ft. in length. Her engines are to be constructed by Messrs. Ravenhill and Co., and will be of 600-horse power (nominal). The launch was an excellent one, not the slightest hitch occurring, and no "hanging" on the ways. She will be at once furnished with her engines, and be made ready for the steam reserve. Another large screw steamer will be commenced on the same slip.

RAILWAY ACCIDENTS.

A SERIOUS ACCIDENT occurred at Swinton, at the junction of the Doncaster and Sheffield branch with the main line of the Midland Company, on December 23, at a little distance from the spot where the branch diverges from the South Yorkshire line. The 1.10 p.m. train from Doncaster was about ten minutes beyond time as it approached the Swinton station, and although the fast train from Leeds to Derby and London was then due, the signal-man allowed it to proceed. The fast train came up to its time, and the consequence was that just as the Doncaster train was entering the main line the fast train ran into it, and hurled the engine down an embankment. The disabled engine struck the parapet of the bridge, which at this point passes over the canal, but it did not fall into it. Had the coupling chains remained intact, or had the train been a few yards in advance, the loss of life must have been fearful. As it was, no fatal results ensued; in fact, but few of the passengers were bruised, and no bones were broken. The fast train was not injured, and proceeded at once on its journey. With but one exception, this is the only accident that has occurred on the Midland line for some years past.

TWO ACCIDENTS occurred on the Eastern Counties Railway in consequence of the late frost, but happily they have been unattended by any of those serious results which have ensued from similar causes on other lines. The first occurred to a goods train, shortly after passing Ingatestone station, on its way to London. The rails were in a very slippery and dangerous state by reason of the frost, and the intense cold so acted upon the iron-work of the trucks, which were heavily laden, that one of the axles snapped, and the body of the vehicle dropped upon the permanent way. Although travelling at a moderate rate, the hindmost carriages smashed almost to pieces, the *debris* completely blocking the up-line. This accident rendered it necessary to use the down-line between Ingatestone and Brentwood for the early passenger traffic both ways on the same day, and it was shortly after passing the broken-down luggage train that the second accident occurred to the express train from Chelmsford to London. It was proceeding at somewhat less than its ordinary speed, when a large portion of the tire of one of the carriage wheels was seen to fly off the line. The train was immediately stopped, and fortunately no personal injury was sustained.

AN ACCIDENT of a serious character occurred near Gainsborough, in connection with the last through train from Manchester to Hull, on the night of the 26th December. It appears that the railway company are in the habit of attaching a third-class carriage to

this train at Retford, which is invariably placed behind the guard van. On arriving at Gainsborough, several third-class passengers were booked, and altogether there were about twenty passengers in this carriage at the time. On nearing Thonock-lane bridge, the passengers in this last carriage began to notice that something was wrong, the carriage jumping about in quite an extraordinary manner. Presently there was a crash, the windows broke (flying inwards), and the carriage fell down on one side, one of the wheels having come off. The other wheel soon followed, and the end compartments of the carriages were gradually smashed to pieces. The most serious case was that of a mechanic from Grimsby, who sustained a fracture of the skull. Several others received some slight injury. It seems that the accident was not discovered before the train reached Blyton, four-and-a-half miles from Gainsborough, notwithstanding that the cries of the whole of the twenty passengers were terrific.

A COLLISION occurred on the morning of the 2nd ult., on the Hartlepool branch of the North Eastern Railway. A train loaded with pit props was going up the line from Hartlepool, and had got near Trimdon Station, when an engine coming down on the other line took some points laid down at the spot where the train was passing, and, crossing over, dashed into the waggons, throwing them off the line, as well as displacing itself. Both up and down lines were blocked up.

ON THE MORNING of the 3rd ult., on the London and North-Western Railway, as the mail train leaving Liverpool at 4.5 in the morning, between Berkhamstead and Watford, the tire of one of the wheels of the engine broke, and the train was suddenly brought to a stand-still. The suddenness of the stoppage, occasioned considerable alarm, many of the passengers being much shaken. One gentleman received a cut upon his forehead, but, fortunately, the wound was not a serious one; another was found with his leg broken, and suffering from several severe contusions. A good deal of alarm was excited by the shaking and jolting of the carriages. The traffic was stopped for about two hours.

NEAR SITTINGBOURNE, on the Chatham and Dover line, an accident occurred to the down express train leaving Victoria Station at 9.55, which had started five minutes behind its time, and on arriving within a short distance of that station was half-an-hour behind. Everything appeared to have gone right with the train until it arrived within a mile of this station, when the tire of one of the leading wheels of the first guard's break van, next the tender, flew off. This had the effect of throwing the guard's van off the line, dragging with it a third-class and also a first-class carriage, both of which were thrown over on their sides. The head guard was so violently bruised and shaken, as to have been unable to do anything towards stopping the train. One passenger was killed, and several others injured. In consequence of the accident, the down line was blocked up for several hours; but an efficient staff of labourers, under the direction of the station-master, were employed the whole of the day in clearing the lines. This is the first fatal accident which has occurred on this line since its opening for traffic.

A SERIOUS ACCIDENT occurred on the 3rd ult., on the London and North-Western Railway, by which the traffic was seriously impeded. As the express train from Manchester, which is due in London at 11 p.m., neared the Camden station, two first-class carriages and a break van became detached, ran off the line, and upsetting, caused terrible confusion. The train proceeded on to Euston-square, which it reached before the carriages in question were missed. So soon as the discovery was made, a special engine and carriage, with a number of railway officials, were despatched from Euston Station to render assistance, when it was found that a gentleman was killed, and several others had sustained serious injuries. The line was speedily cleared, and after a delay of three hours the traffic was resumed.

ON THE GREAT NORTHERN RAILWAY an accident of a serious character, involving the destruction of a considerable amount of property, happened on the afternoon of the 4th ult., near Essendine, the junction with the Great Northern of the lines to Stamford and Bourne. It seems that while a goods train was running between Bytham and Essendine, on the up line, and within a mile of the latter station, a waggon suddenly left the rails. Shortly afterwards the train broke in two parts—that portion attached to the engine dashing forward, whilst the other, headed by the disabled waggon, and consisting of about 10 or 12 vehicles, nearly all left the rails, tumbling about in strange confusion. Both lines were blocked, and of course the passage of all traffic for a time was prevented. Assistance, however, soon came from Essendine and Peterborough, and firstly under the direction of the station-master at Essendine, and subsequently of the district manager, a clearance was effected, and the traffic, which had been detained three or four hours, was resumed. Eight waggons now lie on the line side in a mangled and disabled state, some topsy-turvy, others on their sides—all evidence of the violent nature of the accident. It is stated by the officials that the cause of the waggon, which was an Eastern Counties' one, leaving the line, was the breaking of its leading tire.

FATAL ACCIDENT ON THE SHREWSBURY AND HEREFORD RAILWAY.—On the afternoon of the 4th ult., a sad accident occurred near the Merton Station, about five miles from Hereford, to the down train due in that city at 2.40 p.m. By the breaking of an axle, or the tire of one of the wheels of the carriage preceding the guard's van, the connection between the first carriage and the tender was severed. The whole of the carriages, five or six in number, with the exception of the first, were thrown off the line down an embankment into a meadow, over which the waters of the River Lugg had overflowed to some depth, and which were covered with ice. The alarm of the passengers as they were toppled over in a state of pell-mell confusion, and then as they suddenly immersed in water to a considerable depth, was intense. The engine fortunately remained on the line, and the driver was thus enabled to go on and get assistance. Medical men from Hereford soon arrived. Two females were found to have been drowned, but the other passengers marvelously escaped with a few slight injuries. The guard was up to his neck in water, and was with difficulty rescued from his perilous position. The passengers and also the dead bodies were removed to Hereford, and sent to the hotels, being wet and shivering from the immersion.

ACCIDENT ON THE WEST MIDLAND RAILWAY.—The excitement which was created here by the unfortunate accident which occurred on the 4th ult., on the Shrewsbury and Hereford Railway, about six miles from Hereford, had not yet subsided when an accident of a still more serious character happened on the Hereford, Abergavenny, and Newport section of the West Midland Railway. From the statements of the officials of the company, it seemed that the train, quitted Newport as usual, at 5.45 p.m., and that it consisted of six carriages, and proceeded safely, at its ordinary speed (which is somewhat slow), until it reached the Nant-y-dering Station, about twenty-five miles from Hereford, and two stations beyond Abergavenny. Between that station and Pen-y-gwry, however, the fourth carriage behind the engine got off the rails. The passengers in the other carriages found that something was amiss, and, as all were aware of the accident of the previous day, a state of anxious fear succeeded which it is impossible to exaggerate. Fortunately the guard and engine-driver soon had their attention directed to this alarming state of things, and, as soon as possible the engine was reversed, and the train brought to a stand. It was then discovered that the tire of one of the wheels of the fourth carriage had broken—it is supposed through the fact that but otherwise neither that carriage nor any other was injured, while the passengers—almost by a miracle—had escaped with a few trifling bruises. Nevertheless, three hours elapsed before the line was cleared and the train able to proceed.

ANOTHER ACCIDENT ON THE LONDON, CHATHAM, AND DOVER RAILWAY.—Scarcely had the coroner's jury separated which had been assembled, on the 6th ult., at Sittingbourne, to inquire into the particulars connected with the fatal accident which took place at that station the previous day, than an accident of a much more serious character, and attended, unfortunately, with more alarming results, occurred a short distance from that station, and only a few miles from the scene of the late fatal accident, by which, we regret

to state, two persons lost their lives, and one, if not more, of the passengers was so seriously injured that no hope was entertained of his recovery. The train to which the accident occurred was the last down train from Victoria Station, which it left at 7.45. It consisted of six passenger carriages, and two break vans placed at both ends of the train. Everything, it appears, proceeded safely until the train was within a short distance from Teynham Station—which it is thought to reach at 10.1—when, just as it was proceeding, about twenty miles an hour, and the engine-driver was sluttish, or had shut off the steam, the engine, which was a very large and powerful one, gave a sudden bound, and left the rails, dragging with it the tender, the break van, and the whole of the carriages, with the exception of the last. The effect of the accident was one of the most appalling characters. The engine, which was named the *Bolsee*, is described as having turned a complete summersault, the tender at the same time being thrown over it. The fireman of the engine was killed on the spot, and another fireman in the employ of the company, who happened to be riding on the engine, was also killed. The engine-driver, who was one of the most efficient drivers in the company's employ, was also severely injured by the engine falling over upon him, and by scalds from the hot water and steam. The guard's van and the other carriages comprising the train were all huddled together, and their *débris* scattered in all directions. Fortunately there were not many passengers in the train at the time, but those appear to have had some marvellous escapes, considering that all the carriages were completely smashed. One of the passengers, a clergyman, who occupied a seat in the centre of the train, was severely cut and bruised. Several other of the passengers also received rather serious injuries. The whole of the sufferers were carefully removed to the Teynham Station and the adjoining hotel, where medical assistance was promptly obtained, and their wounds and other injuries attended to. It was considered probable that the accident was caused through the late severe frosts having contracted the metals of the line, and widened the gaps between the rails! On the engine coming to one of these gaps it probably gave a jump, and, instead of the wheels falling on the metals, they bounded aside, there being a slight curve there.

AN ACCIDENT, happily unattended with serious consequences, happened to the through parliamentary train from Hull to Manchester, on the 7th ult. Just as the train had got through the very long tunnel about two miles from East Retford, a tire from one of the carriages in which there were many passengers came off, and, breaking through the floor, flew right up to the roof of the carriage. Fortunately in its descent no person was seriously injured. The wheel, however, coming off altogether shortly afterwards, the carriage was much broken up before the train could be brought to a stand. The accident was caused, it is supposed, by the severity of the weather.

A COLLISION of a serious, but not of a fatal character occurred at the Mirfield Station of the London and North-Western Railway, about nine miles from Leeds, on the 7th ult., at noon. The facts are as follows:—The Lancashire and Yorkshire mail train left Normanton at 5 minutes past 11 a.m., being due at Mirfield at 11.45. On approaching the distant signal on the Thornhill side of the Mirfield Station, about half-a-mile distant, the axle-tree of the leading wheels of the guard's van, next the engine, broke, and the driver brought his train gradually to a stand, when the guard jumped out of the van for the purpose of going back to stop any approaching train. Immediately on alighting a London and North-Western train of empty carriages from Wakefield, which was following close behind, ran into the passenger train at a terrific speed. It is supposed that the driver of the London and North-Western train had not time to stop his engine, or even seriously to check the speed at which the train was proceeding. The passengers were thrown violently against each other, and the guard of the London and North-Western train received a shock which rendered him insensible. About a dozen of the passengers sustained cuts and bruises about the head and face. In addition to the injury of the passengers, five of the carriages belong to the London and North-Western train were forced off the frame-work, and the train was delayed for about an hour.

ON THE SAME NIGHT an accident occurred between Luton and Dunstable, the chief casualty being the delay of both up and down trains for several hours. On the down train from London, due at Luton at 7.40 p.m., reaching about half-way between Luton and Dunstable, the axle of one of the wheels of the engine snapped, which immediately stopped the progress of the train, at a spot where only a farm-house was near, delaying it for two or three hours.

AN ACCIDENT occurred on the night of the 8th ult., on the London and North-Western Railway, almost within sight of the London terminus, by which one gentleman, a first-class passenger, sustained serious injury, others were slightly cut and bruised, and the guard of the auxiliary mail was much hurt. The auxiliary mail train started at 9.15, and in five minutes afterwards was followed by the 9.20 short mail train to Wolverhampton. On reaching the incline upwards from the outside of the northern end of the station to Camden town, the driver of the engine drawing the auxiliary mail found the rails so slippery, that, with all the steam he could put on his engine, he could not advance, although the usual practice of throwing gravel and cinders on the rails was resorted to. It was not until the driver of the Wolverhampton train had passed through this bridge that he was aware the auxiliary mail was immediately before him on the same line. He was unable to check the impetus upon it in sufficient time to prevent a collision. His engine ran into the guard's break van, in which was the unfortunate guard. With the exception of one passenger and the guard, it was found that the injuries sustained by the other passengers were of a superficial character, and the injured people were enabled to proceed on their journey. None of the carriages were displaced from the line, and, after a short delay, both the auxiliary mail and the Wolverhampton train were enabled to proceed on their journey.

ON THE 9th ult. an alarming accident occurred on the Bristol and Birmingham branch of the Midland line, near Mangotsfield. When the slow train, which left Bristol at 1.35, with about twenty passengers, had reached the Rodway-hill cutting, the engine driver observed a large quantity of stones and *débris* upon the line on which he was travelling. Owing to the curve this obstacle had not been seen by him till he was nearly upon it; he, however, with great promptitude, immediately reversed his engine, but not in time to prevent a collision between the train and the mass of rock which lay upon the rails. The heap of stones was of such a height that it came into contact with the buffer of the engine, which is about four feet from the ground, and split it. The engine was thrown off the rails, and, forcing its way through the *débris*, dragged the carriages also off the line. The train ran for about fifty yards between the up and down line, ploughing up the ground, and jerking the carriages over the sleepers; but happily causing the passengers no injury. It was subsequently discovered that several tons of stone had—it is supposed owing to the frost—become dislodged from the rocks, which, at this point, attain a height of thirty feet on the side of the up line, and fallen upon the rails. None of the carriages were at all damaged, but the engine was disabled owing to the front axle having been bent. Steps were promptly taken to substitute another engine and carriages for the disabled train, the passengers being taken on to the Mangotsfield Station by the fast train, and labourers were set to work to clear the line. Had the fall taken place upon a passing train, the probabilities are that we should have had to record a loss of life, as the immense mass of stone which fell (computed at several tons' weight) must have penetrated the roofs of the carriages and fallen upon the passengers.

RAILWAY COLLISION AT VICTORIA STATION, MANCHESTER.—On the 9th ult., an accident of a very unusual character occurred under the Ducie Bridge, near the Victoria Station, which might have been attended with the most serious results, but which eventuated fortunately in no further mischief than the damage of three carriages. It is customary for each train leaving Manchester for Yorkshire to be followed by a pilot engine, to assist in propelling it up the inclines, and the pilot engine usually leaves the station from the line

of rails on the opposite side to the platform, whilst the train starts from the near side. Before the train gets under the bridge, it commences to cross the rails to the extreme left, and then the pilot-engine moves forward and joins up to it. On that afternoon the 3.50 London and North-Western train for Leeds left the station at the usual time, and proceeded to cross to the opposite side. Before it had got completely across, however, the pilot engine came up, and ran into the centre of it. The engine struck three of the carriages, in which there were passengers, and the force of the concussion caused it to rebound, and threw it off the rails. This was a most fortunate circumstance, after all, for had not the engine been thrown off the rails, it would have proceeded on its way clean through the train, instead of running to the left as it did, merely tearing up the road. It was thought at first that some of the passengers might have been injured, but on examination it was found that the sides of three of the carriages were slightly broken, and that the passengers had received no further damage than the fright which the collision caused. The train was brought back to the station, new carriages were substituted for those broken, and in twenty-five minutes afterwards the passengers again proceeded on their journey.

AN ACCIDENT of a fatal character took place on the 9th ult., on the works of the railway running through Bewdley. It appears that some men were at work blasting in a cutting when the accidents took place. In the explosion of one of the blasts a portion of rock struck a man on the head, felling him to the ground. He was taken up, and it was found that life was extinct. Another man was also struck by a piece of rock, and is said to have received dangerous injuries.

A SERIOUS ACCIDENT occurred on the 10th ult., to the Leeds and Bangor mail train, which joins a portion of the London and North-Western mail train at Crewe. On that morning the Leeds and Bangor train left that station for Holyhead two hours and forty minutes. It is stated, later than its regular time. It proceeded safely until it reached "Ty Croes," within a few miles of Holyhead, when the tire of one of the wheels gave way, owing to which the post-office carriage, and two other carriages, were thrown off the rails, dragged about a mile, when they were overturned into a ditch. The engine and guard's van went on for some distance before the driver could stop the train; and on going back it was discovered that one of the passenger carriages was smashed to pieces, and the other carriages, including the post-office van, were complete wrecks. Most fortunately the clerks and sorters had left the van at Bangor, where their duty is completed, only the mail guard being left had therin, and his escape, under the circumstances, was very wonderful; he was, however, thrown out on the line before the van turned over, and sustained severe injuries to his head and back, from the rebound of the carriage and the fall on the rails. There was only one passenger besides the train guard, and both, happily, escaped without injury. Had there been many passengers by this mail the result must have been very calamitous. Fragments of wheels, axles, &c., were scattered over the line, which was cleared during the day, and the traffic resumed.

AN ACCIDENT of a truly terrible character occurred to the Irish night mail due at Holyhead about 3.30 a.m. on the morning of the 10th ult. The train had just left the Tubular Bridge and entered on the Isle of Anglesey, when the tire of one of the wheels flew off, causing a carriage to leave the line, becoming a complete wreck, and bringing the train to a stand still. The scene that then ensued is described by those who were so fortunate as to escape injury as appalling; the cries of females and the groans of the wounded passengers were heartrending in the extreme. Several persons were taken from the debris of the broken carriage, evidently seriously injured, the post-office clerks especially being severely bruised. Two of the injured passengers died the same night. The mails due at Kingston early on Thursday morning did not arrive till late in the day.

ON THE EVENING of the 10th ult., about eight o'clock, a terrific explosion of gas took place at the Colney Hatch Station on the Great Northern Railway, which nearly killed the guard of a train then waiting at the station, and completely blew the roof off the station. The accident is attributed to the action of the frost on the iron pipes.

A FATAL ACCIDENT occurred, at eleven o'clock on the night of the 14th ult., in the yard of the Lancashire and Yorkshire Railway, Great Howard-street, Liverpool, whereby the fireman lost his life, and the engine-driver was seriously injured. The fireman on an engine was engaged at the time the accident occurred in shunting some waggons off a high level platform in the yard, between Great Howard-street and Faltoun-street, when the platform gave way, burying the engine, tender, and break van in the debris. The fireman was caught between the engine and tender, and instantly killed.

AN ACCIDENT of a fearful character, attended with loss of life, happened a short distance from Lincoln on the evening of the 14th ult., on the Manchester, Sheffield, and Lincolnshire Railway. It appears that the down train from Hull, due at Lincoln at 7.45 p.m., entered the Greetwell cutting a little after its time. On reaching the Lincoln end, the tire of the engine wheel came off, and the engine slipped off the rails, rushed over the other line of rails, and ran into the bank—at this place several feet high—and toppled over, the cleaner falling off, the lower part of his body being underneath the engine. The driver was pitched up on a hedge, his head being severely cut. The tender was also upset, but it laid in such a position as to form an arch, under which the stoker crept, by which means he escaped uninjured. Next to the tender were three vans laden with fish, all of which were thrown over, the contents being strewn about in all directions. After the fish vans were the passenger carriages, in the first of which were several passengers. On either side of the seat nearest the engine two men were sitting, father and son. The passengers were first made aware that something was amiss on hearing a loud bump. The father at once jumped over the seat in front of him, and no sooner had he done so than the middle of the end of the carriage was forced in with a terrific crash, the son having both his legs severely injured. The father escaped with a few bruises, but there can be no doubt that had he not taken the precaution to move from his position, he would have been crushed to death. None of the other passengers were injured. Both lines of rails were completely blocked up by the shattered carriages, and consequently the guard at once proceeded to Lincoln, the majority of the passengers accompanying him. On the station master being made acquainted with the particulars of the accident, he at once sent for a surgeon, who, with two assistants, proceeded to the scene of the melancholy occurrence. On reaching the spot the terrible nature of the accident was at once apparent. Fish and portions of the broken vans were lying about in all directions, the "smash" being as complete as could well be imagined. The poor cleaner was found under the engine, the whole weight of which was upon the lower part of his body; and, upon examination, it was found that his head and shoulders had been frightfully scalded—there can be no doubt, however, that his sufferings were only momentary. It was found impossible to extricate the body, there not being means at hand to raise the ponderous engine. The injured man, with the remainder of the passengers, were then brought to London, and the wounds of the driver were dressed in the refreshment-room of the station, the other being, in the meantime, removed to the Lion Hotel, where the injuries received have been found to be much more serious than were first anticipated. On examination it was found that the outer side of the left leg, from the hip to the knee, was bare to the bone, and that the splinters of wood penetrated completely through the underneath portion of the leg, the whole of the muscles being severely lacerated and much bruised, and the principal artery torn. The leg was also swollen considerably. A consultation of the medical officers of the Lincoln County Hospital was, therefore, called, and it was found necessary to amputate the leg from the thigh. The operation reduced the sufferer so much that no hopes are entertained. It was also found that the father had received severe injuries, although not of so serious a nature as his son.

ON THE 14th ult. the Deputy Coroner for the western division of Middlesex, and the jury empanelled to investigate the cause which led to the extraordinary accident which

took place on the line of the London and North-Western Railway, on the London side of the Primrose-hill tunnel, on the night of Friday the 4th ult., resulting in the death of Mr. William Michael George Kelly, a first-class passenger, and injury to other persons, re-assembled in one of the committee rooms of Euston Station for the purpose of further prosecuting their inquiry. The extraordinary character of the accident had the effect of producing a powerful array of scientific and legal gentlemen. The Deputy Coroner having briefly summed up, the room was cleared of strangers, and after a deliberation, the jury returned the following verdict:—"That on the 4th day of January, William Michael George Kelly was found dead beneath a certain carriage on the London and North-Western Railway, and that his death was occasioned by the effects of the fracture of his skull, and other injuries produced by his having become crushed beneath the carriage aforesaid accidentally and by misfortune." To which they appended the following remarks:—"The jury sitting to inquire concerning the death of Mr. M. G. Kelly, earnestly recommend the London and North-Western Railway Company to remedy on their line, as speedily as practicable, the defect which is represented to have been the cause of the accident, and which resulted in the death of the gentleman aforesaid." The proceedings, which lasted the whole day, terminated at six p.m.

ON THE MORNING of the 14th ult., a very serious accident occurred at a spot about midway between the Harrow and Pinner stations on the London and North Western Railway, by which one passenger sustained such severe injuries to his left leg that in the afternoon he was compelled to undergo the painful ordeal of amputation; and three other persons were more or less seriously injured—one, an elderly lady, having one of her arms broken. The train to which the accident happened was what is called the "limited mail." This train leaves Glasgow at 5.53 p.m., and is due at the Euston station at 4.37 a.m. on the following morning; but yesterday, instead of arriving in London at its proper time, it was telegraphed as having just passed Wolverhampton exactly at the moment when it should have been at Camden-town, where it stops for the collection of tickets. It was therefore about an hour and a half late, and it appears that after leaving Bletchley, which is the last stopping station, and which should be reached at 3.28, but was not until about 5 o'clock, the train sped upon its way at a very rapid pace indeed, and continued to do so until it arrived at the spot indicated above, when suddenly the passengers heard a crash, followed by a singular shaking of the carriages. The travellers became much alarmed, which was considerably increased when shrieks and cries were heard above the noise of the train, the speed of which had become gradually slackened. At length the carriages were brought to a stand, when, as described by a passenger in the train, the excitement was intense. This was about six o'clock, when it was pitch dark and extremely cold. The passengers—fortunately limited in number—rushed from the carriages in a state of great alarm, and proceeded to investigate the nature of the accident which had happened. It soon became apparent that the results were of a serious character. Shrieks and moans emanated from a composite carriage which was lying on its side, minus, it is said, the whole of its wheels, and having been dragged in its dilapidated state for upwards of two hundred yards. As speedily as possible the inmates were extricated. A gentleman was not much injured, nor was a young female, but an old lady had her arm broken, and was besides much shaken and otherwise injured. The carriage was completely crushed, and how its inmates escaped with life is considered almost a miracle. Before the train was stopped they were hurled backwards and forwards with every motion, and consequently were much bruised, and placed in great mental agony. As soon as the full extent of the accident had been ascertained, it was deemed advisable to send the gentleman to London immediately. He was placed in a break van, and at once conveyed to the Euston Hotel, near the station. After careful deliberation, it was found impossible to avert amputation of the left leg, which operation was afterwards accomplished, the patient evincing considerable courage and endurance. With regard to the cause of the accident, it is supposed to have originated through the breaking of the axle of a carriage, which threw some of the other vehicles off the line. The "post office" had to be left for some time on the spot where the accident happened, and it was not until another engine arrived from London that it could be brought up. The letters were therefore considerably late, the post-office tender being several hours behind time.

ACCIDENT ON THE GREAT WESTERN RAILWAY.—An accident happened to the down express train on the Great Western Railway on the morning of the 14th ult., which at one time threatened to be attended with consequences of a very serious nature. The train quitted the Paddington Station for its westward journey at the usual hour, 9.15 a.m., and proceeded as far as Twyford without interruption or mishap of any kind. When near that station the axle of the third of the second-class carriages attached to the train (which happened to be one of those which belong to the Bristol and Exeter Company) suddenly broke, and the tires of the wheel flying off smashed all the grease-boxes of the carriage to pieces. The carriage, in which were several passengers, was thrown off the rail by the jerk, causing, as may be supposed, considerable consternation amongst its inmates. After it had dragged some half a mile the engine-driver succeeded in pulling up the train, and the engaged voyagers were released, and the injured carriage removed from the train. None of the passengers were severely injured, but the train was delayed an hour and a half before it reached Bristol.

A FATAL ACCIDENT occurred on the London and North-Western Railway on the morning of the 15th ult., near Boxmoor Station. The down Irish mail train, leaving the Euston Station at 7.25 a.m., and which does not stop till it reaches Rugby at 9.25, was proceeding at its usual rate of speed as it neared the Boxmoor Station, when the engine-driver, who was keeping a good look out ahead, perceived several plate-layers at work upon the line. He at once gave the customary danger signal; but the men appeared to be unconscious of the approach of the train until the engine was upon them. The buffer struck one of the men, and inflicted upon him such fearful injuries that his death must have been instantaneous. His mangled remains were picked up after the train had passed, and conveyed by his fellow-workmen to an adjoining public-house, to await the holding of the coroner's inquest. Another of the plate-layers was also struck by the engine, and so severely injured that it is doubtful whether he will recover. There seems to be no blame attributable to the driver of the train, who, on his arrival at Rugby, was corroborated in his statement that he sounded the danger signal in sufficient time for the men to have got clear of the line.

ON THE 17th ult. a serious collision took place on the Chester and Warrington Railway between a goods and passenger train. It appears that a goods train left Chester for Manchester, as usual, in the morning, and proceeded along until it got through the Frodsham tunnel; but when it got into the cutting between the tunnel and Frodsham Station, the rails were so slippery, owing to the thaw, that it could only get along with great difficulty. The passenger train, which left Chester at 9.5 a.m., proceeded along at its usual speed, and, on arriving at the entrance of the tunnel, was signalled to go on. It accordingly passed through the tunnel at the usual speed. The dampness of the morning caused the steam from the goods train engine to hang more than is common in the tunnel, and also in the deep cutting between it and the Frodsham Station, so that the driver of the passenger train could not see more than a few yards ahead, and the consequence was that he overtook the goods train and ran right into it, knocking the buffers of his engine completely off. The passengers in the latter train were much shaken. One lady received a confused forehead and a blow on her knee; but we believe there was no more serious casualty than this. All the passengers were able to proceed. The damage to the goods and passenger carriages was slight.

ON THE 18th ult., an accident happened to the down parliamentary train upon the Eastern Counties Railway, when near Ardleigh station, about midway between Colchester and Manningtree. The train, on approaching the above station, slackened speed,

for the purpose of enabling the passengers to alight, when the connecting rod of the engine broke asunder, and the end of it nearest the driving-wheel was driven with great violence into the soil. The engine was thrown off the line, but it maintained its equilibrium, and most fortunately all parties escaped without personal injury, though it is almost needless to say they were much frightened. The passengers were forwarded by the mail train, which arrived shortly afterwards, and continued their journey to Ipswich, and after an hour or two the engine was again on the metals, the traffic of the line not having been entirely stopped.

RAILWAY ACCIDENT IN THE NORTH.—On the night of the 19th ult., a special train from Sunderland ran into a luggage train every shortly after passing Brockly Whins station. The latter train was knocked off the line by the force of the concussion. The occupants of the special train—many of them being ladies—were of course a good deal alarmed, but fortunately the only inconvenience which they suffered arose from fright and detention in the snow from 11.0 until 1.0 a.m.

ON THE 23rd. ULT., on the Liverpool branch of the London and North-Western Railway, the mail train which leaves Liverpool at eleven o'clock was ascending a steep incline between Huyton and Raichill, ran into a goods train which was being propelled up before it. The company's guard and the mail guard were both much injured. The engine behind the goods train was also damaged, as was that which ran into it.

A COLLISION ON THE MIDLAND RAILWAY occurred on the morning of the 24th ult. The Derby 7.55 train was in the station-yard at Nottingham, and whilst the tickets were being collected from the passengers, the 8.5 train from Leicester was seen to be approaching on the same line. A signal was immediately given to stop the train, but owing to the slippery state of the rails it was found impossible to check the train, and the latter ran into the Derby train. The shock was considerable, the Derby train being carried more than a dozen yards by the force of the concussion; but, with the exception of a few bruises to the passengers, nothing serious occurred.

ON THE MORNING OF THE 25th ULT., a number of luggage trucks got detached from the engine on the Lancashire and Yorkshire Railway, and, notwithstanding the efforts of the guard to stop them, with the break, the whole came with a tremendous velocity forward to Leeds, several being eventually thrown into the Great Northern goods yard, Wellington-street, a depth of about forty feet. The vans were all broken to pieces. The guard leapt from the van, and thus saved his life.

DEATHS FROM STEAMBOATS AND RAILROADS IN AMERICA.—The statistics of the number of persons killed and wounded in America by steamboat accidents during the past year, show,—killed, 242; wounded, 146. In 1859 the numbers were, killed, 597; wounded, 134. During the past eight years the lives lost by steamboat accidents, notwithstanding those which occurred at sea, were, killed, 30,001; wounded, 1000; and the total number of accidents for that period was 242. A similar return of railway accidents shows—For 1860, killed, 57; wounded, 315; in 1859, killed, 129; wounded, 411. These figures do not include individual accidents caused by the carelessness of travellers. An additional table of deaths and injuries by accidents to railroad trains for the past eight years shows as follows:—Accidents, 977; killed, 1166; wounded, 3926.

BOILER EXPLOSIONS.

OF BOILER EXPLOSIONS, it is estimated that, in the United States, there is an average of one daily. They occur in every section of the land, at sea, on rivers, in basements, garrets, scattering death and destruction in all directions. An American paper remarks, on this subject—"If so much dangerous carelessness is discovered where periodical examinations are made, what is likely to be the condition of boilers where examinations are unfrequent and superficial?"

MANCHESTER STEAM BOILER ASSURANCE COMPANY.—The Chief Engineer of this Company has issued his monthly statement, showing that during the month of December last 259 boilers have been accepted by the board, and proposals received for the insurance of 192 additional boilers. The total number of boilers for which proposals have been received during the year 1860 is 1851, of which 1636 have been accepted. The number of boilers inspected in the month of December is 616, of which 10 have been internally, and 43 thoroughly examined. The principal defects noticed were as follows—viz., corrosion of plates, or angle iron, 20; fractures of ditto, 15; safety valves out of order, 33; water-gauges ditto, 15.

THE HUDDERSFIELD BOILER ASSOCIATION, it is stated, is about to be wound-up, and the members are individually recommended to join the Steam Boiler Assurance Company, which offers inspection with the additional advantage of allowance in case of accident.

DOCKS, HARBOURS, CANALS, &c.

FACILITY IN COAL LADING.—As a proof that the accommodation afforded for the shipment of coals in the Sunderland South Dock cannot be equalled in any other port of the north, we may state that the Ryhope sloop steamer entered between five and six o'clock on a Friday evening, and sailed on the first following tide, five o'clock next morning, having in less than twelve hours taken in 850 tons of coals. She made a quick voyage to London, had good despatch there, and reached Sunderland again on a Wednesday, received another cargo of coals of the same quantity, and sailed on Thursday, having twice left the docks, and made a voyage to London, in five days.

WATER SUPPLY.

ARTESIAN WELLS IN ALGERIA.—The number of these wells sunk up to the present day in Oued Rir and in Hodna amounts to 31, yielding about 33,631 pints of water per minute. The wells sunk in the district of Toungourt are 19 in number, they yield 2790 pints of water per minute. We have, therefore, for the whole province of Constantine a total debit of 36,421 pints of water from the 50 wells, or 52,446,249 pints in the 24 hours. All these sinkings have been made with three sizes of perforators only; the average depths of the wells of Oued Rir and Hodna, is some 90 to 100 yards; those of Toungourt about 60 yards. The expenses entailed by these works have amounted in the 4 years, 1857—60, to 262,676 francs; or, if we deduct the value of the perforators (120,000 francs), to 142,676 francs. The average expense of each well is therefore about 2953 fr.

GAS SUPPLY.

GAS ON STEAMERS.—A new method of lighting the Soud Steamboats, United States, from large reservoirs of gas, to be placed on the upper-deck, the latter being fitted at either terminus of the route, is soon to be put in operation. Four iron reservoirs, capable of holding 1800 feet of gas, are to be secured on the hurricane deck, and it is thought that in case of emergency these buoyant tanks may prove very efficient as life-preservers.

THE WATER-GAS LIGHTING at the Girard House, Philadelphia, U.S., it appears by the Philadelphia papers, is likely to be abandoned, a legal demand having been made on the gas trustees to have the house supplied with coal gas from the City works. Some of the pipes were found to be so filled with tar that it was found necessary to clean them out before the City gas could be introduced. It has been said that water-gas contained no condensable products.

GAS PURIFYING.—A firm in Wakefield propose to remove ammonia from the gas by causing it to pass through and amongst dry, or, by preference, damp cocoa-nut fibre, which is found to have a great absorbing power for that substance.

MINES, METALLURGY, &c.

IN BOILER PLATES there is a difference in quality which is fearful enough to contemplate; but when we consider that "cheap" plates are made, which, instead of carrying

60,000 lbs. to the inch, will break into pieces under a heavy blow from a hand hammer, and that there are thousands of engine owners who are willing to risk everything to save first cost, who invariably get the "cheapest" (lowest priced) work; and, moreover, that too many boiler makers do, and are capable of using anything which the purchaser will call iron, we cannot but wonder that explosions are not more frequent.

IMPORTANT DISCOVERY OF COAL.—About eighteen months since, Mr. Thomas Rees, of Swansea, South Wales, purchased some corporation property, intending it for agricultural purposes. About six or seven weeks ago the idea of trying for coal or other valuable mineral suggested itself. A 25m. vein of valuable fire-clay was discovered in about a fortnight; and in a few days later the workmen came upon a 5ft. seam of level. The coal is highly bituminous, possessing superior coke-producing qualities, and is the nearest to Swansea of any coal yet discovered in the locality, not being more than a quarter of a mile from the town. Mr. Rees has secured the right to all minerals found upon the farm, which extends over some 600 acres.

THE PASSIVITY OF IRON.—When a piece of iron is placed in ordinary nitric acid, it is violently attacked; if it be withdrawn, the acid adhering to the surface continues its action. If we wait until the adherent acid is saturated, and then again plunge the iron into nitric acid, the coating of rust which has been formed becomes of dead white colour, and is no longer attacked by the acid—it has, indeed, become *passive*. If the iron be rubbed it becomes attackable again, and may be brought back into the passive state in the same manner as before.

IODINE IN THE ATMOSPHERE.—It is insisted by French chemists that there is iodine in the atmosphere. M. Chatin says he has found it in the rain water of Pisa, Florence, and Lucca, as at Paris. Further, he adds he has found it in five samples of distilled water, and three specimens of potassium from the best laboratories; and he believes that it may be found in all potassiums and most rain waters. M. Chatin cannot succeed in isolating the iodine, but he is none the less certain of its presence.

APPLIED CHEMISTRY.

ON NITRO-PRUSSIDE OF SODIUM AS A RE-AGENT.—The colour of the compound formed through the action of nitro-prusside of sodium on alkaline sulphurets depends upon the nature of the alkali employed, and upon the proportion of sulphuret and alkali in solution. Ammonia always produces a purple colour; but if soda or potash are present in great excess, the colour formed is red instead of purple. Organic compounds of sulphur which are not easily decomposed by alkalis seem, therefore, to give a different reaction to that of inorganic compounds. Bisulphuret of carbon, or oil of mustard, for instance, when digested with caustic soda, at a common temperature, gave not a purple but a deep red colour with nitro-prusside of sodium. When boiled with soda, these compounds form sulphuret of soda more freely, and then give the purple colour with the re-agent. Albumen may be boiled for some time before the first reaction changes into the second one. Mercaptan proves the alkaline properties of its radical by forming the red colour without the addition of soda, which, when added, however, intensifies it. A solution of sulphur in an organic medium, such as benzine, or oil of turpentine, when acted upon by soda, at a common temperature, does not give the red but the purple colour—the former appearing only when soda was added in great excess. The action of nitro-prusside of sodium on alkaline sulphurets is much stronger and more rapid than that of metallic salts. It was tried to determine the quantity of an alkaline sulphuret in solution by volumetric analysis, by precipitating it with alkaline solution of metallic oxides [of lead or zinc], testing from time to time for the presence of the sulphuret with nitro-prusside of sodium. It was then found that the alkaline sulphuret was thus indicated, even in the presence of an excess of the metallic solution. For indicating the presence of alkalis, nitro-prusside of sodium is superior to the best litmus paper, and for indicating alkaline earths, it can be used when litmus fails to give a reaction. For the purpose of testing for these substances, sulphuretted hydrogen is passed for a short time through the solution previous to its being mixed with a few drops of the re agent. A solution of 1 part of dry carbonate of soda in 20,000 parts of water thus assumes a colour dark enough to be diluted with three times its own volume of water without becoming indistinct. The reaction, however, is the slower in appearing, and the quicker in disappearing in proportion as the solution is the more dilute. If, therefore, 1 part of carbonate of soda be dissolved in more than 40,000 parts of water, the reaction becomes indistinct. The limit of a distinct reaction for litmus paper seems to be, 1 part of carbonate of soda in 15,000 parts of water. Tincture of litmus is equally sensitive as nitro-prusside of sodium for indicating alkalis, but not for earths. One part of carbonate of lime in 20,000 parts of water containing carbonic acid is distinctly indicated through sulphuretted hydrogen and nitro-prusside of sodium; whereas litmus, in such instance, indicates the carbonic acid only. Baccic salts, such as the borate or phosphate of soda, give, as might be presumed, a strong reaction with nitro-prusside of sodium. Organic bases act in an analogous manner with regard to both re-agents. Those which are not indicated by litmus seem not to be capable of forming a sulphuret reacting upon nitro-prusside of sodium. Nicotine is indicated by both re-agents; quinine, cinchonia, and aniline are not. The sulphuret of nicotine, when evaporated at a common temperature over sulphuric acid, is split into sulphuretted hydrogen, which goes off, and the base, which remains in solution. An alcoholic solution of aniline, when submitted to the reaction, assumes a green colour of a very transitory nature. In conclusion, it may be remarked, that nitro-prusside of sodium is capable of acting as a powerful oxidizing agent. It forms brown resinous substances when acting upon volatile oils.

ON MONOHYDRATED SULPHURIC ACID.—Recently, at a meeting of the Royal Society of Edinburgh, attention was drawn to the researches of Marignac on sulphuric acid. This chemist always found too much water in monohydrated sulphuric acid, and fixed its specific gravity, as Beneau and others have recently done, from 1'842 to 1'845. It is well known, indeed, that this hydrate loses anhydrous acid when distilled or boiled, and the object of the present communication is to ascertain the exact conditions under which this loss takes place, as this knowledge is of importance in a practical point of view. The author occasionally found, on distilling, and afterwards heating oil of vitriol, that acid of the specific gravity of 1'848 was obtained, but at other times the specific gravity was as low as 1'842. To explain this difference, the following experiments were made:—

1. Sulphuric acid, having a specific gravity of 1'848, and a per centage of anhydrids of 81'62 by the alkalimeter, was put in a retort, burned in hot sand, and distilled. The distillate had a specific gravity of 1'840, and a per centage strength of 80'12. It had, therefore, lost by distillation $\frac{1}{2}$ per cent. of anhydrids.

2. The weak acid got by the last experiment was heated for half-an-hour to 550° Fahr., and after cooling gave an acid of 1'84798 specific gravity, and strength of 81'615 anhydrids.

3. A portion of this acid now restored to its full strength and specific gravity, was violently boiled for two hours. On testing the acid, on cooling, it was reduced in strength to 80'01 of anhydrids, and to a specific gravity of 1'838.

4. The weak acid obtained in the last experiment was kept for one hour at 550° Fahr. On cooling it had increased to 81'62 per cent. of anhydrids, and the specific gravity was 1'84792.

As a general result of these experiments, it follows that the old specific gravity of 1'848 is more correct than that given by Marignac and Beneau; that there is a true monohydrate of sulphuric acid which loses anhydride near its boiling point, but not below 550°. The latter temperature should not be exceeded in the concentration of oil of vitriol.

LIST OF NEW PATENTS.

APPLICATIONS FOR PATENTS AND PROTECTIONS ALLOWED.

- Dated September 6, 1860.*
2150. C. A. Schneider, 9, Albany-street, Regent's Park—Manufacturing letters, numerals, designs, and ornaments to be attached to glass.
- Dated October 13, 1860.*
2491. M. Strang, Glasgow—Manufacture of lubricating oil.
- Dated October 15, 1860.*
2508. G. F. Goble and F. S. Hemming, London—Machinery for crushing quartz and other substances.
- Dated October 22, 1860.*
2572. A. Dietz, New York, United States—Method of treating skins and hides during or after the process of tanning or finishing them.
- Dated October 26, 1860.*
2614. R. Tiernan, Liverpool—Infants' and invalids' feeding bottles.
- Dated November 2, 1860.*
2690. W. E. Newton, 66, Chancery-lane—An improved press for compressing substances for packing in the form of bales, or for other purposes.
- Dated November 9, 1860.*
2748. J. P. Fittère, Castelnau Magnoac, Hautes Pyrénées—Portable sewing machines.
- Dated November 15, 1860.*
2810. G. Gill, 37, Francis-street, Newington—Steam rams and ships of war.
- Dated November 16, 1860.*
2812. J. C. M. Beziat, 51, Rue de Malte, Paris—Apparatus employed for permitting, stopping, and regulating the passage of steam.
2820. T. Welton, 29, New Compton-street, Soho, and E. H. C. Moncton, Parthenon Club, 16, Regent-street—Application of electricity to the human body for the relief of pain.
- Dated November 17, 1860.*
2828. J. H. Radcliffe, King-street, Oldham, Lancashire—Lubricating or oiling vessels.
2831. A. L. Leveque, Paris—Apparatus for carburating or naphthalizing lighting gas.
- Dated November 19, 1860.*
2836. H. A. Jowett, Sawley, Derbyshire—Heating ovens for the manufacture of pottery and porcelain by means of gas.
- Dated November 20, 1860.*
2844. F. Palling, Escher-street, Lambeth—Fountain pens.
- Dated November 22, 1860.*
2864. R. A. Brooman, 166, Fleet-street—Apparatus for communicating continuous rotary motion from manual power.
- Dated November 23, 1860.*
2870. W. Manwaring, Banbury, Oxfordshire—Gearing of mowing and other light portable machines.
2872. J. Coupe, Blackburn—Power looms for weaving.
2874. B. Beniowski, Bow-street—Manufacture of types and cases to be used therewith.
- Dated November 26, 1860.*
2892. J. W. Hadwen, Kebroyd Mills, Halifax—Treatment of silk waste, waste silk, or silken fibre.
- Dated November 27, 1860.*
2908. W. S. Wood, Chislehurst, Kent—Apparatus for curing smoky chimnies.
- Dated November 28, 1860.*
2916. J. Robb, Aberdeen, North Britain—Gas Stoves.
2920. H. Grafton, 80, Chancery-lane—Application of machinery to the cultivation of land.
- Dated November 29, 1860.*
2928. Sir J. T. Bethune, 39, Rue de l'Echiquier, Paris—Production of motive power by application of the dead weight of liquids.
2935. J. A. Fanshawe, and J. A. Jaques, Tottenham—Brushes and other scrubbing surfaces.
- Dated November 30, 1860.*
2938. J. Fry, Wrotham, near Sevenoaks, Kent—Mills for crushing and grinding grain.
- Dated December 1, 1860.*
2945. R. Dawbarn, Wisbeach—Apparatus for stopping holes in elastic tubes or pipes.
2947. A. Jackson, Liverpool—Generating steam as adapted to a certain arrangement or construction of steam engines for transmitting motive power.
2952. J. Ronald, Liverpool—Machinery for the spinning of hemp.
2954. T. Shedden, Ardgartan House, Argyll, North Britain—Ammunition for fire-arms.
- Dated December 3, 1860.*
2960. W. Galloway and J. Galloway, Manchester—Steam boilers.
2962. W. R. Barker, Chapel-street, Belgrave-square—Bottles for medicines and poisons.

2964. J. Lowden and R. Buckley, Royton, Lancashire—Carding engines.
2966. J. T. Carter and J. Austen, Sydenham, Kent—Method of roughing horse shoes.
2968. T. Whitehead, Holbeck, Leeds—Machinery for combing wool, hair, and other fibrous substances.
- Dated December 4, 1860.*
2972. B. Greenwood, 5, Southfield-square, Manningham—Manufacture of brooms.
2974. E. Jaques, Droydsden, near Manchester—Apparatus applicable to rifled or other muskets.
2976. R. Griffiths, 69, Mornington-road, Hampstead-road—Screw propeller blades.
2978. J. H. Johnson, 47, Lincoln's-inn-fields—Folding racks for airing and drying clothes.
2980. C. S. Duncan, Hereford-road North, Bayswater—Construction of electric telegraph cables or ropes.
- Dated December 5, 1860.*
2982. C. W. Siemens, 3, Great George-street, Westminster—Fluid meters.
2984. G. Hallett, 52, Broadwall, Lambeth—Coating iron and other ships' bottoms.
2986. B. Gorrill, Birmingham—Gilding tools for embossing ornaments on leather.
- Dated December 6, 1860.*
2989. H. Jordan, Liverpool—Construction of ships or other vessels.
2990. J. F. Pratt, Oxford-street—Instruments for receiving and transmitting sound.
2991. R. A. Glass, Greenwich—Apparatus for preserving electric telegraph cables and wires prior to their being laid.
2992. M. Deavin, Rotherhithe—Apparatus applicable as a fire escape.
2993. T. Melodew, Oldham, and C. W. Kesselmeier, Manchester, and J. M. Worrall, Salford—Treatment of velvets, velvetines, and other fabrics, on which there are floated wet threads to be cut.
2994. J. Bellamy, Wednesfield, near Wolverhampton—Traps for taking rats, birds, rabbits, and other animals.
- Dated December 7, 1860.*
2995. J. Musgrave, Bolton-le-Moors—Apparatus for regulating the discharge of water from steam pipes.
2996. J. C. Hadden, 14, Bessborough-gardens, Pimlico—Manufacture of cannon.
2997. P. Guerin Cluny, department of Saone-et-Loire, France—Hydraulic press.
2999. F. H. Edwards, Newcastle-upon-Tyne—Air engines.
3000. S. Holman, Lewisham—Machinery for communicating motion to and transmitting motion from reciprocating rods.
3001. J. B. Turtle, 93, Minories—Means of communicating signals.
3002. W. Clark, 53, Chancery-lane—Machinery for planing or cutting wood.
3003. J. J. Wheble, Reading—Manufacture of artificial stone for building purposes.
3004. B. G. George, Hatton Garden—Mounting of tablets or show bills.
3005. T. Foxall, Princes-street, Fitzroy-square—Canteen for containing refreshments for soldiers or travellers.
3006. W. Morris and J. Radford, Oldbury, Worcestershire—Compositions to be employed in the manufacture of fire bricks.
- Dated December 8, 1860.*
3007. J. H. Cary, St. James's Factory, Norwich—Hammer rails.
3008. G. Davies, 1, Searle-street, Lincoln's-inn—Construction of steam boilers.
3009. J. Robson, junior, North Shields—Mineral-oil lamps.
3010. R. Muschet, Coleford, Gloucestershire—Manufacture of an alloy or alloys of titanium and iron.
3011. T. Roberts, Holborn—Construction of ships and floating batteries.
3012. M. Jones, Royal Mint—Apparatus for preparing the edges of discs of metal for coin.
3013. A. Wheeler, Banner Cross, Sheffield—Manufacture of railway carriages, trucks, engines, and other vehicles.
3014. J. H. Johnson, 47, Lincoln's-inn-fields—Apparatus for applying capsules to bottles.
3015. B. Hockin, Limehouse—Mode of fitting and working furnaces.
3016. L. Simon, Nottingham—Heated air engines.
3017. D. Annan, 8, Albert-terrace, Bow—Furnaces and fire bars.
3018. J. Durrant, 63, Warren-street, Fitzroy-square—Chimney pots.
3019. W. E. Newton, 66, Chancery-lane—Machinery for making bricks.
- Dated December 10, 1860.*
3020. A. Granger, 308, High Holborn—Manufacture of collars, cuffs, shirt fronts, and articles of a like nature.
3021. A. J. Fillette, 42, Rue Amelot, Paris—Presses for copying, stamping, and embossing.
3022. T. Peake, Derby—Method of locking or skidding the wheels of vehicles for the purpose of arresting the progress thereof.
3023. J. A. Barde, Paris—Apparatus for producing and purifying lighting gas.

3024. W. Clark, 53, Chancery-lane—Photographic apparatus.
3025. J. Young and C. Cairns, Glasgow—Making moulds for casting.
3026. R. A. Brooman, 166, Fleet-street—Implements for digging and breaking up the soil.
3027. R. Davidson, London-street—Apparatuses for drying and heating.
3028. R. H. Hughes, Hatton-garden—Apparatus for supplying fresh air to mines.
3029. R. Hudson, Adwalton, near Leeds—Apparatus for the generation of steam.
3030. R. Muschet, Coleford, Gloucester—Manufacture of an alloy or alloys of titanium and iron.
3032. J. H. Johnson, 47, Lincoln's-inn-fields—Electric apparatus for striking the hours on bells.
- Dated December 11, 1860.*
3033. J. Townsend, Glasgow—Obtaining animal charcoal.
3034. A. J. Canu, Paris, Rue Lafitte, numero 42—An improved pulverising and bruising machine.
3035. C. Stevens, 1b, Welbeck-street, Cavendish-square—An impermeable anti-sulphuric coating for leather.
3036. R. A. Ford and W. A. Paige, 33, Poultry—Shirts.
3038. J. Townsend and J. Walker, Glasgow—Treating bye products arising in the manufacture of soda and potash for the obtainment of antichlores and other useful products.
3040. G. C. Wallich, 17, Campden Hill-road, Kensington—Apparatus for taking deep sea soundings.
3041. H. Tucker, 11, Queen-square, Bloomsbury—Bedsteads.
3043. J. Pym, 4, Lawrence Pountney-hill—Railway sleepers.
- Dated December 12, 1860.*
3042. T. Massey, 4, Birch-lane—Sounding machines.
3044. J. Steart, 5, St. James'-road, Blue Anchor-road, Bermondsey—Treating skins for the manufacture of leather.
3045. R. Muschet, Coleford—Manufacture of cast-steel.
3046. H. Hall, Stack Steads, Lancashire—Apparatus for spinning and doubling fibrous materials.
3047. A. F. Jaloureau, Paris—Processes for holding, protecting, and insulating subterraneous telegraphic wires.
3048. H. Newey, Birmingham—Manufacture of certain parts of umbrellas and parasols.
3049. J. Scott, Sunderland—Reefing and furling sails.
3050. C. P. Moody, Corton Denham, Somersetshire—Construction of gates.
3052. S. T. Cornish, Beaumont-square, Mile-end—Construction of ships for the purpose of rendering them shot and shell proof.
3053. G. Richardson, Meekleburg-square, and E. D. Chattaway, Bromley—Apparatus for enabling guards and engine drivers of railway trains to communicate with one another.
3054. A. Kyle, Binghill, Aberdeen—Apparatus for propelling ships or vessels or boats.
3055. S. C. Lister, and J. Warburton, Manningham, Yorkshire—Spinning and doubling.
3056. R. Pitt, Newark Foundry, Bath, and S. F. Cox, Bristol—Apparatus employed in the manufacture of leather.
- Dated December 13, 1860.*
3057. J. Casson, Wellington-street, Woolwich—Machine for dressing dried fruits.
3058. J. G. Reynolds, 33, Wharf-road, City-road—Covering the surfaces of smoking pipes and other articles to obtain ornamental and useful effects.
3059. R. Henson, 113a, Strand—Eye glass and spectacle frames.
3060. G. F. Chantrell, Liverpool—Draught generator.
3061. C. Neville, Great Dover-road—Washing apparatus.
3062. T. West, Warwick—Apparatus for slicing, shredding, and pulping turnips and other roots.
3063. S. Pitts, 14, Catherine-street, Strand—Billiard tables.
3064. W. Clark, 53, Chancery-lane—Manufacture of gas.
3065. G. O. Vandenberg, New York—Breech pieces of breech-loading cannon.
3066. F. J. Evans, Gas Works, Horseferry-road, Westminster, and G. F. Evans, Gas Works, Brentford—Manufacture of illuminating gas.
3067. J. R. Cooper, Birmingham—Breech-loading firearms.
3068. E. Jones, Manchester—Improvements in rifling small arms and ordnance.
3069. C. Reeves, Birmingham—Breech-loading firearms.
3070. R. Muschet, Coleford, Gloucestershire—Manufacture of iron and steel.
3071. J. Chubb, St. Paul's Churchyard, and E. Hunter, Wolverhampton—Locks.
3072. W. D. Allen, Laitfield-house, Norfolk-road, Sheffield—Bearings in which the axles of locomotive engines and carriages revolve.
3073. J. A. Mello, Welbeck-street, Cavendish-square—Stereoscopic slides.
- Dated December 14, 1860.*
3074. J. Fenton, Queen-street, Lincoln's-inn—Securing the wearing tyres on wheels.
3075. J. Jackson, 21, West-grove, St. John's-hill, Battersea—Lamps.
3076. J. P. Baragwanath, 23, Castle-street, Falcon-square—Hydraulic punching apparatus.
3077. W. Clark, 53, Chancery-lane—Signalling from one part of a railway train to another.
3078. W. E. Newton, 66, Chancery-lane—Pavement for streets.

3079. W. E. Newton, 66, Chancery-lane—Cutting and rounding corks and bungs.

3081. H. Batchelor, Newport, Monmouthshire—Construction of models of ships, boats, or other vessels.

Dated December 15, 1860.

3083. N. C. Barton, of Her Majesty's Himalaya, a Lieutenant in the Royal Navy—An improved scaling ladder for military, naval, and other purposes.

3094. G. Davies, 1, Serle-street, Lincoln's-inn—Building bridges, ships, or other structures of iron or other metal.

3085. G. Davies, 1, Serle-street, Lincoln's-inn—Rolling and corrugating plates of metal.

3086. G. Davies, 1, Serle-street, Lincoln's-inn—Iron or other metal beams.

3087. J. G. Williams, Blaenavon—Extracting inflammable and other noxious gases from coal and other mines.

3088. A. Kinder, Great George-street, Westminster—Apparatus for cutting wood.

3089. A. Prince, 4, Trafalgar-square, Charing-cross—Steam engines.

Dated December 17, 1860.

3092. N. C. Szerelemey, 6, Park-terrace, Brixton-road—Apparatus for purifying oils and varnishes.

3094. J. Morison, Paisley, Renfrew—Spinning or twisting.

3095. R. Bodmer, 2, Thavies-inn, Holborn—Apparatus for preventing or modifying the effects of collisions on railways.

3097. A. and E. M. Denny, Waterford, Ireland—Apparatus for singeing the carcasses of dead pigs.

3098. A. Eddington, Springfield, Chelmsford—Draining ploughs.

3101. T. W. Walker, Poole—Manufacture of ornamental bricks.

3102. E. L. Morel, Paris—Ships' rudders.

Dated December 18, 1860.

3103. F. Silas, 4, Leicester-place, Leicester-square—An aerostatic signal apparatus, to be called "Semasphere."

3106. T. L. Preston and T. Lloyd, Birmingham—Metallic bedsteads, chairs, and couches.

3107. R. W. MacArthur, 38, Chapel-street, Belgrave-square—Hulling and dressing rice and other grain.

3109. R. A. Brooman, 166, Fleet-street—Spears for cutting sheet metal and other materials.

3110. C. L. Hancock, Pentonville—Improved fuel.

3111. J. Paterson, Wood-street, London—An improved necktie.

3112. J. Cbesterman, Sheffield—Door and gate springs.

Dated December 19, 1860.

3114. W. Spence, 50, Chancery-lane—Apparatus for closing doors and keeping them closed.

3115. J. W. McGauley, Pimlico—Apparatus for preventing collisions on railways.

3116. R. J. Cole and M. Scarvell, Pembroke-gardens, Bayswater—Ornamenting or illuminating glass for decorative purposes.

3117. O. Blake, Southampton-street, Strand—Manufacture of plate glass.

3118. J. Brinkley, Carrickfergus, Antrim—Furnaces for consuming or preventing the emission of smoke.

3119. M. Henry, 84, Fleet-street—Manufacture of colours applicable for various uses in arts and manufactures.

3120. R. A. Brooman, 166, Fleet-street—Irons for ironing.

3121. R. A. Brooman, 166, Fleet-street—Treatment of caoutchouc, and the employment of a product obtained thereby, for lubricating and coating bodies.

3122. J. Gilmore, Ramsgate—Method of raising water in baths.

3123. C. W. Robinson and J. Robinson, jun., Mount Kennet, Limerick—Singeing the hairs off pigs after being killed.

Dated December 20, 1860.

3124. W. Mossman, 1, Cleveland-terrace, Downham-road—Bonnets from papered cloth.

3126. J. West, Kingstown, near Dublin—Apparatus for drying grain.

3127. J. Clarke the younger, Longford-street, Rochdale—Warping.

3129. G. Hadfield, Carlisle—Preparation of wood for conversion into casks or barrels.

3130. F. Schwann, Gresham-street—Dressing and stiffening fabrics and yarns.

3131. F. B. Baker, Sherwood-street, Nottingham—Manufacture of lace.

3132. G. B. Rennie, Holland-street, Blackfriars—Examining or repairing ships and other vessels.

3133. E. Whitehall, Nottingham—Machinery for embroidering on lace and other fabrics.

3134. E. Southam, Manchester—Apparatus for retarding and stopping railway trains.

Dated December 21, 1860.

3135. W. Price, 4, Wood-street, Lambeth—Manufacture of articles called shives, tits, bungs, and corks, or other conical bodies.

3137. H. Loveridge, Wolverhampton—Meat screens.

3138. J. Chatterton, Highbury-terrace, and W. Smith, Pownall-road, Dalston—Manufacture of electric telegraph cables.

3139. T. Moore, 33, Regent-circus, Piccadilly—Navigating ships.

3140. J. Rigby, Suffolk-street, Dublin, and J. Needham, Piccadilly—Breech-loading fire-arms and cartridges.

3141. T. Hunt, Crewe, Cheshire—Apparatus for supplying steam generators with water.

3142. J. H. Johnson, 47, Lincoln's-inn-fields—Magneto-electric machines.

3143. J. Glover, Danes'-inn, Strand—Mounting and affixing opaque letters or numerals on a translucent ground.

Dated December 22, 1860.

3144. C. Peters, Coventry—Manufacture of ribbons and other fabrics.

Dated December 22, 1860.

3145. J. Johnston, 1, Pond-street, Hampstead—Apparatus for withdrawing corks from bottles.

3146. E. Cook and J. Stokes, Birmingham—Sacking and joints for bedsteads.

3147. H. Hughes, "Falcon Works," Loughborough—Wheels for carts, waggon, and carriages.

3148. G. Sandys, Aldersgate-street—Apparatus for conveying signals between railway stations and other distant points.

3149. T. B. Marshall, 41, Queen-street, Cheapside—Wind musical instruments.

3150. W. Clark, 53, Chancery-lane—Manufacture of colouring matters.

3152. A. V. Newton, 66, Chancery-lane—Watches.

Dated December 24, 1860.

3155. C. H. Adams, Birmingham, and C. Whitehouse, Wolverhampton—Manufacture of frying-pans.

3156. W. E. Newton, 66, Chancery-lane—An improved archers' bow and bow gun-toy.

3157. J. A. Fanshawe, Tottenham, and J. A. Jaques, same place—Manufacture of fabrics with rubbing or friction surfaces.

3158. J. L. Norton, 38, Belle Sauvage-yard, Ludgate-hill—Apparatus for drying wool and other fibres.

3159. J. L. Norton, 38, Belle Sauvage Yard, Ludgate Hill—Apparatus for drying wheat, barley, and other grain and seeds.

Dated December 26, 1860.

3161. F. Puls, 25, Francis-terrace, Hackney-wick—Obtaining products from coal, gas tar, gas pitch, coal tar, asphalt, resin, and other bituminous and resinous substances.

3162. C. Lizars, 36, Rue Lafayette, Paris—Gas meters.

3163. S. Desborough, Noble-street, and S. Middleton, Essex-street, Strand—Manufacture of boots and shoes.

3164. J. H. Johnson, 47, Lincoln's Inn Fields—Instruments for assisting the sense of hearing.

3165. J. H. Johnson, 47, Lincoln's-inn-fields—Smoothing irons.

Dated December 27, 1860.

3166. W. Darby, Birmingham—Constructing and working stamps for cutting and shaping metals.

3167. F. Sage, 11, Hatton-garden—Brackets for carrying trays, shelves, glass cases, &c., in windows and glass cases.

3168. W. Parry, High-street, Deptford—Manufacture of chimney pots and articles made from clay.

3169. J. T. G. Stone, Gopsall-street, Hoxton—Covering steel used for ladies' crinolines.

3170. R. A. Brooman, 166, Fleet-street—Axle boxes and naves of wheels.

3171. T. V. Guerrée, L'Aigle, France—Apparatus for moving waggons or carriages on railways.

3172. W. Hill, 103, Milton-street, Sheffield, and H. Barber, 60, Thomas-street, Sheffield—Manufacture of spring knife scales and knife handles.

3173. R. and H. Parnall, Bishopsgate-street-without—Means for promoting warmth and comfort in railway and other travelling.

3174. W. R. Mulley, 10, Lockyer-street, Plymouth—Apparatus for steering ships or vessels.

3175. G. Dodman, and W. Bellhouse, Rochdale—Thoists.

3176. A. V. Newton, 66, Chancery-lane—bedsteads.

Dated December 28, 1860.

3177. G. H. Birkbeck, 34, Southampton-buildings, Chancery-lane—Furnaces for consuming smoke.

3179. C. Binks, Parliament-street, Westminster—Manufacturing certain gases applicable in generating heat and light.

3180. I. Dimock, Florence, Massachusetts, United States—Machinery for cleaning, sorting according to size, and doubling silk and other threads.

3181. C. Pallu, Nogent-sur-Marne, near Paris—Apparatus and process for producing photographic pictures without working in dark rooms.

3183. A. V. Newton, 66, Chancery-lane—Breech-loading fire-arms.

3184. J. S. Russell, Great George-street, Westminster—Constructing and arming ships and vessels.

Dated December, 29, 1860.

3186. W. Clark, 53, Chancery-lane—An improved tissue, fabric, or structure.

3187. E. R. Burnham, Liverpool—Machinery for stamping, shaping, or forming certain kinds of goods, manufactured of india rubber.

3189. H. W. Viner, Penzance, Cornwall—Grand pianofortes.

3191. G. Davies, 1, Serle-street, Lincoln's Inn—Printing calicoes and other fabrics.

Dated December 31, 1860.

3194. J. Midgley, J. Sugden, and W. Clapham, all of Keighley—Trombones.

3195. W. Eades, Birmingham—Screw-wrench.

3196. W. Clissold, Dnabridge—An improved construction of clutch for driving gear.

Dated January 1, 1861.

1. E. Tomlinson, Manchester—Apparatus for facilitating the placing of cop tubes on the spindles of spinning machines.

2. G. Cook, Croydon—Watch movement.

3. M. Henry, 84, Fleet-street—Breaks applicable to carriages used on railways.

4. M. Henry, 84, Fleet-street—An improved slide valve.

5. P. Campbell, India-terrace, West India-road, and T. A. Kendal, Cowley-street, St. George's-in-the-East—Sails and apparatus used therewith.

Dated January 2, 1861.

8. J. F. Belfield, Primley-hill, Paignton—Reaping and mowing machines.

9. W. Morgan, Liverpool—Certain metals for the manufacture of coating, swill, and similar baskets.

10. J. Taylor and M. B. Cooper, Liverpool—Rotary engines.

11. E. B. West, 24, Longford-terrace—Processes of making worts and washes in brewing and distilling.

Dated January 3, 1861.

12. P. A. Moore, Penge—Improved feet for levelling clocks and other articles.

13. C. Stevens, 1b, Welbeck-street, Cavendish-square—Apparatus for stopping run-away horses.

14. W. C. Fuller, 2, Bucklersbury, J. A. Jaques, Tottenham, and J. A. Fanshawe, same place—Adaptation of india rubber and analogous gums, and compounds thereof, to valves, packing and other parts of steam engines.

15. W. Heywood, Ellesmere-street Works, Manchester—Machinery for grinding rollers and cylinders covered with card teeth.

17. A. V. Newton, 66, Chancery-lane—Air or gas engines.

Dated January 4, 1861.

21. J. Wright, 42, Bridge-street, Blackfriars—Machines for forming the heels of boots and shoes.

23. W. H. Hore, Liverpool—Apparatus for measuring and registering the lengths of woollen, flax, cotton and other fabrics applicable to registering lengths.

25. A. Fairbairn, Leeds—Forging press or hammer.

Dated January 5, 1861.

27. L. C. E. Vial, Paris—Manufacture of colouring matters and pigments from coal oil.

29. J. Watson, Glasgow, and C. F. Halle, Manchester—Spinning or twisting fibrous materials.

31. W. E. Gedge, 11, Wellington-street, Strand—Motive power.

33. J. Sugden, J. Midgley, and W. Clapham, all of Keighley—covered rollers used in machinery for preparing and spinning fibrous materials.

35. J. Conlong, Belfast, Ireland—Machines or engines employed for carding cotton, silk, flax, wool, and other fibrous substances.

37. J. I. Grylls, Murton-street, Sunderland—Anchors.

Dated January 7, 1861.

41. W. Taylor, Nursling, near Southampton—A portable horticultural and arboricultural fruit, flower, and plant protector.

43. W. Bagley and W. Mincher, both of Birmingham—Coating metals and alloys of metals.

Dated January 8, 1861.

45. W. Clark, 53, Chancery-lane—Filters.

47. H. Hirsch, Berlin—Insulating the conducting wires used for telegraphic purposes.

49. G. Hallett, 52, Broadway, Lambeth, and J. Stenhouse, 17, Rodney-street, Pentonville—Manufacture of pigments for coating surfaces.

Dated January 9, 1861.

51. E. Lord, Todmorden, and R. Whitaker, same place—Machinery for preparing, spinning, and doubling cotton and other fibrous substances.

57. C. S. Dawson, Thames Ditton—Rotary engines.

59. W. E. Gedge, 11, Wellington-street, Strand—An improved buckle.

INVENTIONS WITH COMPLETE SPECIFICATIONS FILED.

28. P. Courtais and F. Jammet, both of Port Vendres, Pyrénées Orientales—Manufacturing of paper and pasteboard waterman.

69. B. B. Hawse, Vermont, United States—Machine either for supporting clothes or other articles to be dried.

93. J. Gibbs, Brentford—Constructing submerged works.

3105. C. Stevens, 1b, Welbeck-street, Cavendish-square—An improved cooking stove.

3153. W. J. Gibbons, Birmingham—Stereoscopes and their cases.

3193. B. N. de Buffon, 23, Rue des Saints Pères, Paris—Apparatus for clarifying and purifying water and other liquids.

IRON FLOATING DOCK

DESIGNED BY

MR G. B. RENNIE, M. I. C. E.

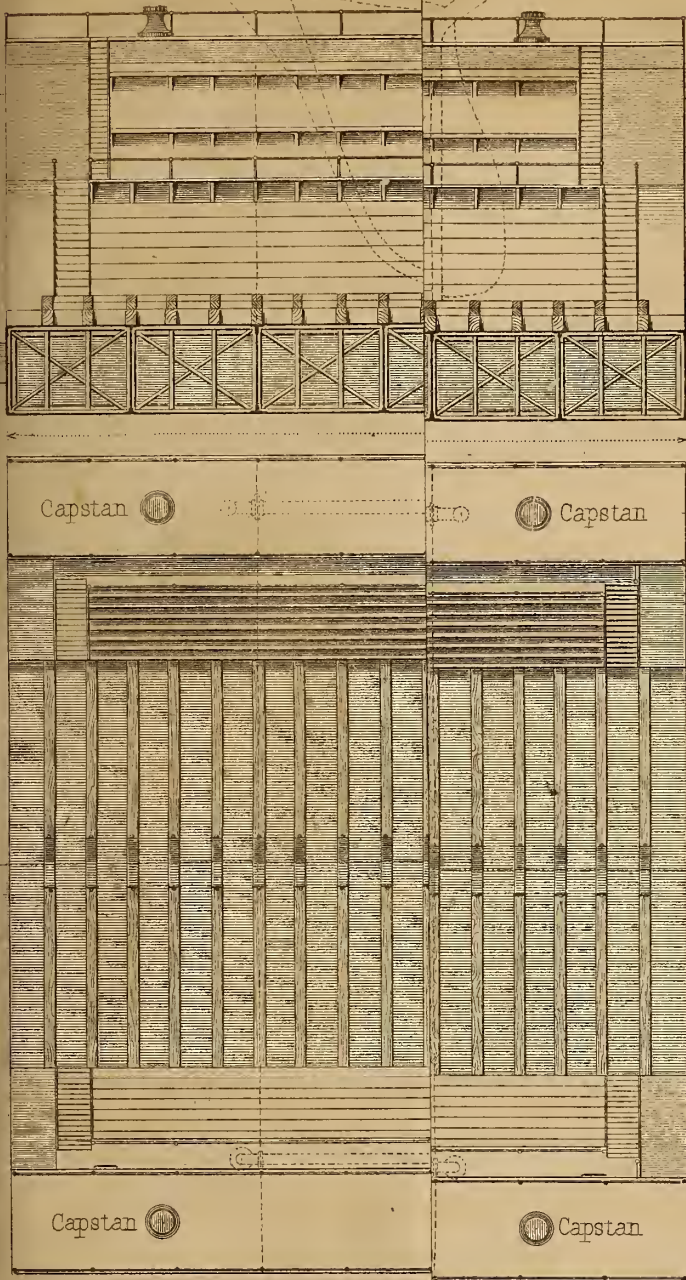

FIG. 4. TRANSVERSE SECTION

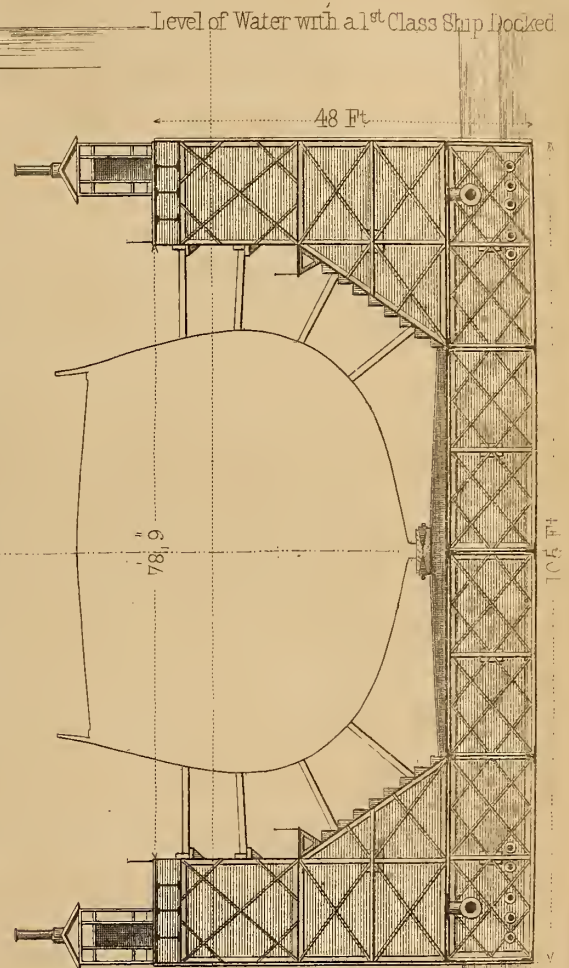

FIG. 5. HALF

END ELEVATION.

Level of Water when ready to receive a 1st Class Ship

Level of Water when fully afloat

FIG. 1. LONGITUDINAL SECTION

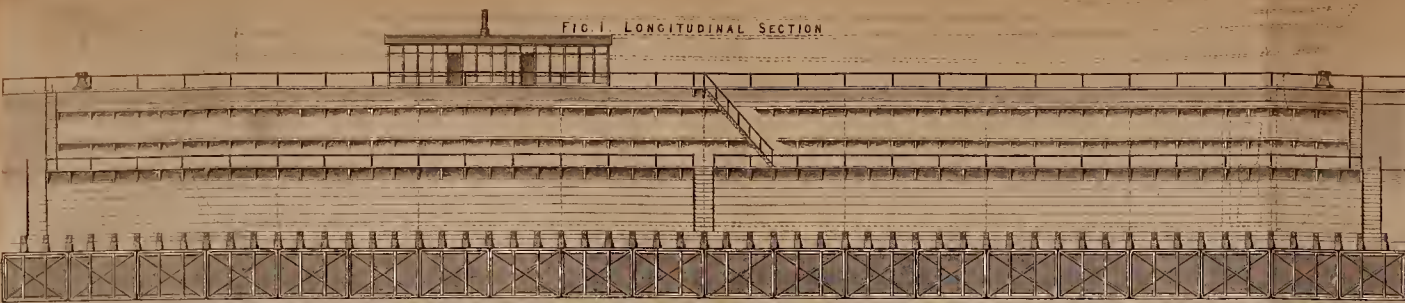

320 Ft

Engine House and Work Shop

FIG. 2. PLAN



Engine House Work Shop

FIG. 3. SECTION

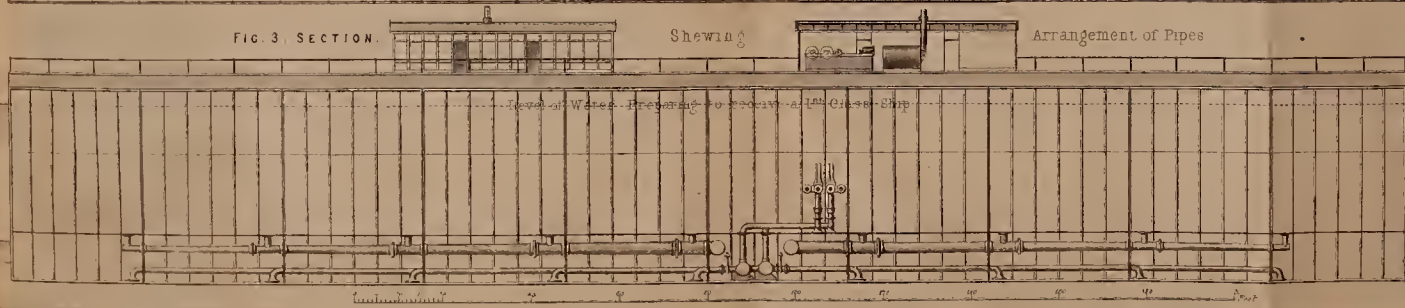

Shewing

Arrangement of Pipes

Level of Water - Prepared to receive a 14 1/2 ft. Glass Ship

IRON FLOATING DOCK

DESIGNED BY

MR G. B. RENNIE, M. I. C. E.

FIG. 4. TRANSVERSE SECTION

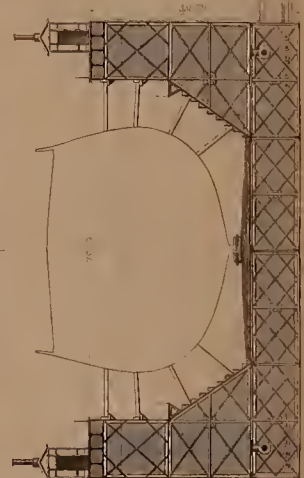
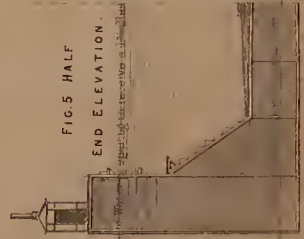

FIG. 5. HALF END ELEVATION.



==

3079.

3081.

3083

3084

3085

3086

3087

3088

3089

3092

3094

3095

3097

3098

3101

3102

3103

3106

3107

3108

3110

3111

3112

3114

3114

3114

3114

3114

3114

3112

3112

3112

3112

3112

3112

3112

3112

3112

3112

3112

3112

3112

3112

3112

3112

3112

3112

3112

3112

3112

3112

THE ARTIZAN.

No. 219.—VOL. 19.—MARCH 1, 1861.

PRACTICAL PAPERS FOR PRACTICAL MEN.—No. I.

ON THE STRENGTH OF GIRDERS.

The object of the present paper is to call the attention of practical engineers to some considerable errors in formulæ calculated by certain mathematical authors. In the following remarks we shall not confine ourselves entirely to algebraical notations, but shall test the practical value of our results by arithmetical calculations. We will first detail the erroneous formulæ above referred to. The case under consideration is that of a flanged girder, the web of which is neglected in the calculation of horizontal strain.

Let d = the depth of the girder,
 d' = the depth within the flanges, } all in inches.
 b = breadth of the flanges,
 s = the greatest strain per square inch direct.
 h = the distance of the outer fibres from the neutral axis of the girder = $\frac{1}{2}d$,
 M = moment of resistance.
 m = moment of strain.
 W = total load.

Then, for reasons well known,

$$m = \frac{W}{4} \cdot \text{span of girder, for a central load,}$$

$$m = \frac{W}{8} \cdot \text{span of girder, for an uniformly distributed load,}$$

$$M = \frac{s}{h} \cdot \frac{b}{12} \{d^3 - d'^3\},$$

which is the expression to be simplified.

The method adopted to effect this is, when the material is thin and the girder deep, to assume

$$\frac{d'}{d} = 1, \text{ or } d' = d;$$

in the works to which we refer this substitution is immediately made, wherefore,

$$M = \frac{s}{d} \cdot \frac{b}{12} \{d^3 - d'^3\},$$

$$= \frac{1}{6} \cdot s \cdot b \cdot \{d^2 - d'^2\},$$

$$= \frac{1}{6} \cdot s \cdot b \cdot \{d - d'\} \cdot \{d + d'\},$$

$$\text{but } b \{d - d'\} = \text{area of flanges} = k,$$

$$\therefore M = \frac{1}{6} \cdot s \cdot k \cdot \{d + d'\} = \frac{1}{3} \cdot s \cdot k \cdot d.$$

We will now show the method we adopt as being more correct than the above, commencing with

$$M = \frac{s}{d} \cdot \frac{b}{12} \{d^3 - d'^3\},$$

we first replace the area by k , then

$$M = \frac{1}{6d} \cdot s \cdot k \cdot \{d^2 + dd' + d'^2\};$$

then, making $d = d'$, we obtain

$$M = \frac{1}{2} \cdot s \cdot k \cdot d,$$

or half as much again as by the above formula.

The first expression involves a considerable error in deficiency of the truth, the latter a slight error in excess; and it now remains for us to ascertain the amount of error in each formula.

We might obtain an algebraical equation for the ratio of the error to the strength, but think it will be more satisfactory to our readers if we restrict ourselves to plain figures.

We will select a beam whose depth is 7 ft. 6 in., the flanges being 1½ in. thick and 2 ft. wide; then putting these dimensions into inches, and taking 4 tons per inch as the greatest direct strain, we have $s = 4$, $d = 90$, $d' = 87$, $b = 24$, $h = 45$; therefore,

$$M = \frac{s}{h} \cdot \frac{b}{12} \{d^3 - d'^3\} = \frac{4}{45} \cdot \frac{24}{12} \{729000 - 658503\}$$

$$= 12,532.8$$

$$\text{and } M = \frac{1}{3} \cdot s \cdot k \cdot d = \frac{1}{3} \cdot 4 \cdot 72 \cdot 90$$

$$= 8,640$$

the error of the latter being = 3892.8,

a deficiency of nearly half the strength, calculated by this formula, or nearly one-third of the true strength.

We will now apply the new formula to the same case, thus:—

$$M = \frac{1}{2} \cdot s \cdot k \cdot d = \frac{1}{2} \cdot 4 \cdot 72 \cdot 90$$

$$= 12,960$$

the error in this case being = 427.2,

an excess of something under one-thirtieth of the calculated value by our formula, or less than one-twenty-ninth of the true value of the strength of the girder.

If we take that view of the case which is least favourable to our formula, we find that the error involved by it is about one-tenth of that involved by the old formula; and taking the other view of the case, we have an error of only one-fifteenth the amount of that produced by the use of the old formula.

We will now consider the utility of these expressions when applied to small girders.

Let $d = 15$, $d' = 13$, $b = 8$, $s = 4$, then

$$M = \frac{s}{h} \cdot \frac{b}{12} \cdot \{d^3 - d'^3\} = \frac{4}{7.5} \cdot \frac{8}{12} \{3375 - 2197\}$$

$$= 416.71$$

$$M = \frac{1}{3} \cdot s \cdot k \cdot d = \frac{1}{3} \cdot 4 \cdot 16 \cdot 15 = 320,$$

$$M = \frac{1}{2} \cdot s \cdot k \cdot d = \frac{1}{2} \cdot 4 \cdot 16 \cdot 15 = 480.$$

The error in the case of the old formula is about one-fourth of the true value, or one-third of that by this formula; and that involved by the new formula about one-eighth of the calculated, or one-seventh of the true value.

Before taking leave of the subject we will explain the manner in which this new formula may be conveniently applied in practice.

In the method we have adopted, the results obtained are the same as those which we arrive at by considering any small rectangular flange or element as a single layer of fibres, and obtaining its moment by multiplying its direct resistance by its distance from the neutral axis.

Results yet more accurate may be obtained by measuring the depth of the beam from the centre of gravity of one flange to that of the other, instead of taking the extreme depth, as we have done in our examples; and it is evident that if the flange be thin we shall thus obtain results very closely approximating to the truth, for if we take the extreme depth of the girder, our results are in excess of the truth, but they are in deficiency if we measure the depth between the flanges. Because the moment of resistance of the girder must be equal to the moment of strain if the forces be in equilibrium, or,

$$M = m,$$

$$\therefore \frac{Wl}{4} = \frac{1}{2} \cdot s \cdot k \cdot d$$

when the load is in the centre l , being the span of the girder. If l is in feet, d must be in feet also; but if l is in inches, d must be in inches.

$$\frac{Wl}{2s.d} = k.$$

Hence, if we know the span and depth of the girder, the weight to be supported, and the strain per square inch on the metal, we can immediately by the above formula find the sectional area of the two flanges requisite to satisfy the necessities of the case.

If the flanges are equal, the area of each will be,

$$\frac{Wl}{4s.d} = k;$$

and if the load is uniformly distributed—

$$\frac{Wl}{8s.d} = k$$

will give the area of each flange.

If the dimensions are given, and we wish to ascertain the load which the girder will bear, we have for a centre load,

$$W = \frac{4s.k.d}{l}$$

and for a distributed load

$$W = \frac{8s.k.d}{l}$$

We will take a practical case as an example of the application of the above formula. Suppose that two girders are required to support a single line of railway, the span being 80ft., and the depth of the girders 7ft. 6in. The load will be about 1.75 tons per foot run, and the greatest direct strain upon the metal 4 tons per square inch. Then

$$W = 1.75 \times 80 = 140, \text{ and}$$

$$k = \frac{Wl}{8s.d} = \frac{140 \times 80}{8 \times 4 \times 7.5} = 46.6 \text{ square inches.}$$

This result is the area of the top flanges; and as there are two girders, the area of each flange of each girder will be,

$$= 23\frac{1}{2}$$

G. B. RENNIE'S PATENT FLOATING PONTOON, OR DOCK.

(Illustrated by Plate No. 188.)

Our Plate represents five views of a novel description of Iron Floating Pontoon, or Dock, designed and patented by Mr. G. B. Rennie, of the firm of Messrs. G. Rennie and Sons, who has devoted a considerable amount of time and attention to this subject, with a view to determine as to the form and arrangement of a Floating Dock best adapted to meet the frequent requirements for their use; and Mr. Rennie appears to have been very successful in hitting upon an arrangement well calculated to accomplish this. The Floating Dock we now represent is being constructed by Messrs. G. Rennie and Sons, for the Spanish Government.

One of the chief features in these Floating Docks is, that fixed or moveable ends, gates, or caissons, for the purpose of enclosing the vessel, are dispensed with, as the water in which the vessel has floated, and which water would, in the case of using gates, &c., have to be pumped out, or otherwise discharged, will, in Mr. Rennie's Dock, leave the vessel during the time the dock and vessel are being raised; the floatative power of the bottom, or basement, when the water is forced or drawn out by pumps, or otherwise discharged, being made sufficiently ample to support the weight of the structure, and also of the largest and heaviest vessel which can be placed within it.

The method of constructing such Floating Pontoons, or Docks, is as follows:—An iron water-tight hollow platform is formed of rectangular shape, and of suitable depth and capacity; this hollow platform is divided, by means of longitudinal and transverse bulkheads, into any convenient number of chambers. On the upper part, and at each side of the hollow platform, a hollow iron water-tight longitudinal chamber is carried from end to end, and having an internal capacity sufficiently great, that with the upper part divided from the lower, by means of a horizontal division or floor, sufficient floatative, balancing, and supporting power is obtained to enable the greatest degree of immersion of the whole structure to be effected. The lower part of each of these hollow longitudinal chambers is provided with valves, for the admission and exit of water, according as the Dock is lowered or raised. The hollow walls or longitudinal chambers, as well as the hasement or hollow platform, being divided into separate chambers by water-tight bulkheads, the water may be let out from, or

admitted to several of the chambers, to enable the base of the Dock to be in a horizontal or level position.

The whole structure is strengthened internally by means of diagonal bracings, trellis work, and truss girders of iron. On the top of the hollow side walls steam-power is placed for the purpose of working the pumps, or discharging the water from the basement portion of the Dock, and for performing various other works in connection therewith; such as raising, lowering, hauling, or removing materials, and other similar operations. Sheds, or small workshops, or similar erections are also (as shown in the engraving) provided. The various sluice cocks are so arranged that they may be readily worked from the Deck formed on the top of each of the hollow side walls; and either one, or any greater number of chambers, may be filled or discharged at pleasure, and thus any irregularity in the disposition of the load, or any inequality in the stowage of the weights of the ship which is being docked, may be compensated for.

On reference to our Plate, Fig. 1 is a central longitudinal sectional elevation of one of these floating docks, and adapted for docking a first-class ship (shown in position by dotted lines). Fig. 2 is the top plan, the series of pipes and valves in the hasement portion of the structure being in this case shown by dotted lines. Fig. 3 is a longitudinal sectional elevation, taken through the hasement portion, and the centre of one of the longitudinal side chambers. Fig. 4 is a transverse section taken through the centre of the length of the dock. Fig. 5 is a half-end elevational view.

The mode of docking a vessel in this Floating Pontoon or Dock is as follows:—Supposing the basement, or hollow platform, as well as the lower part of the side walls, to contain no water, and the valves in communication with the water in which the structure floats be closed, the structure would then have an immersion depending on the amount of water displaced by its weight alone.

The valves in communication with the water are now opened, and the dock allowed to sink to the depth necessary, and according to the class of vessel to be worked; the valves are then closed, the vessel hauled into the dock and shored up, the engines and pumps set to work, and the water pumped out of the different chambers of the basement or hollow platform, so as to preserve its level, and raise the dock and vessel until the keel of the vessel is well out of the water, the structure being so arranged that the top, or floor, of the basement portion shall be a convenient height above the level of the water when floating and supporting the largest and heaviest vessel for which it is adapted.

Should, however, the valves in communication with the outside water be kept open by accident or neglect, the dock would always in such cases be prevented from sinking by means of the permanent or floating air chambers on the upper part of the hollow walls, which are constructed so that their floating power is sufficient for this purpose.

The dimensions of the dock now being constructed by Messrs. George Rennie & Sons, at their Ship-building Yard, Greenwich, are as follows:—Length over all, 320ft.; breadth, 105ft.; height outside, 48ft.; height inside, 36ft. 6in. The pumps are to be worked with two pair of engines of 24 horse-power each pair.

The time required to raise a first-class vessel is about 30 minutes. The floatative power of the hasement or lifting chambers is about 11,000 tons.

This dock is so constructed as to enable the docking of a vessel to resemble as nearly as possible the mode of doing so in graving docks; and from its form, which is of great strength, it is not liable to injure or strain the heaviest vessel in being docked. Mr. G. B. Rennie has also a plan for a float or basin which may be used in connection with the above, by which and the works of construction on shore, vessels may with great facility and without risk of being strained or injured, be placed high and dry at any convenient level, in such position as will enable them to be readily examined and repaired without involving the exclusive use of the Pontoon or Floating Dock during the time such repairs are in progress. Of this invention we hope to give an illustration and description, and details of the mode of employing it for docking vessels, in a future number.

CONVERSION OF CAST IRON INTO STEEL.*

BY THE BARON DE ROSTAING.

Amongst the valuable information contained in the *Lettres sur Sheffield*, which were published in the last numbers of the *Presse Scientifique des deux Mondes*, I noticed with peculiar interest the explanations given *de visu* by M. Gustave Maurice, on Mr. Bessemer's process.

This publication hastened my determination to break a long-continued silence, which it was my desire to keep still longer, before speaking of my own experiments, which have been the object of my pursuits for these last two years or more; namely, converting cast iron into steel, a question which has been growing more and more important since the last commercial treaty took place between France and England.

* A communication to the *Cercle de la Presse Scientifique*, Paris, on their meeting, 3rd December, 1860.

When I first communicated to the *Cercle de la Presse Scientifique*, October, 1858, my method of pulverizing metals by submitting them when in fusion to the action of centrifugal force, I then confined myself to the mere description of the mechanical parts, setting forth the double physical and chemical action which resulted from this mode of division, and producing samples obtained by operating on lead, in order to show what extreme degree of tenuity can be attained with a metal which is not readily pulverised.

At that time I left to chemists, and others skilful in the art, the care of deducing consequences from this economical mode of division, which is applicable to great quantities, thus leaving them the liberty of introducing that into trade practices, which was hitherto kept closed to them. Save a short mention of the facility, procured by pulverization, for converting a metal into oxydes or salts, I did not then describe any important application of my process to metallurgy. This I merely presented in a summary way, thus:—"Division, by centrifugal force, of all solid bodies, which can be brought previously by fusion into a liquid state."

Meeting, however, on my way, an agent of so great a power, applicable in sundry cases and to many bodies which I never dreamed of before, I still had in view, from the commencement, a special subject, to the fostering of which I had been early prepared by a whole year's residence at a high furnace foundry (in Vienne, Dauphiné, France), which, at the time alluded to, belonged to the great company's iron works, La Loire and l'Isere (France).

My object was exactly the same as has been pursued since by Mr. Bessemer; and if, in 1858, I remained silent, it was, perhaps, because I foresaw the attacks which await all innovators, and I did not feel disposed to undergo the first onset.

M. Gustave Maurice, in his *Lettres sur Sheffield*, informed us how trying a time this first onset was for Mr. Bessemer; but as the latter still went on well, in spite of his opponents, it is now likely that less prejudice may be encountered in following the same track.

Let the oldest methods of working iron be gone into, and the most improved modern processes be examined; let the theories upon which patents stand ever since the existence of patent laws be explored, yet you will see that this short word "AIR," or, more correctly, "OXYGEN," will ever stand up before you as being the only agent.

It is by the oxygen of the air, as supplied by blast engines, or the oxygen resulting from the decomposition of water when this is injected on cast iron, brought to a white heat, that the whole ancient and modern system of metallurgy has ever been worked, or is actually working; it is by opposing, at a high temperature, carburet of iron, or cast iron, to bodies more or less saturated with oxygen—such as the oxides of iron, the chlorates, or azotates of potash, &c.; or by injecting, as Mr. Bessemer does, by powerful mechanical means, films of air, not only on the surface of, but through a mass of melted iron, that innovators are trying now-a-days to eliminate carbon by an addition of oxygen.

This idea is old—as old as iron; and I am quite convinced that the idea which has many times been taken up, and thrown aside again, carried on energetically, will ultimately succeed.

I will now describe by what means different from those of my predecessors I have succeeded in supplying cast iron with the amount of oxygen necessary to its decarburization to the degree required for its conversion into steel.

My process comprises three different operations:—

1st. Division or pulverisation of a portion of the cast iron, an operation producing simultaneously the combustion of a portion of the carbon, and a commencing oxydation of the cast iron thus divided. Such division or pulverisation is obtained by means of centrifugal force.

2ndly. Completion of oxydation by the *wet process*, or by moistening the pulverised cast iron obtained in the first operation, and leaving it afterwards exposed for a certain time to the action of atmospheric air.

3rdly. Melting in a crucible, or rather, a reverberatory furnace, a mixture of cast iron, in varying quantities, in the state it comes out from the blast furnace, or cupola, with that portion of the cast iron which has been undergoing the previous operations above described.

In my first operation (division) it will be easily perceived that my method of proceeding is exactly opposite to Mr. Bessemer's. He injects air into the metal, whilst I project metal into the air.

In my next operation, I use for obtaining oxydation, and also the purification of cast iron, a treatment unknown until this day, and which I will describe hereafter.

In my third operation—*melting*—I somewhat followed, though with different preparations, the process of M. Mushat, who, so far back as 1800, took out a patent in England for obtaining steel from cast iron shavings, which were re-melted and mixed together with oxydized ones.

In the same manner, but with new means and considerable modifications, I somewhat follow the processes of M. Breant, Uchatins and others, who always used oxydized cast iron, natural oxides and ores as decarburating agents.

I do not pretend to claim the direct transformation of cast iron into

steel, but only wish it to be understood that my method of proceeding will prove more practical and economical, independently of the operator's skill, than any other method or process heretofore employed or described.

When I examine Mr. Bessemer's process, I find that our starting point is the same; we both take cast iron in the liquid state, as it is issuing from the furnace (first or second fusion); but the immense difference of penetrability of the mediums we have both to encounter, sufficiently shows, what advantages are likely to result from my process in avoiding the immense waste of power which occurs in Mr. Bessemer's.

His process requires powerful blast engines for the purpose of raising, by air pressure, the layer of metal placed above the slags on the conduit pipe during the injecting process. Such layers must be higher and heavier in proportion to the mass of cast iron that is to be acted upon, and in this respect he must necessarily be confined to a limit which is not to be exceeded.

My injection of a continuous jet of cast iron through the air—the melted iron dropping freely upon a disc, the diameter of which is not required to be more than 8in. for acting upon several thousand pounds weight in a few hours—will not require, if the disc be made to turn say 2000 revolutions a minute, more than about a man's power, provided this power be maintained for four or five minutes, which is the time required for casting 200 lbs. of metal. The rotary motion being once imparted, the disc will act as a fly-wheel, and continue to rotate for some time after it is first set going. The disc throws off instantaneously to its circumference, and from thence into the surrounding air tangentially to its circumference, all the metal that it receives on its central portion; consequently it does not support any other load besides its own weight, and that of the vertical shaft with which it rotates, and a moveable metallic layer less than 1 line thick, extended over its whole surface, so that barely one pound more force is required while spreading the metal than when the disc is made to turn empty.

Hence, as I require so little power for my process as compared with Mr. Bessemer's method, I cannot possibly see any superiority in the latter process over mine as to the point to be attained, viz., the greatest amount of cast-iron surfaces to be brought in contact with atmospheric air during the operation.

I hold that, on looking at my pulverised cast-iron, I have some difficulty in granting Mr. Bessemer not only any superiority, but even equality.

Should it be argued that with his process the operation lasts from 20 to 25 minutes (the time named by Gustave Maurice), whilst my process at a high temperature can hardly be rated as to its duration, so rapidly passes cast iron treated by my dividing process from the liquid into the solid state, —I beg to reply that such rapid solidification is quite correct, but it only proves the energy with which the surrounding air has absorbed the caloric from the metal, or, in other words, that the greatest possible amount of contact has taken place.

Mr. Bessemer causes the mass in fusion to be exposed to the action of about twenty small jets of air; but even supposing the mass of melted iron has been exposed to the action of these jets for, say even 20 or 25 minutes, it still remains to be ascertained if each particle of the metal has been exposed to the action of the injected air (which is certainly not very probable), as unless *this is the case*, the action of the jets of air cannot accomplish the desired object. Whereas, by my process, from the detached manner in which each particle of the finely divided metallic mass is collected after having been exposed to the centrifugal force, evidently proves its thorough subdivision, and that every particle has been brought in contact with the surrounding air.

Moreover, if any doubts upon this point could still exist, I beg to observe that in my system such division is but preliminary, whilst Mr. Bessemer's consists alone in the injection of air into the midst of the metal.

In reference to this one only operation constituting Mr. Bessemer's process, and in order to remove a first impression which might possibly be produced upon comparison with my *three distinct* operations,—it is necessary to refer to a subject of the highest importance in manufacturing production, for it touches to the quick the financial side of the question—I mean, the loss to which the raw material, *i.e.*, the cast-iron, is subjected during its conversion into steel by Mr. Bessemer's process.

M. Gustave Maurice did not allude to this fact in his "Letters," but I now gather, from the description he gives us of the operation he witnessed, and also by his quotations from the papers read in 1859 by Mr. Bessemer, before the Institution of Civil Engineers, sufficient information to enable me to understand how metallurgists, both theoretical and practical, and by no means hostile to Mr. Bessemer's process, had arrived at the conclusion, after witnessing his experiments, that the great proportion of the metal carried off from the apparatus in the state of oxide by the force of the current of air, did really and practically constitute the weak side of the process. I shall not here endeavour to estimate even approximately, the loss which I was told resulted therefrom, but if such statement is true, it bids fair to give to my process a considerable superiority, particularly in a financial view.

Now, in my process, as regards the question of loss, I cannot have any but such as results from fusion of a metal already refined and from the

eliminating of carbon; for in the two previous operations, not only is there no loss, but even an excess in weight owing to oxydation. In short, the loss by my process, which varies according to the nature of the material used, never reached yet 5 per cent. since I have abstained from using any addition of flux.

How could the metal by my process be subjected to any loss by being projected into the air, since at the works now actually in construction this projection will take place within a circumscribed space, giving access to the external air only through the bottom, and communicating by means of large conduits on the top with another space, or upper chamber into which will be deposited the impalpable particles ascending with the gases and the rarefied air from one chamber to the other? And it is to be observed that these particles are to actively conduce in my system to the final object to be attained, and that with these particles shall be mingled other products of the division, their oxydation being completed by the wet process, unless I can contrive for them a more profitable application. I will now proceed to describe what I have previously termed my second operation, although I may appear to be rather ambitious in denominating as a distinct operation in connection with my process the mere act of pouring some few bucketfuls of water on a heap of cast iron reduced into powder, spreading, some hours after, this same heap over the ground in order to facilitate its oxydation, and also causing the excessive moisture to be more readily vapourized.

But, however simple in itself this manipulation may appear, the consequences are important as to the chemical action that this addition of water will produce, which action I have already said is not to be obtained by any of the processes heretofore employed. I am not so bold as to ground my remarks upon theory alone, but will here extract from one of our chemical illustrations an explanation of the phenomenon produced in the formation of rust on iron when exposed to damp atmospheric air. "Whilst water and oxygen, when taken separately," says M. Dumas, "exert in a cold state no action upon certain metals, they have, on the contrary, when united, a very powerful action thereon."

After admitting that oxygen, water, and the metal constituted themselves into an electrical state which determined the first spot of rust, the learned chemist adds: "An oxide is always negative as regards the metal it contains; consequently, the small portion of oxide and the remaining iron (let it be well understood that I am alluding to the first rusty spot) will produce a galvanic element; and practice has demonstrated that this element is altogether more energetic than that resulting from the contact of water with the metal. The presence of oxides renders the metal still more positive; this attracts the oxygen with more force, and oxydation is more rapidly effected. This new action is even so powerful as to decompose water. When a paste or mixture is made with aerated water and iron filings, there is an instant when the decomposition of water is effected in the cold state so rapidly as to yield in a very short time a considerable quantity of hydrogen."

It appears to me that these remarks, coming from so eminent an authority, tend very materially to confirm the opinion I have just expressed, as to the important results arising from oxydation by the wet process, particularly when it is considered that I act upon large masses, and not, as in a chemist's laboratory, upon a few grammes, or even kilogrammes, of iron filings, which, of course, renders electrical action more powerful. If this electric action causes a decomposition of the air or water in contact with pulverized iron, a separation should take place between the hydrogen and oxygen of the water, on the one hand, and on the other between the oxygen and azote of the air; hence, may not some idea be formed of the combinations to be realized by the union of these gases in the nascent state with sulphur, phosphorus, or arsenic which may be contained in cast iron? and which combinations will tend to the purification of the metal.

But, apart from these conjectures, if we inhale the odour of a flask, the contents of which are cast iron, pulverized and moistened with distilled water, the acrid odour emitted therefrom will clear up this question better than anything I could further add. I know, by my own experience, that this odour varies sensibly, according to the nature of the material employed. The sample which I presented before the "Cercle" was obtained with cast iron of the finest quality; whereas, in my first experiments, I had operated upon a lot of cast iron which I happened to pick up among the refuse of a foundry, and an odour still more acrid was evolved from it by oxydation.

After the detailed manner in which I have been examining the subject of the division and oxydation of metal as preliminary operations, it remains for me now to treat of fusion in a crucible, or in a reverberatory furnace; as, by giving a short description of my first attempts in this direction, it may perhaps save others the disappointments I had to encounter.

In my first essay of fusion, I confined myself to merely filling a crucible with cast iron, pulverized and oxydized without any addition of flux, the crucible being raised previously to a white heat. After three hours of continued heating in a forced air-furnace, I had the disappointment to

have my metal taken off from the furnace not quite exactly in the state it was thrown in, but agglomerated, as it were, and showing not the least appearance of fusion.

Whether such resistance to fusion was the result of too large a proportion of carbon having been taken away from the metal in the preliminary operation of division, or whether this result was to be attributed to the very extreme state of division, or if it could be attributed to the layer of oxide adhering to acid interposed between the metallic particles, still it is quite evident that the necessity for a flux must be obvious. I therefore had recourse to a whole series of fluxes; all, or nearly all, giving as a result a complete fusion in the course of half or three-quarters of an hour; but I still experienced I had another difficulty to overcome. For although the lugs obtained would, as it were, seem to be a success—for on being broken they showed a compact grain, sometimes of shining appearance, and assumed under the action of the hammer the form of a bar—still, however, the steel thus obtained was crude, and rather difficult to work.

It was, therefore, upon my ascertaining losses of 10, 12, and even 14 per cent. in my fusions (when employing fluxes) that I was led to believe that fluxes attracted the greater proportion of the oxides to their own benefit, but to the detriment of cast iron to be decarburated.

Inventors are generally aware of what patience and tenaciousness are required for such experiments. Before being enabled to ascertain what was my weak side, I had to try many an experiment which it would be needless to mention; one of them, however, I shall relate, on account of its curious results.

The following mixture was submitted to fusion:—

Pulverized cast iron, unoxydized, but in the same state as after being divided	5 oz.
Red, impalpable oxyde	1½ "
Borax	⅔ "
Slag from a steel manufactory in the department of Isere (France), and containing a considerable amount of metal.....	6 "

Total

13 "

about half of which were metal, if I sum up the 5oz. of unoxydized powder, together with the metallic portions contained in about 1½ oz. of oxyde, and the 6oz. of slag.

After the cooling and breaking up of the contents of the crucible, the result gave a description of glass, without the slightest trace of metallic dross or grain, all the metal having apparently disappeared.

Seeing, then, the impossibility on the one hand of melting my pulverized iron by itself, and on the other hand the well-proved inconvenience of fluxes, I thought of mixing together, after Mushat's and Bréant's processes, one portion of cast iron in its natural state with another portion divided and oxydized, with the hopes that the fusion of the carburetted portion would determine the reaction, and finally the fusion of the oxydized portion.

The experiment proved fully successful, and I obtained in addition thereto, another unexpected result which I will mention; it has reference to the proportions of the mixtures. In the *Letters sur Sheffield* we read the following passage concerning the *counter*, by means of which Mr. Bessemer states he can ascertain exactly and precisely the desired degree of decarburation:—

"I have underlined in Mr. Bessemer's communication a sentence relating to the degree of precision which is attainable by the use of the "counter" in the production of the quality of the steel, because it does not seem to me to have been proved that such degree of precision as announced has yet been attained. What induces me to think so is the suppression of the said "counter," or at least the circumstance of its being employed during the whole time I was present; for in the operation I witnessed, the degree of decarburation was ascertained not from the amount of injected air, but from the time elapsed (20 or 25 minutes), and from the colour and length of the flames emitted from the retort."

The remarks I have just quoted do not seem to prove that Mr. Bessemer's expectation has been fulfilled. Whatever it may be, I have learned from a series of experiments that I have no more reason to puzzle myself about the mechanical counter any more than about the attendant's sharpness.

A mixture by equal parts of cast iron from Ria (Pyrenées Orientales) one portion of which consisting in fragments of pig iron, and the other portion divided and oxydized, yielded a good product.

By trying another description of iron, termed Marquise (Pas de Calais), I naturally at first effected the mixture by equal parts, but thought at first the operation had not succeeded so well when, after a longer time than usual, having elapsed, I remarked that I could not obtain a thorough fusion. My retort contained, floating upon the surface of the melted iron, small masses of apparently granulated particles or scoriæ; I cast the liquid portion into a mould, expecting to find again in my retort the floating stuff alluded to, but instead of which I could only collect

some dust, which may still be utilised a second time; and it contains so little dross that it is wholly attracted by the magnet. As to the metal cast into the mould, and which I feared was not completely decarburated, it produced a steel of quite as good quality as that resulting from the Ria cast iron.

Various other fusions in which I successively made use of the same description of iron as above, viz., Marquise and Ria, after weighing exactly first the pig iron and the mixed powders, the resulting product invariably yielded. With the Ria cast iron an absorption of 100 parts in oxydized powder by 100 parts in pig fragments, whilst the proportion of powder absorbed by Marquise cast iron was only 54 to 56.

Some experiments with cast iron from Berry (France) led to different proportions, though nearly constant, notwithstanding the excess in powder thrown into the mixture, which excess is always found again intact when the metal is run off; hence, I feel justified in concluding that, after a first experiment with any given description of cast iron, and provided the proportion of oxydized powder be increased, it is easy to ascertain precisely the proportions of the mixture. It is merely a question of weights. Since I have mentioned the products resulting from the use of cast iron termed Marquise, I shall add a few words more about a small block or anvil which I presented to the *Cercle*, as a specimen of what can be expected not only from this description of cast iron, but also from my process for the cheap manufacturing of a number of tools and implements which do not require very superior qualities. This block was formed, or cast, at once into a mould, and its lower unpolished surface still bear vestiges of its origin; its upper surface alone was slightly acted upon by hammer, after a heating which has some similitude to that made use of for malleable cast iron. This annealing process I do not deem indispensable; it may, however, be of use in some cases. The upper surface or table, which was tempered and polished, shines like a mirror. The block weighs a little more than 1½ pounds, from which it ensues that similar blocks sold for about 7d. (75 cents) would represent steel at, say, £2 per cwt.; and as the raw material, though of a comparatively high price for cast iron, only costs about 7s. per cwt., it is easy to perceive that a considerable reduction may yet be effected in the selling price of 7d. a piece.

(To be continued in our next.)

EXPANSION OF STEAM.

By MR. LOUIS KOCH, of New York.

(Continued from page 40.)

It only remains to investigate, if under a different pressure the relations will be the same: we will, therefore, take the same cylinders and strokes, with a pressure of 36 lbs.

1st. The mechanical effect of full stroke will be 36 lbs. per square inch, or 7200 lbs. per 200 square inches: 6 ft. stroke = 43,200 lbs. lifted one foot.

Deducting for friction 2½ lbs. per square inch = 500 lbs., or 3000 lbs. lifted one foot, and atmospheric pressure 14½ lbs. per square inch = 2950 lbs., or 17,700 lbs. lifted one foot..... = 20,700 " "

Leaving a clear effect of..... = 22,500 " "

or 52.083 per cent.

2nd. The mechanical effect of cutting off at one-half stroke will be 36 lbs. per square inch, or 7200 lbs. per 200 square inches: 3 ft. stroke = 21,600 lbs. lifted one foot.

26.513 lbs. mean pressure per square inch, or 5302.6 per 200 square inches: 3 ft. stroke = 15,907.8 " "

Adding, we have..... = 37,507.8 " "

Deducting friction and atmospheric pressure... = 20,700.0 " "

Leaving a clear effect of = 16,807.8 " "

or 38.905 per cent. with one-half the amount of steam, and 33.615.6 lbs. lifted one foot, or 77.810 per cent. with full steam.

3rd. The mechanical effect of cutting off at one-third stroke will be 36 lbs. per square inch, or 7200 lbs. per 200 square inches: 2 ft. stroke = 14,400 lbs. lifted one foot.

23.48 lbs. mean pressure per square inch, or 4696 lbs. per 200 square inches: 4 ft. stroke = 18,784 " "

Adding, we have..... = 33,184 " "

Deducting friction and atmospheric pressure... = 20,700 " "

Leaving a clear effect of = 12,484 " "

or 28.9 per cent. with one-third the amount of steam, and 37,452 lbs. lifted one foot, or 86.7 per cent. with full steam.

4th. The mechanical effect of cutting off at one-quarter stroke will be 36 lbs. per square inch, or 7200 lbs. per 200 square inches: 1½ ft. stroke... = 10,800 lbs. lifted one foot.

22.0178 lbs. mean pressure per square inch, or 4403.56 lbs. per 200 square inches: 4½ ft. stroke = 19,816 " "

Adding, we have = 30,616 " "

Deducting friction and atmospheric pressure... = 20,700 " "

Leaving a clear effect of..... = 9,916 " "

or 22.95 per cent. with one-quarter the amount of steam, and 39,664 lbs. lifted one foot, or 91.81 per cent. with full steam.

The same per centage exists under the same pressure, whatever the diameter of the cylinder or length of the stroke may be.

In the foregoing calculations, condensation in the cylinder has not been taken into consideration; it will, of course, be greater in proportion to the cut-off being smaller, but the difference to me seems to be trifling, and will cause but little alteration in the above calculations of per centage.

And now, having arrived at a point from which we are enabled to deduce certain elements, the subjoined are submitted:—

1st. The pressure of steam in the cylinder at the end of the stroke, when cut off at any point during the stroke, is smaller than the proportion to the full pressure; and this difference becomes greater, first, with the increase of pressure, and secondly, with the decrease of cutting off.

2nd. The per centage of mechanical effect between that of full stroke and that of cutting off at any point of the stroke, remains the same, the cylinder being large or small, the stroke long or short, as long as the pressure is the same.

3rd. The greater the pressure the greater the per centage of mechanical effect in high pressure engines, under all circumstances. (The relations seem to be different in low pressure engines, which I propose to discuss at a future time.)

4th. The greater the pressure, the greater the relative per centage between the full stroke and the cut-off system.

5th. There is no such thing as a greater mechanical effect in the same cylinder and at the same pressure, when cut-offs are used instead of full steam during the whole stroke; but, on the contrary, there is a proportionate and not inconsiderable falling off of mechanical effect when the former is used, notwithstanding all that has been or may be said to the contrary, and this difference becomes greater with a lesser pressure.

6th. The same amount of steam, under the same pressure, in the same cylinder, used with cut-offs instead of following full stroke, will produce a greater mechanical effect, but it requires a greater space of time; it being in the same proportion as the relative per centage between full stroke and cut-offs, or *vice versa*. During the same space of time, when cut-offs are used, and using a proportionate increase of pressure representing a greater volume of steam, the same mechanical effect will be obtained as that in following full stroke with a lesser amount of steam; or during the same space of time, and with the same amount of steam at a proportionate higher pressure, a greater mechanical effect will be obtained in using cut-offs as in following full stroke.

And now, allow me to remark, that here we have a full explanation of what has been asserted, that the mechanical effect in changing the full stroke to any part of the cut-off, during the working of the engine, was found to be greater in the latter case than in the former.

Suppose we have the same engine as that from which we drew our first deductions—*i. e.*, 200 square inches area, 6ft stroke, and 60lbs. pressure. Then we will have, as shown, a clear mechanical effect of 51,300lbs., or 71½ per cent. of the power exerted by the steam. I have further shown, that when the feeding of steam is cut off at one half stroke, we have a clear mechanical effect of 41,709lbs., or 57.93 per cent., or with the same amount of steam used at full stroke, 83,418lbs effect, or 115.86 per cent. The fire or the production of heat not being changed in using the cut-off, it is evident that with each stroke of the engine, 4⅓ cubic feet of steam will be used less than before, the production remaining the same: and now let us take the steam space at 100 cubic feet, and the engine running only 12 revolutions per minute, and we have the startling result that, in less than one minute, the pressure in the boiler will be found to be at 100lbs. per square inch, provided the safety valve be loaded to that amount; and its clear effect will be 83,300lbs. lifted one foot, or 115.69 per cent., instead of 71½ per cent. when full stroke was used. But when the safety valve remains loaded with 60lbs. in working order, and its orifice is proportionate to the production of all the steam, then, gentlemen, there is no such thing as the engine beginning to jump, or attempting to "run away;" but, on the contrary, its speed will fall off almost immediately, until not more than 57.93 per cent. of the former 71½ per cent. will remain.

7th. From the above deductions, drawn from calculation, we now arrive at the conclusion that a much greater mechanical effect is attained in using cut-offs instead of following full stroke, when the same volume of steam is used, or the same effect is attained with a lesser volume of

steam: the consequence is, that the production of a lesser volume of steam, requiring a lesser quantity of heat, the same mechanical effect, in using cut-offs instead of following full stroke, is attained with a lesser amount of coal, all conditions being otherwise equal. Therefore, let me add, go a-head, busy inventors, and give us an improved cut-off, that will answer our purposes well, and give satisfaction to all.

AMERICAN GOVERNMENT EXPERIMENTS ON THE EXPANSION OF STEAM.

In the U.S. Steamer *Michigan*, a series of experiments—for the sake of comparing the actual saving by expansion of steam in the cylinder with the calculated results—has been carried out by Government.

The results of the experiments for the first twenty-four hours, which we give below, have, however, not been very satisfactory on the point of economy in fuel; for it will be observed in the subjoined table, that while the experimental results show a constant increase in the expenditure, as

the amount of expansion is INCREASED, on the contrary, the calculated (or theoretical) results show a constant DECREASE. Now, this is very natural, as is shown on considering the particulars of the engine. First, there is no superheating apparatus attached to the boiler; second, there are no steam-jackets round the cylinders. When these two material points are left out, a high degree of expansion must always be followed by a considerable loss of power and fuel. Thus far these experiments coincide entirely with the experiments made here in England at different times by eminent engineers, as far back as we can recollect, and they still teach us this lesson, that it is no use to carry out a high degree of expansion unless we first introduce steam jackets and moderately superheated steam—viz., steam superheated thus far, that it arrives in the cylinder in a perfectly gaseous state of the same initial pressure as it was generated in the boiler.

In the following table we give the average quantities of the first twenty-four hours' experiments; the last column, however, is not quite to be depended upon.

	POINT OF CUTTING OFF.						
	Full Steam.	Two Thirds.	Four Tenths.	One Third.	One Fourth.	One Sixth.	One Twelfth.
Number of engines running	One	One	Two	One	Two	—	Two
Pressure of steam in boilers	20 lbs.	20 lbs.	20·7 lbs.	20 lbs.	21 lbs.	20 lbs.	21 lbs.
Inches of vacuum in condenser	25·9	25·9	25·5	25·5	24·8	26	25·8
Pounds of vacuum in cylinder	11·5	11·5	11·15	11·5	10·74	11·76	11·78
Height of barometer	29·57	30·15	30·09	29·71	29·45	29·90	—
Back pressure on pistons	3·2 lbs.	3·2 lbs.	3·6 lbs.	3·2 lbs.	3·7 lbs.	2·9 lbs.	—
Mean effective pressure on pistons	30·2 lbs.	28·4 lbs.	20 lbs.	20·5 lbs.	15·8 lbs.	13·2 lbs.	8·48 lbs.
Revolutions per minute	13·59	14·31	19·3	11·3	15·49	9·04	11·8
Speed of pistons, in feet, per minute	217	229	309	176	248	144	188
Horse-power developed on the pistons	201	200	379	111	240	587	100
Pounds of coal per hour	1100	976	2066	650	1430	404	720
Pounds of coal per hour per square foot of grate	12·24	10·84	22·9	7·22	15·9	4·5	8
Pounds of coal per hour per horse-power	5·46	4·89	5·4	5·85	5·95	6·64	7·2
Pounds of water evaporated per hour as per tank, per horse-power	42·7	37·9	41·8	43·3	46·75	54·25	58
Per centums of steam evaporated as per tank, not accounted for by indicator	13·33	16·17	36·5	41·05	47	56·88	—
Pounds of water evaporated from a temperature of 100° per pound of coal, as per tank	8·08	8·02	7·9	7·77	8·12	8·41	8·32
Cost of power, full stroke being unity, as per water evaporated	1·00	0·88	0·97	1·01	1·09	1·27	1·35
Cost of power, full stroke being unity, as per coal burned	1·00	0·89	0·98	1·07	1·09	1·21	1·31
Cost of power, full stroke being unity, as usually calculated by engineers	1·00	0·77	0·55	0·52	0·43	0·37	0·29
Number of times the calculated must be multiplied to obtain the experimental cost	1·00	1·15	1·78	2·05	2·53	3·27	4·51

KRUTZSCH'S IMPROVEMENTS IN CARTRIDGES AND PROJECTILES.

These improvements relate to a novel description of cartridge or case for holding the charge, whether for small arms or ordnance; also to the mode of combining therewith a projectile; and to a novel mode of combining metal small shot for use in small arms, for sporting and other purposes.

Instead of employing paper or metallic tubes or cases for holding a charge of powder, wooden cylinders are substituted, being bored up to the requisite extent internally, and turned at one end to suit the bullet or shot, and at the other end to suit the character of the chamber or breech of the gun from which the charge is intended to be fired, and whether such arm or piece be loaded at the muzzle or at the breech.

For sporting purposes with small arms, is made a novel description of bullet by combining a number of small metal shots with a mixture of soap, and compressing the same by means of moulds into the shape required, for the purpose of forming a solid mass whilst they remain in the bore of the

piece, or until after they are projected therefrom, when the soap mixture admits of the disintegration of the mass without injury to the form of the individual shots,—so that whilst a greater flight is obtained, due to the form and compactness, the advantage of the full charge of shot is also obtained. The form of the case or cartridge for containing the powder is also somewhat modified to suit this description of bullet, and instead of forming the conical projection and shoulder B (Figs. 1 and 4) at the end which receives the bullet, the end B (Figs. 2 and 3) of such cartridges, when they are intended for sporting purposes are shaped into a sort of cup-form, forming a cavity, into which is placed the conglomerated bullet formed as described. Figs. 1 and 2 are sectional elevations of the improved cartridges intended to be used with that description of breech-loading piece known as the "needle-gun." The cartridge in Fig. 1 being adapted to receive the ordinary conical rifle bullet; and Fig. 2 showing a cartridge formed to receive a conglomerated bullet to be used for sporting purposes.

Figs. 3 and 4 are sectional elevations of the improved cartridges adapted for use in muzzle-loading pieces. Fig. 3 shows the cartridge of a slightly increased diameter, and formed to receive a spherical conical

bullet, intended to be used for sporting purposes. The cartridge *proper* in Fig. 4 is formed in the same manner as that in Fig. 1, and is adapted to receive the same description of bullet as is shown there.

In Figs. 1 and 4, B is the tapered shoulder piece at the extremity of the cartridge, to which the bullet C is attached, the cavity in the base of the ball being so formed as to allow of the tapered shoulder piece fitting accurately therein, whilst sufficient distance is left between it and the bullet to allow of its being driven thereinto, and expanding it when the piece is discharged. In Figs. 2 and 3, B is the extremity of the cartridge, having the cupped recess or cavity adapted to receive the bullet C, to be used for sporting purposes.

Fig. 1. Fig. 2. Fig. 3. Fig. 4.

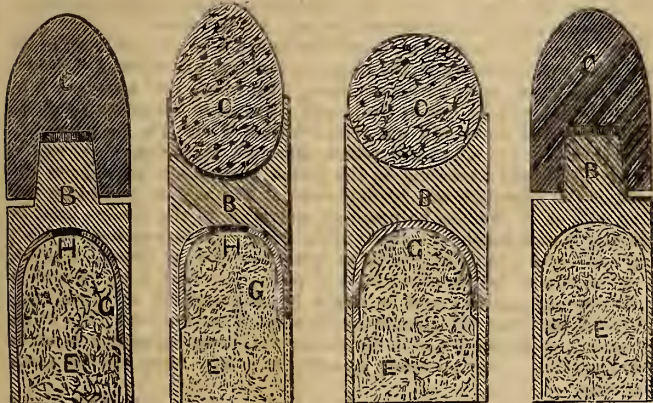

E (Figs. 1 to 4) is the powder; G (Figs. 1, 2, and 3) is a small cap piece of paper, leather, or thin metal inserted in the base of the cartridge, previous to filling in the powder, applied for the purpose of uniformly distributing the explosive force of the contained powder when the piece is discharged. In Figs. 1 and 2, H is the fulminating mixture placed in the base of the paper or other cup piece just described in such manner that, when the piece is discharged, the needle or pricker is caused to pierce the fulminating cap H, causing the ignition of the powder and consequent discharge of the projectile. In Fig. 4, the cup piece C is removed.

LOEWENSTEIN'S IMPROVEMENTS IN APPARATUS FOR PAYING-OUT SUBMARINE CABLES.

The object of this invention is to prevent the breaking of the cable by any sudden strain, and is effected by regulating the rate of paying out the cable according to the strain upon it caused by the various motions of the vessels.

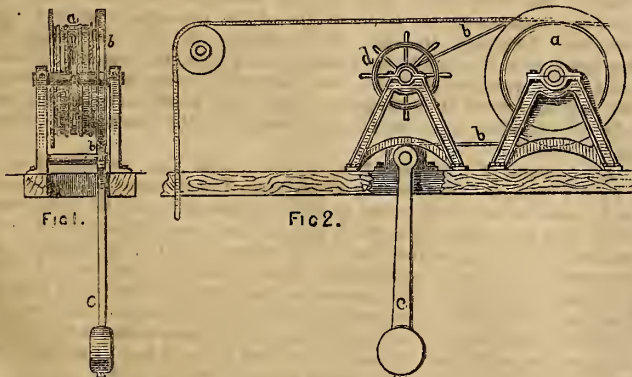

Fig. 1 exhibits an end view; Fig. 2 a side elevation of the improved apparatus.

The cable is paid out over an ordinary grooved wheel or drum (a), over which also in a separate groove passes a break (b), one end of which is connected to a heavy pendulum (c), mounted on bearings, and the other to the axle-tree of a break wheel (d).

In acting with the motion of the vessel, the pendulum always retains its perpendicular position; when the stern of the vessel falls, the break is caused to bear with greater strain upon the drum, slowing its motion, and thereby decreasing the rate of paying out the cable.

When the stern rises, the motion of the pendulum causes the reverse

action, decreasing the strain of the break upon the drum, and allowing the cable to be paid out more freely.

The inventor states that the great merit of this invention consists in the self-acting or working of the machinery, and the consequent increase or decrease of the rate of paying-out the cable being entirely controlled by the motion of the vessel.

STEAM.

THE MECHANICAL THEORY OF HEAT.

BY D. K. CLARK.

An important and interesting inquiry relative to steam and its operation in the steam engine, is that which traces the connection between the heat expended and the dynamical effect, or work, produced. The method of separate condensation, and the application of the force of expanding steam, changed to an important extent the accepted relations of heat to power, and added remarkably to the dynamical effect of the fuel; and though the steam engine has been progressively improved by the continual elaboration of small economies, there is yet good reason to believe that the field of improvement is wide, and that the labourer in that field has the prospect of a good return. The inquiries of scientific men on the subject of the relation of heat to mechanical effect, have resulted in the establishment of the principle that heat and mechanical force are identical and convertible, and that the action of a given quantity of heat may be represented by a constant quantity of mechanical work performed. "Motion and force," says Professor Rankine, "being the only phenomena of which we thoroughly and exactly know the laws, and mechanics the only complete physical science, it has been the constant endeavour of natural philosophers, by conceiving the other phenomena of nature as modifications of motion and force, to reduce the other physical sciences to branches of mechanics. Newton expresses a wish for the extension of this kind of investigation. The theory of radiant heat and light having been reduced to a branch of mechanics by means of the hypothesis of undulations, it is the object of the hypothesis of molecular vortices"—oscillation or vibratory motion—"to reduce the theory of thermometric heat, and elasticity also, to a branch of mechanics, by so conceiving the molecular structure of matter that the laws of these phenomena shall be the consequences of those of motion and force. This hypothesis, like all others, is neither demonstrably true nor demonstrably false, but merely probable in proportion to the extent of the class of facts with which its consequences agree." It must, however, be remarked that, whether the hypothesis of molecular motion be probable or improbable, the theoretical and practical results arrived at in regard to the mechanical action of heat remain unaffected, being deduced from principles which have been established by experiment and demonstration. From these principles, Professor Rankine announced the specific heat of air before it was otherwise known,—the accuracy of his deductions having since been verified to within less than 1 per cent. by the experiments of Regnault. The best experiments, previous to those made by Regnault, in regard to the specific heat of air, were those of Delaroché and Berard, from which they deduced a specific heat of .266; but, arguing from the mechanical theory of heat, Professor Rankine declared that this value must be erroneous, and that the specific heat of air could not exceed .240. It has been found accordingly, by Regnault, since the statement was made, as the result of a hundred experiments, that the specific heat of air was .238, and that it is constant for all pressures from one to ten atmospheres, or at least differs almost inappreciably. This coincidence of theoretical prediction with experimental evidence, it has been well observed, should have something like the same tendency in strengthening our belief of the theory upon which Professor Rankine's estimate was based, as the discovery of an unknown planet, previously indicated by Le Verrier and Adams, had in confirming our faith in the science of astronomy.

The principle of the dynamical or mechanical theory of heat, as already stated, is that, independently of the medium through which heat may be developed into mechanical action, the same quantity of heat converted is invariably resolved into the same total quantity of mechanical action. For the exact expression of this relation, of course, units of measure are established:—in terms of the English foot, as the measure of space; the pound avoirdupois, as the measure of weight, pressure, elasticity; and the degree of Fahrenheit's scale, as the measure of temperature and heat. Work done consists of the exertion of pressure through space, and the English unit of work is the exertion of 1 lb. of pressure through 1 foot, or the raising of 1 lb. weight through a vertical height of 1 foot: briefly, a foot-pound. The unit of heat is that which raises the temperature of 1 lb. of ordinary cold water by 1 degree Fahr. If 2 lb. of water be raised 1 degree, or 1 lb. be raised 2 degrees in temperature, the expenditure of heat is, equally in both cases, two units of heat. Similarly, if 1 lb. weight be raised through 1 foot, or 2 lb. weight be raised through 2 feet, the power expended, or work done, is equally in both cases two units of work, or two foot-pounds. From these definitions, then, the comparison lies between

the unit of heat, on the one part, and the unit of work, or the foot-pound, on the other.

M. Clapeyron, in his treatise on the moving power of heat, and M. Noltzman, of Manheim, in 1845, who availed himself of the labours of M. Clapeyron and M. Carnot in the same field, grounding their investigations on the received laws of Boyle, or Mariotte, and Gay Lussac, which express the observed relations of heat, elasticity, and volume, in steam and other gaseous matter, concluded that the unit of heat was capable of raising a weight, between the limits of 626lb. and 782lb., 1 foot high; that is to say, that one unit of heat was equivalent to from 626 to 782 foot-pounds. By this mode of investigation, they suppose a given weight of steam, or gaseous matter, to be contained in a vertical cylinder formed of non-conducting material, in which is fitted an air-tight but freely-moving piston, which is pressed downwards by a weight equal to the elasticity of the gas. Now, the weight, initial temperature, pressure, and volume being known, a definite quantity of heat from without is supposed to be imparted to the vapour; and the result is partly an elevation of the temperature of the vapour, and partly a dilation or increase of volume, or, in other words, an exertion of pressure through space—the elasticity remaining the same. But the result may be represented entirely by dilation, so that there shall not be any final alteration of temperature; and for this purpose, it is only necessary to allow the vapour to dilate without any loss of its original or imparted heat until it re-acquires its initial temperature. In this case, the ultimate effect is purely dilatation, or motion against pressure; and the work done is represented by the product of that pressure into the space moved through.

Mr. Joule, of Manchester, in 1843-47, proceeded, by entirely different, independent, and, in fact, purely experimental methods, to investigate the relation of heat and work:—1st, By observing the calorific effects of magneto-electricity. He caused to revolve a small compound electro-magnet, immersed in a glass vessel containing water, between the poles of a powerful magnet: heat was proved to be excited by the machine, by the change of temperature in the water surrounding it, and its mechanical effect was measured by the motion of such weights as by their descent were sufficient to keep the machine in motion at any assigned velocity. 2nd, By observing the changes of temperature produced by the rarefaction and condensation of air. In this case, the mechanical force producing compression being known, the heat excited was measured by observing the changes of temperature of the water in which the condensing apparatus was immersed. 3d, By observing the heat evolved by the friction of fluids:—a brass paddle-wheel, in a copper can containing the fluid, was made to revolve by descending weights. Sperm oil and water yielded the same results. Mr. Joule considered the third method the most likely to afford accurate results; and he arrived at the conclusion that one unit of heat was capable of raising 772lb. 1 foot in height; or, that the mechanical equivalent of heat was expressible by 772 foot-pounds for 1 unit of heat,—known as “Joule’s equivalent.”

The following are the values of Joule’s equivalent for different thermometric scales, and in English and French units:—

1 English thermal unit, or 1 degree of Fahr. in 1 pound of water	} 772 foot-pounds.
1 centigrade degree in 1 pound of water..... (or nearly 1390).	} 1389·6 „
1 French thermal unit, or 1 centigrade degree in a kilo- gramme of water	} 423·55 kilogram- metres.

The mechanical theory of heat rests upon a wide basis, and proofs in verification of the theory are constantly accumulating. When the weight of any liquid whatever is known, with the comparative weight of its vapour at different pressures, the latent heat at the different pressures is readily estimated from the theory; and this method of estimation agrees with the best experimental results, as may afterwards be shown; and when the latent heat is also known, the specific heat of the liquid can be determined by means of the same theory: in other words, the quantity of work, in foot-pounds, may be determined, which would, by agitating the liquid or by friction, be required to raise the temperature of any given quantity of the liquid by, say, one degree, altogether independently of Joule’s experiments. The theory enables us to discover the utmost power it is possible to realize from the combination of any given weight of carbon and oxygen, or other elementary substances, with nearly as much precision as we can estimate the utmost quantity of work it is possible to obtain from a known weight of water falling through a given height. It is not difficult to comprehend, then, that the theory of the mechanical equivalent of heat proves of great practical utility.

According to the mechanical theory of heat, in its general form, heat, mechanical force, electricity, chemical affinity, light, sound, are but different manifestations of motion. Dulong and Gay Lussac proved, by their experiments on sound, that the greater the specific heat of a gas, the more rapid are its atomic vibrations. Elevation of temperature does not alter the rapidity, but increases the length of their vibrations, and in consequence produces “expansion” of the body. All gases and vapours are assumed

to consist of numerous small atoms, moving or vibrating in all directions with great rapidity; but the average velocity of these vibrations can be estimated when the pressure and weight of any given volume of the gas is known, pressure being, as explained by Joule, the impact of those numerous small atoms striking in all directions, and against the sides of the vessel containing the gas. The greater the number of these atoms, or the greater their aggregate weight, in a given space, and the higher the velocity, the greater is the pressure. A double weight of a perfect gas, when confined in the same space, and vibrating with the same velocity—that is, having the same temperature—gives a double pressure; but the same weight of gas, confined in the same space, will, when the atoms vibrate with a double velocity, give a quadruple pressure. An increase or decrease of temperature is simply an increase or decrease of molecular motion. The truth of this hypothesis is very well established, as already intimated, by the numerous experimental facts with which it is in harmony.

When a gas is confined in a cylinder under a piston, so long as no motion is given to the piston, the atoms, in striking, will rebound from the piston after impact with the same velocity with which they approached it, and no motion will be lost by the atoms. But when the piston yields to the pressure, the atoms will not rebound from it with the same velocity with which they strike, but will return after each succeeding blow, with a velocity continually decreasing as the piston continues to recede, and the length of the vibrations will be diminished. The motion gained by the piston will, it is obvious, be precisely equivalent to the energy, heat, or molecular motion lost by the atoms of the gas. Vibratory motion, or heat, being converted into its equivalent of onward motion, or dynamical effect, the conversion of heat into power, or of power into heat, is thus simply a transference of motion; and it would be as reasonable to expect one billiard-ball to strike and give motion to another without losing any of its own motion, as to suppose that the piston of a steam engine can be set in motion without a corresponding quantity of energy being lost by some other body.

In expanding air spontaneously to a double volume, delivering it, say into a vacuous space, it has been proved repeatedly that the air does not fall appreciably in temperature, no external work being performed: but, on the contrary, if the air, at a temperature, say of 230° Fah., be expanded under pressure or resistance, as against the piston of a cylinder, giving motion to it, raising a weight, or otherwise doing work, by giving motion to some other body, the temperature will fall nearly 170° when the volume is doubled, that is, from 230° to about 60°; and, taking the initial pressure at 40 lbs., the final pressure would be 15 lbs. per square inch.

When a pound weight of air, in expanding, at any temperature or pressure, raises 130 lbs. 1 foot high, it loses 1° in temperature; in other words, this pound of air would lose as much molecular energy as would equal the energy acquired by a weight of 1 lb. falling through a height of 130 feet. It must, however, be remarked, that but a small portion of this work, 130 foot-pounds, can be had as available work, as the heat which disappears does not depend on the amount of work or duty realised, but upon the total of the opposing forces, including all resistance from any external source whatever. When air is compressed, the atmosphere descends and follows the piston, assisting in the operation with its whole weight; and when air is expanded, the motion of the piston is, on the contrary, opposed by the whole weight of the atmosphere, which is again elevated. Although, therefore, in expanding air, the heat which disappears is in proportion to the total opposing force, it is much in excess of what can be rendered available; and, commonly, where air is compressed, the heat generated is much greater than that which is due to the work which is required to be expended, the weight of the atmosphere assisting in the operation.

Let a pound of water, at a temperature of 212° Fah., be injected into a vacuous space or vessel, having 26·36 cubic feet of capacity—the volume of 1 pound of saturated steam at that temperature—and let it be evaporated into such steam, then 893·8 units of heat would be expended in the process. But, if a second pound of water, at 212°, be injected and evaporated at the same temperature, under a uniform pressure of 14·7 lbs. per square inch due, to the temperature, the second pound must dislodge the first, by repelling that pressure, involving an amount of labour equal to 55,800 foot-pounds (that is, 14·7 lbs. × 144 square inches × 26·36 cubic feet), and an additional expenditure of 72·3 units of heat (that is, 55,800 ÷ 772), making a total for the second pound of 965·1 units.

Similarly, when 1408 units of heat are expended in raising the temperature of air at constant pressure, 1000 of these units increase the velocity of the molecules, or produce a sensible increment of temperature; while the remaining 408 parts which disappear as the air expands, are directly expended in repelling the external pressure.

Again, if steam be permitted to flow from a boiler into a comparatively vacuous space, without giving motion to another body, the temperature of the steam entering this space would rise much higher than that of the steam in the boiler. Or, suppose two vessels, side by side, one of them vacuous, and the other filled with air at, say two atmospheres, a communication

being opened between the vessels, the pressure would become equal in the two vessels; but the temperature would fall in one vessel and rise in the other; and although the air is expanded in this manner to a double volume, there would not on the whole be any appreciable loss of heat, for if the separate portions of air be mixed together, the resulting average temperature of the whole would be very nearly the same as at first. It has been proved experimentally, corroborative of this argument, that the quantity of heat required to raise the temperature of a given weight of air, to a given extent, was the same, irrespective of the density or volume of the air. Regnault and Joule found that, to raise the temperature of a pound weight of air, 1 cubic foot, or 10 cubic feet in volume, the same quantity of heat was expended.

In rising against the force of gravity, steam becomes colder, and partially condenses while ascending, in the effort of overcoming the resistance of gravity, by the conversion of heat into water. For instance, a column of steam weighing, on a square inch of base, 250.3 lbs., that is, a pressure of 250.3 lbs. per square inch, would, at a height of 275,000 feet, be reduced to a pressure of 1 lb. per square inch, and, in ascending to this height, the temperature would fall from 401° to 102° Fahr., while, at the same time, nearly 25 per cent. of the whole vapour would be precipitated in the form of water, if not supplied with heat while ascending.

If a body of compressed air be allowed to rush freely into the atmosphere, the temperature falls in the rapid part of the current, by the conversion of heat into motion, but the heat is almost all reproduced when the motion is quite subsided; and from recent experiments, it appears that nearly similar results are obtained from the emission of steam under pressure.

When water falls through a gaseous atmosphere, its motion is constantly retarded as it is brought into collision with the particles of that atmosphere; and by this collision it is partly heated and partly converted into vapour.

If a body of water descends freely through a height of 772 feet, it acquires from gravity a velocity of 223 feet per second; and if suddenly brought to rest when moving with this velocity, it would be violently agitated, and raised one degree in temperature. But suppose a water-wheel, 772 feet in diameter, into the buckets of which the water is quietly dropped, when the water descends to the foot of the fall, and is delivered gently into the tail-race, it is not sensibly heated. The greatest amount of work it is possible to obtain from water falling from one level to another lower level, is expressible by the weight of water multiplied by the height of the fall.

The objects of these illustrative exhibitions of the nature and reciprocal action of heat and motive power, with their relations are,—first, to familiarise the reader with the doctrine of the mechanical equivalent of heat; second, to show that the nature and extent of the change of temperature of a gas while expanding depends nearly altogether upon the circumstances under which the change of volume takes place.

GENERAL RELATIONS OF GASEOUS BODIES.

Gases are divided into the two classes,—permanent gases and vapours. The former were originally so called, under the impression that they existed permanently in the gaseous state, and could not possibly be reduced to the liquid form; while those which could be so reduced, and could be reconverted to the state of gas, were called vapours. It has, however, been shown by Sir Humphrey Davy and Mr. Faraday, that by the conjoined effects of great pressure, and of a high degree of cold, most of the permanent gases may be liquefied. The under-mentioned still retained the gaseous state at the annexed temperatures and pressures:—

Hydrogen.....	at	-166°	Fahr.	and	27	atmospheres.
Oxygen.....	"	-166°	"	"	27	"
Ditto.....	"	-140°	"	"	58.5	"
Nitrogen.....	"	-166°	"	"	50	"
Nitric Oxide.....	"	-166°	"	"	50	"
Carbonic Oxide.....	"	-166°	"	"	40	"
Coal-gas.....	"	-166°	"	"	32	"

Several of the liquefied gases are further capable of being reduced to the solid state. Thus, sulphurous acid becomes solidified at -105°; sulphuretted hydrogen at -122°; carbonic acid at -72°; ammonia at -103°. The difference, then, between the permanent gases and vapours is merely one of degree, and depends upon the temperature at which the change from the fluid to the gaseous state occurs. Those which exist in the fluid state under ordinary temperatures and pressures are called vapours; those which require strong pressure and extremely low temperatures to reduce them to the liquid form, are called permanent gases.

Steam, as the elastic vapour of water, is amenable to the laws of gaseous fluids; and according to these laws, the pressure, the density, or the volume, and the temperature, bear fixed relations to each other. The influence of temperature on the expansion of permanent gases under constant pressures is such, that, for equal increments of temperature, the increments of volume by expansion are also equal, and they are nearly the same for different gases. The expansion of air by increase of temperature may be

assumed to represent that of other gases; and it may be added, the most exact measure of real temperature is to be found in the expansion of air, or any other perfect gas. By real or absolute temperature is signified the measure of the whole of the heat of a body; and at the absolute zero point of the scale, all gases would cease to have elasticity or molecular motion. As the expansion of air under constant pressure is found experimentally to be uniform for uniform increments of temperature, it is inferred, conversely, that it would contract uniformly under uniform reduction of temperature, until, on arriving at a temperature 461° below zero of Fahrenheit's scale, or, exactly -461.2°, the air would be in a state of collapse, without appreciable elasticity. This point has, therefore, been adopted as that of absolute zero, standing at the foot of the natural scale of temperature. For example, let a volume of air, 673 cubic inches in bulk, at a temperature of 212° Fahr., be confined at a constant pressure in a cylinder, under a piston movable without friction. If the gas be cooled 10°, the piston will descend through 10 cubic inches; if cooled 100°, the piston will descend, and the air will contract through 100 cubic inches; and so on, in the same ratio; so that, by lowering the temperature 673°, the air would not possess appreciable volume; and 673 - 212 = 461° below the artificial zero of Fahr., would, therefore, be arrived at as the point of absolute zero.

Again, if a given weight of air at 0° Fahr. be raised in temperature to 461° under a constant pressure, its volume will be doubled by expansion; and, if heated to 461 × 2 = 922°, its volume will be trebled; in short, for every increment of one degree of temperature, its volume will be enlarged by equal increments uniformly $\frac{1}{461}$ part of the volume at 0°.

The following, then, are the established relations of the properties of permanent gases:—

With a constant temperature, the pressure varies simply as the density, or inversely as the volume. This is known as Boyle's or Marriotte's law.

With a constant pressure, expansion is uniform under a uniform accession of heat or rise of temperature, at the rate of $\frac{1}{461}$ part of the volume at 0° Fahr. for each degree of heat. If, then, 461° be added to the indicated temperature by Fahrenheit's scale, the sum, or absolute temperature, varies directly as the total volume, expanding or contracting, and inversely as the density. This is known as the law of Gay Lussac.

With a constant volume, or density, the increase of pressure is uniformly at the rate of $\frac{1}{461}$ part of the pressure at 0° Fahr. for each degree of temperature acquired. Adding 461° to the indicated temperature, the sum, or absolute temperature, varies directly as the total pressure.

In brief, 1st, the pressure varies inversely as the volume when the temperature is constant; 2nd, the volume varies as the absolute temperature when the pressure is constant; 3rd, the pressure varies as the absolute temperature when the volume is constant.

The foregoing enunciation of the relations of temperature, pressure, and density, should be qualified by the remark, that the more easily condensable gases, as they approach the liquefying point, become sensibly more compressible than air; and that they do not strictly conform to the relations of pressure and volume belonging to the permanent gases. It has been found that, as far as 100 atmospheres, oxygen, nitrogen, hydrogen, nitric oxide, and carbonic oxide, follow the same law of compression as atmospheric air, these being amongst the incondensable gases; and that sulphurous acid, ammoniac gas, carbonic acid, and protoxide of nitrogen—proved to be condensable—commence to be sensibly more compressible than air when they have been reduced to one-third or one-fourth of their original volume. Carbonic acid, for example, in place of following the simple ratio of the pressure and density for a constant temperature, increased in density in a greater ratio than the pressure, as indicated in the following table, showing, in the third column, the volume of carbonic acid and increasing pressures relative to that of air, which is expressed by unity:—

Table of the Compressibility of Carbonic Acid, as referred to Air.
Temperature, 10° Cent., or 50° Fahr.

Pressure.	Theoretic Volumes.	Compressibility of Carbonic Acid.
Atmospheres,		Air = 1.000.
1	1000	1.000
2	500	1.000
4	250	1.000
5	200	.989
6.67	150	.980
10	100	.965
15.38	65	.934
20	50	.919
25	40	.880
33.3	30	.808
40	25	.713
45	...	Liquefied.

The deviations from unity in the last column express the deviations from the law of Boyle, as applicable to dry air at a constant temperature; and they show that, under a pressure of 40 atmospheres, carbonic acid, near the condensing point, occupied rather less than three-fourths of the volume which would have been occupied by air under the same circumstances. This accelerated density, or incipient condensation characteristic of carbonic acid and other condensable gases, in approaching the point of liquefaction, foretells the approaching change. It is, nevertheless, established that all gases, at some distance from the point of maximum density for the pressure, do virtually follow the law of Boyle, according to which the pressure and the density vary directly as each other when the temperature is constant; and, on such conditions, they rank as perfect gases.

THE GENERAL RELATIONS OF ORDINARY OR SATURATED STEAM.

The accelerated reduction of volume and increase of density, observable in the condensable gases as they approach their condensing points, hold likewise with steam. Steam produced in an ordinary boiler, over water, is generated at its maximum density and pressure for the temperature, whatever this may be. In this condition of maximum density, steam is said to be saturated, being incapable of vaporizing or absorbing more water into its substance, or increasing its pressure, so long as the temperature remains the same. Nor, on the contrary, will steam be generated with less than the maximum constituent quantity of water, which it is capable of appropriating from the liquid out of which it ascends. It stands both at the condensing point and at the generating point; so that a change in any one of the three elements of pressure, density, or temperature, is necessarily accompanied by a change of the two others. One density, one pressure, and one temperature, unalterably occur in conjunction: the same density is invariably accompanied by the same pressure and temperature.

If a part of the heat of saturated steam be withdrawn, the pressure will fall, and also the density, by the precipitation of a part of the steam in the liquid form.

If, while the temperature remains constant, the volume of steam over water be increased, then, as long as there is liquid in excess to supply fresh vapour to occupy the increased space opened for its reception, the density will not be diminished, but will, with the pressure, remain constant—the maximum density and pressure due to the temperature being maintained.

If, when all the liquid is evaporated, the fire or source of heat be removed, the pressure and density diminish when the volume is increased, as in permanent gases; and, if the volume be again reduced, the pressure and density increase until the latter returns to the maximum due to the temperature—that is to say, reaches the condensing point; and the effect of any further diminution of volume, or attempt to further increase the density at the same temperature, is simply attended by the precipitations of a portion of the vapour to the liquid state,—the density remaining the same.

On the contrary, if, when all the liquid is evaporated, the application of heat be continued, the state of saturation ceases, the temperature and pressure are increased, whilst the density remains the same: the steam is said to be superheated, or surcharged with heat, and it becomes more perfectly gaseous. And were it, whilst in this condition, to be replaced in contact with water of the original temperature, it would evaporate a part of the water, transferring to it the surcharge of heat, and would resume its normal state of saturation.

Further, let the space for steam over the water remain unaltered, then, if the temperature is raised by addition of heat, the density of the vapour is increased by fresh vaporization, and the elastic force is consequently increased in a much more rapid ratio than it would be in a permanent gas by the same change of temperature. Conversely, if the temperature be lowered, a part of the vapour is condensed, the density is diminished, and the elastic force reduced more rapidly than in a permanent gas.

An account of the special results of M. Regnault's experiments, and of the investigations and deduction, of himself and others based upon them, is given in detail in the following sections.

RELATION OF THE PRESSURE AND TEMPERATURE OF SATURATED STEAM.

The admirable investigations of the constants relating to the economical employment of steam as a motive agency, conducted by M. Regnault, may be fairly considered as affording conclusive data of all the phenomena included within the range examined, until some new discovery in science of a fundamental character shall offer additional facilities of research. The direct methods of trial and observation may, in the meantime, be regarded as exhausted, and to have yielded the full measure of accuracy of which they are susceptible. It, therefore, only remained to give effect to the results obtained by reducing them to rules of calculation, of ready application, and the most simple of which the relations admit.

One of the most important of those relations is that subsisting between the temperature and the pressure, or elasticity of the steam in contact with the fluid from which it is generated. As yet this relation has only

been expressed approximately, and by empirical formulas. The true law of connection has hitherto eluded analysis; and one is compelled to rely in most important calculations on rules which represent the law more or less distinctly, and usually over a very small portion of the curves graphically representing the pressures. There are many such rules, and some of them represent very exactly the data on which they are founded; but as these data are much less complete than those obtained from the elegant and extended researches of Regnault, it becomes necessary, even supposing the forms the most convenient, to lay aside the constants they contain, and to derive them anew from the more recent data.

There are two qualities required in a formula of this kind,—accuracy and simplicity. The first is obtainable by such a form of equation as that suggested by Laplace, which expresses the expansive force by a series arranged according to the ascending powers of the temperature. This suggestion was afterwards modified by Biot, whose form has been adopted, in the main, by Regnault, as the basis of his principal and most approved and exact formulas. The general form given by Regnault is the following:—

$$\text{Log } F = a A^\theta + b B^\theta + c C^\theta +$$

in which θ is a function of the thermometrical temperature; the other literal quantities are constants, to be determined from the series of experiments which the formula is intended to represent.

Egen's formula is also susceptible of accuracy. It is, in some measure, the inverse of that of Biot, and expresses the temperature by a series arranged according to the ascending powers of the logarithms of the elasticity.

Formulas according to these models may include any number of points of the curve of pressures, and may therefore be made to express any required degree of exactness. But such formulas become exceedingly unwieldy and inconvenient for the ordinary purposes of calculation, and they, moreover, do not admit of direct inversion. The formula of Dr. Thomas Young, on which those of Creighton, Southern, Tredgold, Mellet, Coriolis, the Commission of the French Academy, the Committee of the Franklin Institute, and others are founded, is comparatively simple in form; but it does not admit of very great exactness over any considerable extent of the curve. The expression in its most general form is

$$F = (a + b t)^m$$

This equation passes the curve through three given points, and when these are taken at no great distance apart, it may be employed to interpolate; but it cannot with safety be extended to any considerable distance beyond the assumed limits.

Another class of formulas is founded on that proposed by Professor Roche in 1828, from theoretical considerations. It expresses the elasticity by a constant number multiplied by a second constant raised to a power of which the exponent is a fraction, having the temperature in the nominator, and some function of the temperature in the denominator, thus—

$$F = a A \frac{t}{\gamma + t}$$

This form has been virtually adopted by August and Strehlke, Von Wrede, Magnus, Holtzmann, and Shortrede. It is greatly superior, as a formula of interpolation, to that of Dr. Young in extent and accuracy, and to that of Biot in point of simplicity. It approaches more nearly to the double condition of accuracy and simplicity than any other expression which has yet been proposed; and, in fact, as a practical formula applicable to calculations relative to the steam engine, leaves little to be regretted that it is not absolute. The most simple and convenient form to which this expression is reducible is, for the elastic force,

$$\text{Log } F = A - \frac{B}{t + C};$$

and the inverse formula for finding the temperature, when the pressure is given, is, accordingly,

$$t = \frac{B}{A - \text{Log } F} - C.$$

The late Mr. W. M. Buchanan, of Glasgow, adopted this general equation as the basis of his formula, of which he published an account in 1850 in the *Practical Mechanic's Journal*, and he tested it by a number of very careful determinations of the constants, from the graphic curve of pressures constructed by Regnault to represent the mean results of his experiments. He was led to conclude that no three points of that curve, which can be taken as data for the values of the constants, render the expression satisfactory throughout the entire range, experimentally represented. That range, however, extends over a space of 262° of the Centigrade scale, equal to 471.6° of Fahrenheit's thermometer—namely, from 25.6° below 0° Fahrenheit, at which the pressure is less than 0.006lb. on the square inch of surface, to 446° Fahrenheit, at which the pressure is over 400lbs. on the square

incl. Both extremes of this range are at present much beyond the limits at which a practical formula is required for calculations relating to the steam engine. The lower limit, especially, is obviously of no moment for such an object, however important it may be for other scientific purposes. Bearing in mind these considerations, Mr. Buchanan adopted a temperature of 120° Fahrenheit as the lower limit of temperature at which it is practically necessary to consider the elasticity of steam as a motive-power, and he determined the constants from that limit to the higher extremity of the given curve for the results obtained, both by the air and the mercurial thermometer. The values of these constants are arranged in the following statement:—

When the elasticity of the steam is expressed in atmospheres of 29.9212 inches of mercury = 14.68728 lb. on the square inch of surface.....	} then {	A = 5.0324128 for the air thermometer.
When the elasticity is expressed in atmospheres of 30 inches of mercury = 14.726 lb. on the square inch.....		A = 5.0312707 for the air thermometer.
When the elasticity is expressed in inches of mercury of specific gravity 13.59596, which corresponds to the density at 32° Fahr.....	} then {	A = 6.5083919 for the air thermometer.
When the elasticity is expressed in lbs. on the square inch.....		A = 6.3748274 for the mercurial ditto.
When the elasticity is expressed in lbs. on the square inch.....	} then {	A = 6.1993544 for the air thermometer.
		A = 6.0657899 for the mercurial ditto.
For the air thermometer.....		B = 2938.16.
„ mercurial thermometer.....		B = 2795.97.
„ air thermometer.....		C = 371.85.
„ mercurial thermometer.....		C = 358.74.

The formulas for *p* lb. pressure on the square inch by the two modes of measuring the temperature are, therefore—

For the Air Thermometer.

$$\log p = 6.1993544 - \frac{2938.16}{t + 371.85};$$

$$t = \frac{2938.16}{6.1993544 - \log p} - 371.85.$$

For the Mercurial Thermometer.

$$\log p = 6.0657899 - \frac{2795.97}{t + 358.74};$$

$$t = \frac{2795.97}{6.0657899 - \log p} - 358.74.$$

Mr. Buchanan observes, that “the indications by the air thermometer are greatly more to be relied upon than those of the mercurial. The air thermometer is not only more sensitive, but likewise admits of the employment of a relatively larger volume of the expanding fluid, compared with the volume of the glass envelope in which it is enclosed. The errors arising from the different expansibilities of different qualities of glass are, in consequence, much reduced relatively in amount; and, besides, the expansion of the fluid is very nearly uniform for equal increments of temperature. It is, however, the mercurial thermometer which is ordinarily employed in the measurement of temperatures, and accordingly it is of importance that the indications of the ordinary instrument should be represented by an appropriate formula. This formula, it is true, cannot possess more than an average approximation to the measurement by any particular instruments; for all thermometers made from different qualities of glass, and even when the usual fixed points are exactly and accurately determined, differ from one another at the higher temperatures. This is fully illustrated by the comparisons given by M. Regnault in his memoir on the measurement of temperature, which has been justly characterized as one of the most elegant and successful examples we possess of the combination of experimental adaptation with inductive application of the results obtained. Let us take a single line of one of the many tables furnished; it compares four of the mercurial thermometers used with each other, and with the temperature indicated by the standard air thermometer. Take the temperature of 250° C. by the standard; in the medium having that temperature, the mercurial thermometer of

Choisy-le-Roi crystal, indicated.....	253.00 C.
Ordinary glass.....	250.05
Green glass.....	251.85
Swedish glass.....	251.44

At 100° higher, namely, 350° C., by the air thermometer, the first of these four thermometers gave 360.5°, and the second 354° as the temperature of the same medium. In this, it is to be remarked, that the deviations of the ordinary glass thermometer are the least; and this is true through-

out the whole extent of the table—a circumstance which ought to attract the attention especially of the makers of these instruments. The wide differences thus shown to exist among thermometrical instruments of the very best description, render it little surprising that there should have existed very considerable discrepancies among the results obtained by different experimenters, in investigations involving the measurement of temperature. Both Regnault and Magnus have fortunately avoided this source of uncertainty in their researches relative to the elasticity of gaseous fluids, and accordingly their results agree with remarkable nearness.”

The formulas employed by Regnault to connect the temperature with the pressure of steam in a state of saturation, chiefly constructed on the model of Biot’s equation, though greatly more laborious, do not appear to be much, if in any degree, more exact than those constructed on Professor Roche’s model. The wide range over which Buchanan’s rules extend, based on Roche’s model, and the great accuracy which they exhibit within the limits for which they are determined, seem to indicate that they contain at least the first terms of the absolute law. This supposition is further countenanced by the circumstance referred to by Mr. Buchanan, that the same form expresses, better than any other the tension of the vapours of some other liquids, as ether and alcohol; and he suggests that the formula ought to contain higher powers of the temperature than the first; that it ought to take some such form as the following:—

$$F = \frac{t}{\alpha A^2 + \beta t + \gamma t^2 + \dots}$$

M. Bary applied the formula in this form, continued to the third power of *t*, to vapours.

Professor Rankine, of Glasgow, in 1849 published a formula for vapours in general, as follows:—

$$\log p = a - \frac{b}{t} - \frac{c}{t^2}$$

in which *log p* represents the logarithm of the pressure of vapour at saturation; *t*, the absolute temperature; *a, b, c*, three constants, to be determined from three experimental data for each fluid. When the pressure is expressed in inches of mercury and the temperature in degrees of Fahrenheit, the values of these constants for steam are as follows:—

$$a = 6.426421; \log b = 3.4403816; \log c = 5.5932626.$$

The inverse formula, for calculating the temperature from the pressure, is—

$$\frac{1}{t} = \sqrt{\frac{a - \log p}{c} + \frac{b^2}{4c^2} - \frac{b}{2c}}$$

in which $\frac{b}{2c} = 0.0035163, \frac{b^2}{4c^2} = 0.000012364.$

The operations of this formula are considerable, but in point of accuracy it is generally very satisfactory. Extending from – 22° to 446° of Fahrenheit’s scale, it is the most exact of all the formulæ hitherto proposed for the same width of range. It is, however, much more tedious, especially in the inverse form, and is at least not more exact than Mr. Buchanan’s formula between the same limits.

CONSTITUENT HEAT OF SATURATED STEAM.

The relation of the sensible temperature measured by the thermometer and the pressure of saturated steam having been approximately determined and formulated, the next stage of the inquiry is the relation which the sensible temperature bears to the total heat of saturated steam. The total heat of steam comprises the latent heat, in addition to the sensible heat or temperature; that which is not directly measurable by the thermometer, and therefore called latent, together with that which is directly sensible to and measurable by it. The total heat of steam would appear at first sight to be in some way related to, if not identical with, total or absolute temperature. The latter is, however, a speculative quantity, employed in the consideration of gaseous bodies, for the convenient expression of their known properties. The total heat of steam, according to the general acceptance, as defined by M. Regnault, is that quantity of heat which would be transferred to some other body in condensing the steam at the same temperature and pressure as those at which it was generated, and in cooling the condensed steam or water down to the freezing point. That is to say, conversely, if water be supplied at the freezing point of temperature, 0° Centigrade, or 32° Fahrenheit, for evaporation into steam, the total quantity of heat applied to the water and consumed in generating steam of any pressure and temperature from it, is said to be the total heat of the steam of the given pressure and temperature; and in general, whatever may be the actual temperature of the water from which the steam is generated, the total heat of the steam is reckoned from the freezing point. The adoption of the freezing-point as the zero for total heat, as well as for that of the sensible temperature in the case of the Centigrade thermometer,

is not done, of course, with any purpose of fixing an absolute datum or total constituent heat; but for convenience, being situated sufficiently low in the scale of temperature to underlie all the ordinary calculations about steam.

It was determined experimentally by Regnault, that the latent heat of saturated steam at 0° C. was 606.5° C.; so that the latent heat of 1 lb. of steam at 0° C. would raise the temperature of 606.5 lb. of cold water through 1°. The total heat of steam of 0° C. is the same as the latent heat, namely, 606.5° C.; and it was found that the total heat of saturated steam increased uniformly between the temperatures of 0° and 230° C. by .305°, with each increment of 1° of temperature. The specific heat of ordinary steam is thus .305°, that of water being = 1. The total heat H of saturated steam of any temperature t, in Centigrade degrees, is therefore expressed by the equation—

$$H = 606.5 + .305 t.$$

From this equation it appears, that, whilst the sensible heat or temperature rises 1°, the total heat increases only .305°, or less than a third of a degree. The latent heat must therefore necessarily be diminished as the temperature rises, other circumstances being the same, by as much as .305° falls short of 1°, or 1 - .305 = .695° for each degree of temperature; and the decreasing latent heat would be expressed by 606.5° - .695° t. There is one slight disturbing element, however—the specific heat of water, which is not constant for all temperatures, but is slightly increased by a rise of temperature; and by as much as the specific heat of the water is increased, the latent heat of the steam is still further diminished, and the true rate of reduction is expressed by a higher fraction than .695 t. In fact, if the specific heat of water at temperatures between 0° and 30° C. be represented by an average of unity, it will be equal to 1.005 between 30° and 120°, and 1.013 between 120° and 190° C., or 374° Fahr. M. Regnault embodies this slight rate of increase in the formula $C = 1 + .00004 t + .0000009 t^2$, in which C is the specific heat of water at any temperature t, that at 0° C., the freezing-point, being = 1. The introduction of this element into a general formula for the latent heat of steam would complicate it too much for general use; and for present purposes, the equation employed by Clausius is preferred, namely—

$$L = 607 - .708 t,$$

in which L is the latent heat due to the temperature t; and it may be noted that the co-efficient of t is slightly increased above that which would be due to a constant specific heat of water, as the deduction due to a slightly increasing specific heat. That the results afforded by the simpler equation are sufficiently near correctness, appears by the following comparative instances of its application at different temperatures by Fahrenheit's scale, as against the use of Regnault's correct but more complicated process:—

	100°	200°	212°	300°	400° F.
By Clausius L =	1044.4	973.6	965.1	902.8	832
By Regnault..... L =	1044.47	974	965.7	902.9	829.84

In estimating the latent heat of steam at 100° C., or 212° Fahr., Regnault found, that on account of the slight variation of the specific heat of water, 100.5 Centigrade units, or 180.9 Fahrenheit units of heat were required to raise the unit of water from 0° to 100° C., or through 180° Fahr.; and he found that the total heat of steam at 100° C. was 636.67° C. From this deduct 100.5°, and the difference, 636.67 - 100.5 = 536.17° C., represents the true latent heat of steam at 100° C. But as, in the compilation of his tables, Regnault started with the integral number 637°, the latent heat of saturated steam at 100° C., or 212° Fahr., is estimated by him at 536.5° C. = 965.7° Fahr.

To modify the formula for the total heat of steam, in terms of Fahrenheit degrees, 606.5° C. × 9 ÷ 5 = 1091.7° Fahr., is the total heat at 32° Fahr.; and as t represents the indicated temperature, the total heat would be expressed by 1091.7 + .305 (t - 32), or, in a more general form, by (1123.7 - 32) + (.305 t - 9.76) = (1113.94 - 32) + .305 t. The first element in this expression should be reduced to 1113.4, in order to produce exact conformity with the observed total heat at 212° Fahr., Regnault's starting point; and the formula for the total heat, in terms of Fahrenheit degrees, becomes,

$$H = (1113.4 - 32) + .305 t; \text{ or,}$$

$$H = 1081.4 + .305 t.$$

By this equation, the total heat of steam generated at 212° Fahr. is equal to 1113.4 - 32 + (.305 × 212) = 1146° Fahr.; and this represents what would be consumption of heat in generating the steam, if the water were supplied at 32° Fahr. By means of the same form of equation, the total expenditure of heat consumed in raising steam from water supplied at ordinary temperatures may be calculated, by substituting for 32 in the formula, the initial temperature of the water supplied for evaporation, subject to an allowance, if deemed sufficiently important, for the slight increase specific heat of the water of higher temperature. Thus, when the water supplied at 62° Fahr., the average temperature of cold water, the extra

specific heat may be neglected, and the heat expended in generating steam from the water is expressed by the equation,

$$H_1 = (1113.4 - 62) + .305 t; \text{ or,}$$

$$H_1 = 1051.4 + .305 t.$$

If, as in condensing engines, the water be supplied at, say 100° Fahr., the heat expended in generating steam from it, again neglecting the specific heat, is expressed as follows:—

$$H_2 = (1113.4 - 100) + .305 t; \text{ or,}$$

$$H_2 = 1013.4 + .305 t.$$

Again, if the water be supplied at a boiling temperature, 212° Fahr., the specific heat of the water at 212°, as already noted, would be .9 unit or degree of heat in excess of that at 32°, and 212 + .9 = 212.9° should be substituted. Hence for an initial temperature of 212° Fahr., the expenditure of heat in generating steam would be

$$H_3 = (1113.4 - 212.9) + .305 t; \text{ or,}$$

$$H_3 = 900.5 + .305 t.$$

To convert Clausius's formula for the latent heat of steam, namely, $L = 607 - .708 t$, into Fahrenheit's measure, 607° C. + 9 ÷ 5 = 1092.6° Fahr., and for t° C. substitute (t - 32) Fahr., then $L = 1092.6° - .708 (t - 32)$ Fahr., or finally, by the Fahrenheit scale,

$$L = 1115.2 - .708 t.$$

It is convenient to bear in mind that the same figures which express in degrees the relations of the constituent heat of steam, as ratios simply, not as absolute quantities, express also positive values—in units of heat—when applied to 1 lb. weight of steam, in accordance with the definition of the heat unit, or the thermal unit. Now, to trace the appropriation of all the heat which contributes to the formation of a pound of steam, in terms of thermal units, as well as of dynamic units or foot-pounds, take 1 lb. of water at 32° Fahr., to be converted into saturated steam at 212°. The first instalment of heat is provided to elevate the temperature to 212°, through 180°; in other words, to increase the molecular velocity and slightly expand the liquid, which appropriates 180.9 units of heat, equivalent to 180.9 × 772 = 139655 foot-pounds. Secondly, heat is absorbed in overcoming the molecular attraction, and separating the particles; that is, in the formation of steam, appropriating 892.8 units of heat = 689,242 foot-pounds. Thirdly, in repelling the incumbent pressure, whether of the atmosphere or of the neighbouring steam; that is, to raise a load of 14.7 lb. per square inch, or 2116.8 lb. on a square foot, through a cubic space of 26.36 cubic feet, which is the volume of 1 lb. of saturated steam: equal to 55,815 foot-pounds, or 72.3 units of heat. Strictly, there is the initial volume of the original pound of water to be deducted from this total volume; but it is relatively small, and need not be further considered. The second of the above proportions of heat is formed by subtracting the sum of the first and third, which are both arrived at by direct observation, from the total heat. The first is the sensible heat, and the second and third together constitute the latent heat. With respect to the third constituent proportion of heat, it is simply an expression of the necessary mechanical labour of disengaging 26.36 cubic feet of steam, and forcing its way into space against a pressure of 2116.8 lb. per square foot; and these quantities being multiplied together and divided by 772 are equivalent to 72.3 units of heat.

The proportions of the heat expended in generating saturated steam at 212° Fahr., and at 14.7 lb. pressure per square inch, from water supplied at 32°, may be exhibited thus:—

	Units of Heat.	Mechanical Equivalent in foot-pounds.
THE SENSIBLE HEAT:—		
1. To raise the temperature of the water from 32° to 212°, through 180°.....	180.9	or 139,655
THE LATENT HEAT:—		
2. In the formation of steam.....	892.8	„ 689,242
3. In resisting the incumbent pressure 14.7 lb. per square inch, or 2116.8 lb. per square foot.....	72.3	„ 55,815
Latent heat	965.1	„ 745,057
Total heat.....	1146.0	„ 884,712

Supposing, however, that 1 lb. of water, at 32° Fahr., were injected into a vacuum space or vessel, having 26.36 cubic feet of capacity. If heat were applied to evaporate this water into steam of 212°, and 14.7 lb per square inch pressure, so as to fill the whole space with saturated steam, the expenditure of heat would consist only of the sensible heat, to raise the temperature of the water 180.9 units, plus the latent heat for the formation of the steam, 892.8 units, = 1073.7 units, as in this case there would be no incumbent pressure to resist, and no extraneous work. But, again, let a second pound of water be injected into the same vessel, already full of steam, to be evaporated into steam of 14.7 lb. pressure per square inch, so that the vapour of the second pound of water must expel the first, a

uniform pressure of 14.7 lb. per square inch being maintained within the vessel. The expenditure of heat in the generation of the second pound will be 72.3 units in excess of that required for the first pound, being the additional quantity required to repel the incumbent pressure; and the total expenditure will be 1146 units. The 72.3 units excess of heat expended on the second pound of steam disappears, or rather it does not appear as heat, but is transformed into the work of expelling the first pound of steam; and, after its production, the second pound contains just the same quantity of heat as the first, namely, 1073.7 units, which may be proved by condensing them both into water of 32° Fahr.

The latent heat of steam, then, is not, as is sometimes supposed, an expression of the total work or energy in the steam; but is the work expended in overcoming the attraction of the particles, forcing them asunder, together with the work expended in repelling the external pressure under which the steam is generated. As the temperature rises, the centrifugal velocity, or vibratory motion of the minute particles is accelerated, the liquid expands, and the attraction of the particles is consequently diminished. Hence that part of the latent heat, or work, expended in effecting an entire separation of the articles, diminishes as the temperature rises. When water is evaporated at a low temperature, it is obvious that the particles are held together by a greater force than if it were evaporated at a higher temperature, after heat has been expended in accelerating the velocity of the particles, and expanding the liquid; and less work is expended in effecting their separation. At high temperatures the particles are already in part separated; they have a less hold on each other, and consequently an entire separation is more easily completed at higher than at lower temperatures. On the contrary, the second, but inferior portion of latent heat expended in repelling the external resistance—the product of increasing pressure into diminishing volume—increases slowly as the temperature rises; but the increase in this respect is less than the decrease in respect of the chief duty of the latent heat. In this manner it is to be explained, that though the total constituent heat of steam slowly increases as the temperature rises, in consequence of the comparative rapidity with which the sensible heat increases, the latent heat slowly diminishes as the temperature is elevated.—From the *Encyclopædia Britannica*.

DIMENSIONS, ETC., OF AMERICAN STEAMERS.

THE STEAMER "HANKOW."

Hull built by Thomas Collyer, Engine by Morgan Iron Works, New York.

DIMENSIONS.—Length on deck, 212ft.; do. at load line, 211ft.; breadth of beam (molded), 30ft. 6in.; depth of hold, 11ft. 4in.; depth of hold to spar deck, 11ft. 4in.; area of immersed section at load draft of 7ft., 190 square feet. Tonnage of hull and engine room, 717 tons.

ENGINE.—Vertical beam engine; return tubular boilers; diam. of cylinder, 48in.; length of stroke, 12ft.; diam. of paddle-wheel over boards, 29ft.; 26 paddle-floats—length, 7ft. 6in.; depth, 2ft.; 2 boilers—length, 20ft.; breadth, 11ft.; height of do. exclusive of steam chest, 9ft.; 2 furnaces, breadth, 4ft. 9in.; length of grate bars, 7ft.; 64 tubes in each boiler; 10 flues; internal diam. of tubes, 5½in.; do. flues, 8 of 12½in., two of 15½in.; length of tubes, 14ft.; do. flues, 7ft. 10in.; diam. of smoke pipe, 5ft. 4in.; height, 45ft.; draft, fore and aft, 7ft.; grate surface, 102.09ft.; heating surface, 3216 sq. ft.; point of cutting off, variable.

DESCRIPTION.—Frames (molded), 14in.; sided, 7in., 27½in. apart from centres, and strapped with diagonal and clinch-laid braces, 3½ × ½in.; depth of keel, 4in.; 1 independent steam, fire, and bilge pump, and boiler; 2 masts, schooner rigged; paddle-wheel guards extend fore and aft; enclosed fore-castle; intended service, coast of China.

THE U.S. SCREW STEAMER "SEMINOLE."

Hull built by U. S. Government, Engines by Morgan Iron Works, New York.

DIMENSIONS.—Length at load line, 200ft.; breadth of beam (molded), 28ft.; depth of hold to spar deck, 14ft.; length of engine room, coal bunkers, &c., 48ft.; area of immersed section at load draft of 10ft., 264ft. Tonnage of hull and engine room, 755 tons.

ENGINES.—Two horizontal stepple engines; vertical tubular boilers; 2 cylinders, 50in. diam.; length of stroke, 2ft. 6in.; two-bladed screw; diam. of screw, 9ft. 6in.; pitch, do., 18ft.; 2 boilers—length, 22ft.; breadth, 10ft. 6in.; height, exclusive of steam chest, 10ft. 3in.; 12 furnaces—breadth, 3ft.; length of grate bars, 5ft. 6in.; 3685 tubes; internal diam. of do., 2in.; length of do., 2ft. 7½in.; diam. of smoke pipe, 6ft.; height, 42ft.; draft, fore and aft, 10ft.; maximum pressure of steam, 60lb.; point of cutting off, half-stroke; maximum revolutions at above pressure, 80; speed in knots, 9.

DESCRIPTION.—One independent steam and bilge pump, and 1 donkey; 3 masts, bark rigged; 2 bulkheads; capacity of coal bunkers, 220 tons; date of trial, May, 1860.

THE STEAMER "ZOUAVE."

Hull built by John Inglis, Engines by Morgan Iron Works, New York.

DIMENSIONS.—Length on deck, 220ft.; breadth of beam (molded), 30ft. 8in.; depth of hold to spar deck, 12ft. 3in.; area of immersed section at load draft of 6ft. 6in., 175 sq. ft. Tonnage of hull and engine room, 800 tons.

ENGINE.—Vertical beam engine; return flue boiler; diam. of cylinder, 50in.; length of stroke, 11ft.; diam. of paddle-wheel over boards, 31ft.; 27 paddle-floats

—length, 7ft.; depth, 2ft.; 1 boiler—length, 27ft.; breadth (front), 13ft.; height, exclusive of steam chimney, 11ft. 3in.; 2 furnaces—breadth, 5ft. 9½in.; length of grate bars, 7ft. 6in.; 10 flues below, 2 of 22½ft., 4, each 15 and 17in.; 20 flues above, 10, each 8½ and 9½in.; length, above, 20ft. 8in., below, 14ft.; diam. of smoke pipe, 52in.; draft, fore and aft, 6ft. 6in.; point of cutting off, one-half.

DESCRIPTION.—Frames (molded), 14in.; sided, 6in.; 24in. apart from centres, and strapped with diagonal and double-laid braces, 4 × ½in.; 1 independent steam, fire, and bilge pump; 2 masts, schooner rigged; one bulkhead; promenade deck, with saloon, cabin, and state rooms; date of trial, November, 1860.

THE STEAMER "NEW BRUNSWICK."

Hull built by John Inglis, Engine by Morgan Iron Works, New York.

DIMENSIONS.—Length on deck, 224ft.; breadth of beam (molded), 30ft. 8in.; depth of hold to spar deck, 12ft.; area of immersed section at load draft of 6ft. 6in., 175 sq. ft. Tonnage of hull and engine room, 815 tons.

ENGINE.—Vertical beam engine; return flue boiler; diam. of cylinder, 48in.; length of stroke, 11ft.; diam. of paddle-wheel over boards, 31ft.; 27 paddle-floats—length, 7ft.; depth, 1ft. 10in.; 1 boiler—length, 26ft. 2in.; breadth (front), 13ft.; height, exclusive of steam chest, 11ft. 6½in.; 2 furnaces, length of grate bars, 7ft. 6in.; breadth, 5ft. 9½in.; 6 flues above, 10 below; internal diam. above, 1ft. 5in.; do. below, 2 of 22½ft., 4 each 15 and 17in.; length, above, 18ft. 6½in.; do. below, 13ft. 2in.; diam. of smoke pipe, 4ft. 4in.; draft, fore and aft, 6ft. 6in.; point of cutting off, variable.

DESCRIPTION.—Frames (molded), 14in.; sided, 6in.; 24in. apart from centres, and strapped with diagonal and double-laid braces, 4 × ½in.; independent steam, fire, and bilge pumps; 2 masts, schooner rigged; 1 bulkhead; promenade deck, with saloon, cabin, and state rooms; date of trial, October, 1860; intended service, Portland to St. John's, N.B.

THE STEAMER "DANIEL DREW."

Hull built by Thomas Collyer, Engines by Neptune Iron Works, New York.

DIMENSIONS.—Length on deck, 251ft. 8in.; do. at load line, 244ft.; breadth of beam (molded), 30ft. 6in.; depth of hold to spar deck, 9ft. 3in.

ENGINE.—Vertical beam engine; return flue boilers; diam. of cylinders, 60in.; length of stroke, 10ft.; diam. of paddle-wheel over boards, 29ft.; 24 paddle-floats—length, 9ft.; depth, 2ft. 2in.; 2 boilers—length, 29ft.; breadth at furnace, 9ft.; do. at shell, 8ft.; height, exclusive of steam chest, 9ft. 4in.; 2 furnaces; length of grate bars, 7ft.; 14 flues above, 10 below; internal diam. above, 9½in.; below, 2 of 13½in., 1 of 13in.; 1 of 11in., 1 of 7½in.; length, above, 22ft.; diam. of smoke pipes, 4ft.; height, 32ft.; draft, fore and aft, 4ft. 6in.; heating surface, 3350 sq. ft.; maximum pressure of steam, 35lb.; point of cutting off, one-half; maximum revolutions at above pressure, 26.

DESCRIPTION.—Frames (molded), 15½in.; sided, 4in.; 30in. apart from centres; depth of keel, 3ft.; one independent steam, fire, and bilge pump; date of trial, May, 1860; intended service, New York to Albany. This steamer has been built to attain very high speed, having a very easy and a very superior model. The velocity of the periphery of her water-wheel blades is 27 miles per hour.

THE STEAMER "FIRE DART."

Hull built by Thomas Collyer, Engine by Neptune Iron Works, New York.

DIMENSIONS.—Length on deck, 200ft.; do. at load line, 200ft.; breadth of beam (molded), 30ft.; depth of hold, 11ft.; depth of hold to spar deck, 11ft. 3in.; area of immersed section at load draft of 5ft. 6in., 143 sq. ft. Tonnage of hull and engine room, 650 tons.

ENGINE.—Vertical beam engine; return flue boilers; diam. of cylinder, 46½in.; length of stroke, 12ft.; diam. of paddle-wheel over boards 28ft.; 24 paddle-floats—length, 8ft.; depth, 2ft.; 2 boilers—length, 27ft.; breadth at furnace, 9ft. 9in., do. at shell, 8ft. 9in.; height, exclusive of steam chest, 8ft. 9in.; 2 furnaces in each boiler; breadth, 4ft. 3in.; length of grate bars, 7ft.; 14 flues above, 10 below; internal diam. of do. above, 7in.; below, 6 of 12in., 2 of 14in., 2 of 16in.; length above, 19ft. 6in.; do. below, 14ft.; diam. of smoke pipe, 6ft.; height, 42ft.; draft, fore and aft, 5ft. 6in.; grate surface, 120 sq. ft.; heating surface, 3259 sq. ft.; point of cutting off, variable.

DESCRIPTION.—Frames (molded), 14in.; sided, 5in.; 26in. apart from centres, and strapped with diagonal and double-laid braces, 3½in. × ½in.; depth of keel, 4in.; 1 independent steam, fire, and bilge pump; two masts, schooner rigged; paddle-wheel guards do not extend forward, but are continued aft for half-width, and sponsoned; enclosed fore-castle; date of trial, November, 1860; intended service, coast of China.

THE STEAMER "PRIMEIRA."

Hull built by Webb & Bell, Engine by Novelty Iron Works, New York.

DIMENSIONS.—Length on deck, 130ft.; do. at load line, 128ft.; breadth of beam, 28ft.; depth of hold, 10ft.; depth of hold at ends, 9ft. 6in.; area of immersed section at load draft of 6ft., 140 sq. ft. Tonnage of hull and engine room, 320 tons.

ENGINE.—Vertical beam engine; drop flue boiler; diam. of cylinder, 32in.; length of stroke, 8ft.; diam. of paddle-wheel over boards, 16ft.; 14 paddle-floats—length, 6ft. 7in.; depth, 2ft.; 1 boiler—length, 21ft.; breadth, 8ft. 4in.; height, exclusive of steam chest, 8ft. 4in.; 1 furnace—length of grate bars, 5ft. 4in.; 5 flues above fire, 5 in centre, 4 below; internal diam. of do. above, 1ft. 3½in.; in centre, 1ft. 3in.; below, 2 of 21, 2 of 11½in.; length above, 11ft. 4in.; do. in centre, 8ft. 9in.; do. below, 10ft. 10in.; diam. of smoke pipe, 40in.; height, 38ft.; draft, fore and aft, 6ft.; grate surface, 34 sq. ft.; heating surface, 900 sq. ft.; point of cutting off, variable.

DESCRIPTION.—Frames (molded), 13in.; sided, 9in.; 24in. apart from centres; depth of keel, 6in.; date of trial, October, 1860; intended service, at Rio Janeiro. The first of three ferry-boats to ply in the harbour of Rio Janeiro.

THE STEAMER "JOHN P. KING."

Hull built by J. A. Westervelt & Sons, Engine by Allaire Works, New York.

DIMENSIONS.—Length on deck, 235ft.; do. at load line, 233ft.; breadth of beam (molded), 36ft. 4in.; depth of hold, 13ft. 3in.; depth of hold to spar deck, 20ft. 9in.; area of immersed section at load draft of 12ft., 371 sq. ft. Tonnage of hull and engine room, 1740 tons.

ENGINE.—Vertical beam engine; return flue boilers; diam. of cylinder, 71in.; length of stroke, 12ft.; diameter of paddle-wheel over boards, 28ft.; 24 paddle-floats—length, 10ft.; depth, 1ft. 9in.; two boilers—length, 26ft.; breadth, 12ft. 2in.; height, exclusive of steam chest, 12ft. 2in.; 5 furnaces in each boiler; breadth, 3ft.; length of grate bars, 7ft. 3in.; 18 fines above, 15 below; internal diam. of do. above, 8 of 13in., 8 of 11in., 2 of 10in.; do. below, 1ft. 3in.; length of do. above, 19ft. 4in.; do. below, 12ft. 7in.; diam. of smoke pipe, 7ft.; height, 60ft.; draft, fore and aft, 12ft.; grate surface, 225 sq. ft.; heating surface, 5422 sq. ft.; maximum pressure of steam, 30lb.; point of cutting off, variable.

DESCRIPTION.—Frames (molded), 15in.; sided, 14in.; 30in. apart from centres; depth of keel, 11in.; 2 masts, schooner rigged; launching draft, 7ft. 8in.; date of trial, October, 1860; intended service, New York to Charleston, S.C.

THE SCREW STEAM TOW-BOATS "RESOLUTE" AND "RELIANCE."

Hulls built by B. C. Terry, New Jersey; Engines by Cobb & Fields, Jersey City.

DIMENSIONS.—Length on deck, 93ft.; do. at load line, 93ft.; breadth of beam, 16ft.; depth of hold to spar deck, 7ft. 6in.; area of immersed section at load draft of 8ft., 65 sq. ft. Tonnage, 100 tons.

ENGINES.—Vertical direct engines, with return tubular boiler; diam. of cylinders, 17in.; length of stroke, 17in.; 4 blades of screw—diam., 7ft. 8in.; length, 5ft. 6in.; pitch, 14ft.; 1 boiler—length, 15ft.; breadth, 6ft. 8in.; height, exclusive of steam chest, 8ft.; 2 furnaces—breadth, 3ft. 4in.; length of grate bars, 6ft. 8in.; 58 tubes, 6 fines; internal diam. of tubes, 4in.; do. flues, 2 of 10in., 4 of 6in.; length of tubes, 10ft. 4in.; do. flues, 6ft. 10in.; diam. of smoke pipe, 3ft. 2in.; height, 12ft.; draft, forward, 5ft.; aft, 8ft.; grate surface, 48 sq. ft.; heating surface, 2500 sq. ft.; consumption of fuel per hour, $\frac{1}{4}$ ton; maximum pressure of steam, 100lb.; average do. 75lb.; point of cutting off, half-stroke; average revolutions at above pressure, 95; speed in miles with tide in 61 minutes, 17.5; do. against, in 61 minutes, 12.5; weight of engines, 20,160lb.; do. boilers, without water, 18,000lb.; do. with water, 29,180lb.

DESCRIPTION.—Frames (molded), 8in.; sided, 5in.; 12in. apart from centres; depth of keel, 12in.; date of trial, September, 1860; intended service, New York Harbour.

THE STEAM FERRY-BOAT "JOHN P. JACKSON."

Hull built by O. Burtis, Engine by Wm. Birkbeck, Jersey City, N.J.

DIMENSIONS.—Length on deck, 210ft.; do. at load line, 210ft.; breadth of beam (molded), 33ft.; depth of hold, 13ft.; depth of hold to spar deck, 13ft.; area of immersed section at load draft of 5ft. 6in., 140 sq. ft. Tonnage of hull and engine room, 858 tons.

ENGINE.—Vertical beam engine; drop flue, round shell boiler; diam. of cylinder, 45in.; length of stroke, 11ft.; diam. of paddle-wheel over boards, 21ft.; 18 paddle-floats—length, 9ft.; depth, 2 of 12in.; 1 boiler—length, 30ft.; breadth, 10ft.; height, exclusive of steam chest, 10ft.; 2 furnaces—length of grate bars, 6ft.; 6 flues above, 6 in centre, 4 below; internal diam. of do. above, 15 $\frac{1}{2}$ in.; in centre, 15in.; below, 1 of 23in., 1 of 14in.; length, above, 18ft.; in centre, 15ft. 10in.; below, 17ft. 10in.; diam. of smoke pipe, 4ft. 6in.; height, 48ft.; draft, fore and aft, 5ft. 6in.

DESCRIPTION.—Frames (molded), 14in.; sided, 6in.; 12in. apart from centres; depth of keel, 11in.; date of trial, October, 1860; intended service, New York to New Jersey.

INSTITUTION OF CIVIL ENGINEERS.

January 22, 1861.—GEORGE P. BIDDER, Esq., PRESIDENT, in the Chair.

ON THE RISE AND FALL OF THE RIVER WANDLE: ITS SPRINGS, TRIBUTARIES, AND POLLUTION.

By Mr. FREDERICK BRAITHWAITE, M. Inst. C.E.

This history was compiled from a survey of the River Wandle, made early in the spring of the year 1853, from its rise at Carshalton, and at Croydon, 111 feet 2 inches and 123 feet 10 inches respectively above Trinity high water-mark (T. H. W. M.), to its outfall in the Thames at Wandsworth. In the course of the survey, special notes were taken of the several springs, tributaries, and sewerage from drains, which swelled the amount of the water. The levels of the successive falls of the river from its spring-heads, through the numerous mills, were carefully taken; also, a complete set of gangings of the water from the numerous springs and tributaries.

The branch of the river rising at Carshalton was said to be supplied from three principal springs, the Grotto Springs, the Hogs' Pit Pond, and the Ordnance Pond, which together yielded, when the gangings were first taken, 13,246,020 gallons, and on a subsequent occasion 12,670,610 gallons daily, or every twenty-four hours. The head of water at the lake in the grounds attached to the Ordnance School, varied 4 or 5 inches, according to the rainfall. When the lake was emptied, it was refilled from the springs in thirty hours. This branch was also supplied from the Town Ponds and other springs. Five mills were situated on it, driven by wheels, having a united power of 71 H.P. The general character of the water was brilliant and pure, with the exception of that from the paper mills, and where the road drainage was discharged into the river, after heavy rains. The water contained about 16° of hardness, and a small quantity of sulphate of lime.

The Croydon branch derived its principal flow of water from a stream called the Bourne Brook, which rose in Marden Park, about 8 miles south of Croydon.

The supply from this source was, however, very precarious, as it did not flow more than once every five or seven years, when the rainfall was excessive, and then only lasted for a limited period; though it was in evidence, that the Bourne did run for two entire years in 1841 and 1842, a period of great rain. Two other streams united with the Bourne about 2 miles south of Croydon, which, with springs rising in the Garden Pond and elsewhere at Croydon, brought up the total quantity to, from 16,158,780 to 17,625,600 gallons daily. Other springs, issuing principally in the Lauds Ponds, contributed about 1,458,000 gallons every twenty-four hours; so that, when all the streams had united to form the eastern branch of the Wandle, 123 feet 10 inches above T.H.W.M., the river flowed at more than the rate of 19,000,000 gallons every twenty-four hours. The springs at Wadden Mill, and from land drainage, produced about 1,200,000 gallons, and the river was constantly increased from similar sources, so that, when united with the Carshalton branch, at the Oil and Felt Mills, above Hack Bridge, the gangings, which represented the entire flow of the Wandle in one stream, when first taken showed 63,488,520 gallons, and, on the subsequent occasion, 52,750,980 gallons, every twenty-four hours. The mills on this branch were four in number, but three only were in occupation at the time the survey was made, using water power equal to 25, 25, and 12 H.P. respectively. Above Hack Bridge the soil consisted of a mixture of chalk and gravel; but below the bridge it was wholly gravel or sand, though there was clay close underneath.

The Paper then proceeded to notice the different mills situated on the main stream, giving a statement of their power, height above T.H.W.M., in many cases the quantity of water used at each, and other details. The operations carried on at some of these works, such as rinsing silk goods, washing skins, &c., and the chemicals employed, which when used were discharged into the river, tended materially to contaminate the stream. Indeed, it was generally remarked, that the water below all the print works was much coloured when any print-washing was going on. The colour did not appear to settle, it only became largely diffused. The water used for cleaning the blocks was also sent into the river. In clear weather, the contrast between the water at the Carshalton springs and that at Merton bridge was very marked; proving to the sight alone, how unfit the water had become for drinking purposes, during its progress through so many works discharging impurities, and over such a soil, and receiving such drainage. In dry seasons this would be still more striking. There were twenty-five mills on the main stream, using 545 H.P.

Mention was also made of the amount of drainage water flowing into the Wandle from the surrounding land, one stream alone, on the eastern side of the river, at Mitcham common, contributing 4,172,760 gallons daily. The Pickle, a dirty stream, joined the main river at Merton Bridge, and the Graveney, a considerable tributary, which had also a dirty appearance when the water in the itself was comparatively clear, entered the river at Mr. Payton's leather works. The average gangings at Garratt's oil mills showed 83,469,060, 76,316,950, and 62,343,000 gallons, every twenty-four hours. The gangings of the river Graveney, during the same period, showed from 6,291,000 to 1,458,000 gallons daily. These quantities referred to a period when the river, its bed, and adjacent soil had been fully saturated with heavy rains, and afforded no criterion of the quantity due to dry seasons. The water in gravelly districts at such times was much wasted. Then that stratum not only refused to part with it freely, but even deprived the river itself of water, which flowed down from a district less influenced by evaporation. It might, therefore, be concluded, that in periods of drought, the true source of the supply to the Wandle would be found at Wadden and at Carshalton only; for the Bourne Brook became dry, and the Croydon springs were polluted. At present the supply from Wadden and Carshalton was found to amount to 32,941,800 gallons daily; but when the land springs and other drainage waters were exhausted, there only remained 18,367,920 gallons daily available for water supply, supposing the flow from the chalk to continue uniform. But when the river reached Wandsworth, much of the water had been evaporated and filtered into the gravelly soil, and much had been filtered and carried away as sewerage, or been consumed in the works, so that probably not more than 10,000,000 gallons could be relied upon, and that must necessarily be polluted.

In an Appendix a table was given, showing the rainfall daily during the months of September, October, November, and December, 1852, over that portion of the district, the nature of the soil of which was not absorbent, viz. the tract of land drained by the river Graveney and the Collier Brook, having an area of 4900 acres. The available water-shed area of the Wandle, in addition to this, amounted to 12,935 acres, and the length of the river, from Croydon to Wandsworth, was rather less than 9 $\frac{1}{2}$ miles. The entire details of the survey were also given in a tabular form.

LONDON ASSOCIATION OF FOREMEN ENGINEERS.

On the 2nd ult., the ordinary monthly meeting of this association took place at their rooms, St. Swithin's-lane, City. Mr. Joseph Newton, of the Royal Mint, President, occupied the chair. Mr. John Briggs read his paper on the "Resistance of Cast Iron to Internal Pressure." He commenced the subject by stating that he considered cast iron to be the most deceptive of all metals, for in addition to its liability to unsoundness in the process of casting, and fracture from unequal expansion, it was affected injuriously from a variety of other causes. Pig iron was iron in its most impure state, for it was contaminated by all the impurities which were capable of combining with it in its primitive form as ore, and which chemical affinity prevented its parting with it in the process of smelting. Frequently, indeed, it was found that the same charge yielded iron of totally different qualities. It had occurred to the reader of the paper that some of the impurities which thus interfered with the character of cast iron were actually other metals, and modern chemistry supported the theory. Many mineral productions, which were formerly considered simple substances, had been proved to have metallic bases, from which had been obtained metals; for example—

aluminium, barytum, magnesium, calcium, and silicium. Then, again, manganese, which abounded in the Bowling and Low Moor irons, and which gave them their superiority for solidity and strength, and caused them to be largely used in the manufacture of heavy guus, might be mentioned. There were several other elements, such as carbon, sulphur, and phosphorus, which were or less affected the character of cast iron. The first-named gave fluidity and softness to the iron, while sulphur and phosphorus were the greatest enemies it had to contend against.

These were the primary points which those who employed cast iron in the construction of cylinders intended to resist great internal pressure—whether in the shape of pieces of ordnance, or of hydraulic presses—had to deal with; and perhaps no one had laboured more zealously to comprehend and explain them than had one of their own members, when employed at Woolwich Arsenal. The existence of the various substances and elements he had named, was doubtless due to the peculiarities of the localities in which the ore was obtained. In addition, however, he must be permitted to say that the constitution of cast iron was materially affected by the manner of smelting it. It was necessary to exercise great care in this operation, and in making proper selections of different kinds of iron for particular purposes. The judgment of the ironfounder must be largely relied on in this case; and it was well when that judgment was not at fault. Without detaining the meeting further, he should now reiterate the assertion that cast iron was the most deceptive of all metals, and required to be dealt with accordingly.

There was a limit to the pressure which should be put internally to cast iron, and there was, he was bold to assert, a limit also to the thickness of metal to be used for the cylinders of hydraulic presses. Such a statement might, at the first blush, appear to be irrational. The general opinion would undoubtedly be that the thicker the iron, the greater its resistance to pressure where the bore remained the same size. This he believed not to be the case, and Mr. Joseph Bramah had held long ago the same opinion. At the time that one of the press cylinders employed in raising the tubes of the Britannia-bridge had burst asunder, a workman, once in the employment of Messrs. Bramah, thus wrote to a weekly mechanical journal (Sept. 29th, 1849):—"At Bramah's we never found presses in constant work stand more than three tons (6720lbs.) on the square inch, and the greatest pains were taken to obtain the most approved kinds of iron—mixed qualities—to cast the cylinders from. I have seen press cylinders stand 7000 and even 8000lbs. on the square inch under proof for a short time; but we never could trust them to work with so much, and cast iron then was far superior to that of the present day. *Increasing the thickness of the metal in press cylinders was seldom successful.* I have known metal seven inches thick stand as well as that 10½ inches, for presses with rams 10 inches diameter. The thicker the metal, the greater appeared to be the difficulty in getting it equal and homogeneous throughout." The writer of the foregoing had assisted in the construction of upwards of 100 hydraulic presses at Bramah's, and his remarks came with all the weight, therefore, of authority based on experience. For himself, he must say that his own experience, though more limited in extent, confirmed him in a like opinion. He, indeed, almost thought that the error at present consisted in making such cylinders too thick. If the metal were used thinner, there would be more certainty of obtaining castings of greater density and uniformity, and therefore better calculated to sustain pressure. There were next adduced some instances of fractured cylinders, and referred to a list which he had, in a former paper, laid before the meeting. Experiment and experience, then, alike induced him to believe that there should be a limit to the thickness of all cylinders intended to resist high pressures.

Some examples touching the maximum of pressure to be employed were adverted to, and much information of a practical nature was given in relation to this part of the subject. The general conclusions were that three tons per circular inch were to be the bursting pressure of press cylinders. The maximum thickness of metal, when all due care had been exercised in its composition, should not be more than the radius of the bore of the cylinder. Two tons per circular inch was a safe pressure to work up to, and this was pronounced to be the standard. With these deductions, and with the announcement that at the next monthly meeting he would pursue the questions as to how the pressure is distributed, the commencement of fracture, the line of fracture, the direction of the forces within the cylinders, and introduce the opinions of the late Mr. Robert Stephenson, Mr. Briggs brought his valuable remarks to a close.

REVIEWS AND NOTICES OF NEW BOOKS.

The Economy of Steam Power on Common Roads in relation to Agriculturists, Railway Companies, Mine and Coal Owners, Quarry Proprietors, Contractors, &c., with its History and Practice in Great Britain, by CHARLES FREDERIC T. YOUNG, C. E., *Memb. Soc. Engineers; and its Progress in the United States,* by ALEX. L. HOLLEY, C. E., and J. K. FISHER, Engineers, New York. Illustrated with Engravings by J. H. RIMBAULT (444 pp. 8vo. 12s. 6d.). London: Atchley & Co.

(THIRD NOTICE.)

Having given an interesting account, interspersed with engravings, of the working of the different steam coaches that for several years were successfully used in the metropolis and various parts of the country, the author proceeds to consider the subject of "Concentrated Weight," as he terms it, by which he means, carrying a heavy weight on an ordinary wheel, without anything between the wheel and the surface of the ground. He objects strongly to the employment of this system for general use, or where the ground or roads are not solid, on account of the want of adhesion for drawing a load, and the damage caused to the road or ground under such circumstances; and to show that this is found to be really the case

in practice, he summons to his aid a few of the plans gathered from the patents of those who have found this to be so in using steam engines, which certainly do show that the author's views are correct on this subject. We may remark, however, in confirmation of the views he has taken, that on hard ground, or roads, the system does work and do no harm to the surface, so long as the wheels are not provided with teeth, or do not slip round and tear it up. In all such cases we do not see any necessity to seek for a better system than that of a wide wheel bearing on a hard road; but it becomes of great and serious importance to have a *proper and well-constructed engine*, one fit for the work, and not a "blown together" affair, which tumbles to pieces after a few days' use, and exhibits neither design, workmanship, or any of the numerous points needed in a really efficient and useful engine. It is to be lamented, however, that so few engineers have of late years turned their attention to the designing and making of these engines, as a vast field is open in this direction to enterprise and perseverance; but it is possible that the want of practical knowledge amongst engineers on this peculiar subject, arising chiefly from the neglect with which they have treated all attempts at progress in this direction, accounts for it. Having shown the damage done by the system of "concentrated weight," where used without due regard to the requirements of circumstances, given some interesting remarks on friction, resistance, causes of failure, supported by the evidence of facts, and also by the observations of well-known scientific men, the author concludes the section by commending the Traction Engine of Taylor and Co., of Birkenhead, a description and illustration of which will be found in THE ARTIZAN for July, 1859.

The next section is that of "Distributed Weight," or the plan of interposing between the wheel and the ground a hard, unyielding substance covering a large area of the surface on which the wheel rests, thus distributing the weight, and reducing its mischievous effects by preventing it becoming concentrated "on any one spot." We here have a list of the various means by which those persons who had found the inefficiency of the other system, tried to carry this out, and a chronological list down to the year 1859, of these attempts, together with the names of the inventors, and short remarks on the inventions. The next section of the work describes Boydell's Traction Engine and Endless Railway, and gives a description of its working which is very interesting. We must however remark, that the want of a proper design, and the construction of these engines by fit and proper mechanics, seems as yet to be a desideratum. This is very evident in the accounts given by the author, where we find frequent remarks as to "faulty pump valves," weak waggons, &c. In fact, the want of skilled management in the designing and making of these engines is very manifest; and we feel sure that until these, or any engine, for traction or other purposes on common roads, are taken in hand by fit and proper men, whose experience and knowledge enable them to overcome the difficulties which are only to be discovered in practice, and are known to those whose pursuits and experience lead them to go into the matter, nothing but failure can be looked for, and the subject must remain in the hands of mere speculators and commission seekers. This is surely not the position a subject of such vast utility and importance should remain in; and it becomes evident that all who intend using steam power on common roads, should entrust their orders and wishes to the scientific professional man, who is capable of having the work properly designed, and seeing it properly executed; in fact, until this principle is acted on, we do not expect to see much progress made in the use of steam on common roads.

The next section treats of the most important part of the whole subject, viz., Cost of Working; and we feel we cannot do better than make an extract or two from this portion of the work:—

In order to show the great saving that arises from the use of steam, no plan can be more satisfactory than the case of the conveyance of a given number of tons per day, a given distance, by horses and steam; and as the horses could not do, say twenty-five miles per day, six days per week, we will limit them to a load of one ton each, over that distance, the load to be moved each day being twenty tons net weight, horses going four days a week, and the engine taking twenty tons per day, also four days per week.

If we set down the capital to commence, with twenty carts, horses, and harness, at £1200, we shall not be far off the mark; for the steam engine and five 4-ton waggons, we will say £1500—or one-fourth more for steam—bearing in mind, however, that the same expenditure for steam would as easily move 30 tons as 20 tons, if required. In the estimates of cost of working nothing is charged for turnpikes, as they ought, in these vaulted days of progress, free trade, and liberalism, to be, and will be, ere long, at least equal.

Here the great advantage of steam begins to show itself, inasmuch as whether these 20 horses are working or not they must eat, and it does not appear that the cost of them can be less than £20 per week, or 3s. per day; when not working equal to £3 per day, or three days at £3, equal £9.

If we give each driver two carts, and each man 2s. per day wages, we shall have £1 per day for men, and £3 per day for the horses, or £4 per day, so that seven days per week at £4 equals £28 as the cost of moving 80 tons per week 25 miles, by horse power.

The daily expense of moving 20 tons 25 miles per day by steam will stand thus:—

	£	s.	d.
Engine, including coal, wear and tear, oil, grease, &c., per			
25 miles	3	0	0
Wages of driver, steersman, and breaksman	0	12	0
	£3	12	0

So we have £3 12s. per day as the expense of taking 20 tons 25 miles by steam, or 6 days at £3 12s., equal £21 12s. per week; there being no work done on the Sunday, and deducting the cost of steam the two days the engine is not working, but reckoning the

wages of the men, it will be £21 12s. less £6, equal £15 12s., as the cost of drawing 80 tons per week over 25 miles—a saving in working expenses equal to £12 8s. per week, as compared with horse labour, or say £580 per annum, which we will call £500. The wear and tear of waggons is not included in this, as it may be considered that it could not in any case equal that of the horse-power arrangement, even if two-horse waggons were used instead of one-horse carts; but at any rate we may call them equal.

The cost of haulage by these engines on common roads has been found, after numerous experiments and continued working, with an average nett load of 20 tons, *not to exceed 3d. per ton per mile*. The first trip in which an account of coal, &c., was kept, so as to give some certain data for calculation, was that of Mr. M'Adam, from Thetford to London, a distance of 85 miles. In the account of this journey, no particulars as to the nett weight, or "load," are given, but it will be assumed that it was 17 tons nett, which the engine would easily have brought, including the weight of the vehicles, at a trifling addition to the present cost of the journey.

We find that there were three men to the engine and one man to the train; their cost will be—driver, 4s. 6d.; steersman, 3s. 6d.; man for train, 3s.; odd man, 3s. per day—14s. per day wages; this journey occupied three days; we have £2 2s. for wages. The coal burnt was 43cwt., which, at 1s. per cwt., equals £2 3s.; wear and tear on 85 miles, at 1s. 6d. per mile, equal to £6 7s. 6d.; the consumption of oil and grease was stated to have been great. Mr. Lamerton, in his journey of eight days' actual working, used 2 gallons of oil and 25lbs. grease; so, if his consumption be *doubled*, it will give a liberal allowance, and will stand thus—4 gallons oil at 5s. per gallon, equal £1; $\frac{1}{2}$ cwt. grease at 10s. per cwt., equal 5s. The total cost of the journey will therefore be:—

	£	s.	d.
Wages for 3 days	2	2	0
Coal	2	3	0
Wear and tear	6	7	6
Oil and grease	1	5	0

£11 17 6

or say £12, as the cost of drawing 17 tons over 85 miles; equal to, say 14s. 2d. per ton over 85 miles, or 2d. per ton per mile.

By horses 'tis would have cost, at the *minimum* rate of 6d. per ton per mile, £36 2s. 6d.; if at 9d. per ton per mile, £54 3s. 9d.; and, at 1s. per ton per mile, £72 5s., taking it at the sum of 6d., there is a nett saving of £24 2s. 6d. by the use of steam; and if we *double* the cost of the steam, making it £24, we still have a saving of £12 in its favour—no inconsiderable sum, where a large amount of tonnage has to be moved.

The next journey was that of Mr. Lamerton, from Thetford to Woolwich, a distance in round numbers of 100 miles. It is seen that the train consisted of:—

	Ins.	cwt.	qrs.
Engine	15	0	0
Five logs of oak timber	18	7	0
Four timber carriages	6	1	0
One van, coals, tools, men, &c.	4	10	0
	Total	43	18
Deduct engine	15	0	0
	Gross load	28	18
Deduct van, waggons, men, &c., say	8	18	0
	Nett load	20	0

We find that there were three men to the engine and two to the carriages, and, at the wages in Mr. M'Adam's journey, gives 17s. per day for wages. As this train was nine days on the road, we have the sum of £7 13s. as the amount of wages for the trip. The coals used amounted to 106 cwt., which, at 1s. per cwt., gives £5 6s.; wear and tear, at 1s. 6d. per mile, £7 10s.; oil, 2 gallons, at 5s.; equal 10s.; grease, at 10s. per cwt., equal 2s. 6d.; therefore the total cost will stand thus:—

	£	s.	d.
Wages, at 17s. per day, 9 days	7	13	0
Coals, at 1s. per cwt., 106 cwt.	5	6	0
Wear and tear, 100 miles at 1s. 6d.	7	10	0
Oil and grease	0	12	0

£21 1 6

Or say £22 for the trip, or a fraction over 22d. per ton per mile; in this case, horses at 6d. per ton per mile, would have cost, for the 20 tons, £50 against £22 by steam; a saving of no less than £28 on the journey.

The following are the average results of the working of the engine and train to the collieries near Manchester; but as there was only a load *one way*, the results are not so good as if we had loaded *both ways*. The journey to the pit—8 miles—was performed in 3 hours and 5 minutes, including 12 to 15 minutes' stoppage for water. The five waggons weighed 12½ tons. The return journey, with $\frac{1}{2}$ tons of coal in each wagon, equal 22½ tons coal; waggons, 12½ tons, equal say 35 tons, was performed, including 12 to 15 minutes' stoppage for water, in three hours 10 minutes. The coal burnt was $\frac{1}{2}$ cwt. per mile; oil, less than $\frac{1}{2}$ pint; grease, $\frac{1}{2}$ lb.; wear and tear, at 1s. 6d. per mile.

This gives the cost of working the engine and train as follows:—

	£	s.	d.
Wear and tear, 16 miles at 1s. 6d.	1	4	0
Coals, at 7d. per cwt.	0	7	0
Grease, 4lbs., at 10s. per cwt.	0	0	$\frac{1}{2}$
Oil, $\frac{1}{2}$ pints, at 6s. per gal.	0	1	$\frac{1}{2}$
Wages—Driver, steersman, and breakman	0	11	0

£2 3 6

Now, the above shows the cost of moving 22 tons over 8 miles, to be at the rate of 5s. 5d. per mile for the whole load, or a fraction under 3d. per ton per mile. When compared with the present price of 3s. 4d. per ton, as shown by Mr. Gibson to be at present charged for horses, or 3s. 1½d., if we deduct the toll, it is evident that even under the disadvantage of having to go 8 miles one way without a paying load, there is still a very considerable economy in the use of steam as compared with horses for this purpose. The trip from Manchester to Liverpool, *via* Warrington, 38 miles, stopping the night at the latter place, occupied two days; and the load behind the engine of the waggons, carts, spare gear, coke, &c., was equal to 19 tons, 15 cwt. on leaving Manchester. The coke used on the journey of 38 miles, including getting up steam, was a little under 1 ton; this gives a trifle over $\frac{1}{2}$ cwt. per mile, the road being pretty level, and in a good and dry condition. The oil used did not exceed $\frac{1}{2}$ gallon on the 38 miles, or less than $\frac{1}{2}$ of a pint per mile. A small quantity of grease was used, which helped the oil.

Having thus shown us what has been found to be the cost of the engine in actual working, the author gives us a short sketch of the progress of steam on the roads of the United States, furnished to him by Messrs. Holley and Fisher; from which we learn that the want of progress of this system in that country is attributed to the conduct of the English engineers as a body, who, without

giving the subject any attention, were loud in their condemnation of it, and thus it was not carried out in that country, further than as a moderately successful experiment. He next treats on conveying passengers on common roads by steam, giving us a description and engravings of the locomotives of the Marquis of Stafford and Lord Caithness, and showing that public attention is now being seriously attracted to the subject.

Under the head of "Why Steam Traction is not more general?" he is very severe in his remarks on the absurdity of taking a thing for granted without trying it; and having giving some notice to the cause of the use of traction engines and steam carriages being so limited, he shows what attempts have been made to facilitate their employment, mentions the Locomotive Bill now before the public, and gives some amusing remarks on the opposition the bill experienced during the last session.

In conclusion, he gives some good advice to both purchasers and users of these engines; and having invoked the aid of "all hands" to assist in liberating the system from its present incubus, of the existence of which we have a most convincing proof in the List of Tolls at the end of his work, the author concludes one of the most interesting and practical works we have for a long time seen.

We may remark that it possesses great interest for the general as well as the practical and scientific reader, more particularly as a bill for regulating these extraordinary tolls is now before Parliament, and of the existence and exorbitance of which we are sure few, whether in or out of the House, are aware. It gives us great pleasure to commend Mr. Young's work to the serious attention of our readers as being plain, practical, and highly instructive.

Useful Information for Engineers; containing experimental Researches on the Collapse of Boiler Flues and the Strength of Materials, and Lectures on popular Education, and various Subjects connected with Mechanical Engineering, Iron Shipbuilding, the Properties of Steam, &c. By WILLIAM FAIRBAIRN, LL.D., F.R.S., &c. Second series, 325 pp. London: Longmans, 1860.

In the volume before us we have a detailed account of the *modus operandi* and the results obtained from the numerous experimental researches conducted by the author, into the question of the strength and power of resistance to collapse possessed by tubes or flues of boilers, and also of glass vessels, when subjected to heavy pressures.

The results of the inquiry into the strength of tubes were brought before the public at the Royal Society in 1858, and those on glass at the same place in 1859. The experiments appear to have been very carefully conducted, and the details given in the work are exceedingly interesting and instructive to all those who have in any way to do with such matters.

The second portion of the work consists of lectures on popular education; on the machinery employed in agriculture; on the rise and progress of engineering down to the present century; on its progress during the present century; on the construction of iron ships, &c.—all of which possess great interest both for the scientific and general reader—read before the Polytechnic Institute in Liverpool, and again in 1860 at the opening session of the Institute of Naval Architects in London.

The lecture "On the Strength of Iron Ships," however, calls for a few remarks from us, more particularly as we have not yet seen any attention directed to what we now purpose to mention.

In seeking to find if a "more judicious distribution of the material" used in the construction of iron ships cannot be attained, we find Mr. Fairbairn advancing in the year 1860, and claiming principles of construction which, as it appears to us, are not new, inasmuch as they, we believe, are to be found described in the patent obtained by Mr. Richard Roberts, the well known Manchester engineer, in the year 1852.

We do not for a moment suppose that Mr. Fairbairn could have been aware of this, nor from the fact of Mr. Roberts not being a shipbuilder, it is not very probable that much attention would be given by those engaged in that pursuit to the performances of such "outsiders" as may have turned their attention to the subject. However, be that as it may, we find, on referring to the specification above named, that Mr. Roberts says, "Instead of the ordinary wooden bulwarks, the plates forming the sides of the vessel are continued above deck to admit cabin, and to increase the strength of the vessel. The bulwarks are covered by strong plates of iron, which are united to other strong plates. The plates dividing the coal bins are continued up to and connected with the plates at the top of the bulwarks, which are attached to and support the shrouds, whereby a clear passage is left for the crew outside the shrouds. By forming the bulwarks in the manner above described, great additional strength is given, inasmuch, as is well known, the strength of a beam, to which a vessel is analogous, is not directly in proportion to its depth, but as the square of its depth. The decks are made of iron, still further to strengthen the vessel (covered with wood where that is necessary), and for the same purpose the partitions are made of iron, and secured to the bulkheads and decks."

Our readers will do well to compare the above with the "new plan" which Mr. Fairbairn proposes as his own, and enunciates in the space included in from p. 244 to p. 281. At p. 273, we find that constructing the bottom of the hull of the vessel in the form of cells is proposed, and its advantages expatiated upon. Turning to the Patent Specification before quoted from, we read, "Sixthly, in applying two hollow keels to single hulled vessels, and dividing them into cellular compartments for stowing away goods, and for other purposes. Seventhly, in constructing iron vessels with longitudinal and transverse beams under the floor, and dividing the space between the floor and the bottom of the vessel into cells or compartments for the stowage of goods or water, which cells, being secured with watertight lids, afford great strength and security to the vessel."

We do not in any way desire to detract in the slightest degree from Mr. Fairbairn's merits, but simply in a matter of detail to "put the saddle on the right horse." If in error, we shall be glad to be corrected. Our readers will find that much instruction is to be gained by studying the discussion on Mr. Fair-

bairn's Paper in the Transactions of the Institution of Naval Architects, and also the specification of Mr. Roberts.

Before closing these remarks, we would wish to refer to the system of "chain rivetting," as it is termed by Mr. Fairbairn (which he strongly recommends), and the remarks on this subject to be found in the work *On the Britannia and Conway Tubular Bridges*, by Edwin Clark, where it is shown that this so-called "chain" rivetting is not by any means so strong as the zigzag rivetting, and that, in building those bridges, its employment was abandoned! As this statement is a published one, we do not like to see a plan recommended as better than any other, when it has been found in practice that such is not the case, more especially when it is done by a gentleman holding the position of Mr. Fairbairn, and we call his earliest attention to this fact.

In conclusion, we may say that, notwithstanding these minor defects, the work will be found particularly well worthy of perusal and attention; and we are all deeply indebted to Mr. Fairbairn for his great and constant exertions in behalf of the advancement of practical science, as well as for the very clear and familiar way which he from time to time brings before us the results of his labours.

A Sectional View of the Lanarkshire Coal Measure. By RALPH MOORE.
Glasgow: Morrison Kyle.

This section shows at first sight the stratigraphical position of the various seams of coal and ironstone in Lanarkshire. The present edition is also accompanied with a printed detailed section of the thickness of each stratum met with in the 730 fathoms which comprise the coal measures in Scotland, and which considerably adds to the value of this edition. The strata are named according to the local nomenclature, which will be better understood by those practically engaged in the search for minerals; and the geological names are likewise added.

The corresponding positions of the valuable minerals in other mineral districts are also given; thus, the well-known Airdrie black-bands, on which the Lanarkshire Ironworks are founded, have corresponding positions in these, some of which are beginning to be successfully developed.

The Fleet of the Future: Iron or Wood? Containing a Reply to some Conclusions of General Sir Howard Douglas, G.C.B., F.R.S., &c., in favour of Wooden Walls. By J. SCOTT RUSSELL, Esq., F.R.S., Member of Council of the Institution of Civil Engineers, and Vice-President of the Institution of Naval Architects (pp. 57). London: Longmans.

The pamphlet before us is most important, convincing, and valuable, and also most opportune in its appearance. It contains a complete and satisfactory refutation of the *dicta* of Sir Howard Douglas, who tells us that "ships formed wholly, or nearly so, of iron are utterly unfit for all purposes and contingencies of war, whether as fighting ships, or as transports for troops." It is rather difficult at first to understand on what grounds so sweeping a condemnation of iron ships is so dogmatically pronounced by one holding the high position of Sir Howard, and to whom that position opens so many ways of arriving at facts, or at least at correct information in these matters. However, Mr. Russell shows us that Sir Howard is in the confidence of the naval authorities, "who assist him with every kind of official information," on the subject of the Admiralty experiments which were tried on the power of iron to resist the impact of shot which experiment, in the words of Mr. Scott Russell in the pamphlet before us

"Was made, and made in such a way, that the conclusion they desired to arrive at might be effectually secured, and inconvenient questioners put down.

"An old worn-out river-boat, of thin and decayed iron, was accordingly procured; it was set up as a target, and fired at with heavy artillery, and triumphantly demolished.

"This much information was at least obtained, that old iron could be demolished by artillery, and there the matter ended; and the authorities retired from the performance, justified in their reluctance to assist in the introduction of a troublesome innovation."

It is needless, after this, to tell our readers *why* iron ships have made so little progress in gaining favour with our Admiralty; or to say that they will find in Mr. Russell's admirable pamphlet a complete and convincing proof of the entire fitness of this material for all purposes of war, if only proper care and attention be given to applying it in the *right* way, and to the circumstances under which it is to be used.

So far as relates to their powers as *fighting* ships, so good; but bearing in mind the extended employment of iron ships as *transports for troops* during the Crimean war—the purchase of the *Himalaya* and other iron ships by Government for this purpose, which are now in almost constant employment—we are sure it would be needless to point out to Sir Howard the fallacy of his statement that iron ships "are utterly unfit for all purposes and contingencies of war," more especially as the above *facts* admit of no contradiction, either theoretical or practical.

Bearing in mind the desperate attack made on us some short time since by a *quasi* scientific labourer in the same field as ourselves, because we presumed to speak and write in favour of "inclined sides" for armour-cased ships of war, it gives us great pleasure to find that a gentleman of the well-known talents and scientific attainments of Mr. Scott Russell should hold and enunciate the same views as ourselves. We heartily commend the following extract, therefore, to our friend, trusting that he will duly consider and profit by the remarks therein contained:—

"A few months ago it was proved by Capt. Hewlett, of the *Excellent*, that shots fired at plates placed at an angle of about 45 degrees, suffered only one-half the injury of plates receiving the fire at right angles. The experiments made by him on Mr. Jones's butt clearly established the advantage of inclined sides so far as resisting shot. * * * The principle of obliquity of surface to the line of shot, then presents us with a mode of dodging the shot instead of meeting it, which will enable us to contribute materially to the strength of all the smaller class of vessels without loading them with a heavier protection than their size will carry."

Here we have, from *practice* and *actual use*, the results we claimed for the principle so strongly deprecated by our scientific friend. We do not say whether it will, or will not be, applied by Government; but we do set forth its ad-

vantages, and we feel sure that the perusal of Mr. Scott Russell's excellent and practical pamphlet will cause many more to be of the same opinion.

Having carefully and plainly shown the advantages of iron over wood in building steamships of war, Mr. Russell proceeds to remark on the future fleet of England, and shows us why the use of iron is so opposed by Government; how they proceeded in order to prove its unfitness for the purposes to be answered by Government vessels; and, having completely and satisfactorily disposed of this part of the question, he shows us how we are to set about constructing the future fleet of England.

This is a most interesting portion of the work before us, and is deserving of the most careful attention of every Englishman. We find that, in addition to its other advantages, the new iron fleet proposed by Mr. Scott Russell can be more economically maintained than our present wooden fleet; that fewer men will be required; that it would occasion the employment of men of higher attainments, and more skill and knowledge in the scientific department of the Admiralty; and that from every point of view, and in every way, the country would be the gainer by the substitution of the iron fleet for the wooden one.

We say that Mr. Scott Russell deserves the thanks of every tax-payer in the country for bringing this most important subject so plainly before them, and in a way that will prevent any question or loss of time in carrying it into effect; and we take leave of it by heartily commending it to the careful study of our readers, as a work deserving of their most serious attention and consideration.

The Builder's and Contractor's Price Book for 1861. Revised by GEORGE R. BURNELL, Civil Engineer and Architect (pp. 286). London: Lockwood and Co., Stationers' Hall-court.

In this work we find the following alterations have been made:—1st, in the revision of the day-work prices throughout; 2nd, in the omission of prices for goods that are not used often enough to warrant their special notice; 3rd, the partial revision and alteration of the detailed prices of carpenters' and joiners' work; 4th, the revision of the prices for ironmongery; 5th, a similar revision of the prices for masons' work; 6th, the introduction of a new series of prices for gas-fitters' work; and, lastly, the text has been generally condensed.

All these add much to its utility, and give one a feeling of certainty in its use, which it is very desirable all should possess who are called on to employ works of this character to assist them in getting out estimates, taking work, &c.

The work is very nicely printed, the type used is plain and clear, and the contents are arranged in a convenient manner, so as to be easy for reference.

It must find its place on the table of every civil engineer, architect, builder, and contractor, as one of the standard works of reference employed by all engaged in the above pursuits.

A Practical Treatise on Coal, Petroleum, and other Distilled Oils. By ABRAHAM GESNER, M.D., F.G.S., Consulting Chemist, &c. (pp. 134). New York: Ballière, Brothers, 440, Broadway. London: H. Ballière, 219, Regent-street.

The author states that the work before us is prepared with a desire to aid the manufacturer of oils in his vocation, and that it is more practical than theoretical. In a small compass the author has contrived to embody a great deal of useful and practical information, on a subject to which a great amount of attention and capital have been, and will be directed.

He, it appears, has been engaged for several years as consulting chemist in the actual working of oil manufactories, and has consequently had much experience in all relating to the various processes employed for this purpose; he has, therefore, carefully recorded in the body of the work such information and facts bearing on the subject as he has considered useful.

The recent discoveries of vast reservoirs of petroleum in the Western and Southern States of the Union, have received a due share of attention; and the most accurate information that could be obtained, regarding their supplies of oil, has been recorded. Engravings of the different plans of apparatus employed for the manufacture of the oil have been given, which will be found of great utility to those under whose notice this important branch of manufacture may be brought, by showing them what is found suited for each description of mineral, in regular practical work.

It seems that there are no less than fifty-six factories for the distillation of oil from coal now working in America, which will give some idea of the importance it is assuming. One—the North American Kerosene Gas Light Company, whose works are at Newton Creek, Long Island—imported in the year 1859 upwards of 20,000 tons of the Scotch Boghead coal, or Torbane-hill mineral, at an average cost of 18 dols. per ton! The discovery, however, of the numerous strata of Cannel coals in the Western States, and of other cheaper substances for the production of oils, will soon render them independent of this country for their raw material.

The lowest yield of crude oil per ton of the American coal used is 47 gallons, and the highest 170 gallons; whilst from the Cuba bitumen 120 gallons per ton are obtained; and from that of Canada, 118 gallons.

In conclusion, we must say that we consider the work to be a most valuable, practical and plain treatise on a most interesting subject, and as such we have great pleasure in strongly recommending it to the attention and careful study of our readers.

Lessons and Practical Notes on Steam, the Steam Engine, Propellers, &c. By the late W. H. KING, U.S.N. Revised by Chief Engineer J. W. KING, U.S.N. New York: Frederic A. Brady, 24, Ann-street. 1860.

The author has here presented us with a very useful little work for practical engineers, and for sea-going engineers in particular. In pursuing it carefully we find what the author says fully corroborated, that it is an extract from his own private pocket-book, or, as he calls it, his *Steam Journal*; for we find a collection of notes and data that could only be got from practice; and thus he gives us a series of cases which he has had to encounter during his own practice as a marine engineer. In

addition to this, he gives us a very useful selection of some important theories connected with the engine and boiler, which it is quite necessary that every practical engineer, in charge of a pair of engines, should know; but, we are sorry to say, is too often unacquainted with. Before leaving this book, we cannot help noticing the superior stamp of the American chief engineers, in comparison with the generality of those in similar capacities here in England, who certainly are excellent practical workmen, but too deficient, generally, in respect to the theory of the steam engine. We commend this book to the careful study and attention of our readers.

Boyd's Marine Viaduct, or Continental Railway Bridge, between England and France.

This is the title of a pamphlet written by Mr. Boyd, of Barnes, Surrey, in which he proposes to connect England and France by a railway bridge, consisting of a succession of tubes, 50ft. deep by 30ft. wide, made of wrought iron, and riveted together; the tubes, 300ft. above the level of the sea, will rest on 90 towers, 100ft. diameter each, and contain two or more lines of rails. The total expense of the undertaking is estimated at £30,000,000. The idea is grand enough in all conscience, and is, judging by the plate illustration accompanying the pamphlet, simple enough, and apparently easy of execution; and the wish which on the instant occurs to our mind is, that Mr. Boyd may live long enough to see it executed, and that he may never suffer from that curse of authors, "the headache," until his project is successfully put into practice.

If we remember aright, this gentleman is the same who proposed a very useful and far more feasible plan for connecting London with the English Channel at the South Coast through the Valley of the Adar.

The Engineer's, Architect's, and Contractor's Pocket-Book for the Year 1861 (Weale's), roan tuck. London: Lockwood & Co., Stationers' Hall-court.

This book again comes before us, somewhat reduced in bulk by the omission of a good deal of matter of little value to those who generally employ it, though still containing, especially in the additions, much that is useful. We must however remark that it does not possess the exterior finish, nor exhibit the same care in binding that was one of the characteristics of former years; but this is a defect so easily remedied, and at such a trifling cost, that we feel sure attention needs only to be called to it to have it remedied.

We would direct the attention of the compiler of future editions of this work to the excellent *Pocket-Books* of Nystrom and Haswell, both American publications, from which he may, we have no doubt, gain some useful hints as to the material to be used, and the manner in which it should be worked up.

Amongst the additions we notice the Memorandum-book of Telford, the well known Engineer; several papers by Mr. Wm. Fairbairn, including his experiments on the collapse of tubes; a table of sines, cosecants, tangents, &c., and notes to these tables; also memoirs of deceased engineers; a complete list of the members of the Institution of Civil Engineers, and the Institution of British Architects.

We may say that the book is considerably improved, and, but for the minor defect we have noticed, should have spoken in high commendation. However, it is as well deserving as ever of the notice of engineers and architects, and as such we commend it to their notice.

An Essay on the Thermo-Dynamics of Elastic Fluids. By JOSEPH GILL (pp. 97). London: John Weale.

SECOND NOTICE.

The author has given us in his essay the results he has obtained during the study of many years devoted to the phenomena of steam and hot air as motive agents.

From these studies he seems to have arrived at the general conclusion, that

"In the thermodynamical phenomena of vapours and gases, instead of taking the unit of thermometric heat as the equivalent of mechanical work, we should distinguish between the sensible and latent conditions of the heat—sensible heat being the source of mechanical work, and latent heat the sign of work already done; sensible heat is the spring wound up, and latent heat the spring unwound; hence the equivalence is not between mechanical work and thermometric heat, irrespective of its quality or condition, but between caloric energy and mechanical work, the energy depending on the quality as well as the quantity of heat; and the conversion of latent heat into sensible is correlative to the statical force, or the work packed up; while, conversely, the change of sensible heat into latent is the measure of the work done, or given out in the expansion of the elastic medium.

"In developing my views on these points I shall have occasion to sketch briefly my general ideas on heat and thermo-dynamics, with the condensed results of experiments made during a period of seventeen years in the study, the workshop, and the engine room, in my endeavours to reduce theory to efficient practice; and I hope my labours will be found useful towards developing a theory of the mechanical equivalence of heat, which will better explain the mysteries of our heat engines, and lead to their improvement on correct physical grounds."

The author concludes his introductory portion of the essay by saying, that he "would direct the attention of our practical mechanicians and engineers to the importance of a rational investigation of principles, and thence the application of sound theory, if they are desirous of ennobling their work by impressing on it some stamp of intellect, and of performing worthily each his part towards the support and advancement of the high reputation which England enjoys for her thermo-dynamic engineering." We will not allude to the numerous cases in which these remarks could be shown to be needed, even at the present moment, and that, too, where the soundest principles and practice should and would naturally be expected to be found; but hoping that the author's essays may fall into their hands, we will only here strongly recommend them to study his remarks, in order that future practice may show a more thorough comprehension of the laws required to be known and acted on whilst dealing with the Thermo-Dynamic properties of Elastic Fluids, more especially in the case of steam.

In the course of his work the author gives accounts of some interesting experiments bearing on the general subject before us, and also in regard to boiler explosions and superheating of steam. In the last chapter he describes the practical application of moist air as a motive fluid, giving the results of an experimental

apparatus he used in order to carry out this design, from which he concludes that "unlike the steam engine where $\frac{1}{10}$ of the heat in possession is often thrown away unavoidably but uselessly at each stroke to prepare for the next, an air engine stores up the heat in possession when it is requisite to remove it from the motive medium, and again restores a large portion of it to the working fluid; so that the office of the boiler is principally to supply the heat of expansion of the elastic medium, which is the true representative and equivalent of the work performed, and which, with dry air of five to six atmospheres' pressure, corresponds nearly to Joule's equivalent of heat, or 772 lbs. raised 1 foot per unit of heat." Having shown that the mechanical work usually obtained from a given quantity of heat in the steam engine is only $\frac{1}{10}$ of the theoretical equivalent, he says, "With such a wide margin for improvement, we should surely endeavour to reform our heat engines;" and as all steam engines are heat engines, we think there are few who have read this pamphlet but will arrive at the same conclusion; so, by way of encouraging progress towards the successful carrying out of this desirable object, we strongly recommend the essay to the careful study of our readers.

Perpetuum Mobile; or, search for self-motive Power, during the 17th, 18th, and 19th Centuries. By HENRY DIRCKS, C.E. London: Spon, 1861. 12mo, pp. 600.

Perpetual Motion! what next? "A most incredible thing, if not seen," says the motto in the title-page, as quoted from the Marquis of Worcester's memorable "Century of Inventions;" wherein he makes mention of a wheel which he exhibited in the Tower before Charles I., and most of his Court, prior to 1649. His wheel is the first machine on record as having been actually exhibited. He describes it as having been 14ft in diameter, and moved by forty fifty-pound weights, in all two thousand pounds. The next wheel of this nature was invented about 1712, in Germany, by Orffyreus, a singularly versatile but unsettled genius. Mr. Dircks gives the fullest account of this invention that we have yet seen. And these two cases, although the inventors never disclosed the secret of their construction, are considered to have occasioned doubts in the minds of many able mechanicians, and a consequent mental reservation in the declaring of opinions adverse to the possibility of attaining self-motive power, and may have influenced even many mathematicians. We cannot go into these details here, nor quote as we could wish the French and German authorities adduced, respecting Orffyreus. The possibility of effecting perpetual motion has been demonstrated by Bernoulli, Gravesande, and Professor Airy, all which are here supplied; and it appears, according to Dr. Poppe, that "The discovery of such a motion is difficult, but not impossible; as Kästner, Laugsdorff, and other celebrated mathematicians have frequently shown" (p. 405). The authorities also quoted at large, but against its possibility, are De la Hire, Desaguliers, Parent, Papin, and, in Chapter V., a host of natural philosophers. We next come to consider the various schemes themselves, projected by sanguine inventors, and we promise all readers fond of mechanical curiosities a rare treat in the perusal. Their variety and interest may be imagined from a bare statement of the sources from which they are gleaned: there are the works of Bishop Wilkins, Tasnierus, Fludd, Bettünus, and other old authors; the Royal Society's Transactions, early philosophical treatises and journals, British and Foreign encyclopædias, popular journals, &c. To these are added three patents of the 17th century, seven of the 18th, and, strange to say, sixty-five of this present century. On this point Mr. Dircks remarks:—"The number of patents that are recorded will, no doubt, create general surprise; and yet some may have escaped notice owing to adopting titles as little explanatory as possible of the patentees' real object. If invention in this department showed any vigour, any signs of progressive improvement, this fact would prove a serious drawback. All circumstances, however, considered, it may really be acknowledged by many as a great relief from absolute surfeit." And so we ourselves really think. It is amazing, in looking over this record, to find men of good position and varied information so lost to all prudence as to patent, without the least investigation, plans which are not only absolutely useless, but in many instances, as here shown, public and obsolete—consequently, valueless as patent property; and when possessing some shadow of originality, rendered useless by their cumbrous and complicated character. To all engineers, particularly those commencing their career, this work will afford much useful information respecting past and present efforts to disturb the natural operation of the mechanical powers, and act as a warning against too readily entertaining schemes merely because they oppose difficulties whose solution, however amusing, are too likely to end in serious disappointments.

The number of claimants to the discovery having patents, and those who profess to possess the secret is really astonishing. The work has an introductory essay, by Mr. Dircks, in which he has fully analysed the subject in its several bearings, and states the case with earnestness and candour, favouring neither one side nor the other. It is rendered further interesting by above 100 wood engravings, and an excellent general index, which, from the variety of the subjects, occupies 18 pages. We wish the work, as we believe it will have, and deserves, every success.

Notes on Screw Propulsion: its Rise and Progress. By W. M. WALKER, Commander U.S. Navy. New York: D. Van Nostrand, 192, Broadway. London: Trübner and Co. (pp. 51). 1861.

The author informs us that he has reproduced, in a collected form, the series of notes for the *Atlantic Monthly* in consequence of the favourable reception accorded to them.

We have failed to discover anything novel or original, which is of practical value, in the 51 pp.; but, as the author writes from an exclusively American point of view, and does not rightly understand much that he has read, we are not surprised to find a vast number of errors, and several mis-statements.

The author acknowledges his obligations to the works of Admiral C. Paris, Imperial French Navy; Mr. John Bonne, C.E.; and M. Doré. We think he might have studied the works of Woodcroft, Russell, Nystrom, and others on

the Screw Propeller, and, to use a genial phrase, have "posted" himself "up" on the subject from THE ARTIZAN, and other scientific publications; for, when an officer in Commander Walker's position takes up the calling of author, and undertakes to instruct others, it would be well to first thoroughly acquaint himself with accurate details upon the subject on which he writes.

Transactions of the Institution of Naval Architects. (Vol. I.) Edited by E. J. REED, M.I.N.A., Secretary to the Institution. 1860. Secretary's Office, 166, Fleet-street, London.

We hail with considerable satisfaction the appearance of the first volume of the transactions of this promising institution. The volume, for the vast amount of valuable information which it contains, as well as for the admirable manner in which it has been got up, reflects great credit upon the secretary and editor, by whom it has been produced.

The sale of the volume to the general public would, we think, be of considerable value in stimulating improvements in naval architecture, as well as increasing the popularity of so valuable an institution, to which we wish every success.

We are glad to find, on perusing some of the papers, that they have been materially improved since they were read to the members of the institution, and they exhibit evidences of careful attention whilst passing through the press. We shall look for the results of the labours of the members of the institution at the series of meetings about to take place at the rooms of the Society of Arts, in the second volume of the *Transactions*.

LIST OF NEW BOOKS. AND NEW EDITIONS OF BOOKS.

- ANDREWS, G.H.—*Eudimentary Treatise on Agricultural Engineering.* 1 vol. 12mo. cloth, 3s., Weale's Series. Weale.
- BARROW, Isaac—*The Mathematical Works of,* edited for Trinity College, by W. Whewell, Royal 8vo., Cambridge, pp. 325, cloth, 15s., C. Cox.
- FOWNES, George—*A Manual of Elementary Chemistry, Theoretical and Practical.* Eighth Edition, revised and corrected. 12mo. pp. 780, cloth 12s. 6d., Churchill.
- HULL, Edward—*The Coal Fields of Great Britain; their History, Structure, and Duration,* with Notices of the Coal Fields of other parts of the World. Post 8vo. pp. 200, cloth, 6s. 6d., Stanford.
- JINMAN, G.—*Winds and their Courses, or a Practical Exposition of the Laws which govern the Movements of Hurricanes and Gales; with an Examination of the Circular Theory of Storms as propounded by Redfield, Sir W. Reid, Piddington, and others.* 8vo. pp. 100, cloth, 5s., Philip.
- KIMBER, Thomas—*Mathematical Course for University of London.* New edit. 8vo. cloth, 10s., Longman.
- MILLER, Thomas, *Catechism of the Marine Steam Engine, for the use of Young Naval Officers, and others.* E. and F. N. Spon, Bucklersbury, fcap. 8vo. 64 pp., cloth, 2s. 6s.
- MOORE, R.—*Sectional View of the Lanarkshire Coal Measure, showing at a glance the Stratigraphical Position of the various Seams of Coal and Ironstone in Lanarkshire,* by Ralph Moore. 10s. 6d., Morrison Kyle, Glasgow.
- VAUBAN'S First System of Fortification, preceded by a Life of Vauban. By Thomas Kimber. 3rd edit. royal 8vo. pp. 60, cloth, 5s., Longman.

CORRESPONDENCE.

We do not hold ourselves responsible for the opinions of our Correspondents.

AIR PUMPS, FOOT VALVES, AND THEIR PROPORTIONS.

To the Editor of THE ARTIZAN.

SIR,—In the last December number of THE ARTIZAN I find two letters about my foot-valve formula. To the first letter, from "A Marine Engineer," I have to reply that he is perfectly correct; our difference seems to lie in the tail of the decimals. I have sent to you, for "A Marine Engineer" the Russian pamphlet, from which he will soon understand the comedy; and he will find therein many things about steam engines which I am sure he did not know before.

The second letter, from an "Amateur," I consider of great importance, and it deserves particular attention, because it bears directly on a real practical question of value; and, for the interest of the engineering profession, I am very much obliged to him for his remarks.

"Amateur" says that I have given in my *Pocket-Book* a formula, in which the capacity of air-pumps and speed of ditto are brought into calculation of the area of the foot-valve, but it is not the case in the article in THE ARTIZAN; and that it seems strange to him that the latter can be correct.

Now, I beg to explain that the nature of the formulæ referred to is precisely the same in my *Pocket-Book* as that in THE ARTIZAN; that the air-pump and foot-valve are dependent on one another in both cases, because they are both calculated from precisely the same sources. The error lies in applying the foot-valve formula to an old air-pump of different proportions. In order to make the explanation clear, it will be necessary to repeat the meaning of the letters, namely:—

- D = diameter in inches
- S = stroke in feet
- d = diameter in inches
- s = stroke in feet
- A = area of air-pump
- a = area of foot-valve
- n = double strokes, or revolutions per minute.
- p = pressure in lbs. per sq. in., or deficiency of vacuum.
- T = temperature of the exhaust steam, Fahr. scale.
- k = specific volume of the exhaust steam.

From the *Pocket-Book* we have:—

$$d = 0.326 D \sqrt{\frac{S(890 + T)}{sk}} \dots 1$$

but as

$$d = 1.128 \sqrt{A},$$

$$1.128 \sqrt{A} = 0.326 D \sqrt{\frac{S(890 + T)}{sk}}$$

from which

$$A = \frac{D^2 S (890 + T)}{11.98 sk} \dots 2$$

According to *Pocket-Book*, $\alpha = \frac{A sn}{100 \sqrt{p}}$; from which $A = \frac{100 \alpha \sqrt{p}}{sn}$

consequently

$$\frac{100 \alpha \sqrt{p}}{sn} = \frac{D^2 S (890 + T)}{11.98 sk}$$

reducing, we get

$$\alpha = \frac{D^2 S n (890 + T)}{1198 k \sqrt{p}} \dots 3$$

In this formula in THE ARTIZAN I have brought into calculation the coefficient for the contraction of water passing through the foot-valve, which in some cases, where the area consist of a great number of small passages, is very considerable, and may amount to 50 per cent. In the formula in THE ARTIZAN I have assumed this coefficient $m = 0.625$; and as the stroke S is expressed in inches, the numerical division will be:—

$$\frac{1198 \times 12}{0.625} = 23001.6 \text{ and}$$

$$\alpha = \frac{D^2 S n (890 + T)}{23001.6 m k \sqrt{p}} \dots 4$$

which is the same formula as that in THE ARTIZAN, in which it appears that the foot-valve is independent of the air-pump, but we have just arrived at this formula, from the proportions of the air-pump; therefore, when "Amateur" employed the formula in THE ARTIZAN direct to his engine, he would not get into error about the foot-valve; but when he applied the foot-valve formula from my *Pocket-Book* direct to an old air-pump of proportions not calculated from my formula, the error is derived from the air-pump, and not from the formula.

The dimensions of "Amateur's" steam engine are: D = 30in., S = 6ft., P = 30lbs., n = 30 revolutions; for which he calculated the foot-valve to be $a = 71.4$ square inches, from which I find that the steam has been cut off at half-stroke. Let us now calculate, from the formula in THE ARTIZAN, the required size of an air-pump for "Amateur's" engine; we have for 30lbs. steam expanded one-half T = 235°, and k = 1150, stroke of air-pump piston s = 36in., for which the diameter of the air-pump will be

$$d = 0.326 \times 30 \sqrt{\frac{72(890 + 235)}{36 \times 1150}} = 13.7 \text{ inches.}$$

instead of 18½, as "Amateur" says is the diameter of his air-pump.

This is just the very point which I have so many times endeavoured to explain—that the air-pumps are generally made too large, and the foot-valve too small. When it has been found that a better vacuum is formed by a larger air-pump, I believe that that credit is due only to the increased size of the foot-valve.

Let us now make a calculation of the foot-valve from the *Pocket-Book* formula; we shall have,

$$\text{when } d = 13.7; \text{ area of the piston } A = 0.785 \times 13.7^2 = 147 \text{ square inches.}$$

$$\text{and foot valve } a = \frac{147 \times 3 \times 30}{100 \sqrt{2.75}} = 79.8 \text{ square inches.}$$

Should "Amateur," or any other engineer who has the opportunity of making a condensing engine from these formulae, be willing to let us know the result of it, it might lead to some important results in the construction of air-pumps. In the steam-engines I have made, I find the formulæ come in very well.

I shall always be willing to answer any communication, or enter into any discussion that will lead to some practical benefit;—if I am wrong, I am open to correction.

Yours most obediently,
JOHN W. NYSTROM.

STEAMSHIP PERFORMANCE.

To the Editor of THE ARTIZAN.

SIR—This subject has received a great deal of attention in England, and been discussed in most of the engineering journals, but I believe it is not yet exhausted; therefore a few of my notions on the same may be found worthy a space in THE ARTIZAN. Having made a slight alteration in the steamship formulæ in my *Pocket-Book*, I will explain my reason for having done so.

LETTERS DENOTE.

T = displacement of the vessel in tons.
 Ψ = greatest immersed section in square feet.
 φ = area of resistance in square feet.
 l = length in feet of the vessel at load line.
 b = breadth of beam in feet.
 F = total resistance of the vessel in pounds, moving in smooth water.
 k = co-efficient, x = exponent of the vessel. (See table.)
 M = nautical miles, or knots, per hour.
 H = actual horse power required to propel the vessel, or the horse power delivered by the engines after the friction and working pumps are deducted.

$$x = \frac{35 T}{\Psi l} \dots \dots \dots 1 \quad F = 4 \phi M^2 \dots \dots \dots 3$$

$$\phi = \Psi \sqrt{\frac{b^2}{b^2 + k l^2}} \dots \dots \dots 2 \quad H = \frac{\phi M^3}{81} \dots \dots \dots 4$$

EXPONENT x AND CO-EFFICIENT k.

Ex. x	Co-ef. k.	Ex. x.	Co-ef. k.	Ex. x.	Co-ef. k.
1.00	0.000	0.74	1.28	0.61	1.93
0.95	0.024	0.73	1.35	0.60	1.88
0.90	0.228	0.72	1.43	0.59	1.82
0.88	0.326	0.71	1.51	0.58	1.77
0.86	0.432	0.70	1.59	0.57	1.72
0.84	0.558	0.69	1.64	0.56	1.67
0.82	0.622	0.68	1.71	0.55	1.61
0.80	0.836	0.67	1.77	0.54	1.55
0.79	0.902	0.66	1.84	0.53	1.50
0.78	0.978	0.65	1.90	0.52	1.44
0.77	1.050	0.64	1.96	0.51	1.38
0.76	1.12	0.63	2.00	0.50	1.32
0.75	1.20	0.62	1.97	0.49	1.26

EXAMPLE 1.—The U.S. steam frigate, *Niagara*, is l = 328.9 feet long, b = 55 feet wide; greatest immersed section Ψ = 855 square feet; displacement, T = 5000 tons. Required.—What horse power is necessary to propel her M = 10 knots per hour in smooth water?

$$\text{Exponent } x = \frac{35 \times 5000}{855 \times 328.9} = 0.63 \text{ nearly.}$$

See table for exponent 0.63 answers the co-efficient k = 2, and the area of resistance will be:

$$\phi = 855 \sqrt{\frac{55^2}{55^2 + 2 \times 328.9^2}} = 104 \text{ square feet.}$$

$$\text{Actual power } H = \frac{104 \times 10^3}{81} = 1284 \text{ horses.}$$

EXAMPLE 2.—A freight steamer of l = 210 feet, b = 34, Ψ = 480 square feet, T = 2310 tons, M = 6 nautical miles per hour. Required.—The horse power.

$$x = \frac{35 \times 2310}{480 \times 210} = 0.80, \text{ for which } k = 0.836.$$

$$\phi = 480 \sqrt{\frac{34^2}{34^2 + 0.836 \times 210^2}} = 84.3 \text{ square feet.}$$

$$H = \frac{84.3 \times 6^3}{81} = 224 \text{ horses.}$$

In these two examples the quality of performance is considered to be the same; but if brought to the test of Mr. Atherton's formula, they will give quite different co-efficients. The following table contains data from a table in the second report of the Committee on Steamship Performance presented to the British Association for the Advancement of Science; it is also published in THE ARTIZAN for July, 1860. The results from the data by my formulæ are annexed.

NAME OF VESSELS.	Dimensions from Table of the Committee on Steamship Performance.						Results given by Nystrom's Formulæ.				REMARKS.
	l	b	Ψ	T.	M.	H.	H.	φ	X.	k	
Niagara.....	328.9	55	856	5075	10.9	1955	1600	100	0.63	2	Propeller.
Massachusetts ...	156	32	424	1428	6.9	240.75	312	77	0.75	1.2	Propeller.
Mersey (H.M.S.)	300	52	886	5462	13.29	4044	3690	127	0.72	1.43	Propeller.
Rattler	176.5	32.7	274	870	10.07	428	450	35.6	0.63	2	Propeller.
Lima	257	30	302	1345	10.4	1160	352	25.3	0.61	1.93	Paddle-wheels.
Tasmania	332	39	577	3375	12.35	2800	1122	48.2	0.62	1.97	Propeller.
Valparaiso	232	29	308	1220	10.0	800	345	27.9	0.60	1.88	Paddle-wheels.
Mersey (R. M. Co.)...	254.4	30	261	1300	11.5	1088	450	23.9	0.69	1.64	Paddle-wheels.
Guayaquil	195	30	260	840	10.4	600	415	29.8	0.58	1.77	Propeller.
San Carlos	192	30	260	700	10.0	500	444	36	0.49	1.26	Propeller.
John Penn	172	18.75	99	280	13.2	790	233	8.2	0.57	1.72	Paddle-wheels.
Undine	124	25	154.3	294	8.0	157	156	24.6	0.54	1.55	Propeller.

This table is not intended to show how closely my formulæ agree with the reported data, but to show what reliance can be placed in data given by different engineers and reporters, for which we will pick out the worst case, where the formulæ differ most, namely, for the steamer *John Penn*. The report gives 790 indicated horse power for 13.2 knots, while the formulæ give only 233 actual horses for the same speed. From the indicated power take off about 25 cent. to bring it into actual horses = 592, or 2.55 times that of the formula. Let us now reduce the speed of the *John Penn* to that of the *Undine* = 8 knots, and the required indicated power will be:—

$$\frac{790 \times 8^3}{13.2^3} = 176 \text{ horses.}$$

The propeller *Undine* has 33 per cent. more beam, 56 per cent. more immersed section, and more displacement, making the area of resistance three times that of the *John Penn*; but it requires only 157 indicated horses for 8 knots, while the *John Penn* should require 176; and, moreover, the *John Penn* is a paddle-wheel steamer, which ought to give a better result than the propeller *Undine*. How can this be explained? Are the formulæ to be condemned, or the reported data; or is it possible to establish a theory that will agree with such data?

The mischief originated from the theory of steamship performance is attributed principally to the different ways in which different engineers estimate horse power—some giving the speed in statute miles, and others in knots, which are not always clearly explained. Persons not accustomed to handle formulæ in connection with practice get hold of reported data, and blindly apply them to formulæ, and a controversy is raised. Should any one make remarks on my formulæ,

please take good care to ascertain the correctness of the given data; not that I am afraid of being exposed, whether the formulæ are right or wrong, but the wrong data produce a great deal of mischief to the general interest. For similarly proportioned vessels the resistance is a function of ΨM^2 , and the horse power a function of ΦM^3 . The displacement of a vessel is a function of the cube of any linear dimension of the same, and the greatest immersed section, Ψ , is a function of the square of any linear dimension of the displacement; consequently, $\sqrt[3]{T}$ is a function of any linear dimension, and $(\sqrt[3]{T})^2 = \sqrt[3]{T^2}$ is a function of Ψ ; therefore the resistance is a function of $M^2 \sqrt[3]{T^2}$, and the horse power is a function of $M^3 \sqrt[3]{T^2}$; thus we arrive at what is known as Atherton's formula, $C = \frac{M^3 T^{\frac{2}{3}}}{H}$ about which so much controversy has existed in your journal.

My formulæ give precisely the same result for similarly proportioned vessels as that of Mr. Atherton's, and it will be found that they give different co-efficients for different proportions of vessels, as seen in the two examples, where the quality of performance is considered to be the same.

$$\begin{aligned} \text{EXAMPLE 1.} - C &= \frac{10^3 \sqrt[3]{5000^2}}{1284} = 228 \\ \text{EXAMPLE 2.} - C &= \frac{6^3 \sqrt[3]{2310^2}}{224} = 168 \end{aligned} \left. \begin{array}{l} \text{As Atherton's} \\ \text{co-efficient.} \end{array} \right\}$$

The co-efficients are here very small, compared with Mr. Atherton's, on account of the different estimate of horse power, but the proportion is the same; it can, however, in neither case be considered a measure of quality of performance for different proportions of vessels, neither can it be considered a measure of commercial value, because the commercial effect produced will be—

$$\begin{aligned} \text{EXAMPLE 1.} &= \frac{10 \times 5000}{1284} = 39 \\ \text{EXAMPLE 2.} &= \frac{6 \times 2310}{224} = 62 \end{aligned} \left. \begin{array}{l} \\ \end{array} \right\} \text{Effects.}$$

which is quite the reverse of the co-efficients. If my formulæ are well understood, it will be found that they trace a line of justice between the engineer and ship-builder, that when the performance is known it shows to whom the praise or blame is due.

In the next edition of my *Pocket-Book* will be found complete tables of steamship performance, calculated for vessels of different sizes, and different speeds, and the required horse power.

My reason for having altered formula 2 is that $\sqrt{\frac{\Psi}{\Psi + k l^2}}$ in the former editions of my *Pocket-Book* does not answer for flat bottomed vessels of light draft; but in this formula 2 the $\sqrt{\frac{l^2}{l^2 + k l^2}}$ will be correct for all proportions. I believe that many deficiencies in tables and data are caused by the trouble of calculation, that persons may not have time or feel disposed to calculate what may be readily to hand, and therefore dispense with it. For my own part, I have no such trouble, all my calculations being done by machinery; I manage the calculating machine with my left hand, and pen and paper with my right, putting down the results as easy as if copied. Without this instrument I should not be able to produce one-tenth of the calculations and tables which I am constantly bringing out.

JOHN W. NYSTROM.

NOTICES TO CORRESPONDENTS.

A. R. C. (St. Petersburg).—A paper has been read, we believe, at the Institution of Engineers of Scotland, on the "Different Plans of Surface Condensation," by Mr. Thomas Davison, who is, we believe, the agent for an American Patent Condenser (Sewell's). Mr. J. F. Spencer has his condenser in use for about four years, and he is now fitting it in a considerable number of ships. The Surface Condenser of Mr. Scott, of Rotten, which has been illustrated in THE ARTIZAN, is an admirable contrivance, and we believe answers thoroughly. We cannot answer the last of your questions.

C. JUNIOR.—The name of the inventor is Pougault. We have written to Paris for you.

B. A. C.—The gentleman died some four months ago. Dr. Williamson, of University College, London, abandoned his patent of 8th of January, 1859 (No. 65), for Improvements in Condensers. We do not know positively whether he depends upon a current of air from a fan (instead of water) for the cooling action in the condensers with which he is at present experimenting, but we should have thought the learned Doctor was too well acquainted with the economic disadvantages of the use of air to have even contemplated its use, especially on board of ship.

Q.—We are not certain whether the book has been published. Professor J. R. Young was to have published a course of mathematics, pure and mixed, particularly suited for the use of Candidates for Military and Civil Service Examinations. Write to Allen & Co., 7, Leadenhall-street, London.

J. HOWARD (New York).—The *Black Prince*, iron-cased screw frigate, is being built by Messrs. R. Napier & Sons, Glasgow, and it is said will be launched on the 27th or 28th of February. Her principal dimensions are—length, extreme, about 420ft.; breadth, 35ft.; depth from spar deck, 41½ft.; builders' measurement, 6173 tons. Thanks for the information. Mr. Silver is, we understand, now in Philadelphia.

STEEL WIRE.—We cannot furnish you with the information. You had better apply to Messrs. Smith & Houghton, Silver-street, Warrington. We can speak with confidence as to the quality of their wires. The test-strain mentioned was obtained from very fine music wire, and was equal to about 110 to 120 tons per square inch.

C. SCRUTTON.—You may take 23 tons per square inch as a fair strain. Fairbairn gives 12,320lbs. for cast iron, and 28,000lbs. for wrought iron. We regret we have not space to enter upon the subject;—refer to THE ARTIZAN for the years 1855-1860.

C. CRAIG.—Read *The North British Review* for February.

C. S. STUART.—There is a Scientific Society in Glasgow, whose business it is to deal with such questions. Address Messrs. Robert Duncan and Robert Mansell, Secretaries to the Scottish Shipbuilders' Association.

AN ENGINEER (Newcastle).—You had better refer to Mr. Woodcroft's work on Screw Propellers, to Bourne on Screw Propellers, and other similar works, which you will find in the scientific libraries in Newcastle.

G. (Liverpool).—Corrections have been made. There is no work treating on the subject exclusively, but, we believe, Sir Howard Douglass's last book contained some information on the subject.

LW-ERBACH.—If you had read attentively THE ARTIZAN, you would not have had occasion to write, as you will find in the hack volumes all the information you seek. Get Nystrom's *Engineer's Pocket-Book*. Write to Spon, Bucklersbury, and Weale, High Holborn, London, for a list of books, and their prices.

A YOUNG ENGINEER (Burnley).—In a few more years you may be in a better position to judge of such matters. If you really knew your business, you would appreciate what has been done in the direction with which you find fault. We are, however, obliged for your suggestion. Send your address, and we will give you a useful hint by post.

P. B. (Lancashire).—Write to the Novelty Iron Works, New York. You may also address the manager of the Agricultural Engineering Co., Thames-street, London. We understand that an engine has been set up somewhere in that neighbourhood.

C.—The formula is corrected in the present number.

R. S.—The locomotive plate referred to is engraved, and has for some time been waiting an opportunity for its publication in THE ARTIZAN. As to surface condensers, send your address, and we will reply through the post. We do not know the gentleman for whom you inquire.—The vessel and her machinery not having been sufficiently tried, we must for the present decline complying with your request; we require facts. The diagrams you have sent us are fictitious. The fuel could not have evaporated the volume of water.

C. D.—Get a thorough theoretical knowledge of Arithmetic, Logarithms, the differential and integral Calculus, Geometry, Stereometry, and Trigonometry, besides the rudiments of Applied Mechanics, Natural Philosophy, and Chemistry. The following books would be of use to you—Moseley's and Rankine's *Applied Mechanics*, Rankine's *Steam Engine*, Dampsey's *Practical Railway Engineer*, Simms: *On Levelling*, and many of Weale's Series of Rudimentary Works.

ERRATA.

In the paper "On the Strength of Boilers," the co-efficient 263 should be 266, wherever it occurs.

In the same paper, page 21, TABLE OF FORMULÆ FOR STRENGTH OF BOILERS' COLUMN headed, *Strain per inch* $\frac{31520}{1}$ should be $\frac{51520}{1}$.

RECENT LEGAL DECISIONS

AFFECTING THE ARTS, MANUFACTURES, INVENTIONS, &c.

UNDER this heading we propose giving a succinct summary of such decisions and other proceedings of the Courts of Law, during the preceding month, as may have a distinct and practical bearing on the various departments treated of in our Journal: selecting those cases only which offer some point either of novelty, or of useful application to the manufacturer, the inventor, or the usually—in the intelligence of law matters, at least—less experienced artizan. With this object in view, we shall endeavour, as much as possible, to divest our remarks of all legal technicalities, and to present the substance of those decisions to our readers in a plain, familiar, and intelligible shape.

HOWES v. THE GREAT SHIP COMPANY (LIMITED).—This was an action brought in the Court of Queen's Bench by the plaintiff, Captain Ebenezer Howes, to recover a sum of money for royalty in the use of the plaintiff's patent in rigging the *Great Eastern*. The question involved was, by whose authority the patent was used, whether it was by Mr. Scott Russell in the completion of his contract, so as to make him liable for the royalty, or whether it was extra work done by him at the suggestion of the late Captain Harrison, acting not merely as superintendent for Mr. Scott Russell, at his request for the proper completion of the work, but as the agent of the company authorising the adoption of the patent on their behalf. The jury returned a verdict for the defendants, after having been locked up for some time.

BLYTH v. SAMUDA.—The plaintiff in this action, Alfred Blyth, is an engineer, and he sued the defendant, J. D. Aguilar Samuda, an iron shipbuilder at Poplar, to recover damages for the breach of a contract into which the parties had entered in August, 1858, whereby the defendant had contracted to build an iron steam-tug for the plaintiff, according to the specifications annexed to the argument, for the sum of £5000. The plaintiff complained that the vessel was not built according to the specifications. The defendant pleaded the usual pleas, and also an equitable plea, in which he alleged that the variations were made with the knowledge and consent of the plaintiff, and that he waived them. It appears that the plaintiff had entered into a contract with the Mayence Steam Towing Company, to supply them with a steam-tug of a shallow draught of water, and entered into a sub-contract with the defendant to construct the hull of the vessel, to which he was himself to add the steam engine and boilers, according to the specifications. The deck beams were to be of iron, fastened to the sides by knees and angle irons, and the whole were to be connected by two stringer plates lying on the ends of the deck beams, running from end to end of the vessel, and riveted to the deck beams and connected with the sides of the vessel. The defendant, however, substituted wooden deck beams for the iron beams, and instead of the iron stringer plate he put a wooden shelf, his object in doing so being, it is said, to lessen the draught of water. The vessel was constructed through the doing so being, it is said, to lessen the draught of water. The vessel was launched, the defendant under the inspection of plaintiff's manager, and before it was launched, the defendant's attention was drawn to the deviation from the specifications, and he was told that the responsibility of its being satisfactory to the Mayence Company rested with him. Shortly after, the vessel being launched and fitted with her engines, sailed for Rotterdam, and on her voyage encountered a heavy swell from the North Sea, which caused her to pitch and labour a good deal, and the result was that on her arrival the Mayence Company would not accept the vessel. The sides of the vessel had bent, or "huckled," and the bottom had sunk six or seven inches in the middle. The plaintiff had recovered £850 from the Insurance Company, and had sold the vessel for £1450 to the Mayence

Company, and he now sought to recover from the defendant the difference between these sums, and what he had paid him, viz., £5000; as he attributed the bucking of the vessel to the substitution of wooden deck beams, and a wooden shelf for the iron deck beams and iron springer plate. The defence was, that it was necessary to have wooden deck beams in order to secure the vessel drawing only 3ft. water, and that the deviation from the specification had been adopted with the plaintiff's full consent, and that it had finally been accepted and paid for, in satisfaction of the contract. This trial, which lasted three days, ended in a verdict for the defendant.

SCHLUMBERGER AND OTHERS v. SALT.—This was an action brought by the plaintiffs, in the Court of Queen's Bench, woolcombers and machine manufacturers, on the Upper Rhine, against the defendant, the late M.P. for Bradford, for an alleged breach of an agreement. Mr. Salt was only the nominal defendant, the real defendant being Mr. S. Cunliff Lister, the well-known combing-machine manufacturer in this country. Mr. Salt and some other gentlemen had purchased of the plaintiffs the royalty for the manufacture of their machines for Great Britain, Ireland, and Scotland only, and they have sold the same to Mr. Lister. The plaintiffs discovered that Mr. Lister had manufactured the machines, and had sold them to parties on the Continent, and they brought this action for compensation. Before the plaintiffs' case was concluded the parties agreed to a verdict for the plaintiffs, damages £5000.

RAE v. THE THAMES IRON WORKS AND SHIPBUILDING COMPANY.—This was an action brought for the infringement of a patent which the plaintiff had taken out for an improvement in the formation of the keel for iron steam vessels. The defendants pleaded "Not Guilty," that it was not plaintiff's invention; that it was not new; that it was not the subject of a patent, &c. The plaintiff had been workman, foreman, and manager to Messrs. Rennie. The defendants' company having been established, they secured the services of the plaintiff. The defendants had contracted to build two ships for the Royal Mail Steam Navigation Company. The plaintiff was aware of a great defect in connecting the keelson with the keel in ships, and he had invented a mode of doing this, which he thought a great improvement. He had kept his plans and models sealed up in his own private office. Two persons connected with the Mail Company had come down to talk to him about the ships the defendants were building for them, and in confidence, he showed them his models, telling them he should take out a patent. They highly approved of the plan, and requested plaintiff to apply it to their ships. In the beginning of April, 1853, the plaintiff took out a patent, and shortly after the directors and the plaintiff disagreed, and he left their service. After that time they applied his invention to the *Warrior* and other ships which they built, and refused to allow the plaintiff any royalty, and this gave rise to the present action. For the defendants it was urged that the plaintiff had communicated his invention to other persons, and had publicly used it in defendants' yard before he had taken out the patent; and in addition to this, he had been in consultation with one of defendants' foreman about the invention, and each had suggested some part thereof; therefore the invention was not new at the time the patent was taken out, and not solely the invention of the plaintiff. Witnesses were called proving the latter portion of the defence. A specification sent in by the Royal Mail Steam Navigation Company was put in. It was dated March, 1853, the drawing in that specification contained the groove. It was said to have been a matter of common discussion in defendants' yard before that time. The object of cutting the groove was well known. The Lord Chief Justice here interposed, and asked, if the jury believed defendants' witnesses, how could the plaintiff succeed. It was one of the hardships attending such things when a man told his invention; he always regretted that an inventor should so defeat his own interest. The plaintiff was, therefore, nonsuited.

NOTES AND NOVELTIES.

OUR "NOTES AND NOVELTIES" DEPARTMENT.—A SUGGESTION TO OUR READERS.

We have received many letters from our correspondents, both at home and abroad, thanking us for that portion of this Journal in which, under the title of "Notes and Novelties," we present our readers with an epitome of such of the "events of the month preceding" as may in some way affect their interests, so far as their interests are connected with any of the subjects upon which this Journal treats. This epitome, in its preparation, necessitates the expenditure of much time and labour; and as we desire to make it as perfect as possible, more especially with a view of benefiting those of our engineering brethren who reside abroad, we venture to make a suggestion to our subscribers, from which, if acted upon, we shall derive considerable assistance. It is to the effect that we shall be happy to receive local news of interest from all who have the leisure to collect and forward it to us. Those who cannot afford the time to do this would greatly assist our efforts by sending us local newspapers containing articles on, or notices of, any facts connected with Railways, Telegraphs, Harbours, Docks, Canals, Bridges, Military Engineering, Marine Engineering, Shipbuilding, Boilers, Furnaces, Smoke Prevention, Chemistry as applied to the Industrial Arts, Gas and Water Works, Miniug, Metallurgy, &c. To save time, all communications for this department should be addressed "19, Salisbury-street, Adelphi, London, W.C." and be forwarded, as early in the month as possible, to the Editor.

MISCELLANEOUS.

TUBULAR STEAM CRANES.—The two powerful tubular steam cranes erected for the Government by Messrs. Fairbairn & Sons have been recently subjected to a series of severe tests, before being formally taken possession of by Government. The largest of the two cranes is a fine specimen of mechanical engineering, and has been constructed of sufficient strength to sustain nearly double the number of tons that it will ever be required to bear. In order to carry the enormous weight thrown upon the foundation, excavations were made to the depth of nearly 30 feet, where a firm bed of concrete was laid, supporting a number of iron cylinders, each of 15 feet in length, the whole being bolted firmly together, and surrounded with brickwork. The arm of the crane forms the segment of a circle of 25 feet radius, the whole being formed of half-inch wrought-iron plates. By a simple contrivance it can be so adjusted that the crane may be worked by manual labour as well as steam, eight men being required to lift weights of 15 tons, while the nominal power of the engine when steam is used is 7 horse. During the experiments recently made, the crane was first tested with a few tons weight, which was gradually increased until a strain of 15 tons 7 cwt. was obtained, three of the heaviest guns on the wharf being raised with the greatest apparent ease. In order to show the perfect control of the engine, the guns were repeatedly raised and lowered with the greatest rapidity, while, by a simple contrivance, the weight was moved round to any required spot by means of a spur segment, on which the crane travels. At the period of the heaviest strain it was ascertained that the deflection of the crane was only 2 inches, returning 1½ inches when the weight was removed, leaving a ¼ inch of settled deflection,

or dead set. Similar experiments were made with the second crane, the results of which were equally satisfactory.

REAR-ADMIRAL OF THE BLUE ROBERT SPENCER ROBINSON has been appointed by the Admiralty as successor to Rear-Admiral Sir Baldwin W. Walker in his office as Controller of the Navy.

SHIPS' PUMPS.—An official trial recently took place in Portsmouth dockyard of the two patent systems of ships' pumps (Downton's and Roberts's) commonly in use in the navy—Downton's being a 7 inch or regulation pump, and Roberts's a double-action twin pump of 5½ inches. The result proved that five tanks, measuring 200 gallons each, were filled with water by Roberts's pump in 17 minutes 27 seconds, with 520 strokes, and by Downton's, with 746 strokes, in 21 minutes 40 seconds; being 42 per cent. in favour of the former in capacity, and about 20 per cent. in time.

EXPERIMENTS lately made at Pittsburg, U.S., on the strength of iron compressed by cold rolling, show that the operation imparts to this metal a strength of about 110,000 lbs. per square inch, when before it bore but 65,000 lbs.

ANVIL BLOCK.—Messrs. Morrison & Co., of Ousburn, Newcastle-on-Tyne, cast a few days since an enormous anvil block, weighing upwards of 34 tons, for the Elswick Ordnance Works. The melting of the metal occupied five hours, and the immense mass will take three weeks to cool, when it will be removed to its bed at Elswick.

THE LARGEST CAST-IRON BUILDING IN THE WORLD is now erecting in Havana, Cuba. It is 800ft. long, 70ft. wide, and 50ft. high, and is to be used as a warehouse to store merchandise on the dock.

THE NUMBER OF STEAMERS built in the United Kingdom in 1856 was 298 steamers, measuring 90,549 tons; in 1857, 321 steamers, measuring 87,594 tons; in 1858, 221 steamers, measuring 80,106 tons; in 1859, 219 steamers, measuring 61,375 tons; and in 1860, 242 steamers, measuring 103,662 tons. In the latter number is included the tonnage of the *Great Eastern*.

STONE-BREAKING MACHINE.—A Bombay paper thus describes a new machine invented to supersede manual labour in stone-breaking:—"Embedded in a strong wooden frame is what is termed a vertical jaw, formed of white metal, chilled. This is corrugated at intervals of about two-and-a-half inches. Opposite the vertical is the hanging or moveable jaw, which works at an angle of about forty-five with the other, thus with it forming a kind of hopper, into which are placed the larger stones for reduction into metal, the hanging jaw propelled forward two hundred times in a minute by a lever moved on a tangle-joint, worked by a crank and fly-wheel, thus giving the necessary sharp, hammer-like blows to the stone. This machine, being upon two large wheels, and having an arrangement in front to which smaller ones may be attached, can be transported at pleasure, and with very little trouble or loss of time. It crushes bluestone at the rate of four cubic yards per hour, and can be set at pleasure to a large or small gauge. A cylinder, with different sized meshes, when required, is attached to the apparatus, the smaller apertures being nearest the feeder."

SURFACE CONDENSERS.—It has been found that the tubes of the Poisson surface condensers, used in many of the American steamships, become so injured after two years' use as to be entirely worthless. This result is attributed to the sprinkling of cold water upon them instead of its circulating in bulk among them.

AN IRON SHIP, 3000t. long, is about 1in. longer when in the Gulf stream than in the Northern seas, with the water at a temperature of about 35 deg., the difference being due to the expansion of the iron in the warmer current.

BY THE RETURN made by Lloyd's up to 14th ult., the number of losses and casualties during the recent storm amounted to 210. When the returns are completed, it is highly probable the number will not be far short of 300.

THE ADMIRALTY have come to the determination of abolishing the rank of third-class assistant engineer in the navy. Assistant engineers of the first-class will, in future, be styled engineers; those who are at present in the second-class will become first-class; and those of the third-class will be designated second-class assistant engineers.

BEFORE THE PUBLICATION of Lieutenant Maury's wind and current charts, the average length of a voyage by sailing ship between England and Australia was 124 days. The average is now ninety-seven days, the passage having once been made in sixty-three days.

ON THE 10th ULT., on the Great Northern Railway, near Doucaster, a wooden bridge was carried away by a flood. An express train had passed over it not long before, and the discovery of the accident was just in season to stop another train about leaving Doncaster at 1.17 a.m. The traffic was interrupted until late on the following day.

THE TYNE IMPROVEMENT COMMISSIONERS have erected, at the west-end of the New Quay, North Shields, a mast and apparatus, to be used by the Coastguard in giving instructions to seamen in the use of the rocket apparatus in cases of shipwreck.

FRENCH NAVY.—An official statement of the French Navy states as follows:—"At this time, when the only war ships worthy of the name are steamers, our real force is reduced to eighty-eight vessels, even including those of a mixed order, which are but of secondary value. These eighty-eight vessels are thus classed:—

	New Ships.	Mixed.	Total.
Lineers	12	23	35
Plated Frigates.....	1	—	1
Ordinary Frigates ...	11	6	17
Corvettes	7	—	7
Avisos	23	—	23
	59	29	88

A GREAT VESSEL OF OLDEN TIMES.—Ptolemy Philopater, who lived some 200 years before Christ, had a ship with forty banks of rowers, being 560ft. in length—100ft. longer than the *Persia*, and 120ft. shorter than the *Great Eastern*—76ft. from one side to the other; height to gunwales, it was 96ft.; and from the highest part of the stern to the water-line it was 100ft. It had four rudders, each 60ft. long. When it put to sea it held 5000 rowers, and 400 supernumeraries, and on the deck were 3000 mariners.

CAPTAIN SIR EDWARD BELCHER, C.B. (owing to the demise of Admiral Sir George Mundy), is now promoted to the rank of Rear-Admiral.

A SET OF VERY POWERFUL SHEERS, worked by steam power, and adequate to lift the largest class of marine boilers and machinery, is in course of construction by Messrs. Jackson & Watkins, at the Canal Iron Works, Poplar, for the use of the port of Sebastopol.

THE BRITISH NAVY.—A parliamentary return has just been issued, showing the number of Her Majesty's steam and sailing ships afloat, building, and converting, on the 1st of the present month. Of steamships afloat there are 392 screw, and 113 paddle, making a total of 505, and 57 are building or converting. The effective sailing ships afloat are 129, making the total of steam and sailing ships 638. Of the steam ships afloat 53 are ships of the line, screw; 31 are frigates, screw, and 9 paddle; 9 block ships, screw; 1 iron-cased ship, screw; 19 corvettes, screw; 53 sloops, screw, and 35 paddle; 3 small vessels, screw, and 21 paddle; 189 gun vessels and gunboats, screw; 8 floating batteries, screw; 17 transports, troop ships, tenders, yachts, &c., screw, and 48 paddle; and 4 mortar ships, screw. The steamships building or converting are 14 ships of the line, 12 frigates, 6 iron-cased ships, 4 corvettes, 14 sloops, 4 gun vessels and gunboats—all the foregoing are screw vessels; 2 despatch vessels, paddle; 1 transport. The effective sailing ships afloat are divided into 10 ships of the line—3 of these, and 2 from the non-effective list, are fit to be converted into block ships; 17 frigates, 4 of these are fit to be converted; 18 sloops and 8 small vessels, and 83 mortar vessels, floats.

SHIPBUILDING AND REPAIRING.—A return has been presented to Parliament, furnishing particulars of the expenditure of the four millions voted for the building and repair of ships, and the wages of artificers for the year 1859-60. On 49 ships and vessels building

there was expended £1,018,061; on six ships commenced as sailing ships and converted to screws while building, £193,727; on 17 ships launched as sailing ships, and subsequently converted into screws, £322,074; for the fitting out and refitting, and for repairs, and the maintenance of 239 steamships and vessels in commission £819,976; and of 56 sailing ships and vessels, £39,194; for the fitting, refitting, and repairs and maintenance of 207 ships and vessels in the steam ordinary, £362,256, but the corresponding outlay on 100 ships in ordinary appears to have been met by credits given for stores returned on paying off; for the fitting and maintenance of hulks, £5560; and for the maintenance of yard craft, £21,611. Then there were £286,752 paid for building vessels by contract, £762,590 for machinery of steam vessels, £343,136 for miscellaneous expenses, and £110,508 for stores sent abroad.

IRON SHIPBUILDING ON THE TYNE.—On the 17th ult. there was launched, from the building yard of Messrs. Mitchell & Co., a full-rigged iron screw steamship, named the *Western*, of the following dimensions:—Length, 183ft.; breadth, 23ft.; depth, 12ft. The engines, by Messrs. Stephenson & Co., Newcastle, are of 100 horse power, and are of the same principle as that of the iron vessel *Diamantina*. The *Diamantina* has had two trial trips. The result of the latter was even more satisfactory than the former, the vessel attaining a greater amount of speed with a less consumption of fuel. The average speed attained was $9\frac{1}{2}$ knots per hour, being half a knot above the contracted speed, on a consumption of 1.23lbs. coal per indicated horse power.

PUDDLING MACHINE.—A self-acting puddling machine may be seen up to the 13th inst. at 21, Rhodeswell-road, Stepney, practically making puddled balls without manual labour.

INTERNATIONAL EXHIBITION OF 1862.—The arrangements for holding the second International Exhibition of Works of Industry and Art in 1862 are steadily progressing. A Royal Charter has been granted empowering the commissioners to borrow the sum of £250,000. The funds borrowed are to be expended on the erection of such building as may be necessary, and in the general expenses attending the enterprise. Of the building to be raised, one acre only is to be of a permanent character, and upon this portion the sum of £50,000 is to be expended in its erection and completion. Should the Exhibition be attended with a profit, in this case the permanent building is to be vested in the Society of Arts, and used by them for purposes tending to promote arts, manufactures, and commerce; but in case of a deficiency at the close of the Exhibition, the Society of Arts is to have the power to claim a lease of the same upon its undertaking to pay to the commissioners such money as the buildings would be likely to realize if taken down; but in case the Society of Arts should not claim a lease, then the commissioners are to sell the one acre of permanent building, and convert into money all properties and effects belonging to them, which can be sold and converted, particularly all the buildings erected by them for the purposes of the undertaking. Should there, however, at the close of the Exhibition, after the payment of all liabilities, be a sufficient surplus of profit remaining, then the one acre of permanent building is to be completed and the land retained for the purposes of a future Exhibition, by the payment of £10,000 to the Royal Commissioners of the Exhibition of 1851, on whose land the Exhibition of 1862 is to be placed, and all further profits are to be applied to such purposes connected with the encouragement of arts, manufactures, and commerce as shall be determined by the guarantors at a meeting to be called for that purpose. On the 23rd ult. it is stated that they came to a final decision as to the character of the building intended to be erected for the Exhibition of 1862, and so soon as the guarantee deed is signed the Bank of England will be prepared from time to time to advance the necessary funds, and Messrs. Kelk and Lucas, the eminent contractors, who sent in the lowest tenders, will jointly proceed with the erection of the building. It is also stated that the commissioners have received the assurance of the French Government of its support of the Exhibition, accompanied by the statement that it had been the intention of the Emperor to hold an International Exhibition in 1862, had the project not been entertained in England. The Duke of Newcastle, Secretary of State for the Colonies, has addressed a communication to the Governors of Her Majesty's colonies, announcing the intention to hold the Exhibition. In England some of our largest manufacturers are already actively engaged in preparing for this second display.

A SCIENTIFIC GENTLEMAN in Jamaica, after years of study and research, claims to have discovered some new arrangement by which, by action and reaction, condensed air is enabled to keep a piston or other body in perpetual motion without extraneous aid.

THE MIDLAND WAGON COMPANY held their customary half-yearly meeting on the 20th ult. The report was adopted. The net profit of the past half-year, after deducting £7158 for the renewal of waggons, amounted to £6550. A dividend of 10 per cent. was declared, and the remaining £3000 was carried to the credit of the bonus shares which are now paid up, and are classed with the ordinary shares of the company. Certain resolutions were then passed, by which the company will now be authorised to increase the capital to £200,000.

A DIVIDEND OF 5s. PER SHARE has lately been declared by the directors of the English and Australian Copper Company. It is said the company purpose making 3000 tons of copper during the present year.

A NEW SURVEYING CHAIN.—Mr. Payne, of the United States, has brought out a new invention to supersede the usual chain used in surveying. It consists of a steel measure, which curls up like a tape measure, but is so tempered as to be perfectly straight when uncoiled. The whole weight of the instrument does not exceed 3lbs. A thermometer is attached to it, and the measure, it is stated, can always be of the same length, no matter what is the temperature.

A DRENGER intended for the river Tyne, and designed to operate at a depth of 30ft., is now being built by Messrs. Wingate and Co. The above is the largest dredger ever built on the Clyde.

STEAM SHIPPING.

THE STEAM NAVIGATION COMPANY held their half-yearly meeting on the 26th ult., Mr. J. Wilkin in the chair. The report of the directors and statement of accounts were unanimously adopted, and the customary dividend of 10 per cent. and the usual bonus of 2s. 6d. per share were declared, a vote of thanks being likewise passed to the chairman and directors in acknowledgment of their services.

THE "SPIDER," screw steam gunboat, having received a thorough repair, got up steam on the 26th ult., and proceeded from Hamoaze into Plymouth Sound, to try her machinery.

THE "ROYAL ALBERT,"—At Devonport there are various rumours regarding the fate of the screw steamship *Royal Albert*, 121. Some contend that she will be cut down; others, that she is so much decayed as to be not worth repairing.

QUEENSLAND—AUSTRALIA.—A number of influential colonists have projected a Steam Navigation Company with a view to increase the traffic, lower the rates of freight, and afford the Government greater facilities for carrying on the mail service between Brisbane and the northern parts of the colony. The capital of the company is £25,000, divided into shares of £10 each. Arrangements have already been made with the Government for the conveyance of the mails from the 1st of April, 1862; and as the mail subsidy will cover the working expenses, the shares will soon take a high stand. As nearly all the shares intended to be issued have been taken up, it was determined to appoint an early day for the election of directors.

NEW SOUTH WALES.—The H.R.N.S.N. Company forwarded home instructions for the last mail for a new steamer, to be built to their order. She will be about 15ft. longer, with 1ft. more beam, than the *City of Newcastle*, and of about 180 H.P. She is to combine all the latest improvements, and is expected to be one of the fastest paddle-boats in the colonies.

THE "METROPOLIS," screw steamer, of London, sunk on the 12th ult., off the Hermitage Rocks, Jersey.

THE STEAM RESERVE IN THE MEDWAY, at Chatham, is composed of the following line of battle and other screw steamers:—First division—The *Meane*, 81,—400 horse power; *Phaeton*, 51,—400 horse power; *Challenger*, 22,—400 horse power; *Malacca*, 17,—200 horse power; *Chameleon*, 17,—200 horse power; *Griffin*, 5,—80 horse power; *Lee*, 5,—80 horse power; and five gunboats, each of 2 guns, and 60 horse power. Second division—*The Hood*, 91,—600 horse power; *Rodney*, 90,—500 horse power; *Waterloo*, 90,—500 horse power; *Goliath*, 80,—400 horse power; *Irresistible*, 80,—400 horse power; *Severn*, 51,—500 horse power; *Galatea*, 26,—800 horse power; *Orpheus*, 21,—400 horse power; *Orestes*, 21,—400 horse power; *Horatio*, 12,—250 horse power; *Dragon*, 6,—560 horse power; *Victor*, 6,—350 horse power; *Plover*, 5,—80 horse power; *Wanderer*, 4,—200 horse power; *Cormorant*, 4,—200 horse power; *Racehorse*, 4,—200 horse power. The floating batteries—*Thunderbolt* 16,—200 horse power; *Etna*, 16,—200 horse power; *Thunder*, 14,—150 horse power; and 5 gunboats. Third division—*The Anson*, 91,—800 horse power; *Atlas*, 91,—800 horse power; *Newcastle*, 51,—600 horse power; *Eurotus*, 12,—200 horse power (mortar ship); *Sicollour*, 9,—60 horse power; *Hermes*, 6,—200 horse power; *Virago*, 6,—300 horse power; *Locust*, 3,—100 horse power; and 10 screw gunboats. Fourth division—*The Collingwood*, 80,—400 horse power; *Leander*, 51,—400 horse power; *Phaenix*, 6,—260 horse power, and 1 gunboat.

PROGRESS OF STEAM SHIPPING.—A return has been published, from which it appears that in 1860 the number of steamers built for British owners were—23 vessels of wood, 811 tons; 140 vessels of iron, 79,570 tons. For foreign account, 74 steamers of wood, 23,280 tons; 242 of iron, 103,662 tons.

THE "QUEEN VICTORIA" steamer, which run on shore near Plymouth in January last, has since been most successfully raised by the use of Gwynne's Pumps. This is the tenth large vessel recently raised and floated by the use of those centrifugal pumps.

THE "NAPOLEON," a fair representative of the new steamships of the line of the French Navy, has an extreme length of 262ft., a breadth of 53ft. 8in., and a draught of 25ft. 3in. Her immersed mid-section is 1063 $\frac{1}{2}$ square feet, and displacement, 5050 tons. Her engines have 98 $\frac{1}{2}$ in. cylinders, 5ft. 3in. stroke, and her four-bladed propeller is 19ft. in diameter, and has a pitch of 27ft. 11in. She has eight boilers, and forty furnaces, and at a maximum speed of 12.14 knots, burns 143 tons of coal per day, carrying five days' supply.

THE "RIFON," belonging to the Peninsular and Oriental Company, has come to London to be lengthened 35ft.

THE "COCKATRICE," new class gunboat, made her official trial of speed a few days ago at Portsmouth. The mean of her runs at the measured mile gave her a speed of rather over 8 $\frac{1}{2}$ knots. Her engines are 60 horse nominal, condensing, by Messrs. Penn. Their working gave entire satisfaction.

STEAM SHIPBUILDING ON THE CLYDE.—Messrs. Napier and Sons, of Govan, are building a fine new steamer, to be named the *Scotia*, and intended for the Cunard line of Atlantic steamers. The *Scotia* will, next to the *Great Eastern*, be the largest mercantile steamer built. Messrs. Napier have also entered into a contract to build an iron-cased war steamer, intermediate in size between the *Warrior* and the *Resistance*. The contract has been taken at £41 10s. per ton, as compared with £37 per ton in the *Black Prince*, and £31 10s. in the case of the *Warrior*. Messrs. Napier's tender is, however, 10s. per ton lower than a similar one entered into by Messrs. Westwood, Baillie, and Co., of Milwall, Poplar. The new batteries (which are intended for block-ships), instead of being limited, as regards their iron-casing, to a length of 214ft. amidships on each side, will be placed entirely round from below the water-line upwards.

STEAMSHIP PADDLE FLOATS.—The Royal paddle yacht *Victoria* and *Albert*, on the occasion of the recent trip to Madeira from Antwerp, sustained considerable injury to her paddle-floats during the exceedingly violent weather she experienced throughout the trip, particularly on the outward voyage. Since her floats have been unslipped and examined, it has become a question whether they could not be made from some more durable material than that which has been hitherto used—English oak. To ascertain this satisfactorily, a series of tests have been tried at Portsmouth, and the result appears to be that it will be difficult to supersede English oak with any other material more durable for the purpose. Each float of the yacht's paddles measure 11ft. 6in. in length, by 4ft. 4in. in width, the wood being 4in. thick. One of these floats—a spare one—was tested. The others tested comprised two new ones, of the same wood—English oak, one of American oak, and one of wrought iron, the latter being plates rivetted together with a space between. The mode of testing was by placing the float with its two ends resting on bulks of timber. Across the centre of the float, transversely, ran a bar of iron, 4in. square, from which was suspended the weights for trying the float's resisting powers. The American oak broke at 32 tons. The wood forming this float was of the finest character, and most even grain, and without a knot in any part. One of the new English oak floats broke at 28 tons, and the other at 24 tons. These floats were much weakened by having iron plates on their surface, each containing nine or ten bolt holes. The one that broke at 28 tons, had it been without this iron plate, and its accompanying bolt holes, would doubtless have stood as great a strain as the American oak. The *Victoria* and *Albert*'s spare float broke at 21 tons, and the wrought iron one broke at 19 tons.

THE "PHILOMEL,"—GRIFFITHS'S SCREW.—The *Philomel*, 5, screw-gun vessel, tested her speed in Stokes' Bay, on the 8th ult. The average of the runs made at the mile gave the ship a speed in knots of 9.540, using a Griffiths's propeller, at a draught of water of 12ft. 5in. aft, and 10ft. 9in. forward. On her trial at light draught, prior to her commission, drawing 11ft. 5in. aft, and 7ft. 1in. forward, using the Admiralty or common screw, she attained a speed of 10.551 knots. The diameter and pitch of the screw being in both cases nearly the same, the Griffiths used in the present trial being 9ft. diameter, with a pitch of 12ft. 6in.; and the Admiralty screw used in the trial at light draught only differing from Griffiths's in having 2in. less pitch. The *Torch*, a sister vessel to the *Philomel*, on her deep draught trial, made 8.843, the draught of water being about equal. The *Ranger*, also a sister vessel, on her deep draught trial, drawing 4 $\frac{1}{2}$ in. less than the *Philomel*, made 8.381 knots.

THE "WANDERER," 4, gunboat, 200 horse power, on the 14th ult., proceeded to the measured mile off Maplin Sand for the purpose of testing her machinery. The trial lasted five hours, and was most satisfactory. The vessel made six runs, and attained a mean speed of 10 $\frac{1}{2}$ knots per hour; revolutions, 92; draught of water forward, 8.7; aft, 10.7 pressure of steam, 20lb.; vacuum, 25.

THE "PELICAN," 17, screw, just completed in the fitting of her machinery by Messrs. Ravenhill, Salkeld, and Co., made her official trial of speed on the 14th ult., at the measured mile in Stokes' Bay. The ship drew 12ft. 2in. aft, and 11ft. forward, being in light trial, and about 16in. less than she will be with guns, cables, masts, and rigging on board. She was propelled by a Griffiths screw of 12ft. diameter, and a pitch of 14ft. 5in.; pressure of steam, 20lb.; vacuum, 25; revolutions of engines, maximum, 112; mean, 110. The mean of six runs gave the ship a speed in knots in 11.350, the boilers and machinery performing their duty well.

THE "BAROSSA," steam corvette, 21 guns, 400 horse power, was taken to the Maplin Sands on the 16th ult., for the purpose of testing her machinery and capabilities at the measured mile. The *Barossa* is a new and handsome vessel, lately launched at Woolwich, and built from plans designed by Sir Baldwin Walker, late Controller of the Navy. She is a sister ship to the *Jason*. Her length between perpendiculars is 225ft. 6in., her beam, 40ft. 6in., and her tonnage, 1650. Her engines are built by Messrs. Watts and Son, of Birmingham. During her trial, the vessel was tested in every manner, and found to work exceedingly well, and with very little vibration. She attained an average speed of 12.19 knots per hour, giving a draught of water forward of 15ft., and aft 17; mean revolutions, 66; pressure of steam, 20; indicating horse power, 800; nominal horse power, 400. She is propelled with one of Griffiths's screw propellers, the diameter of which is 16ft., and the pitch 24ft.

RAILWAYS.

THAMES EMBANKMENT AND RAILWAY BILL.—The object of this bill is to authorise the embankment of the Thames on the Middlesex side, between Westminster and Blackfriars bridges, so that it may be rendered available as the site of a main sewer and of a railway, and afford space also for a road and for approaches. The estimated expense of the embankment, works connected with it, road, and approaches, is £600,000, and of the railway, £75,000. Power is proposed to be given to the Commissioners for Woods, Forests, and Land Revenues, to contribute any funds that Parliament may place at their disposal for that purpose, towards the undertaking. It is to be competent for the Metropolitan Board of Works to construct the embankment, a sewer for the main drainage of the metropolis, and contribute a sum of £400,000, out of any funds placed at their disposal by Parliament. The approaches to the roadway will be from Whitehall-place and Waterloo-bridge, and the eastern end of the embankment will unite with the line which the London, Chatham, and Dover Railway are authorised to construct to Farringdon-street, there communicating with other railways, having terminal stations in the city, and power is to be given to such railways to contribute. Borrowing powers are to be sought in addition to the original capital, to the extent of £100,000. The work is proposed to be completed in five years.

AUSTRALIAN RAILWAYS.—Eight railways now radiate from Melbourne, proceeding from three stations. The following is a list of those now in operation:—Melbourne, St. Kilda, and Brighton, 8 miles; Melbourne and Sandridge, 2½ miles; Melbourne and Williamstown, 9 miles; Melbourne and Geelong, 47 miles; Melbourne and Sumbury, 24 miles; Melbourne and Essendon, 4½ miles; the suburban two branches, 7 miles—total, 102 miles. The Sandhurst line will be open to Woodend, about 22 miles beyond Sumbury, in April or May. The practicability of street tramways is under discussion in the City Council, and locomotives on common roads are actually in use in New South Wales.

THE NERUBDA BRIDGE, on the Bombay, Baroda, and Central India Railway, has 60 spans of iron, and is of a total length of 3750 ft. The Taphu Bridge, on the same line, has 32 spans, and its total length is nearly 2000 ft.

THE PARIS, LYONS, AND MEDITERRANEAN RAILWAY, whose lines now comprise 1201 miles, is the largest establishment of the kind in the world. Its receipts for January were £356,667, whilst those of the London and North Western (966 miles) were £290,093.

THE MIDLAND RAILWAY now has 451 locomotive engines, 17 new goods' engines having been purchased during the last half-year. These engines are worked upon 678 miles of lines.

CHARING CROSS RAILWAY.—The new Cannon-street branch of the Charing Cross Railway is to be 900 yards, or rather more than half-a-mile long, and, including a bridge over the Thames, is estimated to cost £525,000.

LANCASHIRE AND YORKSHIRE RAILWAY.—On this line an experiment has been in progress for the last two years, to determine the best kind of rails, "every possible description, without regard to price," having been put down where the traffic was heaviest. The results are not yet determined.

RAILWAY NOTES FROM THE NORTH.—The line branching off the Great North of Scotland Railway, 6 miles out of Aberdeen, through the eastern districts of the county to Peterhead and Fraserburgh, and called the Formartine and Buchan Railway, is expected to be opened to Mintlaw, 30 miles from the junction, on the 1st of May this year. A line is making, and expected to be opened in July, 1861, from Keith (the northern terminus of the main line), to Pufftown (westward); a Bill is in Parliament this Session, for an extension of this line from Pufftown up the Valley of the Spey to Grantown (where Her Majesty spent a night last autumn). There are immense forests of fir, the largest in Scotland, at Abernethy, to which this line will open an access, and which are at present almost valueless for want of it. This line crosses the Spey three times, and as there are several sharp curves in it, it is proposed to employ Bogie engines only, instead of the ordinary locomotives. The Great North of Scotland Railway has leased the Morayshire Railway from Lossiemouth, a seaport on the Moray Frith, through Elgin to Rothes; a junction of a couple of miles will be made between the Pufftown line and it, each company making up to the Spey—the bridge across it to be mutual—and working from this on to Elgin. All these branches are independent companies, to which the Great North of Scotland Company, supplies the rolling-stock for these lines, and works them, but gives no guarantees to them. The above lines just described as being in progress will, when completed, give a total length of nearly 250 miles of single line. The main line has been doubled from the Kittybrewster station to the junction of Formartine and Buchan Railways, as the latter must be worked as a main line out of Aberdeen; it is too expensive to be worked as a branch of this line. A bill is also in Parliament this Session to double the line from this station to the terminal station in the town, and the latter station is to be fully doubled in size; in the same bill, powers are taken to purchase here, Kittybrewster, ground to build a complete new set of workshops. It is rumoured again that the Great North of Scotland line and the Scottish North Eastern line are to be joined by a line through the centre of Aberdeen, both companies working out of a joint station. There is no doubt, if this is done now, it will save the former company having eventually to double the present line between Kittybrewster and Aberdeen, and enlarging the stations. A bill is in Parliament this Session for a line from Forres, 25 miles this side of Inverness, on the Inverness and Aberdeen Railway to Dunkeld, through the centre of the Highlands, by "the pass of Killiecrankie." This line is promoted by the Inverness and Aberdeen Junction Railway, which joins the Great North of Scotland line at Keith, and goes to Inverness. It is expected to catch all the through traffic, there being little, if any, local traffic. We consider, however, that if the line is ever made, it will prove a very expensive undertaking. We understand there would be gradients on it of 1 in 65 for 20 miles at a stretch.

THE OLDHAM, ASHTON-UNDER-LYNE, AND GUIDE-BRIDGE JUNCTION RAILWAY will, under ordinarily favourable circumstances, according to report delivered by the engineer, be ready for traffic in May next.

THE PERFORMANCE OF THE NEW EXPRESS ENGINES, with 8 ft. driving wheels, on the Caledonian Railway, is reported very satisfactory, notwithstanding that they are worked on long inclines of 1 in 75.

AT A SPECIAL MEETING of the South Staffordshire proprietors, a resolution to accept the proposal of the London and North-Western, to lease the line, transferring Mr. M'Lean's lease, was carried by a poll.

THE LONDON AND NORTH-WESTERN working stock, included on the 31st December last, 839 locomotive engines: 737 first-class, 576 second-class, and 434 third-class carriages; 15,565 goods waggons, besides about 4000 other vehicles of various descriptions. The total charge to capital, including moveable machinery and tools, is £3,427,837.

TELEGRAPHIC ENGINEERING.

RED SEA AND INDIA TELEGRAPH.—The difficulties between the Red Sea and India Telegraph Company and Messrs. Newall have finally been settled in a satisfactory manner, viz., the company are to pay Messrs. Newall the gross sum of £65,000, which sum will include the drawback, amounting, with interest, to £26,500, thus leaving £38,500 only to be provided for out of the funds of the company.

THE LONDON DISTRICT TELEGRAPH COMPANY have sixty stations now open.

THE RED SEA AND INDIA TELEGRAPH cost £70,000, and for this outlay twelve messages were sent, making the cost of each message £5833 6s. 8d.

PRIVATE TELEGRAPH.—Railway and Gas Companies, are beginning to avail themselves of the private wires, and within a short time it is expected that the system will be extended to all the Government departments, to St. Martin's-le-Grand, and the district post offices, to the fire engine stations, the clubs, theatres and the courts of law.

FRENCH TELEGRAPHS.—Preparations are now in process for establishing a new line of electric telegraph between Paris and London, by Dieppe and Newhaven. Three wires from Paris will meet one from Havre, at Malaunay, and the four will cross the Channel from Dieppe to Newhaven. When this line is completed, France will be connected with England by twelve wires, four from Calais to Dover, four from Boulogne to Folkestone, and four from Dieppe to Newhaven. These last are especially intended to connect Lyons, Bordeaux, and Marseilles directly with London.

MEDITERRANEAN TELEGRAPH.—The English screw steamer, *William Corry*, arrived at Malta on the 16th ult. from Otranto, having successfully completed the submarine line of telegraph between Otranto and Sidari, at the north-end of the Island of Corfu. The land line at Otranto, connecting the cable end with that town, is completed, and the line will shortly be open for communication. Steps will be taken during the summer months to repair and the Malta and Corfu, and the Malta and Cagliari lines. It is expected that the Malta both Alexandria cables will be out at the end of April or beginning of May, and Her Majesty's ship *Medina* is at present engaged completing the soundings along the proposed route.

THE MALTA AND ALEXANDRIA CABLE.—The cable shipped originally on board the *Queen Victoria* for service at Rancon, but now intended for the Mediterranean, continues in the hold of the Government brig *Pilot, Rover*, and corvette *Arachne*, which are moored near the Royal Albert Bridge, in Hamoaee, where it has been for the last month, and from where there is no immediate prospect of its removal.

MILITARY ENGINEERING.

THE WHITWORTH GUN.—The experimental firing from the 80-pounder Whitworth gun at Portsmouth was brought to an abrupt termination by the discovery of a flaw or rent in the metal at the breech. The gun, which weighs four tons, has been landed from the *Stork* gunboat, and forwarded to Woolwich. Many naval officers, experienced in gunnery, are of opinion that the principle of the gun, in working metal upon metal, is radically wrong. They argue that if any foreign substance is introduced into the bore of the gun, such as a cinder from the funnel, and should get between the inner surface of the gun and the projectile, the latter would infallibly jam, and the gun would burst.

A SET OF VERY POWERFUL SHEERS, worked by steam power, and adequate to lift the largest class of marine boilers and machinery, is in course of construction by Messrs. Jackson and Watkiss, at the Canal Iron Works, Poplar, for the use of the port of Sebastopol.

THE EXPERIMENTS AT PORTSMOUTH, now being conducted, both for the purpose of testing the new rifled cannon, and their effects against iron-cased vessels, have come to a stand-still by the failure of the guns employed. First, the 100 pounder Armstrong was found defective in the proving, and lately the 80-pounder Whitworth has also failed. Practice with the latter has been carried on from the *Stork* gun-boat, by Captain Hewlett, of the *Excellent*, at the Sirius, whose sides are cased with iron armour on the angulated system, and the result of the firing at 300 yards distance was a penetration of only 2½ inches, while the polygonal bolts dropped alongside broken. The firing from the 68-pounder solid shot, smooth bored, gave better results, inasmuch that a few blows in the same spot would have driven the whole plate in. Armstrong's powder was used with the Whitworth, in order to give every advantage to the gun, it being of a slower combustion, important when the tremendous pressure excited by the bolt on first starting down the polygonal grooves is considered. It was not until the following morning that, when the gun was cleaned, a rent across the breech-band was discovered. Whatever may be the result of the report on the Whitworth rifling, it is now pretty clear that of the breech-door, and the screw, is sufficiently objectionable; grit from the funnel, or any dirt getting among the threads of the screw, which are quite exposed, shut up the fire of the gun altogether; and with respect to the pressure on the grooves, we venture to think that the callipers would show some slight enlargement of the bore at the breech end after continuous firing.

THE WHITWORTH ORDNANCE.—Four Whitworth 80 pounder guns, made on the muzzle-loading principle, are about to be tried. Two have been made at the Royal Arsenal, Woolwich, and two at Manchester. The 80 pounder, which, during the recent official experiments at Portsmouth, was found defective, is the same which was subjected to a great variety of trials in 1860, and which was fired at Southport in February in that year. In August last an account was given of practice obtained with this gun at 5 deg., when a range of upwards of 3000 yards was obtained, and the charge used was 10lbs. of powder. When the same gun fired its 80lb. projectiles through the plates and sides of the *Trusty*, charges of 12lb. and 14lb. powder were used, and the latter was the largest charge Mr. Whitworth appears ever to have employed. But when the gun was officially proved at Woolwich, after upwards of a year's experimental firing, it is asserted that the very large charge of 24lb. powder was used. It is not unlikely that so large a charge strained and permanently injured the gun, built up as it is of two series of hoops. With regard to the general working of the principle of firing hard metal projectiles from rifled bores, it is argued that Mr. Whitworth has fired from one of his small field guns upwards of 2000 rounds, and the bore shows no mark of injury. In the case of large guns, both Sir W. Armstrong and Mr. Whitworth have great obstacles to overcome, owing to the peculiar construction required to give the necessary strength, and the difficulties arising from defects in materials wrought in large masses.

THE ARMSTRONG GUNS.—In the House of Commons, in reply to a question, the Under Secretary for War, Mr. T. G. Baring, said, the reports received with respect to the mode in which the Armstrong guns did their work in China were very satisfactory. They related to a number of points of small detail—to the fuses and the different portions of the guns. But he was inclined to think it would not be for the advantage of the country to make those reports public, although he was quite willing to allow any hon. member who might desire to inspect them the opportunity of doing so.

LAUNCHES OF STEAMERS.

LAUNCH OF HER MAJESTY'S SHIP "CHANICLEER."—This 17 gun screw sloop, 200 horse power, was launched from No. 2 ship at Portsmouth Yard, on Saturday morning, 26th Jan., at eleven o'clock. She is a fine vessel, and sister ship to the *Rinaldo*. The following are her principal dimensions:—Length between perpendiculars, 185ft.; length of keel for tonnage, 33ft.; breadth moulded, 32ft. 4in.; depth in hold, 17ft. 6in.; burthen in tons, 9,850-8-94. On the dogshores being knocked away, and hydraulic power applied, she went away beautifully, and was immediately after her launch taken into the steam basin to receive her engines, and to be brought forward for commission. The admiralty superintendent, and several naval and military officers were present at the launch. One of the daughters of Admiral Grey performed the ceremony of christening. The whole arrangements reflect great credit on the master shipwright, Mr. Abethell, and those under him. The public not being generally aware of the launch, were not, as is generally the case, present. The *Glasgow*, frigate, will be launched next month.

TWO SCREW STEAMERS were launched at Dundee in one day, and at one tide, on the 9th ult. One of the vessels launched is a wood-built screw steamship, specially constructed for the seal and whale fisheries; the other an iron screw steamer, built on speculation. The steamship for the Arctic trade was built by Messrs. Stephen and Son. The *Polynia* is 140ft. long, 29ft. broad, and measures 560 tons. The iron screw steamer *Dalhousie* was launched from the shipbuilding yard of Messrs. Gourlay, Brothers, and Co. This vessel is about 150ft. long, 20ft. broad, and 11ft. 3in. deep. The *Dalhousie* took the water in excellent style, in the presence of a great multitude of people, and was at once taken charge of by the steam tug *Sampson*, and towed into dock, where she is being fitted out for the trade between Newcastle and Dundee.

LAUNCH OF THE "AJAX."—On Jan. 31, 1861, was launched from the steamship works of Messrs. Stothert and Martin, an iron paddle wheel steam vessel, called the *Ajax*. She is 100ft. long, 19ft. beam, and is fitted with strong and well-finished engines of 80 horse power on the side-lever principle. She has fine boilers of great size and strength, made entirely of Messrs. G. B. Thornycroft and Co.'s best iron. She is built for the Bristol Steam Towing Company, and will be the largest and most powerful steamship in their fleet. She is a handsome ship, and is the only iron one of that character that has ever been entirely constructed in Bristol by one firm, the hull, machinery, and boilers being made and fitted complete by Messrs. Stothert and Martin. She will be one of the fastest vessels of the class in the Bristol Channel. It is gratifying to see that the company are promoting the building of their vessels and machinery in Bristol, where their money is made.

The "BRISTOL," screw steam frigate, 51 guns and 600 horse-power, huilt at No. 1 slip Woolwich, was successfully launched on the 12th ult. The *Bristol* was subsequently removed to the basin, to be fitted with her engines and machinery, manufactured by Messrs. Napier, of Glasgow. The following are her exact dimensions:—Length, extreme, 255ft.; length between perpendiculars, 250; length of keel for tonnage, 214ft. 7in.; breadth, extreme, 52ft.; breadth for tonnage, 51ft. 6in.; breadth, moulded, 50ft. 8in.; depth in hold, 18ft. 8in.; burthen in tons, 3027—40-94; armament, one 68-pounder pivot-gun, 30 65-cwt., 9ft. guns, 20 32-pounder 68-cwt. guns.

The "SPEEDWELL," screw steam-vessel of five guns, and 425 tons burthen, was launched in a most successful manner, at Deptford Dockyard, on the 12th ult. The *Speedwell* is now in the basin, to be fitted with her machinery and engines of 80 horse-power, which are manufactured by Messrs. Day & Simmons, of Southampton.

RAILWAY ACCIDENTS.

FATAL ACCIDENT ON THE LONDON AND SOUTH-WESTERN RAILWAY.—An accident of a very serious character occurred on 28th January last, to the 5.10 p.m. direct Portsmouth train, on the above line, near Wimbleton station, which resulted in the tender and four carriages being thrown off the line. One passenger (Dr. Baly) lost his life, and two others sustained serious personal injury.

FATAL ACCIDENT AT THE CRYSTAL PALACE RAILWAY STATION.—On the 11th ult., two passengers were killed while crossing from the London, Dover, and Chatham Railway, to the train from the Crystal Palace to London-bridge. When the London and Chatham was first opened, a porter was always there to see that the passengers did not cross while the train was coming in; but of late the crossing has often been left without any one to warn the passengers.

BOILER EXPLOSIONS.

FATAL BOILER EXPLOSION.—On the 4th ult., a lamentable accident took place at the paper manufactory of Messrs. J. Dickinson and Co., Manchester. About seven o'clock the boiler of the works exploded, injuring four persons so severely that two have since died, and the others are in a very precarious state.

FROM BOILER EXPLOSIONS IN STEAMSHIPS, and other accidents to them in the United States during the past year, the lives lost have been 474. Of this number, 125 were from explosion; by collision, 308; by fires, 41. It is quite common for sloops and schooners in the United States to run at night, both at sea and on rivers, without a light! and when a steamboat comes snorting up in dangerous proximity, there is usually a desperate rush made to display a tallow candle at the head or stern.

THE ASSOCIATION FOR THE PREVENTION OF STEAM BOILER EXPLOSIONS.—At the monthly meeting of the executive committee, held on Tuesday, the 29th Jan., Mr. L. E. Fletcher, C.E., chief engineer, presented his report, from which the following are extracts:—We have made 92 visits, and examined 199 boilers and 165 engines. Of these visits, three have been special. Of these boilers, 2 have been specially, 159 externally, 6 internally, and 32 thoroughly examined. Eight cylinders have been indicated at ordinary visits. The principal defects met with during the month are as follows:—Fracture, 4 (1 dangerous); corrosion, 15 (2 dangerous); safety-valves out of order, 5 (1 dangerous); water gauges out of order, 4; pressure gauges ditto, 4; blow-off cocks ditto, 6 (2 dangerous); fusible plugs, 4; furnaces out of shape, 1 (dangerous); over pressure, 1. Total 44 (7 dangerous). Boilers without water gauges, 3; blow-off cocks, 15; feed check valves, 8. The chief engineer in his report, which is too long for insertion *in extenso*, remarked that two boilers had been inspected during the last month, which, although working at a pressure of 10lb., yet were not fitted with their own independent safety valves, but had to rely for the escape of their steam upon the safety valves of some adjoining boilers, the communication to which could be intercepted, and the arrangement, was consequently pregnant with danger. Attention was called in the report to the too frequently disregarded weakening effect of steam domes upon the shells of boilers, reference by way of illustration being made to an explosion which took place lately to a boiler, not under the inspection of this association, which, though of good material and workmanship, went right through the opening for the steam dome, the dome itself being blown completely over the mill. This explosion was attended with fatal consequences, and two other explosions, equally disastrous, had occurred during the last few weeks. Neither were these two boilers under the inspection of this association, and had they been under inspection there is every reason to conclude that these lamentable effects might have been prevented.

MANCHESTER STEAM BOILER ASSURANCE COMPANY.—In addition to the report we gave last month we give now some further details. Two boilers sustained injuries to the flues, and have been repaired at the expense of the company. One of these accidents resulted from the deficiency of water. This boiler is provided with glass tube water gauge, and the usual mountings, all of which appear to have been in working order, with the exception of a check valve on the feed pipe, through which the water must have passed, and thus escaped into the adjoining boiler not in use. The other boiler which sustained damage is provided with one of Hopkinson's safety valves, and a glass tube water gauge, neither of which gave any indication of deficiency of water; but the crown of the furnaces, where the collapse occurred, gave unmistakable evidence of overheating. This can only be accounted for by the presence of a peculiar kind of deposit, which does not form a hard scale, as commonly found in boilers, but is precipitated in a very fine powder. It is generally found, where there is a deposit of this kind, overheating takes place, notwithstanding abundance of water in the boilers. It is very important, therefore, in such cases to obtain water from another source. The flues of the boiler referred to are 26ft. long by 2ft. 10in. in diameter, made of 7-16th plates, and the working pressure 50lbs. per square inch. The boiler has not worked many months, and, under ordinary circumstances, is well calculated to sustain this pressure. Both flues collapsed in the furnace part, but with the exception of one or two edges of the plates they were not fractured, and the quality of the iron appeared to be good.

UP TO THE DATE of the last report of the Manchester Association for the Prevention of Steam Boiler Explosions, but three boilers among all those under the inspection of the association (constantly averaging nearly 1500) had exploded in six years.

FEARFUL LOCOMOTIVE EXPLOSION.—A locomotive explosion occurred on the Blyth and Tyne Railway on the 23rd ult. A locomotive was standing at the Blyth Station, ready to take away the early train, when its boiler suddenly burst. The engineman and fireman were both very severely injured. The boiler, after exploding, separated into three parts; one part was hurled through the end of a house opposite the station, which is nearly all blown in, a large piece of the boiler being lodged in the upper room. Another portion was pitched into a stable. The third part was carried into an arm of the river covered by the tide at high water. A carriage next the engine was completely smashed up. The locomotive itself is a complete wreck.

WATER SUPPLY.

THE WATER SUPPLY of the borough of Whitehaven is said to be the softest in the kingdom.

DURING the present winter, at a time when the temperature of the air over Loch Katrine was from 12 deg. to 14 deg. below the freezing point, no ice formed upon that lake.

GAS SUPPLY.

GAS ON RAILWAYS, ETC.—Gas for lighting railway carriages and steamboats is used in America at both high pressure, and at ordinary atmospheric pressure. The high pressure holders are charged with gas at a pressure of 400lb. per square inch.

FEARFUL EXPLOSION OF A GASOMETER.—An explosion of gas, attended by serious injuries to several persons, took place lately at the gas company's works in Walker-street, Preston. It appears that an enormous gasometer was in course of construction by Messrs. Houghton and Co., of Birmingham, and nearly completed. It was 105ft. in diameter, and 44ft. in height when inflated, the tank of water in which it was floated being 23ft. deep, and it was estimated to contain 330,000ft. of gas. At the time of the explosion, about half-past ten, two men were engaged on the work, and were assisted by two labourers. To state distinctly the precise cause of the explosion appears almost impossible, and it may never, perhaps, be known unless one of the unfortunate sufferers can distinctly explain it. One man, who was sitting on the top of the holder, after being blown into the air, fell into one of the rents, and was held in the crevice by the neck until rescued, otherwise he must have fallen into the water beneath and been hopelessly lost. The others were fearfully scorched and bruised. One leaped over the wall with his clothes in a state of flame. The "outfit," or lower portion of the holder, which remained entire, was completely displaced from its position, one edge being level with the water in the tank, and the other being 20ft. above the edge of the water. Within this space lay the collapsed dome, bent and crushed to an indescribable shape. The columns remain standing, and only one of them is injured, that one having a large fracture on the side nearest the holder. All the connecting bridges are fractured, and the conducting rods broken like so many matches. The heavy iron slabs suspended as weights to the chains fell with a frightful crash, smashing the stonework, and cutting up the earthwork near.

DOCKS, HARBOURS, CANALS, &c.

LIGHTHOUSES.—The number of lighthouse stations on the Atlantic, Gulf of Mexico, and Pacific Coasts, is 223 exhibiting 369 lights. The number of light-vessel stations on the same coast is 42, and the number of lights exhibited, 55. On the lake coasts there are 91 light-stations, exhibiting 115 lights, making a grand total of 456 light-stations, and the lights exhibited, 539.

A GIGANTIC GRAVING DOCK.—The Mersey Dock Board are about to construct a gigantic graving dock at Birkenhead. It is to be 750ft. long, 85ft. wide, and 106ft. deep. The estimated cost is £34,000. There will be accommodation for two rows of vessels on griddons at each side of the dock, the construction of which is to be proceeded with as fast as possible.

DRY DOCK AT PEMBROKE.—The completion of this dock is being urged on night and day, relays of men relieving each other every 12 hours; when finished, it will be capable of accommodating the largest ship in the British Navy. A gradual reduction of the establishment, both of skilled artisans and labourers, is to take place at Pembroke. The number of men employed is about 1300.

IMPROVEMENTS AT CHATHAM.—The Lords of the Admiralty have decided on making several improvements at Chatham Dockyard, for which purpose the sum of £35,000 has been taken in the estimates, in addition to the large sums previously voted by Parliament.

MINES, METALLURGY, &c.

PREVENTION OF OVER-WINDING.—An ingenious contrivance for preventing accidents from over-winding of safety cages is now being largely introduced. The invention consists in the use of a shackle formed of three steel plates, provided with slots similar to those employed in the formation of hayonet joints; the one being right-handed, and the other left-handed; when the chain is introduced, the blades are drawn apart, and the link is thus tightly fixed in the upper part of the slots; a rivet of soft iron is then passed through both plates, which effectually prevents the release of the link, except in case of over-winding, when the outer sides of the plates or blades, being drawn through a ring, cuts the soft iron bolts, and permitting the slot to open, disengages the cage.

IRON ORE DISCOVERY.—Upon the discovery of iron ore on the estate of Sir Cullen Eardley, at Nettleton, the Hon. Baronet became desirous to have the most accurate information respecting it, and sent samples to the Geological Institution, London. The report is very satisfactory. Iron in its metallic state of first-rate quality has been obtained. Some persons who understand the different properties of iron say it is very much too fine for laundry purposes, and it is argued therefrom that a large portion of North Lincolnshire must one day become a manufacturing as well as an agricultural district, being the centre of a large corn and cattle-growing country.

CAST PLATINUM.—At the last sitting of the Academy of Sciences of Paris, M. Deville exhibited two ingots of platinum, weighing together a little over 55lb., which had been melted in the same furnace, and run into an ingot mould of forged iron. He states that platinum may be melted in any quantity; and once melted, it behaves precisely like gold or silver, requiring exactly the same precautions as in casting the precious metals. He also exhibited a platinum cog-wheel, cast in an ordinary sand mould in the same way as other metals; thus giving a new proof of the possibility of giving platinum all the forms that may be desired by the process.

BISMUTH.—The eminent chemist M. Nicklès has laid before the French Academy of Sciences an account of some experimental researches on bismuth, which, he asserts, proves that bismuth is a "demi-metal," and in common with tellurium, arsenic, antimony, and tungsten, establishes a transition between the metalloids and the metals. Like them, also, it is neither ductile nor malleable, qualities possessed by all bodies, the metallicity of which is uncontestable.

COFFEY, containing twenty-four per cent. of phosphorus, will resist a strain of 48,000lbs. to the square inch.

CUMBERLAND BLACK LEAD.—A valuable discovery has taken place of a new sop, or pipe, of pure plumbago, fully confirming the opinion expressed by Captain Dixon, in his report of 1859, since which date the company have sold several parcels of wad at from 35s. to 45s. per lb., being equal to £3500 to £4500 per ton. A good demand for this new deposit of wad has been already received.

THE COAL SUPPLY TO THE METROPOLIS.—The quantity of coal and coke carried into the metropolis for the year ending Jan., 1861, shows an enormous increase on preceding years. No less than 1,477,545 tons have been conveyed from various parts of England to London, by the railways having access thereto, the London and North-Western, and the Great Northern carrying the greatest proportion. The following is the actual tonnage of each railway company. The London and North-Western, 693,413 tons; Great Northern, 502,313 tons; Eastern Counties, 121,225 tons; Great Western, 63,944 tons; Midland, 58,490 tons; South Western, 17,589 tons; South Eastern, 14,555 tons; Hertford, Luton, and Dunstable, 4416 tons; London, Tilbury, Southend, 953 tons; and the London and Brighton, 104 tons. Of this aggregate one-ninth has been produced from the Claycross pits, near Chesterfield. For the year the seaborne importation has been 3,573,377 tons, brought by 11,226 ships, against 3,299,170 tons by 10,693 ships, being an increase of 274,207 tons and 533 ships.

A NEW KIND OF BRONZE.—Workers in metal are finding good uses for a new kind of bronze, made by melting together ten parts of aluminium with ninety of copper. It is described as being tenacious as steel, and well adapted for the bearings of machinery. A polisher, who used it for bearings in his lathe, which made 2000 revolutions a minute, found it last six times longer than bearings made of other kinds of metal. It is good also for pistol barrels, and is to be tried for rifles and cannon.

THE PROPERTIES OF NICKEL.—Some new facts were recently laid before the Academy of Sciences on this subject by M. Tissier, who contends that, as regards resistance to the action of acids (with the exception of nitric acid), nickel is superior to iron, zinc, copper, lead, and tin; and that in tenacity it is also superior to iron (in the proportion of 90 to 70). M. Moigno states that in the smaller coinage of America, nickel has been already employed. The applications of this metal in the arts will doubtless increase.

IRON IN KENT.—Now that the iron in the Southern counties is exciting some interest, it may not be generally known that there is abundance of iron ore in Lamberhurst. It was in this parish that the most celebrated furnaces in the kingdom were situated; it was at one of these furnaces that a large portion of the ordnance used in our navy were cast; here, also, the iron balustrades that now surround St. Paul's were cast. The railings and gates for St. Paul's weighed upwards of 200 tons, and cost £11,200.

COAL WORKINGS.—IMPORTANT DISCOVERY.—The proprietor of the gasometer at Blaenavon states that he has found a method by which the explosive carburetted hydrogen gas which accumulates in coal mines can with safety be extracted. The invention is very simple. A receiver, containing a siphon pipe, is to be placed in the pit's mouth, and connected to gas pipes of a sufficient size, which are to be carried down the pit, and through the workings; branch pipes being attached to the main pipe, with stop-cocks at all necessary points. These branch pipes, for conveying the gas to the main, are to be inserted in the roof, or any other part of the workings, where gas is found to accumulate. The receiver on top of the pit is to be filled with gas, and a burner attached to the receiver will be lit. By these means, all the gas which may be in the pipes will be sucked up through the receiver, the burner of which will keep lit as long as any gas remains in the pipes. Mr. Williams, the proprietor, has constructed the apparatus on a small scale at his gasometer. This has been inspected by several scientific gentlemen, all of whom have pronounced very favourably of its performance.

CEMENTATION OF IRON.—The process by which iron is converted into steel generally consists in making it combine with a small quantity of carbon; and very frequently, owing to the brittleness of steel when tempered to the highest degree, it is desirable to give the qualities of steel to the surface only of a bar of iron. This is done by enclosing it in a box of sheet-iron, filled with charcoal-dust, or horn-savings, tallow, &c. Here the question naturally arises whether carbon combines with the metal under a solid form,

which is scarcely admissible, or else is absorbed in the shape of some carburetted gas; and, in the latter case, it is useful to know what gas is generated in the process. On this subject M. Caron has just addressed a paper to the Academy of Sciences, in which he describes several experiments of his to show that the cementation is owing to the formation of a cyanide, cyanogen being, it is well known, a compound of carbon and nitrogen. Having filled a porcelain tube with fragments of charcoal surrounding a bar of iron, and exposed it to the heat of a reverberatory furnace, he successively caused hydrogen, oxide of carbon, azote, air, pure carburetted hydrogen, &c., to pass through the tube, but could not, after a two hours' fire, obtain any degree of cementation. But the case was far different when he made a current of dry ammonia pass through the tube; in that case the cementation was effected rapidly and easily; after being exposed to the fire for two hours, the bar of iron being immediately tempered, then hammered to make the grain closer, and then tempered once more, proved, on being broken, to have been cemented to a depth of two millimeters. This result M. Caron attributed to the formation of the cyanide of ammonium, and further experiments confirmed this idea. M. Caron then, in order to obtain cyanide of potassium in his tube as a cementing agent, let his charcoal soak in a solution of carbonate of potash, and the experiment succeeded beyond expectation. In the same manner he obtained excellent cementations by employing soda, barytes, and strontian, under the influence of a current of air. Hence he shows that all the various nostrums used in metallurgy for cementing iron owe their efficacy to the formation of cyanides.

APPLIED CHEMISTRY.

ON THE INSOLUBLE MATTER OF ZINC, BY G. F. RODWELL.—In making hydrogen by the action of dilute sulphuric acid on commercial zinc, we observe a number of black flocculent particles floating on the surface of the liquid, which, when the zinc is all dissolved, gradually sinks to the bottom, and crumble down to a greyish powder. This residue in 100 parts of ordinary sheet zinc, amounted to,

I.	II.	III.	IV.
13142	13661	13388	13017

or, taking the mean of the four determinations, 13339. It was found to consist of sulphate of lead, together with about five per cent. of carbon, and a trace of iron. The black particles appear to be suboxide of lead, which, when the evolution of hydrogen has ceased, and not till then, are slowly converted into sulphate of lead. The lead undoubtedly exists in the zinc as metallic lead, and its quick conversion into suboxide is probably due to the electric current which is established between it and the zinc with which it is in contact; for if a clean piece of lead be immersed in dilute sulphuric acid, it will remain bright for some time; but if, now, a piece of zinc be placed in the liquid, so as to wash it, the lead will be speedily coated with a black film.

LIST OF NEW PATENTS.

APPLICATIONS FOR PATENTS AND PROTECTIONS ALLOWED.

Dated October 15, 1860.

2514. P. R. Smith, Essex-street, Strand—Fire-arms and ordnance.

Dated October 25, 1860.

2598. A. Verwey, 3, Croydon-grove, Croydon—Manufacture of soap.

Dated November 5, 1860.

2708. E. F. Prentiss, Philadelphia, U.S.—New detergent.

Dated November 6, 1860.

2724. C. Neumann, U.S.—Manufacture of hoop skirts.

Dated November 13, 1860.

2734. L. Saccardo, Venetia—Apparatus and arrangement of paper for the substitution of this latter instead of the cards of Jacquard looms.

2786. W. Clark, 53, Chancery-lane—Improvements in looms.

Dated November 19, 1860.

2838. G. Chown, Dipperton, New Down, Crediton, Devonshire—Obtaining motive power by hydraulic means.

Dated November 21, 1860.

2850. W. Clark, 53, Chancery-lane—Improvements in journal or axle boxes for railway carriages.

Dated November 24, 1860.

2880. P. C. H. Charbol and A. Berson, Paris—Cages and aviaries for birds.

2890. S. M. Fox, New York, U.S.—Improvements in rails for railways, and in the wheels of carriages to run thereon, especially adapted to street railways.

Dated November 26, 1860.

2894. G. F. Train, Liverpool—Improvements applicable to street railway carriages, part of which are suitable for other purposes.

Dated December 3, 1860.

2958. R. E. Keen, 15, Old Change—Improvements in cocks, taps, valves, and other apparatus for stopping and regulating the flow of liquids, steam, and gas.

Dated December 5, 1860.

2988. C. J. Duméry, 29, Boulevard St. Martin, Paris—Apparatus for extracting from water or any liquid, the bodies in dissolution.

Dated December 10, 1860.

3031. W. E. Newton, 66, Chancery-lane—Improvements in machinery for quartering cork-wood, and for cutting the quarters into bottle corks.

Dated December 11, 1860.

3037. J. Hamerton, Shibden, near Halifax—Manufacturing certain textile fabrics.

Dated December 12, 1860.

3051. G. S. Harwood, Bradford—Machinery for drying, stretching, and tentering cloths.

Dated December 14, 1860.

3050. H. Barber, Belgrave, Leicestershire—Lamps used in Mines.

Dated December 17, 1860.

3093. J. W. Hill, 3, Philadelphia-place, Hackney-road—Sewing machines.

3096. E. Barlow, Bolton-le-Moors, J. Newhouse, Farnworth, and F. Hamilton, Bolton-le-Moors—Machinery for carding cotton and other fibrous substances.

3099. M. Henry, 84, Fleet-street—Fishing nets.

Dated December 18, 1860.

3104. C. Stevens—A new mode of obtaining an article resembling honey, and to be used as a substitute therefor.

3108. W. Scholes, Leeds—Wire card-covering for carding wool, silk, flax, tow, cotton, jute, or other fibrous substances.

3113. J. H. Johnson, 47, Lincoln's-inn-fields—An improved compound felted and textile fabric.

Dated December 20, 1860.

3128. T. Sykes and B. C. Sykes, both of Cleckheaton, Yorkshire—Furnaces.

Dated December 21, 1860.

3136. D. A. Morris, Pittsburgh, U.S.—Improvements in the manufacture of sheet iron.

Dated December 22, 1860.

3151. A. Savage, 42 and 43, Eastcheap—Apparatus for separating, reducing in size, and mixing articles of grocery.

Dated December 24, 1860.

3154. P. Spence, Newton Heath, near Manchester—Improvements in separating copper from its ores.

Dated December 26, 1860.

3160. F. Warren, Birmingham—Machine used for cleaning cotton, commonly called a "churka," or "roller gin."

Dated December 28, 1860.

3182. W. E. Newton, 66, Chancery-lane—Machinery to be used in the manufacture of paper.

Dated December 29, 1860.

3185. J. Brinton and J. Lewis, Kidderminster—Manufacture of pile carpets, rugs, and other pile fabrics.

3188. J. L. St. Cyr, A. J. Grignon, and P. Romé, Paris—Manufacturing fibrous materials, tissues, or other fabrics.

3190. L. C. M. J. Vilcoq, Courbevoie, France—Apparatus or machinery for triturating textile bodies and other substances.

3192. H. Chamberlain, Wareham, Dorsetshire—Preparation of clay for pottery purposes, which improvements are also applicable to filtering or cleansing liquids.

Dated January 2, 1861.

6. W. Cooke, Charing Cross—Apparatus for ventilating.

Dated January 3, 1861.

16. H. Doffgnies, Brussels—Obtaining pulp for the manufacture of paper from Indian corn and other similar plants.

18. S. Perkes, Clapham—Improvements in presses and modes of pressing, applicable to cotton, hemp, wool, coir, hides, hay, fibres, peat, linen, thread, piece goods, extracting oil, and other useful purposes.

Dated January 4, 1861.

19. G. Lowry, Salford—Machinery for heckling flax and other fibrous materials.

20. T. Cobley, Meerholz, Hesse, Germany—Mode of obtaining or manufacturing commercial salts of lead directly from the ores of lead.

22. P. Pimout, 55, Imperial-street, Rouen, France—Apparatus for drying fabrics and other articles.

24. J. Crocker, Liverpool—Apparatus for indicating the number of persons, vehicles, or articles passing, or being made to pass, any place or part of a machine.

26. J. R. A. Douglas, Hounslow—Roughing the shoes of horses and other animals, to prevent them from slipping in frosty weather.

Dated January 5, 1861.

30. H. Gilbee, 4, South-street, Finsbury—Sewing machines.

32. B. G. Sloper, Hackney—Machinery for amalgamating, and for effecting the separation of gold from earthy and other matters containing the same.

34. L. D. Owen, 491, New Oxford-street—Improvements in hustles or skirt supporters.

36. W. M. Williams, Haudsworth, Staffordshire—Treating coal peat, for the purpose of obtaining solid and liquid hydro-carbons therefrom.

39. J. Hamilton, Glasgow—Governors for regulating the speed of steam and other engines.

40. W. Luck, Mableton-place, Burton-crescent—An improved table, or article of furniture.

Dated January 7, 1861.

42. G. D. Mease, South Shields—The manufacture of sulphuric acid, and also in separating copper and silver from their ores.

44. W. Bagley and W. Mincher, Birmingham—Coating metals and alloys of metals.

Dated January 8, 1861.

46. W. Rattray, St. Clement's Chemical Works, Aberdeen—For the invention of improvements in preserving organic substances.

48. P. E. Chassang, 9, Rue du Conservatoire, Paris—An improved buckle.

50. J. J. Welch, Cheapside—Scarfs and cravats.

Dated January 9, 1861.

52. D. Adamson, Newton Moor, Cheshire—Improvements in steam engines.

53. W. Taylor, Nursling, near Southampton—A combined heating and ventilating pipe.

56. E. C. Shephard, Victoria-street, Westminster—Apparatus for carburating gas for gas lighting.

58. C. N. Leroy, Paris—Grease for lubricating the frictional surfaces of machinery.

Dated January 10, 1861.

61. M. F. Halliday, 4, Langham Chambers, Langham-place, Westminster—An improved trigger for gun locks.

62. S. Moulton, Bradford, Wiltshire—Manufacture of india-rubber, applicable to springs, valves for machinery, and other purposes.

63. R. A. Brooman, 166, Fleet-street—Treating lava and other volcanic substances, in order to fit them for employment in certain arts and manufactures.

64. C. Newsome, Coventry—Looms for weaving ribbons.

65. J. H. Johnson, 47, Lincoln's-inn-fields and Glasgow—Tanning hides and skins.

66. J. Coury, Manchester—Apparatus for communicating between the passengers and guard, and guard and engine-driver on railways.

67. C. H. G. Williams, 39, Regent-square, Gray's-inn-road—Manufacture of dyes and colouring matters.

68. W. Longmaid, Galway, Ireland—Hardening the surfaces of the rails of railways, and the surfaces of the tyres of railway wheels, and in charring the surfaces of timber to be used for railway sleepers, and other purposes.

- Dated January 11, 1861.*
70. C. Senior, Huddersfield—Apparatus for tentering or stretching and drying woollen or other textile fabrics.
71. W. C. Carson, Sheffield—Improvements in stoves, grates, or fire-places.
72. H. T. Hooper, Truro, and W. Gerrans, Tregony, Cornwall—Machine for distributing manure on lands.
73. T. Brownich, Bridgnorth—A combined apparatus for combing and cutting the hair of the human head.
74. W. H. Muntz, Millbrook, Hampshire—Improvements in breaks for locomotive engines.
75. W. H. Muntz, Millbrook, in Hampshire—Signalling or communicating with the guard or engine-driver in railway trains.
76. P. Laffitte, Bordeaux, Gironde—An improved instrument for writing and printing music.
77. W. E. Gedge—Weighing machines.
79. T. T. Chellingworth, 12, Buckingham-street, Adelphi, and J. Thurlow, 37, Belvedere-road, Lambeth—Improvements in traction engines.
80. W. H. Moran, Cologne—Improvements in gas meters.
81. H. Pawson, 117, Leadenhall-street—Beams and weighing machines.
82. A. R. le Mire Normandy, King's-road, Clapham-park—Connecting gas and other pipes.
83. N. Ager, 77, Upper Ebury-street, Pimlico—Stoves and ranges.
84. A. M. Foote, New York, United States—Lock for receiving and securing umbrellas, canes, and similar articles.
85. W. G. Woodcock, West Bromwich—Wrought iron beams or girders and columns.
86. R. Smellie, West Merrieston, North Britain—Apparatus for supporting and working sash windows and other similar sliding or traversing details.
87. M. A. Muir and J. M'Ilwham, Glasgow—Looms for weaving.
- Dated January 12, 1861.*
88. W. Bullough, Blackburn, Lancashire—Improvements in looms for weaving.
89. G. Whicht, Ipswich—Sewing machines.
90. T. Warwick, Birmingham—Governors for steam and other engines.
91. J. Charlton, Manchester—Directing the streams of water employed in extinguishing conflagrations.
94. H. Matheson, Lahore-terrace, Sydenham-road, Croydon—Improved apparatus for generating steam.
95. E. F. Prentiss, Birkenhead—Regulating the flow of gas, part of which is applicable to the valves of steam engines.
97. C. A. Girard, 17, Boulevard du Temple, Paris—Preparing colouring matters for dyeing and printing.
98. G. Franci, 29, Boulevard St. Martin, Paris—Cannon and mortars.
- Dated January 13, 1861.*
100. J. Baldwin, junior, C. Wood, John Crossley, Halifax—Machinery for combing wool or other fibrous substances.
101. V. Hall, Oxford-street—Obtaining colouring matters.
102. W. Desilva and T. F. Griffith, Liverpool—Instrument for taking observations at sea or on land.
103. H. Clifford, Greenwich—Apparatus to be employed in coiling and paying out electric telegraph cables.
104. J. Horsey, Belvedere-road, Lambeth—Pouches or receptacles for tobacco and other articles.
105. H. Weber, New Maldon, Surrey—Window fastenings.
106. J. Lark, Strood, Kent—Manufacture of Portland cement.
107. J. H. Johnson, 47, Lincoln's-inn-fields, and Glasgow—Machinery or apparatus for obtaining motive power.
- Dated January 15, 1861.*
108. S. Hemming, Moorgate-street—Improved rifle ranges.
109. J. Sidebottom, Harewood, near Cheshire—Fire-arms and ordnance.
110. J. Willcock, 89, Chancery-lane—Gas regulators.
111. J. F. Spencer, Newcastle-upon-Tyne—Improvements in steam engines, and the machinery and apparatus connected therewith.
112. C. Stevens, 31, Charing Cross—A new paste made from wood to be used in the manufacture of various articles.
113. C. B. Walker, 1A, Southampton-street, Strand—A novel mode of advertising, signalling, giving notices, or other communications.
114. R. Wilson, Patricroft, Lancashire—Screw propellers, and machinery or apparatus for actuating the same.
115. G. Davies, No. 1, Serle-street, Lincoln's-inn, and Glasgow—The manufacture of blades for knives, razors, swords, bayonets, and other similar articles.
116. A. G. Lasserre, Chemist, Bordeaux, France—Manufacture of fuel.
117. M. Courmiol, Libourne, France—Manufacturing tallow candles supporting a heat of 28 degrees, without greasing or adhering, and extracting from the moulds whatever may be the atmosphere every two hours.
118. A. V. Newton, 66, Chancery-lane—Construction of railway and other carriages.
119. L. A. Bigelow, High Holborn—Construction of certain kinds of passenger carriages.
120. J. Picken, Birmingham—Breech-loading fire-arms and ordnance.
121. E. Stevens, 5, 6, and 7, Cambridge-road, Bethnal Green—Machinery for preparing dough and paste.
- Dated January 16, 1861.*
122. H. Sagar, Broughton, Manchester—Machinery for finishing patent tracing cloth and woven fabrics.
123. W. Coulter, 143, Everton-road, Chorlton-upon-Medlock, Manchester—An invention for the use of joiners, cabinet makers, and others, called "a bench hook."
124. E. Whittaker and J. Clare, Hurst, Lancashire—Machinery for apparatus for preparing cotton or other fibrous materials to be spun.
125. J. Reading, Birmingham—Swivels or fastenings for connecting watches to watch chains, for fastening articles of jewellery, and for other like purposes.
126. J. W. Graham, Manchester—Cutting, shaping, and dressing stone or other similar substances.
127. J. Batley, Leeds—Manufacture of belting.
128. J. Telfer, Newcastle-upon-Tyne—Capstans and winches for hoisting, which improvements are also applicable to the steering of ships.
129. R. W. Swinburne, South Shields—Manufacture of plate glass.
- Dated January 17, 1861.*
130. W. Spence, 50, Chancery-lane—Machinery for making butt hinges.
131. J. H. Craven, Keighley, Yorkshire—Spinning and doubling wool, cotton, silk, flax, and other fibrous substances, and in machinery or apparatus employed for the same.
132. M. A. Mennons, 39, Rue de l'Echiquier, Paris—Apparatus and materials for filtering water and other liquids.
133. G. Lewington, Bridport, Dorsetshire—Chimney and ventilating cowls.
134. M. F. Cavalerie, 29, Boulevard St. Martin, Paris—Apparatus for obtaining motive power by centrifugal force.
135. W. Clark, 53, Chancery-lane—Apparatus for raising fluids.
136. E. Jullien, Marseilles—Machinery for preparing and treating hides and skins in the manufacture of leather.
137. M. Henry, 84, Fleet-street—Apparatus for locomotion, and in the construction of certain wheels employed therein, and of levels used therewith, such improved wheel and level being also applicable for other purposes.
138. J. R. Joy, All Saints' Street, Bristol—Machinery or apparatus for lithographic printing.
- Dated January 18, 1861.*
139. J. Townsend and J. Walker, Glasgow—Mordanting, and in the manufacture of products to be used as mordants and otherwise.
140. E. Argent, White Lion-street, Pentonville—Lifting and tilting casks, or other receptacles containing liquids.
141. I. Dates, Dukinfield, Cheshire—Apparatus for preparing warps for the loom.
142. R. Mason, Lincolnshire—Apparatus for washing and churning.
143. J. Jobson, Derby—Improvements in the manufacture of stove grates.
144. W. E. Newton, 66, Chancery-lane—An improved clutch apparatus for transmitting motion to various kinds of machinery.
- Dated January 19, 1861.*
145. B. Piffard, 17, Caroline Villas, Kentish Town—Preparation of non-conducting substances, for the deposition thereon of metals by electric action.
146. W. Crozier, Finton Cottage, Witton Gilbert, Durham—Means of communication on railways.
147. W. A. Lyttle, 10, Arundel-street, Strand—Projectiles, to be used with ordnance rifles, and other fire-arms.
148. F. G. Sanders, Poole, Dorsetshire—Boxes for containing earth for growing shrubs or trees, which improvements are also for paving, flooring, building, and other purposes.
149. R. M. Latham, Fleet-street—Construction of children's rocking toys.
150. J. Bond, Tow Law, Durham—Railway wheels.
151. H. Vandercruyce, Bordeaux—Apparatus for lowering or striking the masts of ships at sea with sails and courses set.
152. C. W. Lancaster, Bond-street, J. Brown, J. Hughes, Newport—Constructing forts, screenes, and other like defences.
153. J. B. Rickards, Snow-hill—Construction of axle boxes for the wheels of vehicles used on railways, applicable also to the wheels of vehicles used on common roads.
154. D. Maan, New York, United States—Rotary spading and digging machines.
155. M. Henry, 84, Fleet-street—Machines for manufacturing corks, bungs, spiles, and such like articles.
157. W. Clark, 53, Chancery-lane—Device for balancing slide-valves of steam engines.
- Dated January 21, 1861.*
159. C. E. Albrecht, Radnor-place, Hyde-park—Apparatus for indicating or measuring the pressure of steam and other fluids.
160. W. Pickstone, 32, York-street, Manchester—Waggons used for carrying coals.
161. Lieut. J. Scott, 23, Michael's-place, Brompton—Rifles and their projectiles.
162. W. Pickstone, 32, York-street, Manchester—Apparatus for discharging water from steam pipes.
163. R. Mushet, Coleford—Improvement in the manufacture of cast steel.
164. H. Hibling, 14, Blomfield-street North, Kingsland-road—Manufacture of high boots, knickerbockers, and other suchlike articles.
165. T. Stewart, Northampton-street, Clerkenwell—Improvement in vehicles known as Hansom cabs.
- Dated January 22, 1861.*
167. C. W. Siemens and F. Siemens, both of Great George-street, Westminster—Improvements in furnaces.
168. C. Duckworth, Pendleton—Manufacturing fabrics for useful and ornamental purposes.
169. G. White, 7A, Pancras-lane—An improved warping and beaming mill.
170. W. Cooke, Charing-cross—Apparatus for filtering.
171. R. Philp and J. Philp, 9, Lower John-street, Golden-square—Propellers for propelling ships, boats, and other vessels in water.
172. E. Ellis, Bangor, Caernarvon, apparatus for picking and picking oakum.
173. R. Henderson, 15, Park-place, Bayswater-road—Dumb jockey, for breaking or training horses.
174. H. R. Cottam, St. Pancras Iron Works, Middlesex—Folding chairs, coats, and suchlike articles to sit and recline on.
175. J. Chatterton, Highbury-terrace, and W. Smith, Pownall-road, Dalston—Manufacture of telegraphic cables.
176. A. E. Holmes, Derby—Carriage springs.
177. X. A. Brooman, 166, Fleet-street—Manufacturing tyres for wheels, hoops, and rings.
- Dated January 23, 1861.*
178. D. Smithies, Rochdale-road, and J. Jackson, Holyrood-terrace, Queen's Park, Manchester—Manufacture of heads or harness for weaving.
179. W. Westley, Northampton—Manufacture of boots and shoes.
180. W. Brown, Wigan—An improved stripper for carding engines.
181. W. Clark, 53, Chancery-lane—Thrashing machines.
182. W. Clark, 53, Chancery-lane—Circular looms for weaving hats and other articles.
183. W. Clark, 53, Chancery-lane—Ships' sails.
184. J. Deakin and J. Cresswell, Birmingham—Shutters.
185. W. Wilson, Newcastle-upon-Tyne—Manufacture of hats.
186. A. Prince, 4, Trafalgar-square, Charing Cross—An improved induction and eduction valve for steam engines.
187. R. A. Brooman, 166, Fleet-street—Sewing machines.
- Dated January 24, 1861.*
188. T. Haworth, Nut Mill, Ba'up—Apparatus for governing or regulating the speed of steam engines or other motive power.
189. H. Henderson, Edinburgh—Apparatus for printing yarns or threads.
190. G. Mulholland, 20, Great Oxford-street, Marlborough-road, Chelsea—Apparatus for preventing steam-boiler explosions.
191. R. Thomas, Bath-street, Tabernacle-square—Tires of wheels for vehicles used on common roads.
192. H. D. O'Halloran, Kensington—An improved sporran or excursion bag especially suitable for volunteer riflemen and tourists.
193. G. T. Selby, Smerwick, Staffordshire—Construction of masts and posts.
194. T. Gibson, W. Knighton, and H. Knighton, Staveley Works, Derby—Core barrels for casting pipes, re-torts, and other hollow articles.
195. D. J. Fleetwood, Birmingham—Apparatus for rolling metal.
196. W. Longmaid, Inver, Galway, Ireland—Manufacture of iron and steel.
197. N. W. Dobson and G. Warren, Bill Quay Bottle Works, near Gatheshead—Manufacture of glass.
198. J. Vero, Atherstone, Warwickshire—Machinery for separating the fur or hair from the skins of animals.
- Dated January 25, 1861.*
199. E. T. Hughes, 123, Chancery-lane—Apparatus for pulverising clay and other materials.
200. G. Hadwen, Audenshaw, Lancashire—Double-lift jacquard machine applicable to power looms.
201. R. A. Brooman, 166, Fleet-street—Reaping and mowing machines.
202. S. Needham, Oriol Place, Chelsea—Spring apparatus applicable to bedsteads.
203. J. Law, Hollinwood, Lancashire—Breaks of engines.
204. B. Lauth, Pittsburgh, Pennsylvania, United States—Piling iron for heating.
205. A. F. Yarrow, Arundel-square, Barnsbury, and J. B. Hilditch, Barnsbury Villas—Apparatus used in ploughing, tilling, or cultivating land.
206. C. Lungley, Deptford-green Dockyard—Construction of ships and other vessels for war purposes.
- Dated January 26, 1861.*
207. J. Durrant, Fitzroy-square, and N. A. Harris, Bayswater—Construction of chimney-tops or appliances for surmounting chimneys.
208. C. Bishop, St. Helen's—Ornamenting of glass.
209. C. A. Drevet, 4, South-street, Finsbury—Manufacture of sulphurous acid, sulphites, bi-sulphites, and sulphuric acid.
210. T. Bradford, Manchester—Machines for washing, rinsing, and blueing clothes, fabrics, yarns, and similar articles.
211. F. W. Webster, Whitstable—Apparatus applicable for washing and churning.

212. J. H. Johnson, 47, Lincoln's-inn-fields — Obtaining motive power from the expansion and compression of air, gas, or vapour.
213. R. Musket, Coleford—Manufacture of melting pots or crucibles.
214. J. Arrowsmith, Bilston, Stafford—Manufacture of armour plates for gun-boats and land batteries.
215. G. Hallett, 52, Broadwalk, Lambeth, and J. Stenhouse, 17, Rodney-street, Pentonville—Manufacturing of pigments for coating surfaces.
216. H. Bessemer, Queen-street-place, New Cannon-street—Ordnance and projectiles.
- Dated January 23, 1861.*
217. J. Clark, 28, Harleyford-place, Kennington—The application of a paste of whatever wood to any kind of ornamental and other mouldings, without the least admixture of any other materials, or use of any chemical agent.
218. J. Boulby, Whitty—Instrument for measuring the speed of ships.
219. C. De Bergue, 9, Dowgate-hill—Machinery for shaping metal.
220. J. Badcock, Canhall Gate, Wanstead—Signalling between the different carriages of railway trains.
221. H. W. Hart, 3, Rue Bergere, Paris—Gas burners.
222. F. H. Twilley and A. Romer, Dean-street, Middlesex—Tobacco pouches.
223. G. A. Rothholz and M. Rosenthal, 14, Goulston-street, Whitechapel—Combined garment for gentlemen's wear.
224. W. E. Newton, 66, Chancery-lane—Apparatus for exhausting and compressing air, and producing autoblats.
225. W. E. Newton, 66, Chancery-lane—An improvement in dinner plates.
226. W. E. Newton, 66, Chancery-lane—Railway carriage wheels.
227. J. G. Mason, Ironmonger-street, Stamford—Chimney tops.
228. J. A. Shipton, Wolverhampton—Steam engines.
- Dated January 29, 1861.*
229. T. A. Verkrusen and M. A. Verkrusen, 96, Hatton-garden, E.C.—A metal paint.
230. W. Winstanley and J. Kelly, Liverpool, Lancashire, and W. Payne and J. Formby, Liverpool—Ships' pumps.
231. E. W. Furrell, Kensington—Means of communication between the guard and the engine driver of a railway train.
232. W. F. Fleming, Halifax—Bottle cleaners.
233. J. W. Friend, Freemantle, Southampton—Beer engines.
234. J. H. Ashford, Loxbeare, Tiverton—Signals for communicating between the passengers of railway trains and the engine driver and guards.
235. E. Culverwell, Plymouth—Apparatus for obtaining motive power.
236. E. A. L. Negretti and J. W. Zambra, Hatton-garden, London—Mountain and other barometers.
237. C. E. Crawley, 17, Gracechurch-street, and T. Shneider, 74, Horseferry-road, Westminster—Safety and other lamps.
- Dated January 30, 1861.*
240. A. Courtois and J. E. de Soulange, both of Paris, France—Kiln for calcining limestone.
241. A. Courtois and J. E. de Soulange, both of Paris—Construction of kiln for baking bricks, tiles, or other similar articles.
242. J. Mellor, jun., Colne Cottages, King's Bridge, Huddersfield—An improved machine called a "cross raising gig," used in the dressing of woollen cloth.
243. S. T. Crook, Halifax—Boilers employed for warming buildings.
244. A. Boyle, Birmingham—Manufacture of umbrellas and parasols.
245. W. Archer, Polton—Jacquard machines.
246. E. Smith, Carlisle-street, Middlesex—Manufacture of swivel rings.
247. J. Poole, Bletchley, Bucks, and J. Wright, 42, Bridge-street, Blackfriars—Steering or guiding steam or other vessels.
248. G. T. Bousfield, Loughborough Park, Brixton—Lasts for boots and shoes.
249. H. Phillips, Pinhoe, Devon, and J. Bannehr, Exeter—Urinals, and manufacture of manure when urine is used.
250. G. T. Bousfield, Loughborough Park, Brixton—Boots and shoes.
251. G. T. Bousfield, Loughborough Park, Brixton—Manufacture of shoes for horses, and other hooved animals.
252. J. H. Jobuson, 47, Lincoln's-inn-fields—Treatment of vegetable substances.
253. J. H. Johnson, 47, Lincoln's-inn-fields—Construction and internal arrangement of railway carriages.
254. R. B. Longridge, Manchester—Promoting the circulation of water in steam boilers.
255. W. Clark, 53, Chancery-lane—Spring hinges.
- Dated January 31, 1861.*
255. C. Reeves, Birmingham—Apparatus for converting breech-loading small arms into muzzle-loading small arms.
257. R. D. Clegg, 73, Fleet-street—Atmospheric clocks, or mercurial time keepers.
258. J. Robertson, Avon Bank, North Britain—Machinery or apparatus for finishing textile fabrics.
259. J. H. Johnson, 47, Lincoln's-inn-fields—Apparatus for roasting coffee and other seeds and roots, and for drying grain.
260. S. Moulton, Bradford—Construction of cables for telegraphic purposes.
261. S. W. Warren, Brooklyn, New York, United States—An improved high and low water indicator for steam and other boilers.
262. I. Rogers, Haverstraw, Rockland, United States—Furnaces for treating iron ores.
263. J. Chatterton, Highbury—Treating gutta percha, india rubber, and compounds containing one or both of these substances.
- Dated February 1, 1861.*
264. E. W. Furrell, Kensington—Apparatus for communicating between the passengers and the engine drivers of railway trains.
266. R. Kuntsinnan, Manchester—Apparatus for lubricating the frictional surfaces of machinery.
267. H. Curtiss, 7A, Skinner-street, Snow-hill—Men's scarfs, cravats, and neck-ties.
268. J. M. Park, Glasgow—Sun blinds or shades.
269. A. Crichton, Cork—Applying and fitting screw propellers.
270. W. Hart, Norwich—Sewing machines.
271. J. J. de Arrietta, Piccadilly—Applications of chapapote and its products.
272. A. V. Newton, 66, Chancery-lane—An improved construction of motive power engine.
273. II. Medlock, 20, Great Marlborough-street—Brewing malt liquors.
274. M. Pollok, jun., of Govan, Lanark, North Britain—Apparatus for winding yarn or thread.
275. H. Bessemer, Queen-street-place, New Cannon-street—Manufacture of malleable iron and steel.
276. T. E. Knightley, 25, Cannon-street—Constructing stable floors.
- Dated February 2, 1861.*
277. G. H. Spencer and R. G. Cook, Hathersage, Derbyshire—Umbrella and parasol furniture.
278. E. T. Hughes, 123, Chancery-lane—Manufacture of woven fabrics.
279. W. Praungle, Salisbury—Pianofortes.
280. J. Cameron, Hematite Iron Works, Hindpool, Lancashire—Purifying water for the supply of steam boilers.
281. A. L. Bricknell, Loughborough Park, Brixton—Fire escapes.
282. W. Clark, 53, Chancery-lane—Manufacture of paper pulp.
283. W. Clark, 53, Chancery-lane—Bellows.
285. W. N. Wilson, 144, High Holborn, and W. T. Hewlett, Leicester—Sewing machines.
286. J. G. Marshall, Headingley, Leeds—Treatment of flax, bemp, and other fibres.
- Dated February 4, 1861.*
287. J. S. Larue, Paris—A mode of greasing pistons and slide-valves.
288. D. Walmsley and J. Rostrom, both of Disley—Apparatus for providing against accidents in hoisting machinery.
289. J. Abraham, Birmingham—Brass nails to be used in sheathing ships.
290. A. E. C. de Balyon, 57, Faubourg Montmartre, Paris—Manufacture of woven fabrics.
291. R. Howarth, Mount Pleasant, Bury, New-road, Manchester—Machinery for raising pile on woollen, cotton, and other fabrics.
292. E. C. Morgan, Norwich—Carriage building.
293. R. A. Brooman, 166, Fleet-street—Carving or figuring wood.
294. J. Murray, Whitehall-place—Railway carriages.
- Dated February 5, 1861.*
295. G. W. Belding, Moor-lane, Cripplegate—Skeleton petticoats.
297. G. Williams, Liverpool—Construction of charcoal and other kilns.
299. J. T. Wood, Strand—Open work fabrics, suitable for ladies' collars.
300. Captain H. Dixon, 8, Park-end, Sydenham—Apparatus for signalling in railway trains.
301. J. Leeming, North Holme Mill, Bradford—Looms.
302. J. Purdy, 314½, Oxford-street—Apparatus for ramming and turning over breech-loading cartridges.
- Dated February 6, 1861.*
303. E. T. Hughes, 123, Chancery-lane—Shuttles for weaving.
304. A. Drevelle, Manchester—Apparatus for folding and measuring woven or textile fabrics.
305. J. Marsden, Orrell, near Wigan—Apparatus for making, forging, and punching metal nuts, spikes, or washers.
307. C. M. J. Bourcier, Paris, and T. Allan, of Adelphi-terrace—Treating certain animal sinews, in order to convert them into fibres or threads.
308. C. W. Forbes, Southampton—Rests for rifles.
309. W. Clark, 53, Chancery-lane—Preserving animal substances.
310. A. J. Robertson, 26, Parliament-street, Westminster—Construction of ships and vessels.
- Dated February 7, 1861.*
311. J. Beesley, Coventry—Looms used in the manufacture of ribbons and other fabrics.
312. J. W. Wilson, Bevor Saw-mills, near Barnsley—Steam boilers.
313. J. E. Boyd, Hither Green, Lewisham—Manufacture and preparation of paper.
- Dated February 8, 1861.*
314. A. Drevelle, Manchester—Embroidering or ornamenting woven fabrics, felts, or other similar materials.
315. T. Blezard and J. Blezard, of Padham, Lancashire—Self-acting temples.
316. M. J. Stark, Norwich—Preparation of colouring matters for dyeing, staining, or printing fabrics.
317. T. Banks and T. Morgan, Kidderminster—Improvements in coating sheets or plates of iron with lead or tin.
318. B. Peake, Coventry—Broadcast silk fabrics.
319. R. Harrild, and H. Harrild, Farringdon-street—Apparatus for printing addresses for newspapers.
320. R. M. M'Turk, Liverpool—Improved construction of neck-tie, and attachment therefor.
321. W. M. Storm, New York, U.S.—Construction of ordnance.
322. J. Branscombe, Noel-street, Islington—Telegraph cables.
323. W. Morris, junior, Kent Waterworks, Deptford—Valves.
- Dated February 9, 1861.*
324. D. Grimshay, Belfast—Locks.
325. H. Freystadt, 16, Broad-street-buildings—Manufacture of bodies for caps, nets, baskets, bags, and other similar articles of light work.
326. C. J. Richardson, 54, Kensington-square—Armour or metal covering for iron cased ships of war.
327. H. Withers, Dundalk—Horse shoes.
328. G. Jarrett, 37, Poultry—Apparatus applicable for marking linen, and for other printing and stamping purposes.
329. D. Ker, Plymouth—Construction of submarine telegraphic cables.
330. J. L. Julion, Tyne-mouth—Treatment of soda water and sulphurets.
331. J. Higgins and T. S. Whitworth, Salford—Apparatus for preparing cotton and other fibrous materials for spinning.
332. J. Lockwood, Dudley-hill, near Bradford—Healds for fibrous materials.
334. J. G. Jennings, Holland-street, Blackfriars—Capsules, or covers for the necks or ends of jars.
335. A. Leidemann and T. Lange, Newcastle-upon-Tyne—Manufacture of sub or oxil-sulphate of lead.
- Dated February 11, 1861.*
337. E. Gerlaise and J. E. Bernier, Paris—Manufacture of artificial leather.
338. M. A. F. Mennons, 39, Rue de l'Echiquier, Paris—Improvements in the heating and cooling surfaces of engines propelled by aeriform fluids.
339. M. A. F. Mennons, 39, Rue de l'Echiquier, Paris—Construction of steam generators employed for heating, drying, evaporating, and other purposes.
340. M. A. F. Mennons, 39, Rue de l'Echiquier, Paris—Construction of certain kinds of breech-loading firearms.
341. W. E. Newton, 66, Chancery-lane—Floating structures.
342. W. E. Newton, 66, Chancery-lane—Machinery for preparing hemp and similar fibrous materials.
343. W. S. T. Clarke, 29, Charing-cross—A railway break.
344. H. Baker, Glasgow—Manufacture of lucifer matches.
345. J. H. Johnson, 47, Lincoln's-inn-fields—Arrangement of bearings and grease boxes for shafts and axles.
346. N. Thompson, Abbey Garden, St. John's Wood—Machinery for preparing wood for boat-building and other uses.
347. R. A. Brooman, 166, Fleet-street—Treating the tobacco plant in order to manufacture paper.
349. G. G. Aggio, Nevill's-court, London—Stereotype plates.
- Dated February 12, 1861.*
351. W. Oldfield, Noble-street, St. Luke's—Writing and dressing cases.
353. A. Parkes, Birmingham—Electric telegraph conductors.
355. A. Parkes, Birmingham—Manufacture of the fire boxes of locomotive and other tubular boilers.
357. C. Prater, Charing-cross—Slings or traps adapted for knapsacks.
359. W. E. Newton, 66, Chancery-lane—Projectiles for ordnance and fire-arms.
- Dated February 13, 1861.*
361. E. T. Jones, Morden College, Blackheath—Suppression of arsenical and sulphurous fumes emitted during the first operation or calcination of copper ores.
365. C. S. Roskilly, Falmouth—Refining malt liquors.
367. W. Clark, 53, Chancery-lane—Sewing and embroidering machines.
369. C. A. Lawson, Aston, New-town, near Birmingham, J. B. Barnes and J. Loach, Birmingham—Projectiles applicable to the use of ordnance and small arms.
371. M. Henry, 84, Fleet-street—Construction of a certain description of castor.
373. J. Poole, J. Wright, F. S. Hemming, G. Searby, all of 35, Moorgate-street—Drilling, boring, or excavating rock or other earthly substances.

INVENTIONS WITH COMPLETE SPECIFICATIONS FILED.

265. T. Lemelle, 51, High Holborn—Engines for the extraction of the produce of mines, and new arrangement of the ropes for suppressing all dead weight.
364. C. F. Atkinson, Sheffield—The application of steel or iron to the manufacture of collars and wristbands to be worn as articles of clothing.

RAILWAY CURVES

20 1/4 Chassis Roadies

Fig. 1.

direction of Train



W. C. B. Director

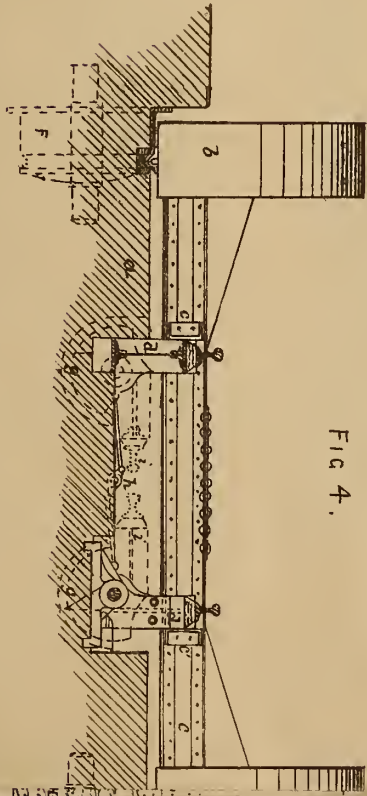

FIG 4.

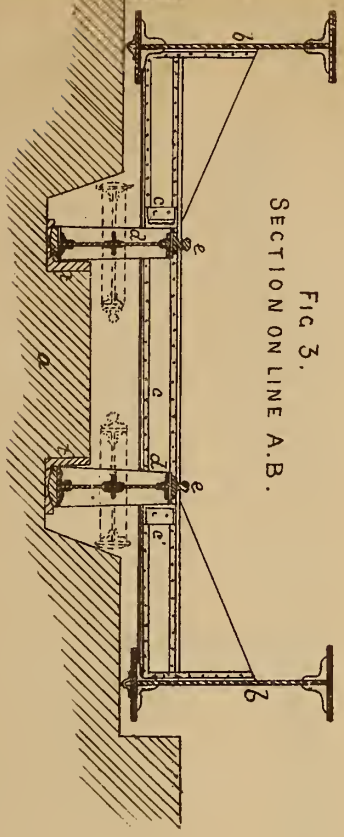
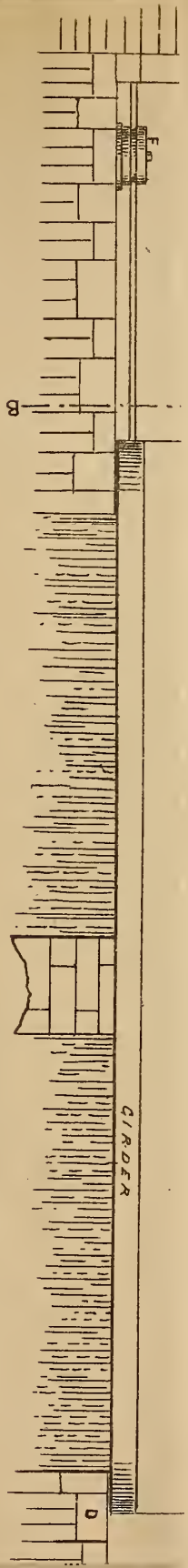

FIG 3.
SECTION ON LINE A.B.



GIRDER

191 2101-1

"RAILWAY CURVES"

Direction of Train →

FIG: 1.

20 1/2 Chains Radius

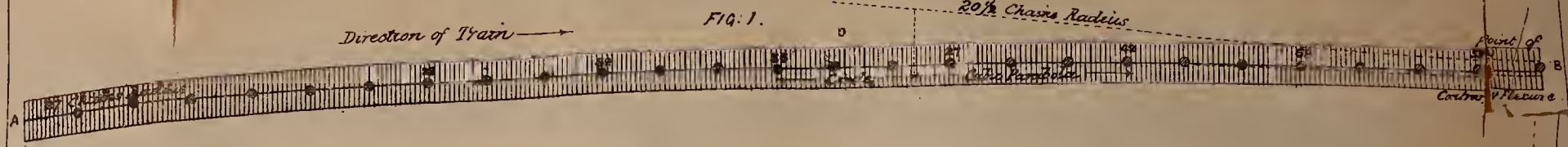

FIG: 2.



FIG: 3.

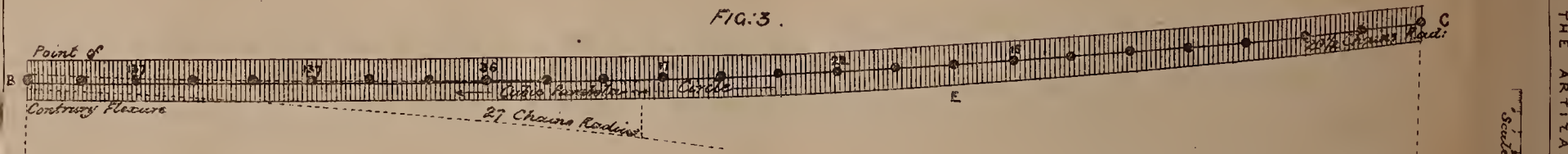
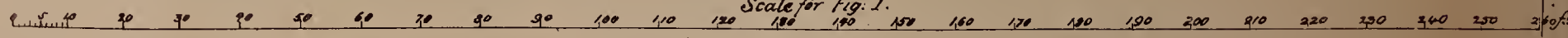

FIG: 4.



Scale for Fig: 1.



APPLICATION OF THE "CURVE OF SINES".

FIG: 5.

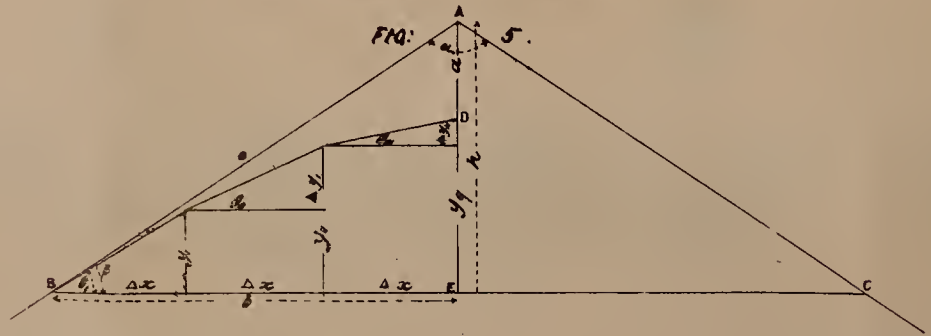

"STABILITY".

FIG: 6.

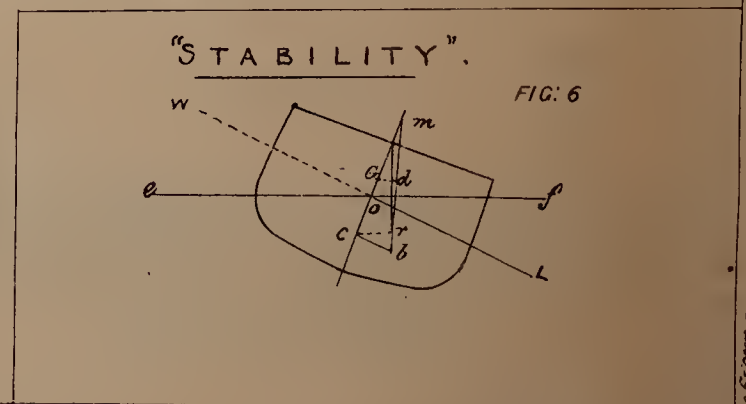

THE ARTISAN, APRIL 1ST 1851.

Plate 110.

Scale C.E. drawn.

212. J. H. Johnson, 47, Lincoln's-inn-fields — Obtaining motive power from the expansion and compression of air, gas, or vapour.
213. R. Musket, Coleford—Manufacture of melting pots or crucibles.
214. J. Arrowsmith, Bilston, Stafford—Manufacture of armour plates for gun-boats and land batteries.
215. G. Hallett, 52, Broadwall, Lambeth, and J. Stenhouse, 17, Rodney-street, Pentonville—Manufacturing of pigments for coating surfaces.
216. H. Bessemer, Queen-street-place, New Cannon-street—Ordnance and projectiles.
- Dated January 28, 1861.*
217. J. Clark, 23, Harleyford-place, Kennington—The application of a paste of whatever wood to any kind of ornamental and other mouldings, without the least admixture of any other materials, or use of any chemical agent.
218. J. Boulby, Whitby—Instrument for measuring the speed of ships.
219. C. De Bergue, 9, Dowgate-hill—Machinery for shaping metal.
220. J. Badoek, Canhall Gate, Wanstead—Signalling between the different carriages of railway trains.
221. H. W. Hart, 3, Rue Bergere, Paris—Gas burners.
222. F. H. Twilley and A. Romer, Dean-street, Middlesex—Tobacco pouches.
223. G. A. Rothholz and M. Rosenthal, 14, Goulston-street, Whitechapel—Combined garment for gentlemen's wear.
224. W. E. Newton, 66, Chancery-lane—Apparatus for exhausting and compressing air, and producing air-blasts.
225. W. E. Newton, 66, Chancery-lane—An improvement in dinner plates.
226. W. E. Newton, 66, Chancery-lane—Railway carriage wheels.
227. J. G. Mason, Ironmonger-street, Stamford—Chimney tops.
228. J. A. Shipton, Wolverhamptou—Steam engines.
- Dated January 29, 1861.*
229. T. A. Verkruzen and M. A. Verkruzen, 96, Hatton-garden, E.C.—A metal paint.
230. W. Winstanley and J. Kelly, Liverpool, Lancashire, and W. Payne and J. Formby, Liverpool—Ships' pumps.
231. E. W. Furrell, Kensington—Means of communication between the guard and the engine driver of a railway train.
232. W. F. Fleming, Halifax—Bottle cleaners.
233. J. W. Friend, Freemantle, Southampton—Beer engines.
234. J. H. Ashford, Loxbeare, Tiverton—Signals for communicating between the passengers of railway trains and the engine driver and guards.
235. H. Culverwell, Plymouth—Apparatus for obtaining motive power.
236. E. A. L. Negretti and J. W. Zambra, Hatton-garden, London—Mountain and other barometers.
237. C. E. Crawley, 17, Gracechurch-street, and T. Shneider, 74, Horseferry-road, Westminster—Safety and other lamps.
- Dated January 30, 1861.*
240. A. Courtois and J. E. de Soulange, both of Paris, France—Kiln for calcining limestone.
241. A. Courtois and J. E. de Soulange, both of Paris—Construction of kiln for baking bricks, tiles, or other similar articles.
242. J. Mellor, jun., Colne Cottages, King's Bridge, Huddersfield—An improved machine called a "cross raising gig," used in the dressing of woollen cloth.
243. S. T. Crook, Halifax—Boilers employed for warming buildings.
244. A. Boyle, Birmingham—Manufacture of umbrellas and parasols.
245. W. Archer, Polton—Jacquard machines.
246. E. Smith, Carlisle-street, Middlesex—Manufacture of swivel rings.
247. J. Poole, Bletchley, Bucks, and J. Wright, 42, Bridge-street, Blackfriars—Steering or guiding steam or other vessels.
248. G. T. Bousfield, Loughborough Park, Brixton—Lasts for boots and shoes.
249. H. Phillips, Pinhoe, Devon, and J. Bannehr, Exeter—Urinals, and manufacture of manure when urine is used.
250. G. T. Bousfield, Loughborough Park, Brixton—Boots and shoes.
251. G. T. Bousfield, Loughborough Park, Brixton—Manufacture of shoes for horses, and other hoofed animals.
252. J. H. Johnson, 47, Lincoln's-inn-fields—Treatment of vegetable substances.
253. J. H. Johnson, 47, Lincoln's-inn-fields—Construction and internal arrangement of railway carriages.
254. R. B. Longridge, Manchester—Promoting the circulation of water in steam boilers.
255. W. Clark, 53, Chancery-lane—Spring hinges.
- Dated January 31, 1861.*
256. C. Reeves, Birmingham—Apparatus for converting breech-loading small arms into muzzle-loading small arms.
257. R. D. Clogg, 73, Fleet-street—Atmospheric clocks, or mercurial time keepers.
258. J. Robertson, Avon Bank, North Britain—Machinery or apparatus for finishing textile fabrics.

259. J. H. Johnson, 47, Lincoln's-inn-fields—Roasting drying apparatus.
260. S. Mouton, graphi.
261. S. W. Wainwright, An in steam.
262. I. Rogers, naces.
263. J. Chatterdia ru of the.
264. E. W. Fucating driver.
266. R. Kuntsi the fr.
267. H. Curtis cravat.
268. J. M. Par.
269. A. Cricht peller.
270. W. Hart.
271. J. J. de An and it.
272. A. V. New struct.
273. H. Medlo malt l.
274. M. Pollok parati.
275. H. Besser Manu.
276. T. E. K stable.
277. G. H. Spe —Um.
278. E. T. H wover.
279. W. Prang.
280. J. Camer shire-boiler.
281. A. L. B escap.
282. W. Clark pulp.
283. W. Clark.
285. W. N. Wi Leice.
286. J. G. Mar hemp.
287. J. S. La slide.
288. D. Walm ratus mach.
289. J. Abrah sheat.
290. A. E. C. (Manu.
291. R. Howa chest cotton.
292. E. C. Mo.
293. R. A. B wood.
294. J. Murra.
295. G. W. pettic.
297. G. Willia other.
299. J. T. W ladies l.
300. Captain l for si.
301. J. Leemi.
302. J. Purde t.
303. E. T. Hug.
304. A. Drevi meas.
305. J. Marsd forgh wash.
307. C. M. J. terra convt.
308. C. W. Pc.
309. W. Clarl stanc.
310. A. J. Rol Cons.
311. J. Beesle of ribbons and other fabrics.
312. J. W. Wilson, Bevor Saw-mills, near Barnsley—Steam boilers.
313. J. E. Boyd, Hither Green, Lewisham—Manufacture and preparation of paper.

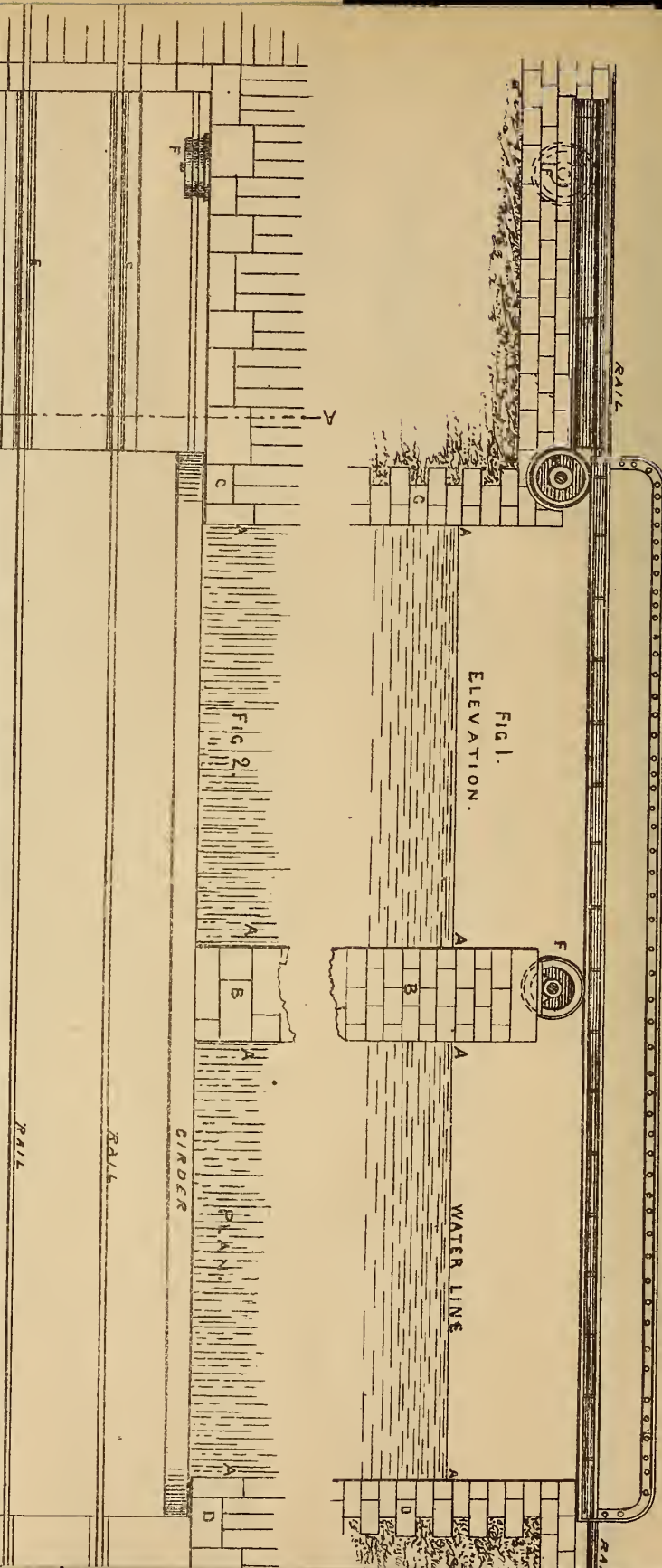

traction of the produce of mines, with new arrangement of the ropes for suppressing all dead weight.

364. C. F. Atkinson, Sheffield—The application of steel or iron to the manufacture of collars and wristbands to be worn as articles of clothing.

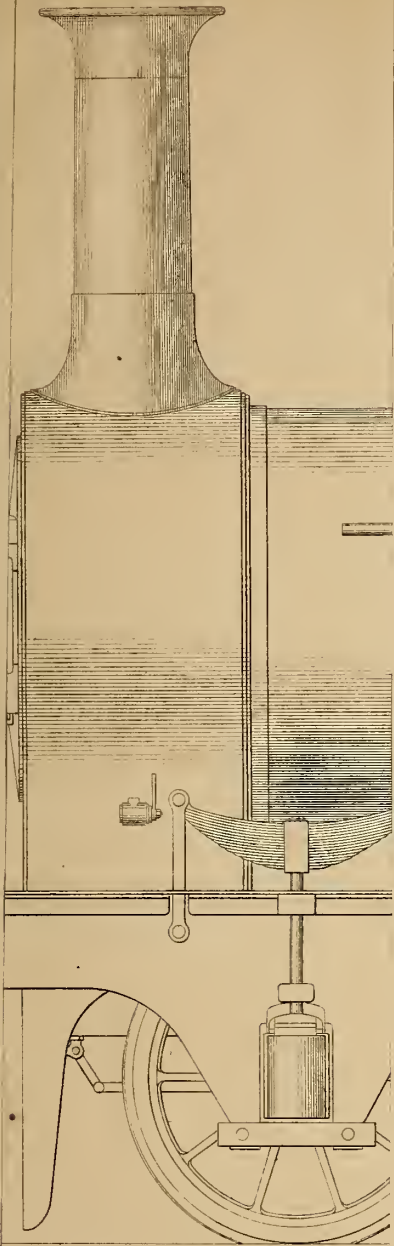

PASSENGER-

Inches 12 9 6 3

TURNER AND GIBSON'S BRIDGES.

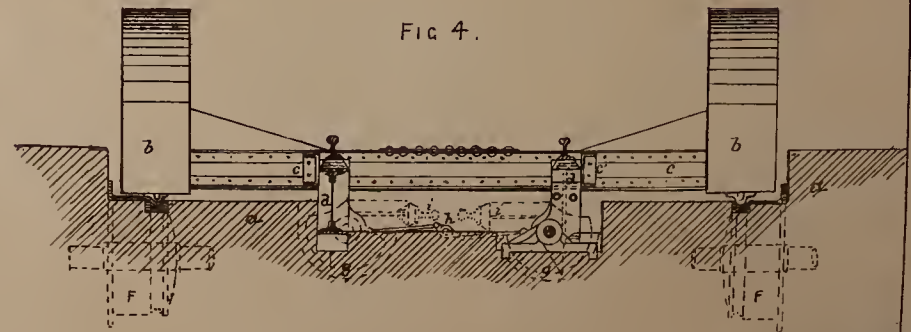
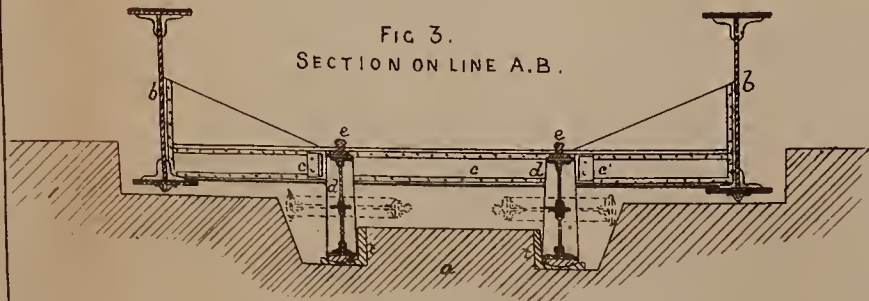
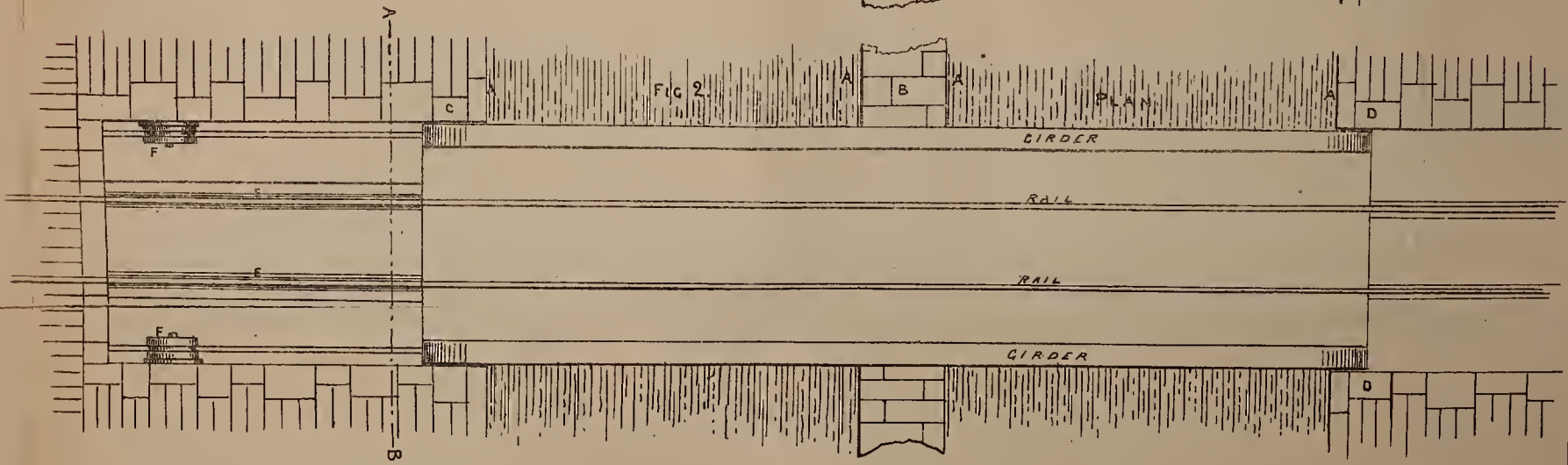
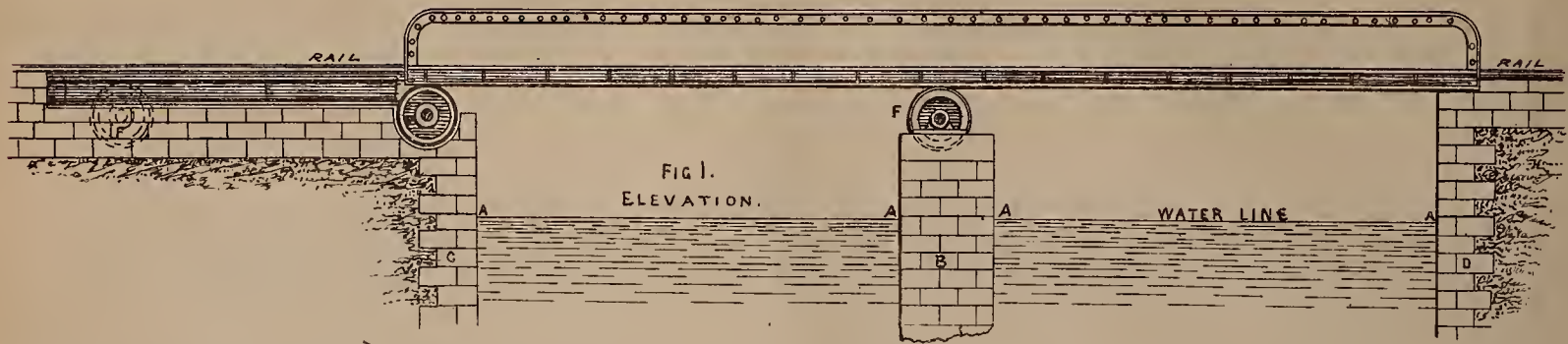

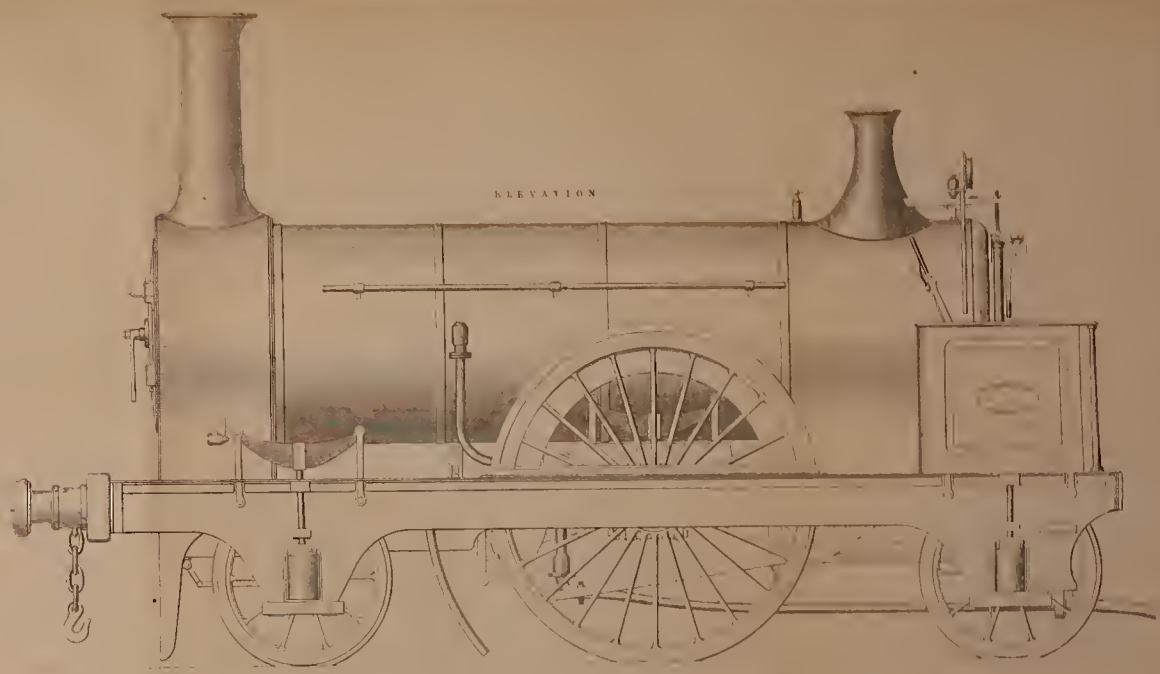
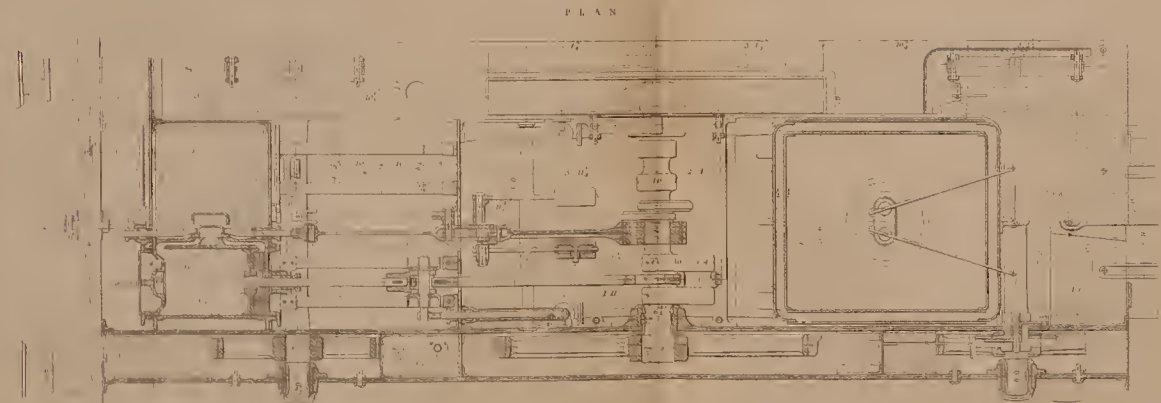
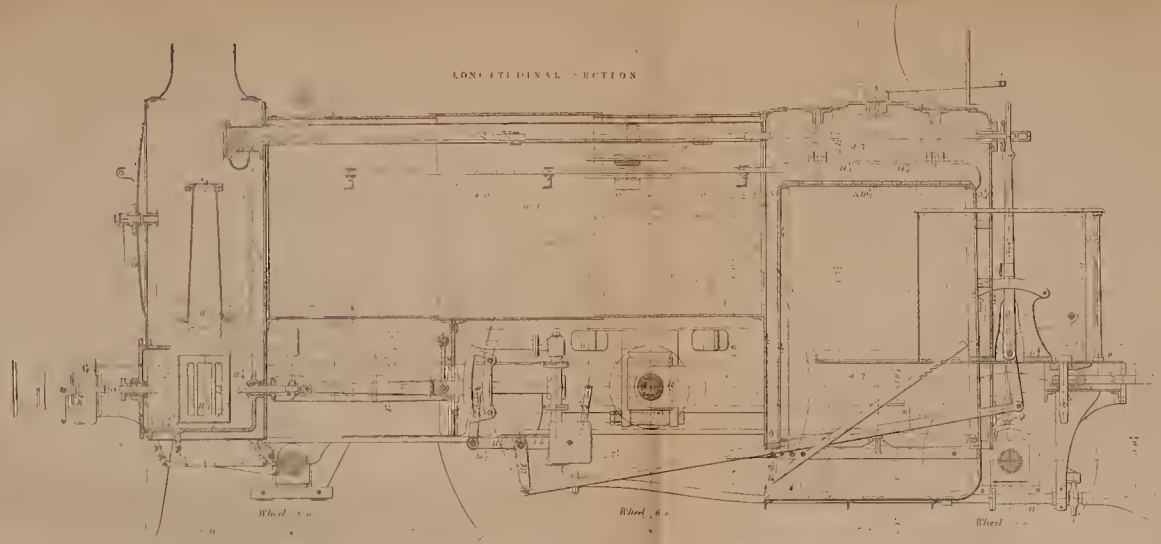

PASSENGER-LOCOMOTIVE, BY BEYER, BRADOCK & CO MANCHESTER
 FOR THE
 EDINBURGH AND GLASGOW RAILWAY.

INches 0 1 2 3 4 5 6 7 8 9 10 11 12

212.

213

214

215

216

217

218

219

220

221

222

223

224

225

226

227

228

229

230

231

232

233

234

235

236

237

238

239

240

241

242

243

244

245

246

247

248

249

250

251

252

253

254

255

256

THE ARTIZAN.

No. 219.—VOL. 19.—MARCH 1, 1861.

PASSENGER LOCOMOTIVE ENGINE FOR THE EDINBURGH AND GLASGOW RAILWAY.

(Illustrated by Plate 189.)

With this number we present our readers with a large copper-plate engraving of a Passenger Locomotive—for fast trains—constructed by Messrs. Beyer, Peacock, & Co., of Manchester, for the Edinburgh and Glasgow Railway, early in 1856; and their performance having given entire satisfaction up to the present time, a considerable number of these engines have from time to time been ordered, from Messrs. Beyer, Peacock, & Co., by the Engineer to the Company, for the same line of railway. The same firm have also constructed two other classes of engines, to meet the respective requirements of heavy passenger trains and goods trains of the Edinburgh and Glasgow Railway, maintaining the same type or character, the boilers, fire-boxes, engine cylinders, and gearing being the same in all the three classes of engines. The principal dimensions of the class of engines we now illustrate are as follows:—Cylinders, 16 in. diam., and 20 in. stroke; driving wheels, 6ft. 6in. diam.; leading and hind wheels, 3ft. 6in. diam., and 14ft. 6in. between their centres; boilers, 10ft. 1in. long inside, by 4ft. diam., with 172 tubes 2in. external diam.; fire-boxes (copper), 4ft. long by 3ft. 6in. wide, by 5ft. 3in. high; heating surface in fire-box, 82 square feet; ditto in tubes, 928—total, 1010 square feet; area of fire-grate, 14 square feet; weight of engine under steam, 22 tons 10 cwt.

The firm of Messrs. Beyer, Peacock, and Co., has for its first partner a gentleman who was many years with Messrs. Sharp, Brothers, and Co., where his great talents as a practical engineer obtained for him a very wide reputation for excellence of design and constructive ability. Mr. Peacock, the second partner, is known to be one of the most—if not the most—practical of the locomotive engine builders of the present day, combining within himself that varied and extensive amount of knowledge which can alone be acquired by having passed through the several grades of practical working from his apprenticeship as a mechanic, his after employment as a journeyman in the position of engine fitter and erector, and afterwards as fireman; then as driver; next, as foreman in the running-shed, and in different positions in the railway locomotive shops; then, finally, in connection with railway works, as Locomotive Superintendent over an extensive line of railway; and now a partner in one of the largest and most modern engine building establishments in the world. It is not, therefore, so surprising that Messrs. Beyer, Peacock, and Co., should, in the course of so very few years, have attained such eminence as locomotive builders; and to this cause, also, we ascribe their apparent fondness for giving uniformity of character to the chief parts of the several engines—to maintain, as far as possible, uniformity of type, simplicity of construction, combining great strength with the least weight, and a general character of finished excellence, superadded to the utmost mechanical accuracy.

We hope at some very early date to be able to illustrate two other classes of engines of the same type, which have been built by the same firm for the Edinburgh and Glasgow Railway Company, for performing the duties connected with the various traffic arrangements of that railway. These latter engines, having worked equally well with those which we have illustrated in the present number, additional interest will be given to their publication from the fact that we shall be able to compare their relation and performances as working machines, as well as point out their constructive merits.

Mr. D. K. Clark, in his *Recent Practice in Locomotive Engines, &c.*,* says, "These engines are characterised by elegance and finish, in general form and arrangement, and in detail. The broad and comprehensive slab frame-plate is here noticeable. It was first introduced by Mr. Beyer, many years since, in the engines made by the old established firm of Sharp, Brothers, & Co. (now Sharp, Stewart, & Co.), and is now generally adopted in English practice. The short cast iron blast pipe reaching just above the level of the upper row of flue-tubes is also noticeable. This level of blast pipe gives the best results, creating a superior draft with a wide orifice, as compared with higher situated blast orifices, and was first arrived at by Mr. Peacock by means of a series of well arranged experiments. It is now commonly adopted."

He also gives the following particulars as to the dimensions of the axles, &c., of this engine, beyond what we have given above:—"The crank axle is 6½ in. diam. at the middle, and at the journals, which are 7½ in. long, the throws of the cranks are 4in. thick, and 10in. broad,—being strong, yet elastic. The axle is 8in. diameter in the wheel cases. The journals of the fore and hind axles are 4½ in. diameter, and 8in. long.

In the plate illustrating this engine, we have given a side elevation, a longitudinal section, and a sectional plan. The first-named view gives a very accurate notion of the appearance which the engine presents; the other two views contain all the details most accurately shown in position,—drawn to scale with the utmost minuteness,—and having their dimensions generally marked thereon. Thus, to the practical engineer, this plate is of infinitely greater value than a mere picture would be of such machines, however excellent the style of the engraving, or the elaborateness of the shading.

In the present instance we have to acknowledge our obligation to Messrs. Blackie and Sons, for their permission to illustrate this engine, which we have selected as an excellent example of Messrs. Beyer and Peacock's construction; and, also for the extracts from the text of Mr. D. K. Clark's admirable work.

TURNER AND GIBSON'S IMPROVEMENTS IN BRIDGES.

(Illustrated by Plate 191.)

Our Plate is an illustration of a railway bridge constructed according to Messrs. Turner and Gibson's patent, and recently erected by them on the line of the Cork and Youghal Railway, Ireland. These improvements relate to that description of bridge known as balanced, rolling, or sliding bridges for crossing canals, dock entrances, railway lines, &c. The chief feature in the description of the bridge now under notice is, that the roadway being perfectly level, and not having any "camber," it may be employed with advantage as a railway bridge, and is readily opened or closed by merely sliding or rolling it back or forth in a horizontal position, and without tipping or canting; and when the bridge is in position, a continuous line of rails is formed, perfectly steady and secure for the purposes of traffic.

Underneath the platform of the bridge constructed according to this invention, guiding and bearing rails are introduced for running upon wheels or rollers, one set of which supports the platform near the centre of its length; and one or more sets of wheels or rollers may be interposed beneath the platform on the "land" or "pit end."

* *Recent Practice in the Locomotive Engine; Comprising the latest Improvements, &c.* By D. K. Clarke, C.E. Published by Blackie & Sons, Glasgow, Edinburgh, and London. 1860.

mation to the true value of this quantity by a series of assumed values, continually approaching to the required quantity.

We may here observe that, in any span of any continuous girder, the sum of the central moment of strain + half the sum of the moments over the piers is constant, and this fact provides us with a very convenient check upon our calculations when substituting the assumed values of h in the above equation.

The following tabular form exhibits the method applied to the present case:—

	<i>mc.</i>	<i>M'</i>	Total.	Areas.	Total.
Let $h = \cdot 1$	0·08	0·04 + 0·005	0·125	0·0426 + 0·045	0·0876
„ = 2	0·045	0·02 + 0·06	0·125	0·018 + 0·016	0·034
„ = 3	0·02	0·045 + 0·06	0·125	0·0053 + 0·0315	0·368

In this table the first column shows the assumed value of h ; the second, the central moment corresponding to each of these assumptions; the third column contains the moment over either pier; the fourth, which is a check upon the first and second, contains the sum of the moments over one pier and at the centre of the girder; the fifth column contains two series of areas—the first that of the central parabolic part of the curve, and the second that of the end triangular parts of the curve. The sixth column contains the total areas of the curve, and from it we see that the first and last quantities are both larger than the intermediate value; hence the true value of h lies between 0·1 and 0·3. We will now approximate closer to this value:—

	<i>mc.</i>	<i>M'</i>	Total.	Areas.	Total.
Let $h = \cdot 21$	0·042	0·022 + 0·061	0·125	0·0162 + 0·0174	0·0336
„ = 215	0·041	0·023 + 0·061	0·125	0·0148 + 0·018	0·0326
„ = 22	0·039	0·024 + 0·062	0·125	0·0146 + 0·0189	0·0335

From this latter table we find that the true value of h is contained between 21 and 22, and that 215 is exceedingly near to it; hence we may safely assume this in practice as the value of h .

From these calculations we find that, in a girder fixed at both ends, and uniformly loaded throughout its whole length, the value of h is $\cdot 215 \times$ span, and the distance between the points of contrary flexure is $\cdot 57 \times$ span. If $l =$ span, and w load per lineal foot, then $mc = 0\cdot 041 w l^2$, and $M' = 0\cdot 084 w l^2$, and, by equating these expressions with these for the moment of resistance of the girder, we obtain $0\cdot 041 w l^2 = s. a. d. \cdot \frac{0\cdot 041 w l^2}{d}$ = *s. a.* represents the direct strain on either flange; and $0\cdot 084 w l^2 = s. a. d. \cdot \frac{0\cdot 084 w l^2}{d}$ = *s. a.* represents the direct strain on either flange, over either point of support. The greatest quantity of metal must be over the pier, whence it decreases to the point of contraflexure, beyond which it again increases to the centre of the girder.

Let us now consider the case of a girder fixed at one end, and supported, but not fixed, at the other. The tabular statement will be as follows:—

	<i>mc.</i>	<i>M'</i>	Total.	Areas.	Total.
Let $h = \cdot 2$	0·08	0·020 + 0·08	0·180	0·042 + 0·010	0·052
„ = 25	0·07	0·031 + 0·083	0·184	0·035 + 0·014	0·049
„ = 3	0·06	0·045 + 0·105	0·210	0·028 + 0·022	0·050

It will be observed that the quantities in the fourth column do not exactly agree. The difference, however, is not sufficiently great to endanger the accuracy of the calculation. This girder will have one point of contrary flexure which, according to the table, is distant from the point of support on which the girder is fixed by an amount between $\cdot 2 l$ and $\cdot 3 l$, and the areas are so nearly equal that $\cdot 25 l$ must be very near the true value of h , if not actually the true value.

It may be well here to remind the reader that *mc* represents the moment

of strain at the centre of that part of the girder which is concave on the upper surface, and this point will, in the present case, be midway between the point of contrary flexure and the pier on which the girder is supported only. Equating the moments of resistance and strain as before, we find that the maximum direct strain on either flange, at the central part of the girder, is $= \frac{0\cdot 07 w l^2}{d}$, and the direct strain on either flange over the pier

$$= \frac{0\cdot 114 w l^2}{d}$$

We will now proceed to determine the positions of the points of contrary flexure in a continuous girder, supported at three points, and having, therefore, two spans or bays. First, let the spans be equal, and also the loads on the two bays; then will each span be in exactly the same condition as a single girder fixed at one end and supported at the other. Hence, in a continuous girder of two spans of equal lengths, when both spans are loaded, or both are unloaded, there will be two points of contrary flexure, one on each side of the central pier, and distant $\cdot 25 l$ from it. Let the loads now be different on the two spans, which would be the case when one span only is loaded with a live weight. Let w per foot run be the load on one bay, and w' that on the other. In this case we shall have another condition to satisfy, viz., so to arrange the points of contrary flexure that the moment produced over the pier by one bay will be equal to and balanced by that caused by the other bay. By an obvious transformation of our formulæ we find the moment over the pier generally

$= \frac{w l h}{2}$. Let the point of contrary flexure in the first span be distant h from the centre pier, and let that in the second span be distant v from the same pier; then $M' = \frac{w' l h}{2}$, and also $M' = \frac{w'' l v}{2}$; therefore $\frac{w'' l v}{2} = \frac{w' l h}{2}$, and the spans being equal, $v = \frac{w'}{w''} h$. Let us suppose that the weight of the girder alone is one ton per lineal foot, and of the load alone one ton per lineal foot, then $w' = 1$, $w'' = 2$, and $h = 2 v$. We now determine the minimum area allowed by this condition:—

<i>v.</i>	$h.$	<i>mc.</i>	<i>m''c.</i>	<i>M'</i>	Areas.	Total.
1	2	0·08	0·20	0·1	0·032 + 0·12 + 0·015	0·167
2	4	0·042	0·16	0·2	0·018 + 0·083 + 0·06	0·163
3	6	0·02	0·125	0·3	0·005 + 0·058 + 0·135	0·198

From this table we see that the value of v is between 1 and 3. The following is a closer approximation:—

<i>v.</i>	$h.$	<i>mc.</i>	<i>m''c.</i>	<i>M'</i>	Areas.	Total.
16	32	0·058	0·175	0·16	0·026 + 0·098 + 0·038	0·162
18	36	0·05	0·168	0·18	0·021 + 0·091 + 0·048	0·160
19	38	0·048	0·164	0·19	0·019 + 0·088 + 0·054	0·161

Hence the value of v is between 16 and 19, and the corresponding areas are very nearly alike, we may, therefore, adopt 18 as the true value. By so doing we involve an error of about $\frac{1}{15}$ of v ; but as far as we shall use the calculation the error is on the safe side. As we have before observed, the greatest moment of strain is produced over the pier when both spans are fully loaded; hence the greatest direct strain on either flange over the centre pier is $= \frac{0\cdot 114 w'' l^2}{d}$, and as the greatest moment of strain on the

central part is obtained, when one span only is loaded, the direct strain on either flange is $= \frac{0\cdot 168 w' l^2}{d}$ when $w' = w''$. If the ratio between the loads upon the two spans is any other than the above v , and h will have different values from those given above, it may be calculated by the same process. The error above mentioned is occasioned by our method of calculating the areas of the curves; but of this we shall speak hereafter.

If the spans are unequal, another element will be introduced into the calculation, but this may be readily determined; for if we put l' an l'' for the two spans, $M' = \frac{w' l' v}{2}$, and also $M' = \frac{w'' l'' h}{2}$; therefore $w' l' v = w'' l'' h$, and $v = \frac{w'' l''}{w' l'} h$. Suppose that $w' = 2 w''$, and $l' = 1\cdot 5 l''$, then $v = 3 h$, which being ascertained, the other calculations are conducted as above. From the foregoing data we may determine the

greatest strain to which any part of the girder may be subject, whence all the elements of the bridge which are intended to resist the bending strain may readily be decided upon. These calculations may at first sight appear somewhat tedious, but a little experience will show that they occupy, in fact, but little time.

Before taking leave of the continuous girder of two spans, we must explain another method of determining the positions of the points of contrary flexure. Let the loads still be in the ratio of 1 to 2. If we consider the girder as consisting of two single girders, supported at the outer ends, but fixed on the centre pier, we shall find that in both spans, the spans being equal, the points of contraflexure are each one quarter of the span from the centre pier; but in one case the moment on the pier will be twice what it is in the other, but in the continuous girder the moment must be the same whichever span it is calculated from. Let us therefore alter the distances of the points of contraflexure from the centre pier, so as to satisfy this condition; we must then increase that for the span with the least load, and diminish the distance for the other. We may consider that we have two right angled triangles, whose bases represent the distances of the points of contraflexure from the pier, and the perpendiculars the moment over the pier; the bases are equal, and the perpendiculars are unequal. We require two similar triangles, whose perpendiculars are equal to a mean between the perpendiculars of the given triangles. If we call the greater perpendicular 4, and the lesser one 2, the mean between them will be equal to 3. First, let us reduce the largest triangle, the perpendicular must be reduced to the extent of one-fourth, then the base will be $= .25 \times .0625 = .1875$, which is within the limits of v in the last table, and within $\frac{1}{24}$ th of the value adopted; as v in the table is slightly short of the true value, the actual error in this case is not so great as we have just stated. For the base of the other triangle we find, by adding one-half, $.25 + .125 = .375$, which is exactly twice the value of the base of the diminished triangle. This method possesses an advantage over the last, in the extreme readiness with which the calculation may be performed; for it does away altogether with the necessity of forming new tables of approximations for every fresh case, and may be made quite as accurate by adding $\frac{1}{24}$ th of the value obtained, for the distance of the point of contraflexure from the pier. It will be observed that this method depends upon the assumption that the true value of the moment over the pier is equal to half the sum of the moments, supposing the spans to be distinct, and the girders fixed on the pier over which the moment is brought into action.

We have hitherto found it most convenient to determine the positions of the points of contrary flexure, in order to obtain data upon which the strength might be calculated. We have, however, now arrived at a stage of our investigation when it becomes desirable to change our method of procedure, as in our future cases we shall be able more readily to obtain the value of the moment over any pier than the position of the points of contrary flexure, the moment being found by comparing the girder with a series of single fixed girders. The moment over the pier being known, we can readily find that at any other point of the span by altering the general equation to suit the circumstances of the case, and the strain at the centre may be found thus:—If M' , M'' represent the moments at each end of the span, and m the moment at the centre, we find, by examining the curve of moments, that $m = \frac{w l^2}{8} - \frac{M' + M''}{2}$.

In the commencement of the present paper, we have shown that in an isolated girder which has its ends only supported, $M = R'x - \frac{w x^2}{2}$, in which expression R represents the reaction of the pier, from which x is measured: in the continuous girder this force also acts, but the action of the moment over the pier must be taken into consideration. This latter evidently acts in the same direction as $\frac{w x^2}{2}$, for they both tend to render the beam convex on the upper surface; hence the above equation becomes $M = R'x - \frac{w x^2}{2} - M'$.

We must now find an expression for R' , which will be affected by the moments over the piers. Let, therefore, M'' be the moment over the pier at the opposite end of the span to that for which R' and M' was taken; then in the above equation, when $x = l$, $M = M''$, $M'' = R'l - \frac{w l^2}{2} - M'$; therefore, $R' = \frac{w l}{2} + \frac{M' - M''}{l}$, and the above equation becomes, $M = \left\{ \frac{w l}{2} + \frac{M' - M''}{l} \right\} x - \frac{w x^2}{2} - M'$. If the distances of the points of contrary flexure from the piers are required, they may be found by making $M = 0$ in the above equation, and determining the value of x from the quadratic thus obtained, two values will be found which will correspond to the two points of contrary flexure when two exist. These may also be determined by a transformation of one of the foregoing formulæ. Thus,

if there is but one point of contrary flexure, h being its distance from the pier, $M' = \frac{w l h}{2}$; therefore $h = \frac{2 M'}{w l}$. If there be two points of contrary flexure, h being the distance of one from the support over which M' is taken, and v the distance of the other from the other support, then

$$M = \frac{w h}{2} \{ l - v \}, \text{ therefore } h = \frac{2 M'}{w \{ l - v \}}, \text{ and also } M'' = \frac{w v}{2} \{ l - h \}$$

$$\text{therefore } v = \frac{2 M''}{w \{ l - h \}}.$$

We will now proceed with the investigation of the strains on continuous girders of three spans, and as a practical case will be more satisfactory and quite as convenient as a supposititious one, we will select a railway bridge, which carries two lines of railway, and consists of three continuous girders, between which the rails are laid. The centre span is 88.5 feet in length, and the two end ones 85.25 feet each; the depth of the girder is 7ft. 6in., and the weight of the bridge 1.33 tons per foot run. We take the moving load for the two lines of rail at 2 tons per foot run. Our object is now to determine the maximum moments on the piers and on the central parts of the spans, and we may here observe, that as the end spans are equal, the maximum moments on them and on the second and third supports will be equal. There will be one point of contrary flexure in each end span and two in the centre span. To find the maximum moment over the piers, we first take the first and second spans, subject to a total load, the third having its own weight only to carry. We must make two calculations to get near the truth—the first based on the positions of the points of contrary flexure, found by considering each span as distinct and fixed,—and the second found from the revised values of these quantities. Those who desire greater accuracy may obtain it by more numerous approximations and corrections.

In girders fixed at one end, the point of contrary flexure will be $.25 l$ from the fixed end; in this case it becomes $85.25 \times .25 = 21.3$, &c. In girders fixed at both ends, the distance of either point of contrary flexure from one pier is $.25 l$, and for the centre span in the present case, $88.5 \times .25 = 19$, &c. The moments calculated upon these data are, for the second support by the first span, $M' = 85.25 \times 3.33 \text{ tons} \times 21.3 \div 2 = 3023.3$; and by the second span, $M' = \left\{ 88.5 - 19 \right\} \times 3.33 \times 19 \div 2 = 2198.3$. For the third point of support by the second span, $M'' = 2198.3$, and by the third span, $M'' = 85.25 \times 1.33 \times 21.3 \div 2 = 1207.5$. The positions of the points of contrary flexure must now be altered so as to equalise the moments; but on the centre span, by altering the position of one point, we affect the moment on the opposite pier, therefore this must be allowed for. On the second point of support in the second span, the moment, and therefore the distance, of the point of contraflexure must be increased by about $\frac{1}{3}$,—to equal the diminished moment by the first span, and at the other extremity, at the third support, the moment must be reduced by nearly $\frac{1}{3}$. The increment on the second support will decrease the moment over the third by $\frac{19 w}{5} \times 13 = \frac{19 \times 3.33 \times 13}{5} = 164.5$, taking the reduced value of the distance of the point of contrary flexure from the pier. The reduction of this value will increase the moment over the other pier by $\frac{19 w}{3} \times 23 = \frac{19 \times 3.33 \times 23}{3} = 485$, taking the increased value in this case. If we take the unaltered values in both cases we shall find $\frac{19 w}{5} \times 19 = 240.4$ and $\frac{19 w}{3} \times 19 = 400.4$, and the means of these results will be $\frac{164.5 + 240.4}{2} = 202.5$, and $\frac{485 + 400.4}{2} = 442.7$; adding and subtracting these values respectively, we have for the revised moments, as calculated from the centre span, $2198 + 202.5 = 2400.5 = M'$, and $2198 - 442.7 = 1755.3 = M''$, when both are calculated by the centre span. We might, by continuing the above process, approach the truth very nearly; but the present results are sufficiently accurate for our purpose. We shall therefore equalise the values for M' by reducing them to a mean—thus $M' = \frac{2400.5 + 3023.3}{2} = 2712$, which we shall adopt, as the error involved is only about $\frac{1}{16}$ of the result. The value of the other moment is not required, as it is not a maximum. The mean depth of the girder is about 7 feet; hence, dividing by this, we obtain the strain on either flange, which is $\frac{2712}{7} = 344.57$ tons; if we allow 4 tons per square inch as the greatest safe strain direct for either flange we have $\frac{1}{4} 344.57 = 86.14$ square inches for the area of either flange over the second and third points of support. Four tons may seem rather small for tension, but this is accounted for if we consider the loss by rivet holes, which does not exist if the flange is in compression. The calculations may be completed by taking two other

cases, viz., the first span loaded and the second span loaded. In the first case we shall get the maximum moment at the centre of either end span, the second the same for the centre span; these divided by the depth of the girder will give the direct strain in either case, one quarter of which will be the sectional area of all the top, or all the bottom flanges. In a similar manner we might carry our examples to any number of spans; but this is unnecessary, for reasons now to be explained. If we take a variety of continuous girders of equal spans and loads, we shall find that the greater the number of spans, the less will be the maximum moment on each pier. We are therefore quite safe in taking the moment calculated on the piers of a three span girder for those on the piers of a four or five span girder of equal spans, and by so doing we escape the complexity which is unavoidable, if we work the cases out. When, however, the bridge is very heavy, it may be preferable to work the particular case out. There is another consideration which must not be neglected in the construction of continuous girders, viz., the expansion of the metal between the temperatures of summer and winter, which will necessarily limit the length of the girder: thus we see that the Victoria Bridge at Montreal is made in lengths of two spans each, so that the expansion can be conveniently provided for. We will now speak of the weight on each pier.

Let l be the length of any span of a continuous girder, w the load per foot run, M' the moment on the first, and M'' that on the second support, R' R'' being the reactions; then $R' = \frac{wl}{2} + \frac{M' - M''}{l}$, and $R'' = \frac{wl}{2} + \frac{M'' - M'}{l}$, which will give the proportionate weight borne by each point of support for each span. The shearing strains diminish as the ordinates of a straight line, becoming nothing at the point of greatest horizontal strain; thus measuring from this point to any point distant from it towards the pier, the shearing strain at such point will be represented by $w x$, and this shearing strain the web of the girder should be made strong enough to withstand. The strain which may be safely allowed is 4 tons per sectional square inch. If we take the case of a girder fixed at one end and supported at the other, there will be no shearing strain at a point distant $\frac{3}{8}l$ from the pier on which the girder is supported only. Let $l = 180$ feet, and $w = 2.5$ tons; then if $x = 13$ feet, the shearing strain at that point, which will be either 54.5 feet, or 80.5 feet from the pier which supports the free end of the girder, will be $13 \times 2.5 = 32.5$ tons; therefore at these points the least area of the web should be 8.0625 square inches. This is of course very far below what would be necessary for the junction of the flanges.

Before concluding the present paper we will make a few observations upon the method, which we have adopted for the determination of the area of the curve of moments of strain, from which arises a slight error, to which we have already referred. Let $abcd$ in Fig. 2 represent the curv

Fig. 2.

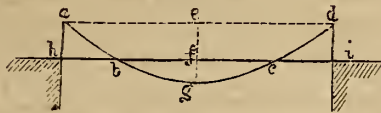

of moments, which is a parabola, b and c being the points of contrary flexure; then we have taken the area of the part $b c g$ as being

$$= \overline{fg} \times \frac{2bc}{3}.$$

This is perfectly correct. The area of the parts $a h b$, $d c i$, we have taken as—

$$= \overline{ah} \times \frac{hb}{2} + \overline{di} \times \frac{ic}{2}.$$

This is an approximation in most cases very near the truth, as the lines ab , dc are usually nearly straight. The correct expression for the area is evidently—

$$= \frac{1}{3} \cdot \overline{fg} \cdot bc - \overline{fg} (\overline{hb} + \overline{ic}) + \frac{1}{3} \cdot \overline{cg} \times \overline{ad}.$$

If m = moment at centre of span, l = span = \overline{ad} , $\overline{hb} = \overline{h}$, and $\overline{ci} = \overline{v}$; then the area

$$= \frac{1}{3} \cdot m \{l - (\overline{h} + \overline{v})\} - m(\overline{h} + \overline{v}) + \frac{1}{3} \cdot \frac{wl^3}{8}.$$

It will generally be found that the formula we have adopted is sufficiently correct, but we deemed it desirable to supply our readers with an accurate account of our data, so that they may, if they choose, work out approximations for themselves. All our results have been compared with those obtained by the process mentioned at the commencement of the paper, and it is from these comparisons that we have deduced the amount of error in our various formulae.

STABILITY.

(Illustrated in Plate 190.)

STABILITY, STRENGTH and STIFFNESS are necessary to the permanence of a structure, under all the variations or distributions of the load or stress to which it may be subjected.

STABILITY OF A FIXED BODY is the power of remaining in equilibrium without sensible deviation of position, notwithstanding the load or stress to which it may be submitted may have certain deviations.

STABILITY OF A FLOATING BODY.—A body floating in a fluid is balanced, or at rest, when it displaces a volume of the fluid, the weight of which is equal to the weight of the floating body, and when the centre of gravity of the floating body and that of the volume from which the fluid is displaced are in the same vertical plane.

When a body in equilibrium is free to move, and is caused to deviate in a small degree from its position of equilibrium, if it does not tend to deviate further, or to recover its original position, its equilibrium is termed *Indifferent*; when it tends to deviate further from its original position, its equilibrium is *Unstable*; and when it tends to return to its original position, its equilibrium is termed *Stable*.

A body in equilibrium may be stable for one direction of stress and unstable for another. Assume fig. 6 to represent the cross section of the hull of a vessel; G the centre of gravity of the hull; $W L$ the water line; and C the centre of buoyancy of the immersed section in the position of equilibrium; conceive the vessel to be heeled or inclined over, so that $c f$ becomes the water line, and b the centre of buoyancy of the immersed section, produce $b m$ and the point m is the *meta-centre** of the hull of the vessel.

The COMPARATIVE STABILITY of different hulls or vessels is proportionate to the distance of $G m$ for the same angles of heeling or of the distance $G d$.

The oscillations of the hull of a vessel may be resolved into rolling about its longitudinal axis, pitching about its transverse axis and vertical pitching, consisting in rising and sinking below and above the position of equilibrium.

If the transverse section of the hull of a vessel is such that when the vessel heels, the level of her centre of gravity is not altered, then her rolling will be about a permanent longitudinal axis traversing her centre of gravity, and it will not be accompanied by any vertical oscillations or pitchings, and the moment of her *inertia* will be constant while she rolls; but if when the vessel heels the level of her centre of gravity is altered, then the axis about which she rolls becomes an instantaneous one, and the moment of her *inertia* will vary as she rolls, and her rolling must necessarily be accompanied by vertical oscillations.

Such oscillations tend to strain a vessel and her spars, and it is desirable, therefore, that the transverse section of her hull should be such that the centre of its gravity should not alter as she rolls—a condition which is always secured if all the water lines, as $W L$ and $e f$, are tangents to a common sphere described about G ; or, in other words, if the point of their intersections, o , with the vertical plane of the keel is always equi-distant from the centre of gravity of the hull.

TO DETERMINE THE MEASURE OF THE STABILITY OF THE HULL OF A VESSEL OR OF A FLOATING BODY.

The measure of the stability of a floating body depends essentially upon the horizontal distance, $G d$, of the meta-centre of the body from the centre of gravity of the body, and it is the product of the force of the water, or resistance to displacement of it (acting upwards), and the distance of $G d$, or $P \times G d$. If the distance $c m$ is represented by e , and the angle of rolling $c m b$ by M° , the measure of stability, or S , is determined by $P \times e \times s m M^\circ = S$; and this is therefore the greater; the greater the weight of the body the greater the distance of the meta-centre from the centre of gravity of the body, and the greater the angle of inclination of this or of $c m b$.

RESULTS OF EXPERIMENTS UPON THE STABILITY OF RECTANGULAR BLOCKS OF WOOD OF UNIFORM LENGTH AND DEPTH, BUT OF DIFFERENT WIDTHS.—W. BLAND.

Length 15 in.; Depth 2 in.; and Depression 1 in.

Width.	Weight.	RATIOS OF STABILITY.			
		As observed.	With like weights.	By squares of the widths.	By cubes of the widths.
In.	oz.				
3	24	1	1	1	1
4.5	35	3.5	2.4	2.25	3.375
6	45	7	3.7	4	8
7	55	11	4.8	6.25	15.625

* The meta-centre depends upon the position of the centre of buoyancy, for it is that point where a vertical line, drawn from the centre, intersects a line passing through the centre of gravity of the hull of the vessel, perpendicular to the plane of the keel. The

Hence it appears that rectangular and homogeneous bodies of an uniform length, depth, weight and immersion in a fluid, but of different widths, have stability for uniform depressions at their sides (heeling), nearly as the squares of their width, and that when the weights are directly as their widths, that their stability under like circumstances is nearly as the cubes of their width. Further experiments deduced the following results:—

1. That rectangular and homogeneous bodies of an uniform width, depth, and immersion in a fluid, but of different lengths, have stability for uniform depressions at their sides, nearly as their weights, and without reference to their lengths, and that when the weights are directly as their lengths, that their stability under like circumstances is nearly directly as their lengths.

2. That like bodies of an uniform width, length, an immersion of half their depth, but of different depths, have stability for uniform depressions at their sides, nearly inversely as their depths, and that when the weights are directly as the depths, that their stability is inversely as their depths.

RESULTS OF EXPERIMENTS UPON THE STABILITY OF MODELS HAVING MIDSHIP SECTIONS OF DIFFERENT FORMS, BUT OF UNIFORM LENGTH, WIDTH, AND WEIGHTS.

(Immersion different, depending upon form of section.)

Form of Immersed Section.	Stability.
Semicircle	9'
Rectangle	14'
*Right-angled triangle	7'
Half depth triangle, the other half rectangle.....	12'

* Draught of water or immersion double that of the rectangle.

STEAM.

(Continued from page 61.)

THE DENSITY OF SATURATED STEAM.

On the principle of the mechanical equivalence of heat, according to which heat, and work or duty performed, are convertible into and representative of each other, the investigation of the properties of steam may be conveniently conducted in terms of one form of expression or the other—heat, or dynamic effect—as the nature of the experimental evidence may demand. The density of saturated steam is one of its properties which has not yet been accurately determined by direct experiment; nor, of course, has the relative volume, which is inversely as the density. The density of steam is expressed by the weight of a given constant volume—say one cubic foot; and the relative volume by the number of volumes of steam produced by one volume of water—hence called relative. The density and the relative volume are, however, most accurately determinable by means of the pressure, temperature, and latent heat of steam, all of which have been subjects of careful and comprehensive experiment. When steam is freely generated in contact with water in a boiler, the actual process of generation consists, first, in heating the water to the temperature due to the pressure under which the steam is generated; second, in the absorption of a large quantity of heat which becomes latent—not affecting the thermometer—and is replaced physically by a quantity of steam of the same temperature—the sensible heat of the water continuing sensible in the steam. It is properly argued, then, that the specific function of converting the water into steam, of changing a non-elastic into an elastic substance, of thus developing a reservoir of motive-power where none existed before, is performed by the latent heat; and that, inasmuch as the process is just the conversion or change of form, of heat into elastic force, the force or power so manifested is simply commensurate with the latent heat; and if the latent heat, the amount of which is known experimentally, be converted into foot-pounds, in terms of Joule's equivalent, it will constitute one side of an equation, which will show on the other side the dynamic expression of the relative temperature and pressure, which also are directly known by experiment.

Suppose one pound of water in contact with other water, to be converted into one pound of steam within a boiler, and that the process of heating and conversion be commenced at the bottom of the scale of absolute temperature, at 461° below zero, Fahrenheit. Whether it be possible or not, it is at least conceivable that the whole of the given weight of water may

point of the meta-centre may be the same, or it may differ slightly for different angles of heeling. The angle of direction adopted to ascertain the position of the meta-centre should be the greatest which, under ordinary circumstances, is of probable occurrence; in different vessels this angle ranges from 6° to 20°. If the meta-centre is above the centre of gravity, the equilibrium is stable; if it coincides with it, the equilibrium is indifferent; and if it is below it, the equilibrium is unstable.

be in a state of vapour at 1° absolute temperature, of extreme tenuity, indefinitely large in volume, and indefinitely low in pressure; let it be supposed that this one pound of steam occupies the entire capacity of the boiler, and let the temperature be raised to 2°; another portion of vapour would be generated, occupying part of the capacity of the boiler, and forcing the prior steam into smaller compass, and thus increasing its density. If the temperature be thus continually elevated by degrees, the particular pound of steam under consideration would be continually reduced into smaller bulk, and its density would be increased, and likewise the pressure. It may properly be conceived, therefore, to undergo a process of compression from its conception to maturity—the increments of pressure accumulating with the increments of density and pressure. Now, the work of dynamic force accumulated in the given pound of steam, in virtue of the successive compression to which it may be supposed to have been subjected, is the same in quantity for each degree of temperature:—it is equal, in fact, to the product of the final increment of pressure multiplied into the final volume of the steam. Or—regarding the problem in another way—a pound of water is converted into a pound of steam, generating and occupying a certain volume, and this volume is consumed with a final increment of pressure for the final degree of temperature.

This final increment of pressure, then, represents, for this particular volume, one degree of temperature; and if multiplied into the volume, is an expression of the action for one degree of temperature. If further multiplied by the absolute temperature in degrees, the resulting product expresses the whole of the latent heat of evaporation inherent in the given weight of steam.

In strict argument, this mode of estimation, in terms of the whole volume of the steam, gives a result slightly in excess of the literal result, as the volume actually generated is not the whole final volume, but only the excess of this above the volume of the water from which it is generated.

To vary the form of the argument, suppose the final volume of the given pound-weight of steam to be erected into a vertical column on 1 square foot of base, the column would of course weigh 1 pound; and if the height be multiplied by the final increment of pressure in lbs. per square foot for one degree of temperature, the product would express the height of a vertical column of the steam on 1 square foot of base, equal in weight to the final increment of pressure. If the weight be again multiplied by the absolute temperature, the ultimate product will express the latent heat of 1 pound weight of steam in "feet of fall" of 1 pound, that is, foot-pounds; and, further, dividing by 772, Joule's equivalent, the quotient will be the equivalent value of the latent heat in units or degrees of Fahrenheit's scale.

This form of reasoning, no doubt, contains a principle of hypothetical origin, according to which the actual heat present in a substance is simply proportional to its temperature, measured from a certain point of absolute cold, and multiplied by a specific constant; and "although," as Professor Rankine observes, "existing experimental data may not be adequate to verify this principle precisely, they are still sufficient to prove that it is near enough to the truth for all purposes connected with thermo-dynamic engines, and to afford a strong probability that it is an exact physical law."

Let g = the increment of pressure for the final degree of temperature in lbs. on the square foot; 772 foot-pounds = the mechanical equivalent of 1 unit of heat, or so much heat as would raise the temperature of 1 pound of cold water 1°; L = the latent heat of 1 pound of water in units, which is of course identical with the latent heat in degrees deduced from the temperature; T = the absolute temperature; V = the volume of 1 lb. of steam in cubic feet, and v the volume of the water from which it is generated; then $V - v$ = the volume generated, and the contemplated equation would be as follows:—

$$772L = Tg(V - v);$$

or, for simplicity, let the volume of the water be neglected, as it is not practically important, then the equation would be—

$$772L = TgV.$$

From this equation, it follows that the latent heat of one pound of steam is

$$L = \frac{TgV}{772} \text{ units of heat; or,}$$

$$L = TgV \text{ foot-pounds.}$$

Consequently, also, the latent heat l , of one cubic foot of steam, dividing the above quantities by V , is

$$l = \frac{Tg}{772} \text{ units of heat; or,}$$

$$l = Tg \text{ foot-pounds.}$$

The volume of 1 lb. of steam in cubic feet, L being expressed in units of heat, is

$$V = \frac{772L}{Tg} \text{ cubic feet.}$$

As the weight of 1 cubic foot of cold water is 62.3 lbs., it follows that 62.3 V is the volume, in cubic feet, of the steam generated from 1 cubic

foot of water. If n be the relative volume, then $n = 62.3V$, and $V = n \div 62.3$; and, by substitution,

$$\frac{n}{62.3} = \frac{772L}{Tg};$$

from which the relative volume of the steam is

$$n = \frac{772L}{Tg \div 62.3};$$

also, conversely, the latent heat, in Fahrenheit degrees, in terms of the relative volume, is

$$L = \frac{nTg}{772 \times 62.3}.$$

For illustration, let the temperature be raised from $211\frac{1}{2}$ to $212\frac{1}{2}$, through one degree, the pressure will rise from 2094 lbs. to 2136 lbs. per square foot, making the increment of pressure $g = 42$ lbs. per square foot. The mean temperature is 212° , and the absolute temperature $T = 461 + 212 = 673^\circ$. The latent heat Tg in foot-pounds, of 1 cubic foot of steam at 212° , and a pressure of 14.7 lbs. per square inch, or 2116.8 lbs. per square foot, is, therefore, $673 \times 42 = 28,266$ foot-pounds. To determine next the value of V , the volume of 1 lb. of steam at 212° , and at atmospheric pressure, let the steam be gaseous, then, by the equation for gaseous steam (which will be afterwards explained), $V = 85.4T \div P = 85.4 \times 673 \div 2116.8 = 27.16$ cubic feet; and substituting numerical values, we have for the latent heat of 1 lb. of gaseous steam at 212° , and atmospheric pressure,

$$L = \frac{TgV}{772} = \frac{673 \times 42 \times 27.16}{772} = 994.4,$$

which is precisely the latent heat of gaseous steam at 212° , as deduced by Mr. Brownlee, in terms of Regnault's constant for the specific heat of gaseous steam, namely, .475.

According to the preceding equations, the volume of 1 lb. of saturated steam at 212° , is

$$V = \frac{772L}{Tg} = \frac{772 \times 965.1}{673 \times 42} = 26.36 \text{ cubic feet};$$

and the relative volume of the same steam is

$$n = \frac{772 \times 965.1}{673 \times 42 \div 62.3} = 1642 \text{ volumes,}$$

which has been, but erroneously, considered to be 1700 volumes.

The density or weight of 1 cubic foot of saturated steam is readily deducible from the equation for the volume in cubic feet of 1 pound of steam, in which $V = 772L \div Tg$; as the weight of a cubic foot is simply the inverse of this equation. Thus, the density D , or the weight in pounds of 1 cubic foot = $\frac{1}{V}$, or

$$D = \frac{Tg}{772L}.$$

Mr. James Brownlee has deduced a simple expression for the density of saturated steam in terms of the total pressure, thus—

$$D = \frac{p^{.941}}{330.36}; \text{ or,}$$

$$\text{Log } D = .941 \log p - 2.519;$$

in which D is the weight of 1 cubic foot of steam, of the pressure p Fah. The results presented by means of this formula are very accurate; they do not differ from those obtained in terms of the temperature and latent heat of steam for pressures from 1 lb. to 250 lbs. per square inch by more than one-seventh per cent. The volume in cubic feet of 1 lb. of saturated steam is of course expressed by the inverse of the weight in pounds of a cubic foot of the steam, thus $V = \frac{1}{D}$, consequently

$$V = \frac{330.36}{p^{.941}}; \text{ or,}$$

$$\text{Log } V = 2.519 - .941 \log p.$$

Again, the relative volume of the steam is expressed by the ratio of 62.3 lbs., the weight of a cubic foot of water, to D , the weight of a cubic foot of steam; hence, $62.3 \div \frac{p^{.941}}{330.36} = 62.3 \times 330.36 \div p^{.941}$, = the relative volume. Putting n = the relative volume,

$$n = \frac{20559}{p^{.941}}; \text{ or,}$$

$$\text{Log } n = 4.3135 - (.941 \times \log p);$$

from which it appears that the relative volume of saturated steam of 14.7 lbs. pressure per square inch, and 212° temperature, is 1642, the same as was found before in terms of the temperature and latent heat.

(To be continued.)

CONVERSION OF CAST IRON INTO STEEL.

BY THE BARON DE ROSTAING.

(Concluded from page 53.)

There are in mechanics a number of tools and implements, and a number of essential parts in machinery, which it would be easy to bring to their proper form by casting them in moulds, but which, by reason of the high price of steel, continue to be made of cast iron, though it would be useful and preferable to substitute a more tenacious metal, which, whether tempered or not, will admit of a finer polish;—thus, for instance, crushing and pounding cylinders or rollers for agricultural purposes continue to be made of cast iron.

But it would be useless to proceed any further with such nomenclature, as I have a few more particulars to give concerning fusion, according to my process.

In this, as in all industrial operations, hand-skill is to be considered. Thus, for instance, the order in which materials are to be thrown and arranged in the crucible is by no means immaterial. The mode of treatment I will now describe, has always given very satisfactory results.

The iron in the granulated state,—powders or grains, is first separated in three sieves of different meshes.

Upon charging my crucible, and when it has been raised to the white heat, I throw into the bottom the most finely oxydised powder, then successively the middling and the largest grains; I afterwards place on the topmost of these layers the fragments of pig iron, covering then my crucible with a lid just enough to prevent combustible matters from intruding into the materials to be melted. I imagine that the following is what takes place during fusion.

The fragments of carburetted cast iron being thrown on the layers of the granulated iron, are soon liquified, and, dropping down, gradually go filtering, as it were, between the powdered grains which may have become agglutinated, as it were, by the action of a high temperature, yet leaving between them some empty spaces, whose existence is sufficiently proved by the small specimen I have submitted to your examination. On its passage through the underlying porous mass, the liquid cast iron comes in contact with the oxyde which surrounds each particle of the layers of the granulated iron. The combination of oxygen and carbon must also evidently take place, and also probably all other combinations which have been facilitated and prepared during the oxydising operation by the wet process.

Before reaching the bottom of the crucible, the cast iron first entered into fusion has, in consequence of those various combinations, probably liquified a portion of the underlying layers of the pulverised or granulated iron corresponding to the oxygen abstracted from the oxydes by the carbon which has consequently passed to the state of gaseous carbonic oxyde. The liquid cast iron thus being increased in bulk, as it is of superior density to that of the grains of iron, the adherent oxyde of which has not yet been decomposed, will cause the grains which still remain conglomerated together to ascend and keep floating upon the liquid mass, although a number of such particles remain immersed therein, as was the case in the operations previously described, and which will be the case when the whole of the mass does not contain a proportion of carbon in sufficient excess for the entire reduction of the oxydised part.

While upon this subject, I would observe I am inclined to think, from the experiments above cited, that there is a decarburating point beyond which any excess of oxide will be of no avail, and at this particular moment the exact alloy, which it is admitted, constitutes the steel, ceases to part with its carbon. For this reason, I am not inclined entirely to coincide with Mr. Bessemer's ideas as to the conversion of cast iron into steel. My opinion is that here chemical agents are insufficient, and that decarburation can only be thoroughly and finally effected under the repeated action of hammers or finishing rollers.

It has certainly been remarked, that during fusion I cover my crucible but just enough to prevent combustible matter from dropping into its interior. I will now say, further, that I uncover it entirely as soon as the operation is so far advanced, as to render it unnecessary to introduce a fresh charge of coal. This is, I know, contrary to common practice in the manufacturing of cast iron, and it will serve me to explain why I thought proper to mention the use of reverberatory furnaces in my process, although the means hitherto at my command would admit only of the use of crucibles. I will state the motives which induce me to believe that reverberatory furnaces can yield as regards the quality of the products the same results as crucibles which, with regard to the quantity to be melted in the same operation, would show a marked superiority over the actual mode of manufacturing cast steel.

Why should it be an obligation in the actual method of proceeding, to make use of crucibles, notwithstanding their high cost, considering their short duration, and in spite of the difficulties, or rather impossibilities, which they present in the manufacturing of heavy pieces? Such necessity is obvious when we consider what are the materials employed for producing cast steel—viz., cemented iron, steel termed natural or puddled-steel, all of which contain the desired proportion of carbon for forming steel, but un-

equally distributed in the mass. The fusion to which those materials are submitted has not merely for its object the introduction of fresh elements into their constitution, but to better equipose what they already contain; or if any addition should be required, it would be an addition of carbon. Consequently, care must be taken not to allow the free access of atmospheric air into the crucible, for fear of introducing the very agent best calculated to destroy that exact proportion of carbon brought in at great expense in the previous operations of cementation or puddling.

On the contrary, with my own process, far from having to fear decarburation, I encourage it. The very agent which would hitherto have proved noxious is the same I am now most in want of; and all my preliminary operations tend to increase its power. Why, then, should I be afraid of its presence in the final operation?

It must be self-evident that I am correct in preventing combustible matters from entering my crucible, for I am operating on materials containing carbon in excess, and this intrusion would still further increase the proportions which I want to diminish. By the use of a reverberatory furnace, there can be no such intrusion of combustible matters, since they are separated from the metal by the bridge, and laid besides on a separate grating; and as regards the air which may enter the furnace either through the grating or otherwise, I have proved sufficiently that, far from being an obstacle, it will assist in the accomplishment of what is required.

To conclude, I shall observe that Mr. Bessemer's process, however efficient it may be, is only applicable to large establishments, in consequence of the number of tools and implements, and the power it requires; whilst the preliminary means I make use of, being liable to yield other products than steel, are not necessarily limited to such manufacture.

The pulverising of cast iron may perhaps prove the starting point of a special branch of manufacture—say, the production of oxides of iron of great purity and cheapness for the use of artists and painters, and, which would be employed with very beneficial results, for the preservation of the hulls of iron ships, more especially as the injurious effects arising from the use of minium, or red lead, for this latter purpose have been proved in England. This process for the conversion of cast iron into steel, so as to enable materials to be produced *ready prepared*, to meet the requirements of other trades, would only necessitate the erection of furnaces for the fusion of the metal, and would be brought within the capabilities of the lesser branches of industry. Now, by affording additional facilities to the latter, it will cause the employment of a number of heads and hands in order to arrive at the same end, and give an additional impetus to the onward march of progress.

INSTITUTION OF NAVAL ARCHITECTS.

Thursday, Feb. 28th, 1861.

The Right Hon. Sir JOHN S. PAKINGTON, Bart., G.C.B., President of the Institution, in the Chair.

The proceedings commenced with a brief address from the President, in which he expressed his gratification at having been elected President since the Institution last met, and stated that he looked for great benefit to the State resulting from the proceedings of the body. He stated that a communication from General Sir Howard Douglas had just been received by the Secretary, and he thought it would be only a proper tribute of respect to pay to that distinguished man to call upon the Secretary to read his communication as the first part of the business of the day.

The communication from General Sir Howard Douglas, of which we gave the material portions, was accordingly read. He stated that in his remarks on the subject of iron ships and iron-cased ships he had taken care not to confound the two questions together. He considered the *Warrior*, and the other vessels now being built of timber combined with iron, to belong to the category of iron-cased ships; for although the only timber used in the formation of the *Warrior* consisted of two layers of wood, 8 and 10 inches thick respectively, placed behind the plates, yet, but for the timber by which the plates were backed up, the side of the ship would not be shot-proof, nor could the plates be firmly fixed. Timber being thus indispensable to the formation of iron-cased ships, placed them constructively in the category of ships formed of a combination of wood and iron, entirely distinct from ships formed wholly of iron. With respect to vessels formed wholly out of iron, he contended that in vessels constructed wholly of iron plates $\frac{3}{4}$ ths of an inch thick, the weight of material in the shell of a ship was considerably less than that of a timber vessel of the same dimensions, and they would therefore carry a greater weight of cargo, and have greater capacity for stowage, on account of the thinness of their shell than timber ships, and that thus iron might not only be made to float, but to carry a cargo of greater weight and bulk than a timber ship of the same dimensions. But the danger to life and property of those thin-skinned vessels was such as, in his opinion, to render them wholly unfit for the purposes and contingencies of war, and likewise for purposes of commerce in war. The reason why the bottoms of the *Warrior* and other iron-cased vessels now being built were not formed of timber was not a denial of the proofs exhibited of the perishable nature of iron when long exposed to the corroding effects of salt, bilge, and sea-water, but because timber could not be obtained of scantling requisite for building ships of such enormous tonnage. But that was not so in the contract for building the iron-cased timber frigate for the service of Russia, although she was to be of 4200 tons displacement, length 300ft., breadth 55ft., and total depth 55ft. inside, and was to be covered

fore and aft with $\frac{1}{2}$ -inch iron plates, the total weight of which was 1250 tons, at £37 a ton, her engines 1000 horse power, but it was found that with such a top weight the speed would not be more than 11 knots; so true was it, that speed and metallic protection throughout were antagonistic. In stating the conclusion at which he had arrived, that iron-cased ships were not invulnerable to the penetrations and impacts of heavy solid shot, he did not deny that they were less vulnerable by being so protected than ships not so covered, and, although we would not have initiated such a system, yet so long as our neighbours, the French, persisted in building iron-cased ships, we must do so likewise, and that in a manner to keep well ahead of anything the French or any other power might do for aggressive purposes. The country was much indebted to Sir John Pakington for having had the moral courage and the administrative enterprise to effect that, and on a scale adequate to satisfy all the requirements which such vessels demanded, and which could not be obtained by vessels of the displacement of *La Gloire*. It was a fact well-known to shipbuilders that the bottom of a well-built copper-fastened timber ship scarcely ever wore out, and would wear out at least three tops. But it was the reverse in iron ships, for one top would wear out three bottoms, as was proved by iron plates now at Lloyd's for the inspection of underwriters. Numerous instances, several of which he cited, occurred of wooden ships getting off the strand on which they had struck without apparent damage; and he contended that had they been iron vessels all of them would have been lost. The numerous losses continually occurring of merchant steam-ships, nine-tenths of which were formed of thin iron plates, and particularly the loss of the *Connaught*, the *Queen Victoria*, and the *Victor Emmanuel*, which broke up as soon as she struck, like a glass bottle against a stone, had produced great disinclination on the part of the underwriters, and determined some to refuse, to insure iron ships. In the wreck of timber ships there was always some, and generally a considerable, compensation to the underwriters from salvage; but, he asked, what was the salvage on the *Birkenhead*, the *Royal Charter*, and many other iron vessels which had been lost? The salvage on the *Victor Emmanuel*, which cost £10,000, was £20. He knew something of that description of architecture the foundations of which were laid in Britain's native element—the sea. He was, every inch of him, a sailor. The army was not the profession of his choice. He was born to the sea, nurtured, tutored, devoted, and destined to it. He would not follow Mr. Scott Russell in the plunge he had taken to dive into the future of the British navy; but to the question put in that gentleman's pamphlet—"Iron or Wood; which shall it be?" he (Sir H. Douglas) confidently replied, of neither singly, but by a combination of both, to constitute that new description of vessels for special purposes in which the French had taken the lead, but which lead we must take out of their hands, by constructing iron-cased ships which, like theirs, should be formed of timber; that was on wooden bottoms, having iron-cased sides, the number and strength of those vessels to be extended according to circumstances. With respect to ships formed wholly of iron, he adhered firmly to the opinion that they were utterly unfit for any of the purposes of war. The *Great Eastern* belonged to that category, and no one could assert that a vessel that might be perforated through and through by 68-pounder solid shot was fit for such purposes. Being formed of plates proof against shells, no shells would be fired at her, but solid shot would do the work far more effectually. No real test of the resistance of the iron-cased ships to shot, nor of ships formed of thin plates of iron, would be made till trial in a state of war, and then the very existence of the country would be at stake on a theory—a speculative experiment, untried in war. It had been said in the *Times* that, if the *Warrior* was successful, we might bid adieu to timber ships, but the reverse would be the case. Her success would bid adieu to ships formed of thin plates of iron, because if those ships were not made shot proof by their thin skins being covered with massive layers of timber, and these in turn covered with $\frac{1}{2}$ -inch iron plates, they would not be fit for war purposes, and, if so covered, would be unfit for commercial purposes in war, having their tonnage either wholly or greatly absorbed, according to their size, by the weight put upon them.

Mr. Samuda, a member of the Council, read a paper "On the Construction of Iron Vessels of War Iron-cased." He entered briefly into the history of such vessels, from their first introduction in 1855-56, adverting especially to the *Thunderbolt*, *Etma*, and *Terror*, which were built from designs and specifications supplied by the Admiralty. They were vessels of 2000 tons burden, pierced for 30 guns, and fitted with engines of 200 horse power. They were intended for attacking Cronstadt, and were constructed on the reduced draught of water of 8ft. 6in. The hull was built entirely of iron. The top sides were then covered with teak 6in. thick, and reaching from the gunwale to about 2ft. below the deep-water line, a distance of about 13ft., and this teak was again covered with wrought iron armour plates, averaging 4in. in thickness, bolted against the teak and through it and the iron skin of the vessel. The armour reached from stem to stern, and thus protected the entire topsides of the ship, and also 2ft. under water. They made very fair speed, considering their reduced draught of water and power, and steered well. The Russian war terminating, they were never brought into action, but the *Thunderbolt* stood the test of a severe examination at Chatham Dockyard, nearly five years after her completion; the result being to prove that the greatest durability might be calculated upon in vessels of her construction. He showed how for three years iron-plated vessels were discouraged in every way, until January, 1859, the Admiralty called upon several of the leading shipbuilders for designs and suggestions for a 36 gun frigate, suggesting that for a length of 200ft. the middle part of the vessel should be rendered shot proof by covering the iron skin of the ship with hard wood, equal in substance to the timbering and planking of the topsides of a ship of the line, and thus forming a backing for the armour plates, which were to be $\frac{1}{2}$ in. in thickness, and bolted through the hard wood backing to the iron skin of the ship. The great error of that was the leaving the two ends of the vessel entirely unprotected, and he sought to correct it. He proposed to adopt an iron vessel, to build the hull double from the keel to the lower edge of the armour plates, and above that point to protect and

strengthen the topsides fore and aft with two thicknesses of teak, worked on the outsides of the skin plating, and a third thickness of teak-work on the inside of the same, and bolted through and through. The united thicknesses of teak would thus be 18 inches, and that planking would serve as a backing for the armour plates to the extent they covered the ship's side. He proposed to fasten the armour-plates at their edges only, so that each bolt should hold two plates, and thus prevent weakening the plates to the same extent as the holes some distance from the edges did. None of his proposals, however, were adopted; but one, designed in the office of the Surveyor of the Navy, was selected by the Admiralty, and the *Warrior* and *Black Prince* were built from it. Those vessels were 380ft. in length, 58ft. in breadth, 33ft. deep from main deck, and 6038 tons. They were protected by $4\frac{1}{2}$ -in. armour plates for about 200ft. of their midship length, extending from gunwale to 5ft. below water, with 18in. of teak backing interposed between the armour plating and the skin of the vessel; but the ends of the vessel were left wholly unprotected, which was very objectionable, though, as far as regarded the general design of the ship, nothing was left to be desired. Of the *Defence* and *Resistance*, two smaller vessels, each 3668 tons and 600 horse power, now in course of construction, the general arrangements were similar in all respects. A further contract had just been entered into by the Admiralty for two vessels, each 4062 tons and 800-horse power, in which he was glad to see the importance of protecting the extremities of the vessel had been recognised and was partially being carried out. He had long been convinced of the necessity of introducing iron-vessels, iron-cased very extensively into our navy, and he believed that conviction was daily gaining ground, even among those who had been hitherto altogether opposed to it. The result of a great deal of thought had led him to a conclusion that the present plan was not the right one. He was of opinion, first, that no teak backing would ever be effective to prevent the breakage of the armour plate, if the shot blow was sufficiently severe to break the plate without backing. Second, that a teak facing would have some beneficial effect by resisting the force of the blow before it reached the armour plate. Third, that an increased thickness of plate, such as would render the weight per superficial foot of the armour plate alone equal to the weight of the armour plate and backing together, as at present being used, would be better than either—namely, an armour plate six inches thick, without backing, would be better than a $4\frac{1}{2}$ -in. plate with 18in. teak backing. He had made some experiments on a small scale with steel plates, and he found that a steel plate $\frac{1}{8}$ inch thick could be perforated with a Minie bullet fired from an English rifle at 100 yards' range with a charge of $2\frac{1}{2}$ drachms of powder. He adopted in all his experiments, therefore, that thickness of steel plate and distance of range, and used the same rifle and similar bullets in all cases. In all of them the destruction to the plate was the same. The back had rendered no assistance, either in preventing the fracture of the plate or even in decreasing the extent of indenture made by the bullet, or changing the form of the indentation in the least. He then reversed two of the plates and fired at them from the wood side. The retardation of the bullet and its consequent power to penetrate was immediately manifested by its not being able to dent the plate when it reached it through the wood in the slightest degree. It was impossible from an examination of the plate to tell where the bullet had reached in its passage through the wood facing. The conclusion to be drawn from that was clear, that if our defence was to be made up of wood and iron we had a much more efficient armour where our second defence was iron and the first defence wood.

Mr. Scott Russell next delivered an address on "The Professional Problem presented to Naval Architects in the Construction of Iron-cased Vessels of War." He first adverted to the practical difficulties which presented themselves to the naval architect in endeavouring to combine with the shot-proof character of the new kind of ship all the good qualities which had hitherto been considered indispensable to a sea-going vessel. In the solution of that problem the naval architect had everything against him. He was obliged to carry more weight than before, and to carry it in the worst possible place. He was obliged to load his vessels with a large quantity of coating, and he was asked to go faster with all that load than any ship of war had ever gone before, and under that superincumbent weight he was expected to preserve a perfectly stable gun platform. He held that it would be the greatest national misfortune if all the experience of our great shipbuilders and naval authorities was not brought to bear very earnestly on the solution of that most difficult question, and that without further delay. He asked was it, or was it not, politic in us at the present moment to endeavour to observe secrecy in matters of naval architecture connected with purposes of war? Ever since 1855 he himself had been observing the policy of secrecy, divulging his views only to the authorities at the Admiralty; but a department of the Government having made public the report of the Secret Commission which sat last year on the defences of the country, he and others interested in naval architecture could not hesitate to follow so excellent an example. (A laugh.) He believed our policy in that respect ought to be a simple one. If we kept secrets of that kind it was not from the enemy, but from the friends who would be willing to help us. (Hear, hear.) As soon as a matter became so serious that it could only be carried into effect by the national will and resources, and by a determination of the Government, or the Legislature to have what we wanted, from that moment it was absurd to attempt to invest it with mystery. Our strength in these matters lay in the national power of productiveness, and whatever policy we decided to adopt—whether it was a wooden fleet coated with iron, or an iron fleet coated with wood, or an iron fleet coated with wood and iron—we had only to act upon a large and comprehensive system, and we need not be afraid of the plan of our fleet leaking out; because, once resolved to do it, the productive powers of England were so great, that we could construct a fleet in a far shorter interval than all the rest of Europe could do, even if they combined to make the attempt. (Hear, hear.) The task of the shipbuilder in preparing the design of an iron-plated ship was peculiar, in that he had nothing to copy. The profession was, therefore, called upon to exercise its highest function, and to create a new class of vessel, having little in common with any other previously built. But the sailor was even more deeply con-

cerned in this matter than the shipbuilder—the admiral than the architect. If it was true that the British sailor was the best in the world, it was the duty of the nation to see that he had the best ships in the world to fight in. What the naval profession had to do was, to tell the shipbuilder beforehand exactly what it was that they did want. All practical naval constructors would agree with him that it was too common for their masters to ask impossibilities. An admiral with authority proportioned to his rank would require them to construct for him a ship which should be fast. They prepared a design, and he exclaimed that would never do; they had made her so long that she would not steer. He demanded 13 knots, and refused to allow more than 250ft. of length. He required that she should stand up like a church (a laugh), and refused the tonnage of the large beam necessary to keep her upright. He urged the use of high power for speed, and refused length of body to carry her boilers. He demanded coals for a great many days, and a draught of water that would not carry them. He asked for a ship that would be as handy as a boat, and as quick as a cutter, and refused the length of tiller or turns of the wheel to afford sufficient purchase. He wanted a steady ship, and laid on an amount of top weight that made her stagger. These were some of the causes which led to bad ships, and to worse understanding between builders and users of them. The fighter of the ship and her builder must come to a thorough understanding at the outset; and he (Mr. Russell) trusted it might be one of the results of that meeting that the naval commander of a future fleet would let the constructors, who would do anything for him but impossibilities, know what it was he wanted. An admiral, present or future, would say he wanted as many guns as possible, and a steady and roomy platform to fire them from. Next, he wanted his ship to carry her ports well out of the water. To be plain, these things were difficult, if not impossible, in combination, especially in a shot-proof ship. In any case, they were costly; he did not mean in money; but in other points of perhaps of equal importance. But they could be had if they were worth the sacrifice. At the outset, then, they had to ask the naval commander to settle what was the height at which his first-rate must carry her ports out of the water. Was it to be 5, 6, 7, 8, or 9ft.? 5ft. was an old first-rate; 6ft. 6in. was the *Gloire*, and 9ft. was the *Warrior*. Given the beam of the ship, every foot in height added enormously to the difficulty of insuring a steady gundeck; and an unsteady gundeck lost all the good for which a high port was wanted. He had ventilated this question much among his naval friends. None of them would let him off with less than 7ft. for port sill out of the water for a seagoing ship, and on our shores there was no question of any other. Most of them were content with 8, and some said that 9 was better, at whatever cost. To all that he had but one answer. They could have 9ft. with certainty, but at a great cost, and that cost was implied in the great beam which was necessary to carry a main deck and its weights so high out of the water. Again, he must ask them to settle how much room they wanted on deck to fight each gun. Most of them said they would be satisfied with ports 15ft. apart, from centre to centre. That was moderate and fair, but it was costly, and 12ft. would do. Then they wanted their ship to be shot-proof. What would the naval commanders accept as shot-proof? Did they mean shot-proof in proportion as wooden liners were shot-proof in old days; that was, a great many shot stopped by the hull of the ship and sticking in her side, and not so many getting through and wounding men, and disabling guns? Or did they mean absolutely impenetrable to modern artillery? To ask too much in that was also to be heavily paid for. His belief was that 6in. of good iron plate, judiciously put together, would keep out anything. His old friend, Mr. R. L. Stephens, of New York, whom he took as the father of this system, found it kept out 68-pounders of the most powerful charge and weight of wrought iron shot. He (Mr. Russell) believed it would still do in practical warfare. The iron in the side of the *Warrior* was equivalent to 7in., and practically in a naval engagement that would be found impenetrable. Again, how much did they value speed? To put it in guns, he could give them 11 knots and 50 guns, or 15 knots and 30 guns. Whether would they have a frigate that could sail round and round her enemy, and so choose her time, place, and weather, and either accept or refuse action; or change places, and take the slow coach? He would be probably asked if he could give 15 knots, why not 30 guns also. The answer was—money. But to that it would be said that in war efficiency was money; that a defeat was too dear at any price, and a victory cheap at the cost of certainty. That was probably a wise rejoinder, and he would take it so—that the odds were with the fast vessel; that 15 knots were worth their cost; and that the slow ship was dear at any price. But there was another point. They wished their ship, perhaps, to be ready to go anywhere, and to do anything. If by that they meant that she was to be able to keep the sea, and do long voyages, not as a sailing ship, but a fast steamer—to go in search of a flying enemy, and not return until she gave a good account of him—they made a further demand, which was again only to be met by a sacrifice. Such a ship must reach the Cape of Good Hope by steam alone, and must coal for 5000 miles. Mr. Russell continued to treat each of these topics in great detail. He described at considerable length his views as to the mode of distribution of materials in any ship they might build, so as to combine with the property of resisting shot and shell the general properties of strength, durability, and safety. He noticed the points of difference in the ways and degrees in which iron might be used for stopping shot and for deflecting shot, and he raised several questions as to the best mode of using the smaller classes of ships. He trusted that one of the advantages of the discussion would be to show that the *Warrior* class of ship was, in all respects and qualities, a worthy inauguration of the new fleet. He hoped it would confirm the conviction in the minds of those most able to judge that not a moment should be lost in completing a fleet of such ships, and in adding in each new vessel such improvements as familiarity and study might suggest.

Mr. Charles Lungle, shipbuilder, of Deptford, in a paper, advocated the coating of iron ships up to the water line with thick iron, and the placing of a shot-proof deck across at that height. This arrangement would protect the lower parts of the ship. Then, at any suitable height he would place a shot-

proof battery, and connect it with the lower part of the ship by means of shot-proof trunks. A ship so constructed would be impregnable below the water and on the fighting deck, and consequently, Mr. Lungley argued, as well protected as any ship need be.

Admiral G. Elliot, being called upon by the President, offered several observations, and Captain Cowper Phipps Coles, R.N., described his proposed form of shot-proof ship, with guns placed beneath revolving shields.

The meeting then adjourned.

On the resumption of the discussion, at seven o'clock, on Iron-cased Ships of War, the Rev. J. Woolley, LL.D., Vice-President, took the Chair, in the absence of the President, Sir John Pakington.

Captain E. P. Halsted, R.N., opened the debate for the purpose of combating some of the statements which had been made by Mr. Samuda. That gentleman, he considered, was in error in respect to certain facts connected with the trials upon the *Trusty*, with the effect of the shot. He presumed Mr. Samuda had not had the opportunity of seeing the experiments himself. The gallant officer entered into an enormous variety of details connected with the results of these experiments, and contended that nothing could be more illustrative of the value of the backing of timber in assisting the plate to perform its office of protection. The next point he noticed was the plated iron when subjected to the fire of the rifles at 100 yards; and here Mr. Samuda relied on the fact of the oak covering being sufficient to protect the plate from the effect of the shot. Mr. Samuda left the argument by maintaining that they had still left 6in. plating, which would resist any shot. Experience, they knew, was wanting to establish this fact—experience only could be their safe guide. To say, "I will join these plates together," would be a proposition at this moment which would be extraordinary, without any satisfactory basis to govern them; but that would be an experiment in which they had no right to expect success. At the same time, he quite agreed in the abstract question—that it was desirable to do away with wood. As to the curling of the plating being a circumstance which was common, he had known different cases when the armour-plate was struck in no less than three different firings from the *Trusty*, and in no instance had the plate curled, properly so speaking. The plates were bent in several cases, perhaps perceptibly so, when the shot struck a plate, and many of the bolts were started. This was considered to be the effect of the elastic rebound, and the elasticity of the timber beyond it. But after the trials were completed, there was a request made by the Ordnance Committee, under whose direction the experiments were made, to re-examine the question of the starting bolts; and the result of the inquiry, which was instituted as to the bolts being started, was, that it was found that not a single one had really started, except those in the immediate neighbourhood of where the shot had struck the bolt, or where the plate was fractured. The plates were driven back upon the shrunken timber. Now, he did not acknowledge the experiments which had been made at Portsmouth against vessels which had been built 54 years ago, and which were never intended to bear the weight of 4 or 5in. of iron-plating, especially when guns were brought to bear upon them of unprecedented calibre and power. He denounced these experiments as a deception. He considered that these experiments had produced that amount of perplexity which existed in the public mind, especially when there had been a contemporaneous system of secrecy observed upon the effects of real experiments made. He meant, however, to say that at the present moment he was not prepared to do away with wood; nevertheless, it was necessary to institute experiments; but, for God's sake, let them not be secret and exclusive experiments. Now, there was another thing about which he must speak to Mr. Samuda. He (Captain Halsted) had always considered the question of incorporating the armour-plating, and its necessary backing into the strength of the fabric, a most important question; and possibly he might have found the difficulty, if he had not done so. But Mr. Samuda had experienced this difficulty—he meant in his outside timber. There was nothing outside of the timber; and if they had anything to do with these armour-clad ships, they should make up her backing outside of her armour, because nothing could more conduce to their destruction than a contrary course. Next as to the red-hot shot, Mr. Samuda admitted it burned for 20 minutes, and he would venture to ask him under what circumstances he made that experiment? Did he apply the bellows? because it was seldom they had not breeze enough to blow up a flame in timbers. Again, timber in a vertical position, and in a horizontal position, would be more readily ignited according to its position. This was exemplified especially in the case of teak wood. Mr. Samuda did not know what the effect of a shell would be; but he could assure him that the effect would simply be to strip off his timber covering, and leave the iron side behind it exposed. The timber covering would form a most excellent shell-bed. Now, as to the Vice-President's (Mr. Scott Russell) paper, the great value of it was, that it enunciated some large *bonâ fide* propositions, which afforded everybody the opportunity of looking at what they were. He had challenged the naval officers to say what they did want; and he believed that challenge was a reasonable one, and it was not necessary for him to make any apology, if he took it up, and stated what they did want. He would take the question first of the height of the port-holes. This was an important point, which was more to be considered by naval architects than by naval officers. He had, not many years ago, commanded a full-powered srewer-fragate, that had been built by the late Mr. Finehan. She was taken to represent what was termed a second class frigate, of 36 guns; but, in respect to the height of her ports, the architect fell into an error. The gallant officer proceeded in the most technical manner to describe the effect of the ports not being sufficiently high, and to the impossibility of firing in a 36 gun frigate even her main-deck guns. The same fault attached to the *Gloire*, where the main-deck ports were too low. If, then, we continued to put our guns from the sides, the question of the height of the ports must be considered in relation to the size of the ships. Then, as to the distance apart of the ports, for all the purposes of firing, the distance should be as small as possible; but, for the facility of working the guns, it would be desirable to

adhere to the 15ft. distance between the centre of one port and the centre of the next; but, under any circumstances, the distances should never be less than 12ft., though it was better to have 15. In the trials made in the *Excellent* in 1850, on a section of the *Sinoom*, where the iron-plating was $\frac{3}{4}$ ths of an inch thick, it was penetrated with perfect ease by our shot, but there this was singular anomaly, that it broke the shot into smithereens! (A laugh.) Why should not the Council of this Institution, in due and proper form, appeal to the authorities that experiments of this nature should be made? If the Institution should take upon itself to do this, he, for one, would say, "Go ahead." But let it be done on one condition, that the experiments must not be exclusive and secret; if they were, they had better not be made at all. As to obviating the combination of wood with iron, he thought that this was a very desirable thing to do. In reference to the *Warrior*, he reminded the meeting that in the course of a little time her estimated speed of 14 knots would be reduced to 12 knots from the fouling of her bottom. In conclusion, he contended for the necessity of all ships of war, large or small, being constructed to secure speed, and ensure the capability of remaining at sea for a long period, without leaving their stations at short intervals to coal at distant depots.

Admiral Sir George Sartorius said he took a different view from that taken by the preceding speakers. When steam first became applicable to the navy, he thought from that time that the system of warfare might be altered, and that large vessels might be so constructed as to be able to sink a vessel at one blow. During the period of the Russian war he had frequent interviews with Mr. Scott Russell, as to the possibility of building ships which should be invulnerable; and he immediately said it could be done, but not with gun-boats. He proposed the matter to the Admiralty, and was permitted by Sir Charles Wood to make known his plan to the French Minister; and he believed the *Gloire* was built in a great measure according to the plan which he had sent into Mr. Scott Russell, with an iron protecting screw and rudder at each end. He had not to thank his brother officers for their courtesy at the Admiralty. Of the naval architects there, however, he was bound to speak gratefully and with respect. He found that that part of his invention which went to sink a vessel by concussion, was left out in building the *Warrior*. He felt that if these vessels could be adopted there would be an end to timber vessels. He sought to unite the power of concussion with the guns.

Captain Sherard Osborn, R.N., had hoped that some observations would have been made on the deflection of shot. He had gone five miles to hear Sir Howard Douglas's letter, and he would have gone 500 miles to do so if it had been necessary. That gallant officer had originally set his face against this armour-plating; but he now found that it was essentially necessary—the question being whether it should be applied on wooden or iron carcasses. He (Captain Osborn) was greatly inclined to the use of iron only.

Captain Scott, R.N., addressed the meeting on the effect produced by different shot upon iron, and drew a variety of diagrams on the board. He thought it was a mistake to put aside the ordinary round shot, especially for short distances.

After a few words from the Secretary, as to the objects and operations of the Institution, the meeting adjourned till 11 o'clock on Wednesday morning.

The discussion was renewed on Friday morning, the chair being taken by Mr. J. Inman Fincham, Master Shipwright of the Royal Victoria Dockyard, Deptford. Mr. Josiah Jones, of Liverpool; Captain Sullivan, R.N., C.B., of the Board of Trade; Mr. J. Grantham, Admiral Sir Edward Belcher, Captain Blakely, Mr. Charles Laneaster, and Captain Addeley Sleigh took part in it; and Mr. Samuda and Mr. Scott Russell replied upon the whole subject.

Friday, March 1, 1861.

The Rev. CANON MOSELEY, F.R.S., Vice-President I.N.A., in the Chair.

The first paper read at this meeting was upon "The Rolling of Ships," by W. Froude, Esq. This paper was substituted for another on the same subject, which was to have been furnished by the Rev. Dr. Woolley, but the reverend gentleman was prevented by indisposition from attending the meeting, and Mr. Froude's paper consequently took the place of it.

The following is a condensed account of Mr. Froude's remarks upon "THE ROLLING OF SHIPS":—

As the changing phases of a series of waves pass under a ship, her angle of inclination undergoes a series of derivative changes. The law of derivation depends on the magnitude and direction of the momentary effort which her resisting inclination, combined with that of the wave, compels her to exert; what is the law which governs that effort?

Now, in wave motion, the particles of which the body of the wave consists undergo a series of translating oscillations, vertical and horizontal, in their respective vertical planes. These translations make up the phenomenon; their changes express the accelerative forces employed in its continuance, and the momentary direction of surface which the particles thus affected assume, expresses the corresponding resultant of gravity and those forces, in the same manner in which the surface of stationary water expresses the direction of gravity alone.

Again, if a floating body be substituted for a relatively small aggregation of wave particles, it must itself accept all their dynamical relations, and hence to it the surface of the wave is virtually level.

Thus, if a spirit level be embedded in a flat board, floating in still water and adjusted accordingly, it will exhibit no disturbance while floating on the steepest part of the steepest wave.

Or if a small cork ring, like a lifebuoy, be fitted with an oblique mast, carrying a plumb-bob, and so placed that in still water the bob will centre the ring, it will remain there, however steep the waves that are made to pass under it; indeed it has been seen to do so on the overhanging surface of a breaking wave, so that the bob was above the point of suspension. The relations between angle and motion are in principle exactly those to which we must adhere if we would rapidly move about a flat board with a marble on its surface, so as to keep the marble undisturbed. The direction then of the total force experienced by a body floating on

a wave is exactly as if gravity acted at right angles to the momentary surface of the wave when it floats; and a ship on a wave, with her mast at right angles to its surface, is in momentary equilibrium: while if her mast deviate from this position by any given angle, she will, in virtue of her moment of stability, exert the same effort to eliminate the angle as if she floated with the same angle of inclination on stationary water.

The rate at which the angle will change on still water depends, in a given ship, on her moment of stability at the angle, and on her moment of inertia; including in the latter the equivalent effect of those contiguous masses of water whose motion is involved in hers.

The same conditions govern the direction and rapidity of the change of inclination which the same ship will experience on a wave where there is the same angle between her mast and the normal to the wave.

When the ship oscillates in still water, these conditions furnish a differential equation, the solution of which gives the period of her natural roll, *i.e.*, the period in which she will continue to perform each successive oscillation when artificially put in motion, and it may be observed that practically these oscillations conform to the laws of isochronism.

When the ship oscillates in waves, the same conditions, combined with those belonging to the equation of the wave, furnish a differential equation, the solution of which gives the phases of her motion on the waves.

Taking Mr. Scott Russell's wave curve (the curve of versed sines) as an approximation sufficient for our purpose, and solving the differential equation thus arising, we obtain an expression for the ship's motion, the constants of which naturally resolve themselves into the relation between the period of the ship's natural roll in still water, and the uniformly recurring period of the assumed waves.

The solution is based on the assumption that, commencing with the ship at rest in still water, and having a period of natural roll = T (for the period of the double roll, say starboard to port and back), a series of such waves approach, and pass under her with uniform velocity, having a length = L from crest to crest, a period = T' due to L , and a height = H from hollow to crest, then, after a given time = t , we have the ship's inclination expressed as follows:—

$$\theta = \pi \frac{H}{L} \frac{1}{1 - \frac{T'}{T}} \left\{ \sin \frac{\pi t}{T'} - \frac{T}{T'} \sin \pi \frac{t}{T} \right\}$$

or when $\frac{T'}{T} = 1$ the equation answers the second form,

$$\theta = \frac{1}{2} \pi \frac{H}{L} \left\{ \sin \frac{\pi t}{T} - \frac{\pi t}{T} \cos \frac{\pi t}{T} \right\},$$

where it may be noted that $\pi \frac{H}{L}$ is the tangent of the angle of steepest part of the wave.

If these equations are analysed in the case when $\frac{T'}{T}$ is greater or less than 1, we find that in every case the ship will complete a cycle of oscillations, arriving at a maximum, and dying out to nothing. As $\frac{T'}{T}$ is taken nearer to = (1) the cycles become longer, and the maximum of angle greater; but on the whole, the cases where $\frac{T'}{T}$ is greater than 1, the cycles are longer and the maximum smaller.

If for distinctness we speak of the weather side and the lee side of the waves respectively (though the subject is considered independently of wind), and examine the case where $\frac{T'}{T} = 1$, it follows that, throughout the lee lurch takes place on the lee side of the wave, the angle being at its maximum when the crest of the wave is reached: the weather roll will occur on the weather side of the wave, and its angle will be at its maximum at the lowest part of the hollow, so that the continual recurrence of identical impulses produces a definite increase of maximum at each wave transit, and after the transit of four or five such waves, an angle of 90° will be attained; while with $\frac{T'}{T}$ greater or less than 1, the coincidence of impulse dies out *vernier* fashion, and the oscillation ceases in order to commence *de novo*, when a half wave interval has been gained or lost.

The errors due to the imperfect assumption involved in the investigation for the most part tend to eliminate each other. But there remains a permanent demand for correction in reference to the resistance which the keel and figure of the ship generally offer to free oscillation, of which no account has been taken.

Poisson, however, and others have shown that when a pendulum experiences a resistance proportioned to the square of its velocity, not its period, but simply the length of each successive excursion is altered, and it follows from this that, though the maximum angles indicated by the equation will in fact be largely reduced in practice, yet the general character of the cycles which it indicates may be relied on as a fair representation of the truth.

The results have been verified by observations on the performances of the *Duke of Wellington* and the *Great Eastern*, both of which ships, having long periods of roll, $T = 13.2'$, and $T = 11.5$ to $12'$, respectively refused to roll in the quickly recurring waves of narrow seas, but rolled considerably when engaged with the long period wave of an Atlantic gale. They have been verified experimentally in the action of artificially generated waves on floating bodies, the periods of each being adjustable. In every case the result indicated by the equation followed. The value of $\frac{T'}{T}$ governed the result, however dissimilar

the shape of the bodies experimented on. In every case when $\frac{T'}{T} = 1$, five or six successive waves produced a complete upset.

On the whole, the slower the natural period of a ship can be made, the less likely will she be to encounter waves of equal period—the less likely to attain large oscillations.

Excess of stability under canvas, more than any other cause, tends to give a quick period, hence the violent rolls of Symondite ships; hence the saying, that a crank ship is an easy ship. Were a ship altogether without stability no possible wave could disturb her inclination.

Armour-plated ships possess naturally all the conditions tending to produce a slow period, large amount of inertia, and, unless by special arrangements, limited stability. The effect of their armour will be not to increase, but to lessen oscillation.

The second paper read was "ON A METHOD OF CALCULATING THE HYDROSTATIC STABILITY OF SHIPS," and was from the pen of Samuel Read, Esq., M. Council, I.N.A., late master-shipwright of Sheerness Dockyard, and Member of the Chatham "Committee of Construction," established some years since by the Admiralty, over which Lord Haddington presided. This paper was read in a short form by Mr. E. J. Reed, the Secretary to the Institution, who explained the several mathematical steps comprised in it, and wrote down the formulae obtained. The moment of the area of the section of the immersed wedge of the ship in an inclined position about "the point S," was obtained in terms of the two sides (y_1 and y_3), an intermediate line (y_2), and the angle between the two sides (θ). When the angle was small, the expression obtained became,

$$\left\{ (y_3 + y_2)y_3 + (y_2 + y_1)y_1 \right\} \frac{y_2 \sin \frac{\theta}{2}}{6}.$$

This expression manifestly involves only the radial ordinates y_1, y_2, y_3 , and the angle θ .

When tables of squares are to be referred to, and the angle θ is still small (not greater than 8 degrees) the expression becomes,

$$\left\{ y_3^2 + y_1^2 + (y_3 + y_1)y_2 \right\} \frac{y_2 \sin \frac{\theta}{2}}{6}.$$

The author's paper went on to explain how the aggregate horizontal transverse moments of the volumes immersed and emerged (or, technically, the "Ins" and "Outs") were obtained; and to exhibit how this method was carried into effect by the Committee of Reference, and by the author himself at Portsmouth.

The second part of this paper proceeded with the development of this theorem in a logarithmic form, as used in calculating the stability of several large ships designed at Chatham by the Committee of Reference. In this case the angle of inclination (θ) was divided into four equal parts by radial ordinates (y_2, y_3, y_4, y_5 , and y_3 , being the bounding ordinates), and the area of the section into four portions (A_1, A_2, A_3, A_4). The horizontal moment of the whole area was,

$$\frac{1}{3} \left\{ A_1 y_1 \cos \theta + (A_1 + A_2)y_2 \cos \frac{3}{4} \theta + (A_2 + A_3)y_3 \cos \frac{\theta}{2} + (A_3 + A_4)y_4 \cos \frac{\theta}{4} + A_4 y_5 \right\}.$$

This expression was made general by putting n instead of 4 for the number of triangles. The paper concluded with a practical illustration of the use of this method of calculation.

The third paper read was "ON A NEW METHOD OF CALCULATING THE STABILITY OF SHIPS," by F. K. Barnes, Esq., M.I.N.A., of the Constructive Branch of the Controller of the Navy's Department. This method is intended to replace all previous methods of calculating both the statical and the dynamical stability of ships, as it affords a ready means of making such calculations with unexampled brevity, and with complete accuracy. It has also the advantage of enabling indifferent mathematicians to make the calculations. The principle consists in dividing the wedge, which is immersed at a given angle of inclination, into an indefinite number of very small wedges, by means of radial ordinates and vertical planes. Various beautiful mathematical artifices are then introduced in obtaining the volume and moment of the whole wedge from these small wedges, the chief artifice being the taking of a *line* to represent the *angle* of inclination, and treating this line as a base upon which a curvilinear area representing the whole wedge is constructed. The author, in fact, reduces the whole of the calculations for finding the statical and dynamical stabilities of a ship to the process of finding several sets of curvilinear areas—a process which is well understood by almost all persons engaged in the construction of ships.

So great a reduction of labour is effected by the author's method of calculation, that all the calculations for both the statical and dynamical stability of a ship may be placed, in ordinary handwriting, upon the four sides of a single sheet of foolscap.

INSTITUTION OF ENGINEERS IN SCOTLAND.

Wednesday, 23rd January, 1861—the PRESIDENT in the Chair.

ON RAILWAY CURVES. (Illustrated by Plate 190.)

The adjourned discussion on Railway Curves was commenced by Professor Rankine, who communicated the following additional particulars from Mr. William Gravatt, C.E., F.R.S., respecting the application of the *Curve of Sines*:—

As from the construction of the curve, $y = p \sin x$, and $d x : d y = 1 : p \cos x$,
 $\therefore d^2 y = -p \sin x \, d x^2$; whence, radius of curvature, $r = \frac{(1 + p^2 \cos^2 x)^{\frac{3}{2}}}{p \sin x}$,
 $= \frac{(1 + p^2 \cos^2 x)^{\frac{3}{2}}}{y}$. When $x = 0$, $r = \infty$, and when $x = \frac{1}{2} \pi$, $r = \frac{1}{p}$.

In the diagram, fig. 5, Plate 190, let B A, C A be two tangents, and let D be

some point fixed by circumstances. Let the angle, α , and the distance, $A D = a$, be determined from the actual survey; and let $A E = h$. Then when $x = 0$,

$$\cos. x = 1, \therefore d x_0 : d y_0 = 1 : p = b : h, \therefore p = \tan. \beta \left(\beta = 90^\circ - \frac{1}{2} \alpha \right),$$

$$\text{or } p = \cotan. \frac{\alpha}{2}. \text{ Now, if } b \text{ be put} = \frac{1}{2} \pi, \text{ we have } a : h = \left(\frac{1}{2} \pi - 1 \right)$$

$$p : \frac{1}{2} \pi p, \therefore h = 2.75193 a, b = h \tan. \frac{1}{2} \alpha, c = h \sec. \frac{1}{2} \alpha. \text{ Call } b, \text{ for con-}$$

venience, 90 degrees, and also call $\Delta x, \frac{1}{2} \Delta x, \frac{1}{3} \Delta x, \dots, q \Delta x$, and take out the sines; then

$$\left\{ \sin. (x + \Delta x) - \sin. x \right\} p = \Delta y. \text{ Now, } \Delta y : \Delta x = \Delta y : \frac{\pi}{2q} \tan. \theta : 1;$$

or $\log. \tan. \theta = \log. \Delta y + \log. 2q - \log. \pi$. Enter the tables with $\log. \tan. \theta$, and take out θ , and $\log. \sec. \theta$. Then the $\log.$ of the chord of the curve in

chains = $\log. \sec. \theta + \log. \Delta x$; Δx being taken in chains, as being $\frac{b}{q}$ chains, or

$$\log. \Delta s = \log. b - \log. q.$$

Having divided the curve into as many or as few parts as convenient, and having a little table of the values of $\theta, \theta_1, \theta_2, \dots$, &c., and also of the corresponding chords, we may set up the theodolite at B, with the verniers arranged so as to take up the angle, θ_1 , and then run out the first chord. At the end of that chord again set up the theodolite to take in the angle, θ_2 , run out the second chord, and so on. As to the cant of the rails, we have the exact radius of curvature at as many points as we please, but it will generally be sufficient to make the cant vary directly as the ordinate, having previously determined it, for

any one speed we may fix upon, for the minimum radius, $r = \frac{a}{5708 p^2} =$

$$.5708 \frac{a}{(\sec.^2 \beta - 1)}. \text{ If the curve were an arc of a circle we should have } \sec.$$

$$\beta - 1 : 1 = a : r, \text{ or } r = \frac{a}{\sec. \beta - 1}, \text{ so that our curve is, at a minimum,}$$

sharper than a circular arc; but a bare circular arc certainly ought not to be used in any case, although it is every-day practice. But who knows how many accidents have arisen from that practice?

As for a reverse curve, there is evidently no more difficulty, or, at any rate, but little more difficulty, in setting it out than in setting out a curve without contrary flexure. You must in both cases have a *really good skeleton survey taken*, and laid down by the method of "latitude and departure," or by what is sometimes called the "back-angle" method. My theodolites are all on transit arms, with a hole completely through the main vertical axis, to which there is sometimes attached a small object glass, cross wires, and an eye-piece, for the purpose of setting the centre of the instrument accurately over any point. When not fitted up with a small vertical telescope, I use a soft, rather stout copper wire, sharpened to a point at the lower extremity, and bent into a serpentine figure: the instrument being set upon a steady *unwristable* stool, with a large opening through the top, and over that a kind of false top that may be slid about so as to set the point of the copper wire nicely over a centre-punch mark in a nail driven into a rather substantial oak-stake, which should be marked with a number or with a letter. Now, as the copper wire is soft, and turns altogether with the divided circle of the instrument, there is no difficulty in bending it a little this way or that, and so setting the theodolite over a given point with a degree of accuracy not to be approached by the ordinary plumb-bob method. The limb of the instrument is divided into degrees and sixths of a degree, or ten-minute spaces, and the verniers read minutes and tenths of minutes (not seconds)—($4\frac{1}{2}$ inches is sufficient for such reading). The liability of error in working with an instrument so divided is very much less than when divided in the ordinary manner. The divisions are, and always should be upon gold. It is false economy to divide upon silver. What I now send you is from what I invented, or think I invented, in 1828-29.

The Secretary then read the following remarks by Mr. Froude in reply to observations made at the former discussion of the subject:—

I must declare myself unable to perceive on what grounds it is said that the amount of cant should depend on the height of the centre of gravity of the engine or carriage.

So far as the cant is to supply a correction of the effect of centrifugal force on the train, it should be such that the plane of the rails will be at right angles to the direction of a plumb-line attached to any point on the train; and if we disregard the difference of curvature of the inner and outer rail, the direction of the plumb-line will be the same whatever be the level of the point of suspension, depending solely on the radius of the curve and the velocity of the train.

And if the length of the plumb-line be equal to the gauge of the railway, the cant ought to be equal to the distance by which the plumb-bob deviates from a true vertical line drawn through the point of suspension. The formula given in the paper is constructed on this principle.

Since, however, the velocity with which a given curve is traversed by different trains is not the same, it must be admitted that cant can furnish only an approximate remedy for centrifugal force; for the cant which suits an express train, travelling at fifty miles per hour, is four times as great as that which would suit a luggage train travelling the same curve at twenty-five miles per hour.

It should be observed, however, that centrifugal force is not the only force which tends to cause a pressure against the outer rail.

In the first place, the greater length of the outer rail, operating on wheels keyed to their axles, produces, or tends to produce, on the carriage an effect analogous to that of backing water on one side of a rowing boat, and pulling on the other. It is true that the conical figure of the wheels tends to furnish a rough correction of this operation; but any one who has watched the real motions of a running train must feel that the correction is necessarily very rough indeed, and that (in virtue of another cause to be presently mentioned) it operates even at the best very unequally on the leading and trailing wheels of each engine or carriage.

This second collateral cause of pressure on the outer rail exists in the direction of the planes of the several wheels of a given carriage, which cannot *all* of them lie tangentially to the direction of the rails, unless the carriage be vertebrated, and bent so as to make all its axles radiate to the centre of the circle.

If we suppose that at any moment the flanges of the outer leading wheel and outer trailing wheel are both in contact with the rail, it is obvious that the planes of the wheels will have such directions respectively, with relation to the rail, that the flange of the leading wheel will continue to push outwards against the rail, while that of the trailing wheel will deviate inwards from the rail—each, in fact, trying to follow the direction of the *chord* which connects the points of the curve on which the wheels respectively rest. The trailing wheels will thus, in fact, deviate inwards from the outward rail, and will give a more biting angle of direction to the leading wheels. The tendency to this inward direction of the trailing wheels will not cease until their plane has become tangential to the curve; and if the curve be a sharp one, the amount of inward deviation will be such as to bring the flange of the opposite trailing wheel into contact with the inner rail, so as to reverse the corrective effect assumed to lie in the conical figure of the wheels, and thus neutralize the advantage derived from its more proper action on the leading wheels. The result on the whole is such, that if we watch the consecutive carriages of a train running on a sharp curve (say of ten or fifteen chains radius) we shall observe that (to use a rather nautical phraseology) each carriage in turn appears to be "luffing up" against the outer rail, while its trailing wheels are "dropping to leeward" against the inner rail. And I am inclined to think that, especially when the velocity of the train is small, the bite of the flanges of the leading wheels against the outer rail, due to this cause, is very considerable, and demands a not inconsiderable amount of cant.

I must, however, admit that I believe, not only that the corrective effect of cant is but at best approximate, but that the object to be guarded against by its use, is rather the waste of power due to friction than the danger that for want of it carriages or engines will mount the outer rail. At least, unless the curve be so sharp that the *cutting* edge of the flange is enabled to bite against the side of the rail with a clear, *shearing* action, it seems to me plain that the tendency to mount the outer rail derivable from the forces called into play (even at the very highest velocities ever attained by trains) is really insignificant; or, rather, I do not see how on any known principle the tendency can be shown to be of dangerous magnitude. Take, for example, the case of a curve of fifteen chains radius, and a velocity of forty miles per hour; in this case the centrifugal force is barely $\frac{1}{2}$ of the weight in motion at the centre of gravity of the carriage. And granting that the whole of this pressure would have to be resisted by the flange of the leading wheel (if the line were without cant) while the insistent weight on that wheel might happen not to exceed, say, $\frac{1}{2}$ of the whole weight of the carriage, it would follow that the lateral pressure on the flange would be only equal to the insistent weight on the wheel; while if the co-efficient be taken at $\frac{1}{10}$, which, under the circumstances, is an ample allowance, it would follow that the friction due to the lateral pressure could not, even in so extreme a case, enable the wheel to exert, in an attempt to rise, more than $\frac{1}{10}$ of the weight which actually presses it downwards.

But though it seems plain to me that it is not essential on the score of safety that the cant on any curve should be correctly proportioned to the centrifugal force, it does seem important on the score of safety that its proportion should not undergo irregular variations, such as must occur if either the cant or the curvature is changed, one irrespectively of the other.

For if the cant be incorrectly proportioned, assuming only the proportion to be uniform, it will only follow that the springs on one side or on the other of the carriage will experience a corresponding excess of compression; and so long as this is invariable, no harm will ensue.

If, however, the proportion undergoes rapid changes, the compression of the springs will be changed also, and will thus tend to set up an oscillation. (Indeed, it would be possible to assign such a series of changes in curvature with a uniform cant—by adapting their recurrence to the natural period of oscillation of a given carriage—as to develop oscillations of the most formidable magnitude). It is to correct this tendency that (as it seems to me) every change of curvature should receive, as near as may be, a corresponding change of cant; and in suggesting the arrangement described in the paper, I do not contend for the pursuit of unattainable niceties, but I have endeavoured to suggest an easy method of approaching with fair practical accuracy a result which is theoretically correct. For to point out how the cant and the curvature may be made to undergo properly corresponding variations, involves no greater pretence of refinement than to point out how the cant should be kept constant while the curvature is constant.

It should be observed that it is not only at reversals of curvature that a proper method of affecting this variation is required. There is as much cant to be eliminated in changing from a fifteen chain radius to a forty chain radius (both having their curvature in the same direction) as there is in a reversal of curvature where the radii are both forty chains; or again, as in dropping from a twenty chain radius to a tangent; and if the change is to be correctly affected, there must be in each case the same length of connecting curve and the same gradient of adjustment.

The careful diagram furnished by Mr. Bell (Plate 190), which shows very accurately an existing reversal of sharp curvature, traversed daily by trains at from thirty to forty miles per hour, independently of its value as a full record of an exist-

ing instructive fact, is interesting in relation to the method I have recommended. It proves, indeed, that an exact adherence to that method is not necessary; but it also shows how far in the practical handling of the curve the workmen in charge of the line have felt their way towards the method—deviating into it by mechanical instinct from the original type of two circles with “a bit of straight” between them. But while they have arrived at this result roughly, and by a painstaking use of the rule of thumb, I think it clear that a better result would have been attained, and with less trouble, had the method which is recommended in my paper been adopted at the outset.

The cant adopted, based on the practical rule of adjusting it until the flanges no longer mark the sides of the rails, will be found to accord closely with that given by the formulæ in the paper, while the general gradient of adjustment will be found to be just that which seemed to me, and I mentioned as about the steepest that could be safely ventured on.

The Secretary then read the following:—

Description of Diagram, showing a Reversal of Curvature on the South Devon Railway. By MR. WILLIAM BELL. (Illustrated by Plate 190.)

The curves in this case being of small radii, and with a somewhat small amount of separation between their prolongations, were considered to offer a good example of a sharp reversing point on the broad gauge, and one which has worked with safety for many years. The curve has been taken in the state in which it is kept by the men working on the line, and minutely surveyed—offsets or ordinates being taken every ten feet along a straight base line, and the cant of the rails also observed every ten feet, for some distance on each side of the reversing point.

The radii of curvature in chains, marked in figures on the plan, Plate 190, figs. 1 and 3, were derived by calculation from the second differences of the ordinates.

The end portions of the central line, A B—B C, on the plan, are circles, coinciding, as nearly as they could be drawn, with the actual curves up to the points, D E, of maximum cant. The part of the line between these points is a portion of a cubic parabola, drawn as explained in Mr. Froude’s paper. The centres of the small black circles being points in the actual curve, and these circles being drawn of one foot diameter, the eye can readily appreciate the amount of divergence between the actual curve and the cubic parabola.

The diagram (fig. 2 and 4) of the cant of the rails shows a very good approach to regularity, in what Mr. Froude has called the “gradient of adjustment.” By comparing the ordinates of this diagram with the radii of curvature marked on the plan, fig. 1, to which they ought to be inversely proportional, it will be found that although upon the whole length, the average cant is very nearly the same as on the other running portions of the line, yet there are considerable differences at particular points between the actual amounts of cant and the amounts determined from the curvatures; and these differences are more than can be accounted for by errors of observation. It would thus seem that, to some extent, deviation from the correct amount of cant may exist with impunity. At the same time there can be no question but that the amount of cant should be proportional to the amount of curvature, and *vice versa*; for it has been found that upon different curves, when the amount of cant is determined practically by giving to the outer rail such an elevation that both rails wear fairly and evenly and without getting rubbed sideways, the amount of cant is then (on the broad gauge) equal to the amount by which the curve is hollow upon a length of from 66 to 70 feet, thus corresponding to a train velocity of from 34 to 36 miles per hour.

Professor RANKINE remarked, with respect to the position of the centre of gravity of the carriages of a train above the rails, that it was perfectly correct to say that that had no influence upon the centrifugal force; but there were certain cases in which it should be considered in the adjustment of cant, which, however, did not often occur. The cases he referred to were where cylindrical (not conical) wheels were used. His father and he had used such wheels on a horse railway, and they found it necessary to give more cant than corresponded to the centrifugal force, because the wheels had no taper, and consequently no deviation to counteract the necessity of making the outer wheels slide upon the rails. The plate layers gradually attained the requisite amount of cant by rule of thumb. On studying the results they thought that, besides balancing the centrifugal force, they had to do something more—they had to make the outer wheel to slide over a longer distance than the inner one. Now, in order to do that, it was necessary to make the resistance to the motion of the carriage less at the outer than the inner rail; and additional cant did that, by throwing the centre of gravity inwards. They had found a formula for this portion of the cant. He had published the formula, with the experiments made at the time. This was a case in which the elevation of the centre of gravity was a main thing to be considered; but when they used coned or tapered wheels, it was unnecessary to attend to it in that way. They found the friction generally of cylindrical wheels much less than that of tapered wheels, which he ascribed to their running upon straight lines without oscillation. The friction, which was constant at all speeds up to 12 miles an hour, was only $4\frac{1}{2}$ lbs. per ton, or 1-500th of the weight. Now, the lowest friction with tapered wheels was 6lbs. per ton, or a third part more than that of cylindrical wheels. He thought that was principally owing to the absence of oscillation of cylindrical wheels on a straight line. There was another cause, also, to be found in the extreme smoothness of the axles, produced by end play. In answer to questions, Prof. Rankine said that in the case he had cited the higher the centre of gravity the less cant was required, as the carriage was thrown over to the inner side of the curve. He had made experiments to determine the additional resistance due to curvature, with cylindrical wheels, and he found that a curve of mile radius increased the resistance by 1-4 lb. per ton, and the increase was inversely as the radius of the curvature. There had been some experiments made in America with tapered wheels, and they gave a less amount of additional friction on curves.

Mr. Lawrie said he still disagreed with Mr. Froude as to the height of the centre of gravity having nothing to do with the cant of the rails. If a line were drawn from the centre of gravity to the outer rail, it would be seen that, as the elevation of the centre of gravity was varied, the angle of that line with the vertical became

changed. The angle was a important element in the determination of the cant. There were some curious considerations connected with the conical form of the wheels. It was a prevalent belief that it assisted the carriage round the curve. It could only do so on condition that the axles were nearer together on the inner side of the curve. By merely making them conical, the action was scarcely altered, unless the axles altered their angles. Another element in the determination of the cant of the rails had not been taken into account by the author of the paper. Everybody knew that the moment a train entered a curve the speed slackened until a balance was attained between the motive force and the increased frictional resistance; so that in point of fact the cant should vary, not only with the curvature, but with the difference of speed, if it be wished to come to accurate results.

The Secretary explained that the “angle” Mr. Froude referred to was different from that on which Mr. Lawrie considered the cant to depend: it was the inclination which a plumb-line assumed in consequence of the speed and degree of curvature, and which continued the same whether the plumb-line was suspended from a high or low centre of gravity, or from any other point of the carriage.

Mr. W. Johnstone remarked that conical wheels were now seldom used. If any taper at all was given to the wheels, it was extremely slight.

The President, in bringing the discussion to a close, remarked that if they had had more time they might have enlarged the discussion on the different subjects these papers had brought before them. They would, however, require to content themselves at present by tendering the thanks of the Institution to Mr. Froude, Mr. Gravatt, and Dr. Rankine, the authors of the papers; and to Mr. Bell for his interesting diagram and description.

ROYAL INSTITUTION OF GREAT BRITAIN.

Friday, February 22, 1861.

Sir RODERICK I. MURCHISON, D.C.L., F.R.S., Vice-President, in the Chair.
ON PLATINUM.

By PROFESSOR FARADAY, D.C.L., F.R.S.

The discourse was founded on the recent investigations of MM. Henri Ste. Claire Deville and H. Debray regarding the characters and conditions of the platinumiferous metals, and the new process of working the ore which they have established on their results. Wherever platinum occurs, it is usually, if not always accompanied by five other remarkable metals; namely, Ruthenium, Osmium, Iridium, Rhodium, and Palladium: and in addition, by other substances, as iron, copper, gold, silver, and sand. Being washed the heavy particles are left as the general ore of platinum; this metal constituting by far the largest part of the substances.

The six metals, when obtained apart and purified, form two groups of three each; each group having an equivalent number very different from that of the other group, as appears in this table:—

Equivalent Number, 95.5.	Equivalent Number, 53.
1. Osmium Spec. grav. 21.40	2. Ruthenium ... Spec. grav. 11.3
3. Iridium..... „ 21.15	4. Rhodium „ 12.1
5. Platinum „ 21.15	6. Palladium „ 11.8

The three in the first group have the same equivalent number, and nearly the same specific gravity; but osmium takes the place of platinum as the heaviest of bodies. The equivalent number of the second group is alike for all, but it is little more than half that of the former group. The specific gravity also of the group is little more than half that of the former group: from which it results that an equivalent of any of these will have very nearly the same volume as an equivalent of any one of the heavier group.

There are certain analogies between 1 and 2; 3 and 4; 5 and 6; platinum is more like palladium than like the other metals. These numbers also represent the order of fusibility. Osmium has not as yet been fused; the rest have, in the order given. Platinum appears among them as a comparatively easily fusible metal. They are all volatile at very high temperatures, even osmium disappearing whilst the mass remains solid.

The platinum has usually been obtained from these ores (after they have been well washed, sifted, and mechanically separated) by the action of nitro-muriatic acid; which, bringing the platinum into solution, supplies a fluid which, on the addition of muriate of ammonia, &c., throws down a precipitate of ammonio-chloride of platinum. This, washed, dried, and heated, gives spongy metallic platinum; which being then pressed, heated, and hammered, yields massive platinum; the aggregation of the particles taking place entirely by adhesion and welding. Instead of forming a solution by acids, Deville proposes to employ a heat fusion process; and instead of welding, to fuse the metal together at the last by intense heat obtained by the use of the oxy-hydrogen or the oxy-coal-gas blowpipe. The ore, properly prepared, is mixed with its weight of galena or native sulphuret of lead, and half its weight in metallic lead; it is then heated and well stirred together, the iron and some other metals are taken up by the sulphur of the galena, the platinum and other metals are taken possession of by the lead, and when the action is well effected, the access of

air is adjusted until the remaining part of the sulphuret is decomposed and only platinumiferous lead left at the bottom part of the crucible or furnace, with scoræ upon it. The former is separated, and then heated, exposed to air until much of the lead is oxidized; which, escaping as litharge, leaves at last an alloy of lead and platinum, containing not more than 10 or even 5 per cent. of lead. Such an alloy of platinum requires a very high temperature to fuse it, and this is therefore attained and applied in furnaces constructed of chalk-line, heated by the insertion of gas blow-pipes. The heat first melts the alloy, and being combined with oxygen in a little excess, the remaining lead is rapidly oxidized and dissipated in fumes, and then being raised and continued, any gold, copper, osmium, or other metals, except iridium and rhodium, are also converted into vapour and driven off. The platinum remaining is at last heated to a still higher degree, and is either cast into flat cakes or granulated; and this has been done with quantities weighing even as much as 40 lbs.

The resulting metal contains some iridium and some rhodium, being in fact an alloy of platinum; but it is an alloy which, being harder than platinum, and even less liable than it to the chemical action of acids and other chemical agents, is as useful as the pure substance in the ordinary applications of the metal. As iridium and rhodium have no employment at present better than that of alloying platinum, their quantity has been purposely increased until it has made as much as 25 per cent. of the mass.

A mixed process has been devised by MM. Deville and Debray, which gives a platinum purer than any heretofore obtained. It is then as soft and ductile as silver. But for this process, for general directions and minute particulars, and for most interesting matter about all the metals of the platinum group, the reader is referred to the LVI. and LXI. volumes of the *Annales de la Chimie*.

CIVIL AND MECHANICAL ENGINEERS' SOCIETY.

Mr. A. F. Yarrow read a paper on "THE FOUNDRY." The following is an abstract:—

The author commenced by saying his intention was to describe the present practice, the difficulties "moulders" have to encounter, and how they are overcome.

With regard to the material used for constructing moulds, sand is the most common, certainly the most perfect and convenient. An open binding, and at the same time refractory nature is essential. It is necessary that it should be open, in order to allow the free passage of gas and air from all the parts of the mould, as, when the heated metal is poured in, the air which exists between the particles of sand is immediately greatly expanded; also any moisture that may exist is converted into steam, the object being to allow the air and steam to pass outward through the sand, rather than to find exit through the molten metal, and, in all probability, settle on the uppermost side of the casting within $\frac{1}{16}$ th or $\frac{1}{8}$ th of an inch of the surface, and consequently be invisible. This is termed blowing; it even occurs sometimes to a dangerous extent, and the metal in a liquid state is forced up 20 or 30 feet high. The next property that the sand must possess, is that of being refractory; and we find that good moulding sand consists of from 93 to 96 parts of siliceous grains of sand, and from 3 to 6 parts of clay. Any base, such as oxide of iron, magnesia, lime, &c., by rendering the mass more fusible, is injurious; road drift and coke dust are added in various proportions, according to the character of the sand, in order to temper it, as it is termed—*i.e.*, to make it sufficiently open, and also to resist the heating properties of the metal. With regard to the binding nature of the sand, it is evident that, if it does not bind well, sharp corners and fine details cannot be preserved; also, it will be apt to scab—*i.e.*, part of the bottom of the mould will peel off owing to the sudden expansion caused by the heated metal, and settle on the top of the casting.

Loam is a material that is frequently used in foundries for making large and complicated castings; it consists (as the sand just described) of sand and clay, the only difference being that it contains a greater proportion of clay, and is consequently more binding and less open. Owing to this latter property, it is never used in a moist state, but always well dried; it is generally mixed in a mill with horse dung, hair, &c., in order that it should resist handling better, and also prevent its falling to pieces when dried, instead of only cracking a little, as it usually does. There is another description of sand used in the foundry, *viz.*, parting sand, which, as its name implies, is to prevent the union of the various joints; it is generally procured from such places as where it has been subject to the influence of the sea or rivers, by which means all the fine particles of clay, &c., which would give it adhesiveness, have been washed away. Previous to casting, the moulds, in well regulated factories, are covered with a thin layer of blacking or charcoal dust, which increases the refractory powers of the surface of the mould, and at the same time gives the castings a smooth appearance; as, if the sand be coarse, the metal will penetrate between the grains, and make it rough.

The author then proceeded to illustrate, by reference to diagrams, the manipulation of green sand, dry sand, and loam moulding; he also

referred to chilled castings, and then proceeded to describe the various kinds of iron used for different purposes, and illustrated by experiments the advantages gained by various modes of mixing, and proved that the strength of the mixture will be greater than the strength of the various descriptions taken separately. The experiments were tried on an iron casting of a U or shackle shape, 1in. in sectional area, and 6in. from the centre of the eyes to the neutral axis; the one extremity was attached to a fixed point, and to the other weights were gradually added? After having entered at some length into the results obtained, the author proceeded to describe the various kinds of furnaces for melting, and said that, although crucibles for small quantities, and the reverberatory furnaces for large castings, were generally admitted to produce the stronger iron, still the cost of working the cupola was much less, and consequently was coming into general use. Chalk or limestone is generally put into the furnaces, in order to form a fusible slag with the oxide of iron, and thus protect the metal from wasting by fresh oxidation. The author then noticed the various kinds of fans and the different effects produced by placing the blades in different positions with relation to the axis; also the effect that curved blades had in reducing the noise. He then drew particular attention to the great necessity of having them well balanced, and terminated his paper by referring to a fan acting on the principle of the screw propeller, and said he thought that, if two screws, driven in opposite directions, were used, a very simple and effective fan might be produced.

REVIEWS AND NOTICES OF NEW BOOKS.

Catechism of the Marine Steam Engine, for the Use of young Naval Officers and Others. By THOMAS MILLER, Capt. R.N., F.R.G.S., F.S.A., &c. London: Spon, Bucklersbury (price 2s. 6d.).

The author, who is in command of H.M. steamship *Clio*, at present in the Pacific, has produced a very useful little book, which will be found of service not only to young naval officers, but to "others," as they will find several things presented in a novel and more useful form than heretofore, and much that is more accurate than is generally to be found in more pretentious works, whilst the whole is very carefully and creditably got up. We have, therefore, great pleasure in recommending the work to all.

The Coal-fields of Great Britain, their History, Structure, and Duration, &c. By EDWARD HULL, B.A. London: Edward Stanford, Charing Cross, 1861.

From the great extent and thoroughly reliable character of the mass of information to which the author has had access, and the skill and ability which it is well-known he possesses in selecting the necessary materials for such a work, we should have been as much disappointed as we are now satisfied with the results of his recent labours;—had Mr. Hull not collected together a vast amount of most valuable information upon a subject of universal importance, commercially and economically; and which must commend the book to all.

Summary of the Law of Patents. By CHARLES WORDSWORTH, Esq., of the Inner Temple. London: Benning, Fleet-street. (Second Edition).

The second edition of Mr. Wordsworth's book brings down the state of our knowledge of the laws relating to Letters Patent for Invention to the end of 1857, since which time there have been but few and very trivial changes. Mr. Wordsworth's name is quite sufficient to justify the realisation of all the reasonable expectations of those who seek information upon the subjects treated of in the 140 pages.

Laxton's Price-Book for 1861. London: W. Kent and Co.

We observe numerous improvements in the present edition, which entitles the book to maintain the position it has for so many years occupied amongst architects, builders, and others. The present issue is the 41st edition.

A Course of Elementary Mathematics; affording Aid to Candidates for Admission into either of the Military Colleges, to Applicants for Appointments in the Indian Civil Service, &c. By JOHN RADFORD YOUNG, formerly Professor of Mathematics in Belfast College. London: Wm. H. Allen and Co., Leadenhall-street. 1861.

Whilst we have had this book in our possession only sufficiently long to enable us to glance hastily over its pages, we have succeeded in discovering a vast amount of mathematical information of the most useful kind, carefully selected, consistently applied; and between each division of the work there is a continuity and harmony of character which imparts to it great value as a complete handbook to the study of elementary mathematics.

There are many noticeable features to which we propose to devote special attention on some very early occasion. In the meantime, we cannot permit the present opportunity to pass without adding that we cannot too strongly recommend Mr. Young's book to the attention of our readers.

On Coal Gas; a Discourse delivered to some Directors and Managers of Gas Works. By the Rev. W. R. BOWDITCH, B.A., &c. London: John Van Voorst.

In THE ARTIZAN for December last was noticed the important improvements effected by the author in purifying coal gas; and in THE ARTIZAN for February 1st we described the process, and stated at length our views respecting the introduction of Mr. Bowditch's discovery into gas-works, as a part of the manufacturing process. The present work treats of the several impurities found in coal gas, and of the various processes adopted to free it therefrom.

Gas engineers should acquaint themselves with the process, and put it into practical use as soon as possible.

LIST OF NEW BOOKS, AND NEW EDITIONS OF BOOKS.

- BEKE (Charles T.)—The sources of the Nile; with the History of Nilotic Discovery. With 7 Maps. 8vo. 6s. (Madden.)
 DEXTER (Thomas Edward)—Animal and Vegetable Substances used in the Arts and Sciences. 2nd edit. revised. 12mo. cloth, 2s. (Groombridge.)
 DRAYSON (Captain)—Practical Military Surveying and Sketching, with the use of the Compass and Sextant, Theodolite, Mountain Barometer, &c. 12mo. pp. 180, cloth, 4s. 6d. (Chapman and Hall.)
 HOLLEY (Alexander L., B.P.)—American and European Railway Practice; comprising the Economical Generation of Steam, &c. Demy folio (New York), 77 plates, cloth, 63s. (Low.)
 RUSSELL (J. Scott)—The Fleet of the Future: Iron or Wood? Containing a Reply to some Conclusions of General Sir Howard Douglas in Favour of Wooden Walls. 8vo. pp. 60, sewed, 1s. 6d. (Longman.)
 TALBOT (C. R. M.)—Sir Isaac Newton's Enumeration of Lines of the Third Order, Generation of Curves by Shadows, Organic Description of Curves, and Construction of Equations by Curves. Translated from the Latin. With Notes and Examples. 8vo. with 14 folding plates, and 66 woodcut diagrams, cloth, 10s. 6d. (Bohn.)
 URE (Andrew)—The Cotton Manufacture of Great Britain, systematically investigated: with an introductory View of its Comparative State in Foreign Countries. New edit. revised and completed to the present time, by P. L. Simmonds. 2 vols, with 150 illustrations. Vol. 1, post 8vo. cloth, 5s. (Bohn's Scientific Library) (Bohn.)

CORRESPONDENCE.

We do not hold ourselves responsible for the opinions of our Correspondents.

STRENGTH OF BOILERS.

To the Editor of THE ARTIZAN.

SIR,—Many of your readers have, no doubt, appreciated very much the excellent paper by Mr. McFarlane Gray in the February number, and in particular the practical and convenient manner in which the formulæ are arranged.

Some points are, however, not quite clear to me; and as others may be in the same position, I think it might lead to good results, if Mr. McFarlane Gray would favour us with an answer in your columns.

I will not dispute the right of assuming 8 as the factor of safety for riveted joints instead of 6, which has hitherto been found to answer;—here every engineer or boiler maker may be guided by his own experience, and alter the formulæ to suit. I quite concur in using respectively $\frac{1}{8}$ and $\frac{1}{10}$ of the bursting strain for stays in fresh and in salt water; for stays are proportionally exposing a much larger surface to oxydation than the plates. In trying the formula, I found that diameter of stay must everywhere mean least diameter of stay (measured at the bottom of thread of the screwed ends), as the formulæ otherwise cannot be brought to come in.

I allude more especially to Mr. Gray's deductions from Mr. Fairbairn's experiments on the strength of flat-stayed surfaces. Here I beg to remark, first, that the experiments were only made with a distance of stays of 4 and 5 inches, and from this reason alone it would be unsafe to lay down conclusive rules for all distances of stays; and secondly, that the experiments do not show, neither that flat surfaces enclosed within four stays vary in strength inversely as the cube of the distance, nor do they give us at all the breaking weight of plates per se.

To demonstrate this, we must examine the experiments. The first shows us that one stay, $\frac{1}{8}$ in. diameter, was drawn through the copper-plate at a pressure of $815 \times 25 = 20,375$ lbs.; the second, that one of the stays, $\frac{1}{10}$ in. diameter, failed by being drawn through the iron plate under a pressure of $1625 \times 16 = 26,000$ lbs.

Now, there is nothing strange in this, and nothing to show that the bursting strain of the plates has anything to do with the strain that will strip the thread of a stay. In neither experiment was the plate burst in the place where it bulged; the experiments stopped on account of the failing of the above-named stays, and we know very little more of the bursting pressure of a plate under such circumstances than we did before. The pressures that stripped the thread of $\frac{1}{8}$ and $\frac{1}{10}$ in. stays correspond with Mr. Fairbairn's experiments on the strength of screwed stays.

It seems, therefore, natural, until experiments show us that we are wrong, to consider the theory hitherto used (and corroborated by no mean authority, Professor Weisbach) correct, viz., to consider the square between four stays as a beam uniformly loaded and fixed at the ends.

The breaking weight for such a case would be $3 \times 4050 = 12,150$ lbs.,

or the load that would break a wrought iron bar lin. square, and 1ft. long between the fixed ends. But 4050 is a mean breaking weight, and Beardmore, for instance, calls the breaking weight of wrought iron 5333, which must apply to the very best iron, such as best Yorkshire plates, for instance.

Hence $(3 \times 5333 =) 16,000$ lbs., would be our breaking weight for length in feet, and $(16,000 \times 12 =)$, 192,000 lbs., for length in inches, and taking

- S = distance of stays in inches,
- T = thickness of plates in inches,
- P = working pressure in lbs. per square inch,
- F = factor of safety,
- B = bursting pressure,

we would have

$$T^2 = \frac{P S^2}{F}$$

hence

$$P = \frac{T^2 \times F}{S^2}$$

and

$$B = \frac{T^2 \times 192,000}{S^2}$$

hence the bursting pressure of a $\frac{3}{8}$ in. plate of best Yorkshire iron, stays 4in. apart, would be

$$B = \frac{9 \times 192,000}{64 \times 16} = \frac{9 \times 3000}{16} = 1687.5 \text{ lbs.}$$

for stays, 5in. apart, it would be

$$\frac{9 \times 3000}{25} = 1080 \text{ lbs.}$$

Now, as Mr. Fairbairn's first experiment stopped at 815 lbs. per square inch, and the second at 1625 lbs. per square inch, on account of the thread being stripped off the stays, there is no telling how much more the plates would have stood, had the stays been strong enough; and, at any rate, nothing to show, that the strength of the two plates to resist transverse strain, was not in the proportion of 4^2 to 5^2 , or of 1080 to 1687.

Comparing the above rule for the bursting pressure in pounds per square inch with the results of Mr. Fairbairn's experiments, applying a heavy pressure on plates through a blunt instrument,—we find that a plate half an inch thick, and 12in. square, firmly fixed all round, burst with a mean pressure of 37,730 lbs. If this case is to be considered as a beam loaded in the middle, and no notice taken of the possibly punching influence, such as a blunt instrument might have on a plate, it would be obvious that the same beam would bear double the weight if uniformly loaded, equal to $\frac{75,460}{144} = 524$ lbs. pressure per square inch.

My rule would give:—

$$B = \frac{\frac{1}{4} \times 192,000}{144} = 333.3 \text{ lbs. per square inch.}$$

Using Mr. Gray's formula for this case, we get:—

$$B = \frac{720 t^2}{S^3} = \frac{720 \times 256}{1728} = 106.7 \text{ lbs.}$$

Perhaps Mr. Gray now will perceive the necessity of leaving a theory (the strength of stayed surfaces is inversely as the cube of the distance of stays) which carries him so far from both actual experiments, and the mechanical law established (that the strength of stayed surfaces is inversely as the square of the distance of stays).

To convince Mr. Gray that his formulæ for stayed surfaces are not applicable for marine boilers, for instance, I will illustrate this assertion by an example. Taking a common tubular marine boiler with 20 lbs. pressure above the atmosphere, and 14in. from centre to centre of stays, we would, according to Mr. Gray's formula, get the thickness of plate

$$t = \sqrt{\frac{P S^3}{90}}$$

$$\text{hence } t = \sqrt{\frac{20 \times 2744}{90}} = \frac{24.67}{32}$$

or more than $\frac{3}{8}$ inch. Now, the thickness used in practice is $\frac{3}{8}$ inch, and as Mr. Gray's rule is said to give a factor of safety of 8, and as a $\frac{3}{8}$ inch plate is only quarter the strength of a $\frac{1}{2}$ inch one, we should consequently have numerous marine boilers in our navy using a working pressure of half the bursting pressure!

Instead of Mr. Gray's rule, I would offer the following for best Yorkshire plate:—

Reckoning 6 as the factor of safety—

$$T^2 = \frac{P S^2}{32,000} \text{ or } T = \frac{S}{178.8} \sqrt{P}$$

and taking 8 as the factor of safety, we would get—

$$T^2 = \frac{P S^2}{24,000} \text{ or } T = \frac{S}{155} \sqrt{P}$$

floating cable, I apprehend, is its strain by currents. Now, as the great tidal currents is in the lateral direction of the route, and the buoys could be shaped like a cigar, it would not suffer much; but in particular situations it would have to be stayed by side anchors. I think one buoy to the mile would be necessary. By leaving the cable very slack it would, on being strained by a current, drift till it assumed the customary curve, and be so much stronger to resist it. I would not have the cable thicker than the conductor and its vulcanised insulator, anything else giving expense and weight without efficiency. I would keep a track as far south as would clear the ordinary limit of icebergs, or, indeed, to lay it over the great bank of Newfoundland might make that unnecessary. I have thought fit not to protect the invention, believing such a step would only stand in the way of a national object like the present; so, if the Atlantic Telegraph Company chooses to adopt it, or some modification, they may do so; or if they do not, I am warranted in stating, a company will be embodied to prosecute the scheme.

I am, Sir, yours &c. JOHN CLARK.

To the Editor of THE ARTIZAN.

SIR,—I thank Messrs. Gray and Nystrom for their explicit answers to my former communication, and would observe, with respect to Mr. Gray's letter, that the exhaust lap was not omitted in my diagrams; but, owing to the minute scale employed, it only amounted to the thickness of the line. However, I should have been more satisfied if the reply and explanation had been given with a *great circle* instead of with a small circle diagram, this last (differing slightly) being used for some time previous to its publication in your pages.

The mystery is not quite cleared away respecting the air pump and foot valve formula. I have made several calculations, taking as data those derivable from indicator diagrams, but with no satisfaction, except discovering that the formulæ require the terminal pressure in cylinders to be considerably above atmospheric pressure, before corresponding with the practice in land engines.

Now, as engines driving mills and other works are subjected to varying loads, we must evidently so proportion the air pump and its valves to the greatest amount of duty ever likely to come upon them.

What terminal pressure must be assumed, due regard being had to I would have the shore ends for some sixty miles, and all shallow banks efficient condensation? and what value must we put upon the \sqrt{p} ? Will Mr. Nystrom be kind enough to state what value he puts upon them when designing engines?

The one for single-acting air pumps seems intended for plunger buckets, and not for such as contain valves opening upwards. Will it be correct to take the area given by formulæ as applying to these valves?

Another valve remains to be noticed. What formula applies to the discharge valve?—also, is it not a false improvement substituting india rubber ones, resting upon seats full of small holes or gratings, for the old-fashioned brass discharge valves. My calculations give about double pressure on the buckets with the improved valves as compared with the old ones.

Apologising for taking up your time and space with these simple matters,

I remain yours truly AMATEUR.

March 16, 1861.

GYRASCOPE GOVERNOR, CITY RAILWAYS, ETC.

To the Editor of THE ARTIZAN.

SIR,—During my sojourn on this side of the Atlantic, I have examined, amongst other supposed improvements in the line of inventions, the Gyrascope Governor, illustrated in the *Scientific American* of 22nd Sept. last, and subsequently noticed in the *Engineer*; and, from the remarks connected therewith concerning the same, one would have supposed that some new and useful mechanical principle had been developed in the operations of the laws of nature; it turns out, however, to be only a peculiarly arranged specimen of a centrifugal governor, and the attempt to describe the nature of a Gyrascope by the *Scientific American* could give no idea of the reality of this instrument. It consists mainly, and as far as its first regulating principle of action is concerned, of a disc or wheel, fixed loosely at its centre upon a driving spindle, which, when at rest, is held in a diagonal position thereto by the force of a spring, but, when rotated at sufficient speed, the wheel assumes by centrifugal force a right-angled position to the driving spindle, and then again returns to its resting place as the engine slacks its speed &c., and is, therefore, no new invention or contrivance, as wheels or discs have been used before in the same way. It is precisely the same, thus far in principle, as Silver's four ball Marine Governor would be with one arm removed, and the remaining one still connected with the spring; the latter, however, would have with the same weight of

metal and speed several times the centrifugal force, for the reason that all the means for producing centrifugal power is concentrated at those points which vibrate the greatest distance to and from the driving spindle, whilst all the parts of a wheel or disc that are at right angles to the spindle can perform no regulating service through centrifugal force, but is an unnecessary load driven, that can render no service but mischief to the driving gear in case of sudden variations of the speed of the engine; but neither a single disc or pair of balanced balls (as part of Silver's Governor) would form a perfect instrument for marine purposes when suspended on a spindle in a fixed position, in a tossing ship, for the reason that, whilst the position of the spindle would assume different planes with the rolling or other movement of the ship, the centrifugal rotation would have a tendency to continue in a fixed plan. Thus, at every turn of the governor in which the spindle changed its relative position to the orbit or plane in which the centrifugal weights were moving, the throttle valve would be drawn open and closed in like proportion, without reference to any change of speed of the engine. The so called Gyrascopic Governor, however, imperfectly overcomes this derangement by having a counter or horizontal rotation given to the instrument, which continually reverses the position of the driving spindle; the same difficulty being overcome in a perfect manner in Silver's Governor, by the two arms crossing each other, and the centrifugal force vibrating in opposite directions. This latter simple arrangement not only ensures perpetual correctness in case of disturbance of the position of the instrument, but at the same time doubles its centrifugal power. The Gyrascope Governor is a comparatively feeble instrument, considering the weight of metal in rotation, for the reason that the centrifugal vibrations are made from about an angle of forty-five degrees from the driving spindle to a rectangular position, whilst the most effective force in centrifugal governors is that obtained by making the angle of forty-five degree from the driving spindle the centre of the arc of vibration.

I saw in operation on the engines of the Cunard Screw Steamer, Australasian, in which I was a passenger, a plan of governor said to be adopted on all the screw steamers of the company, that differs entirely in principle from any of the centrifugal kind. It simply consists, as near as I could discover, of a small fly wheel, mounted upon a spindle which was allowed to turn freely in its centre to some extent; but both spindle and wheel were so connected by a spring that, when the spindle had motion communicated to it from the engine, the wheel is drawn after it by that elastic means until it assumed a regular velocity commensurate with the nominal speed of the engine; but when the engine had a tendency to run too rapidly, from the propeller losing its resistance, the spindle is driven simultaneously thereby in advance of the momentum wheel, and by a simple contrivance the increased speed of the spindle is resisted by the wheel, and gives a longitudinal motion to a socket or sliding sleeve, as used in ordinary governors, which also gives motion by proper connection to the throttle valve. The fly wheel has vanes attached to it, which, by resistance of the atmosphere, its speed was limited.

In the operation of this instrument, there was no waiting for centrifugal power to be exerted, but its action was prompt, and with force exactly commensurate with the start of the engine. The engine appeared to the common observer to run perfectly steady under its control, and when the sea was very rough, I saw instances of the steam gauge attached to the cylinders dropping the indications suddenly and momentarily from full pressure down to nothing, showing that the condenser at certain moments was quite sufficient to do the work.

Having been a frequent witness to the troubles incident to propeller engines in rough violent head seas, it was very interesting, I assure you, to see the ponderous machines of this large ship under such complete control and safety, adapting every pound of power to the best advantage in driving the vessel through thick and thin.

I believe this governor is also an English invention, as well as the four ball one above mentioned. I must confess our American cousins are entitled to the credit of many good inventions, but I think they must go to England for perfection in governors.

While claiming for my countrymen a great degree of superiority in all that relates to ocean steam navigation, I must, in a spirit of candour, grant the Americans their share of praise for many substantial comforts and conveniences that are unknown among us. For instance, their admirable system of river and ferry boats, as well as their city railways.

In Philadelphia, where they have been carried to greater perfection than in any other city I have visited, there are nineteen city railways with nearly 300 miles of road completed, and yet applications are now before the legislature for two or three more charters. The cars are set very low, handsomely painted and curtained, with seats running the whole length upon either side, and capable of seating about twenty to twenty-five persons. They are drawn by two horses, managed by a driver; a conductor on the rear of the car collects the fare, which for a single trip is 5c., or two-pence halfpenny.

They issue tickets for 7c. (three-pence halfpenny), which will take you upon any intersecting or connecting road to nearly any part of the city. The rails are generally of rolled iron, of about 5in. wide, with an uprise

on the outer side of about three-quarters of an inch, suited to the car wheels, and bevelled sufficiently to allow ordinary vehicles to turn on or off the track at pleasure. Those going in the same direction as the cars have the right of way over any vehicle coming in the opposite direction. I should like very much on my return to find these railways in general use in London, for surely we need them more than any city in the world; and when once introduced and made perfect by our engineering skill and good management, which is generally the case in England with all that relates to the public good, you can never overestimate their convenience.

Yours, &c.,

TRAVELLER.

New York, March, 1861.

NOTICES TO CORRESPONDENTS.

J. B.—The following is an illustrated description of the boilers of the U.S. Revenue Cutter, *Harriet Lane*, which we hope will satisfy your requirements:—

BOILERS OF THE "HARRIET LANE," U.S. REVENUE CUTTER.

These boilers are of a different type to what we generally find here in England, having tubes and return tubes of much larger dimensions than commonly used here.

The principal dimensions are the following:—

Grate surface in one boiler, 51.45 sq. ft.

Heating surface in one boiler, 1275.57 sq. ft.

Grate surface, $\frac{1}{24.78}$

First set of tubes in one boiler consist of eight tubes, 12½ in. diam. inside, 12ft. 6in. long, and two tubes 17½ in. diam. inside, 12ft. 6in. long.

Second set, or return tubes, in one boiler consist of five tubes, 17½ in. diam. inside, 18ft. 7in. long.

Calorimeter of first set of tubes, 10.15 sq. ft.

Calorimeter of return tubes, 8.35 sq. ft.

Diameter of chimney, 60in.

Consumption of fuel in 24 hours, 18 tons, or 16.3lbs. of coal per square feet of grate surface per hour.

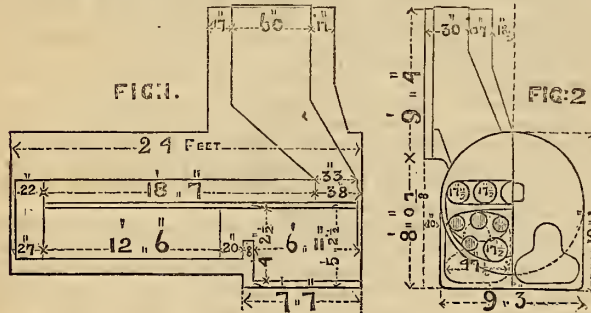

ENGINEER, R.N.—Write to Mr. Lloyd.

C. D.—The engines of the *Bea*, *Ant*, and *Cricket* were made by the late Mr. Joyce, of Greenwich. We will endeavour to find the dimensions and particulars concerning them, and will post them to your address.

HIGH AND LOW PRESSURE.—You are wrong. The numbers and dates of Woolf's patents are respectively, No. 2726, 1803; No. 2772, 1804; No. 2863, 1805; and No. 3346, 1810.

D. C. L.—Accept, for the purposes of calculation, Joule's equivalent of 772 foot-pounds.

G. E. B. (Birmingham).—Your suggestion will be acted upon.

D. R. (R.N.)—You will find in the present number a notice of a little book—just the thing for you—*Miller's Catechism of the Marine Steam Engine*, published by Spon, Bucklersbury, price 2s. 6d. Ask your bookseller at Devonport. Admiral Moorsom is the Chairman. Note down all that occurs.

ALPHA.—We will endeavour to obtain the book for you. Send your address and 2s. We cannot reply to the other questions.

CYCLOPS.—Either the Edinburgh University, or, if London is equally convenient, the London University will be better.

YANKEE ENGINEER.—You write more like a *Cockney engineer*. Our experience of Americans in the position you have assumed is, that they are more highly educated than men in the same grade in this country, more particularly your true *Cockney*. You had better undergo a course of training at sea as fourth engineer. You mistake the use of a salinometer.

ELECTRICUS.—Thanks. We have had at least seventeen or eighteen different plans submitted to us. Admiral Lord Dundonald tried the Trinidad pitch alone, and in conjunction with India-rubber, for insulating copper wire conductors for submarine telegraphic cables. Write to Sir Charles Bright, of the Magnetic Telegraph Company.

RECENT LEGAL DECISIONS
AFFECTING THE ARTS, MANUFACTURES, INVENTIONS, &c.

UNDER this heading we propose giving a succinct summary of such decisions and other proceedings of the Courts of Law, during the preceding month, as may have a distinct and practical bearing on the various departments treated of in our Journal: selecting those cases only which offer some point either of novelty, or of useful application to the manufacturer, the inventor, or the usually—in the intelligence of law matters, at least—less experienced artisan. With this object in view, we shall endeavour, as much as possible, to divest our remarks of all legal technicalities, and to present the substance of those decisions to our readers in a plain, familiar, and intelligible shape.

FREEMANTLE AND BLISS v. THE LONDON AND NORTH WESTERN RAILWAY COMPANY.—An action was brought by each of the plaintiffs, separately, against the defendants, for damages alleged to have been sustained by reason of an engine having emitted from its chimney-top, masses of coke or coal, by which the farm produce of the plaintiff, Bliss, and the whole of the farm buildings occupied by him, and belonging to Sir Robert Freemantle, were entirely consumed in the month of May last. The engine upon which the plaintiffs fixed as the cause of the accident, was a powerful goods engine of the most modern construction by Stodert, Slaughter, & Co., and, upon the occasion in question, it was stated the train consisted of 32 empty waggons, averaging 4 tons each, and was proceeding at the rate of 12 miles per hour up a gradient of 1 in 214½. The engine driver stated that he had, at the time of passing the farm, a thick fire composed of, in bulk, about one-half coal and one-half coke; that he was working in the second notch *in gear* expansively, or cutting off at about 11in. of the stroke, which is 24in. The engine was stated at the time to have been in perfect working order, having come out of the working shed to do duty for a less powerful branch-line engine, to which an accident had occurred. The engine in question (No. 62, southern division) was employed generally in working heavy coal trains on the main line from Rugby, and it was proved that she had a large piston area, to give her greater facility in starting with the load, and that the fire-box and smoke-box were of large capacity, and that the heating surface was also large [in proportion to the class of engine; in fact, that everything in her construction was favourable to her easy working; and the defendants contended that, with a considerably greater load, the engine in question could not, even with the most careless driver, under the circumstances in which it was proved she was at the time, have discharged from her blast pipe any pieces of incandescent fuel capable of igniting straw at the distance at which plaintiffs' stacks were from the side of the line. To prove the correctness of this view, a series of experiments were performed by a number of scientific gentlemen, for their own satisfaction, and it was proved by them that, with thirty-two waggons, at a speed of about 14 or 15 miles an hour, over the same ground, the force of the vacuum produced in the smoke-box—measured by instruments carefully constructed and properly placed—was not sufficient to disturb particles the size of a wheat corn, or to discharge them from the chimney top; and that they then increased the weight of the train by six additional heavy waggons, and, with a pressure of 150lbs. per square inch, and steam full on throughout the stroke, they ascended the same incline at from 22 to 25 miles an hour, and that during the whole series of experiments, the chimney, which was closely watched by the numerous scientific witnesses for the defendants, did not discharge a single piece of incandescent fuel; and it was agreed by all, that, with the heaviest load which the engine was capable of drawing, with full steam, that such an engine would not emit pieces larger than the size of a hazel nut, and that it was quite unnecessary to adopt in such an engine the addition of baffles, Venetian shutters, wire gauze, screens, or wire cages to the chimney top, or other contrivances which it was alleged by the plaintiffs' witnesses were very useful and well known contrivances, and should have been applied to such an engine. In support of this view, the plaintiffs produced drawings and models of what was considered by them so necessary an addition to every locomotive engine burning either coke or coal; but the opinions of the plaintiffs' scientific witnesses upon this part of the question were distinctly opposed by Messrs. Fairbairn, Nasmyth, Fothergill, and other professional gentlemen; by Messrs. Slaughter, Peacock, Crowe, and other locomotive engine builders; and by Fenton, Sturrock, Sinclair, Craven, and numerous other eminent locomotive superintendents; and although the opinions of these scientific and practical gentlemen were supported by experiments, most carefully conducted, with the engine in question—and the plaintiffs' witnesses were invited to make the experiments over again by themselves, the engine and train, together with the instruments and apparatus, being placed at their disposal for that purpose—which offer was not accepted by plaintiffs; and, notwithstanding this, and a number of other statements made by the servants of the company, which went to prove that the engine No. 62 did not set the plaintiffs' property on fire, and, moreover, that the plaintiffs did not attempt to prove that anyone saw the engine emit sparks at the time of the accident, the jury, which consisted of a number of country squires, chiefly from the immediate vicinity of the scene of the accident, returned a verdict for the plaintiffs in each action. The amount of the damages to be paid by the company to each of the plaintiffs had previously been agreed between the parties. The effect of this verdict, if it is permitted to stand, will be, that unless every engine is fitted with an American wire-cage or spark arrester, or some other contrivance specially applied for the purpose between the smoke box ends of the tubes and the chimney top, the owners of such engines will be liable to be mulcted in damages for any fire occurring by the side of a railway along which such engine may pass, and whether or not it is possible for the said engine to discharge cinders or emit sparks from the chimney top. This case occupied three days. It was tried by Mr. Justice Vaughan. Mr. O'Malley, Q.C., Mr. Power, Q.C., and Mr. Keane, were the counsel for the plaintiffs, and Mr. Bovill, Q.C. (specially retained), Mr. Mill, Q.C., and Mr. Stevenson were counsel for the defendants.

ST. THOMAS'S HOSPITAL v. THE CHARING-CROSS RAILWAY COMPANY.—This was a motion, on behalf of the Governors of St. Thomas's Hospital, for an injunction to restrain the above mentioned railway company from taking any part of the land occupied by the hospital for the purposes of their line, unless they consented to purchase the whole of the hospital. The company had given notice to the governors, that they required that portion of the property on which the north wing of the hospital rests. The governors felt that the most advisable plan would be to avail themselves of the privilege given by Act of Parliament to the owner of a message, part of which was required by a railway company, namely, that of compelling the railway company to take the whole of the building. The price which the governors demanded for the hospital was £750,000, being more than double the capital of the company. The Vice-Chancellor held that the governors were entitled to require the company to take all or none of the hospital property, and he granted an injunction to restrain the company from taking compulsorily any part of the hospital until the hearing of the cause.

NEVILLE v. WRIGHT.—This action was brought at the Newcastle Assizes, on the 1st ult., by Samuel Neville against Joseph Wright, for the infringement of plaintiff's patent for an invention to facilitate the annealing of glass. The defendant first pleaded not guilty of the infringement, and that the patent was void.—First, because it was not a true and first invention; and second, because the plaintiff was not the manufacturer. The process of annealing is the means of gradually cooling glass after it has been exposed to the greatest amount of heat necessary for its manufacture, and it is an object absolutely necessary that this process should be accomplished by very slow degrees, as, if rapidly cooled, the glass will be cracked, broken, or defaced. Previous to a particular

date there was a kind of trough in which were plates where the glass was placed, after having undergone the greatest amount of heat, and then they were gradually drawn by hand labour into a cooler medium, and ultimately brought to the lowest degree of temperature. The process was subject to great inconvenience, and, therefore, in the year 1854, a gentleman of the name of Webb invented a kind of table, which, by gradual circular motion, should prevent the necessity of removing the pans, and thus lessen the risk of accident. This machine occupied a great deal of space, and there were also other inconveniences, for which Mr. Neville endeavoured to find a remedy. He at length invented a machine in which a number of "ley" pans, or plates, or vessels for holding articles to be annealed, were made to revolve by an endless chain, receiving fresh charges when required, without being removed from the ley. Consequently, a deal of time and trouble were saved in the process of eooling. He obtained a patent on the 21st January, and in his specification said he did not confine himself to the precise method of raising the plates from the lower to the upper grooves, but he preferred the arrangement he had made. Mr. Wright saw this machine, expressed his admiration of it, and subsequently he took out a patent for a machine of his own, which only differed from plaintiff's invention in the method of raising the ley pans. This patent was taken in June, 1857, and in consequence of it the present action was taken. The question turned upon the practicability of the machinery invented by Mr. Neville, for the purpose to which it was intended to be applied; other points being reserved with leave to move in a higher court. For the defence it was submitted that the defendant's invention was an entirely different mode of obtaining an equivalent for continuity which did not compromise the mode in which the plaintiff specified and only claimed as his invention. It was pointed out to the jury that the question to be considered was, whether the invention of Mr. Neville was practicable, and whether it was new and useful.—The jury returned a verdict for the plaintiff.

THE WARDEN AND ASSISTANTS OF DOVER HARBOUR v. THE LONDON, CHATHAM, AND DOVER RAILWAY COMPANY.—This was an appeal, tried in the Court of Chancery before the Lords Justices, on the 22nd ult., against an injunction granted by Vice-Chancellor Stuart restraining the defendants from carrying their line of railway across Limekiln-street, Dover, otherwise than upon a level. The defendants had intended to lower the street about six or seven feet at the point of crossing, and to construct a bridge to enable the traffic of the street to pass over their line. The plaintiffs, who are the owners of four houses near the point of crossing, and also the owners of a considerable portion of the town of Dover, objected to the defendants' contemplated mode of crossing the street, because the approaches to the bridge would block up their four houses adjoining the point of crossing, and they contended that, inasmuch as the defendants' Act of Parliament provided that it should be lawful for the defendants to carry their line across the street upon a level therewith, the defendants were bound to cross it upon a level. The defendants, however, maintained that the words "it shall be lawful" gave them a discretionary power to cross the street either upon a level, or upon such a deviation from the line of the street as was permitted by the general Act relating to railways. They also urged that it would be dangerous to the inhabitants of Dover to carry the railway across the street upon a level. But the Vice-Chancellor granted an injunction restraining them from crossing the street otherwise than as directed by their Act of Parliament. The case was argued on appeal before their lordships a few days ago, when they suggested that the parties should refer to an arbitrator to decide whether the railway could be carried across the street in a manner that would be more convenient and less injurious to the property of the plaintiffs than that proposed by the defendants. It was supposed that the suggestion would have been acted upon, but the attempt to settle the matter in that amicable mode having failed, their lordships to-day proceeded to deliver judgment on the appeal. Lord Justice Knight Bruce said the words "it shall be lawful," in the seventh section of the company's Act of Parliament, considered as they must be, in conjunction with the other sections of the Act, were in his opinion merely permissive, and not mandatory. But the Attorney-General was not before the Court, and even if the words were mandatory, he thought the plaintiffs (who were aware several years ago of the defendants' intention to cross the street as now proposed) by lapse of time were disentitled to the interlocutory injunction granted by the Vice-Chancellor. The defendants had expressed their willingness to give an undertaking to pay to the plaintiffs any compensation which, under the direction of the Court, might be found due to them for the damage which their property would sustain by the construction of a bridge over the point at which the railway crossed Limekiln-street, and the order for an injunction would be discharged. Independently of all consideration of the serious mischief which would be occasioned to the inhabitants of Dover by the railway crossing the street on a level, he had come to the conclusion that the defendants were not bound by their Act to cross it upon a level. Lord Justice Turner concurred.

NOTES AND NOVELTIES.

OUR "NOTES AND NOVELTIES" DEPARTMENT.—A SUGGESTION TO OUR READERS.

We have received many letters from correspondents, both at home and abroad, thanking us for that portion of this Journal in which, under the title of "Notes and Novelties," we present our readers with an epitome of such of the "events of the month preceding" as may in some way affect their interests, so far as their interests are connected with any of the subjects upon which this Journal treats. This epitome, in its preparation, necessitates the expenditure of much time and labour; and as we desire to make it as perfect as possible, more especially with a view of benefiting those of our engineering brethren who reside abroad, we venture to make a suggestion to our subscribers, from which, if acted upon, we shall derive considerable assistance. It is to the effect that we shall be happy to receive local news of interest from all who have the leisure to collect and forward it to us. Those who cannot afford the time to do this would greatly assist our efforts by sending us local newspapers containing articles on, or notices of, any facts connected with Railways, Telegraphs, Harbours, Docks, Canals, Bridges, Military Engineering, Marine Engineering, Shipbuilding, Boilers, Furnaces, Smoke Prevention, Chemistry as applied to the Industrial Arts, Gas and Water Works, Mining, Metallurgy, &c. To save time, all communications for this department should be addressed "19, Salisbury-street, Adelphi, London, W.C." and be forwarded, as early in the month as possible, to the Editor.

MISCELLANEOUS.

PROPOSED BUILDING FOR THE EXHIBITION OF 1862.—The building which Messrs. Kolk and Lucas have undertaken to erect, from the designs of Capt. Fowke, R.E., for the proposed Exhibition of 1862, is of great extent, covering the whole area of land belonging to the Royal Commissioners between Cromwell-road, Brompton, and the land leased to the

Royal Horticultural Society, besides the space at the side of the Horticultural Society's garden in Prince Albert's-road, on which a more temporary building (an annex) for machinery, 870ft. long and 200ft. wide, will be built. The frontage of the Exhibition building in Cromwell-road is 1152ft., and here we shall have a brick structure 50ft. wide and about 70ft. in height from the ground, in two stories. The upper story, together with two additional galleries attached, will be lighted from the top, and be appropriated to pictures. Beyond this, running east and west, will be formed, 100ft. in height and 800ft. long, irrespective of the space under a vast dome at each end, over an octagon of about 130ft. The extreme height of the domes is 250ft. Intersecting these octagon spaces, at each end, will be transepts extending north and south. The whole extent of the building in this direction, irrespective of the annex, will be nearly 700ft. The nave will have a sham roof of wood, covered with felt, and will be lighted by a clerestory about 25ft. in height. The roof will rest on semi-circular girders, carried on iron columns against iron uprights, and these will also carry the galleries. Large and lofty arched entrances, and a series of semi-circular headed windows or recesses, are the principal features of the front next Cromwell-road. The estimated cost of the building is £300,000, but Messrs. Kolk and Lucas contract to supply it (use and waste) for £200,000, reserving the additional £100,000, if the gross profits exceed £500,000, or proportionally after £400,000.

BUCKINGHAM PALACE.—Considerable alterations and improvements are about being made, under the direction of Mr. Pennethorne, in the chapel at Buckingham Palace, heretofore an ugly, awkward building. The roof is to be raised, maintaining certain old levels and iron columns, and a lantern formed in the centre.

AN IMMENSE CASTING has lately been turned out from the foundry of Messrs. R. & G. Harris, Rotherham. The total weight of this casting is 3½ tons, and it is to form a bed for an immense tilt hammer. The metal was run from the cupolas in 4½ minutes, and 33 borses were required to drag this enormous mass of metal along the road.

THAMES TUNNEL.—The Chairman of the Thames Tunnel Company, at the meeting of 1860, informed the proprietors that the directors had entered into a provisional agreement for the sale of the tunnel to a railway company. At a recent meeting, he added that the amount promised by the promoters of the railway was large, but not sufficient to pay the Government. The promoters came before Parliament with their scheme, but experienced a very strong opposition, which made the promoters feel that they had no hope of getting the bill passed through. The company are now open to an agreement with other parties for the sale of the tunnel.

SOLID COPPER TUBES, now used to a considerable extent in America, are drawn from hollow cylindrical ingots, which are cast in iron moulds revolving some 2000 turns a minute. The centrifugal force imparted to the melted metal condenses it into a solid state. Pure copper does not cast even, when poured in the ordinary manner.

NOVEL WORKSHOP.—Messrs. R. Stebbenson and Co. are about to send out a workshop on wheels, destined for the Pasha of Egypt. The workshop embraces a lathe, a drilling-press, a saw-mill, a portable furnace with fan blast, a steam hammer, and a grindstone. The motive power is supplied to these by means of two double cylinder portable engines, of about 12 horse power each, which resemble in their general appearance and construction those attached to ploughing machines. The cylinders, however, which act in the same direction as in a locomotive, are placed on each side of the boilers, near the top, where they work two driving-wheels of about 3½ft. diameter. The engines, which are made to look in opposite directions, are attached to each other by means of a belt, that revolves from the driving-wheel on the right of one engine to the driving-wheel on the left-hand side of the other. The remaining driving-wheels, which are opposite to each other when placed in position, are directly attached to the machinery. The various machines and engines are mounted upon carriages with broad wheels, and will be dragged by horses. The steam hammer is on an improved principle, invented by the firm, and can, by an ingenious contrivance, be made to adjust itself to the axle of its carriage, on which it revolves, and from which it can be detached at pleasure.

WATER ELEVATOR.—Inventions in pumps have been numerous of late. One of Nelson's patent machines, capable of raising 80,000 gallons per hour, or 150 gallons each, is described by a Liverpool paper as having been exhibited there. The machine is said to be quite portable, and workable at a trifling cost, on a principle so simple, and requiring so little force, that a child might work it easily. It is kept in full play by merely drawing and withdrawing a valve at intervals of about six or seven seconds, the time requisite for the filling of the receiver. The general principle upon which the apparatus is constructed is that of the atmospheric pump, the vacuum in the receiver being produced by the ignition of common naphtha, or any other volatilised hydrocarbon fluid.

THE LIME LIGHT.—It is hardly necessary to observe that, in common with all other lights of great intensity, it may be used for signal lights, its peculiar steadiness and continuity giving it the advantage over its rival, the electric light. For use at sea, or by the coastguard in case of wreck, and in cases where life and property are at stake, cheapness is a matter of no consideration for a light of this nature; still, where cheapness is combined with utility, the lime light has precedence over all other lights, its cost being in pence where others cost pounds. Owing to the total absence of colour, it is not only applicable to photographic purposes, but also for picture galleries, shops, &c. It is found to separate the most delicate shades of colours, and, what is of more importance, it does not in the slightest degree injure the most delicate fabrics. A single jet of the medium size is equivalent to forty argand, or eighty fish-tail lights, or four hundred wax-candles; while its cost is from a halfpenny to fivepence an hour, according to the quantity of combined gases consumed, the augmentation of which increases the power of the light. For instance, twice the quantity of gas consumed per hour will give, not twice, but four times the amount of light. Comparing it with the illuminating power of common gas, a single jet, consuming four cubic feet of the combined gases per hour, equals that obtained from four hundred feet of coal gas.

MR. ABETHELL, the Master Shipwright of Portsmouth Dockyard, is appointed an assistant to the Controller of the Navy at the Admiralty. Mr. Moody, late assistant to Mr. Abethell at Portsmouth, has received an acting order as Master Shipwright of that dockyard.

We understand that Mr. Walter Hannah, formerly assistant-engineer for the Government at Malta, has been appointed Engineer-Surveyor under the Board of Trade, at Newcastle-on-Tyne, and Mr. M'Kinlay, formerly of Hull, has been appointed the Shipwright Surveyor for the Tyne district.

STEAM SHIPPING.

THE NAVY OF FRANCE IN 1860, including vessels afloat, building, or repairing, comprised the following number and classes of ships:—2 sailing liners of 120 guns, and 5 steamers of 120 guns each, 22 steamers carrying 100 gun each, 6 90-gun ships, and 21 90-gun steamers, 8 sailing vessels carrying 82 to 86 guns, and 1 86-gun screw, 3 90-gun steamers, 9 60-gun frigates, and 10 of the same class with steam power, 6 52-gun frigates, and 2 with steam power, 7 50-gun frigates and 12 screw 50-gun frigates, 12 sailing frigates carrying 40 to 46 guns, and 3 40-gun steam frigates, 20 steam frigates carrying 16 to 20 guns, 6 iron plated vessels of 30 to 40 guns with steam power, 24 corvettes, carrying in all 720 guns, 6 carrying 16 guns, 22 steam corvettes mounting in all 176 guns, 32 brigs and dispatch-boats from 2 to 13 guns, and 115 steam do. carrying in the aggregate 313 guns, 57 schooners cutters, and gunboats, mounting 150 guns and 20

steam do. with 72 guns, 12 steam sloops each mounting 1 gun, 6 floating batteries and bombs carrying 2 guns, and 5 steamers mounting 80 guns, 49 sailing transports and 28 steam transports unarmed, 10 disembarking steam transports of 100 horse power, each mounting 10 guns. The total includes 531 vessels (317 steamers), carrying 12,411 guns and of 100,060 horse power. From 1858 to 1861 the State has appropriated each year 45,000,000 francs (nearly £2,000,000 sterling) for the repair and maintenance of the existing naval force, and 15 to 16 million francs for new ships. The Navy of France is to attain its maximum in 1867, when it will include 15 steam ships of the line of the first class, and 25 of the second class. The number of steam ships of the line fit for sea at the present time is only 20, and of 11 sailing ships of the line 7 are building. The personnel of the French Navy includes 2 admirals, 22 vice-admirals, of whom 12 are afloat, 44 rear-admirals, of whom 25 are employed, captains of vessels of the line 103, captains of frigates 233, lieutenants 700, ensigns 550.

AUSTRIAN NAVY IN 1860.—1 screw liner of 800 horse power, and 91 guns, 3 screw frigates of 380 horse power, and carrying 36 guns, 2 screw corvettes of 24 guns and 260 horse power, 3 schooners carrying 4 guns, of 120 horse power, 12 steam gunboats, each 2 guns, 8 paddle steamers of 6 guns each, 1 steam-yacht of 80 horse power, and 2 guns, 3 unarmed paddle steamers; in all 33 steamers, carrying 333 guns. The sailing vessels of war consisted of 15, mounting 358 guns, one pontoon with 12 18-pounders, 1 plated floating battery, 12 gunboats carrying 2 36-pounders each, 8 do., each carrying 1 80-pounder and 10 or 12 transports. There is building, 1 91 screw liner, 1 50-gun screw frigate, of 600 horse power, 2 gunboats of 200 horse power, amounting to 49-pounders. The flotilla on the lagoons and lakes comprised 5 steamers, 1 gun-boat, and 1 pontoon. That on the Danube, 2 steamers of 100 and 160 horse power and 2 gunboats at Semlin. The seamen numbered 1990 and the marine artificers 1225. There is one admiral, and three rear-admirals in the service.

THE ROYAL NAVY OF SPAIN last year comprised the following vessels:—2 ships of the line of 84 guns, 4 frigates of 32 to 42 guns, 4 corvettes of 16 to 30 guns, 8 brigs of 10 to 18 guns, 13 schooners of 1 to 7 guns, 2 luggers carrying 1 gun each, 6 feluccas of 1 to 4 guns, and 10 transports carrying 5 guns each, making 49 sailing vessels. The Navy afloat also comprised the following steam vessels:—Paddlewheels, 3 of 16 guns and 500 horse power, 7 of 6 guns and 350 horse power, 1 of 2 guns and 230 horse power, 2 carrying 2 and 6 guns and of 200 horse power, 14 carrying from 1 to 5 guns and of from 100 to 180 horse power, 2 transports, each of 2 guns and of 480 and 500 horse power, in all 29 paddle steamers. The screw steamers were 59 in number, viz., 1 of 80 guns and 1000 horse power, 9 37 to 50-gun frigates of 300 to 600 horse power, 4 corvettes carrying 3 guns, of 120 to 130 horse power, 18 schooners of 2 to 4 guns and from 80 to 200 horse power, 9 transports carrying 2 guns of 20 to 300 horse power, and 18 gunboats of 20 to 30 horse power. There were also in course of erection the following steam vessels: 3 80-gun ships of 1000 horse power, 5 50-gun steam frigates of 300 to 600 horse power, 6 schooners of 200 horse power each, and 2 of 80 horse power, 18 gunboats from 80 to 100 horse power, each to carry 2 guns. There was also the following cruisers: 24 feluccas and 87 coast guard vessels armed according to their size, 24 vessels of the same class, and also stationed in the Philippines. The active list of the Spanish Navy comprises 1150 officers of all ranks, 184 paymasters, 85 engineers, 13,680 seamen, 8690 marines, and 539 arsenal guards.

AIR PROPULSION OF VESSELS.—An experiment of a very interesting character was tried on the 5th ult., in the docks of the Grand Surrey Canal, Rotherhithe. Mr. James Carter, a gentleman of an ingenious bent in the application of mechanics, has for some years been elaborating a scheme of propelling river craft of all sizes by atmospheric pressure. The principle of the mechanism is exceedingly simple. A discharge of air is effected beneath the vessel, acting downwards on the water and upwards on the sloping side of the boat, which is made flat for the better attainment of a due resistance. That which was done by Mr. Carter and his assistants was done with the very poorest means. A crazy harge, of the "fly-boat" shape and capacity, was fitted up with boiler, engine, and air-pump, got together in haste, and but ill adapted each to each. As for the engine, it was described as of "two cats' power;" and yet the force attained was sufficient to tow a heavily-laden lighter. There is no concussion, no friction of any kind in those parts immediately connected with the propulsion of the vessel.

NEW BOAT-LOWERING APPARATUS.—A further official trial of the system of instantaneously disconnecting boats from their falls, on being lowered from a ship's davits on any sudden emergency, took place on board the steam tender *Lucifer* at Portsmouth on the 5th ult. The trials took place outside the harbour, and the boat was lowered three times with the most perfect success, so far as the inventor of the system pretends to go—the instantaneous freeing of the falls from the boat at the moment required by the person in charge of her. To obtain this result, the boat is fitted with an iron shaft running along the boat's keelson, and connected with an eccentric under the sternsheets; the latter, worked by a small hand lever, throws the shafting forward or aft as may be required. On this shafting, in a line with the boat's falls, are stout claws or teeth, immediately in front of each of which are stout metal rollers. From the after part of each roller run three-inch square casings, level with the boats thwarts. The lower hook of each fall has its hook prolonged into a stout bar, sufficient to reach the shafting in the bottom of the boat, and terminating in a semi-circular link moving upon a stout iron pin. To hoist the boat up to the davits from alongside, the bars attached to each block are passed down the casings until the semi-circular links touch the bottom, when the lever, thrown forward by the hand of the man in charge of the boat, the claws of the shafting catch the links, and jamming each under its roller, it is locked by the eccentric in that position. A pin inserted abaft adds to its security. It will therefore be seen that to lower the boat, the falls having been cleared in the usual manner, and the crew having taken their seats, the lowering from the ship commences in the common way. The officer in charge of the boat, with his hand on the lever, has the power of freeing the boat from its falls at any moment he sees a fit opportunity, and releasing both ends of the boat at the same instant.

APPARATUS FOR PREVENTION OF SMOKE.—Her Majesty's paddle steamer *Vivid* returned on the 6th ult. from her second trip to the North on trial of Mr. D. K. Clark's patent apparatus for the prevention of smoke issuing from the chimney. This invention consists in introducing a supply of air into the furnace above the fuel by means of jets of steam. The operation of the jets during the trial is stated to have been attended with a falling off of indicated power to the extent of 62 horse power, being about 10 per cent. of the power worked up to by the *Vivid*, and a consequent reduction of speed from 13.17 to 12.95 knots, by a loss of nearly a quarter of a knot per hour. The consumption of fuel was scarcely affected, being in each case about the same. The plan of mitigating the nuisance of smoke, though very favourable, is stated to be still capable of improvement. The effect of the apparatus, it appears, occasions a noise in the engine-room to some objectionable extent, but which might probably be in a great measure remedied by the inventor. During the trial the boilers were stoked expressly to emit as much smoke as possible, for the purpose of experiments, and were worked singly under the influence of the jets of steam intended to reduce the nuisance. The comparison of the amount of smoke issuing from the chimneys was at all times greatly in favour of the apparatus, the boilers with the steam jet shut off producing a dense black cloud of smoke, while the one with the jets working gave but a small blue vapour. The above apparatus is to be retained on board the *Vivid* for further trials.

A NEW STEAMSHIP, possessing several novel features, has been projected by Mr. Thomas Silver, of Philadelphia. She is to be 600ft. long, 75ft. broad, and to draw only 16ft. of water. She is to have two paddle engines, that are to be located on the sides and

not in the centre, as is the case in all steamers, and each engine is to work its own independent shafts and wheel. She will also have two screw engines, each separate, and working a propeller under each quarter. The hull of this vessel is to be braced in the most thorough manner for strength; she is to be divided into fifty water-tight compartments, and to be for 15,000 tons burthen.

MULLEY'S AUXILIARY RUDDER.—Lately at the meeting of Naval Architects, a model of a vessel fitted with this rudder was placed on the table for exhibition. It is about half the superficial area of the main rudder, oblong shaped, and formed of separate bars of copper or iron, as the case may be, for wood or iron ships, in such manner as will allow it to twist (its action resembling that of the fin of a fish) in and out of the quarter where it is hung at an optional depth below the water-line, and when not in use, recessed so as to take the shape of the bottom, leaving no projection whatever. The auxiliary rudders are worked each by a common steering wheel placed on either side, near that of the main rudder, and are operated upon simultaneously with it under the same orders, having in case of sudden change of helm the advantage of being brought to act at once, while the main one has first to pass its neutral point. The apparatus consists merely of a vertical and a horizontal shaft, with a pair of wheels and pinions to move the segment shafts passing through the ship's side, and connected to the after end of the rudder. An indicator marks the angle of the rudder. It is intended to prevent the fatal consequences sometimes resulting from the damage or loss of the main rudder in a gale at sea, and when a temporary rudder cannot be conveniently substituted.

A NEW IRON WAR STEAMER.—The entire space between the first and second docks at Chatham Dockyard is now completely covered with the sheds, workshops, forges, and other buildings for the workmen who will be engaged in the construction of the large iron war steamer about to be commenced at that establishment. The whole of the buildings are of corrugated galvanised iron, and have been erected in a most substantial manner by Messrs. Grissell & Co., of the Regent's Canal Iron Works, in an exceedingly short space of time. The largest of the sheds is a commodious workshop, 320ft. in length, by about 50ft. in width at its largest end. This building has an exceedingly light appearance, the roof being formed of iron and glass. At the extreme end a large engine-house is being completed by Messrs. Ford and Sons, the contractors for this portion of the undertaking, who are also preparing the beds of concrete for the foundation of the punching, drilling, stamping, and other powerful machinery which is to be erected. The number of mechanics and labourers who will be employed exclusively on the new vessel will be upwards of 1000, and some idea may therefore be formed of the extensive workshops required to enable this large body of workmen to carry on their operations. Portion of the beams and other parts of the vessel continue to arrive at Chatham from Low Moor, Bowling, Butterly, and other iron works which have entered into contracts with the Admiralty for supplying them.

THE "BLACK PRINCE."—This vessel, which took the ground near Guwell Point, on the 10th ult., on her way down to Greenock, floated off the same day. She was towed into Victoria Harbour, Greenock. She has not sustained any injury. It is confidently expected that she will be equipped and ready for sea within four months.

THE NEW IRON MAIL-CLAD STEAMER about to be commenced at Chatham Dockyard is decided by the Lords of the Admiralty to be named the *Achilles*. The new vessel will be an improvement on those of the same description recently built, and her dimensions will be somewhat larger. Her engines will be nominally of 1250 horse power, but they will be capable of being worked up to considerably over 2000 horse power. She will be pierced for forty guns, all of which will be the long range Armstrong gun.

ADMIRALTY ORDERS AT CHATHAM.—Admiralty orders have lately been received at this dockyard for a squadron of five steam frigates and other vessels of war to be built at that establishment, in addition to the several line-of-battle and other screw steamers which are now in progress. The following are a few particulars of the new vessels. The *Badicea*, 50, 600 horse power; the *Factolus*, 22, 200 horse power; the *Diligence*, 17, 200 horse power; the *Selains*, 4, 250 horse power; and the *Albatross*, 4, 200 horse power. The above ships of war will be commenced immediately. The vessels now on the stocks, several of which are in a very forward state, are completed.

THE "LORD OF THE ISLES," an iron paddle steamer, was successfully launched on the 13th ult. from the yard of the Thames Ironworks and Shipbuilding Company, at Blackwall. The following are her exact dimensions:—Length between perpendiculars, 130ft.; breadth extreme, 18ft.; depth, 7ft. 6in.; burthen, 205 tons, builders' measurement. Her engines, 60 horse power nominal, are constructed by Mr. John Stewart, of Blackwall, and Mr. James Ash is the designer of the vessel. The *Lord of the Isles* has been built for the Southampton, Isle of Wight, and Portsmouth Improved Steamboat Company, and is the first vessel of a new fleet intended to run between Cowes and Southampton, Hyde and Portsmouth; one more will be on the station in the course of the present season, and the number is intended to be increased ultimately to four. The *Lord of the Isles* is expected to commence running in the latter part of April next.

THE "QUEEN VICTORIA" steamship, which run aground at Plymouth some months since, while en route for Rangoon with telegraphic cables, was floated off from Crenybe Beach, on the 13th ult., and taken into the Great Western Docks.

THE AUSTRIAN LLOYDS, by a return made some time since, owned 63 steam-vessels, of 89,175 tons and 13,260 horse power.

SCREW STEAM TROOP SHIP "HIMALAYA."—The authorities at Plymouth have determined to have new cylinders put on board this vessel.

THE "WARRIOR'S" engines are the largest marine engines ever made, being of 1250 nominal horse power, and able to work up to about 6000 horses indicated. These engines took six weeks to remove from the factory in Greenwich, and erect on board this first of the ironclads.

THE TRIAL of the new screw steam sloop *Rosario*, at the Lower Hope, has been reported as highly satisfactory. The engines supplied by Scott & Co., of Greenock, performed 96 revolutions per minute, her draught of water being 10ft. 4in. forward, and 12ft. 5in. aft, working up to 630 horse power, being nominally 150 only. She attained a speed of 10½ knots per hour.

H.M. SCREW STEAMSHIP "GIBRALTAH," 101 guns, the trial of the machinery of which outside Plymouth Breakwater has been several times postponed, was built at Devonport from the lines of Sir Baldwin Walker, and launched on August, 1860. She is 252ft. long, 58ft. 6in. broad, has a depth of hold of 25ft. 6in., and measures 3715 tons. Her engines by Messrs. Maudslay and Field, are a pair of 400 nominal horse power, or 800 nominal horse power collectively. They have been worked up to 3442 indicated horse power in Keyham Basin. The engines, double piston direct horizontal, are with the boilers placed between the foremast and mainmast. They are generally similar to those fitted about eight months back on board the *Revenge*, 91. Instead, however, as in the *Revenge*, of the steam being conveyed from the boilers to the engine-room in one large pipe connected on both sides by junctions with the boilers, in the *Gibraltar* there are two pipes close to the boiler, by which arrangement a great saving of space is obtained overhead for ventilation. In the engine-room the main steam pipe goes round the back of the cylinders, by which more room is obtained for getting off the slide-valve covers, &c. The cylinders proper are completely enclosed in outer iron cylinders or steam-jackets, having a space of three inches between the two, supplied with steam by separate pipes—these being the first engines fitted in this manner by Messrs. Maudslay and Field. The engines are fitted with double port slides and a screw, instead

RAILWAY ACCIDENTS.

ALARMING RAILWAY ACCIDENT.—An accident of an alarming character, but which was fortunately unaccompanied with any very serious consequences, happened on the 13th ult. to the Birmingham portion of the London and North-Western train for the north, which leaves London at nine in the morning. At the time in question the train had reached a point of the line within about four miles and a half of Stafford, when the ash-box of the engine fell off, and became lodged between the bottom of the first carriage and the line, for a short distance, violently shaking the rest of the train, and destroying certain of the cross timbers. Four of the carriages ran off the line, two wheels were broken, an axle-tree bent, and one or more footboards broken. The engine and tender were jerked up some distance off the rails, but fell back in gear, with the axle-trees of the tender bent and the break broken, and the gravest apprehensions were entertained as to the safety of the passengers. When, however, the train was brought to a stand, it was found that not one of the passengers had been severely injured—the only injuries that had been sustained being confined to a few minor bruises.

FRIGHTFUL RAILWAY ACCIDENT.—On the 20th ult. a man was run over a short distance beyond Rochdale, by the Lancashire and Yorkshire express, due in Manchester at 11:15. The poor fellow's head was cut off, and his body much mutilated.

BOILER EXPLOSIONS.

ASSOCIATION FOR THE PREVENTION OF STEAM BOILER EXPLOSIONS.—The monthly meeting of the Executive Committee was held on the 5th ult., Mr. William Fairbairn, C.E., F.R.S., president, in the chair. The chief engineer presented his monthly report, from which the following is abridged:—During the past month 501 boilers have been examined, and 355 engines. The following are some of the principal defects, which have been found to exist in the boilers inspected, and to which the attention of the owner was in each case called:—Fractures, 7; corrosion, 19 (one dangerous); safety valves out of order, 24; water gauges ditto, 19 (eight dangerous); steam pressure gauges out of order, 9; feed apparatus ditto, 2; blow-off cocks ditto, 15 (two dangerous); fusible plugs, ditto, 6; furnaces out of shape, 18 (five dangerous); over pressure, 1 (dangerous); total 120 (17 dangerous). Boilers without glass water gauges, 8; without pressure gauges, 14; without blow-off cocks, 21; without feed check valves, 57. Nothing can more clearly show the necessity for systematic boiler inspection than a fatal explosion which has taken place during the last month, attended with the loss of four lives. The boiler in question had been at work for a number of years, and the thickness of the flue which collapsed was found to be very considerably reduced in places by wear, and this was given in the evidence on the inquest as the cause of the accident. Added to this, although this boiler was one of a series connected together, the whole were without feed check valves, which experience has shown to be necessary to prevent one boiler robbing another of its water unawares, and leaving the furnace crowns dry. It is reported that on the application, after the accident, of an hydraulic test, the furnace crowns of some of the adjoining boilers also gave way, showing that the timely application of this test to all the boilers would have prevented the sacrifice of four lives. With these facts in view, there cannot be any doubt of the importance, or rather the necessity for regular boiler inspection; and notice is drawn to these particulars in the hope of preventing thereby the recurrence of such lamentable accidents.

WATER SUPPLY.

ARTESIAN WELLS IN ALGERIA.—The following are the results of the borings undertaken since the year 1856, in the south of the province of Constantine:—The number of wells sunk up to the present time in the Oued-Hir, and in the Hodna, is 31, yielding 33,631 litres of water per minute. The Tongourt artesian wells, in number 19, give 2700 litres per minute; that is, for the 50 wells of the province of Constantine a supply of 36,421 litres per minute, or, in 24 hours, 52,446,249 litres. All these borings were executed with only three sets of tools. The average depth of the Oued-Hir and Hodna perforations is 89 metres 55 centimes; and Tongourt has a depth of about 55 metres 19 centimes. The mean discharge of the 31 wells in the first of these districts is 108,487 litres per minute. For each of the 19 wells of the second district, the mean supply was 14,634 per minute. The cost of these undertakings amounted, during four years, to the sum of 262,676 francs, from which is to be subtracted the value of the boring apparatus, 120,000 francs; that leaves a total expenditure of 142,676 francs. The main cost of each of the 50 wells is therefore 2853 francs, 52 centimes.

METROPOLITAN WATERS.—The water used for domestic purposes in London, according to the analyses of Dr. Robert Dundas Thomson, F.R.S., still exhibit an amount of impurity beyond the annual average. The quantity of organic matter in some, however, is less than in others; that in the Kent Company was chiefly oxidised, whilst in most of the other waters it was principally in its original condition. For the sake of comparison, the composition of a well-water at Weybridge is given, which was saturated with sewage, the well being undoubtedly situated in immediate contiguity with a cesspool, or drain, from which the contents freely filtered—a condition too prevalent in the case of country wells:—

	Total Impurity Per gallon. grs. or degs.	Organic Impurity Per gallon. grs. or degs.
Distilled water	0.0	0.0
Lock Katrine water—new supply to Glasgow	3.16	0.96
Manchester water supply	4.32	0.64
Weybridge well	215.60	42.24
THAMES COMPANIES.		
Chelsea	22.00	2.23
Southwark	22.28	1.84
West Middlesex	22.24	2.24
Grand Junction	22.56	1.36
Lambeth	20.53	0.96
OTHER COMPANIES.		
East London	24.68	1.52
New River	20.60	1.24
Kent	26.76	2.16

LYNN REGIS WATER WORKS.—The corporation have erected new water works near their present old works, to give the town a constant supply of water. The new machinery consists of a powerful pumping engine, of 50 horse power, and duplicate boilers, fitted with every requisite. The machinery is so arranged that the old engines are to work from the new boilers in addition to the new engine. The buildings consist of engine-house, boiler-house, lofty chimney shaft, with a 5ft. flue, engineer's residence, boundary fencing, stand pipe, and culverts from filter bed.

GAS SUPPLY.

THE CARDIFF GAS COMPANY have held their fortieth half-yearly meeting, and declared a dividend of 10 per cent. per annum on their old shares, and 8 on their new. The Grimsby Company have declared a dividend of 10 per cent. on their original shares. The South Shields Company have also declared a dividend at the rate of 8 per cent., free of income tax.

EXTENSION OF GAS WORKS, DONCASTER.—The Gas Committee of this borough are about making a considerable enlargement of their works by the addition of a new tank

and gasholder, capable of stowing 200,000 cubic feet of gas. The works are the property of the company, and M. J. T. Fairbank, C.E., is the engineer for the additions above referred to.

NEW GAS METER.—A new gas meter has lately been constructed upon a new principle, invented by the late Samuel Clegg, C.E., with the view of facilitating the work of the Government and gas companies' inspectors. The drum, from its peculiar construction, it is asserted, requires much less pressure than any meter now in use. It is supported at the end of a lever, which allows it to rise and fall with the water; and the same motion of the drum shuts off the gas when the water in the meter case is too low, obviating the necessity of a separate float for that purpose.

THE THREE LARGEST GASOMETERS in the world are believed to be the following:—1st, the Imperial Gas Company's, at Hackney, 20ft. diameter, 80ft. deep (in two lifts), and holding 2,500,000 cubic feet of gas; 2nd, the gasholder of the Philadelphia Gasworks, at Philadelphia, United States, 160ft. diameter, 95ft. deep (in two lifts), and holding 1,800,000 cubic feet; 3rd, that recently erected at Glasgow, 160ft. in diameter, 52ft. deep (in two lifts), and containing 1,024,000 cubic feet.

DOCKS, HARBOURS, CANALS, &c.

AT A RECENT MEETING of the Blythe Harbour and Dock Company, a report was read from the directors to the effect that a pier on the eastern side of the harbour, a large timber wharf, and a half-tide breakwater, have been completed, by which an uniform channel, 100ft. wide and 16ft. deep in ordinary spring tides, has been secured from the shipping berths to the sea. The expenditure up to the date of the report had been £91,548.

PORTSMOUTH DOCKYARD COALING JETTY.—Messrs. Grissell's contract for the erection of the new coaling jetty at Portsmouth Dockyard will be completed in about a fortnight's time. The jetty presents a platform 650ft. long, by 60ft. wide, with four spaces of 15ft. each on its front face, for the erection of hydraulic cranes. In the construction of this jetty, 152 double piles have been driven, in three rows, the outer row being 50ft. in length, the middle row 40ft., and the inner row 35ft. The head of each double pile is fitted with an iron cap, weighing nearly 2 cwt., which supports the ends of iron girders, each averaging 37 cwt. There is a girder to each pile. Stout joists on the girders carry the 4½ in. planking of the jetty. The whole is diagonally braced underneath with 13½ in. timbers, and longitudinally by walling of the same substance. When complete, the *Warrior* and *Black Prince* may both lie alongside, and coal at the same time. In addition to the erection of the hydraulic cranes, the ground alongside has yet to be dredged out.

AT SKERRIES, a village on the coast to the north of the city of Dublin, a meeting has lately been held to consider the propriety of adopting a memorial to the Board of Admiralty, requesting that a harbour of refuge should be erected at that place, where it is very much needed, the rocks along that coast being often fatal to mariners. Many of the local gentry attended, and there was a deputation from the town of Drogheda. It is estimated that the harbour can be constructed for £30,000.

BUSTING OF THE BRIDGEWATER CANAL.—On the 11th ult., an accident, involving a vast amount of damage to the property of the Bridgewater Trustees, and the entire stoppage of their traffic, occurred a few miles from Warrington. At Lumb Brook, in the township of Appleton, the canal embankment is 25ft. above the adjoining land, and the road leading to Grappenhall Heys passes under it. This embankment gave way on the south-west side, causing an immense breach, down which the water rushed, carrying with it immense quantities of sand, earth, and blocks of stone. The wing wall of the bridge on that side was completely swept away. "Stops," or flood-gates, were brought into requisition as soon as practicable; but, owing to one of them being in a defective state, the flow of water was not arrested so soon as it might have been. Some cottages in the immediate neighborhood were several feet deep in water, but their occupants sustained but little damage beyond the inconvenience and trouble caused by the inundation. The scene now presented is that of a complete wreck. Great blocks of stone, &c. lie about in indescribable confusion, and about 7000 cubic yards of earth, &c., which formed the bed of the canal, has been carried into the lower ground, and into the road by the force of the current. Nothing is known as the cause of the accident. The very morning that it occurred, and only an hour or two previously, the inspectors passed the place, and failed to observe anything wrong. On Wednesday, about 100 navvies commenced the work of restoration, and a great number more will be put on as soon as practicable. It will be about a month before the traffic can be resumed. The damage has been variously estimated, but it is certain to amount to some thousands of pounds.

THE GREAT HARBOUR, MALTA.—The contractor for dredging the Great Harbour, having completed his preliminary arrangement, was expected to commence his part of the work on the 4th ult. The contractors for the construction of the wharves are also about to proceed with their portion of the undertaking. Mr. Churchward, C.E., who has nearly completed the construction of the new dry dock in Her Majesty's Dockyard, and other important works under the Admiralty, it is expected, will superintend the carrying out of the harbour improvements. The eight iron pontoons built by the respective firms of Messrs. Emmerson & Co., of Stockport, and Messrs. Campbell & Co., of London, are being rapidly put together, and will shortly be ready for launching. These pontoons are for the reception of the mud raised by the steam dredges.

HARBOURS BILL.—This Bill begins with giving power to the Public Works Loan Commissioners to make advances for the construction or improvement of harbours, "or for carrying into effect any other shipping purpose," to be repaid within 50 years, with 3½ per cent. interest, a higher rate being charged on all sums over £100,000. The bill then proceeds to abolish passing tolls, debts now charged on them to be paid by the State. Shipping dues (except pilotage rates), levied by charitable authorities, named in a schedule, are also to cease, except so far as may be requisite for payment of now existing pensions, and of compensations to be granted under this bill, or for the execution of such shipping purposes as have hitherto been executed out of such dues, and as are for the benefit of the shipping and goods on which they are levied. Differential dues are to cease in five years, but compensations paid out of public monies for differential dues are not to cease until the expiration of 10 years, if payable to private proprietors. Increased rates may, therefore, be levied by the local authorities where the compensation paid to them for differential dues is applied to the shipping or other public purpose, or where debts have been contracted for such purposes. Special taxes at the port of Dublin are abolished. Ramsgate harbour is transferred to the Trinity-house, which authority may levy certain tolls. Any deficiency of income for the harbour purposes is to be supplied from a Parliamentary vote; the town dues on coal are to cease. The authorities of Dover Harbour are authorised to levy a rate for harbour purposes on all vessels using the harbour. The debts on Whitby and Bridlington Harbour tolls are to be paid by Parliament, and rates for harbour purposes may be levied on vessels using the harbour.

RAILWAY BRIDGE OVER THE RHINE.—The great railway-bridge over the Rhine, at Kehl, being nearly completed, experiments to test its strength have been made. First of all the two turning parts of the bridge were manoeuvred, and were found to work admirably. That on the French side, which weighs not less than 350 tons, was moved with the greatest facility by eight men, and finally by two. Afterwards a train of 5 locomotives and their tenders, forming a weight of nearly 3½ tons per metre, passed over the line, and then remained stationary on the first part of the bridge on the French side; next, a locomotive and 15 fifteen waggons filled with stones, weighing about 1½ tons per metre, was driven over, and was subsequently stationed for a time on the middle of the bridge; in

the third place, the two trains passed over side by side, and were made to stand on different parts of the structure; next, two other trains, each consisting of 5 locomotives, were also driven over the bridge, side by side, and were made to remain together some time on the turning bridges, and on other portions of the structure; lastly, these two trains crossed each other at full speed. During the experiments, the different parts of the bridge scarcely yielded, proving the correctness of the engineer's calculations, and the great care with which the bridge had been constructed.

SEWERAGE WORKS.

MAIN DRAINAGE WORKS.—In the February monthly report, the engineer of these works states that the five great contracts for the main drainage are now actively progressing, and the amount of work executed may be expected to increase each month as the summer advances. On the Northern High-level Sewer, £1370 have been expended during the month in the finishing works of the contract. The Northern Outfall Sewer is completely fenced in, and the excavations for the concrete embankment commenced. The contract for the Middle Level Sewer has been signed, and the contractors have received instructions to commence the work. On the south side of the river, the Southern High-level Sewer is now in progress at five different places. The value of the work done is about £66,000, and the total length completed nearly four miles. The Southern Outfall Sewer works continue to be carried on in a satisfactory manner. The tunnel under Woolwich is about one mile in length, and varies from 45 to 75 feet in depth. Four shafts have been sunk, and 3550ft. of tunnel completed, the headings being lighted with gas, and the miners working day and night. Two of the shafts have this week been connected by a heading driven through between them. The two sections were found to agree perfectly in line and level. The rest of the work is, with trifling exceptions, being constructed in open cutting, and about 8400ft. have been completed, making 2½ miles in tunnel and open cutting. The value of the work done is about £107,000.

THE LEICESTER SEWAGE WORKS (the population of which is 70,000), cost £40,000; and the annual outlay is about £2500.

MINES, METALLURGY, &c.

THE "BULEFOLD," from Port Augusta, South Australia, has arrived in the London Dock, with forty tons of copper ore on board, on account of the Great Northern Copper Company.

MOLE LEAD MINES.—The success which has attended the mining operations judiciously conducted in the above district has gradually increased its reputation, and it is now proposed to work an extensive property in the parish of Gvernaffield by a company, in shares of £5 each, concerning which no doubt whatever is entertained as to its remunerativeness.

HAMMERING AND ANNEALING ROLLED COPPER.—At the Manchester and Philosophical Society, Mr. Chas. O'Neill read a paper on the above. The result of his experiments proved that the best commercial rolled copper actually lost density by hammering, instead of gaining, as might have been anticipated. In the first series of experiments, ten pieces of copper were cut from a sheet of the thickness of 3-16 in.; the pieces weighing from 250 to 320 grs. each; their mean density was 8.879. The pieces were then separately subjected to the action of a powerful compressing machine, acting on the principle of the *genou*, about fifty blows being given. The density of these hammered pieces showed a mean of 8.855, being a loss of 0.024. The same pieces were annealed by being placed in red-hot sand, and cooled slowly; when cleared from adhering oxide, the mean density was found to be 8.884, being an increase of 0.029 on the hammered pieces, and 0.005 on the original pieces. A second series of experiments, made with very great care, corroborated the first in the main points. The pieces were from another and a better piece of copper;

ten pieces, weighing each from 420 to 520 grs., showing a mean density of 8.898, being hammered by the same machine, their mean density became 8.878, showing a loss of 0.020 by hammering. Upon annealing in a charcoal fire, the mean density of five out of the ten pieces was 8.896, showing a gain of 0.018 upon the hammered pieces, and a loss of 0.002 upon the original. A third series of experiments upon the change of density in a bar of copper by successive hammerings showed a loss of density from 8.885 to 8.867. The author considered there was a connection between these phenomena and the heat disengaged in the hammering of the copper; he conceived it possible that the expanded state of the copper while heated by hammering was retained, and that the effect of annealing might be to allow the molecules or particles to recover the state in which they were in before being disturbed by the heat produced in hammering.

APPLIED CHEMISTRY.

CARBONIC ACID IN THE SOIL.—It is stated by Van den Broek that a solution of carbonic acid percolating through the soil is, up to a certain limit, robbed of its carbonic acid, so that the filtrate no longer causes any turbidity with lime-water; and, if a stream of hydrogen gas be passed through a layer of earth, the carbonic acid can be displaced. This author lays stress on this property of the soil holding carbonic acid, as supporting Liebig's views on the subject of the nutrition of plants.

MINERAL GREEN FREE FROM ARSENIC.—Struve gives an analysis of this colour, which has been in use in Germany for the last three years, as a substitute for Schweinfurt green. Its composition was as follows:—

Chromate of lead.....	13.65
Basic carbonic of copper	80.21
Oxide of iron.....	0.77
Carbonate of lime	2.65
Moisture.....	2.58

This colour, although it has not all the beauty of the Schweinfurt green, is recommended as being free from arsenic; but it is not altogether harmless, and, therefore, must not be used in confectionary, or the like.

MOLYBDENATE OF AMMONIA A TEST FOR SULPHUR.—Schlossberger states that a dilute solution of molybdenate of ammonia, supersaturated with hydrochloric acid, gives a beautiful blue colour, with a solution of sulphuretted hydrogen, or the sulphide of a metal. This test, he states, is more delicate than the nitro-prusside of sodium.

ESTIMATION OF IODINE AND BROMINE IN MIXTURE.—Reiman shows that iodine and bromine may be estimated, when existing together in solution, by means of a solution of chlorine of known strength. If a solution containing both the iodide and bromide of potassium be shaken with a standard solution of chlorine, and a small quantity of chloroform, the chloroform becomes of a blue, or if the solution of salt be very weak, a rose colour. On continuing to add chlorine water, the colouration disappears, when six equivalents of chlorine have been added to one of the iodide. Then, if the solution contains bromide, on a further addition of chlorine a new reaction takes place, and the chloroform becomes yellow, then orange, afterwards again yellow, and finally a yellowish white when two equivalents of chlorine have been added to one of bromine. The bottle must be placed on a sheet of white paper to see these changes clearly. On a further addition of chlorine, the chloroform becomes colourless on the formation of the pentachloride of bromine. Founded on these reactions, the author has constructed a formula for making an approximate quantitative estimation of the iodine and bromine, but the process is evidently of but little practical use. The author explains that a bromine reaction is finished when the chloroform has the colour of a weak solution of chromate of potash. If the liquid tested contains organic matter, it must be got rid of by calcination with caustic soda.

LIST OF NEW PATENTS.

- | | | |
|--|--|---|
| <p>APPLICATIONS FOR PATENTS AND PROTECTIONS ALLOWED.</p> <p><i>Dated October 29, 1860.</i></p> <p>2646. A. S. Stocker, Wolverhampton—Manufacture of horse and other shoes.</p> <p><i>Dated January 2, 1861.</i></p> <p>7. D. A. Johnson, Chelsea, Suffolk, Massachusetts, U.S.—Method of constructing wooden wheels.</p> <p><i>Dated January 12, 1861.</i></p> <p>92. Hon. W. E. Fitzmanrice, 12, Hyde-park-gate—Generating heat for locomotive, marine, and other boilers.</p> <p>96. M. V. Boquet, 224, Rue de Rivoli, Paris—Stopping or closing canisters and bottles.</p> <p><i>Dated January 19, 1861.</i></p> <p>156. W. Clark, 53, Chancery-lane—Compass protractors.</p> <p><i>Dated January 21, 1861.</i></p> <p>166. J. B. Paseal, 29, Boulevard St. Martin, Paris—Generating burning gases to be applied as a motive power.</p> <p><i>Dated January 29, 1861.</i></p> <p>232. J. Robertson, Upper Newington, Mount Pleasant, Liverpool—Sewing machines.</p> <p>236. W. Smyth and M. Wasley, both of Coed Mawr Pool Mine—Apparatus for crushing or breaking up ores, stones, and other hard substances.</p> <p><i>Dated February 2, 1861.</i></p> <p>284. W. Clark, 53, Chancery-lane—Instruments for testing the alcoholic strengths of liquids.</p> <p><i>Dated February 5, 1861.</i></p> <p>296. R. Jeffery, Guildford—Breech-loading gnns.</p> <p>298. W. Paton, Johnstone, North Britain—Coating, colouring, and glazing, or finishing laces, bands, straps, belts, and other similar articles.</p> <p><i>Dated February 11, 1861.</i></p> <p>336. H. Louch, Love-lane, Shadwell—Manufacture of yarns or threads from hemp, flax, cotton, or other fibrous materials.</p> | <p>343. R. A. Brooman, 166, Fleet-street—Gas apparatus for lighting pipes, cigars, and cigarettes.</p> <p><i>Dated February 12, 1861.</i></p> <p>350. S. Frankau, Bishopsgate-street Within—An improved cigar or pipe rack.</p> <p>352. N. Frankenstein, Mining-lane—Syphons for drawing oil liquids from casks and other vessels.</p> <p>354. J. Bowron, Stockton-on-Tees—Manufacture of bottles and other vessels of glass.</p> <p>356. W. Corbett, Clayton, near Manchester—Arrangement and construction of puddling and heating furnaces employed in the manufacture of iron and steel.</p> <p>358. W. Maltby, De Crepigny Park, Camberwell—Manufacturing a glutinous or viscid substance to be used in dressing textile fabrics, and for other such like processes.</p> <p><i>Dated February 13, 1861.</i></p> <p>360. W. Brown, Edgar-place, James-street, Mile End—Manufacture of frames, suitable for containing photographic portraits.</p> <p>362. A. Ellissen, Moorgate-street—Apparatus for working the breaks of railway trains.</p> <p>366. E. Cradock, High Holborn—Mechanism for improving the draught in open fireplaces.</p> <p>368. T. T. Lawden, gun manufacturer, Birmingham—Breach-loading fire-arms.</p> <p>372. W. Roberts, Millwall, Poplar—Portable fire pumps.</p> <p>374. A. Ripley, 42, Bridge-street, Blackfriars, and W. H. Stevenson, Duke-street, Adelphi—Constructing and forming pistons and piston-rods.</p> <p><i>Dated February 14, 1861.</i></p> <p>375. G. Searby, Threadneedle-street—Steam gauge.</p> <p>376. T. Cobley, Meerholz, Electorate of Hesse, Germany—Manufacture of white lead, zinc white, and glazing or potters' lead.</p> <p>377. P. S. Devlan, Elizabeth Port, Union county, New Jersey, U.S.—Journal and axle boxes.</p> <p>379. J. Garforth, Dukinfield—Metallic pistons.</p> <p>380. H. D. P. Cunningham, Bury, near Gosport—Rig of ships and vessels.</p> <p><i>Dated February 15, 1861.</i></p> <p>381. J. B. Nicolet, Brussels—Ornamenting skin gloves.</p> <p>383. M. A. Prenslan, Liverpool—Prevention of toothache and the preservation of teeth.</p> | <p>384. G. J. Wainwright, C. T. Bradbury, and J. Lawton, all of Dukinfield, Cheshire—Apparatus for roving, slubbing, or spinning cotton.</p> <p>385. W. H. Mansbridge, Camden Lodge, St. Paul's-road, Camden Town—Railway brakes.</p> <p>386. A. Leat, Crevecoeur, Oise, France—Looms for weaving.</p> <p>387. A. Senior, Dumfries—Looms for weaving.</p> <p><i>Dated February 16, 1861.</i></p> <p>389. J. Braham, Bristol—Spectacles and hand frames.</p> <p>390. J. Walker, Rhodes, near Manchester—Manufacture of soles for clogs and coverings for the feet.</p> <p>391. E. H. Barré and M. J. Blondel, Nantes, Loire Inferieure, France—Manufacture of paper.</p> <p>392. J. Horn, Whitechapel—Apparatus for the manufacture of bitumeuzed paper pipes.</p> <p>393. L. H. Réal, Paris—Weaving.</p> <p>394. T. Settle, Bolton—Apparatus employed in preparing cotton, wool, and flax, for spinning.</p> <p>395. N. Nussey, Holbeck, Leeds—Machinery for preparing and combing wool, silk, or other fibrous substances.</p> <p><i>Dated February 18, 1861.</i></p> <p>396. J. Womersley, Norwich—Paper making machines.</p> <p>397. R. Offord, 79, Wells-street, Oxford-street—Adaptation of india-rubber to various parts of carriages or vehicles.</p> <p>398. F. Schafer, Golden-square—Travelling bags and frames for the same.</p> <p>399. J. H. Johnson, 47, Lincoln's-inn-fields—Sewing machines.</p> <p>401. C. Price, Wolverhampton, and E. Price, Berry Bar, Staffordshire—Locks and latches.</p> <p><i>Dated February 19, 1861.</i></p> <p>402. A. Carter, Langley-place, East India-road, Poplar—An improved stadium or telemetre.</p> <p>403. J. B. Hawkins, North-street, Limehouse—Construction of cocks for drawing oil liquids.</p> <p>404. J. Browning, Minories—Telescopes.</p> <p>405. J. H. Brierley, 2½, Aldermanbury—Fastener for belts, bands, or straps.</p> <p>406. T. Pedrick, 8, Brighton-terrace, Brixton—Obtaining and applying motive power by water.</p> <p>407. M. Paris, Hill Side, Wimbledon—Fire-arms.</p> <p>408. W. Clark, 53, Chancery-lane—Preparation of alkaline and earthy cyanides.</p> |
|--|--|---|

410. A. V. Newton, 66, Chancery-lane—Coupling the rails of railways.
411. J. I. Jullion, Tynemouth—Construction of the bearings and other rubbing surfaces of machinery.
412. W. E. Newton, 66, Chancery-lane—Guns.
413. R. B. Burchell, Brooklyn, New York—Tighteners for the cords of curtains.
414. A. Turner, Leicester—Preparing warps for the manufacture of elastic fabrics.
415. M. Henry, 84, Fleet-street—Furnaces.
- Dated February 20, 1861.*
417. E. Wilkins, 8, Bath-terrace, Camberwell New-road—Boots, shoes, and goloshes.
418. C. Smith, Manchester—Apparatus for cutting or shaping soap or other similar materials.
419. J. Vasseur, 28, Gravel-lane, Southwark—Steam generators or boilers.
421. J. Suttou, Sheffield—Frames of spectacles.
422. G. Parsons, Martock—Construction of wheels.
423. W. Halse, Love-lane—Construction of reel for velvet or other ribbons.
424. T. Richardson, Newcastle-upon-Tyne—Manufacture of manure.
- Dated February 21, 1861.*
425. J. Louch, 69, Fenchurch-street—Furnaces.
426. F. D. Blyth, 113, Fenchurch-street, and J. Adair, Crane-court, Fleet-street—Machinery for forging nails and other articles.
427. C. Maschwitz, Birmingham—A new or improved tap or stop cock for liquids, steam, and gas.
428. J. Dutillou, 333, Rue St. Martin, Paris—Alarm whistle applicable to steam boilers.
429. J. Moon, Bedford-row—Apparatus for closing the passages of the chimneys from stoves and other fire-places.
430. J. J. Miller, Clarendon-place, Vassall-road, Brixton—Apparatus for governing or regulating the speed of steam and other engines and machines.
431. J. Longshaw, Manchester—Applying breaks to wheels of railway and other carriages.
432. W. E. Newton, 66, Chancery-lane—Centrifugal governors for marine and other steam engines and other motors.
433. W. E. Newton, 66, Chancery-lane—Breaks applicable to railway carriages.
434. J. J. Watts and S. Harton, 61, Shoe-lane—Manufacture of music plates.
435. D. Evans, Stratford—Manufacture of railway and other wheels.
436. W. Watson and A. Watson, Whitehaven—Apparatus for casting bullets.
437. J. H. Johnson, 47, Lincoln's-inn-fields—Application of certain vegetable substances to the manufacture of paper pulp.
- Dated February 22, 1861.*
439. B. Lang, Skinner-street, Snow-hill—Apparatus for feeding infants and invalids.
440. A. Crookes and H. Roberts, Sheffield—Doctor's calico wets or scrapers, used in the process of printing calicoes.
441. A. L. Cole, United Service Club, Pall-mall—Fire-arms.
442. J. B. Mannix, 21, Torriano-grove, Kentish-town—Method of applying springs to railway and other carriages.
443. H. G. Prossor, Waterford—Apparatus for singeing the hairs from off the carcasses of pigs.
444. H. G. Prossor, Waterford—Apparatus for separating chaff, sand, or other foreign substances from grain when it is being deposited in their holds for shipment.
445. H. Hatchwell, Newton Abbot, Devonshire, and S. B. Hatchwell, London—Stools or seats.
446. E. T. Truman, Old Burlington-street—Machines employed in the mastication of gutta percha.
447. M. L. J. Lavater, Guildford-street, York-road, Lambeth—Manufacture of pouches of india rubber, and india rubber fabrics.
448. A. Horwood, 29, Great Quebec-street, New-road—Application of electricity for communicating by signals with carriages on railways.
449. W. Walker, Liverpool—Rocket guns and rocket harpoons and appendages to be used therewith.
450. R. Cuthbert and W. Cuthbert, Newton-le-Willows, near Bedale and Leeming, Yorkshire—Reaping machines and grass mowing machines.
451. A. Barclay, Kilmarnock, Ayr, North Britain—Pumping engines.
452. J. E. Cook, Greenock—Coating and protecting the silvered surfaces of looking-glasses or mirrors.
453. R. Musket, Coleford, Gloucestershire—Manufacture of cast steel.
- Dated February 23, 1861.*
456. J. Martin, 10, Church-row, Limehouse—Preparation of red dyes.
457. C. Stevens, 31, Charing-cross—Method of unhooking in Jacquard machines.
458. C. Stevens, 31, Charing-cross—An improved elastic horse collar.
459. A. L. A. Herbelot, Paris—Machinery for reducing wood into chips or shavings.
460. H. Mackenzie, Ardross and Dundonnell, Ross, North Britain—Applying the water of rivers for driving mills without weirs or other obstruction to the passage of salmon and other fish.
461. J. W. Wyatt, Bunhill-row, Finsbury—Coating metallic springs or bands for crinolines and other articles of dress.
462. M. Meyers, Great Alle-street—Woven fabrics.
463. G. Ward and J. Gaskell, both of Blackburn—Apparatus for making healds.
465. F. E. Massey, 39, Rue de l'Echiquier, Paris—Construction of self-inking stamps for postal and other purposes.
466. W. Brooke, Parliament-street—Apparatus for suspending electric telegraph wires.
467. J. M. Dunlop, Manchester—Machinery suitable for cutting india rubber fillets.
468. J. Warren, Maldon—Chaff cutting machines.
469. L. Pohl, Offenbach, Germany—Albums or books for holding photographs, engravings, and other representations.
472. J. Hinks, Birmingham—Improvements in glass chimneys for lamps with flat wicks.
473. R. Musket, Coleford—Manufacture of cast steel.
- Dated February 25, 1861.*
476. W. G. Smith, Elizabeth Port, Union County, New Jersey, U.S.—Cutting apparatus of harvesters.
477. W. F. Henson, 15, New Cavendish-street, Portland-place—Springs.
478. J. Leeming, Bradford—Jacquard engines.
481. G. Clark, 11, Nicholl-square—Manufacture and mode of laying down submarine electro-telegraphic cables.
482. G. Clark, 11, Nicholl-square—Method of connecting and fastening together blocks, plates, or slabs of wood.
483. L. A. Bigelow, High Holborn—Boots and shoes.
485. J. Barling, Belle Grange, Lancashire—Mode of applying engine power to wheels.
486. J. Young, Limefield, Edinburgh—Apparatus for the treatment or distillation of bituminous substances.
487. J. Young, Limefield—Heating apparatus.
488. C. C. Regnault, Margaret-street, Cavendish-square—Manufacture of oils.
- Dated February 26, 1861.*
489. E. Ettrick, North Hylton, near Sunderland—Construction of furnaces for the prevention or consumption of smoke.
490. G. Davies, 1, Serle-street, Lincoln's-inn—Mechanical beds for invalids.
491. R. Tieman, Liverpool—Apparatus for drawing liquid substances from vessels containing the same.
492. W. H. James, Old Kent-road—Apparatus for taking or catching of fish.
493. R. A. Brooman, 166, Fleet-street—Manufacture of sugar moulds.
494. W. Parish, New North-road, Hoxton—Construction of tobacco pipes.
495. J. T. Pagan and T. B. Willans, Rochdale—Manufacture of flannel.
496. J. H. Bartholf, King-street, Holborn—An improved construction of rocking horse.
497. M. Orenstein, Jewry-street, Aldgate—Apparatus for securing watches.
498. L. Sideman and S. Phillips, Manchester—Hats, or coverings for the head.
499. J. H. Johnson, 47, Lincoln's-inn-fields—Forges.
- Dated February 27, 1861.*
500. W. Whalley, Granges, Vosges, France—Machinery for carding cotton and other fibrous substances.
501. W. Hudson and C. Catlow, both of Burnley—Power looms for weaving.
502. H. J. F. H. Foveaux, Strand—Specula, and plngs used in connection therewith.
503. C. Stevens, 31, Charing-cross—Chimneys.
505. F. Ransome, Ipswich—Manufacture of artificial stone and cement.
506. J. Taylor, jun., Rouppel Park, Streatham—Construction of roofs for buildings.
507. J. T. Whitgrove, Worcester—Funeral or mourning carriages.
508. M. Henry, 84, Fleet-street—Photography.
509. W. Weallens, Newcastle-upon-Tyne—Steam engines and boilers.
- Dated February 28, 1861.*
511. E. Brasier, Victoria-road, Deptford—Machinery for treating flax.
513. W. J. Hay, Southsea—An improved glue or composition, suitable for covering the caulking of ships and other like purposes.
514. R. Laing, Ince, near Wigan—Treatment of certain ores containing metals.
515. R. Whittam, Acerrington—Heating the feed water of steam boilers.
516. J. Wilson, Springfield Saw Mills, Manningham, near Bradford—Apparatus employed in sawing wood.
517. T. Newton, Long Acre—Accoutrements of horse soldiers' and other saddles.
518. C. Beslay, of Rue Menilmontant, Paris—Manufacture and renovation of woven fabrics.
519. R. Thompson, New Charlton, Kent—Machinery for cutting or sawing wood.
520. W. Rose and T. Crowder, Gun Dock, Wapping—Apparatus employed for raising and supporting ships and vessels.
- Dated March 1, 1861.*
521. W. Galloway and J. Galloway, both of Manchester—Moulding wheels and other metal articles.
522. J. W. Mott, Lea Bridge-road, Clapton—Purses, reticules, pocket-books, and other similar portable receptacles.
525. E. T. Hughes, 123, Chancery-lane—Time pieces.
526. G. Smith and J. Carrick, both of Glasgow—Commodos or closets.
527. R. Howorth, Blackburn—Manufacture of healds for weaving.
528. L. L. Sovereign, 302, Strand—Agricultural implement for cultivating land.
529. M. Henry, 84, Fleet-street—Distilling and rectifying.
530. E. Birch, 43, Parliament-street, and H. D. Mertens, Margate—Permanent way of railways.
- Dated March 2, 1861.*
531. J. Ellis, J. Stringer, and J. Bradock, all of Droylsden, Lancashire—Apparatus for lubricating the piston rods, valve rods, pistons, and valves of steam engines.
532. A. K. Irvine, Glasgow—Apparatus for stamping or marking letters or similar articles.
533. R. Griffiths, 69, Mornington-road—Arrangements and construction of armour or iron-clad steam or other ships.
535. W. Hendry, 220, Thistle-street, Hutchesontown, Glasgow—Building of boilers and boiler flues for the consumption of smoke.
536. E. J. Hughes, Manchester—Knitting machines.
537. C. Stevens, 31, Charing-cross—An ointment for the cure of sores.
539. G. G. Sanderson, Park Gate Iron Works, near Rotherham—Furnaces used in the manufacture of armour plates for ships and other structures.
540. J. B. Chaussonnet, 4, South-street, Finsbury—Apparatus for drawing off smoke and gases.
541. S. Botturi, Islington—Apparatus for weaving.
542. W. E. Newton, 66, Chancery-lane—Machinery for folding paper.
- Dated March 4, 1861.*
543. E. Sabel, Moorgate-street—Apparatus to be used in the manufacture of paper.
545. J. James, Princes-street, Leicester-square—Instrument for sharpening pencils.
547. S. A. Emery, Arundel-street—Portable apparatus for transporting locomotive engines and trains from one line of rails to another.
548. R. Murphy, Crumlin-road, Belfast—Looms for weaving.
549. H. Hirsch, Bridge-road, Lambeth—Improvements in insulating and covering the conducting wires used for telegraphic purposes.
550. G. Wilson, jun., Sheffield—Railway buffer.
551. A. V. Newton, 66, Chancery-lane—Construction of hook for hook and eye fastenings.
552. W. E. Newton, 66, Chancery-lane—Machinery for making bullets.
553. W. Kay, Bolton-le-Moors, and I. Kay, Lever Bridge, near Bolton-le-Moors, Lancashire—Machinery for doubling and double twisting yarns.
- Dated March 5, 1861.*
555. T. Scott, Newcastle—Construction of roadways and tramways.
556. E. Whittaker and J. Clare, both of Hurst, Lancashire—Apparatus for preparing cotton or other fibrous materials to be spun.
557. W. H. Haseler, 42, Vyse-street, Birmingham—Joints or hinges for jewellery and other articles having or admitting of metal joints or hinges.
558. J. M. Carter, Somerset House, Monmouth—Boots or other coverings for the feet.
559. G. H. Birkbeck, Southampton-buildings, Chancery-lane—Pistons for pumps, steam engines, or other purposes.
560. R. Brearley, Batley, Yorkshire—Treating woollen and union cloths for surface finish.
561. E. Alean, Coleman-street-buildings—Simultaneously marking and piercing or perforating plates of metal, cardboard, paper, and other material employed in looms for weaving figured fabrics.
562. C. Hanson, Haymarket—Firing gunpowder, gun cotton, and other like explosive compounds in large and small firearms.
563. A. V. Newton, 66, Chancery-lane—Machinery for forging horseshoe nails, spikes, and other like articles.
563. W. E. Newton, 66, Chancery-lane—Fastening for buttons, studs, breast pins, brooches, and other articles.
566. A. G. Corbett, Glasgow—Constructing and draining floors, suitable for stables and other places.
567. J. H. Johnson, 47, Lincoln's-inn-fields—Apparatus for administering medicated and voltaic baths.
- Dated March 6, 1861.*
568. G. B. V. Arbuckle, Charlton, Kent, and T. Scott, Bedford-street—Locks of firearms.
570. J. Statham, Salford, and W. Statham, Openshaw—Apparatus for mowing and reaping.
572. G. Eskholme, Rotherham—Apparatus for regulating the supply of water to water closets.
- INVENTIONS WITH COMPLETE SPECIFICATIONS FILED.**
416. B. Nicoll, 42, Regent-circus, Piccadilly—Method of treating needles used in sewing and other machines.
451. C. Eylan, Walsall, Staffordshire—Manufacture of certain kinds of spectacle frames.

THE ARTIZAN MAY 1ST 1861.

EASTERN STEAM NAVIGATION COMPANY'S GREAT SHIP

AUXILIARY ENGINES FOR WORKING THE SCREW AND PUMPS.

FIG 1.

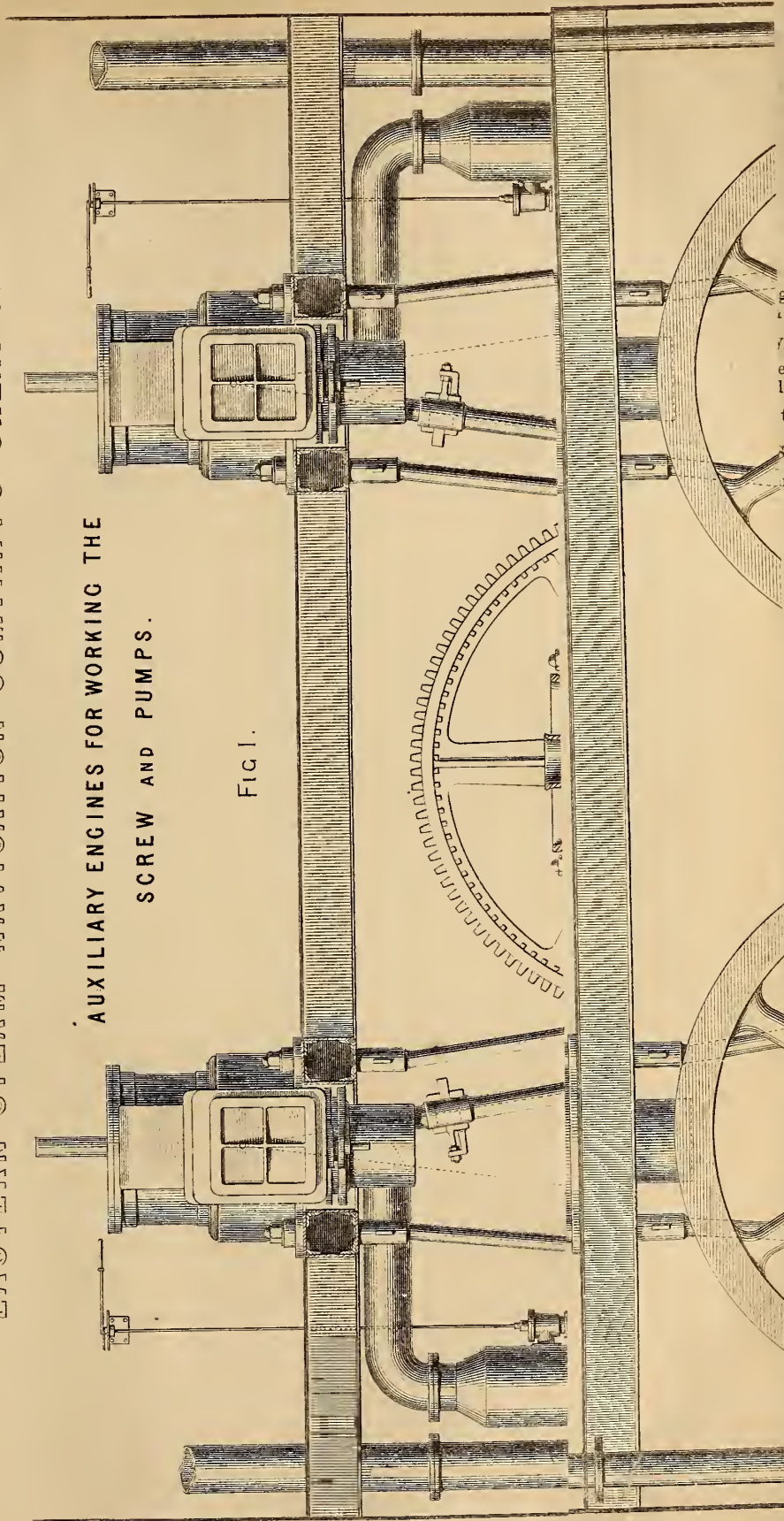

gle $b e W$,
 on $b c =$
 l , if W is
 ent case, d
 l bar, then
 the length
 $= W \frac{l}{d}$
 n a lattice

ie series or
 ie top and
 acting on
 the length
 re D is the
 re of the

two con-
 or of the
 first turn
 aving the
 caused to
 will that
 between d
 between d
 tion of W
 down our
 re to and
 that the

therefore

We may
 d and A .
 bar, and
 etc., but
 y strain
 e, it is a
 to w per
 mc effect
 bove the
 l on any
 d passes
 on loads,
 e strains
 + (plus).
 for the

ortion of
 eing the
 the pro-
 rom the

- 410. A. V. N
of r
- 411. J. I. J
ings
- 412. W. E. M
- 413. R. B. P
the
- 414. A. Tur
fact
- 415. M. Her

- 417. E. Wil
Bo
- 418. C. Smi
soa
- 419. J. Vav
rat
- 421. J. Sutt
- 422. G. Par
- 423. W. Ha
or
- 424. T. Rie
ma

- 425. J. Lou
- 426. F. D. l
co
- 427. C. Ma
stc
- 428. J. Dut
ap
- 429. J. Mo
sa
- 430. J. J. J
A
stc
- 431. J. Lor
of
- 432. W. E. l
fo
- 433. W. E. l
to
- 434. J. J. J
of
- 435. D. Ev
w
- 436. W. W
fe
- 437. J. H.
e
P

- 439. B. J
f
- 440. A. C
w
e
- 441. A. L
A
- 442. J. B
e
- 443. H. G
l
- 444. H. C
v
- 445. H. I
l
- 446. E. T
- 447. M. I
- 448. A. I

- 450. W.
- 452. R. C

- 453. A. J
- 454. J.
- 455. R.

- 456. J.
- 457. C.
- 458. C.
- 459. A.
- 460. H.

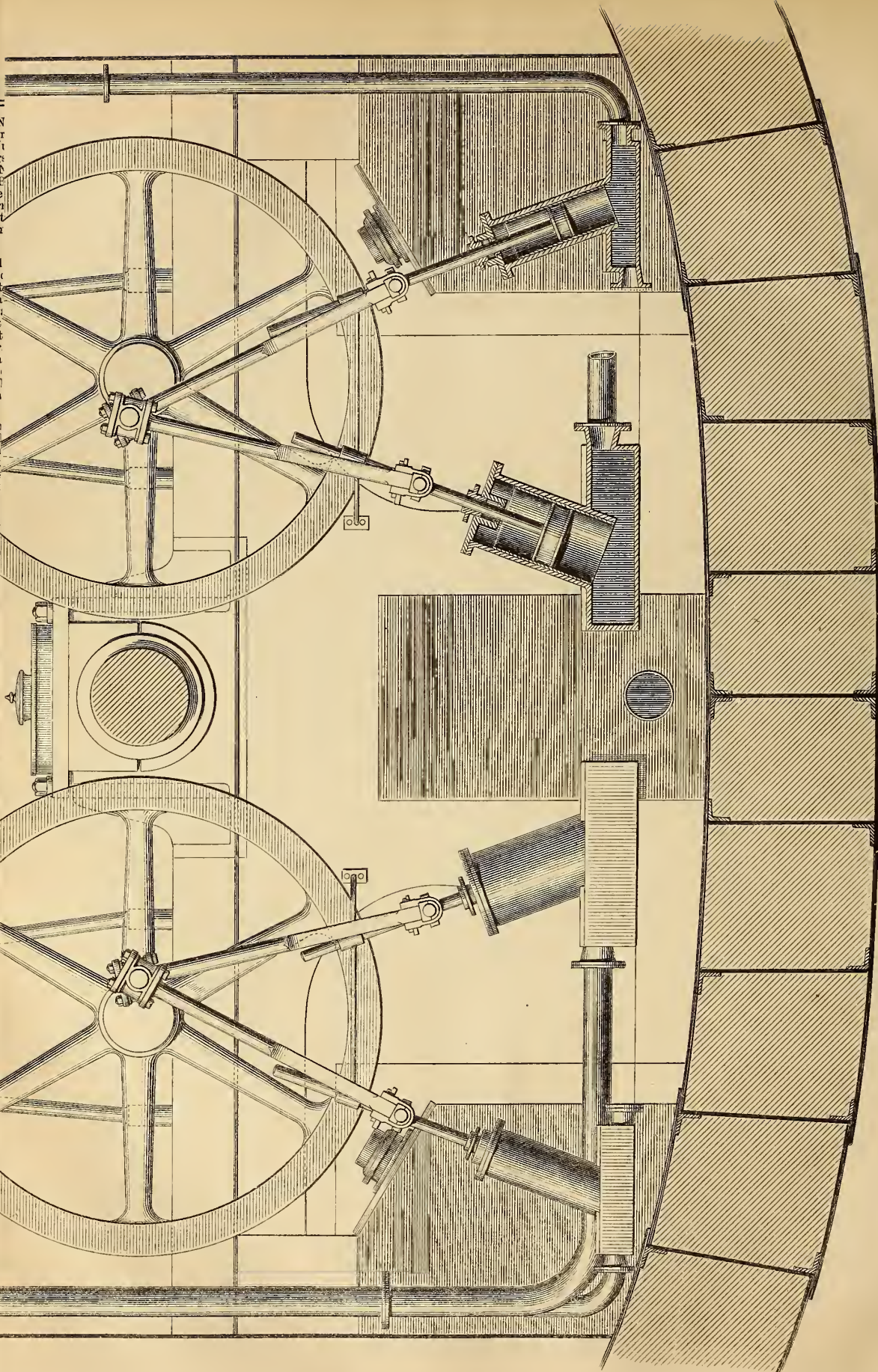

THE ARTIZAN.

No. 221.—VOL. 19.—MAY 1, 1861.

THE AUXILIARY ENGINES AND PUMPS OF THE "GREAT EASTERN" STEAMSHIP.

(Illustrated by Plate 192.)

We now present our readers with the copper plate engraving, which we some time ago promised, of the auxiliary engines employed for working the screw, and the pumps for fire and general purposes. Fig. 1 represents an end elevation, showing how the small engines are arranged for driving the screw shaft, when required. It likewise shows a part of the pumps, and a section across the thrust bearing. Fig. 2 is a sectional plan across the two main bearings of the auxiliary engines and the main thrust bearing of the screw engines. Fig. 3 is an end view, seen from the opposite side of Fig. 1, and shows the arrangement of the smaller pumps. We must defer, until some future opportunity, the summary which we intended to have given of the alterations which have been made in the machinery of the Great Ship since our last notice.

the three forces are represented by the three sides of the triangle $b e W$, which is similar to $b f W$, and also to $a b c$, hence the strain on $b c = W \frac{b e}{a c}$ and that on $a b = W \frac{a b}{a c}$, hence we may say, generally, if W is equal to the load carried by one inclined bar, as in the present case, d being the depth of the frame, and L the length of the inclined bar, then the strain on the inclined bar will be, $S = W \frac{L}{d}$; and if l be the length of the horizontal bar, the strain on the horizontal bar will be $S = W \frac{l}{d}$. This case is an exact illustration of the condition of the bars in a lattice girder, to which we will now turn our attention.

PRACTICAL PAPERS FOR PRACTICAL MEN.—No. III.

ON LATTICE GIRDERS.

As girders constructed with a lattice web are now becoming numerous, it is very desirable that some ready means of calculating the strength or dimensions of any lattice combination should be generally known; we therefore purpose to enter fully into an investigation of the principles of such structures. Many theories of lattice girders have been published, all on the same principle, that we shall adopt in the present paper, and they are all tolerably simple, but with the one disadvantage of being expressed by trigonometrical qualities, and this we shall especially avoid, so that our calculations may be readily comprehended by those who have not studied the elements of trigonometry.

We will commence with some preliminary remarks upon the resolution of forces, confining ourselves to the problems which have reference to our present subject.

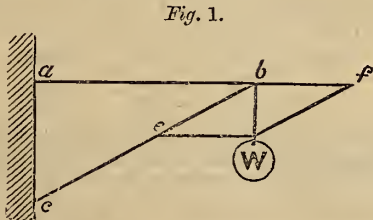

Let $b c$ (Fig. 1) represent a beam fixed into a wall obliquely, as shown and let its upper end be prevented from deflecting by a flexible tie $a b$; from the point b let a weight w be suspended, then will this weight be transmitted to the wall $a c$ through the bar $b c$, solely for the tie $a b$ being flexible, cannot bear any part of the load when in a horizontal position, although it will be subject to a certain amount of tension, produced by the tendency of $b c$ to revolve round the point c . We may now state axiom No. 1; deduced from the foregoing remarks it is as follows:—

If a triangular frame of bars be fixed at two of its angles, and a force be caused to act at the remaining angle, its direction lying in the plane of the triangle, then will two bars be strained by forces acting in the direction of their length, viz., the bars containing the angle on which the force acts. No bending moment can act upon the bar $b c$, because its extremity $b c$ cannot deflect.

It now remains for us to find the intensity of the strain on the elements $a b$, $b c$, which we may accomplish by the well-known principle of the parallelogram of forces. Complete the parallelogram $b e W f$; then, if $b W$ represents the weight or force acting at the angle b , $b e$ will be equal to the strain on $b c$, and $b f$ or $e W$ will represent the strain on $a b$; hence,

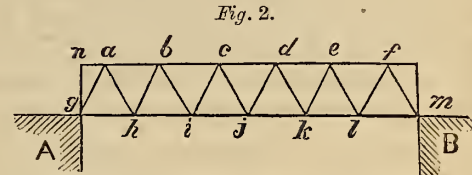

Let $a f m g$ (Fig. 2) represent a lattice girder composed of one series of inclined bars, whose extremities are maintained in position by the top and bottom horizontal members, or flanges. Let us call W the load acting on any bar, supposing them to be all of equal length, then L being the length of the lattice bars, the strain on that one will be $S = W \frac{L}{D}$ where D is the depth of the girder. All measurements are from centre to centre of the pins by which the joints are united.

Let $v = a b = b c = h i = i j = \text{etc.}$, = the distance between two consecutive joints, then, if n equal the number of these distances, or of the triangles, the span of the girder is represented by $n v$. We will first turn our attention entirely to the strains on the diagonal bars, leaving the flanges for a subsequent part of our paper. Let a load, W , be caused to act upon the apex d , x triangles distant from the pier A , then will that part of the load which is borne by A be the load upon the bars between d and A , and the remainder of W will be the load upon the bars between d and B . We may easily, by the laws of the lever, find the proportion of W borne by each point of support; but we will first pause to lay down our second axiom, which is, that the strain on any lattice bar is due to and proportional to the load passing to a point of support situated so that the bar is between it and the load.

The part of the load borne by B will be $= W \frac{x v}{n v} = W \frac{x}{n}$, and therefore the strain on any lattice bar between d and B will be $= W \frac{L x}{n D}$. We may similarly find the strain on the other part of the girder between d and A . The next point to be considered is the nature of the strain on any bar, and this is a matter of observation; thus it is compressive on $d k$, $e l$, etc., but tensile on $e k$, $f l$; hence our third axiom. If the direction of any strain is from the foot of the diagonal towards the summit of the same, it is a tensile strain, and vice versa. If there be a uniform load equal to w per lineal foot distributed over the whole girder, it will have the same effect as a number of small concentrated loads placed immediately above the apices or joints, each of which is equal to $w v$, and the total load on any bar may be found by ascertaining what proportion of each load passes through such bar to the piers, summing the tension and compression loads, and subtracting one from the other. We shall indicate all tensile strains by the sign - (minus), and all compressive strains by the sign + (plus). Let the load be placed upon the top flange of the girder, then for the first joint, $x = \frac{v}{2}$; for the second, $x = \frac{3 v}{2}$ etc.; and the proportion of any load borne by one pier is $= w v \frac{x}{n}$, n being constant, and being the denominator in every quantity; let, therefore, $w' = \frac{w v}{n}$, then the proportion of any load on one pier, the load being at a distance x from the

EASTERN STEAM NAVIGATION COMPANY'S GREAT SHIP

AUXILIARY ENGINES FOR WORKING THE SCREW AND PUMPS.

FIG 1.

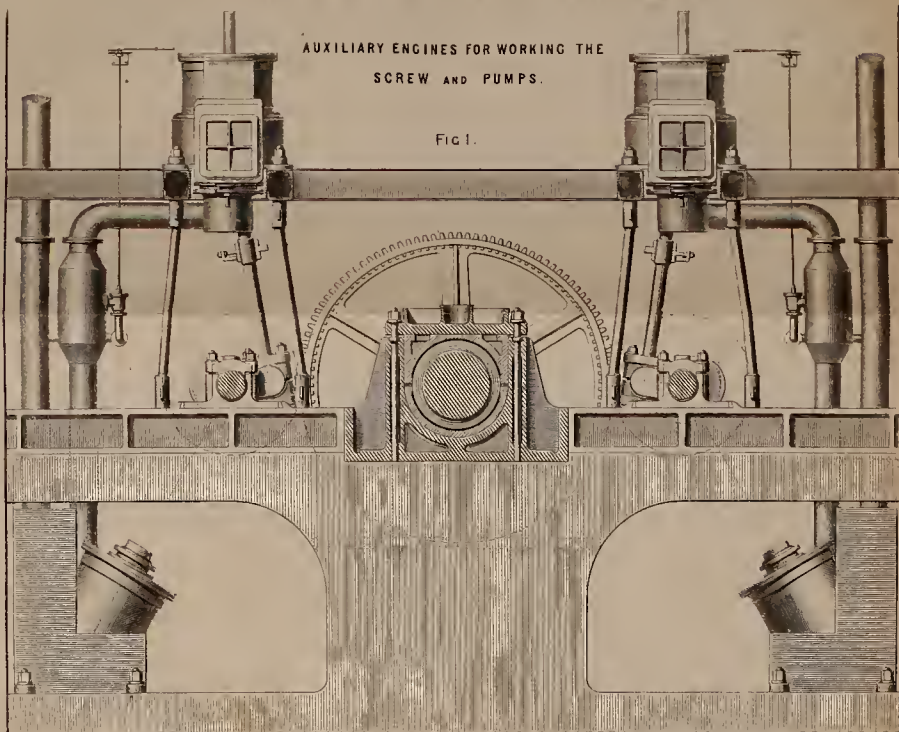
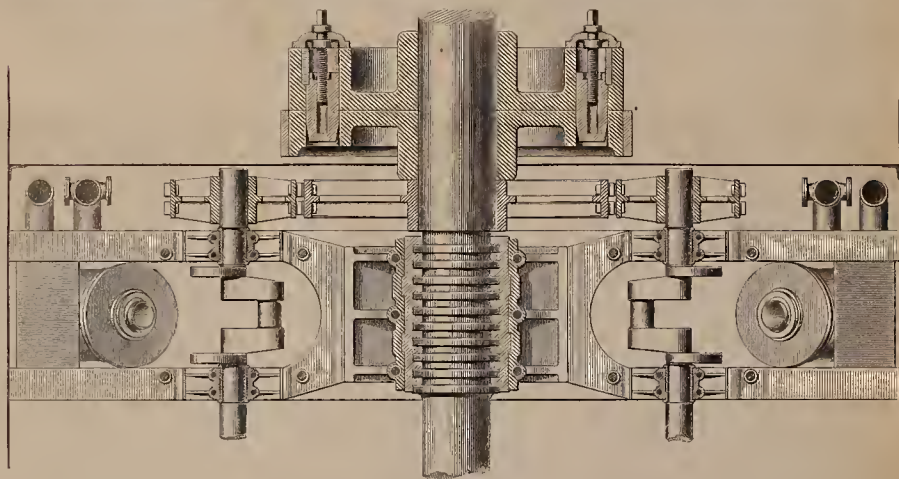
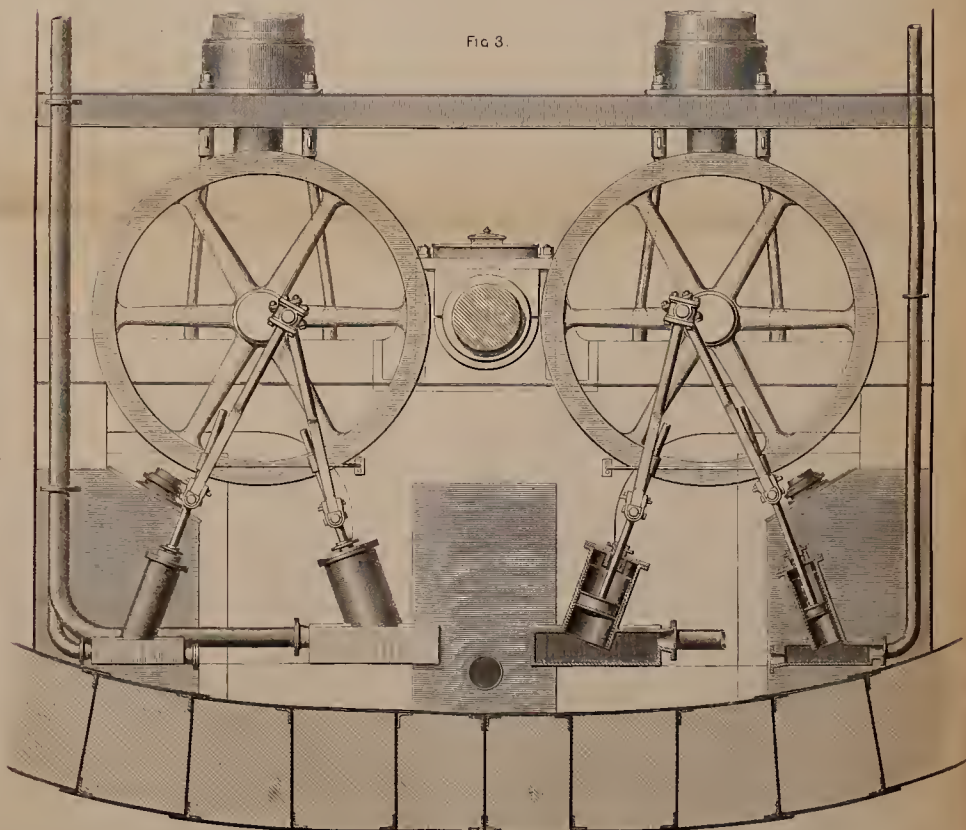

FIG 2.



Scale 1/4" = 1' 0"

FIG 3.



other pier, is = $w'x$. The following summations show the strains on various consecutive diagonals, commencing at one of the piers, for the form shown in Fig. 2:—

$$\begin{aligned} \text{First bar } \frac{w' L}{2 D} \{ & 1 + 3 + 5 + 7 + 9 + 11 + \dots + (2n - 1) \} \\ \text{Second bar } \frac{w' L}{2 D} \{ & -1 - 3 - 5 - 7 - 9 - \dots - (2n - 3) + 1 \} \\ \text{Third bar } \frac{w' L}{2 D} \{ & 1 + 3 + 5 + 7 + 9 + \dots + (2n - 3) - 1 \} \\ \text{Fourth bar } \frac{w' L}{2 D} \{ & -1 - 3 - 5 - 7 - 9 - \dots - (2n - 5) + 1 + 3 \} \\ \text{Fifth bar } \frac{w' L}{2 D} \{ & 1 + 3 + 5 + 7 + 9 + \dots + (2n - 5) - 1 - 3 \} \end{aligned}$$

And so forth for all the others. By inspecting these series we notice that the strain on each tie is equal to that borne by the following strut, supposing the ties and struts to be of equal length. If the girder be suspended by the top flanges as is sometimes the case, we shall commence with a tie instead of a strut.

Let us now take a practical case, whereby to exhibit the application of the above method. Let a bridge be required to carry a single line of railway, consisting of two girders composed of 10 equilateral triangles, such as are known as Warren's Girders, each division or base of a triangle, and therefore each lattice bar being 8ft. long. The depth will then be 6·928ft which we will call 7ft. Taking the weight of the bridge at $\frac{1}{2}$ ton per foot run, and that of the load at 1 ton, we have a total load of $1\frac{1}{2}$ tons, or $\frac{3}{2}$ ton on each girder, we will ascertain the strain on the various bars under a full load allowing 4 tons per sectional inch for compression and 5 tons for tension in determining the sectional areas of the bars. $w' = \frac{wv}{n} = \frac{75 \times 8}{10} = \cdot 6$, and $\frac{L}{D} = \frac{8}{7} = 1\cdot 143$ nearly; therefore, $\frac{w' L}{2 D} = \cdot 3429$, say, = $\cdot 343$. Then the strains and sectional areas will be,

Bar.	Strain.	Sectional Area.
1st. $\cdot 343 \{ 1 + 3 + 5 + 7 + 9 + \text{etc.} + 19 \}$	= 34·3 tons.	8·575 sq. in.
2nd. $\cdot 343 \{ 1 - 1 - 3 - 5 - \text{etc.} - 17 \}$	= 27·44 "	5·488 "
3rd. $\cdot 343 \{ 1 + 3 + 5 + \text{etc.} + 17 - 1 \}$	= 27·44 "	6·86 "

And so forth. It is evident that a total load would not produce the maximum strain on every bar, for there are both plus and minus signs in the series; hence to find the maximum strain we must make those terms which diminish the strain as small as possible, and those which increase it as large as possible. This is done by taking the former as produced by the weight of the structure only, the latter being calculated for the total load; w' will then have two values, one for the gross load $w' = \cdot 343$, and for the minimum load $w' = \cdot 114$. Then will the strains and sectional areas become—

Bar.	Strains.	Areas.
1st. $\cdot 343 \{ 1 + 3 + 5 + 7 + \text{etc.} + 19 \}$	= 34·30 tons.	8·575 sq. in.
2nd. $\cdot 343 \{ -1 - 3 - 5 - \text{etc.} - 17 \} + \cdot 114 \times 1 = 27\cdot 67$	"	5·534 "
3rd. $\cdot 343 \{ 1 + 3 + 5 + \text{etc.} + 17 \} - \cdot 114 \times 1 = 27\cdot 67$	"	6·917 "
4th. $\cdot 343 \{ -1 - 3 - \text{etc.} - 15 \} + \cdot 114 \{ 1 + 3 \} = 21\cdot 50$	"	4·300 "
5th. $\cdot 343 \{ 1 + 3 + \text{etc.} + 15 \} + \cdot 114 \{ -1 - 3 \} = 21\cdot 50$	"	5·375 "

And so on. These are the minimum areas, and of their adoption we shall presently speak. We will now pass on to the top and bottom flanges, first treating the strains upon them generally. We must again refer to Fig. 2. The strain on gh will be that produced by the strain on ag , which is resolved vertically upon the pier and horizontally on the lower flange; therefore, if the line ag represents the strain on that bar, an equals the strain on gh ; this strain passes on to h , where it is increased by the strain on bh , which is resolved between hi and ah ; hence the increment is represented by $a'b$. When $b'h$ is the strain on $b'h$, this strain passes on again, being increased at every joint by a similar quantity until it meets, and is reacted upon by the strain acting in the opposite direction. The greatest strain on the flanges will exist when the bridge carries the total load. We will work out the strains on the flanges for the case we have selected first for the lower flange. The strain on the first tension bar will be equal to the strain on the first diagonal $\times \frac{v}{2} \div$ length of diagonal; but the triangles being equilateral, $v =$ the length of diagonal; hence the strain on the first tension bar is half the strain on the first strut. The strain produced by that on any

other strut is equal to the strain on such strut. The minimum strain and area of each tie bar in the bottom flange of one girder will be as follows:—

Bar.	Strain.	Sectional Area.
1st. $\frac{34\cdot 3}{2}$	= 17·15 tons.	3·43 sq. in.
2nd. 17·15 + 27·24 = 44·59	"	8·912 "
3rd. 44·59 + 20·58 = 65·17	"	13·034 "
etc.	etc.	etc.

The strains on the lower flange are all tensile and produced entirely by the strains on the diagonal compression bars or struts. The strains on the upper flange are all compressive, and are due to the strains on the diagonal ties; they will be as follows:—

Bar.	Strain.	Sectional Area.
1st.	= 27·44 tons.	6·86 sq. in.
2nd. 27·44 + 20·58 = 48·02	"	12·005 "
3rd. 48·02 + 13·72 = 61·74	"	15·435 "
etc.	etc.	etc.

The strain on the first bar is obviously equal to v when the strain on the first tie is equal to the length of the tie. In Fig. 2, this bar is ab , for there is no strain on na .

It now appears desirable to determine the most economical arrangement which may be given to the diagonal bars of a lattice girder.

We will suppose all the bars to be of equal length; then will the weight of the web be proportional to the sectional area of one bar multiplied into the length of the bar, and the number of bars. Let $v = 2z$; then, because the depth of the girder, z , and the diagonal, form a right angle triangle, $L^2 = z^2 + D^2$. The sectional area of one bar is proportional to the strain, and therefore to $\frac{L}{D}$, and the number of diagonals is proportional to the span of the girder $\div zD$. If $l =$ span of the girder, the weight of the web varies as

$$\frac{L}{D} \times L \times \frac{l}{zD};$$

but for any one case l and D remain constant. Hence the weight of the web varies as

$$\frac{L^2}{z};$$

and for the most economical disposition of the bars this will be a minimum. We will take a series of values for z , D being = 2:—

$$\begin{aligned} \text{When } z = 1, L^2 = 5, \frac{L^2}{z} = 5\cdot 00 \\ = 2, \quad = 8, \quad = 4\cdot 00 \\ = 3, \quad = 13, \quad = 4\cdot 33 \end{aligned}$$

Hence the value of z is between 1 and 3. We will take another series:—

$$\begin{aligned} \text{When } z = 1\cdot 9, L^2 = 7\cdot 61, \frac{L^2}{z} = 4\cdot 0052 \\ = 2\cdot 0, \quad = 8\cdot 00, \quad = 4\cdot 0000 \\ = 2\cdot 1, \quad = 8\cdot 41, \quad = 4\cdot 0047 \end{aligned}$$

From this series we conclude that the greatest economy is obtained when $z = D$; hence our fourth axiom, *the lightest lattice web is obtained when the distance between two successive summits of the same system of triangles is equal to twice the depth of the girder.* The value of $\frac{L}{D}$ will in this case be

$$\begin{aligned} = \frac{\sqrt{z^2 + D^2}}{D} \\ = \frac{\sqrt{2D^2}}{D} = \sqrt{2} = 1\cdot 4142. \end{aligned}$$

The strain brought upon the flanges by any diagonal except the end ones will be equal to the strain on such diagonal $\times \frac{2}{\sqrt{2}}$, or it is equal to the load carried by such lattice bar $\times \sqrt{2} \times \frac{2}{\sqrt{2}} =$ twice the load carried by the lattice bar.

The strain brought upon the flange by the last lattice bar = load upon diagonal $\times \sqrt{2} \times \frac{1}{\sqrt{2}} =$ the load upon the diagonal.

Let us work out the strains and the sectional areas for one girder constructed on the above plan, but consisting of two series of triangles, so that one series will sustain half the load on the girder.

Let the span of the girder be 30 feet, the distance between two joints

in one series of triangles 6 feet, then the depth of the girder will be 3 feet. Let the load per foot run be .75 ton. Then, proceeding as before,

$$w' = \frac{w v}{n} = \frac{.75 \times 6}{5} = .9$$

for the two series, and .45 for one series of triangles, for which latter

$$\frac{w' L}{2 D} = .318, \text{ nearly.}$$

The strain on, and areas of the diagonal bars of one series of triangles will be—

Bar.	Strain.	Area.
1st. .318 { 1 + 3 + 5 + 7 + 9 }	= 7.95 tons.	1.987
2nd. .318 { -1 - 3 - 5 - 7 + 1 }	= 4.77 "	0.954
3rd. .318 { 1 + 3 + 5 + 7 - 1 }	= 4.77 "	1.192
4th. .318 { -1 - 3 - 5 + 1 + 3 }	= 1.59 "	0.397

and so on. These are, as before, the theoretical areas for an uniformly distributed load. We will now take the strains for maximum loads, considering .25 ton per foot run the weight of the structure, we shall have,—

Bar.	Strain.	Area.
1st. .318 { 1 + 3 + 5 + 7 + 9 }	= 7.95 tons.	1.987
2nd. .318 { -1 - 3 - 5 - 7 }	= 4.97 "	0.994
3rd. .318 { 1 + 3 + 5 + 7 }	= 4.97 "	1.242
4th. .318 { -1 - 3 - 5 } + .106 { 1 + 3 }	= 2.44 "	0.428

and so forth. The strains on the flanges may be worked out as before.

From these series we are induced to suspect that in some cases there are certain bars which act both as ties and struts; and this being a point of considerable importance, as will be shown hereafter, we will immediately ascertain under what circumstances this will occur. In calculating the maximum loads upon the diagonals, we are at liberty to consider whichever part of the girder we please as totally loaded, and in some cases we shall by these means find compressive and tensile strains acting occasionally on the same bar; thus, for instance, if we have a girder of 10 triangles, the weight of the structure being w , and that of the live load $2 w$ per foot run, we have for the strain on the eighth bar,—

$$\frac{3 w L}{2 D} \left\{ -1 - 3 - 5 - 7 - 9 - 11 \right\} + \frac{w L}{2 D} \left\{ 1 + 3 + 5 + 7 \right\} \\ = -\frac{54 w L}{D} + \frac{8 w L}{D} = -\frac{46 w L}{D}$$

If the load be on the other side of the bar, the strain will become—

$$\frac{w L}{2 D} \left\{ -1 - 3 - 5 - 7 - 9 - 11 \right\} + \frac{3 w L}{2 D} \left\{ 1 + 3 + 5 + 7 \right\} \\ = -\frac{18 w L}{D} + \frac{24 w L}{D} = \frac{6 w L}{D}$$

hence we see that, at and near the centre of the span, the diagonals will act sometimes as ties and sometimes as struts. We must, therefore, make them sufficiently strong to bear either strain; such variations of strain cannot, however, occur at or near the points of support.

A few remarks are necessary before leaving this part of our subject,—on continuous lattice girders.

In this case we may take the central part of the girder, viz., that contained between the points of contrary flexure, and treat it as a lattice girder of the same span supported freely at both extremities. And the other parts may be treated as semi-beams loaded with an uniformly distributed weight and with a weight at the end, which latter will be equal half the load on the central part of the girder. We may thus give a general rule for this case; bisect the distance between the points of contrary flexure, then the load carried by any strut whose upper end is n triangles from the point of bisection and by the tie to which it transmits the load, will be, w being the load per foot run, and v the length of the base of one triangle, $n. w. v$, and the strain on such strut and tie is $\pm n. w. v. \frac{L}{D}$

We have hitherto, in every case except one, regarded the web as consisting of one series of triangles, but it more frequently occurs that a number of series are used forming a lattice web; then each series will bear an equal portion of the load. Thus, if the base of one large triangle equals v , in one series there will be a load on each apex equal to $w v$; but if there are m series of triangles, the load on each apex will be $\frac{w v}{m}$, or we may calculate the areas of the bars as if for one series, and subsequently divide

these areas by the number of series of triangles employed. When only one or two series of triangles are used, totally distinct from each other, that is to say, not rivetted or otherwise fastened together at the intersections of the diagonals, the girder is termed a triangular girder; but if a greater number of series are employed and rivetted together at their intersections, it is called a lattice girder.

Having completed our investigation of the principles of lattice girders we will make a few observations on the construction of them, particularly as regards the forms of the various elements of which they are composed.

The bars must never be made of less areas than those obtained by the foregoing calculations, and in many instances it will be necessary to make them of greater area.

In triangular girders, the ties may be of flat bars or plates; but all bars which act as struts must be provided with feathers along their whole length, and they may be conveniently formed of angle, T, or channel iron, with or without the addition of flat bars, according to the requirements of the case.

In lattice girders, consisting of many series of triangulations, it will not be necessary to make the struts with feathers, and the rivetting together of the various lattice bars will make the web sufficiently stiff; but the girder should be provided with standards or stiffening plates at frequent intervals, in the same manner as an ordinary plate girder, and in fact it requires a greater number of these to render it equally stiff with a plate girder. In triangular girders, the bars will increase in their sectional areas as we proceed from the centre of the girder towards either point of support; but in lattice girders it will be found more convenient to make the diagonals all of the same sectional area, the necessary strength being supplied by using a greater number of series of triangles as we approach the points of support. The number of series of triangles will not alter between two standards, as such an arrangement would be very inconvenient. The diagonals near the centre of a triangular girder must all be made as struts.

Over the points of support, it will be necessary to use very strong standards, or, what will be more convenient, moderately strong standards and a plate web.

Very open triangular girders cannot be made continuous with advantage, for in that case the web of the girder must be very materially altered at and near the points of support. The bottom flange of a triangular girder may be made as bars or links, if the girder be not continuous; but the top flange must be rigid, if the girder has a lattice web; or if continuous, both flanges must be rigid.

In triangular girders, the diagonals must be fastened to the flanges by strong pins, or by rivetted joints. The latter method seems preferable, as imparting the greatest rigidity. The cross girders should be attached to strong standards, so arranged that the load may come first upon the joints in the top flange; if otherwise, the calculations must be slightly modified to suit the case, for, when this occurs, the load on the struts will be some what different.

REMARKS ON SOME RESEARCHES OF DR. JOULE.

BY A PRACTICAL ENGINEER.

Although the learned professor and the practical man are, by the nature of their respective avocations, in one respect widely separated, still, on the other hand, they are, from the circumstance of their mutual dependance the one upon the other, very closely related. The learned professor makes profound researches and scientific experiments,—in fact, leads the way for the practical man, whose place it is to apply in practice that which he receives from the theoretical man often in a very impractical state. They must work hand in hand, because the practical man must necessarily attain such an amount of theoretical knowledge as will enable him to understand and enter into the views and theoretical formulæ given him for his guidance. After having received what theory teaches us to be correct, the practical man has his toil and labour; because he finds himself very often much disappointed in the application of the theoretical rules being so much above what he really finds it to be in practice. But, at the same time, it encourages him, by showing him that there is such a wide field for improvement and application of his practical experience and skill.

Dr. Joule has thus shown us, in a paper published in 1846, the theoretical economical effect of a magneto-electrical engine, compared with the actual duty, from whence we see that the actual duty is from 60 to 75 per cent. of the theoretical, a result which at first sight looks very satisfactory in comparison with what we ever obtain from the steam engine; but the next question for the practical man is, what are the expenses of the battery. There we meet with the obstacle, viz., 1lb. of zinc for the battery costs about $3\frac{1}{4}d.$, whereas 1lb. of coal costs about $\frac{1}{3}$ farthing, the cost of the zinc being about 39 times the price of coal; here we must, however, on the other

hand, state, that in the steam engine we do not obtain more than 10 per cent. actual duty out of the heat expended, consequently, taking that into account, we get $\frac{39}{7.5}$, or about 5, as the number of times which a magneto-electric engine is more expensive in working expenses than a steam engine of the most economically working description, as employed in the Cornish districts. The professor has here shown us, that we only get $\frac{1}{10}$ th part available use out of the heat expended, and thus said to us, "there is room for improvement." It is now the practical man's duty to ascertain whence arises this loss, and how to alter this state of things so as to gain some more practical benefit from the heat expended. One of the chief reasons why there is so much heat lost is plainly; because we have only a very imperfect knowledge of the different temperatures in a steam boiler and hardly any one knows anything about this subject, which is so essential in order to enable us to design the construction of a boiler properly; likewise there is the loss of heat arising from the action in the same place of two elements, which are reciprocally injurious, viz., combustion and heat; another reason is the insufficient admission of air to accomplish a perfect combustion of the gases and the carbon; and also too narrow water spaces, preventing the proper circulation of the water, and too thick metal, retarding the rapid transmission of the heat to the water, both sources of loss of heat; a general adoption of forced draught would likewise decrease our loss of heat. In fact, if there is anywhere room for improvements, it is here, and the only way is to make a series of decisive experiments in order to obtain a thorough knowledge of the different temperatures and the proportions of the different parts of the boiler, &c., and which would at least be one step forward on the proper road that theory has shown us.

We are indebted to Dr. Joule for being the first to show us in a paper read in October, 1843, how closely *heat* and *power* are related to each other, and then for making such energetic researches as to find out and determine that law, by which we ascertain the certain fixed quantity of heat produced by the expenditure of a certain amount of mechanical power, viz., that the quantity of heat capable of raising 1 lb. of water one degree is equal to the mechanical power developed by a weight of 772 lbs. in falling through one foot perpendicular, or expended in raising a weight of 772 lbs. 1 ft. high; or the mechanical equivalent for one degree of heat is 772 foot pounds, equal to 772 lbs. lifted 1 ft., or one lb. lifted 772 ft. This is now generally called, after Dr. Joule, *Joule's equivalent*. For discovering the mechanical equivalent, Dr. Joule employed first a magneto-electric machine; but, not finding it very well adapted for the purpose, he commenced some experiments to ascertain the heat evolved by the friction of fluids, and found in this way very true and correct results, uninfluenced by the nature of the liquid employed.

Here it might not be out of place to point out one of the reasons why Dr. Joule is so much appreciated by practical men. It is because he, in the first instance, always conducts his experiments in an entirely practical manner, showing how the practical results of the experiments correspond with theory, thus making them more comprehensive for the practical man who likes to see some positive proof in order to accept that which he does not understand at first sight, and has no time to experiment upon himself; and secondly, he has, more than many scientific men, a tendency to make his formulæ less complicated, and, therefore, easier to comprehend than we often find to be the case. Further on, in the same paper, Dr. Joule shows us his experiments on the changes of temperature occasioned by the rarefaction and compression of atmospheric air. Here he shows the incorrectness of the former hypothesis—that a given weight of air had a smaller capacity for heat when compressed into small compass than when occupying a larger space. By forcing 2956 cubic inches of air at ordinary atmospheric pressure into the space of 136½ cubic inches, 13.°63 of heat per lb. of water were produced; whereas, by the adverse process, of allowing the compressed air to expand from a stop-cock into the atmosphere, only 4.°09 were absorbed instead of 13.°60, which is the quantity of heat which ought to have been absorbed, according to the generally received hypothesis. He likewise found that, upon the whole, when greatly compressed air was allowed to escape into a vacuum, no cooling effect took place, a fact likewise at variance with the generally received hypothesis. Here many a practical man might ask, why should we believe Dr. Joule more than anybody else? but Dr. Joule has given as a very simple answer, viz., because the heat evolved by compressing air was found to be equivalent to the mechanical power employed, and *vice versa*, the heat absorbed in rarefaction was found to be equivalent to the mechanical power developed, estimated by the weight of the column of atmospheric air displaced. In the case of compressed air expanding into a vacuum, since no mechanical power was produced, no absorption of heat was expected or found.

The above principles, first taught correctly by Dr. Joule, are of the greatest importance with respect to the steam engine, while expanding in a cylinder loses heat in quantity, exactly proportional to the mechanical force developed.

Dr. Joule now proceeds to explain his researches of the theories of Sir H. Davy, of a rotary motion, and Herapath's theory of a "flying-about motion" of the atoms of which gases and elastic fluids are believed

to consist, and shows how he finds the velocity at which they are supposed to move about, and how he from that velocity and the mechanical equivalent finds the specific heat of the different gases; and as the velocity of the particles is inversely as the square root of the specific gravity, he further shows that specific heat is inversely proportional to specific gravity, a law which has been arrived at experimentally by De la Rive and Marcet.

In another paper read April 6th, 1852, Dr. Joule points out how much more profitable the air engine is, when properly constructed, than the steam engine of ordinary construction; and this assertion has been confirmed by the extensive use there is made lately of air engines of small horse-power in America, with an enormous saving of fuel, although the weight of the air-engine per horse-power is possibly greater than that of the steam-engine.

There is one point on which we do not quite agree with Dr. Joule, that is, where he says "that the heated air escaping from the engine at a temperature as high as 219½° might be made available in a variety of ways to increase still more the quantity of work evolved; a part of this heated air might also be employed in the furnaces, instead of cold atmospheric air." To those conversant with Mr. Chas. Wye Williams's smoke prevention apparatus, it will be evident that, even as it is now, where we have to introduce, as a minimum, 150 cubic feet of atmospheric air at 50° for the perfect combustion of 1 lb. of coal (for the supply to the gases and carbon of the necessary quantity of oxygen), we very often find a great difficulty in getting space for air-holes to the amount of six square inches per square foot of fire-grate. What would it be when we used air heated to 220°? that would increase the volume of the air at 50°, viz., 150 cubic feet, up to 203.1 cubic feet, and only contain the same amount of oxygen.

In concluding these few remarks upon the labours of Dr. Joule, we may add, it must be evident how much we are indebted to him for his excellent researches, whereby we are enabled, with the help of *Joule's equivalent*, to calculate with very great precision the utmost quantity of work we can get out of lb. of zinc, coal, or any other substance, capable of generating power.

STEAM.

(Continued from page 83.)

CHAP. IX.—GASEOUS STEAM.

If ordinary or saturated steam be superheated or "surcharged" with heat, it advances from the state of saturation into that of gaseity. The transition into the gaseous state involves a considerable elevation of temperature, by amounts which increase with the pressures; and steam, when thus sufficiently elevated in temperature above the saturation-point due to its density, is known as gaseous steam, distinctively from ordinary, or, as it may be called, imperfectly gaseous steam.

Regnault found, throughout the whole range of his observations, that the specific density of gaseous steam at all temperatures was .622; that is to say, the weights of equal volumes of air and sufficiently superheated or gaseous steam, having the same pressures and temperatures, were as 1 to .622, and that therefore the steam so treated was gaseous, as the specific density being constant, the air and the gaseous steam, when taken at the same temperature, must expand alike when equally raised in temperature.

Confirmatory of Regnault's specific density of gaseous steam, the chemical union of oxygen and hydrogen, in the proportions to form steam, may be referred to. Two cubic feet of hydrogen and one of oxygen combining, will form two cubic feet of gaseous steam at the same temperature. The specific density of hydrogen is = .06926, and that of oxygen = 1.10563, and the density of the product is in the combined ratio of the densities and the uniting volumes.

Hydrogen, 2 volumes, × .06926 = .13852
Oxygen, 1 do. × 1.10563 = 1.10563

Gaseous steam, 2 volumes 1.24415 ÷ 2
Specific density = .622

being the same as was determined by Regnault from direct observation.

In accordance with the relations of perfect gases, the weight of a cubic foot of air, expressive of the density, D, at any pressure per square inch, p, and temperature, t° Fahrenheit, is expressed by the equation,

$$D = \frac{144 p}{53.15 (t + 461)}$$

in which 144 p expresses the pressure per square foot, t + 461 the absolute temperature, and 53.15 a constant determined for air. The same form will express the weight of steam by a modification of the constant in terms of the specific density; thus, for gaseous steam, $53.15 \div .622 = 85.4$ is the appropriate constant, and the weight of a cubic foot of gaseous steam is expressed by the equation,

$$D = \frac{144 p}{85.4 (t + 461)} = \frac{P}{85.4 T}$$

in which P = 144 p, and T = t + 461.

As the pressure, volume, and temperature of gaseous steam, and other gases, vary with each other in simple ratios—the pressure and the volume inversely with each other, and both of them directly with the absolute temperature—their mutual relation for any given constant weight of gas is such, that the pressure multiplied by the volume is equal to the absolute temperature multiplied by a constant number. For gaseous steam, as the weight in pounds of 1 cubic foot is equal to $P \div 85.4 T$; then, conversely, the volume in cubic feet of 1 pound of steam is $85.4 T \div P$, and, generally, $PV = 85.4 T$, for gaseous steam. For air, and a few other gases, the following are the general equations for a given weight, 1 pound of gas:—

Constants for One Pound Weight of Gas.

		Specific Density.
Air	$PV = T \times 53.15$	1.000
Gaseous steam	$PV = T \times 85.4$.622
Oxygen gas	$PV = T \times 48.07$	1.106
Hydrogen gas	$PV = T \times 767.4$.069
Sulphuric ether	$PV = T \times 20.8$	2.556
Alcohol	$PV = T \times 33.45$	1.589
Chloroform	$PV = T \times 10.0$	5.300

In order to find the total heat of steam, it may be observed, that from some experiments made by Regnault, it appeared that ordinary steam is nearly gaseous at temperatures below 60° Fahr. Mr. Brownlee has adopted a fundamental temperature of 40° Fahr. as that at which the saturated and the gaseous steams become identical in constitution. For gaseous steam, Regnault found the specific heat to be .475°; that is, that the total heat of gaseous steam increases uniformly .475° for each degree of sensible temperature; and it follows that an equation on the model of that for saturated steam may be found to express the total heat of gaseous steam. Proceeding on this basis, Mr. Brownlee finds, by the formula for saturated steam, that the total heat of steam at 40° Fahr., and at the pressure due of saturation, is $1113.4 - 32 + (.305 \times 40) = 1093.6^\circ \text{ F.}$; and he substitutes for .305 the gaseous constant .475, and adjusts also the first quantity in the expression, reducing it to 1106.6,—by as much, in fact, as the constant .475 adds to the first side of the equation. The expression then becomes $1106.6 - 32 + (.475 \times 40) = 1093.6^\circ \text{ F.}$, showing the same total heat, 1093.6° Fahr., regarded as gaseous steam, as was found by the formula appropriate for saturated steam. The general formula for the total heat of gaseous steam, putting t for the temperature in Fahrenheit degrees, is then,

$$H = 1106.6 - 32 + .475t; \text{ or}$$

$$H = 1074.6 + .475t.$$

To raise the temperature of the vapour generated at 40° to 212° through 172°, the pressure remaining the same, the additional heat is measured by $.475 \times 172 = 81.7^\circ$, and $1093.6 + 81.7 = 1175.3^\circ$, the total heat. Or, employing the above equation in the calculation, $.475 \times 212 = 100.7$, and $H = 1074.6 + 100.7 = 1175.3^\circ$, as before.

As already shown for saturated steam, the foregoing equation for the total heat of gaseous steam may be employed to find the actual expenditure of heat in raising gaseous steam from water of any temperature higher than 32° Fahr. The latent heat of this steam may be estimated from the total heat by deducting 180.9°, the heat necessary to raise the temperature of water from 32° to 212°; thus, $1175.3 - 180.9 = 994.4^\circ$, is the latent heat of any gaseous steam at 212°.

As for saturated steam, so also for gaseous steam, the latent heat diminishes as the temperature rises, but not so rapidly in the latter as in the former, as the specific heat is greater; that is to say, the increment of total heat, .475°, for each degree of sensible temperature of gaseous steam, is greater than the increment, .305°, for saturated steam; and therefore the difference, $1 - .475 = .525^\circ$, being the reduction of latent heat for each degree of temperature for gaseous steam, is less than the difference, $1 - .305 = .695$, for saturated steam.

The actual expenditure of heat in generating gaseous steam from water of higher temperature than 32° Fahr., may be found by substituting the temperature for 32 in the last formula; as follows, for the common temperature 62° Fahr.:—

$$H_1 = 1106.6 - 62 + .475t; \text{ or,}$$

$$H_1 = 1044.6 + .475t.$$

For a temperature of 100° Fahr. the formula is—

$$H_2 = 1106.6 - 100 + .475t; \text{ or,}$$

$$H_2 = 1006.6 + .475t.$$

For a temperature of 212°, with the specific heat of water 212.9°, the formula is—

$$H_3 = 1106.6 - 212.9 + .475t; \text{ or}$$

$$H_3 = 893.7 + .475t.$$

TABLE OF THE PROPERTIES OF SATURATED STEAM.

The appended table of the properties of saturated steam has been calculated by means of the formulae in this article. The first column contains the ascending total pressures in pounds per square inch. The second

column, of temperatures, was calculated from the pressures by the formula—

$$t = \frac{2938.16}{6.1993544 - \log. p.} - 371.85;$$

the third column, of total heat, was calculated by the formula $H = 1081.4 + .305 t$; the fourth column, of latent heat, by the formula $L = 1115.2 - .708 t$; the fifth column, of density, by the formula $\text{Log. D} = .941 \log. p - 2.519$; the sixth column, of the volume of 1 lb. of steam, by the formula $\text{Log. V} = 2.519 - .941 \log. p$; and the seventh column, of relative volume, by the formula $\text{Log. } n = 4.3135 - (.941 \times \log. p)$.

TABLE OF THE PROPERTIES OF SATURATED STEAM.

Total pressure per square inch.	Temperature in Fahrenheit degrees.	Total Heat in Fahrenheit degrees from 32 degrees.	Latent Heat. Fahrenheit degrees.	Density or weight of 1 cubic foot.	Volume of 1 lb. of Steam.	Relation Volume, or cubic feet of Steam from 1 cubic foot of Water.
Lb.	Fahr.	Fahr.	Fahr.	Lb.	Cub. Ft.	Rel. Vol.
1	102.1	1112.5	1042.9	.0030	330.36	20582
2	126.3	1119.7	1025.8	.0058	172.08	10721
3	141.6	1124.6	1015.0	.0085	117.52	7322
4	153.1	1128.1	1006.8	.0112	89.62	5583
5	162.3	1130.9	1000.3	.0138	72.66	4527
6	170.2	1133.3	994.7	.0163	61.21	3813
7	176.9	1135.3	990.0	.0189	52.94	3298
8	182.9	1137.2	985.7	.0214	46.69	2909
9	188.3	1138.8	981.9	.0239	41.79	2604
10	193.3	1140.3	978.4	.0264	37.84	2358
11	197.8	1141.7	975.2	.0289	34.63	2157
12	202.0	1143.0	972.2	.0314	31.88	1986
13	205.9	1144.2	969.4	.0338	29.57	1842
14	209.6	1145.3	966.8	.0362	27.61	1720
14.7	212.0	1146.1	965.2	.0380	26.36	1642
15	213.1	1146.4	964.3	.0387	25.85	1610
16	216.3	1147.4	962.1	.0411	24.32	1515
17	219.6	1148.3	959.8	.0435	22.96	1431
18	222.4	1149.2	957.7	.0459	21.78	1357
19	225.3	1150.1	955.7	.0483	20.70	1290
20	228.0	1150.9	952.8	.0507	19.72	1229
21	230.6	1151.7	951.3	.0531	18.84	1174
22	233.1	1152.5	949.9	.0555	18.03	1123
23	235.5	1153.2	948.5	.0580	17.26	1075
24	237.8	1153.9	946.9	.0601	16.64	1036
25	240.1	1154.6	945.3	.0625	15.99	996
26	242.3	1155.3	943.7	.0650	15.38	958
27	244.4	1155.8	942.2	.0673	14.86	926
28	246.4	1156.4	940.8	.0696	14.37	895
29	248.4	1157.1	939.4	.0719	13.90	866
30	250.4	1157.8	937.9	.0743	13.46	838
31	252.2	1158.4	936.7	.0766	13.05	813
32	254.1	1158.9	935.3	.0789	12.67	789
33	255.9	1159.5	934.0	.0812	12.31	767
34	257.6	1160.0	932.8	.0835	11.97	746
35	259.3	1160.5	931.6	.0858	11.65	726
36	260.9	1161.0	930.5	.0881	11.34	707
37	262.6	1161.5	929.3	.0905	11.04	688
38	264.2	1162.0	928.2	.0929	10.76	671
39	265.8	1162.5	927.1	.0952	10.51	655
40	267.3	1162.9	926.0	.0974	10.27	640
41	268.7	1163.4	924.9	.0996	10.03	625
42	270.2	1163.8	923.9	.1020	9.81	611
43	271.6	1164.2	922.9	.1042	9.59	598
44	273.0	1164.6	921.9	.1065	9.39	585
45	274.4	1165.1	920.9	.1089	9.18	572
46	275.8	1165.5	919.9	.1111	9.00	561
47	277.1	1165.9	919.0	.1133	8.82	550
48	278.4	1166.3	918.1	.1156	8.65	539
49	279.7	1166.7	917.2	.1179	8.48	529
50	281.0	1167.1	916.3	.1202	8.31	518
51	282.3	1167.5	915.4	.1224	8.17	509
52	283.5	1167.9	914.5	.1246	8.04	500
53	284.7	1168.3	913.6	.1269	7.88	491
54	285.9	1168.6	912.8	.1291	7.74	482
55	287.1	1169.0	912.0	.1314	7.61	474
56	288.2	1169.3	911.2	.1336	7.48	466
57	289.3	1169.7	910.4	.1364	7.36	458
58	290.4	1170.0	909.6	.1380	7.24	451
59	291.6	1170.4	908.8	.1403	7.12	444
60	292.7	1170.7	908.0	.1425	7.01	437
61	293.8	1171.1	907.2	.1447	6.90	430
62	294.8	1171.4	906.4	.1469	6.81	424

Total pressure per square inch.	Temperature in Fahrenheit degrees.	Total Heat in Fahrenheit degrees from 32 degrees.	Latent Heat. Fahrenheit degrees.	Density or weight of 1 cubic foot.	Volume of 1 lb. of Steam.	Relation Volume, or cubic feet of Steam from 1 cubic foot of Water.
Lb.	Fahr.	Fahr.	Fahr.	Lb.	Cub. Ft.	Rel. Vol.
63	295.9	1171.7	905.6	.1493	6.70	417
64	296.9	1172.0	904.9	.1516	6.60	411
65	298.0	1172.3	904.2	.1538	6.49	405
66	299.0	1172.6	903.5	.1560	6.41	399
67	300.0	1172.9	902.8	.1583	6.32	393
68	300.9	1173.2	902.1	.1605	6.23	388
69	301.9	1173.5	901.4	.1627	6.15	383
70	302.9	1173.8	900.8	.1648	6.07	378
71	303.9	1174.1	900.3	.1670	5.99	373
72	304.8	1174.3	899.6	.1692	5.91	368
73	305.7	1174.6	898.9	.1714	5.83	363
74	306.6	1174.9	898.2	.1736	5.76	359
75	307.5	1175.2	897.5	.1759	5.68	353
76	308.4	1175.4	896.8	.1782	5.61	349
77	309.3	1175.7	896.1	.1804	5.54	345
78	310.2	1176.0	895.5	.1826	5.48	341
79	311.1	1176.3	894.9	.1848	5.41	337
80	312.0	1176.5	894.3	.1869	5.35	333
81	312.8	1176.8	893.7	.1891	5.29	329
82	313.6	1177.1	893.1	.1913	5.23	325
83	314.5	1177.4	892.5	.1935	5.17	321
84	315.3	1177.6	892.0	.1957	5.11	318
85	316.1	1177.9	891.4	.1980	5.05	314
86	316.9	1178.1	890.8	.2002	5.00	311
87	317.8	1178.4	890.2	.2024	4.94	308
88	318.6	1178.6	889.6	.2044	4.89	305
89	319.4	1178.9	889.0	.2067	4.84	301
90	320.2	1179.1	888.5	.2089	4.79	298
91	321.0	1179.3	887.9	.2111	4.74	295
92	321.7	1179.5	887.3	.2133	4.69	292
93	322.5	1179.8	886.8	.2155	4.64	289
94	323.3	1180.0	886.3	.2176	4.60	286
95	324.1	1180.3	885.8	.2198	4.55	283
96	324.8	1180.5	885.2	.2219	4.51	281
97	325.6	1180.8	884.6	.2241	4.46	278
98	326.3	1181.0	884.1	.2263	4.42	275
99	327.1	1181.2	883.6	.2285	4.37	272
100	327.9	1181.4	883.1	.2307	4.33	270
101	328.5	1181.6	882.6	.2329	4.29	267
102	329.1	1181.8	882.1	.2351	4.25	265
103	329.9	1182.0	881.6	.2373	4.21	262
104	330.6	1182.2	881.1	.2393	4.18	260
105	331.3	1182.4	880.7	.2414	4.14	257
106	331.9	1182.6	880.2	.2435	4.11	255
107	332.6	1182.8	879.7	.2456	4.07	253
108	333.3	1183.0	879.2	.2477	4.04	251
109	334.0	1183.3	878.7	.2499	4.00	249
110	334.6	1183.5	878.3	.2521	3.97	247
111	335.3	1183.7	877.8	.2543	3.93	245
112	336.0	1183.9	877.3	.2564	3.90	243
113	336.7	1184.1	876.8	.2586	3.86	241
114	337.4	1184.3	876.3	.2607	3.83	239
115	338.0	1184.5	875.9	.2628	3.80	237
116	338.6	1184.7	875.5	.2649	3.77	235
117	339.3	1184.9	875.0	.2652	3.74	233
118	339.9	1185.1	874.5	.2674	3.71	231
119	340.5	1185.3	874.1	.2696	3.68	229
120	341.1	1185.4	873.7	.2738	3.65	227
121	341.8	1185.6	873.2	.2759	3.62	225
122	342.4	1185.8	872.8	.2780	3.59	224
123	343.0	1186.0	872.3	.2801	3.56	222
124	343.6	1186.2	871.9	.2822	3.54	221
125	344.2	1186.4	871.5	.2845	3.51	219
126	344.8	1186.6	871.1	.2867	3.49	217
127	345.4	1186.8	870.7	.2889	3.46	215
128	346.0	1186.9	870.2	.2911	3.44	214
129	346.6	1187.1	869.8	.2933	3.41	212
130	347.2	1187.3	869.4	.2955	3.38	211
131	347.8	1187.5	869.0	.2977	3.35	209
132	348.3	1187.6	868.6	.2999	3.33	208
133	348.9	1187.8	868.2	.3020	3.31	206
134	349.5	1188.0	867.8	.3040	3.29	205
135	350.1	1188.2	867.4	.3060	3.27	203
136	350.6	1188.3	867.0	.3080	3.25	202
137	351.2	1188.5	866.6	.3101	3.22	200
138	351.8	1188.7	866.2	.3121	3.20	199
139	352.4	1188.9	865.8	.3142	3.18	198

Temperature in Fahrenheit degrees.	Total pressure per square inch.	Total Heat in Fahrenheit degrees from 32 degrees.	Latent Heat. Fahrenheit degrees.	Density or weight of 1 cubic foot.	Volume of 1 lb. of Steam.	Relation Volume, or cubic feet of Steam from 1 cubic foot of Water.
Lb.	Fahr.	Fahr.	Fahr.	Lb.	Cub. Ft.	Rel. Vol.
140	352.9	1189.0	865.4	.3162	3.16	197
141	353.5	1189.2	865.0	.3184	3.14	195
142	354.0	1189.4	864.6	.3206	3.12	194
143	354.5	1189.6	864.2	.3228	3.10	193
144	355.0	1189.7	863.9	.3250	3.08	192
145	355.6	1189.9	863.5	.3273	3.06	190
146	356.1	1190.0	863.1	.3294	3.04	189
147	356.7	1190.2	862.7	.3315	3.02	188
148	357.2	1190.3	862.3	.3336	3.00	187
149	357.8	1190.5	861.9	.3357	2.98	186
150	358.3	1190.7	861.5	.3377	2.96	184
155	361.0	1191.5	859.7	.3484	2.87	179
160	363.4	1192.2	857.9	.3590	2.79	174
165	366.0	1192.9	856.2	.3695	2.71	169
170	368.2	1193.7	854.5	.3798	2.63	164
175	370.8	1194.4	852.9	.3899	2.56	159
180	372.9	1195.1	851.3	.4009	2.49	155
185	375.3	1195.8	849.6	.4117	2.43	151
190	377.5	1196.5	848.0	.4222	2.37	148
195	379.7	1197.2	846.5	.4327	2.31	144
200	381.7	1197.8	845.0	.4431	2.26	141
210	386.0	1199.1	841.9	.4634	2.16	135
220	389.9	1200.3	839.2	.4842	2.06	129
230	393.8	1201.5	836.4	.5052	1.98	123
240	397.5	1202.6	833.8	.5248	1.90	119
250	401.1	1203.7	831.2	.5464	1.83	114
260	404.5	1204.8	828.8	.5669	1.76	110
270	407.9	1205.8	826.4	.5868	1.70	106
280	411.2	1206.8	824.1	.6081	1.64	102
290	414.4	1207.8	821.8	.6273	1.59	99
300	417.5	1208.7	819.6	.6486	1.54	96

Mr. William Fairbairn and Mr. Thomas Tate read a paper at the meeting of the British Association for the advancement of science in September, 1859, containing some approximate results of experiments undertaken by them, for the purpose of determining the law of the density of steam and other condensable vapours, and of testing the deductions from the dynamic theory of heat of Professor Rankine and others, with respect to that subject. The new feature of the experiments consists in the use of the "saturation-gauge," to aid in determining with precision the point of saturation of steam. Suppose two globes, called A and B, to be connected by a syphon tube, containing mercury, and the whole to be immersed in a bath, in which they can be raised to any required temperature. If an absolute vacuum be created in each globe, and 20 grains of water be introduced into A, and 30 or 40 grains into B; then, if the temperature be slowly and uniformly raised around the globes, the water within them will be gradually evaporated, and filled with steam of a density increasing with the temperature, until the whole of the water in A is converted into steam, when instantly the line of the mercury, heretofore undisturbed, will rise towards the globe A. The disturbance of level thus occasioned constitutes the saturation test; it is caused by the change of the steam in A, the condition of saturation to that of superheating, whilst that in B, from which contains a surplus of water, must necessarily continue in the state of saturation, and there is no longer an equilibrium of pressure. The volume of the steam in A is known, and the temperature in the bath at the instant of the disturbance of the mercury is that of saturation. The following is a selection of temperatures and relative volumes of saturated steam approximately reduced from the experiments, with the corresponding volumes reckoned from the foregoing table of the properties of saturated steam:—

Temperature.	Relative Volume by Experiment.	Relative Volume by the Formula.	Difference by Experiment.
244°	896	935	- 39
245	890	917	- 27
257	751	753	- 2
262	684	695	- 11
268	633	632	+ 1
270	604	613	- 9
283	490	504	- 14

The nearness of the experimental results to those theoretically established is very remarkable. The differences, as Professor Rankine suggests, may arise from a difference in the value assumed for the volume of water.

(To be continued.)

ON THE MEASURE OF THE RESISTANCE OF STEAM VESSELS AT HIGH VELOCITIES, AND THE MECHANICAL EQUIVALENT OF FORCE.

BY R. ARMSTRONG.

The immense extent, and the rapid progress of steam navigation, render any subject in connection with it an object of the greatest importance to the patriot, naval architect, or marine engineer; and there cannot be a doubt that the highest problem of terrestrial mechanics, at the present time, is to ascertain, either theoretically or practically, the minimum of propelling power, consumption of fuel, and the wear and tear of the machinery for a given vessel, and rate of velocity.

With this object, "the measure of the resistance of steam vessels at high velocities, from the many attempts that have been made by our greatest philosophers, mathematicians, and experimentors at its solution, render the theory of fluid resistance, on account of the inherent difficulty of the subject, one of the most important and interesting problems in the whole of mechanical philosophy; for it cannot be denied that the science of hydro-dynamics is incomparably the most incomplete of all the branches of mathematical mechanics. To substantiate this assertion, an examination of the opinions expressed by various authorities on the subject, will be sufficient to show the absolute necessity of placing the theory of fluid resistance upon a permanent basis, so as to obtain the exact measure of the resistance of steam vessels at high velocities;" the twenty-eighth proposition of the Institution of Civil Engineers for the session of 1861.

First, Dr. Whewell, in his *History of the Inductive Sciences*, states, "Solid dynamics and fluid dynamics resemble two edifices which have their highest apartments in common; and though we can explore every part of the former building, we have not succeeded in traversing the staircase of the latter, either from the top or the bottom. Thus the general science of hydro-dynamics, considered as a practical one, is still in its infancy; and we are obliged to deduce its theorems and laws by processes that are purely empirical."

The same opinion is expressed by one of our most modern writers on Applied Mechanics,—Professor Rankine. He also states, "that our knowledge of the laws of the force exerted by a current against a solid body is almost purely empirical."

Lastly, in the able recapitulation of the various theorems advanced by the most eminent philosophers since the time of Newton, the late Professor Robison states, "that most of them, instead of principles, have given a great deal of calculus; and the chief merit that many of them can claim, is that of having deduced some single proposition which happens to quadruple with some single case of experiment, while their several theorems are either inapplicable from difficulty and obscurity, or are discordant with more general observation." From these few extracts, it is obvious how little advantage the theory of fluid resistance has received from the united efforts of the first mathematicians of Europe, and that little hopes are entertained of improving our scientific knowledge of the subject by merely following in the steps or processes of those eminent geometers, who have failed to deduce a single useful law for the practical mechanic. In attempting to solve this important and interesting problem, it must be evident that some new and unexplored track of induction must be pursued—all known principles of physical or abstract science having hitherto been exhausted, and found unavailing to establish the theory of fluid resistance upon a permanent basis. But, at the same time, whatever principle or method of solution is adopted, the safest foundation to work upon must be a principle in strict accordance with, and deduced from the Newtonian laws of motion, they having received universal assent of their correctness by induction; and when tested by the motion of the celestial bodies, and numerous experimentors, including Attwood, Morin, and M. Tresca, Sub-Director of the Conservatory of Arts, Paris, have been found to be absolutely true in every case, without exception. By proceeding upon the basis of such principles, the theory of fluid resistance must succumb to physical analysis; it cannot possibly be an exception to the universal applicability of these laws. Although they are variously expressed by different writers on mechanics, it is to the beautiful definition, and the simple explanation of the second law given by Sir Isaac Newton, to which attention is now directed.

LAW SECOND.

"The alteration of motion is ever proportional to the motive force impressed; and is made in the direction of the right line in which that force is expressed."

NEWTON'S EXPLANATION.

"If any force generates a motion, a double force will generate double the motion, a triple force triple the motion, whether that force be impressed altogether or at once, or gradually and successively."

In A. Morin's *Fundamental Ideas of Mechanics*, article 61, we find the following passage:—"This is called the principle of the proportionality of forces to their velocities;" and he likewise states, in explanation, "The observation of facts shows, and it seems quite natural to admit, that forces are really proportional to the degrees of velocities, which they impress in equal infinitely small times, upon the same body, yielding freely to their action, and in the proper direction of this action."

"This is one of the fundamental axioms admitted by all geometricians, and is proved in the exactitude of consequences deduced from it." Thus, if a force will produce only a definite amount of velocity in a unit of time, either a twofold force or a double amount of time will be required to perform a double space. Thus, the equivalent of a unit of force may be expressed in a definite amount of velocity, or the principle may be called the conservation of velocity. Proceeding by strict analogy with the above law, we may deduce the principle by which the attempt is now made to solve the problem of fluid resistance, viz:—*The alteration of the amount of mechanical effect is ever proportional to the motive force impressed.* Or by analogy with Newton's explanation, if any force generates a quantity of mechanical effect, a double force must generate a twofold amount; and a triple force a threefold amount. If we accept this analogy to be perfect and indisputable, it may then be asserted, that the alteration of mechanical effect is ever proportional to the motive force and time; so that, if it can be ascertained by experiment, what amount of mechanical effect a given force can produce in one second of time, it will either take a double force, or with the given force a twofold amount of time, to produce a double amount of mechanical effect. Therefore it must be evident, that if a double velocity cannot be obtained without a double force, it must be impossible to obtain a double amount of mechanical effect without the employment of a twofold force.

If this principle can be admitted, the theory of fluid resistance becomes simple and easy of solution, and nature's secret forced.

We have admitted as truths the conservation of *vis viva*, the conservation of energy, the conservation of the centre of gravity, the conservation of momentum, and the conservation of force; then why should its mechanical effects not be conserved when force itself is a constant quantity? Matter is indestructible, and every substance in nature has its chemical equivalent. We have the mechanical equivalent of heat (Joule's equivalent). If heat and motive power are mutually convertible terms, surely force and mechanical effect cannot be the exception to such an universal principle.

Let us now accept the principle of the conservation of the mechanical effect of force as a truth, and endeavour to ascertain by experiment, as Mr. Joule has done on heat, what is the mechanical equivalent of a unit of force in a unit of time; then we will have a theorem practically applicable to every purpose of steamship propulsion or applied mechanics. In the practical application of this theory, we will proceed tentatively in ascertaining how far the generally accepted theory of fluid resistance varying as the square of the velocity, can be reconciled with the second law of motion, and the conservation of the mechanical effect of force. The first experiments to be analysed are those which have been universally accepted by every writer on hydro-dynamics as correct, viz., the weights necessary to propel a body with a section to the line of motion of one square foot, at various velocities, they are represented in the well-known formula of Colonel Beaufoy, which is sometimes stated thus:—

$$\text{Resistance} = A w \frac{V^2}{2g}$$

by others as

$$\text{Force} = A w \frac{V^2}{2g}$$

while according to the real facts, they ought to be expressed as follows —

$$\text{A weight of matter descending uniformly} = A w \frac{V^2}{2g}$$

or, by reduction,

$$\text{A weight of matter descending uniformly} = A v^2 \text{ feet per second.}$$

The experiments, when tabulated, show the following data:—The three first columns represent the real facts, the remainder, the deductions from those experiments. Thus—the fourth column represents the resistance assumed to be equal the motive weight; the fifth, the mechanical effect on that assumption; the sixth (in the author's opinion), the resistance varying as the velocity; and the seventh, the mechanical effect based on the resistance of the previous column, which is proportional to the motive weight; thus corresponding with the second law of motion, and in unison with the conservation of the mechanical effect of force.

Number of Experiment.	Motive Weight of Matter.	Area of Section.	Velocity.	Resistance equalling weight of Matter.	Mechanical Effect.	Resistance varying as Speed.	Mechanical Effect.
	lbs.	sq. feet.	ft. Ψ sec.		foot lbs.		foot lbs.
1	1	1	1	1	1	1	1
2	4	1	2	4	8	2	4
3	16	1	4	16	64	4	16
4	64	1	8	64	512	8	64
5	256	1	16	256	4096	16	256
6	256	256	1	256	256	256	256
7	256	64	2	256	512	128	256
8	256	16	4	256	1024	64	256
9	256	4	8	256	2048	32	256
10	256	1	16	256	4096	16	256

The author here begs to state, that it is upon these experiments that his mechanical equivalent of force is deduced; that, whether the quantity is theoretically correct or not, he has found it practically useful, when tested by the results of trials published by the Admiralty, as will be shown hereafter. *The proposed equivalent being, that a force of one pound, or, practically speaking, each unit pressure of one pound in the cylinders of a steam engine, will produce one foot pound of mechanical effect in one second of time.*

As the above experiments have been made subservient to prove, that the resistance of a fluid varies as the square of the velocity, and are now produced to establish that the resistance only varies at the *simple speed* (the theory of Don George Juan D'Ulloa); consequently, the truth ought to be easily evolved. To establish that the resistance can be equated at every velocity to the weight propelling the body, we must assent—first, that the mechanical effect of matter descending uniformly is a variable quantity; that it is infinite, and can be increased *ad libitum*, by merely diminishing the section to the line of motion; thus, in the sixth and tenth experiment, 1lb. of matter has produced respectively 1lb. and 16lb. of mechanical effect; then again, speaking theoretically, if the section be further reduced, 1000 foot pounds of mechanical effect could be produced in one second of time by the action of 1lb. of matter.

Secondly, we must establish beyond a doubt that the weight in descending exerts precisely (whatever be its uniform velocity) the same tractive force as when weighed in the balance at rest. It must also be clearly established, by means of a dynamometer placed between the weight and the body propelled, that there is the same strain on the instrument when in motion as at rest.

By repeated experiments the author has ascertained that 1lb. of matter can only exert a tractive force of 1lb. when at rest. In the slightest downward motion, and as it increases in velocity, the tractive force of matter diminishes, thus proving experimentally that the resistance does not equate with the weight of matter at rest, the foundation of the theory of the resistance varying as the square of the velocity.

Thirdly, we must admit that, when the velocity is double, each impulse is quadruple. Now, by all the laws of dynamics, the impact can only be double; but as the impact is through a double space, in a unit of time the propelling weight must be fourfold. Again, what amount of matter is required to exert a double tractive force at a double velocity? If we test this again by the dynamometer, a fourfold amount will be required.

Lastly, if we increase the sectional area to the line of motion fourfold, and with a proportional force, the velocity will remain the same; thus proving that the impact of a body in a fluid does not increase as the square of the velocity, but *merely as the speed*.

To establish the theory that the resistance varies merely as the velocity, we must prove, first, that the mechanical effect of matter descending uniformly is a constant quantity, and proportional to the motive weight producing it. In the experiments quoted previous, it may pertinently be asked, how can the mechanical effect be in any other proportion? There is not even the apology for any mechanical contrivance to increase the mechanical effect—the same apparatus and the same formed body is employed. Secondly, adopting the sixth and tenth experiments, is it possible, or is it in accordance with the principle of "sufficient reason?" that 256 lbs of matter, attached to a plane one foot square, can produce 16

times the mechanical effect as when propelling a plane with an area of 256 square feet. We have it universally assented to, in the second law of motion, that to produce a 16-fold velocity, a 16-fold force is required with the same body or resistance, or that the resistance must be diminished in that proportion to obtain 16 times the velocity.

Lastly, if we can admit the conservation of momentum of force, or the constancy of mechanical effect of force, we can come to no other conclusion but that the resistance (*the impact*) varies merely as the speed, and that the work done—the force,—or a weight of matter to propel a body, varies as the square of the velocity.

If any further proof of the correctness of this theory is demanded, the *q. e. d.* must be supplied by experiment; therefore the author suggests that the Institution of Civil Engineers, or the Royal Society, by instituting the necessary experiments, would settle once and for always, the theory of fluid resistance, and at the same time, (a useful coefficient to the practical mechanic); the mechanical equivalent of force, (or, what is the same) or of matter descending, not accelerating, but at a uniform velocity.

The apparatus required would be similar to the models used in the Lyceums of France by the Minister of Public Instruction for observing the laws of motion. For a description, *vide* Arthur Morin's *Fundamental Ideas of Mechanics and Experimental Data*, page 89, Article 90, translated by J. Bennett, published by Appleton, New York. In the principle of the conservation of the mechanical effect of force we obtain a theorem of perfect unity and simplicity for every purpose of applied mechanics, and the widest generality of application:—"Nature is made to work by the simplest means; the design is uniform in that which we understand, and we look for simplicity and uniformity of design in that which we are endeavouring to make clear." Thus we want to ascertain by experiment what minimum velocity is required with force to produce its mechanical equivalent. Or, practically speaking, with a given pressure in the cylinders of a steam engine, what is the minimum velocity of piston to produce its maximum mechanical effect?

By the solution of this problem we shall then know the exact amount of work a given pressure can perform in a unit of time. If that work is to be doubled, then we may be certain that it cannot be obtained by any mechanical contrivance, a double pressure of steam being the indispensable and only alternative.

This theory is so manifestly correct, or so egregiously in error, that the trials of a single steamship are sufficient to test its accuracy. For this purpose the author desires no better test than the coefficients produced by the two formulæ employed by the Admiralty in their published *Results of Trials*; for, in the words of Lord Bacon, "Truth is more easily evolved out of error than confusion."

With respect to the most useful velocity of the piston of a steam engine, there is an old rule, which states that the square root of the stroke, multiplied by 120 per minute, is the most efficient velocity of the piston. Is this old-fashioned rule, which is an implied principle of the conservation of work, correct or not? Let the trials of the *Victory*, *Pioneer*, and *Flying Fish* (vessels identical in form) testify, where it will be observed that the coefficients decline as the velocity of the piston increases, and precisely in the same proportion. These are not isolated examples, but the accuracy of the above rule is amply confirmed by those vessels with the least velocity of the piston all exhibiting the highest coefficients.

Name of Vessel.	No. of Experiment.	Velocity in Knots.	$\frac{\text{Vel.}^3 \times \text{Mid-section}}{\text{I.H.P.}}$	$\frac{\text{Vel.}^3 \times \text{D}^3}{\text{I.H.P.}}$	Velocity of Piston.
					ft. Ψ sec.
Flying Fish.....	4	9.92	469	177	4.61
Flying Fish.....	5	11.20	443	167	5.12
Flying Fish.....	6	11.47	411	155	5.40
Flying Fish.....	3	11.73	376	143	5.62
Flying Fish.....	7	11.60	372	141	5.58
Flying Fish.....	2	11.29	341	129	5.96
Flying Fish.....	1	11.58	335	126	6.15
Victory.....	1	11.58	351	135	6.83
Pioneer.....	1	11.36	336	127	6.83

If the coefficients of those vessels diminish in such marked proportion with the velocity of the piston, what other conclusion can be come too than to adopt the pressure in the cylinders as the most reliable measure of the power exerted by the engine; whatever it may be termed, it is ostensibly the *living force* propelling the steam vessel. If the above facts are merely a coincidence, other trials of steamships may be found to disprove it; on the contrary, every performance of steamships in Her Majesty's service is an absolute confirmation of the truth of the conservation of the mechanical effect of force.

Again, such a principle is one of the easiest to confirm, or to prove false; one of the axioms of that theory being, that the mechanical effect of force can neither be created nor annihilated by any mechanical contrivance; and when adopted in connection with steamship propulsion, the amount of force produced by Colonel Beaufoy's formula is the only and absolute amount of force required in steam vessels for any rate of velocity.

To prevent any misconception of the author's definition of the force to be employed, or the resistance encountered by the vessel, he begs to state that it is the pressure in the cylinders of the steam engine that varies as the square of the velocity, and that the resistance is the propelling pressure on the screw shaft of a steam vessel that varies merely as the speed, the absolute minimum quantities being as follows:—

Resistance lbs. = Mid-Section × Velocity in feet per second.

Pressure in Cylinders = Resistance × Velocity.

or

Pressure in Cylinders = Area × V² feet per second.

It only remains to test the theoretical quantities by the performances of the despatch vessels in Her Majesty's service, vessels built expressly for the highest rate of speed, the hulls designed by the first naval architects in the world, and the engines and propellers by makers unrivalled in the profession of marine engineering. With such advantages, the theory of this paper must be severely tested, and the truth or fallacy of the principle elicited. Therefore, if we examine the following data, it will be found there is a very slight variation between the theoretical and actual pressure in the cylinders; consequently, we have the most unequivocal proof of the truth of the proposed principle, as well as the absolute quantities for any rate of velocity of steamship, and, at the same time, the complete solution of the problem of fluid resistance.

Name of Vessel.	Velocity of Vessel.	Midship Section.	Theoretical Pressure in Cylinders.	Actual Pressure in Cylinders.	Ratio of Actual to Theoretical Pressure.
	ft. P. sec.		lbs.	lbs.	
Flying Fish—Experiment 4	16.76	277	77,837	68,791	1.12
ditto ditto 5	18.92	277	99,792	94,305	1.04
ditto ditto 6	19.26	277	102,767	103,512	.98
ditto ditto 3	19.77	272	106,352	114,188	.96
ditto ditto 7	19.60	277	106,368	114,400	.96
ditto ditto 2	19.09	274	100,010	106,576	.94
ditto ditto 1	19.43	281	106,218	116,466	.94
Victor	19.43	264	99,792	93,886	1.06
Pioneer	19.09	273	99,645	95,988	1.02

It now becomes necessary to point out that, however carefully the experiments of steamships may be conducted, it must be from principles fairly established by induction that the theory of fluid resistance can be established—the only assistance such data can afford, is confirming the deductions of theory. Thus, if it can be established by such trials, that the pressure in the cylinders can be reduced by the combined increase of velocity of piston, and the form of vessel; such a fact would be fatal to the theory of the constancy of the mechanical effect of force. On the contrary, it will be observed, on perusal of the above trials, that the ratio between the actual and theoretical pressure in the cylinders is not diminished in the slightest degree, by either the increasing velocity of the piston, or the form of vessel; but rather in the other direction, the variation in the velocity of the piston in these trials varying from 4.61 to 6.83 ft. per second, or nearly 50 per cent.

The author cannot conclude without citing some authorities well known

in connection with mechanical science in favour of the general principle of this paper. It is adduced by Professor Whewell, in his *History of the Inductive Sciences*, as a great step in the advancement of industrial mechanics, viz., "Among these, I (Prof. Whewell) may mention a new abstract term, introduced because a general mechanical principle can be explained by it, which has lately been much employed by the mathematical engineers of France, M.M. Poncelet, Navier, Morin, and others. The abstract term is *travail*, which has been translated labouring force; and the principle which gives it its value, and makes it useful in the solution of problems, is this—that the work done (in overcoming resistance or producing any other effect) is equal to the labouring force, by whatever contrivance the force be employed. This is not a new principle, being, in fact, mathematically equivalent to the conservation of *vis viva*; but it has been employed by the mathematicians of whom I (Prof. Whewell) have spoken, with a fertility and simplicity which make it the mark of a new school of the mechanics of engineering."

Expressed in a few words, this principle may be called the proportionality of forces to their mechanical effects, and is, in fact, only another definition of the well-known axiom "that a machine can never diminish the total expenditure of power necessary to overcome any resistance."

With respect to the theory of fluid resistance, and the celebrated problem of the solid of least resistance, we have the undoubted authority of Sir Isaac Newton, in Lemma 7, and Scholium to the 37th Proposition of his *Principia*, that the resistance of a globe, or pointed body, is as great as that of its circular base; that, however repugnant to our ideas such a principle may be, his solution has been attacked by the most eminent philosophers since his time without success; hence the absolute necessity and importance of the 28th subject proposed by the Institution of Civil Engineers.

Now, when we consider the many important discoveries in both celestial and terrestrial mechanics, and in mathematical science, made by our most eminent philosopher, it would be impossible to come to the conclusion that he has erred in this single instance, but would rather think that he has pointed out the only method by which the theory of fluid resistance can be permanently established.

After an examination of the many fruitless attempts that have been made to discover the solid of least resistance, Professor Robison, in his dissertation on fluid resistance, has come to the same conclusion, that the theory will be best advanced if we follow in the steps of such a philosopher. He states, "We must discover some method of determining, *a priori*, what will be the motion of a fluid whose course is obstructed by a body of any form. And here we cannot omit taking notice of the casual observation of Sir Isaac Newton, when attempting to determine the resistance of the plane surface, or cylinder, or sphere exposed to a stream moving in a canal. He says that the form of the resisting surface is of less consequence, because there is always a quantity of water stagnant upon it, and which may therefore be considered frozen; and he therefore considers that water only whose motion is necessary for the most expeditious discharge of the water in the vessel. He endeavours to discriminate that water from the rest; and although it must be acknowledged that the principle which he assumes for this purpose is very gratuitous, because it only shows that if certain portions of the water which he determines very ingeniously, were really frozen, the rest will issue, as he says, and will exert the pressure which he assigns; still, we must admire the fertility of resource, and his sagacity in thus foreseeing what subsequent observation (the previous trials) has completely confirmed. We are even disposed to think that, in this casual observation, Sir Isaac Newton has pointed out the only method of arriving at a solution of the problem; and that, if we could discover what motions are not necessary for the most expeditious passage of the water, and could thus determine the form and magnitude of the stagnant water which adheres to the body, we should much more easily ascertain the real motions which occasion the observed resistance."

In a strictly practical view, there remains many imperfections in this theory. We must have a suitable form in steam vessels, to create a minimum disturbance in the water for the efficacy of the propelling instrument, more especially for the screw propeller, which, in a bad formed after-body, would be in that stagnant or frozen water following the vessel, well-known to every practical mechanic.

Therefore, in the words of the previous quotation, "if we could determine the exact form and magnitude of the stagnant water which adheres to the vessel," and form the vessel in accordance with it, we shall then have the propeller in water not subject to any disturbing action by the passage of the vessel, and obtain a vessel of the greatest practical utility.

It will now become evident that, the greater the velocity of the steamship, the "stagnant or frozen water" will be increased lengthwise; consequently, to produce a form of vessel for the efficiency of the propelling instrument, we must have long bows for paddle wheels or side propellers, and long after-bodies for screw vessels. This principle is in strict accordance with the experience of our most eminent shipbuilders. Still, after the naval architect has done his best to imitate "the form and

magnitude of the stagnant water," it is an indispensable requirement for the engineer to find a pressure of steam, &c., in the cylinders equal the midship section, multiplied by the required velocity, squared in feet per second; it is the absolute theoretical minimum which neither art nor ingenuity can diminish.

Notwithstanding these practical defects in the theory of fluid resistance, in connection with side and screw propellers, as laid down by Sir Isaac Newton in his *Principia*, 37th proposition, we cannot but admire the efforts and sagacity of this great philosopher, who, after having discovered so many sublime truths of a mechanical nature, has traced out the only theoretical path, and, when followed in connection with his laws of motion, may be the means, let us hope, under the auspices of the Institution of Civil Engineers, or the Royal Society, of obtaining a permanent solution of this hitherto difficult and important problem in the mechanics of engineering.

SAXBY'S IMPROVEMENTS IN THE METHOD OF WORKING RAILWAY POINTS AND SIGNALS.

(Illustrated.)

We have previously had occasion to notice in the pages of THE ARTIZAN some of the ingenious and valuable contrivances in connection with railway signalling apparatus, &c., which have been invented and put into successful operation by Mr. John Saxby, of Brighton. It now affords us much pleasure to speak of another very valuable invention of Mr. Saxby's, which has been found, after a lengthened trial, to work most efficiently under every variety of circumstances.

one hand lever is caused to operate as may be desired upon any other lever or set of apparatus, whether for working points or signals. For this purpose, there is placed between each hand lever, or in any corresponding and suitable part of the mechanism, a vibrating bar, plate, or lever, having a stop either in the form of a wedge or inclined projection on the face thereof, and working at or near to one end on a stud or centre, whilst the other end is connected to a rod or bar, which, in turn, is connected to any other similar vibrating bar, or to several of them, each having a similar stop or stops on its face or edge. Now, on moving a given hand lever back or forward, it comes in contact with or retreats, and thus causes the vibrating bar between it and the next hand lever to move in one direction or the other; and thus, whilst its position and value as an agent is determined by the angle it is caused to make, it in turn acts upon the other vibrating bar or bars with which it is connected; and, as the hand lever which is worked passes the projecting stop on its respective vibrating bar, the projecting stop or stud of each of the other vibrating bars is opposed to the hand lever, or brought in front or at back thereof, as the case may be; and, by this means, they are automatically stopped, or secured from being moved, or released, or set free, as the case may be; and when several hand levers of the sets of apparatus have been connected, so as to be acted upon by one, then any of the number being worked by hand acts upon the single lever of the connected set, or *vice versa*. Figs. 1 and 2 represent the arrangement of apparatus just described. Fig. 1 being the plan of the arrangement of levers, &c., as seen from above; and, Fig. 2 the plan of the same apparatus as seen from below. Fig. 3 is a plan view of another arrangement of apparatus, wherein parallel sliding bars having T and L shaped projectious, one sliding bar working over the other, are substituted for the arrangement of apparatus just described, and for effecting the same objects.

FIG: 1.

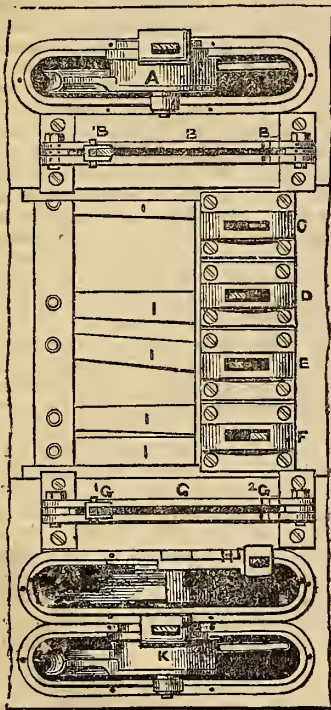

FIG: 2.

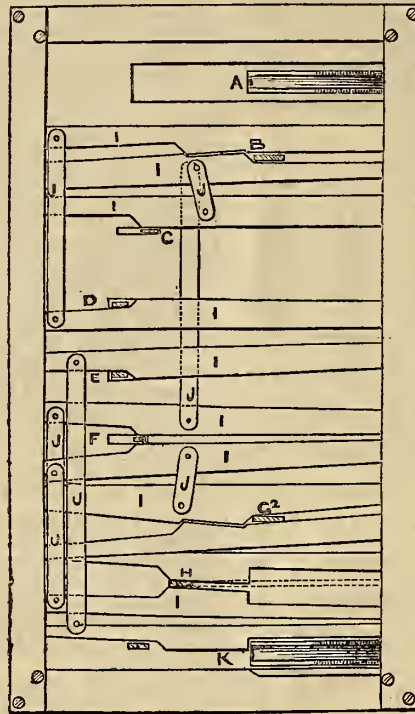
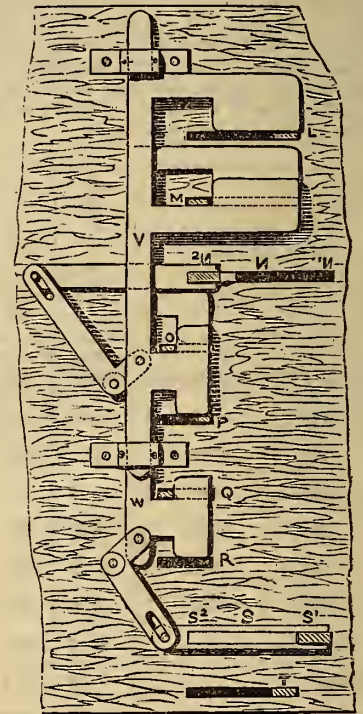

FIG: 3.



The great merit in Mr. Saxby's present invention consists in this—viz., that, by its use, it is impossible for a contradictory signal to be given; or for the points to be contradictory to the signals, or to each other. For, instead of having to trust to taking "off" a signal, or closing a point singly and by hand when another signal has been put "on," or another point has been closed, or *vice versa*, &c., in each case where the points, or the signals in connection therewith, have to be attended to separately,—Mr. Saxby, by his present invention, so pre-arranges, connects, and thus governs the working of any number of points, and the signals connected therewith, or belonging thereto, by the act of working one hand lever, or any greater number of hand levers; so that when one set of points is opened, all that should be closed whilst that set is open, have the hand levers and apparatus belonging thereto locked or secured, and when this set of points are in their turn closed, those that should be open, or be free to be opened, have their hand levers set free; and, in like manner, the moving of any

INSTITUTION OF CIVIL ENGINEERS.

March 5, 1861.—GEORGE P. BIDDER, Esq., PRESIDENT, in the Chair.

DESCRIPTION OF A PIER ERECTED AT SOUTHPORT, LANCASHIRE.

By MR. H. HOOPER, Assoc. Inst. C.E.

This pier was constructed at right angles to the line of promenade facing the sea, on an extensive tract of sands reaching to low water, a distance of nearly one mile. Its length was 1200 yards, and the breadth of the footway was 15ft. At the sea-end there was an oblong platform, 100ft. long, by 32ft. wide, at right angles to the line of footway. The superstructure was supported upon piers, each consisting of three cast iron columns, and each column was in three lengths. The lowest length, or pile proper, was sunk into the sand to the depth of 7ft. or 9ft. These piles were provided at their bases with circular discs 18in. diameter, to form a bearing surface. A gas tube was passed down the inside of each pile, and was forced 4in. into the sand; when a connection was made with the Water Company's mains, a pressure of water of about 50lbs. to the inch was obtained,

which was found sufficient to remove the sand from under the disc. There were cutters on the under side of the discs, so that, on an alternating motion being given to the pile, the sand was loosened. After the pressure of water had been removed about five minutes, the piles settled down to so firm a bearing that, when tested with a load of 12 tons each, no signs of settlement could be perceived. The upper lengths of the columns had cast iron bearing plates, for receiving the ends of the longitudinal lattice girders, each 50ft. long and 3ft. deep. The centre row of girders having double the duty of the outside ones, top and bottom plates were added. The weight of wrought iron work in each bay was 4 tons 5 cwt., and of cast iron work 1 ton 17 cwt. The second bay from the shore was tested by a load of 35 tons, equally distributed, when the mean deflection of the three girders, in 24 hours, was $1\frac{1}{2}$ in., and there was a permanent set of $\frac{1}{2}$ an inch, on the load being removed.

The advantages claimed for this mode of construction were—1st. Economy in first cost, especially in sinking the piles, which did not amount to more than $4\frac{1}{2}$ d. per foot. 2nd. The small surface exposed to the action of wind and waves. 3rd. Similarity of parts, thus reducing the cost to a minimum. 4th. The expeditious manner of obtaining a solid foundation—an important matter in tidal work. 237 piles were thus sunk in six weeks.

The estimated cost of the pier and approaches was £10,400. The works had been completed for £9319, being at the rate of £7 15s. 4d. per lineal yard. The pier was designed by Mr. Brunlees, M. Inst. C.E., and the superintendence of the construction was entrusted to the author, as resident engineer, Messrs. Galloway being the contractors.

ON THE CONSTRUCTION OF FLOATING BEACONS.

By MR. BRINDON B. STONEY, Assoc. INST. C.E.

The various forms of floating beacons hitherto employed were first referred to, including, among those whose axis of symmetry was horizontal or oblique, the Barrel and the Can Buoys; and among those whose axis of symmetry was vertical, of which the cone might be considered the typical form, the Bell Beacon of Liverpool, the Nnu Buoy, and the Egg-bottomed Buoy. All these buoys were characterised by want of conspicuousness and by instability. These defects had, however, been greatly remedied by Mr. Herbert's Cone-bottomed Buoy (*vide* Min. of Proc., Inst. C.E., vol. xv., p. 1). In this arrangement it was originally proposed that the mooring-chain should be attached either to the centre of gravity, or to the centre of the plane of floatation. But this was said not to have been attained in practice, as the mooring-chain was fastened to a point nearly half-way between the plane of floatation and the lower edge of the buoy, and considerably below the centre of gravity. If it were fastened to the centre of the plane of floatation, the author believed the buoy would become much inclined, under the influence of currents, in the opposite direction to the current, from the lateral pressure being below the centre of mooring, in place of above it, as was usually the case.

Being aware that additional keels, or bilge boards, tended to prevent ships of certain forms from rolling, by the inertia of the mass of water constrained to move along with the ship, and that advantage had been taken of this circumstance in some light ships, the author suggested that a similar arrangement might be applied to a floating beacon, and the result was the Keel Buoy. The superstructure might be of any of the ordinary forms, the dome-shape being preferred for conspicuousness. The sides were prolonged below the bottom so as to form a circular keel, within which a large body of water was contained. Thus, a buoy 6ft. diameter, and with a keel 18in. in depth, would contain a mass of water weighing about one ton, or the same weight as the buoy. The bolt of the mooring-chain, where it passed through the mooring-ring, divided the surface exposed to lateral pressure into equal, or nearly equal portions. Hence, the Keel Buoy would float erect in tideways or river currents, as an equal pressure was exerted both above and below the centre of mooring. The keel also gave this buoy a greater hold in the water, and the tendency to pitch was diminished. It also acted as ballast placed in the best position to secure stability. In consequence of the peculiar form of the Keel Buoy, and of its stability, the superstructure might be 25 per cent. higher than that of other buoys of equal diameter, with the same configuration above the water. The mooring-ring had a shank which projected through an aperture in the wrought iron bottom. It was firmly rivetted on the inside of the bottom, so that the straining of the chain could not tear it away, or loosen the rivets. The author believed that in the Keel Buoy there was a greater freedom from abrupt motion than was possessed by other floating bodies having the same amount of displacement. If a buoy were made very wide in proportion to its height, and with slight immersion, it would float upright, because it would float like a board on the surface of the water; but stability thus gained would be at the expense of manageableness. If, on the other hand, stability was sought for, not by breadth of beam, but by ballasting the bottom, the buoy would not only be unwieldy but expensive. The Keel Buoy was light, was easily handled, and, on board ship, only occupied so much room as was sufficient for it to stand on end; thus contrasting favourably with the can and egg-bottomed buoys.

In the course of the discussion, a regret was expressed that the paper contained no details of the experience of the use of the Keel Buoy, and that there was so little additional information to what had been given in Mr. G. Herbert's paper, in 1855. It was contended that it was incorrect to call the circular prolongation of the casing "a keel;" that no comparison could be fairly instituted between such a casing and the usual bilge pieces, and that what was called the keel could not have the material effect attributed to it by the author. Also, that the Keel Buoy was so trifling a modification of the Cone-bottomed Buoy, introduced by Mr. Herbert, as not to be entitled to any great degree of merit; and that the latter was the stronger form of construction, as the strain of the mooring-chain would be upon the cone, whilst in the other it must be resisted by the flat diaphragm, or bottom of the buoy. The Cone-bottomed

Buoy was extensively employed by the Trinity Corporation, as well as by foreign Governments, and only two instances were known where such beacons had been injured by breaking from their moorings, and then they were destroyed by being thrown among rocks. At Liverpool, buoys so constructed, 20ft. in diameter, and standing 20ft. out of the water, safely rode out the late gales, and on no occasion had there been the slightest failure in that respect.

The beacons made use of by Admiral Sir Edward Belcher, in the survey of the western coast of Africa, were likewise alluded to. A cask of 60 gallons had a spar driven through it, which projected 3ft. on the upper side, and 9ft. below. To the upper end a topmast was fitted, and the lower end of the spar was ballasted in such a way that the beacon always maintained a perfectly erect position in very strong currents and tides.

ON THE RESULTS OF TRIALS OF VARIETIES OF IRON PERMANENT WAYS.

By MR. F. FOX, M. INST. C.E.

The author stated that he did not wish to be thought an advocate for the superiority of either of the systems tried over other plans, or of iron over timber for permanent way, under any and all circumstances; his object being merely to record the results of actual trials, and the conclusions to which they led.

In 1853, an experimental length of a quarter of a mile (double line) of iron way, on the principle of Mr. I. J. Macdonnell (M. Inst. C.E.), was laid on the Bristol and Exeter Railway. It consisted of a continuous rolled iron rail bearer, weighing, on an average, 83½lbs. per lineal yard, and 11in. in width. The bearers were united by joint or saddle plates, 30in. in length, weighing 50½lbs. each. The bearers had a rise in the centre of $\frac{1}{16}$ of an inch, and a rib or tongue was rolled on the upper side, which fitted approximately into the hollow of the bridge rail. The rails originally laid weighed only 53½lbs. per yard. Between the rail and the bearer a thin packing of pine wood was placed, the grain being in the direction of the length of the rail. The rails, the bearers, and the joint plates were bolted together, the distances between the intermediate bolts being so arranged as to admit of a rail being readily turned by unscrewing the nuts, or of a new rail being put in, without "opening out" the ballast. Transoms, or cross ties of angle iron, were placed at average intervals of 12ft. between the two rails, and of 24ft. between the two lines. This system differed from the Barlow way, in having the rail or wearing surface separate and easily removable from the bearing surface; but, on the other hand, it considerably exceeded the Barlow rail in weight. After a wear of more than seven years, this length of iron way was in good condition, and bid fair to continue so for some time to come. About one-third of the rails proved defective within the first two years, and had been replaced by rails weighing 60lbs. to the yard. The ballast, which was very indifferent, being a loamy gravel, had been well drained, and thicker packing, laid with the drain transversely to the direction of the rail, had been introduced. The bearers and joint plates, transoms and rails, were supplied at £7 per ton delivered, and the cost per single mile of this arrangement, exclusive of the cost of matching and laying, was £1,936. The cost of a single mile of the longitudinal timber way, at the same period, taking the rails at the same weight and price, was estimated at £1,850. It should be mentioned that iron was then low in price, whilst timber was high. Owing to the undue lightness of the rail, both of these calculations were below the cost of a well-constructed permanent way.

As this experiment appeared on the whole to have been successful, it was determined to extend the rail, by laying one mile of double line, on this system, at a further distance from a station, so that all the trains should pass over it at full speed. Some modifications were, however, made. The width of the bearer was increased to 12in., and its thickness was reduced to 9-16ths of an inch, so that its weight was 75lbs per lineal yard. At the same time the curvature was slightly increased. The pine packing (creosoted) was thicker, and at the rail-joints, pieces of hard wood, laid with the grain lengthwise, were substituted. The rails weighed 68lbs. per yard. The contract for the bearers, joint plates, and transoms was taken at £9 10s. per ton, the cost of the rails being £9 8s. 8d. per ton. This length was laid in July, 1857, where the line had not long before been re-ballasted with hard clinker ballast. The cost of a single mile, exclusive of laying, amounted to £2,511. One mile of timber way, laid with the same section of rail, at the same time, cost about £2,254.

As these trials appeared to give a reasonable expectation of the greater durability and diminished cost of maintenance of the iron way, the author felt justified in recommending a further trial, on a more extended scale, and on different districts of the railway. As the rolling and straightening of the curved section of bearer was alleged to be difficult, it was decided to adopt a flat section. The bearing surface was increased to 13in., the centre rib was rolled half an inch deeper, and the weight was thus brought up to 84lbs. per yard. Rail joint plates of a similar section to the bearer joint plates were bolted underneath the bearer at every rail joint. Although this addition had been found advantageous, the way was still weaker at the rail joints than at any other part. Additional intermediate bolts were used, so that the upper and the lower sections of the way were held together as a girder. The contract for the bearers, joints, and transoms was taken at £9 12s. per ton, and the rails being £8 13s. 1d. per ton, the cost per single mile was £2,571.

In order to test the comparative strength of the different sections of Bearer, of Rail and Bearer combined as laid, and of the Rail and Bearer Joints, with and without joint plates, a series of experiments was made, the results of which were given in a tabular form. The distance between the points of support was 5ft. Of the three sections of bearer only, that of 1853 (the first) showed the least, and the flat section of 1859 the greatest deflection, under a load of about 5 tons; but in each case the ultimate strength did not exceed 7 tons. Of the three sections of iron way complete, that of 1853 was the weakest, and the curved section of 1857, with a rail weighing 68lbs. per yard, rather the strongest. The ultimate

strength was reached under loads varying from 19 to 21 tons. An experiment with the flat bearer showed, as was expected, the increased stiffness gained by placing the centre rib downwards, thus practically deepening the girder. The ultimate strength of the timber way was ascertained to be $2\frac{1}{2}$ tons, or 50 per cent. higher than the iron way. It was, therefore, determined still further to increase the section of the iron bearer. In this case the width of the bearer was 12 in., and it was stiffened by a web underneath 3 in. deep, and three quarters of an inch thick (a plan which was claimed by Mr. W. Bridges Adams). The weight was reduced to 76 lbs. per yard, and the contract for this section was taken at £9 per ton. To stiffen the rail joints (which had no plates underneath) and to secure the ends of the rails, an iron plate having a tongue rolled on it was used. This section of way had been laid too short a time to warrant any decided expression of opinion of it, as compared with the other sections; but as a length of between 4 and 5 single miles was under trial, it would soon be seen if it possessed any advantages. It was perceptibly stiffer to travel over, and the middle web gave it a firmer hold in the ballast than either of the other sections. The cost of a single mile was £2385. This section was the fourth modification of rolled iron bearer under trial, the entire length being $14\frac{1}{4}$ single miles.

The partial failure of the Macdonnell way on the Bridport Railway was then referred to; and it was asserted that it arose from the rails and bearers being too weak, and from a disregard of those appliances which the character of the gradients, curves, ballast, and subsoil rendered more than ordinarily necessary.

In May, 1858, a trial length, of a single half mile, of the cast-iron sleeper way of Mr. De Bergue, was laid in immediate continuation of the Macdonnell way, and on the same kind of clinker ballast. Whilst still preferring a continuous rolled iron to any cast iron way, the author felt bound to state that not a single sleeper had been broken, the nuts of the bolts did not work loose, the rails were very well, and, with the exception of a little depression at the fished rail joints, the line kept as good a "top" as could be desired, and was as easily maintained, but it was more rigid. The cost of this arrangement per single mile was £2108, or £800 per mile less than the Macdonnell way of the same period.

The merits and defects of the continuous rolled iron permanent way were thus stated. The defects, or supposed defects, appeared to be:—1. The great cost, at present prices, almost precluding its adoption on a railway of limited capital. 2. The difficulty of getting the bearers rolled. 3. The possible increased wear of the rails. 4. The greater "wash" of all but very good ballast, inseparable from all iron ways, resting on or near the surface. And 5. The difficulty of laying on sharp curves, and of keeping in place when laid. Its presumed merits were:—1. Greater economy in the long run, owing to increased durability. It was estimated that the cost of renewal of the longitudinal timber way was £45, and of the iron way only £21, per single mile per annum, or less than half, without reckoning the considerable item of labour in the replacement of the timbers. 2. Saving in maintenance, and facility for packing, owing to no "opening out" being required. 3. The safety of the iron way, especially as contrasted with a timber way which had been long laid. 4. The facility of exchanging worn rails. 5. The preservation of correct gauge. 6. The lowness of the crown of the rail above the bearing surface. 7. Saving in the depth of ballast in the case of a new line. And 8. The equableness of the motion, rendering it probable that less injury would be sustained by the rolling stock.

DISCUSSION.

It was observed, that the systems of permanent way described in the Paper did not differ materially from the continuous iron way proposed by Mr. Reynolds many years ago, which had been tried and failed. Looking to the effects of frost, floods, and heavy rains, and to the great variations in the quality of the ballast, a continuous flat iron plate laid on the surface was never likely to be successful in carrying heavy locomotives at high speeds. For a long time to come, either the transverse sleeper or the longitudinal timber systems would probably be used, as they were not liable to be so much affected by the settlement of embankments, from whatever cause arising, the washing away of ballast, or the effects of frost. There might be occasions when it would be desirable to adopt some other mode than laying the line upon wood; as, for instance, when time was an object, and timber could not be obtained so quickly as iron, nor yet perhaps so cheaply. As the prices of materials varied very much, at different times, comparisons of costs were practically valueless. The permanent way of railways ought to be the most perfect in construction, and the most conducive to safety and to ease in travelling, whatever might be its cost. It was wrong to continue to use the same sizes of sleepers and scantlings of timber that were first employed, as the engines were now thrice the weight, and the speed had been doubled. To make a road fit for the description of locomotive and rolling stock at present in use, and to travel at the same speed, at least double the sum ought to be expended. The permanent way and the rolling stock could be made so as to be as safe for speeds of 70 miles as of 30 miles an hour; it was merely a question of money, there being no mechanical difficulty about it whatever.

It was said, that the conclusion to be drawn from the summary of advantages and disadvantages which had been most fairly stated by the author, was the complete condemnation of iron permanent way. There was no advantage in first cost, and the maintenance was certainly more expensive than with a timber road, which would be free from the disturbances likely to affect the iron way laid upon the surface of the ground. There was also greater rigidity, and this told in two ways—first, upon the "life" of the rails—and secondly, upon the rolling stock. The other systems of permanent way might be divided into three classes: 1st, longitudinal timbers with a bridge-rail or a modification of it; 2nd, transverse sleepers, with a double-headed rail and chairs; 3rd, transverse sleepers, with a bridge rail or a modification of it. The latter system was well adapted for light traffic, was inexpensive, and easily maintained. Either of these roads, when properly constructed, would enable the highest speeds required in a commercial country, to be attained with safety.

Attention was then directed to the comparative difference in the wear and tear of rolling stock and of rails upon a rigid road, and on a road that was more

elastic; and the many tyres broken during the late frost, though no doubt in some cases attributable to an indifferent quality of metal having been used, had been caused, it was asserted, in many instances, by the rigidity of the permanent way.

It was stated, that the Reynolds' way consisted of a continuous cast-iron trough, very different in principle to the flat wrought-iron sleeper described in the Paper; in which the results of experience, on one of the best maintained lines in the kingdom, had been given, speculative opinions having been carefully avoided. The different roads alluded to by the author had been observed to keep in good condition, in all weathers and under all circumstances; and the testimony of careful engineers, who could generally point out any radical defects in the permanent way, was in favour of this form of iron way as compared with the longitudinal timber system. At the same time it was admitted, that there were serious difficulties to be overcome in every form of iron road yet proposed. It was important that the system of permanent way adopted on each railway should be capable of being laid throughout the whole length of the line, and of being carried through stations. It was doubted whether the continuous wrought-iron way was applicable in stations, or where there were points and crossings. The De Bergue cast-iron sleeper presented greater facilities in this respect, but a road laid on these sleepers had not the flexibility of a timber road. One of the things which gave the greatest trouble in most kinds of permanent way was the movement of the rail in its bearing. This was prevented in the De Bergue system, as the sleeper was bolted firmly to the rail, and formed, in fact, a bracket or extension of it. In a timber road this evil might be much diminished by reducing the number of fastenings and in this respect the ordinary single-headed contractor's rail, fastened direct to transverse sleepers, without chairs, was to be commended, as being simple, inexpensive, and effective.

It was contended, that practical men in charge of railways invariably preferred transverse sleepers to longitudinal timbers, and it had been found that, upon the whole, the annual expense of maintenance was less with the former system. Thus, upon the road between York and Darlington, which was laid upon transverse sleepers, the joints of the rails being "fished," two miles were maintained for the same sum that it cost to maintain one mile and a half on the longitudinal timber system. The rigidity of the permanent way during frost was due very much to the want of thorough drainage in the road. By the use of creosote, the "life" of a sleeper was not terminated by its decay, but was dependent upon the period it would bear the usage it was subjected to. If the permanent way had to be constructed without reference to economy, which had not been the case hitherto, then no doubt great improvements would be made. It had been found advantageous to seat the double-headed rail, when using the ordinary chair, on a cushion of wood, endways of the grain. This plan prevented the indentation of the underside of the rail, and the motion of the trains over the line was easier. Steeling the surface of the rails had also proved very beneficial. The cost of applying this process did not amount to more than fourteen shillings per ton, and the durability of the rails was at least doubled, as compared with rails made in the ordinary manner.

It was mentioned, that the plan of placing a wooden cushion in the chair under the double-headed rail had been tried many years ago on the London and Birmingham line, and was not found advantageous, as, unless frequently renewed, the rails wore through them. In England, the double-headed rail was almost universal, except on the Great Western and a few other lines; but on the continent of Europe and elsewhere, a deep or broad-bottomed flange rail was most generally used, and it was to be remarked, that these lines had been constructed after experience had been gained in this country, and in many cases under the direction of English Engineers. From this it was inferred, that the use of the chair, which had hitherto constituted the great difficulty with double-head rails, would in future be avoided. In forming the seat for the chairs, the scantling of the sleeper, which, in most cases, was already too small, had to be still further reduced, so that where the greatest strength was required in the support there was the least. Attention was then called to Mr. Seaton's system, in which a saddle rail, laid on the apex of triangular timbers, forming a continuous bearing for the rail, was employed. Immediately under the joints of the rails a plate was bedded into the timber by pressure, so as to make the joint equally solid with the other parts of the line. This road had been laid on the London and North Western (at Bletchley), on the South Western, and on the Great Western Railways; and it had been found that the first cost was something less than the double-headed rail system.

It was considered, that as regarded cast and wrought-iron roads, as far as experience had gone at present, both had proved unsuccessful. The addition of an elastic medium between the support and the rail, as described in the Paper, might, however, be the means of lessening the rigidity, and thus removing the great defect hitherto attaching to iron roads.

It was remarked, that engineers were now aware that a certain amount of elasticity was necessary in the permanent way of railways. Experience seemed to prove, that the transverse sleeper road, with the joints of the rails "fished," was the best; and that if chairs could be dispensed with, it was advisable; but the means of fastening the foot-rail to the sleeper were not what could be desired. It had been ascertained, that during the frost there was less destruction to the rolling stock on lines that were fished, than where that was not the case. With reference to the mode of fishing recently on two short lines, where a flat-bottomed rail weighing 62 lbs. to the yard had been employed, the rail joint had in one case been "fished" to the sleeper, and in other the fish was suspended; when it was found that the difference was in favour of the fish attached to the sleeper.

It was said, that all the forms of cast-iron sleepers yet tried were unsuitable for many kinds of ballast, such as hard broken stone, flint, or other unyielding materials; and that it was doubtful whether wrought-iron bearing plates laid on that description of ballast would form a pleasant road to travel over, unless an elastic medium were introduced between the rail and the bearer. Several objections were taken to the continuous rolled-iron rail-bearer for instance

that in passing round curves and at stations, amongst points and crossings, it would be difficult to bend the bearer laterally in the same degree as the rail, and to match the lengths of the rails, and the bearers, so as to make the bolt holes always correspond, and thus avoid the necessity for drilling fresh holes. The best form of transom for the longitudinal way was asserted to be a flat bar of iron, placed vertically, so as not to take a bearing on the ballast, leaving that duty to be borne by the bearer; or otherwise, when the road got out of order, a series of jerks was produced on travelling over the line, in consequence of the increased resistance at these points. It was contended, that though the use of iron as a rail-bearer was still in its infancy, yet in this land of iron it was fair to conclude, that improvements would be made in its application to this special purpose, and that iron ways would ultimately become the rule rather than the exception.

The statement, that whilst the weight of engines and trains, and the speed of travelling, had been increased, the permanent way had not been proportionately improved, was thought to be capable of some modification. Twenty years ago, locomotive engines averaged 15 tons in weight, supported on four wheels; now the weight was doubled, but there were six wheels, and the greatest weight on the driving wheels rarely exceeded 12 tons. In the same time, the running speed, which was what told on the permanent way, had not been increased more than 25 per cent. On the other hand, looking to the permanent way itself, the rails now in use, taking the London and Birmingham line as an illustration, weighed 84 lbs. to the yard against 65 lbs. at the former period, and the chairs 45 lbs. instead of 25 lbs. each. There was also one more sleeper in each rail length, and the joints of the rails had been strengthened by the addition of "fishes." Only a small proportion of the unfortunate accidents that had occurred on railways of late years could be attributed to weakness of the running road. They seemed rather to be due to the giving way of some part of the rolling stock. On these grounds, the asserted insufficiency of the present permanent way, and the necessity for doubling the cost at the outset, were disputed.

In reply to the observations which had been made it was remarked, that the greater portion of the iron ways alluded to in the Paper had been in use eight years, which, although perhaps not a sufficient time to allow of a decided opinion being expressed, was surely enough to enable some opinion, founded on experience, to be given. It had been said, that the systems described by the Author had been tried and rejected upwards of twenty years ago, and Reynolds' hog-trough cast-iron sleeper, was cited as a case in point. Now, the continuous rolled-iron rail-bearer only resembled that plan in this respect, that iron and wood entered into the composition of both systems. Mr. Reynolds' sleeper was a rigid continuous trough of a V shape, bolted at the joints, and absolutely inflexible, although the hollow was filled with a wooden cushion; whereas the rolled iron way was only too flexible. It was urged that, speaking from speculation and not from experience, Mr. Greaves' cup-sleepers might be condemned, as there was rigid iron resting on sleepers of the same material, placed immediately on the ballast. It was said, by engineers who had tried them, that they gave a great deal of trouble, and that the sleepers sucked up water from the ballast. There was a great difference between flexibility and compressibility. The term rigid had been frequently made use of in the course of the discussion. From experiments it could be shown, that between 5-foot bearings, the double headed rail deflected less, and was more rigid, than the Macdonnell system; but as the double-headed rail was placed upon timber sleepers, forming a compressible cushion, it was not rigid; and for the same reason, the rail on the Macdonnell system being laid on a cushion of wood, which it might be desirable to increase, was not rigid in the sense of flexibility. In fact, the forms first tried were too flexible, and that had led to the use of the T section bearer. It could be stated as a fact, that the maintenance of the Macdonnell system on the Bristol and Exeter Railway cost less than the other portions of the line, in the proportion of about half a man per mile. Taking that at £20 per annum, it would be equivalent to the interest upon the additional outlay at the first outset. With regard to the action of frost upon the iron way, it was admitted that was one of the difficulties of the system, where the ballast was bad, and the line was not well drained. But upon clinker ballast no difficulty of that kind had been experienced, although on another part of the line, where the ballast was composed of particularly bad gravel, it had given some trouble. In reference to Mr. Seaton's road, it was feared that it would be liable to work loose at the joints; and although, looking at the way the timber was cut to form the continuous bearing, it appeared at first sight an economical mode, yet the edges of the timber were liable to be destroyed, and then the width of the bearing would be practically reduced. The difference between the Barlow rail and the Macdonnell system consisted in the interposition of the elastic cushion between the rail and the bearer in the latter; when that was removed, the bolts worked loose. The rails could easily be replaced when required; but they had not been observed to wear out faster upon the iron way than upon the timber way. The rails and the bearers were punched at regular intervals, so that in putting in a new rail, it could never be necessary to do more than cut off a short piece at the end; and as to the drilling, it did not cost more than one penny per hole, which would only amount to a small sum per mile. The system had been laid upon a curve; and in that case the difficulties which had been suggested were got over by making the bearers in short lengths, and having a greater number of joints. Many of the bearers were bent in the rolling process, and these were selected for the curves. As to the transom taking a bearing, that was not the case, because the transom was hollowed out. A T rail transom was preferred to a thin bar, because if the latter received a side blow, it would be likely to draw in the gauge. The different systems of iron way which had been tried over several years, were so far not a failure, that they might be pronounced to have been, to a considerable extent, successful.

In concluding the discussion, credit was given to the author for the candid, practical spirit brought to bear upon the subject. At the same time it was thought, that iron permanent way—at the present moment, at all events, was

not one which could be safely recommended. All roads laid upon embankments, or in cuttings, were liable to subsidence, in a varying degree. It was impossible to believe,—having a due regard to economy and efficiency, and to the fact of engines weighing 30 tons, travelling at from fifty to sixty miles an hour, under all the extremes of weather, of wet and of frost,—that any system of permanent way could answer in the end which was not laid to a sufficient depth in the ground. The result of twenty-five years experience went to show that the double-headed rail, made of good materials, with properly proportioned chairs, and the joints of the rails effectively "fished," was as near to perfection as could be practically attained. In the construction of railways, the permanent way was that which, perhaps, had been the least attended to; and the greatest difficulty had been experienced in getting the consent of Boards of Directors to increase the expense of the way, in order to ensure its efficiency. The hope was expressed that this discussion would have the effect of convincing boards of directors that some additional expense must be incurred in providing better materials for rails, sleepers, and chairs, than it had been hitherto possible to get them to sanction.

INSTITUTION OF NAVAL ARCHITECTS.

Friday, March 1.

The Right Hon. the EARL OF HARDWICKE, D.C.L., F.R.S., Vice-President, in the Chair.

J. Scott Russell, Esq., F.R.S., Vice-President, read a paper entitled, "Notice of the late Mr. John Wood and Mr. Charles Wood, Naval Architects."

He said:—It is one of the objects of this Institution to collect at its meetings, and to preserve in its printed *Transactions*, that great body of floating knowledge which exists in the profession, and which is so widely scattered that it is liable to be lost and left unfruitful, if not thus collected and preserved. It is another of its objects to place on record, and preserve for the benefit of the younger members of the profession, the labours of eminent men whose works are landmarks of progress, and whose lives form examples worthy of imitation. In pursuance of this latter object, it has become my duty this evening to place on the proceedings of the Institution a short notice of two brothers, who for many years occupied the foremost place in our profession, and the last of whom died since we held our last meeting in this place.

The two brothers, Messrs. John Wood and Charles Wood, of Port Glasgow, on the river Clyde, are two men who have left their mark on the period in which they lived. As naval architects, and as practical shipbuilders, I think I may say, that they led for many years the march of improvement in steam navigation. I know that their ships were long the patterns which the builders around them were proud to follow; and I know that this eminence was attained by the combination in a high degree of the perfect practical knowledge of the craft of shipbuilding, with a continual application to the lines of every ship they constructed of careful mathematical calculation of all the properties and qualities of their designs. A long series of successful ships built by them has borne testimony to the value of combining in the same person practical and scientific knowledge, without either of which no true progress is to be made in our profession. There is another point I would remark in the lives of both these accomplished brothers: it is that, although distinguished among their profession by their eminent knowledge, they were equally distinguished by the liberality with which they communicated that knowledge to the other members of their profession, and especially to the younger members of it, whom they took peculiar pleasure in directing to study and to apply the true principles of naval architecture. Even to their immediate rivals in business they were ready to lend their plans; and I can myself remember men, who were direct competitors with them, frequently going to consult them on the vessels and plans they proposed to build. It is our bounden duty, then, that such men should not pass from us unnoticed.

I have before me a tolerably complete list of the works of these brothers; and when I state that the first of their ships was the first steamship—the original *Comet*, built on the Clyde for Bell in the year 1812—you will see that they may well be reckoned the heads and founders of steam naval architecture; and, in fact, most of the peculiarities of our steamships for many years were theirs. The original *Comet* was a vessel only 40ft. long, 12ft. beam, and three horse power. In 1813 they built the next, the *Elizabeth*, which was 15ft. longer (a great stride), and of eight horse power; and in the following year they built the *Clyde*, 10ft. longer, and of 12 horse power.

Referring to the list of steam vessels built by the Messrs. John and Charles Wood, I shall select a few of the most remarkable for notice here. In 1815 they built, from the design of Charles, the first *Caledonia*, which was finished in the style of the Lord Mayor's Barge, and which was afterwards bought by the King of Denmark, and ultimately placed upon the Rhine. In 1816 they built the *Glasgow*, the first steamer that ventured so far to sea as the Island of Cumbra; and when the adventurous voyagers, as they were then regarded, left upon their voyage, their friends bade them farewell, upon an enterprise which they termed "a tempting of Providence." But they got home in safety, and a few years afterwards they built the vessel called the *Talbot*. In 1817 they built the first towing steamboat, which, from her intended employment, was named the *Tug*: hence the name of a well-known useful class of steam-vessels.

I ought here to interpolate the name of David Napier. No very great revolutions have been made by unassisted individuals. You generally find a great many eminent men come together when any great revolution is about to be accomplished. David Napier was a sort of rival to the Woods; and I may mention that he succeeded in getting the *Rob Roy* built in the following manner. David Napier was an engineer, and not a seaman, and the following I believe to be the history of the first sea-going steam vessel built for actual service:—David

Napier, then a young man, had heard of this "tempting of Providence" by going to sea in a steam vessel, and he determined he would go to sea himself, and see what it meant. So the captain of the ship in which he went out remarked that there was a young man on board who was always looking over the bow of the ship into the sea, and every now and then he came back and said, "Captain, do you call this a very heavy sea?" "No, it is only a fresh breeze and a fair sea." Then he went back to his place again. The wind freshened, and he came back again and inquired, "Do you call this a heavy sea?" At length, after the inquiry had been frequently repeated, the captain admitted it was as heavy a sea as he had ever witnessed in his life. "Oh! well, I think I can manage that," cries the young man; upon which he went down into the cabin. That young man was David Napier. He had gone out to sea to ascertain whether the sea was too strong for him, and he found he was too strong for it. He went back and built the *Rob Roy*, the first steam-vessel that ran from the Clyde to Belfast.

Now, I come to the *Talbot*, which the Woods built for him in 1818; and I may mention that this was the first mail packet that ran from Dublin to Holyhead. The next remarkable vessel of theirs was the *James Watt*. It was an enormous advance in ocean steam navigation. It was designed in 1820 by Charles Wood. She had engines made by James Watt & Co., and was an enormous ship in those days. When I tell you that the ship before her was 60ft. long, and she was 120ft.; that the ship before her was 14ft. beam, and she 24ft. beam; that the ship before her was 14 horse power, and she was 100 horse power—you will admit that she was a tempting of Providence. This vessel was a large sea-going vessel of about 450 tons, and I remember her myself, for at least fifteen or twenty years, plying regularly upon that station, between London and Leith, and being an established steam packet, but of dimensions that nobody ever dreamt of before. I have the good fortune, through Mr. Ritchie, a member of our Council, and a relative of the Messrs. Wood, to obtain the drawings of her, which, as valuable records in the history of our profession, I propose to have printed in the *Transactions*, as points to mark our progress by. But it was in those days a wonderful and enormous stride in naval architecture, and which in itself formed, for ten or fifteen years, the pattern steamship. This, as I have said, was the *James Watt*; and you will see from the tracing of her lines (which the speaker exhibited), that in general proportions, in finish, and in beauty of lines, she will bear comparison with many vessels of more modern date. You will see she was unquestionably a beauty in those days, and immensely in advance of any vessel of her time. This *James Watt* came to London, and was for a long time a pattern vessel. Before designing her, Mr. Charles Wood suggested, I say, the practicability of building steam vessels fit to run from London to Leith; and, in 1820, he designed the vessel just mentioned.

As she was not to be propelled by masts and sails, with their leverage to depress the forebody of the vessel, but by paddles, which would impel her in the same manner as oars, she should be formed, he said, as the row galleys of the ancients were, and therefore her water lines were made exactly the same in the forebody as the afterbody, the midships frame being equidistant from the stem and sternpost. The cod's head and mackerel's tail that had been unnaturally joined together in other steamers were thus for ever separated. Most who have studied the subject will recollect that the cod's head is round and dumpy, and that the mackerel's tail is long, fine, and slim. The rule was, that the bow should be one-third of the length, and the run two-thirds, which gives you an ugly head and slender tail. It was, therefore, a greater step than any revolution we make now, when Charles Wood determined that the bow should be nearly as fine as the stern, and that the greatest section should be not one-third from the bow, but exactly amidships, and when, for the first time, an even balancing body was introduced to form the water line.

It is here my duty to state that so early as 1818 Mr. John Wood proposed to propel vessels by a screw, and he did so with a wooden screw, about 2ft. 6in. long, with a blade of wood of 9 or 10in. broad, making one entire revolution round a spindle of 4in. diameter, fastened by iron framework to the stern of a deal gig, this screw being driven by a wheel, and pinion, and crank, by two men at the crank. The boat went at the rate one man could have sculled her with an oar over the stern, or from three to four miles an hour.

But perhaps the most remarkable work of Charles Wood was the construction of two sailing vessels, which those who recollect these times will remember as being the most wonderful things of the period. It occurred to Charles Wood to bring home timber from America, cheap, and in a vessel of an unusual size. We have seen how these vessels grew from 40ft. long up to the *James Watt* of 120ft. You have now to hear what was the next stride they made. His idea was to build a timber ship 301ft. long, 50ft. 6in. broad, and 29ft. 6in. deep, having a tonnage—of what do you think?—5000 tons! He accordingly went out to Canada, and built a ship of that size, called the *Columbus*. This ship came home full of timber. [A Member: She was a mass of timber—a raft. Mr. Scott Russell: I will explain that in a minute.] In 1824, he made a successful passage from Quebec to London in the *Columbus*, the dimensions of which were what I have told you. The *Columbus* arrived safely at Blackwall, and having discharged her cargo, was, against the advice of Charles Wood, sent back again to St. John's, and, unhappily, was lost on her way, the crew being saved. Allow me to explain to you the primary views with which these vessels were formed. It occurred to him that the cheapness of timber out there would make it worth his while to build the vessel in Canada, and break it up here for the value of the timber. He accordingly went out and built this *Columbus*, filled her with timber, brought her home, and had the intention of breaking up the timber of which she was constructed for the value of it as timber; and you may conceive very readily that it was his object to render the structure of her such that the timber should be as little as possible damaged, and put together as cheaply as possible. These large vessels were built, filled with timber, brought home to this country, and the first made a successful voyage, and I am not sure she did not make a large profit. Charles Wood returned to Canada to finish the second raft-ship, called the *Baron Renfrew*, which he had begun before leaving Canada in the *Columbus*. He made the passage home in the *Baron Renfrew*, but she

was unfortunately put aground on the Long Sand Head, while in tow of two steam vessels (one of which was the *James Watt*), through the stupidity of the pilots, and ultimately drove ashore near Gravelines, on the French coast, and broke up; but the whole of the crew were saved, through the gallantry of the Dover boatman. The dimension of the *Baron Renfrew* were somewhat different from those of the *Columbus*, her length being 304ft., breadth 61ft., depth 34ft., and registered 5294 tons. I am happy to say that I have in my possession Mr. Ritchie's private log, kept during her voyage from Quebec to the Thames, and it is a highly interesting document.

The next vessels which I notice on this list are vessels with which we are all pretty well acquainted—I allude to the vessels called the *Perth*, the *Dundee*, and the *London*. Most of you will recollect, on coming up the Thames some fifteen years ago, seeing three very beautiful vessels lying at the Dundee Wharf, called by these names. You may all have noticed those vessels, which were remarkable for their graceful form, and for the finish of every part of the workmanship. These were not Charles Wood's design, but John Wood's. There is this difference between the two—whilst Charles Wood was a remarkable man, and a man of genius, John was a diligent, accomplished, and scientific constructor, who never allowed a line of his vessels to be constructed that had not been carefully laid down with his own hand, after the most accurate calculations. And John Wood was, moreover, remarkable for the great refinement of his taste. He was a consummate artist in shipbuilding, and every line was as studied and beautiful as fine art could make it. John Wood was, in fact, a pattern shipbuilder. His ideas are not my ideas; but I must say I never conversed with John Wood without going away instructed. I must say this, also, that a great deal of the love of my profession I owe to an early intercourse with John Wood. And he had this remarkable effect upon all who came near him—that he made them ambitious to rise in their profession, by means of science, by means of skill, and by means of true love of their profession, rather than with the mere hope of using it as an instrument for making money. Nevertheless, I am happy to say that John Wood died a richer man than when he went into the business.

The next class of vessels I come to is a class which has reflected honour not only upon the name of the Woods, but upon the British nation generally. If there is one class of ships of which we have reason to be prouder than another, it is the Cunard line of steamships. John Wood built the pattern ship of that celebrated line. Allow me to say, further, that John Wood built the pattern ship of the second series of that line. The pattern of the first series was the *Arcadia*, while that of the second was the *Europa*. These were both John Wood's designs. I have already said that great designs are not carried out by solitary individuals. One clever man is not enough; two are rarely enough for a great new enterprise of this kind. The Cunard line was carried to its great success by an extraordinary combination of talent. We had John Wood as the shipbuilder—a man whose conscientious execution of the timber work of the ship made him a pattern in material and workmanship as well as a pattern in design. Then came Mr. Robert Napier, who, though a rival to many of us and to myself in our profession, we must all say is a man whose moral and professional character we are proud to set before us as a pattern. Nor were these alone, for they could only build a good vessel; it was not theirs to use a good vessel when they got it. But amongst those concerned were men who knew how to do justice to a good ship when they got it. Allied with them were two firms who were rivals, but who agreed to sink their rivalry and work together in this great national undertaking, viz., George Burns and Co., and Thompson and McIvor; and they, Robert Napier and John Wood, are the men to whom this nation owes the great pride of possessing the Cunard line of steamers—a line of steamers which has often been attempted to be rivalled, but which I think may be said to possess the confidence of the profession and of the world at large more than any other line. I consider it fortunate that I have been able to obtain for you, through Mr. Ritchie, the lines of the *Europa*, as well as those of the *James Watt*; and those two vessels, I should say, are types of the times in which they were constructed, are patterns which we may be proud to have in our *Transactions*, marking out for us, as they do, the lines of two of the most eminent shipbuilders of the time, showing what were the kind of lines, and what were the qualities of a vessel, which they thought most desirable.

John Wood died only in the latter end of last year; Charles Wood we lost from amongst us ten or twelve years ago; but I am happy to say, before he died he assisted in conferring upon the country one of the greatest benefits that has been conferred upon it during my lifetime. I refer to the emancipation of shipbuilding from the trammels of a bad law. Charles Wood was a genius in his way. He came up to London with the purpose of using all his endeavours to get altered those tonnage laws which had so long cramped our shipping. You will remember that our old tonnage laws made our steamers fiddles—tucking them in at the middle, and swelling them out at the ends. By tucking them in at the middle, you measured the breadth in the smallest place, and you regulated this tonnage according to the tuck-in. And here is a little epigram which Charles Wood made upon this subject. One of the authors of this law was named Riddle, and amongst other shafts which were levelled at the system, was this by Charles Wood:—

"Ships measured by Riddle,
Turned into a fiddle,
And improvements all fiddle-de-dee."

This is an epigram which embodies all that we used to feel upon the subject of the old tonnage laws. But I am happy to say our deceased friend had something to do in getting rid of that abominable law which fettered shipbuilders; and I am happy to add, that under the tonnage-measurement law as it now stands, we are free, without let or hindrance, to make our ships any way we please, and that the ship we build is tested and taxed by its real and absolute capacity for carrying profitable cargo, and not by any other circumstance whatever. For this we are in a great measure, and originally, indebted to the exertions of Charles Wood.

I hope, therefore, you will feel with me that we shall not do otherwise than a duty to our profession if we place upon record this short notice of the life and works of those two distinguished brothers, to whom I think the profession at large is so deeply indebted, and it is, as I have said, our bounden duty that such men should not pass from us unnoticed.

The next paper read was on "THE DEVIATION OF THE COMPASS IN IRON AND OTHER VESSELS, CONSIDERED PRACTICALLY WITH REFERENCE TO MATERIAL, POSITION, AND MODE OF CONSTRUCTION AND EQUIPMENT," by F. J. O. Evans, Esq., R.N., Assoc. I. N. A., Superintendent of the Compass Department of the Admiralty. After some complimentary allusions to the labours of the Astronomer Royal, Mr. Archibald Smith, of Lincoln's-inn, General Sabine, the late Captain Johnson, R.N., the late Dr. Scoresby, the Liverpool Compass Committee, and the able Secretary of that Committee, Mr. Rundell, the author proceeded to define the nature of the laws of magnetic action in iron ships, for the purpose of clearing them, as far as possible, from mathematical obscurities. He next detailed the results of his own personal investigation of many hundreds of deviation tables, chiefly of Her Majesty's ships, and classed under the following heads:—1. Sailing vessels, wood-built; 2. Steam vessels, wood-built; 3. Vessels built partly of wood and iron; 4. Steam and sailing vessels, iron-built; 5. Iron-plated ships. In the first class he found that the north end of the needle was almost invariably drawn to the ship's head, the amount of the action being small. In the second class the same general law obtained, but the machinery was found to add greatly to the disturbance, the direction of the magnetic force varying as the engines, boilers, &c., were variously arranged. In the third class, the iron is introduced in such a variety of forms and positions that only a general account of the magnetic action could be given. The compass errors produced are necessarily of a most uncertain and dangerous character, the more so as they are often unsuspected by the builder and navigator. The author instanced some very important modern examples illustrative of this view. With regard to the fourth class, the author explained that the great difference in the conditions of compass disturbance in wood and iron-built ships respectively is, that in iron vessels, during the progress of building, the inductive action of the earth's magnetism is highly developed, and to a great extent fixed, by the repeated hammering in the riveting and other works in the general fabric. The hull, consequently, becomes one large magnet, divided into two portions (similar to a magnet-bar), one portion having north and the other south polarity, or the power respectively of repelling and attracting the north end of a compass needle. The author explained at length, and by aid of diagrams, the manner in which the position and direction of the ship upon the stocks affected this result; and observed that all detached masses of iron, not worked into the hull (such as the rudder, the funnel, machinery, &c.), have an independent magnetic character, and introduce a new set of phenomena, which must be separately considered. He also drew attention to the fact that in two iron ships built in every respect similarly, except as regards the quality of the iron, the compass will be very differently affected, the softer iron being subject to the greater changes, and therefore the more likely to lead to disaster. From the same circumstance follows the very remarkable inference that, if this iron be largely used in the construction of a ship, the delicately-poised needle of the compass will infallibly detect its presence. After an able and elaborate review of facts connected with the variation of the magnetism of iron ships, the author inferred that the greater the co-efficient denoting the deviation due to the induced magnetism of soft iron in a ship (known as the quadrantal deviation), the more rapid and capricious will be the change of the ship's magnetic force, both in direction and amount. And, conversely, with a small co-efficient, there will be little or no change in the direction, but a decrease in the amount of the magnetic force. "But we are warned," said the author, "under any circumstances, not to send an iron ship too quickly to sea after launching; that her equipment shall progress with her head, if possible, in an opposite direction to that in which she was built; and, as suggested by Mr. Airy, to 'shake out' by motion, concussion, or the tremor of the steam engine the variable part of the sub-permanent magnetism." The author next gave detailed statements on the best direction for building iron ships, and on the position of, and arrangements for, the compass. He urged the general adoption of the Admiralty standard or Azimuth compass in the mercantile marine, and gave directions for fitting it. In conclusion, the author briefly referred to iron-plated ships of war, pointing out the importance of due attention being given to the novel phenomena which must attend their action upon the compass, and inviting further practical investigation of the subject.

*The last paper read was upon "AMERICAN RIVER STEAMERS," by Norman Scott Russell, Esq., Assoc. I. N. A. The author explained the characteristic features of the eastern and western river steamers of America respectively, stating the different conditions of service under which the two classes had to be used, and pointing out the different principles of construction to which the naval architect consequently resorted. He gave a detailed description first, of the hulls, and, secondly, of the boilers and engines of the two kinds of vessels, and illustrated his remarks by several enormous diagrams, and by some exquisitely finished set of drawings on a smaller scale. All the peculiarities of construction which American shipbuilders and engineers have introduced into these remarkable vessels were dwelt upon by the author, who found in them grounds for abundant praise and admiration, and could detect nothing to justify the adverse criticism which our countrymen sometimes pass upon them. Nothing in the shape of a brief abstract could afford any fair indication of the value of this paper; and we must, therefore, refer such of our readers as may feel interested in the subject to the forthcoming volume of the Institution's *Transactions*, which is to be prepared, we are informed, with all convenient despatch, and will contain the author's paper complete, with copious illustrative engravings.

CORRESPONDENCE.

We do not hold ourselves responsible for the opinions of our Correspondents.

STRENGTH OF BOILERS.

To the Editor of THE ARTIZAN.

SIR,—Although I consider Mr. McFarlane Gray's table of formulæ for the strength of boilers excellent, I agree with "Boiler Maker" that we can for the present do no better than to treat stayed surfaces as beams fixed at both ends; but one of his statements appears to me to be unsatisfactory. He writes "the breaking weight for such a case would be $3 \times 4050 = 12,150$ lbs. or the load that would break a wrought iron bar one inch square and one foot long between the fixed ends."

4050 lbs. being the breaking weight on a beam, supported only at the ends, 12,150 lbs. will exceed the breaking weight when the ends are fixed; it is true it is the breaking weight on the centre of the beam, but the greatest moment of strain for a given load will exist at the point of support (the ends of the beam being fixed), thus for a fixed beam 12 in. long, with a weight w on every inch of length, the moment of strain at the centre will be—

$$\frac{w \times 12^2}{24} = 6w$$

while the moment over either point of support will be,—

$$\frac{w \times 12^2}{12} = 12w$$

the central moment of strain on a similar beam merely supported at each end being—

$$\frac{w \times 12^2}{8} = 18w.$$

The breaking weight to be used, instead of 12,150 lbs., will therefore be 6075 lbs., or for best Yorkshire plates 8000 lbs.; the length being taken in feet, or 96,000 lbs. if the length is in inches. We of course consider that the plate will break at the point of fixture.

I think that we require experiments on the resistance of stayed surface, the more that we can put but little faith in theory on this matter; nor have we even any plausible theory to go upon, for if we regard the spaces between the stays as beams, who will decide in which direction the plate will burst.

Experiments, to be useful, must be performed with plates not fixed all round; but fixed only at the corners, and then we may expect the plate to tend in two directions at right angles to each other, perhaps diagonally to the square between the stays.

I am, Sir, yours respectfully,

F. C.

April 17, 1861.

SIR,—In my last letter I tried to demonstrate two rules in respect to the strength of boilers, viz:—*That the strength of flat stayed surfaces varies (with equal thickness of plate) as the square of the distance of the stays; and secondly, that the strength of the plate per se varies (with equal distance of stays) as the square of the thickness of the plate.*

With respect to the first question I am glad to see that Mr. Gray now seems to take the same view of it as I have taken, and we will therefore consider this part of the question settled, until new experiments show us that we are wrong.

Before considering the second question, I will first answer to some remarks made in Mr. Gray's last letter, concerning marine boilers. The reason why I applied the rules in Mr. Gray's table to marine boilers, is simply because I found, immediately following the heading: "Stayed Flat Surfaces, such as the sides of a fire-box of a locomotive boiler, the stays being screwed into the plates without nuts;" another: "Round Iron Stays, with fresh water, and ditto with salt water;" from this last remark *salt water*, I naturally concluded that the rules following this heading, were applicable to marine boilers, and thus I found the discrepancy of his rule, in respect to the thickness of the plates compared with common practice.

In Mr. Gray's letter, he says, "I have never seen, in marine boilers, stayed flat surfaces, such as the sides of a locomotive boiler, the stays being screwed into the plates without nuts at 14 in. from centre to centre, for a regular working pressure of 20 lbs. per square inch." To this I can only answer that I have certainly seen it in marine boilers with 20 lbs. pressure, although I should never recommend it; but in my example I meant stays screwed into the plates, with a nut on each side of the plate. But even if it had been only screwed into the plate and rivetted over, as in a locomotive boiler, it would have been just as strong, as Mr. Gray will perceive from Mr. Fairbairns experiment page 335, III. in *Useful Information*, where the stay itself broke and left the thread and riveting quite sound.

We will now consider the second rule, viz:—*That the strength of the plate per se varies (with equal distance of stays) as the square of the thickness of the plates.* I fully admit that my rule is not perfect, and I had first intended to find a better one, but gave it up for want of satisfactory experiments, which is at one apparent, when we see that the bursting

strain of a $\frac{1}{4}$ in. plate, according to Mr. Fairbairn's experiments, in one instance was 13789lbs. and in another 19769lbs. But taking my rule as it is, you will remember, that it was based on the supposition, that the plate between the four stays was *firmly fixed all round*, in which case it ought to have given a result of 524lbs., but as perhaps the plate between four stays can not be considered as rigid or firm as the plate riveted all round, similar to Mr. Fairbairn's experimental box, I think the result 333lbs. might be nearer the truth than 524lbs. My rule applied to the $\frac{1}{4}$ in. plate would not give more than about one-third of the experimental result but I find that Mr. Gray's rule will not give more than *one-eighth* of that of the experiment.

In conclusion, I should be very much obliged to Mr. Gray, if he, in his next letter would give us, "the other instances of a doubtful application of the principle of strength being as the square of thickness," which I am quite sure, if gone into by so able a writer, will be of great practical value.

I am, Sir, yours,

A BOILER MAKER.

In answer to a note from Mr. Gray, "Boiler Maker" adds, I beg to repeat that I have *several times seen boilers* from second class makers, with stays 14in. apart from centre to centre under a pressure of 20lbs., flat surfaces, *without nuts*, but riveted over at the ends. These stays have however, been applied at the lower part of the common marine boiler only where the furnaces are, and where the stays are but short; at the upper part of the boiler where there are long stays, there have generally been applied nuts on either side of the plate.

SIR,—My reply to "Boiler Maker's" communication was unavoidably a hurried one: having been absent for some days, I did not receive his letter until it was almost too late for the April number. That answer will satisfy "Boiler Maker" that I am ready to acknowledge the validity of any objection he may advance, and that in the following remarks I do not seek to prop up a theory, but to elicit truth.

I admitted at once the force of his argument, that the experiments were not conclusive as to the strength of the plates *per se*, but not having time to go fully into the matter, I accepted his statements as correct; but, on examining the report of these experiments, I can nowhere discover that an iron stay, screwed and rivetted, was drawn through a half inch copper plate by a strain corresponding to that of the first experiment, 9 tons for a stay $\frac{1}{8}$ diameter. I find only one experiment recorded. A $\frac{3}{4}$ inch stay was drawn through a copper plate $\frac{3}{8}$ inch thick, by a weight of 10.7 tons. This stay was screwed and rivetted: when not rivetted, a $\frac{3}{4}$ stay was drawn through $\frac{3}{8}$ inch plate by 8.1 tons; but if the plate had been half an inch thick, it is reasonable to suppose that it would have required a weight equal to $(8.1 \times 1\frac{1}{2}) = 10.8$ tons. But the rivetting gave an additional strength equal to $(10.7 - 8.1) = 2.6$ tons; and this, added to 10.8, gives 13.4 tons as the weight necessary to pull a $\frac{3}{4}$ inch rivetted and screwed stay through a half-inch copper plate. The stay itself would be broken by a less weight, but that circumstance does not affect the present question. If a $\frac{3}{4}$ stay require 13.4 tons, a stay $\frac{1}{8}$ will require $(13.4 \times \frac{1}{12}) = 12\frac{1}{4}$ tons. I have here reduced the weight in the ratio of the diameters, simply because it is the holding power of the thread, and not the strength of the stay that we have to do with. Now, this stay in the experiment was drawn through by 9 tons, which therefore *does not agree* with Mr. Fairbairn's experiments upon screwed stays. In the other experiment the stay was $\frac{1}{8}$ diameter, and it was drawn through a $\frac{3}{8}$ in. iron plate, as in the first experiment the stay was not broken, but drawn through the plate. We cannot tell from Mr. Fairbairn's experiments on stays what force would be necessary to accomplish this. An iron stay $\frac{3}{4}$ ths of an inch diameter, screwed and rivetted into an iron plate $\frac{3}{8}$ ths of an inch thick, broke with 12.5 tons, both the screw and the plate remaining perfect. A stay $\frac{1}{8}$ ths of an inch in diameter ought to sustain at least $(12.5 \times \frac{1}{12}) = 13.5$ tons without injury to the plate or the screw; but, in the experiment on flat surfaces, 11.5 tons pulled the stay through the plate, which therefore *does not agree* with Mr. Fairbairn's experiments upon screwed stays. Supposing then that the experiment was unaffected by the distances between the stays, as "Boiler Maker" asserts, the bursting strain upon each stay ought to have been 12 $\frac{1}{4}$ tons in the first, and 13 $\frac{1}{2}$ tons in the second experiment, whereas the strains were respectively 9 tons and 11 $\frac{1}{2}$ tons.

But if the stay be so fastened into the plate that it cannot be drawn through, as when there is a nut outside and one inside, or a nut outside and a ferule inside, the conditions are quite altered, and in my paper, "On the Strength of Boilers" I have said that, "if the conditions of the strains were such that the plate would burst by rending at the middle of the bulgings, or midway between the stays, the ultimate pressure would be such that the total load on a square contained by four stays would be the same, whatever the distance between the stays might be." This is equivalent to "Boiler Maker's" statement, that the strength of flat stayed surfaces varies (with equal thickness of plate) as the square of the distance of the stays. I have never disputed that the strength of the plate *per se* is as the square of the distance of the stays, but the point in dispute is the

strength of the plate *per something less than se*. At the insertion of a stay which is screwed and rivetted into the plate, the strength of the plate is there reduced, and the strain of the whole pressure is concentrated on the edge of the hole, and the analogy between this and a beam uniformly loaded is not very apparent.

That he has seen stays 14in. apart in marine boilers for 20lb. working pressure is very possible; I have seen them at least 3ft. 6in. apart for 22lbs. (they were spaced closer in the other direction); but in this case the stays were fixed by palms or stiff angle irons, and in marine boilers for such pressures the shell is always stiffened either by inside angle irons, or what is better, by outside angle irons. The example given by "Boiler Maker" in his letter seems to be unexceptionable, but he has explained that he has met with it only in boilers from second-class makers, and his own opinion of it is that he should never recommend it. These examples are in the lower parts of common marine boilers; if wet bottomed this must either refer to the bilges, which are not flat surfaces, or to the bottom itself, which on closer inspection might be found to be $\frac{1}{2}$ in. thick and double rivetted, which would make it *safe* enough for 20lb. pressure; but unless the plates were stiffened, if the flat surface was of considerable extent it would be difficult to keep them tight without nuts. He says that, "even if it had only been screwed into the plate and rivetted over, as in a locomotive boiler, it would have been just as strong." At the page referred to I find that the experiment failed by one of the stays drawing through the iron plate, the stay being uninjured; the strain was then 2 tons less than the thread and rivetting would have carried according to the experiment on screwed stays at page 339, and 3 tons less than the tensile strength of the stay itself. If he refers to page 339, he must remember that the plate there was not under steam pressure, and he must compare the result of it with the result of the experiments on flat surfaces, as I have done in the preceding sentence, before he can justly draw such a conclusion.

With regard to the strength of plates being as the square of their thickness I did not refer to that question for the purpose of criticising his rule, but to point out the fallacy of establishing a rule of strength being as the square of thickness upon experiments which establish that the strength is as the thickness simply under the conditions of the experiment. He compares my rule with these results, but that is a gratuitous service; there is no analogy between the conditions, and I would not have referred to them but that he has chosen to establish his rule upon them. That there was a considerable difference between the two experiments does not invalidate the conclusion arrived at, because it is easy to account for a deficiency of strength, but difficult to explain how a plate could sustain twice the pressure due to its thickness. That the bursting pressure in these experiments was as the thickness simply is not anomalous. The expression square of the depth is introduced into the rules for the strength of beams, not directly, but from the relation which the depth bears to the distance of the neutral axis from the upper and lower edges of the beam. If we examine the conditions of those experiments, we will find that there was no neutral axis or surface in the plate; it was wholly in a state of extension, and therefore the principle of strength being as the square of the thickness is no more applicable to this case, then it is to the strength of a metallic fiddle string to a perpendicular strain. I have not discussed other examples of doubtful application of this principle, my letter being already a long one. I have now, I think, said all that is necessary in reference to the rule introduced by me; your readers have already my side of the question. If "Boiler Maker" has other considerations to advance, I will be glad to read them; but I will decline extending my argument, as I have no wish to force my views on any one.

I remain, Sir, yours, &c.

J. Mc. F. GRAY.

STEAMSHIP PERFORMANCE.

To the Editor of THE ARTIZAN.

SIR,—With reference to my letter in your number of the 1st inst., in which I alluded to the supposed authorship of the now generally recognised formula for determining the relative dynamic efficiency of steamships, I have received a note from Mr. Langdon, of the firm of James Watt & Co., to which I have much pleasure in giving publicity, it being confirmatory of the practical utility of the formula referred to. Mr. Langdon writes as follows:—

"The formula was read by Boulton and Watt, as far back as 1817, during the experiments made upon the *Caledonia*, a small steamer bought by the late Mr. Watt, for the express purpose of experimental research, as it respects the relation of power to velocity, and the said formula was then adopted by the late Mr. William Crichton, of Soho, a man of great mathematical attainments. I have been acquainted with this formula for the past thirty-five years, and have been in the constant habit of being guided by it; and I recollect that, thirty-three years ago, Mr. Brown made out a series of tables compiled from our then stock of experience, which were wonderfully accurate, and even now form our guide in such calculations. I am aware that Mr. Watt used the midship section only as the exponent

of resistance, but he had three or four classes of ships, each class having its own factor, truly accurate, as I have before said.²—Yours, &c.,

“W. LANGDON.”

I could have wished that Mr. Langdon had made the above statement on a late occasion, when the validity of the formula was made the subject of discussion in THE ARTIZAN, but even yet some benefit would result to the science of steam navigation, by the public being now apprised of the table above referred to as having been calculated by Mr. Brown (of the firm of Boulton and Watt) thirty-three years ago, and of the respective factors or coefficients applied by Mr. Watt to each of the four classes by which that great authority classified the steamers of his day; we should then have the means of tracing the progressive improvements of steam ships as respects their dynamic efficiency simultaneously with the changes of construction in hull and engines by which these improvements have been progressively effected since 1817. It will also be a curious and a useful inquiry to compare the progressive dynamic and economic improvement of steam shipping, now that by the publicity of such formulæ, purchasers and the proprietors of steamships are enabled to judge of the relative dynamic merits of steamships by a numerical test, as compared with the rate of improvement, whilst such means of test were exclusively and only partially in the hands of builders and engineers.

I am, Sir, yours very obediently,

Woolwich Dockyard, April 22, 1861. CHARLES ATHERTON.

TUBE SURFACE.

SIR—As many of your readers are now turning their attention to surface condensation, the following remarks on the maximum tube surface that can be obtained in a given space may be useful to some of them.

x = the diameter of the tubes, outside diameter for outside surface, inside diameter for inside surface.

a = the distance between two tubes; for outside surface measure from outside to outside; for inside surface measure from inside to inside.

$$r = \frac{x}{a}, x = r a.$$

In a given space the number of tubes will be proportional to $\frac{1}{(a+x)^2}$

In a given space the tube surface will be proportional to $\frac{x}{(a+x)^2}$

The tube surface will be a maximum when $\frac{x}{(a+x)^2}$ is a maximum,

which will be the case, when the first differential co-efficient of this quantity is zero. If we suppose throughout the rest of this paper that a is a fixed quantity, and that x is variable, the first differential co-efficient of $\frac{x}{(a+x)^2}$

$$\text{will be } \frac{a-x}{(a+x)^3} = 0$$

$$\therefore a-x=0$$

$$\therefore a=x$$

The greatest possible surface is therefore obtained when the diameter of the tube is equal to the distance between the tubes.

Example.—If the clearance between the tubes be $\frac{3}{8}$ of an inch, and if the thickness of the tubes be $\frac{1}{16}$ of an inch, the maximum outside surface will be obtained with tubes which are $\frac{3}{8}$ of an inch in diameter outside, and the maximum inside surface will be obtained with tubes which are $\frac{3}{8}$ of an inch outside diameter.

Again, the maximum tube surface will be a multiple of $\frac{a}{4a^2}$ and the tube surface with any diameter of tube will be the same multiple of $\frac{ra}{(a+ra)^2}$ therefore, $\frac{ra}{(a+ra)^2} \div \frac{a}{4a^2}$ will express the proportion which the actual amount of tube surface bears to the maximum amount. The reduction of this quotient yields $\frac{4r}{(1+r)^2}$ hence the proportion which the actual tube surface bears to the maximum is found thus:—Divide the diameter of the tube by the distance between two tubes, multiply the quotient by 4, and divide by the square of (1 added to that quotient).

Note.—The distance between the tubes must be measured according to the definition of a .

Example.—Given the clearance between two tubes $\frac{1}{2}$ an inch, outside diameter of tube $\frac{3}{8}$, and the thickness of tube $\frac{1}{16}$, what proportion of the maximum inside surface is obtained?

$$\text{Here } r = \frac{6}{5}$$

$$\frac{4 \times \frac{6}{5}}{\left(1 + \frac{6}{5}\right)^2} = \frac{24 \times 5}{11^2} = \frac{120}{121} = \text{the proportion required; showing that}$$

although the maximum surface is obtained with tubes which are $\frac{3}{8}$ of an

inch outside diameter, yet with tubes $\frac{1}{2}$ of an inch larger we do not lose 1 per cent. of the surface.

We may try further what would be the proportion if the tubes were 1 inch outside diameter, retaining the other dimensions as before.

$$r = \frac{7}{5}, \frac{4 \times \frac{7}{5}}{\left(1 + \frac{7}{5}\right)^2} = \frac{28 \times 5}{12^2} = \frac{140}{144} = .9722.$$

With tubes 1 inch outside diameter, and clearance half an inch, we get $2\frac{3}{4}$ per cent. less inside surface in the same space compared with tubes $\frac{3}{8}$ of an inch outside diameter, but with the smaller tubes the tube-joints would be increased 33 per cent. Space is very valuable, but it will seldom pay to buy it at such a price.

OMICRON.

GYRASCOPE GOVERNOR, ETC.

To the Editor of THE ARTIZAN.

SIR,—Under this heading in the April number of THE ARTIZAN, I notice a letter from “Traveller,” New York, in which he describes several governors for marine purposes, one of which is evidently that of Mr. Thomas Silver, of Philadelphia, as I know the *Australasian*, as well as several hundred other vessels are fitted with them, and then says that he believes it to be an “English invention.” The so-called “Gyrascope” governor has long been in use in England, in the shape of a wheel or disc fixed loosely on a shaft or spindle, and held when at rest in a diagonal position by a spring, but I am not aware who invented it.

The late Mr. I. K. Brunel saw what was wanted to make a marine governor, but, from not being a practical mechanic, he was unable to make that mechanical combination by which alone such a machine can be made useful for that purpose. This is easily proved by comparing his four-balled contrivance on board the *Great Eastern*, with the perfect and beautiful invention of Thomas Silver; for, although he started with all the parts employed by Silver, yet he totally failed in producing the machine he desired.

In concluding these remarks, I must assure “Traveller” that he is in error when he says it is necessary “to go to England for perfection in governors, inasmuch as the only perfect, reliable, and efficient marine governor at present used, I may almost say known, in England, is that of Mr. Thomas Silver, of Philadelphia, America. If I am in error, possibly some of your correspondents will set me right.

I am, sir, your obedient servant,

London, April 23, 1861.

AN ENGINEER.

IS THE NORTH ATLANTIC TELEGRAPH ROUTE THE BEST?

To the Editor of THE ARTIZAN.

SIR,—Following up the letter you kindly inserted in your last, on my plan of working a telegraph to America by the direct route, by suspending it 60ft. below the surface, and augmenting the force of the current by causing it to traverse submerged batteries every 300 miles on the route in circuit with the line, I beg to lay before your readers a few difficulties that suggest themselves as naturally in the way of the North Atlantic route. The recent pamphlet published by the Royal Geographical Society on the surveys made for the purpose of the telegraph is what suggested them to me, and it is for those who hold the practicability of the undertaking to prove away the difficulties.

1st, Can they show any preference for going so far out of a direct track with the line but to get the line broken up into shorter stages; and is such not actually accomplished by the method I proposed in floating stations, when their stability is admitted.

2d, The submarine cables on the Indian route are a series of sunk cables, similar in length to the North Atlantic, laid in the quiet Mediterranean, but which, in one part or other of the route, are often going wrong. Can they explain more permanent success for the other, with the untold dangers from icebergs, &c., which our want of experience, practically, cannot as fully determine.

3d, From the nature of the circumstances, in the case of an accident, can they give an idea how soon it could be repaired, seeing only for some weeks, during some years, part of the line can be got at for examination or adjustment.

4th, Can they predict the effect of frosts and snow on the land sections. We have all seen a clothes, line get coated to several inches deep during a snow storm at home.

5th, Can they determine the supposed effects of telluric currents in a line traversing such changes of temperature, and especially in the precincts of the magnetic pole itself. The fact that Captain Kellett and Captain M’Clintock did work a short telegraph in a high latitude (76 degrees, if I remember) does not settle the question.

6th, The expense of making and maintaining the line must be enormous.

C. AULD.—The same propositions were made, and published in the *Glasgow Herald*, about the end of the year 1859. We have not the papers to enable us to refer and give you "chapter and verse," but think the letters were signed either "ARBITRATOR" or "BUILDERS."
 "ISEN-FAHLE."—If you will write in an intelligible style, we will endeavour to reply. We do not know where Mr. C. Bincks now is, nor anything of his cyanogen steel. Mr. F. Yates published a very useful little pamphlet on iron and steel. (Vacher & Sons, Parliament-street, 1861.)
 J. (Nantes, France).—The gentleman respecting whom you inquire is still alive, and is now an Admiral. We cannot find his address, but a letter sent to the Admiralty for him will no doubt reach him.
 "CITROEN."—Your letter, dated 26th April, was received too late for insertion in the present number, but we shall require your correct address, in confidence; therefore please to forward it.
 D. C.—The following were the tenders sent in for the Heating Apparatus of the Conservatory in the New Garden of the Royal Horticultural Society, Kensington Gore, W. — Messrs. John Weeks & Co., Horticultural Builders, King's-road, Chelsea, S.W., £975; William Hood, 12, Upper Thames-street, E.C., £1216; A. Shanks & Son, Dens Iron Works, Arbroath, Scotland, £1250; J. Tylor Sand ons, Warwick-lane, Newgate-street, E.C., £1300; Cottam & Co., 2, Winsley-street, Oxford-street, W.C., £1307; Barwell and Co., Eagle Foundry, Northampton, £1321; J. Wontner Smith, 20 and 21, Teater-street, Finsbury, E.C., £1350; W. Jeakes, 51, Great Russell-street, Bloomsbury, W.C., £1357 18s.; Alfred May, 259, High Holborn, W.C., £1480; Henry Ormsom, Stanley Bridge, King's-road, Chelsea, S.W., £1490; Thomas Potter, 44, South Molton-street, W., £1497 14s. 6d.; John Taylor & Sons, Harrow-road, W., £1551 14s. 2d.; J. H. P. Dennis, Chelmsford, £1745 (N.B.—This estimate includes, in slump, gratings, which are not in the other tenders); Frederick Bacon, 16, Ebury-street, Pimlico, S.W., £1859 17s. The following gentlemen also sent in tenders, but imperfect—A. M. Perkins, 6, Francis-street, Regent-square, W.C.; Johu Meiklejohn, Westfield Iron Works, Dalkeith; Feltham & Truss, 53, Gracechurch-street, E.C.

and it having come on before the Lord Chief Justice, in the character of both judge and jury, he gave a verdict in favour of Mr. Scott Russell. On Friday, however, a motion was made on behalf of the company for a rule for a new trial, on the ground that the arbitrators having authority to decide any case of difference arising under the contract, had taken into their consideration the circumstance under which the company had stopped the transfer of 6,000 shares held by Mr. Scott Russell, 5,000 of which had been allotted by the company, and 1,000 of which had been bought in the market. In considering this matter, it was submitted that the arbitrators had exceeded their authority, inasmuch as it was not a difference arising under the contract. There was also a minor instance, in which it was said that the arbitrators had exceeded their authority, and it was submitted that in consequence the award was bad. Their lordships this morning expressed their opinion that the arbitrators had not exceeded their authority, and that consequently, the verdict entered for the amount of the award must stand. Mr. Watkin Williams, on behalf of Mr. Russell, then applied for speedy execution against the company, upon the ground that it was a limited company, and the only property possessed by it was the great ship, which was advertised to sail for America. The verdict was given on the first day of term, and if Mr. Russell were compelled to wait 14 days before he issued execution he would not be able to obtain his execution until the very day the ship was to sail, and as she lay at Milford, he would not be able to get the writ down there in time to stop her. Again, if she once got out of the jurisdiction of the Court, it was impossible to say whether she would come back again, and Mr. Russell might be utterly unable to enforce his execution. Mr. Lloyd, for the company, hoped that the application would not be granted, especially as he expected to be instructed to ask for leave to appeal, for the Court of Queen's Bench had given as clear and unanimous an opinion against this award as their lordships had just given in favour of it, and this upon the same materials. The Lord Chief Justice said if Mr. Russell got his writ he had no doubt that there would be a reconciliation between them, and that some agreement would take place; and considering that the company was a limited one, and that the only property was the ship, he thought that there should be execution forthwith. Execution ordered accordingly.

RECENT LEGAL DECISIONS

AFFECTING THE ARTS, MANUFACTURES, INVENTIONS, &c.

UNDER this heading we propose giving a succinct summary of such decisions and other proceedings of the Courts of Law, during the preceding month, as may have a distinct and practical bearing on the various departments treated of in our Journal: selecting those cases only which offer some point either of novelty, or of useful application to the manufacturer, the inventor, or the usually—in the intelligence of law matters, at least—less experienced artisan. With this object in view, we shall endeavour, as much as possible, to divest our remarks of all legal technicalities, and to present the substance of those decisions to our readers in a plain, familiar, and intelligible shape.

GLASS AND ANOTHER v. BOSWELL.—This was an action tried in the Court of Common Pleas, on the 16th ult. The plaintiffs in this case were manufacturers of electric cables, and the defendant was the manager of the London establishment of Messrs. Glasse and Elliott, who are also manufacturers of electric cables. The declaration charged that the defendant had instigated a person named Curtis, who had been employed as a rigger in laying down a telegraph cable between England and the Dutch coast, to drive a nail into the cable, so as to damage its efficiency, and that accordingly Curtis did drive in the nail, and destroyed the conducting power of one of the four wires contained in the cable. The result of this was, it cost a sum of not less than £7,000 or £8,000 to repair the damage. The case was tried before the Lord Chief Justice, at the last sitting at Guildhall, when the jury found for the plaintiffs, and it was arranged that the damages should be settled out of court. Mr. Bovill now moved for a rule for a new trial, upon the ground that the verdict was against the evidence, and also upon affidavits. One important question at the trial was, at what time the defendant received from Curtis a piece of the cable. The defendant himself, on the matter being brought suddenly to his mind, could not recollect whether he received it before or after the ship sailed to lay the cable; and upon the evidence on the other side, it went to the jury that the defendant had the piece of cable before the ship sailed. It was now, however, clear upon an affidavit, and from some letters which the defendant had found, that he did not get the bit of cable until the vessel had returned from laying the cable. Until the trial the defendant had no knowledge of what Curtis would say, and he therefore could not meet his statement as to his having damaged the cable; but now it appeared upon the affidavits, and upon the circumstances of the case, that it was extremely improbable that Curtis could have damaged the cable as he said he had done. It was submitted that the nail could not possibly have been driven without great force, though Curtis said that he had driven it with his knife. Further, Curtis could not have had time to leave off cutting the "stops" as the cable ran out to enable him to drive the nail. There were also many men employed in the hold with him, and there were persons above whose duty it was to see that the men did their duty. The hold was well lighted, and Curtis must therefore have been seen driving the nail, and besides, the noise of striking it would have attracted attention. The learned counsel further commented at great length upon the evidence, contending that the defendant's evidence, and not that of Curtis, should have been believed. The Lord Chief Justice said, as the evidence stood he was not dissatisfied with the verdict; but the circumstances which had been stated as to obtaining the piece of cable were extremely relevant, and those circumstances induced the court to grant the rule. Rule granted.

HOWES v. THE GREAT SHIP COMPANY.—This was an action tried before the Lord Chief Justice at the Court of Queen's Bench on the 17th ult., at the last sittings after term, at Guildhall, when a verdict was returned for the defendant. Mr. Bovill now moved for a rule to show cause why the verdict should not be set aside, and a new trial had, on the grounds, first, that the verdict was against the weight of evidence; secondly, that one of the jurymen was a shareholder in the company; and thirdly, that the plaintiff had not had the opportunity of cross-examining one of the defendant's witnesses, named Yates, who was examined upon a commission. The action was one for royalty, the plaintiff alleging that Captain Harrison had used a patent taken out by the plaintiff for rigging vessels. The defendants put in the evidence of a Mr. Yates, who alleged that the defendants had been supplied with the rigging by Mr. Scott Russell, and not by Captain Harrison; which evidence, the learned counsel now stated, the plaintiff had never had an opportunity to cross-examine. The Lord Chief Justice said he thought the verdict in this case was quite right, although he did not know that he should have interposed if the jury had returned a verdict for the plaintiff. The evidence went to show that the order was that of Mr. Scott Russell, and not of Captain Harrison, and he did not consider the jury were at all wrong in finding the verdict they had upon the evidence that was brought before them.

RUSSELL v. THE GREAT SHIP COMPANY.—Execution against the Company.—This case was tried on the 20th ult. in the Court of Nisi Prius. From the proceedings it appeared that there had been a reference to arbitration, and an award was made in favour of Mr. Scott Russell to the amount of £18,000. An action was commenced upon the award,

NOTES AND NOVELTIES.

OUR "NOTES AND NOVELTIES" DEPARTMENT.—A SUGGESTION TO OUR READERS.

We have received many letters from correspondents, both at home and abroad, thanking us for that portion of this Journal in which, under the title of "Notes and Novelties," we present our readers with an epitome of such of the "events of the month preceding," as may in some way affect their interests, so far as their interests are connected with any of the subjects upon which this Journal treats. This epitome, in its preparation, necessitates the expenditure of much time and labour; and as we desire to make it as perfect as possible, more especially with a view of benefiting those of our engineering brethren who reside abroad, we venture to make a suggestion to our subscribers, from which, if acted upon, we shall derive considerable assistance. It is to the effect that we shall be happy to receive local news of interest from all who have the leisure to collect and forward it to us. Those who cannot afford the time to do this would greatly assist our efforts by sending us local newspapers containing articles on, or notices of, any facts connected with Railways, Telegraphs, Harbours, Docks, Cauals, Bridges, Military Engineering, Marine Engineering, Shipbuilding, Boilers, Furnaces, Smoke Prevention, Chemistry as applied to the Industrial Arts, Gas and Water Works, Mining, Metallurgy, &c. To save time, all communications for this department should be addressed "19, Salisbury-street, Adelphi, London, W.C." and be forwarded, as early in the month as possible, to the Editor.

MISCELLANEOUS.

LARGE STEAM HAMMER.—Messrs. Bain & Wylie, engineers, Glasgow, have just finished a large steam hammer, on the "moving cylinder" principle of the late Mr. Condie. It is to be erected in one of the iron-works near Birmingham. The framing consists of two square cast-iron columns, having a clear working space of 16 feet between them, and bound together by a massive horizontal cast-iron beam. These two columns are surmounted by a pair of segmental frame pillars, which, conjoined, form a complete semi-circular arch, springing up to a height of 23 feet from the floor line. The hammer cylinder is cast of the strongest cold blast-iron, and weighs upwards of five tons, with a fall or stroke of six feet. The valves are wrought by means of a small horizontal steam cylinder, to which they are connected, and the attendant has merely to touch gently the slide valve of this miniature engine to put the enormous weight in motion. This hammer, with its anvil, block, and sole-plate, weighs about 80 tons.

STEAM TRAVELLING CRANES.—Messrs. Taylor and Co., of the Britannia iron-works, Birkenhead, have commenced the erection of a pair of the new description of steam travelling cranes, with the elevating jibs, on each side of the second dock, at Chatham dockyard, in which the *Achilles*, iron steamer, will be built. The tramway and supports for the cranes extend the entire length of the dock, a distance of 330 feet, the works being of the most substantial character. The tramways rest on double rows of supports of great strength, the cranes being required for lifting the immense beams and slabs of iron used in the construction of the new steamer.

IRON CHURCH, SOUTHPORT.—This church, erected only for temporary use, has lately been opened for divine service. Three months since, the edifice was standing at Birkenhead; it was afterwards taken to pieces and transported by rail to its present site, where it has only taken one month to erect. The removal and re-erection was effected at a contract cost of under £200.

A LARGE TELESCOPE has just been finished in New York, having an object-glass 16 inches in diameter, which is the largest in the United States. It is a dialtic telescope, the corrector consisting of a double convex lens of crown glass fitting into one surface of a double concave lens of flint glass. This instrument, when mounted, will be worth about £2,500.

THE ELECTRIC LIGHT IN FRANCE.—The French Minister of Marine, has, it is said, decided to establish eight electric lights on the coast of the departments of the Seine inférieure, to maintain a communication with ships within sight of land, and to transmit news rapidly to the interior.

THE FRENCH NAVY, by command of the Emperor, has been organized into five divisions, each division being placed under the orders of an admiral. Three steel-plated frigates are to be attached to each division.

MR. J. HASWELL, a locomotive builder of Vienna, has invented a very simple and ingenious method of increasing the durability of steam boilers. He introduces into the boiler a small wheel, which revolves and drives forward constantly the water from the back towards the heat, so that at the same time the whole boiler is kept cool and the formation of steam is facilitated.

GRANITE.—A geological fact of some interest has been made out by Mr. Sorby. Upon a close microscopic examination of granite, ground and polished so thin as to be transparent, and then cemented with Canada balsam between two glass plates, he has discovered that this rock contains an immense number of cavities, holding water and saline solutions, which must therefore have been in the liquid state when the rock was in process of formation. It must therefore be concluded that granite is not simply an igneous rock, but that it has been formed by the joint action of fire and water.

MANUFACTURE OF MIRRORS.—Of all the various trades inimical to health, those which involve the inhaling or manipulation of mercury are notoriously the most deleterious. The fabrication of looking-glasses is attended with serious inconvenience to the workmen, and any substitute for quicksilver would be a boon to the mechanic. A patent has been taken out at Paris by which nitrate of silver in a vaporized form is made to do duty as effectually and more permanently. 100 grammes of that substance are dissolved in 500 grammes of distilled water, and a metal bath of suitable expanse, an inch deep, is made to receive the mirror; heat being applied beneath, the exhaled particles coat the glass and silver it uniformly and durably.

PRESERVATION OF IRON, &c., FROM DECAY.—There has lately been patented, in West Hartlepool, an invention which relates to a peculiar composition and enamel for protecting iron and other surfaces from corrosion and decay, and is applicable to iron ships, buoys, reservoirs, gas, water, and other pipes, dock gates, and to various other useful purposes, and consists in the primary application to the surfaces to be protected of a preparatory coating of a red composition, consisting of a combination of litharge, Venetian red, and pine varnish, over which is applied a coating of a composite enamel, consisting of a combination of resins, gums, or any pitchy or bituminous substance, with the addition of coal-tar or oil. They first give the surfaces to be protected a coat of the composition, and afterwards a coat of the enamel, which they pour on in a hot lava state, or they plunge the pipes or other articles to be preserved in the melted enamel, or they spread it over the surface with a brush. The proportions of the ingredients used in the composition or enamel may be varied to suit especial requirements.

It is stated that a company is being projected for the purpose of navigating, by a line of steamers, the river Yang-tse, up to the great port of Shanghai, at its mouth. The capital will be about £120,000. Such a speculation ought to turn out successful, for an immense carrying trade might be created up the Yang-tse.

TIME GUN AT EDINBURGH.—This time gun is established in connection with the time ball on the Calton hill, which was set up some years ago, as a time signal, for the benefit of the city of Edinburgh and also for the port of Leith. It was found, however, that frequently the signal was invisible, through fog or haze, and it was then suggested that the signal, which is worked from the observatory on the Calton Hill, should be connected, by means of an electric wire, with a gun on the castle battery, which should be discharged simultaneously with the fall of the time ball. This suggestion is now carried into execution. A gun has been granted by government for the purpose; but otherwise the expense of putting up and maintaining the signal has been undertaken by the citizens. The apparatus consists of a single strand of electric wire suspended from the Calton Hill to the Castle in one stretch of 1,400 yards, and which, being elevated about 120 feet above the level of the street, will be quite invisible to the naked eye. Should this ordnance time signal prove thoroughly successful, it will in all probability lead to its adoption in many other places.

STREET RAILWAYS.—A Philadelphia paper states that the value of real estate in the suburbs of that city has been raised nearly fifty per cent by the introduction of street railways.

THE LARGEST DOUBLE WINDING ENGINE IN THE COAL TRADE.—This large double winding engine, which created considerable excitement among colliery engineers, has lately been tried. Grave predictions of failure had been made by many engineers in the neighbourhood as to the results of the novelties introduced into the engineering of the trade by Mr. James Marshall, the engineer of the Seaton Delaval Company. The engine consists of two cylinders of 36 inches diameter; and they each have a stroke of 6 feet. The weight of the main shaft and cranks of wrought-iron is 11 tons 13 cwt.; and the two rope rolls are each 25 feet in diameter, and weigh 44 tons. When in full work, the engine will lift 72 cwt. of coals in 25 seconds from 120 fathoms deep, while the rolls are making six and a half revolutions. The peculiarity of the engine is that the two cylinders are worked by double mitre valves instead of the ordinary steam slides; and their gearing, which consists of link motions, same as used by locomotives, is regulated by eccentrics attached to the main shaft. The whole is so connected with one shaft as to be under the most complete control of the engineman, who in a moment can start, stop, or reverse the engine. After the order was given by Mr. Marshall to start the engine, the steam was applied, and the gigantic wheels were in motion. The whole was perfect; not a jar nor a creak—all as smooth as good fitting and superior engineering could make it. The house in which the engine is situated is a substantial piece of masonry. The gearing outside will be in keeping with the engine. Instead of wood beams and balks as formerly, iron shear legs and girders will support pulleys of wrought-iron 20 feet diameter. The pulleys are to be Mr. George Crawshaw's patent, and the hearings will consist of a mixture of copper and aluminum, being a suggestion presented to the public by Mr. Isaac L. Bell.

PROPOSED TUNNEL THROUGH THE ALPS.—A Royal Piedmontese commission is about to be occupied with the question of piercing the Alps, which separate Italy from Switzerland. Various projects have been submitted to the commission; one proposes a route by the St. Gothard, another by Lukmanier, and others by the Splügen, the Bernardino, and the Septimer. The line by the Lukmanier appears to offer the greatest advantages, as the mountain is 750 feet lower than either the St. Gothard or the Splügen. It is expected that the expense of construction would be reduced by this difference, and that the expense of transport would be also lowered. On the other hand, a line following such a route would be 95½ miles long, while one by the St. Gothard would be only 82½ miles, and that by Splügen only 74½. The St. Gothard project has galleries or tunnels extending over 16½ miles, and inclinations of 25 and 26 per 1,000 for 34 miles: the Lukmanier route has 24 miles of similar gradients, and at least 16 miles of galleries; and the line by the Splügen 62½ miles of 25 in 1,000, and 26 miles of galleries. The expense of lines by the St. Gothard and Lukmanier is estimated at £3,600,000, and the Splügen route is set out at £4,000,000. The large towns in the north of Italy, such as Turin, Milan, and Genoa—have a natural interest in the establishment of one or other of these routes. If the object were simply to put Italy in communication with Switzerland, the St. Gothard route would certainly have the preference from all three towns; but if it is desired that an easy iron way be opened to Germany and Belgium, Genoa and Turin would have a right to demand the adoption of the Lukmanier route, and Milan that of St. Gothard.

STEAM SHIPPING.

THE "GIBRALTAR."—A trial of the engines and machinery of this vessel took place on the 17th ult. at the measured mile outside Plymouth breakwater, the pitch of her screw having been altered from 22ft. 6in. to 27ft. 6in. In our last number we gave an elaborate description of the ship and her engines; it is now only necessary to state that she is pierced for 101 guns, has neither masts, guns, nor stores on board, and draws 18ft. forward, and 22ft. 6in. aft. The engines are a pair of direct acting, of 400-horse power each, and possess all the modern improvements. With wind easterly and weather fine she first ran from west to east 11'841 knots; second, 12'676; third, 12'121; and fourth, 13'284; maximum of two runs, 12'7; mean speed of four runs, 12'480; mean revolutions, 59; pres-

sure, 20h. This result is considered very satisfactory. The ventilation of the engine room and stokehole was well maintained, and the vibration of the propeller (Griffith's) was comparatively small.

THE "HIBERNIAN."—This vessel is the first of two new steamships to be placed on the Montreal and Quebec line by the Montreal Ocean Steamship Company, (and together with the sister ship, the *Norwegian*) built by Messrs. W. Denny and Brothers, of Dumbarton. Her tonnage is 2500, and her engines of 400-horse power; draught of water, aft, 16ft. 10in., forward, 15ft. 3in. The engines are Spencer's patent, and were fitted by Messrs. Tulloch and Denny, or Dumbarton; and although they are of an entirely new arrangement, they were not once stopped during the whole passage from the Cloch lighthouse to the Bell Buoy, and a steady vacuum of 27in. was easily maintained. They also combine a large effective power with considerable economy of fuel, saving not less than from 200 to 300 tons each voyage, thus establishing the fact that the arrangement of condensers advocated for so many years by the patentee (Mr. Spencer), is fully efficient for forming a good vacuum, whilst in its less cost and facility for repair, it has greatly the advantage of any yet introduced, and they are likewise worthy of notice as being the first successful introduction of surface condensation in engines of large power since the days of Samuel Hall. Nearly thirty of these condensers are being introduced into steamships, and it is believed that the simplicity of Mr. Spencer's arrangements will effectually avoid past failures. On the main and lower decks she has berths for 101 cabin passengers, 30 second class, and 350 steerage passengers. The saloon is a very fine apartment, 70ft. long and 8ft. high, well ventilated, and tastefully fitted up. The steering gear is on the latest principle, and the vessel's course is regulated by five compasses—two aft, one on the mizemast, one on the bridge, and one in the fore part of the ship. Among other appliances the anchors are hoisted by steam, and the eight large lifeboats are fitted with Clifford's patent lowering apparatus. Every new improvement for expediting and economising labour and the safety of passengers and the crew has been adopted. No expense seems to have been spared in making the *Hibernian* a model steamship in every department, and, in fact, she is all that can be desired. A fine model, stiff, yet easy for passengers.

NEW RIVER STEAMER.—Messrs. Samuda, of Millwall, are now constructing a steam vessel for foreign river navigation, on a peculiar and rather novel plan, but one which they have before adopted in steamers sent out to the Volga. This vessel is 190ft. long, 22ft. beam, and will draw only 2ft. 10in. when its machinery and passengers are on board. It is built principally of steel, in three separate compartments, which can be detached from each other at pleasure and with but little difficulty, leaving each part perfect in itself, and sufficiently short to allow it to pass through the various locks it may be called to traverse, which will often not admit vessels of more than 100 feet.

THE "OCTAVIA," 51, screw, was floated out of the dock at Portsmouth on the 11th ult., on the completion of her lengthening and conversion from a sailing ship to a screw. She is to be fitted with three cylinder engines and surface condensers. This ship has not been lengthened by the bow, but merely amid-ships, with the necessary length added to her stern to adapt it to the screw, and will, for this reason, as well as owing to her peculiar form of bottom, carry but a small quantity of fuel.

STEAM BETWEEN DUNDEE AND NEWCASTLE.—A limited liability company, with a capital of £10,000, has been formed at Leith for the purpose of putting on steam vessels between Dundee and Newcastle.

THE "PIGEON," steam gunboat, 60-horse power, left Chatham on the 15th ult. for the trial of her machinery at the measured mile. The engines worked most admirably, and the vessel attained a mean speed of 8½ knots per hour, though a very strong and contrary wind was blowing at the time.

THE "MEENEE," 80, line-of-battle ship, which has been converted from a sailing vessel to a screw steamer, and fitted with engines of 400-horse power, was taken out of Sheerness harbour on the 12th ult., and proceeded on a trial trip to the Nore to test her machinery. The trial lasted nearly seven hours, and was a most successful one, the machinery working remarkably well. The draught of water aft was 23ft. 10in.; forward, 20ft. 10in.; pressure, 20; vacuum, 25; number of revolutions per minute, 56. The *Meenee* is attached to the first class steam reserve in the Medway, and has all her stores, spars, gear, and armament on board.

THE "HYENA" AND "NIGHTINGALE" GUNBOATS went, on the 12th ult., outside Plymouth breakwater to make a trial of their engines. The trial is stated to have been so satisfactory that the engines are reported fit for service at sea.

NEW SCREW.—The screw lately introduced by Messrs. J. & W. Young, of Glasgow, having been applied to a small wooden boat, 30ft. long, and with a 5in. cylinder, 4½in. stroke, and screw 2ft. 6in. in diameter, propelled the boat between 9 and 10 miles an hour. An experimental screw, in which the blades were thrown as much forward as Donaldson's were thrown aft, was designed and tried some years ago, and found to answer very well. The finer the run of the vessel, or the further comparatively that the screw is removed from the stern, it has been found to act with better effect for speed, causes less vibration, and does not injure the steering, though it is liable to foul. Mr. Sturdee's application of a double stern to prevent fouling, in which the screw works in a channel formed by the twin navies, has not been tried on a sufficiently largescale to furnish reliable data.

TWIN STEAMSHIPS, &c.—A return, moved for by Mr. Corry, just issued, gives a comparative statement of the line-of-battle ships, iron-cased ships, frigates, gun-boats, &c., afloat on the 31st March, 1859, and the 31st March, 1861, showing that the total number afloat, building, and converting at the last-mentioned date, was 479, as against 387 in 1859. The number of vessels of all classes launched for the period of two years is 71; converted, 13; total number added afloat, 84; tonnage built, 108,653. The total horse power of the navy afloat on the 31st March, 1859, was 89,732; on the 31st March, 1861, 113,203; increase in the two years, 23,471.

THE "SCARUS," 11, screw, underwent her trial of machinery on the 18th ult.; she drew 12ft. 3in. forward, and 13ft. 6in. aft.; pressure of steam 20; vacuum forward, 24½; aft, 25½; revolution of engines—maximum, 94, mean, 86; engines by Messrs. Rennie and Sons. The common screw was used with its leading corners cut off, at a diameter of 10ft., and a pitch of 14ft. 6in. Immersion 11 inches. The trial, which lasted four hours, and during which some very severe tests were applied, proved her machinery to be in excellent working order, and the boilers throughout gave a thoroughly efficient command of steam.

THE "WARRIOR," iron-cased steam vessel, has been fitted with her masts. The main and fore topmasts of this vessel are of large size and great strength, and weighing rather more than 3 tons. The mizen topmast measures 50 feet, and its weight is about 2 tons. The fore and main yards are each as large as the masts of many large ships, each measuring 105 feet in length, and weighing upwards of 6 tons. The length of the mizen yard is 71 feet. The three topsail yards are also of great size and strength, the two largest being each 74 feet long, and weighing about 2 tons. The whole of these masts, yards, &c., have been constructed of unusual strength under the superintendence of the officials at Chatham. Her cables, 2½in. in diameter, were proved at Woolwich on the 16th ult., and stood a tension of 100 tons.

THE "DEFENCE," IRON-CASED FRIGATE, was launched, on the 24th ult., from the building-yard of Messrs. Palmer, of Jarrow on the Tyne. The following are her dimensions: extreme length over all, 291 feet; breadth, 54 feet; depth from the upper deck, 39 feet; tonnage, 3,700 tons, builders' measurement. The engines will be 600 nominal horse power, and are to be manufactured by Messrs. Penn and Sons, London. It is

expected the *Defence* will steam at the rate of 12 knots an hour. She is pierced for 28 guns on the main deck, all of which will be of the heaviest calibre. The upper deck will be armed with four 40 pounders, and two pivot guns of 100lbs. each, all Armstrongs. Owing to the improved construction of the ship's gun carriages, the portholes are reduced to half their usual size. The masts and spars of the *Defence* will be very light—merely those of an ordinary first class frigate. The bows and stern of the ship are divided into twenty-eight water-tight compartments, and are shut off from the engine-room and fighting part of the ship by wrought iron transverse bulkheads. There is no external keel to the ship, but an inner kind of girder, which acts as keelson. This is formed of immense slabs of wrought scrap-iron 14 in. thick, and 3 ft. 6 in. deep. To it are bolted the ribs—massive wrought-iron T shaped beams, three-quarters of an inch thick. Above the keelson, and inside the ribs, are five immense strong box girders, which go the whole length of the ship, from stem to stern, and from which spring diagonal hands tying every rib together. The orlop deck is of wood. The main deck is of iron, caased with wood, and 9 feet above the orlop. The upper deck is also of iron, caased with wood, and 7 ft. 9 in. above the main. All these decks are carried on wrought-iron beams, to which both deck and ribs are bolted as in one piece. The weight of the plates on both sides is 500 tons, and the severest tests have been applied to the plates with the most favourable results.

RAILWAYS.

ANOTHER METROPOLITAN RAILWAY is being promoted, namely, the Buckinghamshire and West Midland, to be about 60 miles, and to come into Sloane-street. It is calculated to shorten the distance to Worcester by about 20 miles, and is expected to bring about 300,000 tons of coal to London annually.

THE GREAT WESTERN OF CANADA has involved a capital expenditure of £4,976,049. The traffic receipts for the half year ending 31st January last were £252,824. The working and other expenses were £121,407. Deducting interest and £25,690 for the renewal of rails, sleepers, bridges, &c., the balance is £52,142. The dividend is at the rate of 3 per cent. per annum. The increase in the receipts for the last half year was £45,321 over those of the corresponding period of 1859, the expenses being only £5236 more, leaving a nett increase of £40,085. The estimated annual cost of renewals for the next five years is estimated at £60,000.

THE SMYRNA AND ADEN RAILWAY will cost about £15,000 per mile—the whole length being 80 miles, instead of 72 as originally contemplated. Mr. Crampton, the contractor, holds 26,000 shares.

STREET RAILWAYS.—On the 15th ult. Mr. Train opened his second instalment of a line running from Victoria Station to Westminster Abbey, a length of about a mile. Several other vestries have also given Mr. Train permission to lay down his railway.

IRON RAILROAD CARS.—The New York Central Railroad Company, U.S., intend introducing iron cars quite extensively, and a great number are now being made in Albany. An accident that recently took place at New Jersey demonstrated that iron passenger cars are of great utility in protecting human life at the time of disasters. An iron car thrown into the river was but slightly damaged, and preserved all the passengers, while it was conceded by all present that a wooden car, under the circumstances, would have been shivered into fragments.

INDIAN RAILWAYS.—Every account from India speaks of the insufficiency of capital raised for the completion of the lines on hand. Above £20,000,000 more will be required, and there is but little chance, without it is raised in England, of obtaining it.

GREAT SOUTHERN RAILWAY OF INDIA.—The 14½ miles of this railway, from Neginapatam to Trivalore, was expected to be opened this month, and the entire line to Trichinopoly in September next. Thus in two years the first section will have been completed, and at a cost, it is believed, not exceeding £7000 a mile.

TELEGRAPHIC ENGINEERING.

MALTA AND ALEXANDRIA CABLE.—The *Rangoon* and *Malacca* are ordered out to the Mediterranean to lay the cable between Alexandria and Malta. On their return, it is probable the rest of the Rangoon and Singapore cable will be taken out.

FRENCH AND ALGERIAN CABLE.—The English engineers charged with the task of getting up the broken electric cable between France and Algeria, have succeeded in raising part of it, and have been able to transmit messages to Algiers and received replies.

MALTA CABLE.—The local electric cable consisting of land and submarine wires, connecting the different naval and military stations with head-quarters at Valosta, commenced working on the 11th ult.

MILITARY ENGINEERING.

ARMSTRONG GUNS.—The issue of rifled guns to our ships is being gradually effected, so fast as the weapons themselves are forged and transmitted to our naval yards. The *Marlborough*, in her new commission, has been ordered to receive 9 Armstrong cannon, in the following proportion:—Two 40-pounders, to be mounted on truck carriages, *vice* two 32-pounders of 25 cwt. on her upper deck; two 40-pounders on truck carriages, *vice* two 32-pounders of 56 cwt. each on the lower deck; four 40-pounders on truck carriages, *vice* four 32-pounders of 42 cwt. on the main deck; one 100-pounder gun, on a revolving side carriage, in lieu of a 68-pounder, 95 cwt. gun upon the fore-castle. The whole of this armament is now ready for the ship, and vast stores of rifled ammunition are being accumulated, both at Woolwich and at the naval arsenals, for immediate shipment whenever required.

THE FORTS AT SHARNMEADE and Coalhouse Point, near the entrance to the river Thames, are being dismantled with all speed, in order that they may be reconstructed and mounted with an increased number of guns of heavier calibre.

NEW KIND OF GUNS.—Two guns, constructed on a new principle as to form, have been completed by the Mersey Steel and Iron Company for Government. They are of puddled steel, and have been consolidated by the heating of the steam-hammer. They are each 9ft. 6in. long, and in shape are about double the diameter from the butt to the trunnions, from which they gradually taper to the muzzle. In weight they are about 4 tons 3 cwt., and, although only 6½ in. bore, they are intended for 100lb. shot. Their external surface is highly polished, which shows the closeness and excellent texture of the metal. The order for the manufacture of these guns is understood to have arisen from the fact that, at the testing of 4½ in. wrought iron plates at Portsmouth, those sent by the Mersey Steel and Iron Company far exceeded in strength all the others, one plate having received seventeen shots without any material injury.

EXTRAORDINARY SHOOTING WITH THE WHITWORTH RIFLE.—In the course of the first week in April last a series of trials were made at Scarborough by Mr. G. F. L. Collinson, with a Whitworth rifle. During the shooting the Government target, 12ft. by 6ft., was used. The following is a summary of the shooting:—

	Points,
45 shots at 800 yards	46
20 shots at 800 yards, standing	23
30 shots at 900 yards	31
10 shots at 900 yards, standing	11
25 shots at 1000 yards	21
10 shots at 1000 yards, standing	8

Total..140

Total Points..139

FORTIFICATIONS AT CHATHAM.—In order to afford still greater protection to the important dockyards at Chatham and Sheerness an additional line of fortifications is to be effected at the entrance to the Medway, the preparations for which have commenced. The new line of defences will consist of casemated batteries, bomb proof, and all armed with 68-pounders and 10in. guns of the heaviest calibre. It is also proposed to mount guns, *en barbette*, above the casemates, which will materially add to the strength of the works, and, with the present extensive system of fortification, render the entrance to the Medway almost impenetrable.

LAUNCHES OF STEAMERS.

LAUNCH OF THE "RESISTANCE," IRON-CASED FRIGATE.—Another of these formidable ships of war was most successfully launched, on the 11th ult., from the London Yard, Isle of Dogs, Poplar, where she has been built by Messrs. Westwood, Baillie, Crambell & Co. The principal dimensions are as follows:—Length, extreme, 292ft.; breadth, extreme, 54ft.; depth from spar deck, 33ft. 2½ in.; builder's measurement, 3,668½ tons. The *Resistance* will draw 25 feet when down to the water line. She is built entirely of iron, with the exception of two layers of teak, which are placed, one vertically and the other horizontally, between the skin of the ship and the armour-plates, the one layer being of a thickness of 9 inches, and the other 10 inches. The armour-plates, which extend to a length of 144 feet, terminate at the "armour bulkheads," which are water-tight compartments at each end, and reach in depth from the hullwarks to the water line. It is expected that the ship will be more buoyant thus constructed than if she had been encased in these plates from stem to stern. The plates are made of the best rolled iron, in lengths of 17ft., and of a thickness of 4½ in., each plate being bolted by 14 ½ in. bolts, and each plate is tongued and grooved—forming, in fact, a massive wall of iron. It is impossible to conceive that any projectiles can pierce through such plates as these—at least so as to do any material injury; and the whole vessel is so constructed as to present in every point of view immense strength and solidity.

"CITY OF NEW YORK."—On the 12th ult. Messrs. Lod and McGregor, of Glasgow, launched a new steamer for the Liverpool, New York, and Philadelphia line of steamers. No pains have been spared to make this vessel, which is to be called the *City of New York*, one of the most convenient passenger vessels afloat. Her tonnage is of 2560 tons, and her engines are of 550 horse power.

NEW DREDGING MACHINE.—Mr. R. H. Michell has just launched, at Cardiff, his new iron screw propeller dredging machine. It is about 80ft. long by 27ft. beam, and is to be worked by two direct acting engines of 60 horse power collectively. It has a ladder on each side capable of working to a considerable depth of water, the buckets containing each one-fifth of a cubic yard. A screw propeller will be attached for use when at sea; and the screw dredger is, it is said, to be first used for obtaining an entrance to the Briton Ferry Floating Dock, on which account its completion is being hastened with all possible despatch.

RAILWAY ACCIDENTS.

AN ACCIDENT occurred on the Lancashire and Yorkshire Railway, on the 3rd ult., involving much destruction of property, but fortunately no loss of life. A luggage train started from Sowerby-bridge for Leeds, at half-past one o'clock, and went well till it came to the junction at Milner-road-bridge, the junction where the trains leave the main line and turn towards Halifax, &c. From some cause not yet satisfactorily explained, the points did not act properly, and the engine ran off the line. So also did the tender, guard's van, and three of the trucks, and ran about one hundred yards, when the engine, tender, and van all overturned. Strange to say, the driver and stoker were almost unharmed, only shaken, and the former resumed work in a few hours. The guard did not escape so easily, but when the van turned over fell out, and thereby sustained a fracture of the right ankle. The line was torn up, many rails were thrown out of place, and the wooden sleepers broken into matchwood. The engine was, of course, quite disabled, but not permanently, while the guard's van had sad havoc played with it. The hind wheels were riven off, and the buffers and a good deal of the iron-work twisted as though they had been only paper.

A SERIOUS ACCIDENT on the line from Aix to Maestricht occurred on the 5th ult., the train having got off the rails, and six carriages fallen down the high embankment in the valley of Eys. One person only was killed, but several others were severely injured. It was considered wonderful that so little loss of life occurred, as the carriages were literally broken to shivers.

DESTRUCTIVE ACCIDENT ON THE GREAT NORTHERN RAILWAY.—On the 11th ult. an accident of a most destructive nature, but happily unattended with loss of life, occurred at the Great Northern Railway station, Leeds. It appears that a heavily laden goods train was proceeding to get on to the "high level"—a siding line used for the reception of goods—and was backing from Copley Hill, when, on passing the Holbeck station, 24 of the waggons, including the guards' van, got uncoupled. The gradient towards the Leeds station at this point is very considerable, and the detached trucks immediately rushed towards Leeds with terrific force. They entered the station, and, rushing along, came violently into collision with 14 stationary passenger carriages belonging to the Yorkshire and Lancashire Company. The result was that the 14 carriages were all more or less damaged; three of them being smashed into splinters, as if they had been pill boxes, and the rest had either sides knocked in, roofs taken off, or the hodies taken from the wheels. It is estimated that the amount of damage done will be nearly £2000.

BOILER EXPLOSIONS.

THE ASSOCIATION FOR THE PREVENTION OF STEAM BOILER EXPLOSIONS.—The ordinary monthly meeting of the Executive Committee was held on Tuesday, at the offices, 41, Corporation-street, Manchester; William Fairhair, Esq., C.E., F.R.S., President of the Association, in the chair. Mr. L. E. Fletcher, chief engineer, presented his monthly report, from which the following is abridged: "During the last month six special visits have been made, and 199 ordinary visits, making a total of 205 visits. Nine boilers have been examined specially, 504 boilers have been examined externally, 24 internally, and 21 thoroughly, making a total of 558 boilers examined. One engine has been examined specially, and 435 at ordinary visits, from 30 of which indicator diagrams have been taken. The following are some of the principal defects which have been found to exist in the aforesaid number of boilers inspected, and to which the attention of the owners has in each case been called, not only at the time of the visit, but also by a subsequently written report:—Fracture, 10 (2 dangerous); corrosion, 10; safety valves out of order, 26 (2 dangerous); water gauges out of order, 27 (3 dangerous); pressure gauges out of order, 13 (1 dangerous); feed apparatus out of order, 5; blow-off cocks out of order, 23; fusible plugs out of order, 4; furnaces out of shape, 10; over pressure, 1; deficiency of water, 3 (1 dangerous). Total, 132 (9 dangerous). Boilers without glass water gauges, 9; without pressure gauges, 6; without blow-off cocks, 11; without feed check valves, 53. Although nothing of startling interest has occurred during the past month, still the ordinary working of this Association during that period has shown the important value of a regular system of boiler inspection, and thus that it has an importance entirely apart from all considerations of the saving of human life and property endangered by boiler explosions. In illustration of this, it was stated that several boilers have been met with, the proprietors of which had gone to the expense of having them fitted with brass scum and mud or blow-out taps, as well as the full complement of necessary mountings, and who were under the impression that these were properly attended to, and that all was done that could be to keep their boilers free from deposit and promote their efficiency and durability. Upon inspection, however, it has frequently been found

that these scum and blow-off taps have been quite neglected, and have become choked up with sediment. This has taken some of the proprietors quite by surprise, and they have felt obliged by being undeceived. Some blow-off taps are found to be quite dangerous from their construction; the shells being of cast iron, and the plugs of brass, which, on account of their unequal expansion, stick as soon as they are opened, and cannot be closed again, and thus the whole of the water is blown out, the furnace crowns are left dry, and the fires have to be drawn. Three tubular boilers were examined during the last month, which have been so injured as to run a stream at the tube ends and other places, mainly from the neglect of suitable blowing out, and will require the removal of all the tubes, and a large outlay upon them before they will be again fit for use. The value of scum pipes was pointed out, not only on account of their beneficial effect on the boilers themselves, but also on the piston and slides of the engines, by preventing a quantity of earthy matter being carried over in small particles with the steam. It was stated that the water should be blown off from the surface when it is in a state of ebullition, and from the bottom when in a state of rest."

GAS SUPPLY.

THE GLASGOW GAS COMPANIES have issued a statement to the effect that they are prepared to reduce the price of gas to the citizens from 5s. to 4s. 7d. per 1000 cubic feet. The Oxford Gas and Coke Company have also announced that their price of gas is now reduced to 4s. 6d. per 1000 cubic feet.

GAS ON STEAMERS.—The use of gas is now becoming general in the river and bay steamers at New York. One steamer on the Stoning and Boston line has had 260 burners fitted up. The cost of so many lights for the voyage is about 16s.; the quantity of gas consumed, 1400 feet.

THE PARIS GAS CONSUMPTION for the last six years has been as follows:—33,000,000 cubic metres, or 1,164,489,216 cubic feet in 1855; 44,000,000 cubic metres in 1856; 52,261,000 cubic metres in 1857; 57,920,000 in 1858; 63,015,000 in 1859; and 70,348,600 cubic metres, or 2,482,429,860 cubic feet in 1860.

DOCKS, HARBOURS, CANALS, &c.

BERKENHEAD DOCK WORKS.—At a recent meeting of the board in connection with these works, it was stated that the total sum expended on them, since they came into the hands of the board, had been £338,762, up to the present time. It was also stated that the works themselves are being rapidly proceeded with. A very considerable portion of the hydraulic apparatus for working the sluicing runs had been received, and is in course of being permanently fixed; and for the coal trade accommodation two of the three hydraulic hoists have been completed, and the third is in course of erection, as well as a large crane capable of lifting sixty tons, on the side of the great float.

OVER THE ALLEGHANY RIVER, Pittsburg, U.S., the canal is carried on a suspension aqueduct of seven spans of 160 feet each. The two suspending cables are of iron wire, and from these hang iron rods, supported by timber cross-beams, and the wooden bank which forms the water channel, 16 feet deep and 8 feet wide.

GRAND SURREY DOCKS AND CANAL COMPANY.—The annual meeting of shareholders of this company was held on the 16th ult. A report of the past year's operations show an increase of 99 sail and 69,392 tons on the twelve months, as compared with 1859. The company derived a revenue from this branch of the business of £25,263, besides commensurate increase in dock dues. The profit and loss account, including the previous balance, showed a surplus of £20,759 applicable to dividend, out of which it was proposed to pay a dividend of £5 a share, which would absorb £8,320, leaving £12,439 to be carried to the account of the present year.

NEW WESTMINSTER BRIDGE.—The last arch of Old Westminster Bridge was removed on the 25th ult. In the course of three months the foundations of the old piers will have been removed, and the work of completing the eastern half of the new structure will be going on rapidly towards completion. The work which yet remains to be done is unfortunately of a kind that cannot be much hastened, yet there is no doubt but that the close of the present year will see it nearly if not quite completed. Full details with copious illustrations will be found in several of THE ARTIZAN numbers of 1859 and 1860.

RAILWAY BRIDGE OVER THE RHINE.—The inauguration of this great bridge over the Rhine at Kehl took place on the 16th ult, amidst a large concourse of people, including very many eminent engineers. This bridge is composed of three fixed and two moveable *travées*, the former having 183ft. opening each, and the latter 85ft., opening each. The total length from one abutment to the other is 765ft. The fixed *travées* are formed of iron girders, with lattice-work supporting small beams, on which the rails are laid. The girders are about 16ft. 6in. high, and are bound together in their upper parts by iron bars. This iron truss-work has a total length of 577ft., and its weight is about 240 tons. The two moveable *travées* are furnished with turning bridges formed by three girders *en tôle pleine*, supporting small iron beams. Each turning bridge is about 210ft. long, and its weight is about 260 tons. This bridge has been constructed in two years, and cost £320,000.

ON THE Lexington and Danville Railroad, U.S., over the Kentucky river, a suspension bridge is now being constructed, which will have a span of 1,224ft., over a chasm of 300ft. deep. When completed, it will be the longest span in the world.

THE PROPOSED VIADUCT AT RUNCORN.—The Admiralty has reported in favour of the proposed railway viaduct across the river Mersey, at Runcorn. This viaduct, if completed, will be one of the greatest public works in Lancashire and Cheshire. The magnitude and extent of the proposed works will be seen from the following extracts from the Admiralty report:—"It is now proposed by the London and North-Western Railway Company to construct a viaduct, to consist of three spans of 300ft. wide each in the clear, and with a headway of 75ft., at the under side of the girders, above high-water mark; and other waterways of about 500ft. more. This proposition, to a great extent, meets the requirements of the Admiralty; but, considering how very narrow the channel of the river is at Runcorn, and that the river opens out above and below, their lordships must require—1. That on the south side the abutment be set back, and the Castle Rock be cut off to the extent of 100 feet; that there be four piers placed in the river, with five arches of 300 feet span each in the clear, and with clear headways of not less than 75ft. each, above high-water mark ordinary spring tides. 2. That in consequence of the narrow channel of the river at the site of the crossing, the railway company shall clear away, to low water mark, all rocks in the bed of the river within 100 yards of the north end and east side of the viaduct, so that the waterway on flood and ebb may be improved. It has been stated to their lordships that the proprietors of the Bridgewater Canal intended to cut away or widen the river on the western side of the south abutment of the bridge and shore, immediately below the site of crossing proposed, which, if done, will admit the flood and ebb tides to pass more freely up and down—an additional reason, therefore, for the increase of the waterway at the site of the bridge.

SEWERAGE WORKS.

METROPOLITAN SEWERAGE.—The amount authorized to be raised for the main drainage of the metropolis is £3,000,000, which has been contracted for at 3½ per cent., of which £600,000 has been received. The sewers intended will extend to 73 miles, 1743 yards.

EXPORT OF COAL, &c.—A parliamentary return just published, giving an account of the quantities of coals, cinders, and culm exported from the United Kingdom to foreign countries and British settlements abroad, states that in the year 1860, 7,050,388 tons of coal were exported; cinders, 217,61 tons; culm, 13,633 tons; total, 7,311,632 tons, besides 90,743 tons of patent fuel.

MINES, METALLURGY, &c.

FRENCH COAL.—From a document just published by the committee of coal-pit owners it appears that the extraction of coal in France in 1857 was 7,900,000 tons from 62 coal fields. Of that quantity 6 fields yielded not less than 6,485,200 tons—namely, that of the Loire, 2,242,000 tons; the Nord and Pas de Calais, 1,960,000 tons; Gard, 754,000 tons; Blanz and Creuzot, 586,000 tons; the Allier, 485,000 tons; and the Aveyron the remainder. From 11 other districts quantities varying from 40,000 to 200,000 tons were extracted; and from the other 45 the quantity obtained was consequently but very small. In 1852 the total extraction was only 4,900,000 tons, so that in the space of five years it has increased by 3,000,000 tons.

THE NERBUNDA COAL AND IRON Co.—This coal still continues to look well in the level, which, as well as the pit, is progressing satisfactorily. There have been 20 tons already raised by merely driving the level, and it is fully expected as much can be raised as required on receipt of tools, plant, &c.

THE COAL SUPPLY TO THE METROPOLIS.—For the three months ending March 31 last, 451,210 tons of coal have been conveyed to the metropolis by the various railway companies having access thereto, as against 361,574 tons last year, the increase being 89,636 tons; the coals by canal during the same three months of the present year have been 4,761½ tons, showing a decrease of 6¼ tons on the arrivals of last year's first quarter. Of this quantity, the London and North-Western have conveyed 195,144 tons; the Great-Northern 168,034 tons; Eastern Counties, 39,652 tons; Great Western, 22,521 tons; Midland, 15,355 tons; South-Eastern 4,817 tons; South Western (March), 4003 tons; Hertford, Luton, and Dunstable (March), 874 tons; Chatham and Dover, 505 tons; London, Tilbury, and Southend, 302 tons.

TEMPERING STEEL.—The steel should be hardened in the usual way, by heating it to a cherry red, and plunging it in cold water. The temper is then to be drawn by moderately heating the steel again. Different tempers are required for different purposes, and the degrees of heat for each of these, with the corresponding colour is as follows:—Very pale straw yellow, 430°—the temper required for lancets. A shade of darker yellow, 450°—for razors and surgical instruments. Darker straw yellow, 470°—for penknives. Still darker straw yellow 490°—for chisels and shears for cutting iron. A brown yellow, 500°—for axes and plane-irons. A yellow tinged slightly with purple, 520°—for table-knives and cloth shears. Light purple and dark purple, 350° to 520°—for swords and watch springs. Dark blue, 570°—for small fine saws. Pale blue, and still paler blue, 590° to 610°—for large saws, the teeth of which require to be set with pliers and to be sharpened with a file. The same colours with a tinge of green, 630°—too soft a temper for steel instruments.

THE FORCE OF GRAVITY IS APPLIED TO METALLURGY in M. Toussaint's washer or separator. The metalliferous sand or ore is put into a long tube, filled with water. In conformity with the mechanical law that when bodies of nearly the same dimensions, but of different densities, are put into the same resisting medium, the heavier fall with greater rapidity, the various bodies thrown into the tube are deposited at the bottom, in homogeneous strata, in the order of their density; and thus the metallic or metalliferous parts are collected with but loss. M. Jacobi, of St. Petersburg, entertains great hopes of the successful employment of M. Toussaint's apparatus in the mining districts of Russia.

TIN-STREAMING IN SPAIN.—An influential company is in course of formation, with a capital of £20,000, in shares of £1 each, for leasing and developing a property 356 English acres in extent, situate about 30 miles from Vigo. A ton of tin can be produced at a cost, including all charges, under £65 per ton, which will leave a profit of some £80 on each ton treated. The works are all open, no underground workings, nor expensive machinery being required. Water is abundant, and labour plentiful at 1s. per day per man. No shares are to be allotted until two-thirds are subscribed for, and unless that amount be taken all deposits will be returned in full.

GOLD IN BAHIA.—Late Brazilian advices report the discovery of gold deposits in the province of Bahia, within a few miles of the Bahia railway. Nothing, however, is stated as to their probable value.

APPLIED CHEMISTRY.

ON THE ACTION OF CARBONATE OF SODA ON CAST IRON.—C. Tissier, director of the Aluminium Works at Amfreville, has published some interesting experiments on this subject. Tissier's attention was first drawn to the fact that the mixture of carbonate of soda, chalk, and charcoal used in the manufacture of sodium—notwithstanding the great excess of carbon it contains—does not affect the malleability of the iron of the retorts which are employed. He found, further, when a piece of cast iron was submitted to a high temperature with this mixture, that it was first converted into steel, and finally into malleable iron. This led him to try the effect of the action of carbonate of soda alone on both malleable and cast iron. Malleable iron thus treated remained unchanged, while the soda salt extracted the carbon and silicium from the cast iron, thereby converting it into infusible malleable iron. If a specimen of pig-iron (that experimented on contained 6½ per cent. of silicium and free carbon) be exposed for several hours at a red heat, in a crucible containing an excess of carbonate of soda, the following reactions may be observed. As soon as the temperature is sufficiently elevated, the mass commences to rise, and large bubbles of carbonic oxide are given off, burning with a yellow flame. If after the evolution of carbonic oxide has ceased, the fire is allowed to go down, and the iron taken out with tongs and freed from adhering salts by means of a hammer and by water, the metal exhibits a completely etched surface, although the form of the mass is unaltered—it may be drawn out under the hammer and forged either hot or cold, and the granular fracture of the cast iron is replaced by a fibrous crystalline texture—the mass is porous, the little cavities being filled with white silicate of soda, formed from the silicium contained in the metal. The iron thus obtained is scarcely attacked at all by chlorhydric acid in the cold, and but slowly even when heated. Dilute nitric acid acts upon it with energy, but still not so rapidly as in the case of ordinary malleable or cast iron. Tissier considers it conceivable that this action of carbonate of soda not only extracts the carbon and silicium, but also must remove the phosphorus and sulphur contained in the iron. It is further possible that the iron takes up a portion of sodium, which does not injure it, but on the contrary the metal acquires desirable properties, as evinced by the fact of the dealers being very willing to purchase the worn out retorts from the sodium works. If sodium be not thus taken up, we must assume that for every equivalent of carbonic oxide an equivalent amount of anhydrous soda is formed. Tissier suggests that in the process of annealing or the conversion of cast iron into malleable iron, now accomplished by packing and heating for a long period with substances rich in oxide of iron, it may be possible to substitute fusion with carbonate of soda, it possessing the advantage that the metal can be removed from time to time to watch the progress of the conversion into steel or malleable iron. The author hoped by this method to convert large masses of cast-iron into malleable metal, such as heretofore could only be obtained by forging, but the length of time required for the conversion of a mass of any considerable thickness, and the porosity of the iron obtained, present practical difficulties requiring some modification to overcome them. With smaller castings, however, the action, even when superficial, imparts to them great toughness, so that they no longer are liable to fracture. The amount of carbonate of soda required, when properly used, is inconsiderable, but it should be pure; or, if the commercial article be used, it must first be heated with carbon in order to reduce the sulphate of soda to sulphide of sodium, as the alkaline sulphates have a powerful action on iron at a red-heat.

LIST OF NEW PATENTS.

Dated November 24, 1860.
2888. P. Dorgeral, Lyon, France—Manufacture of silk and other fabrics.

Dated December 7, 1860.
2998. C. J. Hill, Froliche Cottage, Turnham Green—Presses for stamping medals, embossing, and cutting or punching out metal or paper.

Dated December 17, 1860.
3090. J. G. Taylor, Merchant, Paris—Dress and other fastenings.

3100. J. G. Taylor, Paris—Manufacture of boots and shoes.
3091. A. S. Stoker, Wolverhampton—Manufacture of tyres for wheels.

Dated January 5, 1861.
338. J. Roberts, Upton, Kent—Improved warming hassock or footstool.

Dated February 7, 1861.
306. T. Gee, Nottingham—Production of a new composition, of which refuse leather is the chief ingredient.

Dated January 14, 1861.
99. C. Brush, Enfield, Meath, Ireland—Fog signals for railways.

Dated January 21, 1861.
153. F. W. Perrot, Hanover-cottage, Hanover-street, Walworth—An improved lubricating grease or paste for railway wheels.

Dated February 9, 1861.
333. C. White, Pontyprydd, Glamorgan—Rolling machinery.

Dated February 13, 1861.
370. J. S. Blake, Portsea, G. C. Lingham and J. Nicklin Birmingham—Apparatus for holding or filing receipts.

Dated February 14, 1861.
378. E. Rimmel, 96, Strand—Impregnating the atmosphere with perfume or purifying vapours.

Dated February 22, 1861.
449. J. Reeves, New York—Electro-magnetic engines for obtaining and applying motive power.

Dated February 20, 1861.
420. Tbos. Holstead, Botchergate, Carlisle—Apparatus for the manufacture of confectionary and biscuits.

Dated February 21, 1861.
438. H. P. Ribton, Dublin—Safety Apparatus for fighting mines.

Dated February 23, 1861.
464. A. Duriez and S. Emsley, Roubaix, France—Apparatus for preparing fibrous materials to be combed or spun.

Dated February 25, 1861.
474. J. Pinchbeck, Reading—Glass water-gauges and pet taps of steam-boilers.

475. C. Sallows, Maidstone—Action or motion of the Kent brush drill at present used in agriculture.

484. J. Howard, and E. T. Bousfield, Bedford—Construction of windlasses.

Dated February 27, 1861.
504. C. Stevens, 31, Charing-cross—Improved iron blinds.

Dated February 28, 1861.
512. J. Bailey and J. Quamby, both of Staleybridge, and E. Burns, Manchester—Improvements in cop tubes.

Dated March 1, 1861.
524. H. R. Martin, 44, Frith-street, Soho—Apparatus for indicating the names of railway stations to passengers.

Dated March 2, 1861.
534. T. Haigh and A. Robertson, Liverpool—Apparatus applicable for boiling, cooling, and fermenting malt liquors.

538. F. Wright, Graham-street, Leicester—Circular knitting frames or machines.

Dated March 4, 1861.
546. G. Davies, 1, Serle-street, Lincoln's Inn—Planes.

Dated March 5, 1861.
564. W. E. Newton, 66, Chancery-lane—Process of cementation.

Dated March 6, 1861.
569. H. A. Silver and H. Griffin, both of Silvertown—Manufacture of insulators and other articles in india rubber.

571. A. D. Martin and P. V. Trembley, Rouen, France—Apparatus for communicating sound signals.

573. J. Hodgson, Back-lane, Newton Moor Hyde, near Manchester—Pistons of steam engines.

Dated March 7, 1861.
574. W. Wild, Bury—Apparatus to be employed in the preparation of cotton.

575. W. E. Wiley, Birmingham—Improvements in ornamenting surfaces.

576. A. G. Brade, Paris—Preserving animal or vegetable matters.

577. W. Pidding, Borough-road, Southwark—Preserving the aroma and other properties of coffee and cocoa from the effects of the atmosphere.

578. W. S. Kennedy, 16, Talbot-terrace, Bayswater—Apparatus for imparting the motion of riding to wooden or metal horses.

579. T. W. Evans, Paris—Telegraphic cables.

580. N. A. Poudar, Paris—Breaks for railway rolling stock.

581. W. E. Newton, 66, Chancery-lane—Manufacture of yarns or threads.

582. J. Edwards, Horace-terrace, Shepherdess-walk—Construction of carriage wheels.

583. G. Hollands, Rochester—Apparatus used in the process of fermentation.

584. W. Clark, 53, Chancery-lane—Warping, dressing, and finishing threads.

585. B. Britten, Barrington-road, Brixton—Projectiles for rifled ordnance.

586. J. H. Johnson, 47, Lincoln's-inn-fields—Cravats or coverings for the throat and chest.

587. R. Leake, jun., and W. Shields, both of Manchester—Machinery for engraving, stamping, or embossing cylinders and other surfaces.

Dated March 8, 1861.
588. E. Comte and E. Prevost, Chantilly, France—Scouring wools before and after the combing of the same.

589. P. Doury, Rethel, Ardennes, France—Rifled or smooth-barrelled arms.

Dated March 9, 1861.
590. T. W. Davenport and S. Cole, Mosely, King's Norton, Worcester—Manufacture of holders or handles for pens, pencils, and artists' or painters' brushes.

591. B. Walker and W. Tilson, Lenton, Nottingham—Apparatus for the manufacture of bobbin net or twist lace.

592. H. B. Barlow, Manchester—Apparatus for preventing the explosion of steam boilers.

593. J. Jacob, Bruun, Austria—Apparatus for obtaining gas.

594. M. Meyers, Great Alie-street—Woven fabrics.

595. W. H. Buckland, Barge-yard, Bucklersbury—Manufacture of iron.

Dated March 11, 1861.
596. J. C. Fisher, Padfield, Derbyshire—Apparatus for preparing and spinning fibrous materials.

597. J. Bunnet, Deptford—Manufacture of bricks and tiles.

598. P. P. Mataran, 60, Rue Lalande, Bordeaux, France—Construction of casement or French windows.

599. A. Myers, Hutchison-street, Houndsditch—Manufacture of boots.

600. G. Williams, Park Nook, Quorn, Derbyshire—Apparatus for arresting the progress of railway accidents.

601. J. H. Johnson, 47, Lincoln's-inn-fields—Life belts and swimming belts.

602. J. T. Hutchings, Charlton, Kent—Manufacture of boots, shoes, and other coverings for the feet.

603. W. Tillie, Londonderry—Machinery for making friills.

604. J. Hirst, jun., and J. Hollingworth, both of Dobcross Saddleworth, Yorkshire—Apparatus employed in weaving.

Dated March 12, 1861.
605. J. Tomlinson, Kegwork, Leicestershire—Apparatus for attaching and detaching horses when in harness.

606. A. S. Stoker, Wolverhampton—Rails for railways.

607. T. F. Griffiths, Birmingham—Machinery for raising or shaping metals.

608. A. Acers, Anvers, Belgium—Apparatus for lubricating the moving parts of machinery.

609. E. Frementin and M. Aubonnet, both of Bordeaux—Apparatus for cutting wood for lucifer matches.

610. G. L. Ripamonti, Bordeaux—Nautical compass.

611. W. Perry, Wednesbury, Staffordshire—Manufacture of gun barrels.

612. R. H. Gratrix, Salford—Dyeing and printing textile materials and fabrics.

Dated March 13, 1861.
613. G. Speneer, 6, Cannon-street, West—India-rubber springs for railway uses.

614. J. Farren, Clapham—Preventing incrustation in steam boilers.

615. A. Peek, Manchester—Preparing textile materials and fabrics.

616. B. Grundy, Ashton-under-Lyne and S. Andrew, Knowles-lane, near Leeds—Apparatus for lubricating the piston rods, pistons, and cylinders of steam engines.

617. D. Hebson and W. G. Ramsden, Liverpool—Apparatus for obtaining fresh-water from salt-water.

618. Wm. Walker and D. Walker, Lindley—Machinery for producing rovings or slubbings of wool or other fibres.

619. J. Cimez, 162 Great Portland-street—Silvering glass.

620. G. F. Muntz, French Walls, near Birmingham—Sheathing iron ships or vessels.

621. O. Saulay, Bourdeaux—Stopping or closing bottles.

622. J. L. Jullion, Tynemouth—Apparatus used in the manufacture of paper.

623. J. W. Aston, Cradley—Manufacture of vices.

624. J. Jeffreys, Norwood—Construction of houses and footways.

Dated March 14, 1861.
625. A. J. Joyce, Upper Gover-street—Means for indicating and representing various meteorological or atmospheric phenomena or influences.

626. J. C. Coombe and J. Wright, 42, Bridge-street, Blackfriars—The means of preserving stones, bricks, slates, wood, and other analogous materials from the action of atmospheric influences.

627. R. T. Pattison, Ayr, and A. M. Pattison, Glasgow—Means and method of fixing colours in connection with the printing of woven fabrics and yarns.

628. W. E. Gedge, 11, Wellington-street, Strand—Musical instruments.

629. W. E. Gedge, 11, Wellington-street, Strand—Apparatus for saving life at sea or in other waters.

630. C. Gammon, Cloak-lane—Mode of forming ventilators.

631. D. Fryer, Carlton-square, Old Kent-road—Construction of candlesticks and lamps.

632. F. Roessler, Bird-street, St. George's in the East—Apparatus for preventing locomotive engines and carriages leaving the rails.

633. W. Clarke, 53, Chancery-lane—Bridges.

634. J. H. Wilson, Liverpool—Pumps.

635. G. Simmons, 40, Frederick-place, Hampstead-road—Apparatus for making connections with gas and water-mains.

637. E. T. Frumau, Old Burlington-street—Apparatus for preparing gutta-percha, caoutchouc, and other similar substances.

638. E. A. Pontifex, Shoe-lane—Charging, tunning, or fermenting casks and vessels.

639. J. Hunter, Cambusneath, N.B.—Moulding and shaping metals.

640. A. F. M'card, 10, Rue de Strasbourg—Tanning.

Dated March 15, 1861.
641. B. Samuelson, Banbury—Machines for breaking up and cultivating land.

642. J. A. Phillips, 12, Earl's-court, Kensington—Manufacture of white lead direct from ores containing carbonate of lead.

643. J. Bigourat, 2, Gloucester-place, Briton-road—Manufacture of harmoniums.

644. W. Collins, Salford—Water, steam, and mercury gauges.

645. C. Stevens, 31, Charing-cross—Improved regulator for looms.

646. J. Marson, Birmingham—Breech-loading fire-arms and their projectiles.

647. T. Griffiths, Birmingham—Apparatus for signalling on railway trains.

648. A. Granger, Holborn—Manufacture of bats, bonnets, waistcoats, and trimmings for wearing apparel.

650. W. Lorber, 34, St. Mary-at-Hill, Eastcheap—Obtaining and utilizing the chemical products of spent bark.

651. C. J. Burnett, Edinburgh—Ordnance and other fire-arms.

652. F. Trachsel and T. Clayton, Manchester—Manufacture of gas.

653. E. Green and J. Green, Lockwood, near Huddersfield—Carding engines.

654. A. Smith, Brentwood—Machinery for cleansing or dressing bass, flax, and other vegetable fibres.

655. W. Schnell, Fitzroy-square—Manufacturing lucifer matches.

656. J. Deakin, Birmingham—Sash frames and sashes.

657. J. Watkins, Birmingham—Railway brakes.

658. H. A. Ward, Birmingham—Apparatus for transmitting signals on railway trains.

659. J. Penn, Newtown—Whistles or water indicators for steam boilers.

660. S. Perkins, Gorton Works, near Manchester—Apparatus for drilling, boring, and cutting metals.

661. W. Cloutman, Calverton—Tanks or vessels for dairy use.

Dated March 16, 1861.
662. A. Krupp, Essen, Prussia—Construction of mortars.

663. J. I. Taylor, Manchester—Manufacture of gas.

664. J. Holden, Manchester—Looms.

665. A. Drevelle, Manchester—Presses for pressing or finishing textile fabrics.

666. T. Stevens, 31, Charing-cross—Agricultural implements.

667. F. Jenkin, Stowting—Construction of bridges.

669. A. Prince, 4, Trafalgar-square, Charing-cross—Electro-galvanic friction brush.

670. W. F. Henson, New Cavendish-street—Railway carriage buffer, and other springs.

671. E. E. Scott, Dundee—Breech-loading fire-arms.

672. J. Robb, Duudee—Apparatus for treating hemp, flax, jute, and other fibrous substances.

Dated March 18, 1861.
674. A. Krupp, Essen, Prussia—Method of securing tyres for rolling stock on their wheels.

675. J. Arrowsmith, Bilston—Apparatus for fixing the windows of carriages at any required height.

676. J. Arrowsmith, Bilston—Street-railways, and railways on common roads.

677. C. Isles, Birmingham—Securing or fastening envelopes.

678. C. N. Kottula, Holborn—Soap.

679. C. Clayton, J. Breodon, and A. Schneider, Deptford—A self-acting socket for taps.

680. W. E. Newton, Chancery-lane—Machinery for drawing and spinning wool and other fibrous substances.

681. M. Henry, 84, Fleet-street—Furnaces for obtaining gases.

682. J. S. Miller, and T. P. Miller, Springfield Works, Dalmarnock, North Britain—Fixing colouring matter.

Dated March 19, 1861.
683. S. J. Wilkinson and G. F. L. Meakin, 14a, St. Mary Axe—Self acting wind fasteners.

684. J. Jervell, Molde, Norway—Preparation of fish and sea animals for manure.

686. A. Wall, 23, Canton-street, Poplar—Preventing corrosion in boiler tubes.

688. J. Smith and A. Cheese, Seaforth, near Liverpool—

689. J. A. Bolton, Campbell-house, Leicester—Apparatus for heating Turkish baths, public and private buildings.

Telegraphic apparatus.

690. G. W. Hawksley, and M. Wild, Sbeffield—Steam boilers.

691. J. Chalmers, Montreal, Canada—Constructing roadways under water.

692. G. Wilson, York—Glass stoppers.

Dated March 20, 1861.
693. T. Brooks, Sunnyside, Lancashire—Producing combinations of certain colours on cotton fabrics.

694. J. Watson, Jarro, Durham, and T. B. Davison, Munster-square, Regent's Park—Applying and securing thowl pins or rowlocks to boats.

695. H. A. Bartlett, Thetford—Apparatus to protect the flame of a candle from draught.
696. J. Ridley, Stagshaw, Northumberland—Reaping machines.
697. R. A. Brooman, Fleet-street—Preparing caoutchouc adapted especially to dental purposes.
699. G. Peacock, Starcross—Anchors.
700. W. E. Gedge, 1, Wellington-street, Strand—Fabric for covering billiard and bagatelle tables.
701. N. Lloyd and J. G. Dale, Church, Lancashire—Dyeing and printing textile materials and fabrics.
702. J. E. McDoual, Lichfield-street, Soho—Improved fastening or coupling.
704. M. Henry, 84, Fleet-street—Treating yarns and threads of silk and other fibrous materials for purposes of restoring colour thereto.
705. M. J. F. Chappellier, Brussels—Playing cards.
706. S. H. Scott, Rouen—Drawing instruments.
Dated March 21, 1861.
707. M. A. F. Mennons, Paris—Gas stop-cocks.
708. J. Franks, 14, Little Tower-street—Mixture and preparation of teas.
709. G. Baxter, Govan—Apparatus for propelling vessels.
711. J. Rhodes, Wakefield—Apparatus for generating steam.
712. C. Taylor, Nottingham—Method of enabling the guard, or other person, to communicate with the engine driver.
713. A. Heaven, and R. Smith, Manchester—Embroidering machines.
714. T. Greenwood, Leeds, and A. Kinder, Great George-street, Westminster—Machinery for cutting or working in wood.
715. W. Clark, 53, Chancery-lane—Apparatus for cutting and shaping metals.
Dated March 22, 1861.
717. F. J. Wagon, Paris—Manufacture of soap.
718. T. S. Truss, 53, Gracechurch-street—Apparatus for propelling ships and other vessels.
719. J. Victor, Wadebridge, Cornwall, and J. Polglass, Bodmin—Safety fuses for mining.
720. T. Hindle, Blackburn—Looms for weaving.
721. W. Clark, 53, Chancery-lane—Method of locking the nuts on railroad rail bolts.
722. R. A. Brooman, 166, Fleet-street—Colouring enamelled leather.
723. J. Armour, Kilmarnock, North Britain—increasing the generation of steam in boilers.
724. E. Humphrys, Deptford—Steam engines.
725. T. Thomas, Rawtenstall—Apparatus for spinning and doubling cotton.
726. J. Graham, Lancashire—Preparing and annealing iron wire.
727. S. Jackson, Sheffield—Manufacture of spades.
729. A. Haley, Frome—Power looms for weaving check patterns.
730. J. Potter, Leeds—Construction of wire and other similar fences.
Dated March 23, 1861.
731. J. C. Rivett, Manchester—Machinery for carding cotton and other fibrous materials.
732. W. H. Clarke, 3, Vernon-place, Bloomsbury-square—Commissariat ambulance cooking apparatus and appurtenances.
733. G. J. B. Loyer, 2, Brunswick-place, Brixton-hill—Self-supplying water brushes.
735. J. H. Johnson, 47, Lincoln's-inn-fields—Improved skating chair.
736. J. Billing, 12, Abingdon-street, Westminster—An improved chimney head.
737. J. Spencer, Doncaster—Construction of harrows.
738. T. Cardwell, London, and D. Campbell, Liverpool—Machinery for pressing or baling cotton.
739. H. Wickens, 4, Token-house-yard—Shuttles for weaving.
Dated March 25, 1861.
741. P. R. Hodge, 36, Blessington-road, Lee, Kent—Hydraulic press.
743. Sir W. G. Armstrong, Elswick Ordnance Works, Northumberland—Improved breach loading cannon.
745. J. Brown, and R. Gregson, Middleton, Lancaster—Self-acting mules for spinning cotton.
747. W. Bailey, Horseley-fields, Chemical Works, Wolverhampton—Manufacture of globes or shades.
748. J. Morgan and A. T. Jay, 132, Upper Thames-street, E. Edwards, 13, Beaufort-buildings, Strand, and J. Tilston, 2, Lower Gore, Kensington—Ropes or cables for submarine or other electric telegraphs.
749. W. Brookes, 73, Chancery-lane—Apparatus for measuring gas.
750. F. Verdmann, Bury-court, St. Mary Axe—Manufacture of colour.
751. J. Spencer, and M. Spencer, both of Newcastle-upon-Tyne—Manufacture of cast-steel tires.
753. J. Chatterton, and W. Smith, both of Dalston—Submarine telegraph cables.
742. J. T. Holden, Birmingham—Improvement in victorines, boas, collars, and other like articles of dress for females.
744. J. Grant, Mansfield—Apparatus for twining or spinning and doubling cotton or other yarns and threads.
746. S. A. Beers, Brooklyn, United States—Rails for tram-roads.
752. T. Bentley, Margate—Making up, or packing, charges or small quantities of gunpowder, drugs, or other articles.
754. G. F. Morrell, Fleet-street—Manufacture of sealing wax.
- Dated March 26, 1861.*
755. H. Spencer, and E. Taylor, both of Roehdale—Steam engines and boilers.
757. J. Smith, Coven, Staffordshire, and J. Higgs, Brewood—Thrashing machines.
759. T. Davison, Belfast, and R. Paterson, Glasgow—Steam engines.
761. J. Savory, and W. R. Barker, 143, New Bond-street—Douches for the ear.
756. S. Lamb, Manchester—Pipes for smoking tobacco.
760. H. Emes, St. John's-villas, Adelaide-road, Hampstead—Dress fastenings.
Dated March 27, 1861.
763. W. Spence, 50, Chancery-lane—Dressing or preparing the surface of mill stones.
764. W. Grimshaw, Lytham—Apparatus used in drying, pulverizing, and compressing clay.
765. E. Briggs, and S. Fearnly, Castleton Mills, near Rochdale—Manufacture of piled fabrics.
766. W. E. Gedge, 11, Wellington-street, Strand—Lamps.
767. C. D. Abel, 20, Southampton-buildings, Chancery-lane—Construction of wardrobes.
768. J. M. Dunlop, Manchester—Machinery for cleansing cotton.
769. J. G. Williams, 2, Clarence-place, Belfast—Preparation of hydrated oxide of iron.
Dated March 28, 1861.
770. F. Chevillard, Horts, Canton of Varennes, Haute Marne, France—Machines worked by concentrated power.
771. B. Brittain, Cowley-road, Brixton—Obtaining motive power.
772. J. Bremner, Leith—Steam boilers.
773. P. M. Parsons, Arthur-street West, London-bridge—Fire-arms.
775. L. J. Vandecasteele, Lille, France—Brewing.
776. J. Sanderson, Clerkenwell, travelling bags or cases.
777. R. A. Brooman, 166, Fleet-street—Manufacture of shear steel.
778. W. Sorrell, Haggerstone—Apparatus for mashing malt.
779. W. Stratford, Mile End Old Town—Construction of furnaces for heating steam boilers, bakers' ovens, and brewers' coppers.
Dated March 30, 1861.
781. J. J. Field, Holloway-place, Holloway—Apparatus for evaporating in vacuo.
782. W. Simons, Renfrew, North Britain—Ships or vessels.
783. J. Griffiths, Richmond Park, Breck, Liverpool—Compositions or cements.
784. J. Ratray, Manchester—Window-frames, commonly called casements or French lights.
785. T. Sykes, and B. C. Sykes, M.D., Cleckheaton—Steam boilers.
786. J. Cass, Bury—Steam engines and boilers.
787. G. Barton, Nottingham, and T. Soar, Radford—Washing, wringing and mangling machines.
788. W. D. Napier, 22, George-street, Hanover-square—Manufacture of rubbers for the human teeth, and gums.
789. J. J. L. Guibélet, and J. Rambal, 11, Wilmington-square, Clerkenwell—Watches and timekeepers.
790. D. Sutton, Banbury—Apparatus for hanging gates.
791. C. A. Ehrenberg, Altona, Denmark—Construction of ships' compasses.
792. H. Medlock, Great Malborough-street—Preserving fermented liquors.
793. T. Simpson, Darfield Fire Clay Works, Yorkshire—Manufacture of bricks.
794. O. Earle, Liverpool—An improved lubricating compound.
795. R. Ridley, Low Wortley, Yorkshire, and J. Rothery, West Ardsley, Yorkshire—Hewing or working coal and other minerals.
796. J. Briggs, 42, Bridge-street, Blackfriars—Manufacture of an artificial substance to be used as a coating or covering for stone.
Dated April 1, 1861.
797. G. Russo, Genoa, Sardinia—Method of colouring, as a substitute for saffron in the manufacture of cheese.
798. G. Edmondson, Queenwood, Southampton—Washing machines.
799. J. Low, Glasgow—Mode of applying colouring matter to certain textile fabrics and yarns in the process of dyeing and printing.
801. S. de Sanges, 23, Northumberland-street, Strand—Mattresses, cushions, and such like articles.
803. R. James, Faversham, Kent—Reaping and mowing machines.
804. R. A. Brooman, 166, Fleet-street—Method of fixing lac and lac varnishes upon glass and ceramic ware.
805. J. Gardner, Eversholt-street—Portable buildings or structures.
806. W. Palmer, Ballymena, Antrim—Apparatus for grinding wheat and other grain.
807. W. Brookes, 73, Chancery-lane—Apparatus for obtaining superheated or surcharged steam.
808. J. Greenwood, Rawden, near Leeds—Apparatus for combing wool and other fibres.
Dated April 2, 1861.
809. J. G. Winton, and T. W. Cowan 42, Bridge-street, Blackfriars—Means for actuating machine hammers, which said improvements are also applicable to pile-driving, and other such-like machines and purposes.
810. J. H. Winder, Sheffield—Apparatus for raising and forcing water and other fluids.
811. E. Horlick, Tredegar—Stand for exhibiting drapery.
812. W. A. Lyttle, 10, Arundel-street, Strand—Collars and wristbands of shirts.
813. A. Huray and H. Leillé, 42, Laffitte-street, Paris—Apparatus for reproducing and varying all sorts of drawings.
Dated April 3, 1861.
818. T. E. Wilson, Cornholme, near Todmorden—Machinery for agricultural purposes.
819. W. Crighton and F. Crighton, both of Manchester—Apparatus for preparing cotton.
820. M. H. Blanchard, 74, Blackfriars-road—Manufacture of articles made of terra-cotta, stoneware, and plastic clays.
821. T. Wright and H. Wright, both of Dudley—A new or improved steam brake.
Dated April 4, 1861.
825. J. G. N. Alleyne, Alpeton, Derbyshire—Machinery employed in the manufacture of iron.
826. J. T. Grice, Birmingham—Ornamenting metallic tubes.
827. R. Woodruff and C. Milnes, Red Lion-square, Nottingham—Carriages for children.
828. J. W. Lec, Crich, Derbyshire—Apparatus used in winding up watches, musical boxes, or tell-tales.
829. R. A. Brooman, 166, Fleet-street—Method of doubling silk threads together.
Dated April 5, 1861.
836. D. Stone and C. Comer, Manchester—Combining metals and alloys of metals for the manufacture of coins, vouchers, trade marks, and other useful articles.
837. C. Burn, Delahay-street, Westminster—Apparatus for opening and closing the port-holes of ships of war.
Dated April 6, 1861.
848. J. Down, Alderley Edge, Cheshire—Treating certain ores and alloys.
849. W. Slater, Bolton-le-Moors—Machinery for preparing and spinning cotton.
Dated April 8, 1861.
855. W. Smith, Birmingham—Manufacture of umbrellas, parasols, and other similar articles.
856. W. E. Gedge, 11, Wellington-street, Strand—Construction of ceilings and partition and other walls.
857. H. Deheselle, Thimistree, Belgium—Application of centrifugal force to the purpose of raising and propelling fluid bodies.
Dated April 9, 1861.
865. G. Davies, 1, Serle-street, Lincoln's-inn—Machinery for dressing and cutting stone.
867. H. G. Prosser, Waterford—Apparatus for preventing the deterioration of grain when deposited in the holds of vessels for shipment.
868. W. H. Diddall, 104, Fleet-street—Apparatus for distributing the contents of teapots.
Dated April 10, 1861.
879. J. Iyers and J. Pollitt, Preston—Apparatus employed in preparing fibrous substances for spinning.
881. W. B. Peck, Broad-street Bristol—Screw propellers.
882. A. V. Morel, Paris—Safety lock.
883. P. G. Gardiner, New York City, United States—A new improved spring.
Dated April 11, 1861.
887. D. Chalmers, Glasgow—Weaving textile fabrics.
888. W. McConnell, Manchester—Engines for carding cotton.
889. J. Shand and S. Mason, 245, Blackfriars-road—Steam fire engines and pumps.
Dated April 12, 1861.
901. G. C. Haseler, 19, Vittoria-street, Birmingham—Joints or hinges of lockets.
902. T. Carr, Chouvent—Apparatus for forging and shaping articles of iron.
903. J. Ward, Blackburn, and R. Greenwood, Whittle-le-Woods—Apparatus for preparing fibrous materials to be spun.
Dated April 13, 1861.
905. J. E. A. Gwynne, Essex-street Wharves, Strand—Machines for breaking, crushing, and reducing stones and other substances.
907. T. Bailey, Aston-road, Birmingham—Breech loading fire-arms.
Dated April 15, 1861.
919. A. Bradbury, Oldham—Machinery for spinning and doubling cotton.
921. E. Brooks, Birmingham—Machinery for grinding and polishing swords.
Dated April 16, 1861.
923. A. Sax, Paris—Ordnance and projectiles.
928. S. Ridge, Hoviley-bridge, near Hyde—Apparatus applicable to steam boilers and steam engines.
Dated April 17, 1861.
937. W. Jenkins, Montpelier-street, Brompton—Medicated belts or bands for the alleviation of pain in or prevention of cholera.
941. J. Vickerman, Taylor-hill, near Huddersfield, Yorkshire—Syphons.

INVENTIONS WITH COMPLETE SPECIFICATIONS FILED.

774. J. C. Keen, Birmingham—Manufacture of braces.
685. J. J. O. Taylor, 12, Mark-lane—Separation of siliceous and other matters from steel.
703. L. L. Tower, Massachusetts, U.S.—Heads for lead pencils, ink erasers, and other articles of like character.
716. W. M. Cranston, King William-street—Sewing machine.

ON WEIR,
IER SIMILAR WORKS

TSON, *ENGINEER*.

VIL SERVICE.

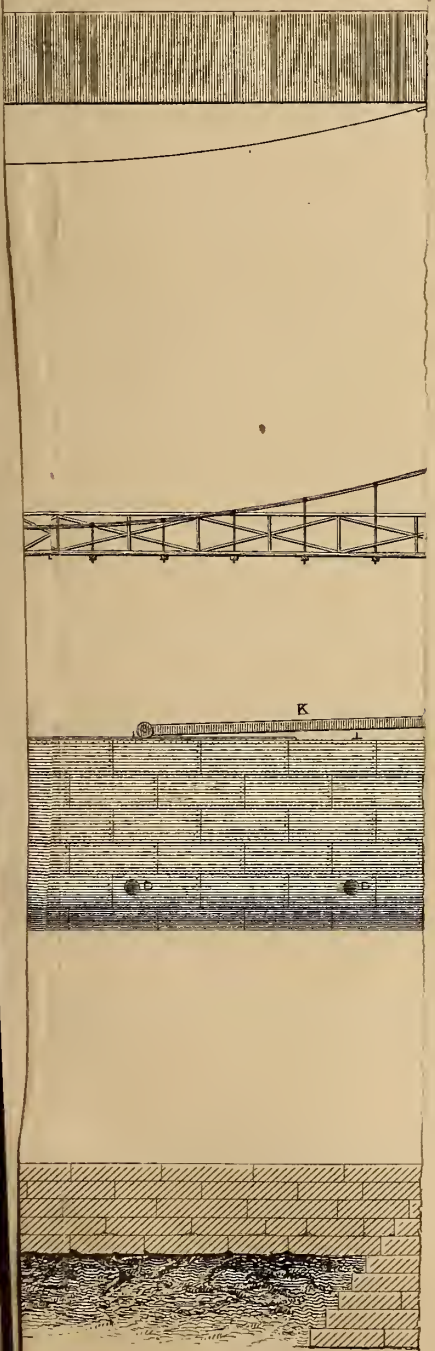

CAISSON WEIR, FOR CANALS & OTHER SIMILAR WORKS

BY JAS L. WATSON, ENGINEER.

INDIAN CIVIL SERVICE.

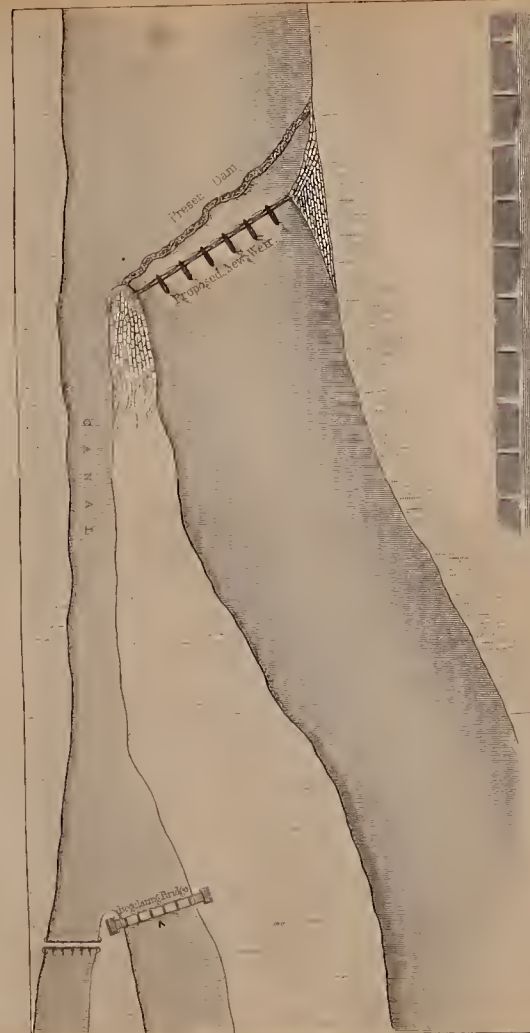
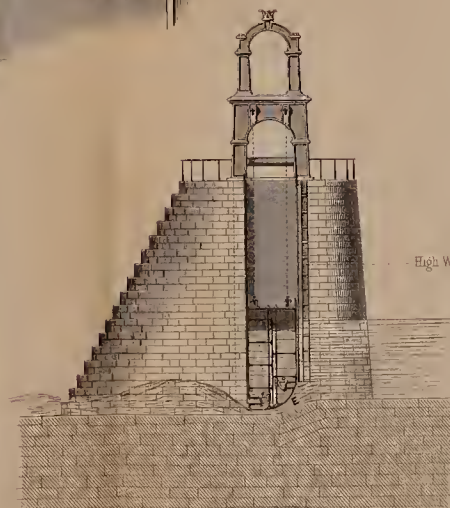
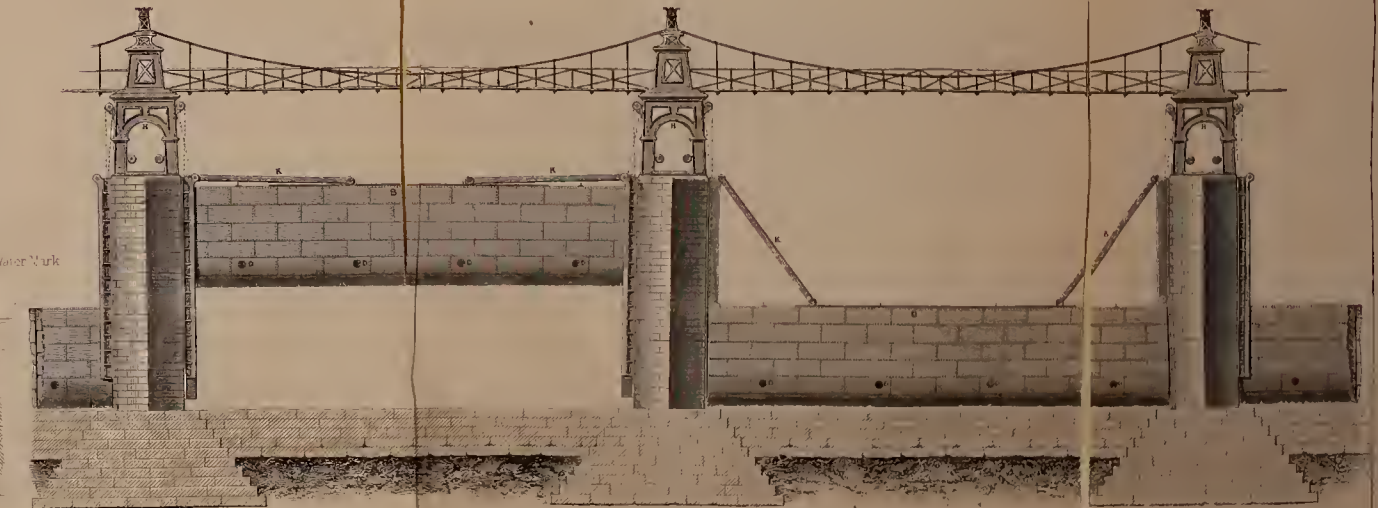
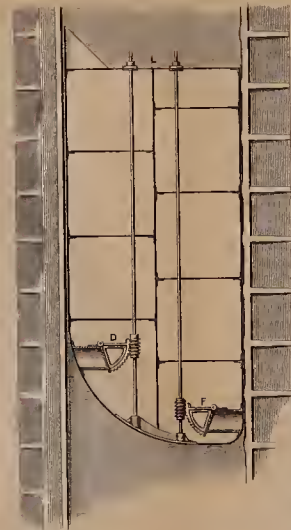
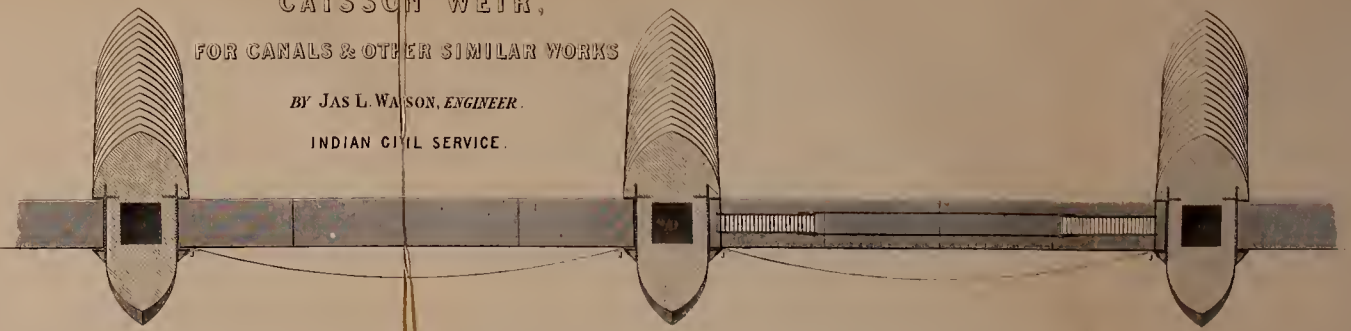

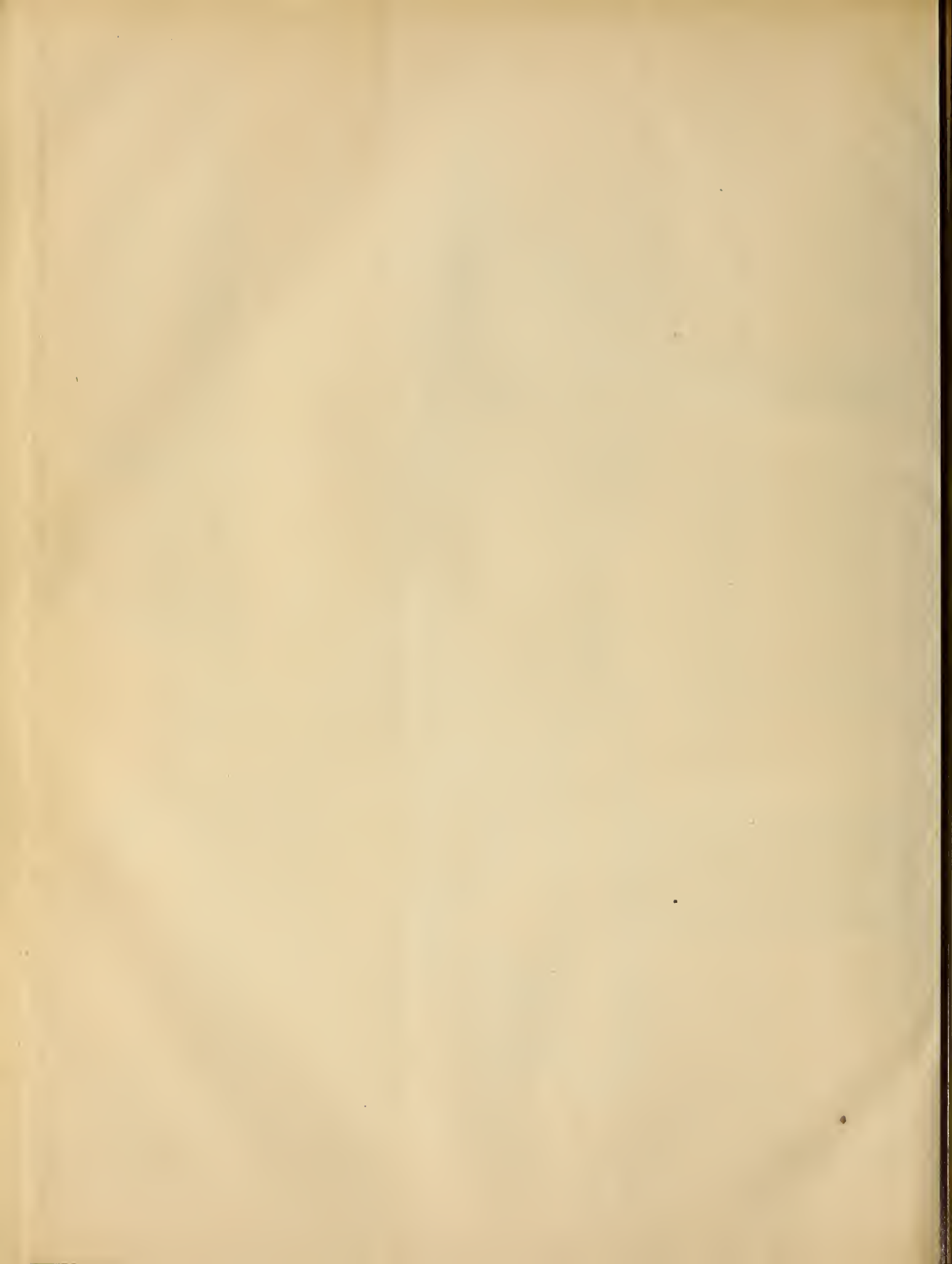

Fig. 1.

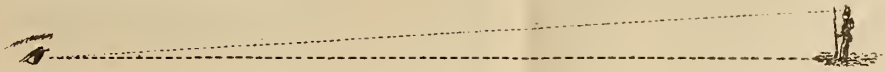

Fig. 2.

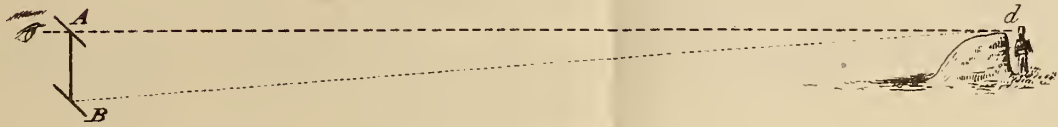

Fig. 3.

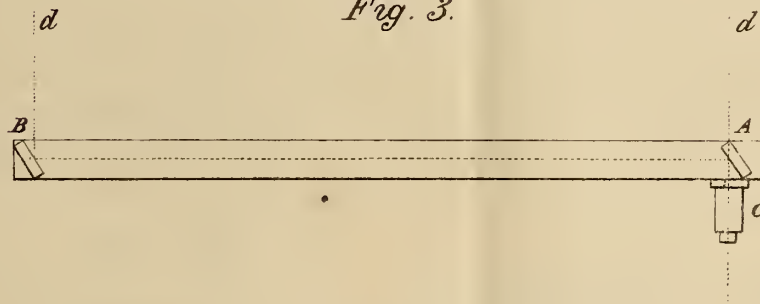

Fig. 4.



Fig. 5.

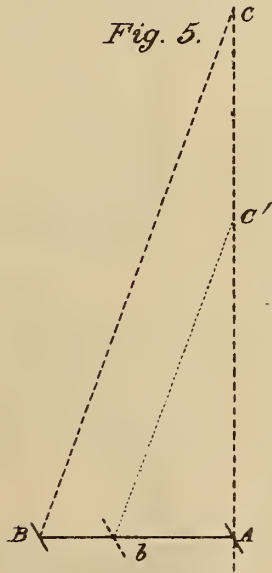

Fig. 6.

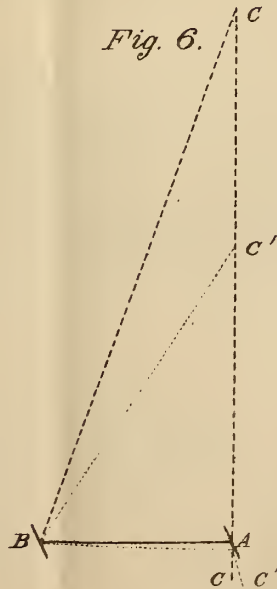
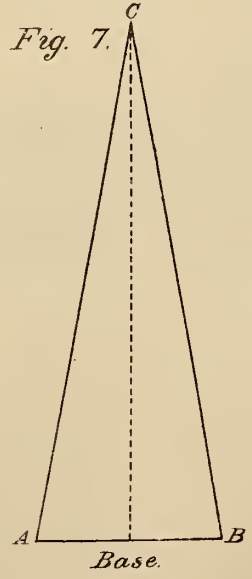
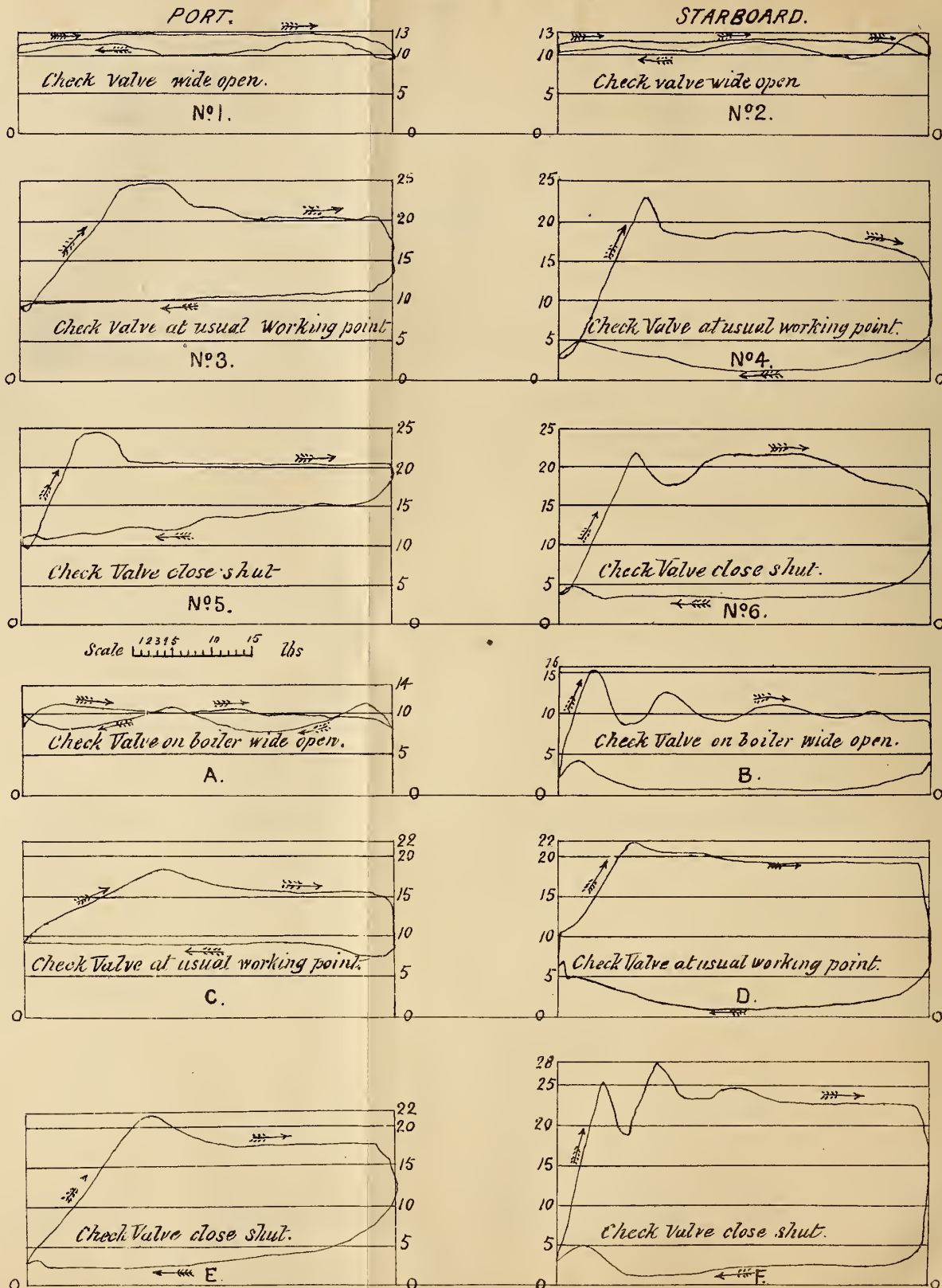

Fig. 7.



DIAGRAMS FROM FEED PUMP U.S STEAMER POWHATAN.



21288

U. S. PATENT OFFICE

THE ARTIZAN.

No. 222.—VOL. 19.—JUNE 1, 1861.

PRACTICAL PAPERS FOR PRACTICAL MEN.—No. IV.

ON ARCHES AND CHAINS.

In the present paper, we purpose to examine carefully the properties of arched ribs, bow-string girders and suspension chains, with the view of calling the attention of our readers to all the points, both great and small, to which regard must be had, in order to produce works which may be thoroughly trustworthy. It appears to us, that hitherto many most important principles have been totally neglected in iron bridge construction, and that too wide a distance has been placed between the principles involved in the construction of stone and metal bridges, whereas we shall presently show that in exact sense the material of which a structure may be formed can affect the principles of its construction in no way whatever, although elements of larger mass, or different form, may be required.

The resolution of strain on arches and chains is a matter sufficiently simple, provided we follow other principles appertaining to the true nature of the arch; but if we neglect these, then all our calculations become absolutely and entirely erroneous, and we might even now, notwithstanding the vast improvements which have recently been made in bridge construction, point to arch bridges, in illustration of the truth of our remarks; for, although structures erected on fallacious principles may not actually fail, this is fully accounted for by the fact, that these works are designed so that the utmost load which can come upon them shall be but one-sixth of the breaking load, and we may lose a portion of the extra strength, which loss will not be at once exhibited, but will so far injure the structure as to cause derangements of form, accompanied with excessive and unequal strain upon the foundations of the work.

We will, however, no longer dilate upon the dangers of negligence on these points, as that must be evident to all who consider the matter, but proceed to explain the subject of our paper.

As we have before said, the calculations for arches are very easy, nor are we aware, that taking each separately, any of them can be improved upon; but we purpose combining all so as to arrive at accurate results. We will first take the case of an arch, and suppose that the strain to which it is subject is direct strain in every part. Perhaps the most satisfactory method we can adopt to exhibit the amount of strain on the crown of an arch, consists in a comparison with the ordinary flanged girder. Let fig. 1

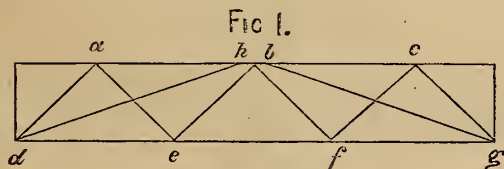

represent a straight girder, supported on piers at *d* and *g*, and let it consist of two flanges, the top flange *a e*, and the bottom flange *d g*, these two flanges being united by means of lattice bars *a d*, *a e*, *b e*, *b f*, *c f*, *c g*, &c.

We will regard it as supporting an uniformly distributed load equal to *w* per lineal foot.

Then if we calculated this structure as a lattice girder, we shall find that the strain on the centre of the top flange will be found from the expression,

$$S = \frac{w l^2}{8 d}$$

in which *S* = the direct strain upon the flange, *l* = the span of the girder, and *d* = the distance between the flanges or the depth of the girder.

We may replace all these lattice bars by the two long struts *b d*, *b g*, without in any way altering the strain on the flange, at the centre, and we may also make these struts curved if we are careful so to arrange the elements of the girder that they cannot bend, and this done, we have

arrived at the form of the arch; hence the direct strain at the crown of an arch is to be found from the expression,

$$S = \frac{w s^2}{2 v}$$

in which *s* represents half the span of the arch, and *v* its rise or versine. Having found the strain at this point, we can easily find it at any other point.

To find the strain on any section of the arched rib, at a distance *x* from the crown or centre, we have the following data.

There is a direct horizontal strain, as found from the foregoing equation, to be withstood, and there is also a direct vertical strain produced by the weight between the crown of the arch and the section on which the direct thrust is required, this weight is evidently

$$= w x.$$

The resultant of these two forces will represent the direct strain required. The resultant may, of course, be obtained by completing the parallelogram, in which the strain at the centre will be represented by a horizontal line, the weight *w x* by a vertical line, and the diagonal or resultant, by a line tangent to the arch, at the point at which the strain is required.

It will, however, be more convenient to calculate this resultant, as the two known composing forces are at right angles to each other, which makes the calculation exceedingly simple, for the resultant being the hypotenuse of a right-angled triangle, its value is given by the equation,

$$R^2 = h^2 + v^2$$

in which *R* is the resultant, *h* the horizontal, and *v* the vertical forces; replacing these latter by their respective values, we obtain,

$$R = \sqrt{\left(\frac{w s}{2 v}\right)^2 + (w x)^2}$$

$$= w \sqrt{\frac{s^2}{4 v^2} + x^2}$$

and at the abutments, where *x* = *s*,

$$R = w s \sqrt{\frac{S^2}{4 v^2} + 1}$$

Let us now examine the duties which the various sections of the arched rib have to perform.

We have already seen that the crown of the arch, or rather that a section at that place may be regarded as an extremely short piece of the top flange of a plate girder; but we must now determine the part played by the other portions of the arch.

At first sight, it would appear that the parts on each side of the crown of the arch act as parts of the web of a lattice girder, and, in many respects, they do so, but with this difference, that they must not only support the shearing strain or downward force produced by the weight of the load, but they must also sustain the horizontal strain existing at the centre of the arch.

If the portions of the arch on each side of the crown had but the vertical force produced by the weight of the load to carry, we might resolve the strain for any point, thus:—

From the point at which the strain is required to be found, draw a horizontal line so as to form the chord of a small arc; take the versine of this arc, which we will call *v'*; draw also a horizontal tangent to the crown of the arch, and a tangent to the arch at the point at which it is required to determine the strain, measure the length of this tangent from the point under consideration, and call this length *T*; then, if the sides of the arch had but the weight of the load acting vertically to support, the strain would be,

$$S = w x \frac{T}{v'}$$

This, however, is not always the correct state of the case; let us therefore examine the expression in order to see to what conclusions they will lead us.

Let $a b$, Fig. 2, represent one half of a lineal arch, as shown, b being the abutment, a the crown, and $a c$ a horizontal tangent to the crown.

Now, let us suppose that we are required to determine the strain upon any point d , the arch being of the form shown.

First we will find what strain is due to the direct vertical force produced by the weight of the load. Let $g d$ represent the value of $w x$ to a given scale, and draw $d e$ tangent to the curve at the point d ; then $d e$ will re-

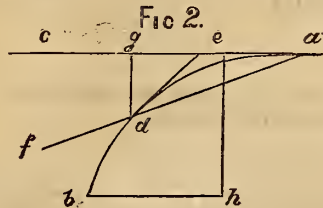

present the direct strain on the section d due to the vertical action of the load.

We also see from the diagram that the line $g e$ represents, or should represent, the horizontal component of the force $d e$; but suppose that when measured upon the scale it does not correspond to the result of the formula

$$\frac{w s^2}{2 v}$$

then our calculations evidently do not apply.

First, let us give another demonstration of this formula, in order to insure ourselves against errors arising from this source.

Taking the load on one half of the girder as uniform, its centre of gravity—at which we may regard the whole weight as being gathered together—will be at a distance of half s from the abutment, and this weight will tend to cause the semi-arch to revolve around the point of support. The moment of the weight about the point b being equal to the weight multiplied by the perpendicular distance of the centre to which it is referred, from the direction of its action, is

$$w s \cdot \frac{s}{2}$$

for if $e h$ represents the direction in which the weight acts, $b h$ at right angles to $e h$ will represent the distance of the centre of rotation from the direction of the force.

This moment will evidently produce a horizontal thrust at a , which thrust will be represented by the moment divided by the perpendicular distance of the centre of rotation from the direction of its action, and this distance is that between the point b , and a horizontal tangent to the arch, and is therefore equal to the rise or versine of the arch, hence the direct thrust at the crown of the arch is

$$\frac{w s \cdot \frac{s}{2}}{v} = \frac{w s^2}{2 v}$$

which is the same formula as we formed at the earlier part of the present paper. Having demonstrated this formula, let us proceed to ascertain the cause of the erroneous value of $g e$.

We may here observe that the formula

$$S = w x \cdot \frac{T}{v}$$

should give a correct answer, and for this reason.

Each half of the arch may be supposed to support half the total load upon the arch, and the section d may be considered as supporting the load between itself and the centre or crown of the arch; we may, therefore, justly conclude that if the arch be formed upon sound principles, the only strain which the section d can be required to sustain is that which is due to the load supported by it, in the same manner that the direct strain upon any bar of a lattice girder is that which is due to the load carried by such bar. The section d may be regarded as an extremely short diagonal bar, the direction of which is represented by the tangential line $d e$.

If $g e$ does not represent the horizontal component of the strain upon section d , let it be shown by $g a$, then the resultant of the strain due to the load, or $d e$, and of the surplus horizontal strain, or $e a$, will exhibit the actual strain at the section d .

A glance at the figure shows us that, in this case, the strain is in a direction ($f d a$), which does not correspond with that of the element by which it is to be sustained; hence the strain upon this element is not a direct strain, wherefore a bending moment must exist.

According to the assumed principles of the arch, the strains upon it must at every point be thrusts; hence in the above figure we have not complied with the conditions upon which this structure must be formed.

Let us now examine the means by which we are enabled to determine the form suitable for any required arch.

We will take a supposititious case in which, for the sake of simplicity, the following values are assumed, $w = 1$, $v = 1$, $s = 5$, the total span being = 10.

The horizontal thrust at the crown of the arch will then be

$$= \frac{w s^2}{2 v} = \frac{1 \times 5 \times 5}{2 \times 1} = 12.5.$$

The thrust upon the arch at the abutment will be

$$= \sqrt{12.5^2 + 5^2} = \sqrt{181.25} = 13.46$$

and that upon the arch midway between the crown and abutment will be

$$= \sqrt{12.5^2 + 2.5^2} = \sqrt{162.5} = 12.74$$

We have now obtained the value of the resultant or the thrust upon the arch in two places, and this resultant must, in order that the strain may be direct, be a tangent to the curve. Let us for the first point, viz., the abutment, reduce the quantities so that they may be represented by the structure itself; thus the horizontal strain may be represented by a portion of the roadway, and the vertical strain by a line extending from the extremity of the roadway to that of the arched rib, which line will of course be equal to the rise of the arch.

The rise of the arch is = 1, but the vertical force is = 5; hence, if the rise is allowed to represent the vertical force, the horizontal strain must be divided by 5. Effecting this, we have for the length of the roadway representing horizontal strain

$$\frac{12.5}{5} = 2.5$$

Observing this, we are immediately struck by a notable property, *the tangent to the curve bisects the horizontal distance between the spring and the crown of the arch*; if so in every part, the curve is a parabola.

It is evident that, if we reduce the values of the elements for any other part of the arch, we shall arrive at precisely the same results; therefore the curve suitable to an arch subject to an uniformly distributed load is the *parabola*.

We may now describe a ready method of setting out the curve, commencing at the crown of the arch and working towards the abutment.

It is required to find the vertical distance of any point in the arch from the horizontal line, the thrust at that point being called t , and its distance from the crown of the arch x , let the required vertical distance be h ; then

$$h^2 = t^2 - \frac{x^2}{4}$$

$$\therefore h = \sqrt{t^2 - \frac{x^2}{4}}$$

Let us apply this to the case of a bridge the span of which is 120 feet, the rise being 20 feet, and the load per lineal foot 4 tons; then the horizontal thrust at the crown of the arch will be

$$\frac{w s^2}{2 v} = \frac{4 \times 60 \times 60}{2 \times 20} = 360 \text{ tons.}$$

We will now calculate the thrust at every ten feet of the span, and the area of metal required to resist it, the arch being of wrought iron, the strength of which is taken at 4 tons per square inch. We commence at the crown of the arch.

At 10 feet $S = \sqrt{360^2 + 40^2} = 362.2$ tons.

„ 20 „ $S = \sqrt{360^2 + 80^2} = 368.7$ tons.

„ 30 „ $S = \sqrt{360^2 + 120^2} = 379.4$ tons.

„ 40 „ $S = \sqrt{360^2 + 160^2} = 393.9$ tons.

„ 50 „ $S = \sqrt{360^2 + 200^2} = 411.3$ tons.

„ 60 „ $S = \sqrt{360^2 + 240^2} = 432.6$ tons.

The areas will be:—

At 10 feet	$\frac{362.2}{4} = 90.55$ sq. in.
20 "	$\frac{368.7}{4} = 92.17$ sq. in.
30 "	$\frac{379.4}{4} = 94.85$ sq. in.
40 "	$\frac{393.9}{4} = 98.47$ sq. in.
50 "	$\frac{411.8}{4} = 102.95$ sq. in.
60 "	$\frac{432.6}{4} = 108.15$ sq. in.

Let us now calculate the values of h for points ten feet apart. We must first reduce the above values of the thrusts at each point, to suit the value which the horizontal strain will have; this value being half x , the quantity by which the actual thrust must be divided to give the reduced value will be found by dividing the thrust at centre by half x ; thus the reduced thrusts are

At 10 feet	$\frac{360}{5} = 72.0$
20 "	$\frac{360}{10} = 36.0$
30 "	$\frac{360}{15} = 24.0$
40 "	$\frac{360}{20} = 18.0$
50 "	$\frac{360}{25} = 14.4$
60 "	$\frac{360}{30} = 12.0$

Dividing the thrust at each point by its corresponding dividend, we find for the reduced values

At 10 feet	$\frac{362.2}{72} = 5.03 = t$
20 "	$\frac{368.7}{36} = 10.24 = t$
30 "	$\frac{379.4}{24} = 15.80 = t$
40 "	$\frac{393.9}{18} = 21.88 = t$
50 "	$\frac{411.8}{14.4} = 28.59 = t$
60 "	$\frac{432.6}{12} = 36.05 = t$

Upon these data the vertical distances may be calculated; they will be, replacing in the formula,

$$h = \sqrt{t^2 - \frac{x^2}{4}}$$

At 10 feet	$h = \sqrt{5.03^2 - 5^2} = 0.547$ feet.
20 "	$h = \sqrt{10.24^2 - 10^2} = 2.203$ feet.
30 "	$h = \sqrt{15.80^2 - 15^2} = 4.964$ feet.
40 "	$h = \sqrt{21.88^2 - 20^2} = 8.873$ feet.
50 "	$h = \sqrt{28.59^2 - 25^2} = 13.870$ feet.
60 "	$h = \sqrt{36.05^2 - 30^2} = 19.990$ feet.

It may be observed that these quantities are not absolutely true, but very close approximations, and they may, of course, be made to approximate as nearly as we please to absolute truth by using a greater number of decimal

places; but we consider the above approximation sufficiently near for practical purposes, for we see in the last quantity, which we know to be 20, and which is calculated as 19.99, the error is only $\frac{1}{1000}$ of the total amount.

If the arch were subject to one rolling load, its form would be different, but it will generally be sufficient to calculate the arch for a total distributed load.

As the structure is subject to the action of a load continually varying, it follows that the form proper to the arch continually varies, and, therefore, the rib must be constructed of such depth that none of the curves appertaining to any kind of load shall pass outside of it at any point.

We will now offer a few remarks upon the means which we should adopt if it is required to construct the most handsome form of arch.

Let us suppose that an arch with an excessively flat crown is to be constructed in metal, the form being chosen on account of its appearance.

Let us also, in order to have some definite form, suppose that the curve selected is a semi-ellipse, or it may perhaps be better to have a curve parallel to a semi-ellipse.

If we consider the arch as merely a curved line, it is evident that it will not be in a state of equilibrium; but the crown will be falling in and the haunches rising if it be of disconnected parts, which will not occur in a properly formed arch. If, therefore, we wish to retain the principle of the arch, we must dispose an additional load in such a manner as may retain the structure in equilibrio, but we shall thus be placing an extra and unnecessary load upon the bridge, which will of course absorb a portion of the strength of the structure; we may, therefore, find it desirable to form the structure on some other principle than that of the arch.

Let us now regard the structure as a combination of the arch and straight girder. We shall find a certain amount of thrust at the crown of the arch, perhaps equal to that which would exist if the structure were a true arch; and if we consider the rib as a web with the top and bottom flange, the thrust will be increased on the top flange by the deflection of the girder, whereas it will be diminished on the bottom flange.

If the extremities of the rib are free to move in a horizontal direction, there would be no strain on it except that produced by the deflection, and the case would be that of a straight girder.

Let us now take a case of a very flat arch, or arch and girder combined, and examine the conditions of strain existing.

Let the arch be of 140ft. in span and 20ft. rise, the crown for a length of 80ft., having but little more camber than would be given to a straight girder.

Let the load per lineal foot be taken at 3 tons, then the maximum thrust at the centre of the structure will be

$$= \frac{w s^2}{2 v} = \frac{3 \times 70 \times 70}{2 \times 20} = 3.67 \text{ tons.}$$

Let the depth of the rib or distance between its flanges be 4ft. We will consider the 80ft. in the centre of the rib as a beam, and the 30ft. on each side as arch ends, then the thrust on the end of the beam will be found by calculating the horizontal thrust produced by half the load on the beam, and the whole load on one arch end; the moment of the first quantity about the abutment will be

$$= 120 \times 30 = 3600$$

and that of the second

$$= 90 \times 15 = 1350$$

making a total moment

$$= 1350 + 3600 = 4950$$

Dividing this moment by the leverage with which it is resisted by the beam, we have the thrust on the latter, which is,

$$\frac{4950}{20} = 247.5 \text{ tons,}$$

which will produce on each flange of the beam a thrust of 123.75 tons. The direct strain produced at the centre of either flange of the beam is found thus,

$$S = \frac{w l^2}{8 d} = \frac{3 + 80 \times 80}{8 \times 4} = 600 \text{ tons.}$$

Thus there will be on the top flange of the rib a strain in compression

$$= 247.5 + 600 = 847.5 \text{ tons,}$$

and on the bottom flange, a tensile strain

$$= 600 - 247.5 = 352.5 \text{ tons;}$$

and if the structure is of wrought iron, the area of the top flanges must be

$$= \frac{847.5}{4} = 211.875 \text{ square inches,}$$

and that of the bottom flange

$$= \frac{352.5}{5} = 70.5 \text{ square inches.}$$

The great strain upon the flange of the beam is due to its small depth, for we see that its depth should be about 7ft., whereas we have assumed it at 4ft., in order to avoid the appearance of heaviness in the aspect of the structure. These calculations are made upon the supposition that the ends of the beam-arch are not bolted down, but merely supported; if, however, they are firmly fixed, matters will assume a more promising aspect, for then the beam will act as a girder fixed at both ends. Let us now regard it as thus circumstanced; as the ends of the beam cannot move, the first thrust mentioned above will not be produced.

We will first examine the beam part of the structure, the strain at its centre will be (as it is fixed at both ends),

$$= \frac{w l^2}{24 d} = \frac{3 \times 80 \times 80}{24 \times 4} = 200 \text{ tons.}$$

Let us at the extremities of the beam increase the depth to 5ft. 6in., then the strain on those parts for either flange will be

$$= \frac{w l^2}{12 d} = \frac{3 \times 80 \times 80}{12 \times 5.5} = 291 \text{ tons, nearly.}$$

The area of the top flange will be, at centre, 50 sq. in.; at end, 72.75 sq. in.; the area of the bottom flange will be at centre 40 sq. in.; at end, 58.2 sq. in. The ends of the beam should be connected with the abutment masonry by a horizontal tie, and the strain upon the curved ends may be calculated in the usual manner; but if no tie should exist, there will, probably, be a bending moment on some part of the extremities, which may be calculated in a manner very similar to that employed for determining the strain at the end parts of the arch.

In designing suspension chains, the form of the chain may be similar to that of the arch, and it may be calculated in a similar manner.

The bowstring girder consists of an arch, which has its abutment plates connected by a tie, instead of being supported by masonry; and this form of structure may in some cases be convenient, as saving the mass of masonry required to resist the thrust of the arch; but it is evident that it is not economical to use it in the case of several contiguous spans, for then the thrust on one side of any except the extreme abutments will be withstood by that on the other side. We may thus find the tension of the tie. The thrust on the abutment plate is resolved in a vertical and in a horizontal direction—vertical upon the point of support, and horizontal upon the tie.

The triangle forming half the parallelogram of pressures at the abutment of the arch will show the strains in both directions, but the horizontal element is,

$$\frac{w s^2}{2 v}$$

wherefore the tension upon the tie is equal to the thrust at the crown of the arch.

We shall not occupy space with an account of the method of proportioning and constructing the platform in any case, as such observations are here unnecessary.

With regard to inverted bows, we may observe that the strain upon the

FIG 3.

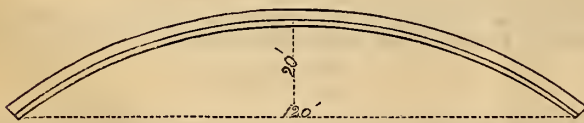

struts is calculated in precisely the same manner as that on the ties of ordinary bowstring girders.

By employing these struts, the back stays and masonry necessary to hold down the anchor plates are dispensed with, but we think that as, a rule, their weight is an insuperable obstacle to their employment if we have a due regard for economy.

Cast iron would appear to be a most suitable material for arches, but wrought iron, though offering less resistance to a compressive force, is far more worthy of reliance, and cast iron should never be used for false arches, as we may call those which are subject to bending strains, and this applies especially to those parts of the ribs at and near the haunches or abutments.

Before concluding the present paper we may mention that the circular

segmental form is very convenient for true arches, as it will generally, with only a moderate depth of rib, include the parabola representing the true arch. The radius of the segment may be calculated from the formula,

$$R = \frac{V^2 + S^2}{2 V}$$

where R = radius. Fig. 3 shows a parabolic curve included in a circular rib. It is plotted from the calculations given above.

ON GAS LIGHTING.—COMPARISON OF COAL GAS WITH OTHER MEANS OF ARTIFICIAL LIGHTING.—DISCUSSION ON PUBLIC LIGHTING AND RECENT IMPROVEMENTS THEREIN.

By SAMUEL HUGHES, CIVIL ENGINEER, F.G.S.

The artificial light produced by coal gas, although its introduction only dates about half a century ago, has become almost as much a necessary of civilised life as either fire or water.

The increase of gas consumption far outstrips the increase of population, for while the latter scarcely anywhere in England doubles itself in thirty years, there are many instances of towns in which the consumption of gas has doubled in ten years.

Nor, is this to be wondered at, when we consider its vast superiority in point of convenience, cheapness, and efficiency to every other kind of light. The consumer of the common coal gas in London procures as much light from gas costing £1 as he could procure from tallow, oil, wax, or spermaceti,* by an outlay varying from £5 to £20, according as he uses the cheapest or dearest of these materials. In Lancashire or Scotland, owing to the very much higher illuminating power of the gas, he procures as much light as from London gas for one-half, or even less than half the money. These facts, with reference to the economy of gas, are now tolerably well understood.

Owing to improved fittings and improved modes of purification, gas now finds its way into the most elegant apartments of the best houses; and one may hope in a few years to see it as commonly used even in the bed-rooms of houses, as it is already in Scotland, where, from the first, the fittings have always been of a very superior description.

APPLICATION OF GAS TO PUBLIC LIGHTING.

The history of this is somewhat curious. When gas first began to be used for public lighting, the local authorities and their astute advisers in the legal profession were in the habit of stipulating that the new light produced from gas should be equal to the old oil lamps, which it was intended to supersede. This was a condition by no means difficult; and this continued for some years to be the only condition as to quantity of light which was insisted on so far as the public were concerned. In those early days it was considered so difficult and mysterious an affair to light and extinguish the public lamps, that local authorities were glad to entrust this to the gas companies, who therefore generally undertook not only to supply the gas for the public lamps, but undertook to light and extinguish the gas, as well as to clean and repair the lamps and posts.

Our far-seeing countrymen north of the Tweed, however, were not so simple as to entrust the lighting and extinguishing of their public lamps to the gas company; and accordingly we find that nearly all over Scotland the local authorities have kept this power in their own hands, and have merely contracted with the gas companies to pay for so much gas supplied to public lamps. A similar practice prevails in many of the Lancashire towns, and in a few of those in Yorkshire.

We shall have more to say on the extreme absurdity of the practice still followed in most parts of England—that of allowing the gas companies to light and extinguish—when we come to treat this branch of the subject in detail. In the meantime let us consider the progress or application of gas to the purpose of street lighting.

In the first place, then, the gas companies were only too glad to obtain the power of breaking up the streets at any cost, and were quite ready to enter into contracts for the supply of gas to the public lamps at almost

* Experiments with the photometer, when the sperm candle is used to measure the light of gas, have taught us the curious fact that all coal gas gives more light than an equal weight of sperm. Thus 5ft. of common coal gas, with a specific gravity of .42, gives a light equal to twelve sperm candles, each burning 120 grains an hour. Now, gas of this specific gravity weighs 225 grains per cubic foot, so that 5 cubic feet will weigh 1125 grains; but this gives a light equal to 12 sperm candles, each burning 120 grains an hour, in all 1440 grains. In the same way it will be found that 1475 grains of Lancashire gas, with an illuminating power of 20 candles and a specific gravity of .53, gives as much light as 2400 grains of sperm. This difference is due partly to the wick which is a necessary evil in the candle, and somewhat interferes with the light; partly to the structure of the candle itself, which impedes the upward flow of air to unite with the flame; but still more probably to the carbon and hydrogen being contained in the candle in proportions not so well adapted for combustion as those which obtain in coal gas.

any price. The extreme sacrifices which they were willing, and indeed compelled to make, may be inferred from the fact that, when the price of gas to the private consumer was 15s. per 1000 feet, the public lamps were actually supplied with gas at a price, per lamp per annum no higher than at present, when the price to the private consumers is only 4s.

The original burners were probably not so large as at present, for instead of being batswings, consuming five feet an hour, they were probably cockspears, or similar burners, consuming not more than three feet. Still, even at this rate of burning, the public lamps must have consumed between sunset and sunrise about 13,000 feet of gas, so that, after deducting the expense of lighting, cleaning &c., the gas alone must have been supplied for about 6s. per 1000 feet, while, at the same time, the private consumer was charged 15s.

Considering the circumstances of gas works forty years ago, it is probable that 6s. per 1000 feet was a totally unremunerative price; and yet companies were then perfectly willing to undertake contracts for public lighting on those terms.

I have no wish to justify for a moment a price for public lighting so low as two-fifths of the ordinary price paid by the private consumer, although I do maintain that the local authority is entitled to a considerable reduction, say, for instance, something like 25 per cent. below the price charged to private consumers.

I think the local authority is entitled to this reduction in consequence of the largeness of the consumption, the certainty of payment, the saving of expense attending the collection of small amounts, the nature of the supply to which ratepayers of all classes contribute—poor as well as rich—and finally and principally, in return for the liberty of breaking up the public streets, and as some small compensation for the serious mischief and expense which this occasions. I think, when all these circumstances are taken into consideration, it is not too much to ask that a large consumer like the local or municipal authority of a town should be allowed a discount of 25 per cent., a discount which is often exceeded at the present day in many places where there are large consumers, to whom it is thought desirable to allow a differential scale of charges.

ARRANGEMENTS UNDER WHICH THE PUBLIC LIGHTING IS CONDUCTED.

There is considerable variety in these arrangements, which we shall now consider in detail:—

1. When the public lamps are supplied with gas, lighted, extinguished, and repaired by the company for a fixed price per lamp per annum.

This is the arrangement which generally prevails in the metropolis and throughout the greater part of England, excluding, however, the manufacturing districts of Yorkshire and Lancashire, where it is usual to pay a price per 1000 feet of gas or per 1000 hours of burning.

This general arrangement may be further classified under the following subdivisions:—

- a. When the lamps belong to the company.
- b. When the lamps belong to the local authority.

When the lamps belong to the gas company, the price is usually made up of the following items:—

1. The estimated quantity of gas consumed per annum, derived from the hours of burning multiplied by the assumed consumption per hour, and calculated at a price per 1000 feet somewhat less than the lowest price paid by any private consumer.

2. The expense of lighting and extinguishing the gas, cleaning and repairing the lamp-glasses and fittings, and painting the lamp posts.

3. A payment for the use of the lamp and post, in the nature of a rent or annual per centage on the cost of these.

Now, in estimating the quantity of gas consumed by public lamps, the greatest uncertainty prevails.

Taking the case of the metropolis, in which the contracts usually stipulate that the gas company is to supply 5ft. an hour to the public lamps, let us see what happens.

In the first place, there is no similarity or uniformity in the burners, and even if there were, it would be perfectly useless on account of the great irregularity of pressure which prevails in the mains. The pressure is usually highest at or about sunset, or just at the time when the public lamps are lighted. This pressure, at present, varies in different parts of London from 24 to 36 tenths, and most of the burners used for the public lamps would consume more than 5ft. at the lowest of these pressures. In the winter time the pressure at sunset is kept up till about seven o'clock, when it diminishes 2 or 3 tenths. Another fall of about 4 tenths occurs at ten o'clock, a further fall of 4 tenths at eleven, another fall of 6 tenths at twelve o'clock, and between twelve and one in the morning there is another fall of 6 tenths, bringing the pressure down to about an inch or sometimes less, and this pressure continues with little or no variation till sunrise, when the public lamps are extinguished.

These remarks apply to the Westminster district, which is lighted by the Chartered Gas Company from their station in the Horseferry-road. The pressures were recorded by a very accurate self-registering pressure gauge fixed in my house, No. 14, Park-street, during the last fortnight of October, 1860.

The following were the average pressures of the gas during the whole fortnight:—

At	Time	the average pressure was.	Tenths of an inch.
At 5	p.m.		30.8
5.30			38.5
6			33.2
7			29.2
8			23.3
9			23.4
10			24.5
11			20.4
12	midnight		14.3
1	a.m.		8.7
2			8.9
3			9.1
4			9.0
5			9.0
6			8.9
6.30			9.4

$$308.6 \div 16 = \text{an}$$

average pressure throughout the night = 19.29 tenths.

These pressures are considerably higher than those which prevailed during the preceding winter, and it is probable that with the taps full on the lamps at the average pressure of 19 tenths would consume the contract quantity, which, in the Westminster district, is 2½ft. of Canuel gas, giving a light of twenty candles for 5ft. an hour, or ten candles for 2½ft.

But as a general rule the taps never are turned on full, nor anything like it, the lamplighter, in fact, being directed to adjust the taps so as to give the flame which he considers right according to his own judgment.

Now, as the lamplighter who has to perform this important function of regulating the public lights is an individual profoundly ignorant of pressure and its laws, and cannot for a moment be supposed capable of judging either what the pressure of the gas will be after he leaves the lamp, nor how it will affect the flame it follows, necessarily, that this act of regulation, supposed to be performed by the lamplighter, must be highly unsatisfactory and inefficient.

If we suppose him to regulate the flame so as to burn the contract quantity at the pressure with which he is dealing at sunset, it must be evident that, as the pressure falls off, the quantity consumed must be very much less than that for which he regulates the flame.

If we suppose the consumption to vary as the square root of the pressure, and assume that at sunset the taps are adjusted to burn 2½ft. an hour, we have this proportion to find the average consumption throughout the night,

$$\sqrt{30.8} : \sqrt{19.29} :: 2.5 : 1.99 \text{ cubic feet per hour,}$$

or 20 per cent. less than the proper quantity. It is far more correct, however, to calculate the consumption according to the $\frac{7}{10}$ root of the pressure in which case we have—

$$\begin{aligned} \sqrt[10]{30.8^7} & : \sqrt[10]{12.29^7} :: 2.5 : 1.80 \\ 11.01 & : 7.95 :: 2.5 : 1.80 \end{aligned}$$

or more than 26 per cent. less than the contract quantity.

Independently of inferences which may be drawn from the diminution of pressure, however, perhaps it will be more satisfactory to refer to actual experiments which were made in public lamps on various parts of the metropolis in the year 1858.

In most of these cases the pressure at the actual burner of the street lamp was tried at every hour throughout the night. The burner was then removed from each lamp, and the consumption, at the observed pressures, determined by an accurate experimental meter and other proper apparatus.

Experiments in the Westminster district:—

1. Part lighted by the Equitable Gas Company west of the Vauxhall Bridge-road.

The pressure in the mains was found to vary from 17 tenths down to 8 tenths. The pressure at the burners varied from 10 tenths down to 2 tenths. The consumption of the lamps at sunset varied from 5.3 to 5.35ft., and after 2 a.m. the consumption fell from 2.08 to 2.75ft. The average consumption per annum for each lamp experimented on was 11,806ft. per annum instead of 22,000ft., which it should have been at 5ft. an hour.

2. In the part of the Westminster district lighted by the Chartered Company the pressure in the main varied from 30 down to 5 tenths, and the pressure at the burners from 26 down to 1½ tenths.

The average consumption of eleven lamps at sunset was found to be 2.54ft. an hour, but after 2 a.m. the average consumption fell to 1.04ft. The eleven lamps, on the average of the night, consumed 1.63ft. an hour instead of 2½, and each lamp consumed per annum 7012ft. a year instead of nearly 11,000, which was the proper contract quantity.

3. In the hamlet of Knightsbridge, lighted by the Western Gas Company, the pressure in the main varied from 30 to 8 tenths, and the pressure at the burners from 26 down to 3 tenths.

The average consumption of four lamps at sunset was 3.34ft. an hour, but at 2 a.m. the average consumption fell to 2.57ft. an hour.

These lamps burnt, on the average of the night, 12,643ft., or more than 2000ft. in excess of the contract quantity. These were the only lamps which were found to be doing justice to the public.

PUBLIC LAMPS IN LAMBETH.

Twelve lamps lighted by the London Gas Company were experimented on in June, 1858.

The pressures in the main varied from 26 down to 5 tenths. The pressures at the burners varied from 21 down to 2 tenths.

The average consumption of the whole twelve lamps when first lighted was 4.94ft. an hour, but the lowest consumption during the night only averaged 2.04ft., or less than half the proper quantity.

The average consumption of the whole twelve lamps throughout the night was only 3.23 cubic feet an hour, giving for the whole year 13,920 feet instead of 22,000, which they ought to have burnt at the rate of 5ft. an hour.

The lamps lighted by the Phoenix Company were also tried in Lambeth.

The pressure in the mains here varied from 19 down to 6 tenths, and the pressure at the burners from 17 down to 2 tenths.

The average consumption of the whole ten lamps at sunset was 6.26 feet an hour. The average of all the lamps gave 2.63 feet an hour as the lowest consumption in the night.

The average consumption throughout the night was 4.19ft. an hour, and the consumption of each lamp per annum 18,042ft.

Table I. contains all these results in a collected form, with the addition of a number of experiments made in other parishes.

Experiments have since been made in various other parts of the metropolis, but as these now form the subject of disputes with Gas Companies, I prefer confining my statements to those which have already been given in evidence before parliament.

The following calculation shows the average consumption derived from all the preceding experiments, which comprise observations on 106 lamps, extending, in some cases, over more than a week.

TABLE II.

PARISH.	No. of Lamps.	Consumpt. per Lamp.	Consumpt. of all the Lamps.
St. John's, Westminster ...	3	14,806	44,418
St. Mary's, Westminster ...	11	14,024	154,264
Ditto	4	25,286	101,144
Lambeth	12	13,920	167,040
Ditto	10	18,042	180,420
Battersea	1	12,740	12,740
Ditto	1	19,454	19,454
Ditto	1	25,092	25,092
Clapham	6	15,444	92,664
Wandsworth	3	15,021	45,063
Streatham	2	18,550	37,100
Ditto	2	22,295	44,580
Ditto	3	14,088	42,264
Newington	12	15,354	184,248
Ditto	7	10,200	71,400
Chelsea	28	15,043	421,204
	106		1,643,095

Average annual consumption per lamp, $\frac{1643095}{106} = 15501$ cubic feet; whereas the consumption, at 5ft. an hour, should be 21,520ft., or nearly 39 per cent. more than it really is by experiment.—(See *Evidence on Metropolis Gas Bill*, 1860.)

TABLE I.

NAME OF PARISH OR DISTRICT.	Number of Lamps tried.	Name of Gas Company.	Highest Pressure in Mains.	Lowest Pressure in Mains.	Pressure at Burner.	Lowest Pressure at Burner.	Average Consumption at Sunset.	Average lowest Consumption.	Mean Hourly Consumption.	Mean Annual Consumption.
St. John, Westminster	3	Equitable	17	8	10	2	5.32	2.46	3.44	14,806
St. Margaret, Westminster.....	11*	Chartered	30	5	26	1½	2.54	1.04	1.63	7,012
ditto ditto	4*	Western	30	8	26	3	3.34	2.51	2.94	12,643
Lambeth	12	London	26	5	21	2	4.94	2.04	3.23	13,920
ditto	10	Phoenix	19	6	17	2	6.26	2.63	4.19	18,042
Battersea	1	London	20	14	6	4	3.47	2.70	2.96	12,740
ditto	1	Wandsworth	22	12	18	10	5.53	3.83	4.52	19,454
ditto	1	Phoenix	18	12	18	10	6.90	5.33	5.83	25,092
Clapham	6	ditto	20	10	15	2½	3.88	3.41	3.56	15,444
Wandsworth	3	Wandsworth	20	6	12	2	3.86	3.05	3.49	15,021
Streatham	2	Phoenix	17	11	15	3	4.99	4.05	4.26	18,550
ditto	2	Mitcham	20	10½	11	3	6.43	4.45	5.18	22,295
ditto	3	South Metrop.	22	14	4½	2½	4.13	2.97	3.61	14,088
Newington.....	12	Phoenix	20	5½	17	1½	4.88	2.76	3.57	15,354
ditto	7	South Metrop.	25½	5	12	1¼	5.28	1.75	2.37	10,200
Chelsea	28	London	32	5½	29	1	5.04	2.24	3.49	15,043

* Lamps lighted with Cannel gas.

WEIR FOR CANALS AND OTHER SIMILAR WORKS.

(Illustrated by Plate 193).

We have for a long time observed the great necessity which exists for introducing some better means of regulating the rapid flow of the Indian rivers during the rainy season; and, as a well-matured plan by Mr. Jas. L. Watson, Engineer, in the Indian Civil Service, seems to meet the requirements of such cases, we have illustrated it by the large copper-plate engraving No. 193; and, as we believe the plan deserves to be more generally known and adopted, and seeing that Mr. Watson has not sought to secure to himself the exclusive advantages to be derived from its use, we feel the greater pleasure in noticing the very useful exertions of an ingenious mechanical mind.

In writing to us respecting these works, Mr. Watson says:—

For the last nine years, I have been connected with one of the largest canals in India, the works at the head of which are always a great source of annoyance and expense, on account of the dam that is thrown across the river to turn the water into the canal (the construction of which is a work of no ordinary undertaking), being carried away every season during the rains, when the river rises some 8 to 9ft., and then not a stone is left to mark the spot. It generally requires five to six weeks to reconstruct the dam, and during this time a very limited supply of water is obtained.

An ordinary dam or weir, such as is used in this country, would not answer, on account of the great quantity of silt, boulders, &c., which come down during the rainy season, and which with an ordinary weir would all be carried into the canal, and silt up the channels for irrigation.

Not being aware of any weir or contrivance of that kind having been constructed for similar works, I designed the arrangement as seen in the drawing. The applicability of my plan you will readily perceive, and the advantages to be derived from its employment on Indian rivers will, I feel assured, be admitted by all who know the nature of such streams.

The plate illustration shows a plan view, and longitudinal sectional elevation of a portion of the proposed new weir; a transverse sectional elevation of one of the caissons and piers; a detached section of the caisson, showing more particularly the regulating valves and mode of working them. A view is also added, showing the proposed new weir *in situ*.

What I propose, is to erect strong piers of solid masonry work, with cast iron brackets built in at either side, so as to form a recess. The distance between the piers to be as great as practicable. Wrought iron caissons, B C, divided into compartments, are placed, as shown, between the piers; in case of accident, each of the compartments should be provided with a valve. C shows one of the caissons which has been lowered into position by the valves, D having been opened so as to admit the water into the compartments. A space of some 8 to 10 inches is left for a scour, to allow of boulders, silt, &c., passing. The caisson being in equilibrium, a rise in the river (which sometimes comes rather suddenly) would produce an increased pressure at E, and the caisson would ascend, by which means the flood would be allowed to pass away, and so render unnecessary the regulating bridge (marked A in the view of the canal, &c.) hitherto employed, and which requires to be attended to by men stationed for the purpose of regulating the quantity of water required in the canal during a flood.

When the rainy season sets in, the valve F on the down stream side of the caisson is opened, and the water allowed to escape, upon which the caisson will rise and float upon the surface of the water, and remain there during the flood season.

C, in the transverse sectional view, represents one of the caissons during the rains, showing the water which has been admitted into the compartments by means of the valve D; and thus, by a series of such caissons being so employed, a dam or weir could be thrown across a canal or river in a few hours. H is cast iron framework erected on each pier, with provisions made for the employment of cranes in case of accident. I, wells for counterweights attached to the suspending chains (when it is necessary to employ such).

J is a slip of leather, or other suitable material, screwed on to the flanges of the bracket to prevent stones getting in between the ends of the caissons.

The top part of the framework, H, surmounting the piers serves to carry a light wire rope suspension bridge to allow of ready access to the caissons, and answers the purpose also of a bridge for foot passengers. K, hinged ladders, rising and falling with the caisson.

As there is a considerable amount of rafting carried on during the rainy season, one of the centre Caissons would require to be made in two halves, and worked on a hinge, or it might be hoisted up by hydraulic pressure clear of the river, so as to allow free passage to the rafts, &c.

NOTES ON THE CONSTRUCTION OF ENGINES AND MACHINERY:—MORE PARTICULARLY MARINE ENGINES.

By L. O.

It has often been found, by perusing the best engineering works of the day, that most of them are out of date, owing to the enormous progress and alterations made in the last seven or eight years; and it therefore becomes necessary to propose a different way to arrive at more true and correct results in calculating the different parts of engines and machinery, than can be obtained by following the old system; and as a record of the fundamental rules of mechanical engineering, and the experience upon which the proportions of engines and machinery in general have been determined, would be very instructive, this paper has now been brought before the public, not presuming that it shall be taken as a standard, but in the hope that it may be considered a step towards bringing to light that which has been wanting so long a time, viz., a more modern guide for the aspiring young engineer, and likewise to call forth a discussion by those engineers who, combining theory with great practical experience, will kindly come forward to give their opinions and views upon the different questions of importance contained in this paper. By doing so, they will confer a great benefit on the engineering world, diffuse a great amount of knowledge, and certainly gain the honour due to them. At the present day, for example, we often find in an engineer's drawing office a man of great practical experience, but almost devoid of any theoretical knowledge, and, more especially, of the fundamental sciences connected with engineering, *mechanics*, and *natural philosophy*. These men look down upon all theory with such an amount of contempt, that it is almost ridiculous; but it is nevertheless a fact, that all their practical knowledge is not half so useful to them as it would be if they had possessed a certain amount of theory. In proof of this let us instance such men as Whitworth and Fairbairn. Would they have attained their high position without the assistance of theory? No, certainly not. The great failing of those non-theoretical men is that they nearly always oppose inventions and improvements, because, being new to them, and not having seen their fathers do the same, they don't like "to get upon slippery ice," where they might fall and make blunders. At the same time, theory without practice is in many cases almost useless; therefore combine them, and by so doing every one will soon feel the benefit. Adhering to this principle, every care has been taken in the following pages to bring forward only such rules as have been tried in practice and found good; and should they be useful to those inquiring into the subject, the point aimed at will be attained. Should the experience of others have given different results, or should any errors be discovered in what is now laid before them, it will be esteemed a favour if they will kindly point them out.

The first step to commence with is to get a distinct and clear idea of the different strains we have to deal with when we calculate the strength of the different materials employed in the construction of engines and machinery.

	Strain.	Fracture.
1. Longitudinal.....	{ Extension ...	Tearing.
	{ Compression ...	Crushing.
	{ Distortion ...	Shearing.
2. Transverse.....	{ Twisting ...	Wrenching (Torsion).
	{ Bending ...	Breaking across.

The *Breaking Weight* is that weight which, applied to a body, will produce rupture.

The *Working Strain* on a piece of machinery is that part of the breaking weight which, by experience, has been proved to be safe in daily use.

When the *Elastic Force* of a material to withstand a certain weight is not exceeded, the crystallisation is undisturbed, and the material, after being strained, will return to its original state.

The following table has, by experience, been found to be reliable in practice, as a fair average of the breaking weight and crushing force of different metals.

The elastic force or tensile strain of malleable iron without derangement of its structure has been found to be about 17,500 lbs. In this table all the materials have a cross sectional area of 1 square inch.

This table must only be taken as a medium; and should it be desired to know the exact strain a certain sort of metal will bear, the reader should refer to Mr. D. Kirkaldy's valuable list of experiments, published in THE ARTIZAN of January, 1860, and which may be fully relied on.

We will now turn to the transverse strains upon material; and after a description in general, it will be shown separately how each kind of strain is applied to machinery for practical purposes, with the necessary factor of safety. But as the question relating to the transverse strain of materials was treated in so superior a manner in THE ARTIZAN four years ago (July, 1857), in an "Inquiry into the Strength of Beams and Girders," by Mr. Samuel Hughes, C.E., one cannot do better than refer to that excellent paper, from which we have taken the following short extract of the first

part most applicable to machinery, because it forms one of the fundamental pillars for the calculation of the different strengths of parts of engines and machinery in general.

Table of the Breaking Weight and Crushing Force of the most useful Materials used in Machinery.

METALS.	Breaking Weight.		Crushing Force.
	lbs.	Tons.	
Swedish bar iron	65,000	29.20	...
Russian ditto	59,470	26.70	...
English ditto	56,000	25.00	27,000
Cast Steel	134,000	59.85	250,000
Blistered Steel	133,000	59.30	150,000
Shear Steel	127,000	56.70	150,000
Wrought Copper	33,900	15.10	6,700
Hard Gun Metal	36,300	16.23	12,250
Cast Copper	19,000	8.50	10,000
Yellow Brass (cast)	17,000	7.60	10,000
Cast Iron.....	15,000	6.70	100,000

The experiments of Mr. Fairbairn for ascertaining the transverse strength of cast iron beams has generally been made on bars 1in. square and 4ft. 6in. between supports, and thus the breaking weights were found for the different kinds of iron. To reduce that, however, to unity, Mr. Hughes has used bars 1in. square, and 1ft. long between supports.

The rule for finding the breaking weight for rectangular bars of cast iron is:—Multiply the breadth of the given bar (in inches) by the square of the depth (in inches) by S, the experimental breaking weight of a bar 1in. square and 1ft. long, and divide the product by the length of the bar between supports (in feet): the quotient will give the breaking weight of the bar required (in lbs.)

If b = breadth of bar in inches, d = depth in inches, l = length in feet, and S = the breaking weight in lbs., for a bar 1in. square and 1ft. long of the kind of iron used; then $\frac{b d^2 S}{l} = W$ lbs. (the real breaking weight of the bar); and putting e for the constant of a bar or the value of $b d^2$, it is easy from the general equation $\frac{S e}{l} = W$ to determine either of the other quantities.

Thus $\frac{S e}{l} = W$ (1)

$\frac{W l}{e} = S$ (2)

$\frac{W l}{S} = e$ (3)

$\frac{S e}{W} = l$ (4)

N.B.—When S is taken from Fairbairn's table (which was obtained from bars 4.5 feet long), of course the number found in the column marked S must be multiplied by 4.5: thus for Ponkey iron we find in the table 587, but use $(581 \times 4.5 = 2614.5)$ 2614.5 in Hughes's formula.

For example, call 2000 lbs. (a very good medium) the breaking weight of a cast iron bar 1ft. long and 1in. square, to find the breaking weight of a bar 20ft. long between the bearings, 3in. wide and 24in. deep.

Here the constant of the required bar is $3 \times 24^2 = 1728$, and then

1. $\frac{2000 \times 1728}{20} = 172,800$ lbs.,

the breaking weight required.

2. $\frac{172,800 \times 20}{1728} = 2000$.

3. $\frac{172,800 \times 20}{2000} = 1728$.

4. $\frac{2000 \times 1728}{172,800} = 20$.

N.B.—The breaking weight, S, must by no means be confounded with the safe or permanent load. The latter should not exceed one-fourth of the breaking weight for building purposes, and one-sixth to one-tenth for machinery. As a striking example how differently the metal can be applied in respect to saving material, we will give the following example:—

Supposing $S = 512$; required the constant of a bar 8ft. long between supports, which will bear a weight of 3200 lbs. without breaking?

Here $\frac{3200 \times 8}{512} = 50$, the constant required.

It is evident that in order to bear this weight the bar may be in various shapes, provided always the breadth multiplied with the square of the depth be equal to 50, namely, $b d^2 = 50$. Thus, if

1. $b = 1$ inch, $d = \sqrt{50} = 7.07$ inches.

2. $b = d$, $b = \sqrt[3]{50} = 3.684$ inches.

3. $d = 1$ inch, $b = 50$ inches.

In each of these cases the constant is the same, consequently the strength of the beam the same; but let us observe the very great difference in quantity of material.

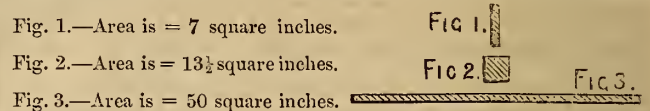

From the former it will be seen, that in rectangular beams the lateral strength is directly proportional to the breadth, and that the strength varies directly as the square of the depth, and inversely as the length; but the following properties, with reference to the breaking weight applied to beams under different circumstances, are also of importance.

- I. When a beam is fixed at one end and loaded at the other. We will take this as unity.
 - II. When a beam is fixed at one end and loaded uniformly, it will support double the weight of No. I.
 - III. When the beam is supported at both ends and loaded in the middle, it will support four times the weight of No. I.
 - IV. When the beam is supported at both ends and loaded uniformly, it will support eight times the weight of No. I.
 - V. When the beam is firmly fixed at both ends and loaded in the middle, it will support six times the weight of No. I.
 - VI. When the beam is firmly fixed at both ends and loaded uniformly, it will support twelve times the weight of No. I.
- These six points will be better remembered, when illustrated with a few sketches, thus:—

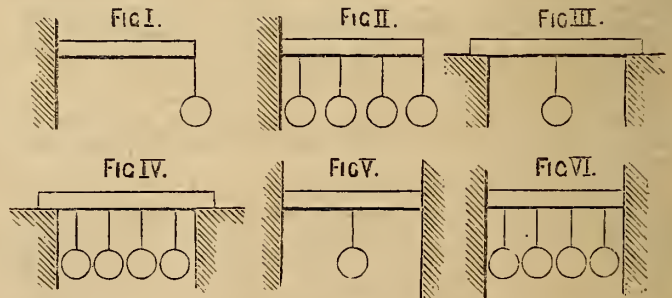

These six illustrations represent the same beam in the six different cases, and in the following ratio to No. I:—

I = 1.	IV = 8
II = 2.	V = 6.
III = 4.	VI = 12.

But as S is always found in the tables for No. III. when the beam is loaded in the middle, we must of course divide S by 4 when we want to know the experimental breaking weight, S, of a beam No. I.; or multiply by 2 when we want to know the experimental breaking weight, S, for a beam No. IV., and so on.

CLASSIFICATION.

Arguments or known Facts of the Beam.	Nature of Curve or Lines for remaining parts.	Parts to be determined.	Relations which the unknown Dimension bears to the length or Value, by which the Dimension for Unity must be multiplied to find the Dimension for any corresponding length.
I.—BEAMS* FIXED AT ONE END.			
<i>a.—Load at extremity.</i>			
1. Depth equal throughout..	Sides straight	<i>b</i>	<i>l</i>
2. Breadth equal throughout	Sides parabolic	<i>d</i>	\sqrt{l}
3. All sections similar figures	Sides cubic parabola	<i>b</i> & <i>d</i>	$\sqrt[3]{l}$
<i>b.—Load uniformly distributed.</i>			
1. Depth equal throughout..	{ Sides formed by arches } { of parabola	<i>b</i>	l^2
2. Breadth equal throughout	Top & bottom straight	<i>d</i>	<i>l</i>
3. All sections similar figures	Semi-cubic parabola	<i>b</i> & <i>d</i>	l^3
II.—BEAMS SUPPORTED AT BOTH ENDS.			
<i>a.—Load in the middle,† or at any other fixed point.</i>			
1. Depth equal throughout..	Sides straight	<i>b</i>	<i>l</i>
2. Breadth equal throughout	Sides parabolic	<i>d</i>	\sqrt{l}
3. All sections similar figures	Sides cubic parabola	<i>b</i> & <i>d</i>	$\sqrt[3]{l}$
<i>b.—Load uniformly distributed,‡ or at any variable point.</i>			
1. Depth equal throughout..	Sides nearly straight	<i>b</i>	l^x
2. Breadth equal throughout	Sides elliptical	<i>d</i>	$\sqrt{l^x}$
3. All sections similar figures	Sides cubic parabola	<i>b</i> & <i>d</i>	$\sqrt[3]{l^x}$

* On beams of this class *l* means the length from the free or unfixed end.

† Here *l* means the length from the nearest extremity.

‡ Here *l'* and *x* are the two segments which form together the whole length of the beam.

As the shape of a parabola and a cubic parabola is often used to save material in beams, as is shown under the classification of beams, it may be useful in this place to show how to draw a parabola, a tangent to a parabola, and a cubic parabola.

HOW TO DRAW A PARABOLA.

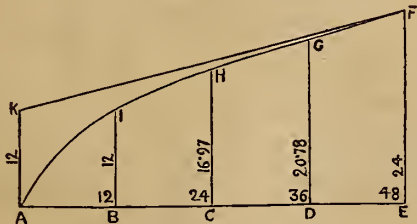

Let A E be the length of the beam, and E F the base; then divide A E in four equal parts, thus: A B = B C = C D = D E = 12in. each; E F = 24in.; then by the property of the parabola,

$$A E : A D :: F E^2 : G D^2$$

that is $48 : 36 :: (24)^2 : 432$

the square root of which is 20.78 = G D.

and $A E : A C :: F E^2 : H C^2$

that is, $48 : 24 :: 576 : 288$

the square root of 288 = 16.97 = H C.

and $A E : A B :: F E^2 : I B^2$

that is, $48 : 12 :: 576 : 144$

the square root of 144 = 12 = I B.

A line drawn through the points F, G, H, I, and A will be a parabola.

How to draw a Tangent to a Point of a Parabola.

(The point here is F.)

From the vertex, A, of the parabola draw A K perpendicular to A E, and make it equal to $\frac{1}{2}$ F E; then draw K F, and K F will be the tangent required.

HOW TO DRAW A CUBIC PARABOLA.

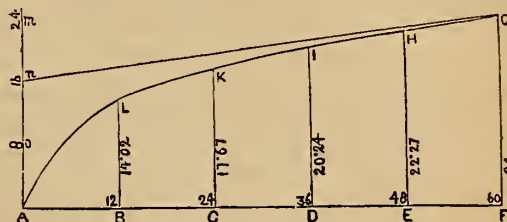

Let A F be the length of the beam, and F G the base; then divide A F in five equal parts, thus:—A B = B C = &c. = 12in. each, F G = 24in.; then by the property of the cubic parabola,

$$\sqrt[3]{A F} : \sqrt[3]{A E} :: F G : E H$$

that is, $\sqrt[3]{60} : \sqrt[3]{48} :: 24 : 22.27 = E H$

$$\sqrt[3]{60} = 3.915; \sqrt[3]{48} = 3.634 \times 24 = 87.2 \text{ and } 87.2 \div 3.915 = 22.27.$$

and $\sqrt[3]{A F} : \sqrt[3]{A D} :: F G : D I$

that is, $\sqrt[3]{60} : \sqrt[3]{36} :: 24 : 20.24 = D I.$

and $\sqrt[3]{A F} : \sqrt[3]{A C} :: F G : C K$

that is, $\sqrt[3]{60} : \sqrt[3]{24} :: 24 : 17.67 = C K$

and $\sqrt[3]{A F} : \sqrt[3]{A B} :: F G : B L$

that is, $\sqrt[3]{60} : \sqrt[3]{12} :: 24 : 14.02$

A line drawn through the points G, H, I, K, L, and A will be a cubic parabola.

How to draw a Tangent to a Point of a Cubic Parabola.

(Here the point is G.)

From the vertex A of the cubic parabola draw A M perpendicular to A F, divide A M in three equal parts, A O, O N, and N M, draw a line from N to G, and N G will be the tangent required.

The deflection of beams is a question on which we are still in want of further decisive experiments to give exact formulæ for the different kinds of materials. The following are two different rules commonly used.

Tredgold gives this rule:—

Multiply the weight or power (in lbs.), acting at the end of a single beam (crank) by the cube of its length (in feet), and this product, divided by 2662 times the deflection (in inches) will give the product of the breadth and cube of the depth (in inches).

Let W = weight (in lbs.), *l* = length of beam or crank (in feet), *b* = breadth, *d* = depth, both (in inches), S = deflection in inches, then

$$\frac{W l^3}{2662 \times 8} = b d^3$$

This rule is for a uniform beam, of which the section is a rectangle; but if the beam is of the parabolic kind, divide by 1628 instead of 2662. The beam is cast iron.

A general rule for deflection of beams is this:—The deflection is directly as the cube of the length, inversely as the cube of the depth, and inversely as the breadth.

$$\text{Deflection} = \frac{W \text{ in lbs.} \times \text{length}^3 \text{ in feet}}{48 \times E \times x}$$

E = modulus of elasticity.

$x = \frac{1}{2} \times b \times d^3$ in a beam with rectangular section.

$x = \frac{1}{12} \times b \times d (\frac{1}{4} b^2 + \frac{1}{3} d^2)$ in a beam with triangular section.

$x = \frac{1}{4} r^4 \times \pi$ in a beam with circular section.

$x = \frac{\pi}{4} (R^4 - r^4)$ in a hollow beam.

Modulus of Elasticity.

Brass (cast)	8,900,000.
Gun metal	9,873,000.
Cast iron	18,400,000.
Wrought iron	24,920,000.
Steel (best shear)	20,000,000 (soft).
ditto ditto	29,000,000 (hard).

The two other transverse strains by distortion and twisting will be treated upon afterwards; the first, under the shearing force of keys, pins, &c., the second, under torsion of shafts. In proceeding, we will now see why the old fashioned way of calculating engines is faulty, and how it is proposed to do it.

Whenever we open one of those old standard works still used by engineers for calculating the different parts of a steam engine, such as Tredgold, John Bourne, Templeton, &c., we will find that they all calculate everything according to nominal horse power, such as area of piston, speed of piston, revolutions, grate and heating surface, &c., and having once found the sizes of those, we will again find that nearly all the details of the engines are calculated from the diameter of the cylinder, such as piston rods, cross-heads, cylinder side rods, side levers, crank shafts, cranks, crank pins, air pump rods, eccentric rods, eccentric hoops, &c.; however, it must be admitted that it is desirable that the strength of all these different parts should be found theoretically by entirely different rules; for instance, the piston rod and cylinder side rods, by considering the crushing force upon them; the cross-head and side levers, by considering them as beams; the crank shaft, by considering what power will twist it asunder; the crank considered as a single beam; the crank pin as a gudgeon; the air pump rod, by calculating the amount of water to be lifted, + 13lb. for each square inch of area of air pump bucket; the eccentric rod, by calculating the friction of the slide, and the power necessary to move it; and the eccentric strap in the same manner.

Now let us even admit that the old system of calculating might do for those days, when we had only 7lb. pressure on the square inch, and never more; but it was neither business nor engineerlike, because the designer never knew what he was doing, or why he was doing this or that, but he was entirely left in the hands of the printer, who is now and then apt to make mistakes. The following misprint, for example, has perhaps been the cause of breaks down in some engines or other; for as he (the designer) must follow the rule given, say diameter of cylinder 40in. x .25 instead of .52, which would make the not very small difference of 10 instead of 20.8, without his being able to find out the proper proportion, even if he could see that this was not right; therefore such rules are more like rudiments for children than a scientific guide for an engineer.

But how it is possible to continue using nominal horse power and diameter of cylinder as starting points in our days, in which we have from 20lb. up to 150lb. pressure for engines, it is difficult to understand. Even in the new *Handbook for Engineers* (1860), by Mr. Charles Lowndes, at page 16, the rules are given for fire-grate surface per nominal horse power, and, at page 40, the rule for the crank pin is given as $1\frac{1}{4}$ to $1\frac{1}{2}$ x diameter of piston rod (it is shown a little above that the calculation of the crank pin and piston rod is founded upon two quite different principles); the rule for piston rods is given as $\frac{1}{10}$ th the diameter of cylinder for low pressure, and $\frac{1}{8}$ to $\frac{1}{4}$ for high pressure—it will be too strong for the first case and too weak for the last, as will be seen further on. Mr. Lowndes then gives several rules for various parts of the engine, all referring to the piston rod, but one is too peculiar to pass without mentioning something in contradiction. He says: "The shaft, if of wrought iron, the piston rod x 2 to 2 $\frac{1}{2}$." This is evidently wrong, because the power that exerts a crushing force on the piston rod acts in quite a different way to that, which tries to twist the crank shaft asunder, and can therefore by no means be included in the same rule as one being the half of the other. As an example of the fallacy of calculating the diameter of the piston rod from the diameter of cylinder, we cannot have a better specimen than the following illustration:—Supposing we have got a cylinder 14 $\frac{1}{2}$ in. diameter = 170 square inches, with a pressure of 20lb., steam 7lb., + 13lb. vacuum, making a total pressure on the piston of 3400lb.; now, taking $\frac{1}{10}$ th part of the crushing force, we have for the diameter of the piston rod $1\frac{1}{4}$ in. In another engine we have the same cylinder, but 100lb. pressure; what is the diameter of the piston rod? Here the total pressure on the piston is 17,000lb., and consequently the diameter

of piston rod 2 $\frac{1}{2}$ in. According to the old rules and Mr. Lowndes's rule it would be diameter of cylinder x .1 = 1.475, which is a deal too strong; and the last diameter of cylinder x $\frac{1}{8}$ or $\frac{1}{7}$ = 2.46in. and 2.11in., which is much too weak. Thus it is proved that these rules will not stand good when properly investigated, and, in particular, when applied to the increased pressure in use at the present time.

(To be continued.)

RESISTANCE OF WROUGHT IRON TUBES TO EXTERNAL AND INTERNAL PRESSURE.

(Deduced from Experiments of W. Fairbairn.)

By CHARLES H. HASWELL, Civil and Marine Engineer, New York.

In order to save space, and to increase the generative powers of boilers, internal flues and tubes have been generally adopted, and without sufficient attention to the proportions of their diameter, length, and thickness of plates, so as to ensure safety and economy of material in its judicious distribution. Hitherto it has been considered a rule amongst engineers that a cylindrical tube, such as a boiler flue, when subjected to a uniform external pressure, was equally strong in every part, and that the length did not affect the strength of a tube so placed. Although this rule may be true when applied to tubes of indefinite length, it is very far from true where the lengths are restricted within certain apparently constant limits, and where the ends are securely fastened, as in head or tube sheets which prevent their yielding to an external force, or where, as in flues constructed in courses, the laps present a ring which greatly increases their resistance. In some experimental tests to prove the efficiency of large boilers, it was ascertained that flues 35 feet long were distorted with considerably less force than others of a similar construction 25 feet long. This result led to further inquiry, and the following series of experiments were instituted with very conclusive results.

RESULTS OF EXPERIMENTS ON THE RESISTANCE OF WROUGHT IRON TUBES AND FLUES TO EXTERNAL PRESSURE OR COLLAPSE.

	No. of Experiment.	Diameter.	Length.	Thick-ness.	Pressure of Collapse per sq. in.
		in.	in.	in.	lbs.
Welded Tubes and Ends secured to Head Plate	1	4	19	.043	170
ditto ditto	2	4	19	.043	137
ditto ditto	3	4	40	.043	65
ditto ditto	4	4	38	.043	65
ditto ditto	5	4	60	.043	43
ditto ditto	6	4	19	.043	149
ditto ditto	7	6	30	.043	48
ditto ditto	8	6	29	.043	47
ditto ditto	9	6	59	.043	32
ditto ditto	10	6	30	.043	52
ditto ditto	11	6	30	.043	65
ditto ditto	12	8	30	.043	39
ditto ditto	13	8	39	.043	32
ditto ditto	14	8	40	.043	31
ditto ditto	15	10	50	.043	19
ditto ditto	16	10	30	.043	33
ditto ditto	17	12.2	58.5	.043	11.0
ditto ditto	18	12	60	.043	12.5
ditto ditto	19	12	30	.043	22.0
Riveted Tubes	20	18.75	61	.25	420
ditto	21	9	37	.14	262
ditto	22	9	37	.14	378
Welded Tubes—Ends left open	23	4	60	.043	47
ditto ditto	24	4	30	.043	93
ditto ditto	25	4	15	.043	147
Riveted Tubes—Ends closed	26	{ 14.5 by 14.6875 }	60	.125	125
Cylindrical Riveted Flues ...	27	18.75	61	.25	420
ditto ditto	28	12	60	.043	12.5
Elliptical Riveted Flues.....	29	20.75 x 15.5	61	.25	127.5
ditto ditto	30	14 x 10.25	60	.043	6.5

Tubes and Short Flues.

In the subjection of a tube or flue to external pressure, the material being compressed becomes crumpled in longitudinal lines near the middle, the tube loses its original cylindrical shape at and near to that part, whilst

the portions toward the extremities when supported by inflexible end plates, or the centre portions when sustained by the laps of the courses, retain their original form; so that the material virtually resisting compression in the comparatively small portion in the middle and between the laps of the courses, and which in the latter case, to a certain extent, is independent of the length of the tube, whilst the pressure producing the compression is always approximately proportional to the area of the longitudinal section of the tube.

Hence, as the total external pressure on a tube or flue varies directly as its longitudinal section, that is, as the product of the length and the diameter.

$P' \cdot l \cdot d \cdot C = P$; P' representing the pressure to which the tube, &c., is subjected in pounds per square inch, l , the length of the tube in feet, and C , a constant to be determined.

It has been ascertained by experiment that the resistance of thin metal plates to a force tending to crush or crumple them varies directly as a certain power (x) of their thickness, the number indicating the power lying between 2 and 3. Hence, the value of a tube, &c., to resist collapse is as $\frac{P}{t^x}$; t representing the thickness of the metal in inches.

The mean of the products of $P' \cdot l \cdot d$ in the several experiments here given, where the metal is of an uniform thickness of $\cdot 043$ in., is 850; for a thickness of $\cdot 125$ in., 9140, &c.; and the mean of the value of x for all thicknesses is 2.19.

Consequently, $\frac{850}{\cdot 043^{2.19}} = 835800$,

and $835800 \times \frac{t^{2.19}}{l \cdot d} = P'$

which is the general formula for calculating the strength of wrought iron tubes and short flues subjected to external pressure, within the limits indicated by the experiments—that is, provided their length is not less than 1.5 foot, and not greater probably than 10 feet.

In order to facilitate calculation this formula may be written

$$\log P = 1.5265 + 2.19 \log 100 t - \log (l d);$$

and by an obvious transformation,

$$\frac{850}{l \cdot d} = P'$$

By taking 2 instead of 2.19 for the index of t , this formula becomes as follows:—

$$V \times \frac{t^2}{l \cdot d} = P', \text{ the collapsing pressure.}$$

For thick tubes of considerable diameters and lengths, this formula is sufficiently exact for practical purposes. V varies with the thickness of the tubes and flues, and may be safely estimated, as in the following table.

When a flue is constructed of courses, the above rule will apply by estimating the length of it to be the distance between the centres of two contiguous laps when the flue is of one course, or in the middle of each course when there are some two to four of them, if the whole length of the flue does not exceed three times the length of a course; when, however, the length does exceed that proportion, the estimate of its resistance is to be made by taking the units from the following tables. In one experiment the tube was divided into three parts by two rigid rings soldered upon its exterior, and its powers of resistance were thus increased in the ratio of 3 to 1; *virtually*, the length was reduced in this ratio, and the strength was *actually* increased from 43 to 140 lbs. per square inch.

For Lengths from 1.5 to 10 feet.

From $\cdot 043$ to $\cdot 125$ inch in thickness,	380,000 to 520,000
" $\cdot 125$ to $\cdot 25$ " " "	520,000 to 650,000
" $\cdot 25$ to $\cdot 375$ " " "	650,000 to 720,000
" $\cdot 375$ to $\cdot 5$ " " "	720,000 to 800,000

For Lengths from 10 to 18 feet.

From $\cdot 125$ to $\cdot 25$ inch in thickness,	650,000 to 720,000
" $\cdot 25$ to $\cdot 375$ " " "	720,000 to 810,000
" $\cdot 375$ to $\cdot 5$ " " "	810,000 to 910,000

For Lengths from 18 to 25 feet.

From $\cdot 125$ to $\cdot 25$ inch in thickness,	720,000 to 810,000
" $\cdot 25$ to $\cdot 375$ " " "	810,000 to 920,000
" $\cdot 375$ to $\cdot 5$ " " "	920,000 to 1,020,000

For Lengths from 25 to 35 feet.

From $\cdot 125$ to $\cdot 25$ inch in thickness,	810,000 to 920,000
" $\cdot 25$ to $\cdot 375$ " " "	920,000 to 1,020,000
" $\cdot 375$ to $\cdot 5$ " " "	1,020,000 to 1,120,000

NOTE.—In selecting the above units regard should be had to the length of the flue, independent of the ordinary conditions of strength of the materials and character of the riveting, as the nearer the length is to the limit of length at the head of each table, the higher the unit is to be taken.

Illustration:—

1. Let $t = \cdot 043$ inches, $l = 2.5$ feet, and $d = 6$ inches.

Then $\frac{\cdot 043^2}{2.5 \times 6} \times 400,000 = \frac{\cdot 001849}{15} \times 400,000 = 49.3$ lbs.

Experiments 7 and 10 give 50 lbs. for a length of but 2.5 feet.

2. Let $t = \cdot 25$ inches, $l = 5$ feet, and $d = 18.75$ inches.

Then $\frac{\cdot 25^2}{5 \times 18.75} \times 585,000 = 390$ lbs.

Experiment 20 gave 420 lbs. for a length of but 5 feet 1 inch.

3. Let $t = \cdot 375$ inches, $l = 25$ feet, and $d = 42$ inches.

Then $\frac{\cdot 375^2}{25 \times 42} \times 920,000 = 123.2$ lbs.

Experiment gave 127 lbs. for a length of 25 feet.

The following table will show how nearly this formula represents the results of the experiments on the different classes of tubes.

No. of Experiment.	d Diameter.	l Length.	t Thickness.	P' By Experiment per sq. in.	P' By Formula of $t^{2.19}$.	P' By Formula of t^2 .
2	in. 4	feet. 1.58	in. $\cdot 043$	lbs. 137	lbs. 130	lbs. 130
5	4	5	$\cdot 043$	43	41	41
7, 10, 11	6	2.5	$\cdot 043$	55	54.7	54.7
13	8	3.25	$\cdot 043$	32	31.6	31.6
15	10	4.16	$\cdot 043$	19	19.7	19.5
18	12	5	$\cdot 043$	12.5	13.6	13.6
20	18.75	5.08	$\cdot 250$	420	407	435.5
21	9	3.08	$\cdot 140$	378	392	388.3
26	14.6	5	$\cdot 125$	125	116	134.7

Results of Experiments on the Resistance of Wrought Iron Cylindrical Tubes or Flues to Internal Pressure or Bursting.

No.	Diameter.	Length.	Thickness	Pressure of Rupture per sq. in.	Remarks.
31	in. 6	in. 12	in. $\cdot 043$	lbs. 475	Burst by rending of Rivets.
32	6	24	$\cdot 043$	235	{ Burst through Plates and Rivets—Plates very brittle.
33	6	30	$\cdot 043$	230	{ Burst by Rupture of Rivet Heads.
34	6	48	$\cdot 043$	375	Burst by rending of Rivets.
35	12.13	60	$\cdot 043$	110	{ Burst through Plates and Rivets—Plates brittle.

FORMULE OF RESISTANCE OF CYLINDRICAL TUBES OR FLUES.

The strain which the material of a cylindrical vessel is submitted to, when a uniformly distributed external pressure is applied to it, is very different from the strain produced when the pressure acts internally. In the latter case the material is equally extended throughout all its parts, and its cylindrical form is preserved at all stages of the pressure, with the exception of the small portion of the plates where they overlap to close their extremities. The tube under a high internal pressure will assume the form of the middle frustrums of a spindle, and the relation of the force of rupture to that of resistance will be approximately expressed by

$$\frac{T \times 2 t}{d} = P,$$

T representing the tensile resistance of the material per square inch in pounds, t its thickness, d its diameter in inches, and P the pressure requisite to produce rupture of the tube or flue in pounds. From a consideration of which experiments it appears—

1st. That the resistance of tubes or flues to any external or internal pressure varies directly and inversely as their diameters.

2nd. That the resistance of a tube or flue to external pressure up to the length experimented upon is inversely as its length. Consequently, the resistance of tubes or flues to external pressure of different diameters, but of equal length, varies inversely as their diameter, and contrariwise.

3rd. The tubes or flues with lap joints have one-third less resistance to external pressure than when their joints are abutted.

4th. That a cylindrical tube or flue has three times the resistance to external pressure of an elliptic tube or flue of the proportionate diameter given in the experiment noticed (29).

5th. That the length of tubes or flues to resist internal pressure has no essential effect.

6th. That with tubes or flues of like thickness, their resistance varies inversely as the product of their lengths by their diameters.

Results of Experiments on the Resistance of Elliptic Flues to External Pressure or Collapse.

By comparing the result of experiment (30) on the elliptical tube with the result of the experiments on the cylindrical tubes, we find that the preceding general formula will apply approximately to elliptical tubes, by substituting for D in that formula, the diameter of the circle of curvature touching the extremity of the minor axis.

Thus,

$$\text{Diameter of the circle of curvature} = \frac{2r^2}{r'} = \frac{2 \times 7^2}{5 \cdot 125} = 19 \cdot 12 \text{ inches.}$$

The pressure on this elliptical tube was 6·5 lbs.; which, reduced to unity of length and diameter = 621·4 lbs. (19·12 × 5 × 6·5), which result nearly agrees with 688 lbs., the mean pressure of the 12in. tubes, also reduced to unity of length and diameter.

The pressure P' per square inch requisite to collapse a tube of variable curvature varies inversely as the diameter of curvature.

RESISTANCE OF WROUGHT IRON CYLINDRICAL TUBES TO INTERNAL PRESSURE.

Taking the mean of the results of Experiments 31 and 34 on iron tubes,

$$P = \frac{P' \times d}{2t} \text{ or } \frac{425 \times 6}{2 \times \cdot 043} = 29651 \text{ lbs.,}$$

and $\frac{2t \times P}{P'} = d$, or $\frac{2 \times \cdot 043 \times 29651}{425} = 6 \text{ inches,}$

and $\frac{P \times 2t}{d} = P'.$

Hence,—To ascertain the thickness of a Wrought Iron rivetted Tube or Flue, the Diameter of the Tube, and the Pressure in Pounds per square Inch being given.

RULE.—Multiply the pressure in pounds per square inch by the diameter of the tube in inches, and divide the product by twice the tensile resistance of the metal in pounds per square inch.

EXAMPLE.—The diameter of a wrought iron flue 6 inches, and the pressure to which it is to be submitted is 425 lbs. per square inch, what should be the thickness of the metal?

$$\frac{425 \times 6}{29651 \times 2} = 59302 = \cdot 043 \text{ inches.}$$

Assume the tensile resistance to be as above, 29,651 lbs.

The tenacity or tensile resistance of wrought iron boiler plates ranges from 62,000 to 42,000 lbs. (including English plates) per square inch; hence it appears that, in the cases given, a reduction of tenacity of about ¼ must be made.

From experiments 7, 8, 10, and 11, and 31, 32, 33, and 34, it appears that tubes or flues subjected to internal pressure or bursting, have much greater resistance than when subjected to external pressure or collapsing, in the cases given, when the length of the collapsed tubes was 2·5 feet, the difference is about 6·2 times.

The difference, however, between these strains cannot be determined as a rule, for the reason that the resistance to internal pressure is inversely as the diameter of the tube or flue alone, without regard to its length; whereas, with the resistance to collapse, the stress is inversely as the product of the diameter and the length.

Application to Construction of the Results of the Experiments.

Throughout the experiments here enumerated, it has been proved that the resistance to collapse from a uniform external pressure, in cylindrical tubes or flues, varies in the inverse ratio of the lengths. This law has been tested to lengths not exceeding fifteen diameters of the tube or flue; but the point at which it ceases to hold true is as yet undetermined, and it can only be ascertained by a series of experiments on tubes and flues of greater length, in which the strength of the material modifies the above law of resistance to collapse. Such experiments are desirable, but the results already obtained appear to supply the data necessary for calculating the resistances and proportioning the material in ordinary cases.

Thus, with drawn or brazed tubes, where there are no courses and consequent laps, their length is an essential element in an estimate of their resistance to collapse; but with rivetted flues, constructed in courses, the objection to length is removed, as the addition of the laps is a source of great resistance to collapse, rendering the flue alike to a series of lengths, each equal to the distance between the centres of the courses.

In a boiler of the ordinary construction of 30 feet in length, and 3 feet 6 inches in diameter, with two flues 16 inches in diameter, the cylindrical external shell has 2·8 times resistance to the force tending to burst it than the flues have to resist the same force to collapse them. This being the case, it is not surprising that the collapse of the internal flues so frequently occurs. To remedy this, and to place the security of boilers upon a more certain basis, it is essential that every part should be of uniform strength to resist the stress upon it. The equalisation of the powers of resistance is the more important, as the increased strength of the outer shell is absolutely of no value, so long as the internal flues remain liable to be destroyed by collapse at a pressure of only one-third of that required to burst the envelope which contains them.

The following table, deduced from experiments, exhibits the collapsing pressure of flues and bursting pressure of boilers of different diameters and thicknesses of metal.

TABLE OF THE RESISTANCE OF WROUGHT IRON FLUES TO AN EXTERNAL OR COLLAPSING PRESSURE, AND OF THE SHELLS OF BOILERS TO AN INTERNAL OR BURSTING PRESSURE.

Tensile Resistance of the Plates without Rivetting is taken at a mean of 55,000 lbs. per square inch.

FLUES.				SHELLS.			
Diameter of Flue.	Length of Flue.	Thickness of Flue.	Collapsing Pressure per sq. in.	Diameter of Shell.	Thickness of Shell.	Bursting Pressure per sq. in.	
						Single Rivetted.	Double Rivetted.
in.	feet.	in.	lbs.	ft. in.	in.	lbs.	lbs.
6'	10	·2	417	2 0	·25	573	745
6·5	10	·2	385	2 6	·25	458	596
7'	10	·2	357	3 0	·25	382	496
7·	10	·25	580	3 4	·25	318	414
7·5	10	·2	333	3 4	·3125	395	528
7·5	10	·25	542	3 6	·25	327	426
8'	10	·2	312	3 6	·3125	409	532
8·	10	·25	508	4 0	·25	286	372
8·5	10	·2	294	4 0	·3125	358	465
8·5	10	·25	478	4 6	·25	254	331
9'	10	·2	278	4 6	·3125	328	413
9·	10	·25	451	5 0	·25	229	298
9·5	10	·2	263	5 0	·3125	286	372
9·5	10	·25	427	5 0	·25	208	270
10'	12	·2	227	5 6	·3125	260	338
10'	12	·25	354	5 6	·375	312	406
10·	12	·3125	612	5 6	·25	191	248
10·5	12	·2	216	6 0	·3125	239	311
10·5	12	·25	337	6 0	·375	286	372
10·5	12	·3125	583	6 6	·3125	220	287
11·	12	·2	206	6 6	·375	264	344
11·	12	·25	322	7 0	·3125	204	266
11·	12	·3125	557	7 0	·375	245	319
11·5	12	·2	197	7 6	·3125	191	248
11·5	12	·25	308	7 6	·375	229	298
11·5	12	·3125	532	8 0	·3125	179	233
12'	15	·2	153	8 0	·375	215	279
12'	15	·25	239	8 6	·3125	168	219
12'	15	·3125	415	8 6	·375	202	263
12·5	15	·25	229	9 0	·3125	159	207
12·5	15	·3125	398	9 0	·375	191	248
13'	15	·25	220	9 6	·3125	150	196
13'	15	·3125	384	9 6	·375	181	235
13·5	15	·25	212	10 0	·3125	143	186
13·5	15	·3125	369	10 0	·375	172	224
14'	18	·25	176	10 0	·5	229	298
14'	18	·3125	305	10 6	·3125	136	177
14·5	18	·25	169	10 6	·375	163	212
14·5	18	·3125	294	10 6	·5	218	284
15'	20	·25	157	11 0	·375	156	203
15'	20	·3125	276	11 0	·5	208	271
15·5	20	·25	152	11 6	·375	149	194
15·5	20	·3125	267	11 6	·5	199	259
16'	20	·25	148	12 0	·375	143	186
16'	20	·3125	231	12 0	·5	191	248

NOTE.—The single rivetted are estimated at '5, the resistance of the plates and the double rivetted at '65; this reduction from '56 and '7, as determined by Fairbairn, is to meet defects of rivets, cracks of plates, from the pinning of rivet holes, &c., his experiments having been made with rivets and plates in a normal condition.

APPLICATION OF THE PRECEDING TABLES.

To ascertain the ultimate collapsing Resistance of a Flue, when the Thickness of the Metal is not given in the above Table.

RULE.—Take the square of the thickness of the metal, if given in decimals of an inch, or that due to the number of it, if given by a wire gauge, and multiply it by its proportional unit, or multiplied from the table preceding (p. 136), the thickness and length being duly considered, and divide the product by the product of the diameter of the flue in inches, and the length of it in feet.

EXAMPLE.—The diameter of a flue is 15 inches, the thickness of the metal No. 3, U. S. wire gauge (= '23 inch), and the length of it is 30 feet. What is its ultimate resistance to collapse per square inch?

Multiplicators for thicknesses from '125 to '25 inch, and for a length of 30 feet, are 810,000 to 920,000, the difference of which is (920,000 - 810,000) = 110,000, and the difference in the thickness ('25 - '125) = '125.

Then, as '125 : 110,000 :: '105 ('23 - '125) : 92,400.

Difference in length, (35-25) = 10.

Then, as 10 : 110,000 :: 5 (35 - 30) : 55,000

Consequently, $\frac{92400 + 55000}{2} = 73700,$

a mean multiplier of thicknesses and lengths, which, added to 810,000, the multiplier for '125in. in thickness, and 25ft. in length = 883,700.

Hence $\frac{.23^2}{30 \times 15} \times 883700 = \frac{.0529}{450} \times 883700 = 103'88\text{lbs.}$

To ascertain the ultimate Bursting Resistance of the Shell of a Boiler, when the Thickness of the Metal is not given in the above Table.

RULE.—Double the thickness given, or as ascertained for a wire gauge, and multiply the sum by the tensile resistance of the metal, and divide the product by the diameter of the flue in inches.

EXAMPLE.—The diameter of the shell of a wrought iron boiler, single rivetted, is 5 feet, and the thickness of the metal is '28 in. What is the ultimate resistance to a bursting pressure?

'28 + 28 x 55000 = 30800, and $\frac{30800}{60} = 513'33\text{lbs.}$, which x '5 for reduction of resistance of the plates for single riveting = 256'67 lbs.

NOTE.—From the results given in the tables, and deduced from the rules, such allowances for the resistances and wear of the plates, oxidation, &c., are to be made as the character of the metal, the nature of the service, and the circumstance of using fresh or salt water, &c., will render necessary.

In plates single rivetted, it is customary in practice to estimate the tensile resistance of the metal at one-fifth of its ultimate resistance; and when they are double rivetted, at one-fourth of it.

COMPARISON BETWEEN THE RESISTANCE TO EXTERNAL AND INTERNAL PRESSURE IN WROUGHT IRON SINGLE RIVETTED FLUES OF DIFFERENT DIAMETERS AND LENGTHS.

Diameter.	Thickness.	Length.	External Pressure per sq. in.	Internal Pressure per sq. in.	Ratio.
in.	in.	feet.	lbs.	lbs.	
6	'15	10	205	1375	1 to 6'7
12	'2	15	163	917	1 to 5'6
18	'25	20	135	764	1 to 5'6

"GREAT EASTERN" STEAM SHIP.

We have been favoured with the following letter relating to the performance of the *Great Eastern*, together with the log, during her voyage to New York:—

S.S. "GREAT EASTERN," At Sea, May 10, 1861.

We are 180 miles from New York, and we expect to get in at 10 a.m. to-morrow. I am happy to inform you that everything has gone on well; we have had no stoppages since we left, but we have had a run of very unfavourable weather; on the fourth day we got into a gale, and we have

ABSTRACT OF ENGINEER'S LOG OF THE "GREAT EASTERN"—SECOND VOYAGE TO NEW YORK, MAY, 1861.

Date of each Day, ending at Noon.	PADDLE ENGINES.				SCREW ENGINES.				Total quantity of Coals used each Day.	Number of Knots run by the Paddle Engines.	Number of Knots run by the Screw Engines.	Distance run by the Ship in Knots.	REMARKS, &c.
	Revolutions of Engines each Day.	Average Revolutions per minute.	Average Pressure of Steam in Engine Room.	Tons of Coals used each Day.	Revolutions of Engines each Day.	Average Revolutions per minute.	Average Pressure of Steam in Engine Room.	Tons of Coals used each Day.					
Thursday, May 2	8,716	9'	21	89'00	34,930	36'5	17 $\frac{3}{4}$	159	248	213	236	208	At 9 P.M. Pilot left; at 9.15 full speed.
Friday ,, 3	13,887	9'5	21	126	54,095	37'5	17 $\frac{1}{2}$	169	295	366'1	390	332	Light winds; Sea smooth.
Saturday ,, 4	13,986	9'5	21	122'10	54,305	37'	17	159'10	282	367	393	342	Beam wind; Ship rolling.
Sunday ,, 5	14,188	9'65	22 $\frac{1}{2}$	116'10	54,990	37'4	17 $\frac{3}{4}$	162'10	279	370'2	388	335	Strong beam wind; Ship rolling heavily
Monday ,, 6	14,165	9'61	21	113	54,969	37'57	17	160	273	367	391	340	Strong beam wind; Ship rolling heavily.
Tuesday ,, 7	11,013	7'53	21	103	50,941	35'	16 $\frac{3}{4}$	143	246	291	366	215	Strong S.W. gale; half-speed 4 $\frac{1}{2}$ hours.
Wednesday ,, 8	14,113	9'7	21	113	53,169	36'5	16 $\frac{1}{2}$	155	268	373	382	325	Dense fog; Ship rolling heavily.
Thursday ,, 9	14,075	9'54	22	119'10	56,776	38'46	18	157'10	277	368	398	350	Dense fog; standing by Engines 10 hours.
Friday ,, 10	14,175	9'81	22	118	56,295	38'9	18 $\frac{1}{2}$	154	272	377	404	300	Eng. stop'd to take soundings; standing by 6 $\frac{1}{2}$ hours.
Saturday ,, 11	14,653	10'35	22	124	54,806	38'88	19	153	277	385	394	270	At 11.30 A.M. arrived at Light Ship.
Total.....	133,000	9'48	21 $\frac{1}{2}$	1144'10	525,276	37'44	17 $\frac{3}{4}$	1572'10	2717	3477'4	3742	3017	

Density of Water in Boilers, 1 $\frac{1}{2}$; Vacuum in Paddle Engines, 25 $\frac{1}{2}$; ditto in Screw, 26. The Injectors working well. Extreme Diameter of Paddle Wheel, 53ft. Effective Diameter of Wheel, 51ft. = 160'22ft. each Revolution. Screw, 44ft. Pitch. Immersion, leaving Milford Haven, forward, 23ft. 9 $\frac{1}{2}$ in.; aft, 26ft. 4in. No perceptible wear on Screw Shaft Bearing.

had thick fogs since. Enclosed is an abstract of our log. We have not got the revolutions out of the paddle engines that I expected. I regret we did not reef the floats two feet before we left; they are the same diameter we came home with, viz., 50ft. to centre of floats. There is no perceptible wear on the screw shaft hearing, and the injectors are working well. We will not require any repairs at New York, and are quite ready to return when wanted. We have made the passage in 1½ days less time than the last voyage, and, considering how little was done to the machinery while at Milford, and the weather we have had to contend with, I feel confident we may make a passages in 8 days. We have not tried to save coal, for we have a great number of men who never were in a ship before, and they are only getting into the system of firing; now they will turn out to be good men if we can keep them together. Captain Thompson is in full command. Captain Carnegie is a passenger.

I have not been able to obtain a card, but will send you one from each cylinder on our homeward passage.

X.

POWER REQUIRED TO OVERCOME THE RESISTANCE OF THE FEED PUMPS OF THE U.S. STEAM FRIGATE "POWHATAN."*

By WM. H. SHOCK, CHIEF ENGINEER, U.S. NAVY.

(Illustrated by a Sheet of Diagrams.)

I was anxious to ascertain with some degree of certainty the amount of power required to overcome the resistance of the feed pumps of the *Powhatan*, and, as preliminary to that investigation, the annexed plate of diagrams was taken under different conditions of the check valves on the boilers, as follows:—

Check valves wide open.
" at usual working point.
" close shut.

I deemed these three points sufficient for the investigation, thinking that any deviation from them in practice would not materially modify the result. In this I was correct, as will be seen upon examination of the diagrams, and the tabulated H.P. deduced therefrom.

The average pressure of steam, revolutions, &c., were taken from the daily engine diagrams, and were as follows:—

Steam per gauge	11½
Revolutions per minute	9·3
Vacuum	25 in.
Hot-well	120°

DIMENSIONS OF PUMPS, ETC.

Diameter of pumps	8 in.
Stroke of pumps	42 in.
Diameter (internal) of feed pipes	4¼
Weight on safety feed valve	294 lb.
Pressure per square inch on safety feed valve	20·7 lb.

From diagrams 1, 2, 3, &c., Plate 195, it is found that the power necessary to overcome resistance of feed pumps was as follows:†

No. 1 = 1·12 horse power	} Check valves at their working lift.
No. 2 = 1·19 "	
No. 3 = 1·58 "	
No. 4 = 1·48 "	
No. 5 = 1·73 "	
No. 6 = 1·54 "	

Mean ... 1·44

As the investigation was to ascertain more particularly the power absorbed by the pumps under their normal working condition, we shall use those diagrams only which were taken at that time, and assume their mean resistance to be the measure of power absorbed by each pump, as follows:—

No. 3 = 1·58 H.P.
No. 4 = 1·48 "
C = 1·52 "
D = 1·70 "

Mean ... 1·57

and $1·57 \times 4 = 6·28$ H.P. as the total resistance of the four pumps. The engines at the time were developing 527·58 H.P., 6·28 or 1·19 per cent. of which was being absorbed by the feed pumps.

Diagrams A, B, C, &c., were taken under nearly the same conditions of steam, revolutions, &c.

The following tabulated statement shows the pump resistance, as determined by each diagram on that day:—

A = 1·23 horse power	} Check valves at their usual working lift.
B = 1·26 "	
C = 1·52 "	
D = 1·70 "	
E = 1·58 "	
F = 1·91 "	
Mean...1·53	

When the plate of diagrams, A, B, C, &c., was taken, the engines were developing 600 horse power, 1·045 per cent. of which was exhausted in overcoming the resistance of the pumps.

UPON THE PRACTICAL RELATIVE ECONOMY OF USING STEAM WITH DIFFERENT MEASURES OF EXPANSION.

By ALBAN C. STIMERS, CHIEF ENGINEER, U.S. NAVY.

(From the Journal of the Franklin Institute.)

The most simple and obvious mode of using steam to obtain power in a steam engine is to permit it to flow freely from the boiler into the cylinder during the entire stroke of the piston; and this was the plan adopted in the earliest engines.

The ingenious and philosophical mind of Watt, however, upon the announcement by Mariotte that the volume of the fixed gases, when maintained at a constant temperature and unaffected by the greater or less proximity of their molecules, was inversely as their pressure, or, conversely, that the pressure was inversely as their volume, soon made the application to steam; and, assuming this law and this application of it to be correct, it is easily shown that great gains in economical effect are produced by suppressing the flow of steam into the cylinder before the piston has completed its stroke, and permitting it to expand during the remainder. This was done by Watt, and apparatus for effecting this suppression at any desired point in the stroke, forms one of his many patents; but, notwithstanding the fact that both his mechanism and his patent covered the whole ground of the expansion question, that is, enabled him to cut off at any point in the stroke, his engines, which were generally paid for by a portion of the fuel he saved over that used by those displaced, were arranged after a few trials for suppressing the steam at about three-fourths the stroke of the piston.

Any one familiar with Watt's history must have observed how uniformly he put every important conception tending to improve the steam engine to the test of a practical experiment; and though we have no account of an especial set of experiments having been tried by him to test the exact value of the expansion principle there is but little doubt that his very accurate practice would soon determine whether the practical result was equal to the theoretical prediction, and that, when he found it was not, he determined by a complete set of experiments the most favourable degree of expansion and its actual value in the practical steam engine.

The fact that he published no accounts of such experiments is no proof against their having been made, as he had every incentive, as a business man, to permit his rivals to follow the natural proneness of mankind for settling all such questions by mathematical demonstration rather than by carefully conducted experiments, which require time, money, ingenuity, patience, and a much greater knowledge of the physical laws for drawing correct inferences from the experimental data than is needed, in any calculation where the data are all assumed; having ascertained to his own satisfaction that all such calculations, based upon his own invention, the indicator diagram, would lead them to adopt a more unfavourable degree of expansion than had been decided upon for him by his experiments, thus causing them to produce engines inferior to his own.

The steam engine establishment of Boulton and Watt is still in existence, having descended from father to son during eighty-six years, and the general practice of the present firm with regard to this question is the same to-day that it was sixty years ago. It cannot be considered as at all strange that the practice of so successful and celebrated an establishment should be imitated as closely as possible by a large majority of steam engine builders as soon as the expiration of their patents destroyed their monopoly; and this we find to have been the case in fact, even in our own country. The swift and powerful steamers upon the Hudson, in their palmiest days, only differed materially from the practice of the above establishment by using a higher pressure, the steam being cut off almost uniformly at five eighths of the stroke of the piston. The same degree of expansion is also used in the engines of the steamers upon the Mississippi and its tributaries.

It is true that in river boats the greater dimensions and consequent weight of the larger engines required to use the steam very expansively may be a much greater objection than it is in most of the applications of steam power, and that, consequently, the fact of the lesser degree of ex

* From the Journal of the Franklin Institute.

† It will be observed that the frictional resistance of the pump plungers is not an element in the above calculations; not because it was of no importance, but simply from the fact that it was impossible to arrive at a correct estimate of its value. In properly managed pumps, however, loss from this source would be comparatively small.

pansion being used in them, is not in itself a proof of its greater economy; but an examination of the subject will prove that the advantages of obtaining great power with small engines are not, in either of these instances, at the expense of economy in fuel.

Until quite recently, it was the exception and not the rule to find new engines cutting off at less than half the stroke of the piston, and even now it is doubtful if a majority of all the steam engines in existence are arranged for expanding the steam as much as twice. The impression, therefore, which appears to be quite general, that any experiments which prove that the law of Mariotte cannot be applied to the practical steam engine to determine its economy when the steam is being expanded several times, and contrary to the experience of the whole engineering profession ever since its birth, is a very mistaken one. The indefatigable persistence, however, of the patentees of adjustable cut-offs, who wish to "sell rights," together with the remarkable coincidence which exists between the indicator diagram as formed by an engine when expanding the steam several times, and that called for by the simple application of the law of Mariotte, have exerted of late years a powerful influence in causing engines to be built with the design of permitting the steam to be expanded a great number of times.

The apparent success of some of the extreme applications lately made of this principle was rapidly causing a great revolution in the practice of the profession; so much so, that when Chief Engineer Isherwood, of the United States Navy, had the practical sagacity to perceive that the actual economy of any engine in which the steam was greatly expanded was not nearly equal to what it should have attained if there had been no drawbacks to the application of the theory, and proceeded to publish a book, giving, among other things, an account of experiments he had made to test the question, and explaining their rationale, it was met with severe criticism from nearly every quarter. He was looked upon as a man who was endeavouring to thrust the steam engine back into darkness from which it was just emerging. By no one was this view taken more strongly than by the present writer, who shared the general feeling that the experiments detailed in the book were not of a character to justify its author in what appeared to be such radical conclusions, overthrowing, at one fell stroke, all our preconceived ideas respecting the power of the indicator diagram to determine the amount of steam which had entered the cylinder.

After the issue of the above book, and during the year 1860, Mr. Isherwood was almost constantly engaged, under orders from the Navy Department, in experiments showing the relative economy of using steam with different manners of expansion. Such of the results of these as became known to the public, were so different from what would have been predicted by what had become to be regarded as established theories, that a memorial was addressed by a large number of steam engine manufacturers and others to the Secretary of the Navy, praying him to cause a complete set of experiments to be tried with the engines of some of our national vessels by a Board of Naval Engineers. This was granted, and a Board, consisting of Chief Engineers B. F. Isherwood, Theodore Zeller, Robert H. Long, and Alban C. Stimers, was ordered to convene on board the U. S. steamer *Michigan*, at Erie, Penna, on the 19th of November, 1860.

When the writer joined this board, he had very little doubt about the result. He had been taught in his engineering education to consider the indicator diagram as an exponent of economy of the engine which formed it, whatever the degree of expansion, and although he had experienced some unaccountable deficiencies in the evaporative powers of boilers attached to engines using large measures of expansion, he had never suspected that the difficulty lay in the engines and not in the boilers or the coal. And as an experiment was not in itself an argument upon this side or that of any question, but the true determination of the real facts, he believed that these would prove to be, that decided benefits were obtained by expanding the steam as many as three times at least in that kind of engines, namely, unjacketed cylinders using saturated steam, and without regard to the opinions or expectations of the others, he satisfied himself thoroughly of the propriety of every preparation made before commencing the experiments, and watched narrowly their whole conduct afterward, being determined that whatever they would be to people in general, to him they should prove the *experimentum crucis*, as far as these engines were capable of determining the question. This they have done, and they prove to his entire satisfaction that it is utterly futile to attempt to realize any benefit by expanding the steam beyond one and a-half times, under the conditions above described.

The following description of the machinery, of the manner of making the experiments, of obtaining the data, and of calculating the results, together with the reasons for the same, and the reductions formed, may be considered as condensed from the report of the board, which being very minute and circumstantial, is too long for a magazine article.

The selection by the Navy Department of the machinery of the U. S. Steamer *Michigan* for making these experiments was determined by its appropriateness and convenience; the engines being of the medium size

used for marine purposes and the vessel out of commission; the former had just been thoroughly repaired and furnished with new boilers.

Description of the Boilers.—The boilers are two in number, placed side by side, six inches apart, with one smoke-pipe in common at the front end. They are of the type known as *Martin's Patent*, but with proportions somewhat different from those adopted by the patentee; these were designed by Samuel Archbold, Esq., the Engineer in Chief of the Navy, for the purpose of burning to the greatest advantage the highly gaseous coal found on the boarders of Lake Erie, in Pennsylvania, and Ohio, and universally used by the steamers on the lakes, to the waters of which the cruising of the *Michigan* is confined.

These peculiarities are:

1. The greater length of the tube-box, which is about one and a half times more than the patentee employs.

2. The greater width in the clear between the tubes crosswise the furnaces, which is about two and a-half times that which the patentee employs.

3. The greater calorimeter for draft between the tubes, which is double the patentee's proportion, while the area of the smoke-pipe, instead of being equal to this calorimeter, is only about half of it.

4. The employment of a much larger combustion chamber between the furnace and the tubes than the patentee adopts.

5. The furnishing a copious supply of air, not only to the furnaces through perforations in the doors, but to the bottom of the combustion chambers, through perforations in the lower part of the bridge-wall.

The whole of the boilers and steam chimney are well covered with felt. The heating surface given below is calculated for every part with which the heated gases come in contact—top, sides, and bottom—and for the external circumference of the tubes.

The following are their principal dimensions:—

Length of each boiler at the furnaces (fore and aft the vessel)	15ft. 8 in.
Length of each boiler at top of flues	16 8,,
Breadth of each boiler	9 2,,
Height of each boiler exclusive of steam chimney	9 2,,
Number of furnaces in each boiler	3
Width of each furnace	2 6,,
Length of grate bars	6
Height from bottom of ash-pit to top of grate bars at front of furnace	1 9,,
Height of crown of furnace from bottom of ash-pit at front of furnace	4
Height of crown of furnace from top of bridge-wall	1 3,,
External diameter of tubes	2,,
Length of tubes between tube sheets	1 8,,
Whole number of tubes	1504.
Total area of grate surface, in both boilers	90 sq. ft.
Total area of water-heating surface, in both boilers	2689'59
Total area of steam-heating surface in both boilers	84'71
Diameter of the smoke-pipe	4ft. 3 in.
Height of the smoke-pipe above grate surface	45
Steam space in the two boilers and steam chimney	530 cubic ft.
Weight of water in the two boilers at a temperature of 262° Fahr., measured to the height carried during the experiments	46,450 lbs.
PROPORTIONS.—Ratio of water heating to grate surface	29'884 to 1
Ratio of steam heating to grate surface	0'941 to 1.
Ratio of grate surface to least cross area between tubes	3'212 to 1.
Ratio of grate surface to area of smoke-pipe	6'344 to 1.

Description of the Engines.—The engines are two in number, condensing, direct-acting, and inclined from the keel at an angle of 23 degrees: they are placed side by side in the vessel with a passage-way $4\frac{1}{2}$ feet wide between them. They occupy in the vessel a space 15 feet wide, including the above passage between them, by 35 feet long, and a height from top of keelsons to top of main pillow blocks of $13\frac{1}{2}$ ft.

The air-pump is inclined like the cylinder, the axis of both being parallel. It is a single-acting piston-pump, with a solid piston, and one end open to the atmosphere.

The condenser is the common jet kind, situated immediately beneath the cylinder.

The cylinder steam and exhaust valves are the double poppet kind habitually used in the United States for marine paddle-wheel engines. The upper and lower valve chests are connected by a steam and an exhaust pipe, the axes of which are parallel with the axis of the cylinder.

The cylinder steam valves are made to act as expansion valves by means of a valve-gear known as a *Sickle's cut off*. As applied to these engines, the valve was tripped by its own movement when the spring came in contact with the inclined face of a fixed cam, which could be adjusted by means of a screw. By this arrangement, the point of cutting-off could be graduated from nearly the commencement up to $\frac{2}{3}$ of the stroke of the piston, and from $\frac{1}{10}$ up to $\frac{1}{2}$ of the stroke, at which point the valve seated by the eccentric movement without tripping. Between $\frac{2}{3}$ and $\frac{1}{10}$ of the stroke it was impossible to suppress the admission of the steam.

Each end of the cylinder is provided with a relief valve for the discharge of the waste water.

The steam pipe between the boilers and cross pipe to the two engines, in which is placed a throttle valve to each engine, is 25½ ft. long by 17½ ins. diameter. The cross pipe is 4½ ft. long by 15½ ins. diameter, and the steam side pipe of each cylinder is 7½ ft. long by 12½ ins. diameter, giving a total interior surface when one engine is used, for the radiation of the heat, of 156·5 square feet, and as there is a slight inclination towards the cylinder throughout the whole length of the steam pipes, any water condensed in them is passed through the cylinder.

The steam pipes, side pipes, and cylinders are protected with a thick coat of felt covered with wooden lagging. The heads of the cylinders, the valve chests, and cylinder nozzles have no covering.

The lower head of each cylinder is double, the upper one is single.

Diameter of cylinder	36 in.
Stroke of piston	8 ft.
Diameter of piston rod	3½ "
Mean area of piston, exclusive of rod	1012·278 sq. in.
Space displacement of piston per stroke, exclusive of rod	56·544 cub. ft.
Steam space comprised in the clearance and nozzle	3·280 "
Net area of opening through steam valve, exclusive of stem, &c.	114·96 sq. in.
Net area of opening through exhaust valve, exclusive of stem, &c.	108·38 "
Diameter of air pump	29 in.
Stroke of air-pump piston	31½ "
Space displacement of air-pump piston per stroke	12 cub. ft.
Diameter of feed pump and of bilge pump	5½ in.
Stroke of piston of pump and of bilge pump	31½ "
Capacity of one condenser	20 cubic ft.
Capacity of hot-well	27 "
Length of connecting rod	16 ft. 5 in.

PADDLE WHEELS.—The arms, rims, and braces of the paddle-wheel are of iron; the paddles are of wood, 1½ inches thick, chamfered at the edges. Each paddle is divided in its breadth.

Diameter to outside of paddles	21 ft. 6 in.
Number of paddles in each wheel	16
Breadth of outer fraction of paddle	1 ft. 2 in.
Breadth of inner fraction of paddle	1 " 5
Length of paddles	8 "
Immersion of the lower edge of paddle	2 " 8

NOTE.—The above is the normal surface and dip, but during the experiments these greatly varied, different numbers of buckets being removed for different experiments, and sometimes several getting broken by the ice during the same experiment. The vessel, too, was so near the ground, that, as the water ebbed and flowed by the influence of the winds, it was sometimes afloat and sometimes aground, varying the dip according to the extent of the fall of the water: the experiments being made with the vessel lashed to the wharf in the harbour of Erie.

(To be continued.)

CORRESPONDENCE.

We do not hold ourselves responsible for the opinions of our Correspondents

STRENGTH OF BOILERS.

To the Editor of THE ARTIZAN.

SIR,—As I have already taken up a great deal of your valuable space, I should not have troubled you any more, but as the letter from your correspondent, "F. C.," requires an answer, I ask the favour of the insertion of this. In the May number, "F. C." says that I have, in the case mentioned, used 12,150 lbs. as the breaking weight for a wrought iron bar 1 in. square and a foot between the fixed ends, instead of 6015 lbs. If "F. C." will refer to any of the treatises on the Strength of Materials, he will find that, if we consider a beam fixed at one end, and loaded at the other, as unity, a beam supported at both ends and loaded in the middle will support four times the weight of the first one; and a beam firmly fixed at both ends and loaded uniformly will support twelve times the weight of the first one, or three times the weight of the second one.

Now, as steam pressure against the sides of a boiler certainly must be considered as a weight uniformly distributed, and as 4050 lbs. is the breaking weight of a beam 1 in. square and 1 ft. long, between supports loaded in the middle, it consequently follows that (4050 lbs. × 3 =) 12,150 lbs. is the breaking weight for a beam firmly fixed at both ends, and uniformly loaded.

The last being the very point "F. C." has entirely overlooked, I hope he will agree with me upon perusing this.

I remain, sir, yours,

A BOILER MAKER.

STEAMSHIP PERFORMANCE.

SIR,—I concur in the views expressed in Mr. Atherton's letter in THE ARTIZAN of this month, as to making public the results in practice of the

formula by which the performance of steamships may be estimated beforehand. This, as you know, has been from the first one of the objects of the "Steamship Performance" Committee of the British Association.

The two reports of that Committee comprise particulars of a great variety of vessels, both of screw and paddle power, with their performance under different conditions. I trust that the British Association at its next meeting will be presented with something to show the use that may be made of such materials, collected with much labour and at some cost. But Mr. Atherton goes further, and suggests that the factors applied by Watt to the formula used by him for sectional resistance would be useful for comparison with similar factors for ships of the present day. In this I also concur. But who are they who possess such factors? Are they not gentlemen engaged in ship or engine building, and to whom such factors, as part of their stock-in-trade, are too valuable to be made public for rivals to take advantage of?

In the successive Papers I have laid before the British Association are results of calculations based on the fundamental law which is clearly explained in Mr. Scott Russell's lecture at the Meeting of the Institution of Naval Architects, on March 1st, 1860. This law, in its application to the resistance due to a plane surface moving rectangularly through water at any velocity, is expressed by the formula

$$R = \frac{a}{w} \cdot \frac{V^2}{2g}$$

It requires some modification when used as the basis of calculation of the resistance due to the section of a ship under any given conditions, and still further modification when the resistance due to the section is to be reduced to that due to the form of the ship. The modifications required are dependent on the following conditions:—

1. The weight of the fluid in which the ship floats.
2. Its being still or disturbed.
3. The resistance due to the air.

4. The ratio of the increment of speed; that is, whether under the actual conditions, R varies as V^{1·7} or V^{2·28}. Factors are therefore required to represent these conditions.

It has been part of the amusement, or business if you like, of my life, to collect data for the modifications here indicated. I conclude that the heads of the department of the Controller of the Navy must have vast stores of such data. They are incomparably better situated than any private firm can be for procuring such information; and, with such a rich mine as has been open to them since steam became a motive power to ships, it is impossible to conceive that no one has availed himself of the riches within his grasp.

When, four years ago, I commenced the series of Papers, read yearly to the British Association, I was under the belief that specific information on the points raised in issue could be poured forth from many quarters, but especially from that great national establishment, maintained at such cost, which designs, builds, equips, and employs afloat above two hundred ships and vessels with steam power, besides sailing ships.

During my professional services afloat, and particularly when in command of three ships for trial of their qualities, I could get no aid from the then Navy Board; but I received valuable assistance from Professor Inman and some of the students of the School of Naval Architecture, two of whom are still living. Such of these gentlemen as may occupy responsible situations have, no doubt, data derived from performance of ships at sea, the application of which to the requirements of the present day would be of the highest value.

It is a truth that can hardly be controverted by any scientific sea officer, that the latest built ships of war are not as fit for their work as those of Chapman, the Swede; Barallier, the Frenchman; Rule and Seppings, the Englishmen, were for what they had to do.

If the *Warrior* had been designed for a sailing ship, there would not be much to object to. As a steamer, which she must be, notwithstanding her masts and yards, she will be found to want sufficient speed, and that steadiness for rifled guns without which such cannon are less to be depended on than the smooth bore.

As a challenge to others in all fair rivalry to produce, for the public benefit, what they may know, I will describe a vessel lately built by order of the Board of which I am Chairman, intended for the conveyance of cattle and pigs between Holyhead and Dublin. *The Admiral Moorsom* (so named by a special order of the Board) was designed by Capt. Hirste, the Company's Superintendent.

It is essential in such a vessel's qualities that her motion should be steady, her roll slow and uniform; she must neither "lurch" nor "scend;" she must be able to make her passage good, however hard it may blow, and she must land her cargo in good condition, having them on board the shortest time possible. Speed, therefore, though an element of the problem, is not the highest term of the equation.

While the ship was in the Clyde, and before she was ready for trial, there were furnished to you, Sir, the following estimated results, on the supposition that the wind is light, with some ripple on the water, the

Ind. H.P. about 1200, or three times the nominal H.P.; the area of section, 243·5 sq. ft.; and displacement, 960 tons, at a mean draft of 9ft. 3in. :—

	lbs.	per cent.	lbs. per sq. in.
Specific Resistance	9900·8	34·92	5·98
Equivalent of Slip	6423·19	22·66	3·88
Resultant of absorbed Power...	12022·01	42·41	7·27
Effective Power.....	28346	99·99	17·03

By the figures given, it will be seen that the co-efficient for the power given out was estimated at ·07158 of the power exerted, and the speed at 13·78 knots.

The formula employed was that described in my paper read at Leeds in 1858, and again in my letter in THE ARTIZAN of November last, viz. :—

$$R = \frac{S \cdot V^2}{3219}$$

the divisor being a corrected factor for the first and third of the conditions before enumerated. But this, being sectional resistance, requires the corrective of other co-efficients for form and for disturbed water with its corresponding wind. The maximum of these factors or co-efficients is ·07012, and the minimum, ·064. The "specific resistance" in the calculation given (9900·8) is the mean answering to the assumed conditions. The "equivalent of slip" (6423·19) was determined by comparing the "plane of resistance" (Chapman) of about 18 sq. ft., with the resultant thrust of the paddles which must balance it. This would be effected by a speed of 23 revolutions, or about 1806 feet per minute for the effective diameter of 25 feet.

The "resultant of absorbed power" is composed of the moving friction of the machinery, and the additional friction thrown on it by the load, the latter of which elements has not yet been subjected to such experiments as would determine its relation to the other constituents of the total resistance. I must, therefore, give it as empirical, and resting on my own experience only.

It is true that application has been made to such cases as this of Morin's experiments on friction under other conditions; but such application is but a guess, and I know of no specific experiments with vessels with Paddle wheels.

This double friction is estimated at 12022·01 lbs., in terms of the total resistance, 28346.

A series of trials in Holyhead Bay, between the Clipera Buoy and the Breakwater, on the 3rd January, the wind easterly and light, and the water smooth, gave the following results :—

Speed	14·67 knots.
Indicated horse power	1104
Slip of wheel	13·93 per cent.
Area of section	252·9 square feet.
Displacement	1021 tons.
Draft of water.....	9ft. 8·75in.

These results show greater speed, with less power, at a deeper draft, with larger section and displacement, but under more favourable conditions as to wind and sea than had been estimated.

The next trial was made on the 7th January from Holyhead to Kings-town, with the following results :—

Speed	13·14 knots.
Indicated horse power	1068·46
Slip of wheel	21·21 per cent.
Area of section	253·5 square feet.
Displacement	1025 tons.
Draft of water	9ft. 9in.

The conditions of wind and sea on this occasion were, as nearly as may be, such as were assumed in the estimate.

The particulars of performance of this vessel in her regular work will appear in the returns to be presented to the British Association. I will add such particulars to those already given as will enable any one to make what calculations he may think most suitable to test her qualities.

I prefer the analysis I have described of the three constituent elements to the comparison usually adopted by the formulæ—

$$K = \frac{S \cdot V^3}{P}$$

$$K = \frac{D^{\frac{3}{2}} \cdot V^3}{P}$$

The "equivalent of slip" may be subdivided into two parts, as also the "resultant of absorbed power," as I have done in the cases *Marlborough, Renown, Niagara, &c.*, in the paper read to the British Association at Oxford last year.

I trust the invitation I have given may induce some gentleman to show the public by what methods the qualities of the Queen's ships are estimated beforehand and tested afterwards; how, for instance, the table was prepared which appears in the Report of the Royal Commissioners' Appendix, p. 533, where the estimated and actual load draft and speed of twenty-nine of her Majesty's ships are given.

The discrepancies in this table are such that it is impossible to suppose the conditions of "estimated" and "actual" to have been similar, without which comparison is of no value as a test of the method of calculation.

I conclude by suggesting to the great authorities of the ship-building department of the Admiralty that this "pig-boat" may perhaps present characteristics of rolling motion that will show her type to be more suitable for rifled cannon than the ships of war now building will prove to be.

I would further suggest whether the attempt to unite a sailing ship and a steamer is compatible with obtaining the best qualities of each.

I am, sir, yours truly,

C. R. MOORSOM.

Euston Station, May 21st, 1861.

PARTICULARS OF THE "ADMIRAL MOORSOM."

	While in the Clyde, Nov. 1860.	3rd Jan. 1861.	7th Jan. 1861.
Length on water line	220 feet
Breadth	30 feet
Draft (for. 8ft. 6in., aft 10ft.)	9ft. 3in.	9ft. 8½in.	9ft. 9in.
Area of section	243·5 sq. ft.	252·9 sq. ft.	253·5 sq. ft.
Displacement	960 tons	1021 tons.	1025 tons
Diameter of cylinder	73 inches.
Stroke	6 feet
Diameter of wheel	26ft. 9in.
Effective	25 feet	about the same	about the same
Number of floats	20
Width	8ft. 8in.
Depth	2ft. 2in.
Immersion of upper edge.....	9 inches	1ft. 2½in.	1ft. 3in.
Estimated revolutions.....	23	actual 22	actual 21½
Estimated horse power	1200	1104·01	1068·46
Speed (knots)	13·78	14·67	13·14
Slip per cent.	22·66	13·93	21·21

Since the letter was corrected in proof by the Admiral, on the 25th ult., we have received the melancholy intelligence of his death on Sunday, the 26th, a loss which will be greatly felt, not only by the members of his family and all his friends, to whom he was greatly endeared, but also in the scientific world, as well as the great railway and other commercial interests with which he had identified himself. The announcement of his death will be received with the greatest possible regret.

ENGLISH AND AMERICAN INVENTIONS.

To the Editor of THE ARTIZAN.

SIR,—I beg to offer the following remarks with regard to the article signed "Traveller," in the April number of your journal.—In establishing a comparison between the Girascope governor and Silver's four ball marine governor, the writer draws a faithful picture of its construction, mode of working and advantages, but erroneously attributes it to an English inventor, whereas it is the invention of Mr. T. Silver, an American, who, after having perfected it in the United States, imported it into England, where it was speedily adopted by some of the most extensive marine engine builders. To prevent any further confusion on this subject, it is as well to state that the father of the late Mr. Brunel also invented and patented, as far back as 1822, a four ball governor ostensibly to remedy the defects of the original governor when applied to navigation; he, however, in practice failed completely to overcome the difficulties he had to contend with, and the son frankly admitted to Mr. Silver himself the defects of his own governor, and the merits of his (Mr. Silver's).

And with reference to the other governor described by the writer as applied to the engines of the *Australasian*, from his description of the instrument, coupled with the fact that the Cunard line is having it applied to

their steamers, I must also beg to claim the paternity of the invention for the same Mr. T. Silver. This instrument is known as his balance wheel governor, which although of more recent creation than his four ball governor, has already received extensive application for ocean navigation.

I remain, sir, yours truly,
D. H. B.

STEAM, &c.

The conclusion of the extracts from Mr. D. K. Clark's papers, originally published in the *Encyclopædia Britannica*, upon the above subject, together with some concluding observations thereon, and editorial remarks relating thereto, will, if possible, be given in our next; and we also hope shortly to be able to give some illustrations and further extracts from the *Encyclopædia Britannica*.

ON THE DETERMINATION OF DISTANCES ON THE FIELD.

By LIEUT.-COL. H. CLERK, R.A., F.R.S.

We are compelled to defer until next month presenting our readers with the textual description of the Plate illustrating Col. Clerk's valuable paper, as we have been unable to complete some further illustrations now being engraved.

REVIEWS AND NOTICES OF NEW BOOKS.

Portefeuille économique des Machines de l'Outillage et du Material, &c. Dirigé par C. A. Oppermann, Ingenieur-Constructeur. Paris: DUNOD, Quai des Augustins. London: J. Weale, High Holborn.

This very useful publication continues to flourish and extend in usefulness; the subjects of which it treats in the current number are well selected. The four plate illustrations given with the present number are to a large scale, and contain the dimensions of almost every part of the machines represented therein, and described in the textual portion of the work.

One of the chief features of interest connected with the present work is, that the wrapper is devoted to the publication of the prices of numerous machines, apparatus and things principally mechanical, and the prices current of metals and materials, and a vast amount of information of a kindred nature, in addition to some exceedingly useful tables of scientific, commercial, and general interest.

A Treatise on the Steam Engine, &c. By JOHN BOURNE, C.E. Being the Fifth Edition of a Treatise on the Steam Engine. "By the Artizan Club." Longman & Co. 1861.

We hail with considerable pleasure the appearance of the new edition of the "Artizan" treatise on the steam engine, by John Bourne; but on account of its having been received too late to enable us to do justice to it this month, we must defer the notice until our next number; although, in cursorily glancing over the pages of the work, we perceive a vast number of improvements have been introduced in the present edition, and the most recent examples of modern steam engineering are described textually, and illustrated with plate engravings and woodcuts. The present edition is illustrated by thirty-seven copper-plate engravings, and five hundred and forty-six wood cuts.

The Theory and Practice of Ship Building. By ANDREW MURRAY, M. Inst., C.E. &c. And, *On Steam Ships.* By ROBERT MURRAY, C.E., Engineer-Surveyor to the Board of Trade. Edinburgh: Adam and Charles Black. 1861.

This volume is made up of two very interesting papers, recently published in the *Encyclopædia Britannica*, and they are admirably illustrated with numerous plates and woodcuts. The Messrs. Murray have devoted considerable attention to their respective papers, and have brought together a vast amount of useful information, which they have done great service by re-publishing in the present form, and which we trust is in price brought within the means of those to whom it may prove of considerable utility as a work of reference, combining as it does a vast amount of popular and historical knowledge with a great deal of useful practical matter, and well tabulated information.

Pocket-book of Mechanics and Engineering; containing a Memorandum of Facts and a combination of Practice with Theory. By JOHN W. NYSTROM.

We have just received, and too late to enable us to give an extended notice of, the edition for 1861 of Mr. Nystrom's very useful pocket-book—indeed, we do not know of any pocket-book containing as great an amount of really useful information for practical men. The present edition has fewer faults than were to be found in the previous issues, but we must reserve until the next month our analysis of its contents, merely confining ourselves upon the present occasion to recommending this pocket-book as the best and cheapest work of the kind for practical mechanics and others, by whom we trust it will be appreciated.

NOTICES TO CORRESPONDENTS.

J. M.—Your communication has been received, but we do not quite understand its purport; if you have any practical remarks to make upon the subject to which you refer we shall be very happy to give them place in our columns.

J. B. J.—Apply to the engineer of the Canadian Mail Company, at Liverpool, or to the Secretary of the Pacific Mail Steam Ship Company, if you do not know anything of the officers of other Steam Companies, take the Liverpool Directory.

JAMES BRUCE.—Apply to Schiele & Co., Manchester. There is a very good maker of fans in Great Guildford-street, Southwark. We would suggest to you the use of the portable furnaces as being better than the dry air. If you choose to enter upon the question fully and in a scientific manner, we will give space to your communication.

J. R. (Manchester).—Thanks. We know the gentleman referred to, and also his inventions. He deserves success. We give the log of the *Great Eastern* in the present number. Always glad to hear from you.

G. (Liverpool).—The promised paper not yet received. The Secretary had your letter. J. J. W.—Further in our next.

W. C.—Many thanks for your politeness and shall be glad to hear from you further.

R. B.—Sorry that the length of your communication precluded the possibility of giving it *in extenso*, whilst for us to reduce its proportions would occupy too much time, and with the probability of the curtailment being injurious.

G. E. B.—Your letter was unavoidably overlooked. The most recent investigations upon the collapse of tubes, flues, &c., are by Mr. William Fairbairn, F.R.S., and we refer you to the papers published in *THE ARTIZAN*. In the present number, too, you will find in Mr. Haswell's paper that which will materially assist you. Anything further you may require upon this subject shall be sent by post on application.

J. R. (Barcelona).—We shall be glad to hear from you or Mr. B.

G. W. (Granada).—We await the promised communication.

D. C.—Mr. Whitehead is now in the Republic of Paraguay, where he is Chief Engineer to the Government.

R.—We regret we cannot inform you who are the proper parties to whom you should apply with respect to the harbour works at Valencia, but we think, if you were to write to Messrs. M. de Bergues & Co., Barcelona, they would give you the information.

S.—Apply to Messrs. A. Bost & Co., Buchanan-street, Glasgow.

J. HOWARD.—You are too old. You had better apply for a situation in a railway shop.

P. Z.—The apparatus patented by Mr. Ramsbottom, of Crewe, is in use on the Chester and Holyhead Railway between Colwyn and Conway, and answers admirably; we have seen it pick up more than 1000 gallons of water whilst the train was running at full speed.

D. C. L.—The Giffard injector is answering admirably for feeding locomotive engines; they are being gradually introduced, and Messrs. Sharp, Stewart, & Company feel that they are now perfectly justified in recommending them with every confidence for general adoption by locomotive engineers.

R.—Apply to Messrs. Saudys & Co., the telegraph engineers, Aldersgate-street. [The instruments are made by them.]

P. S. and D. T.—The only address we have is Messrs. Joveliere, Trico, Edel & Co., 52, Rue Taitbout, Paris.

T. A. L.—You had better refer to the weekly report of railway bills which have been passed; you will find them in *Herapath's Railway Journal*.

X.—The life-boats were built by Mr. John White, of Cowes, and have been found to answer every expectation.

O. D. (Faubourg de Cracovie, Warsaw).—The communication referred to has not been received. Shall be glad to hear from you.

No. 2.—We should be glad hear of the progress of the Wilna works.

RECENT LEGAL DECISIONS

AFFECTING THE ARTS, MANUFACTURES, INVENTIONS, &c.

UNDER this heading we propose giving a succinct summary of such decisions and other proceedings of the Courts of Law, during the preceding month, as may have a distinct and practical bearing on the various departments treated of in our Journal: selecting those cases only which offer some point either of novelty, or of useful application to the manufacturer, the inventor, or the usually—in the intelligence of law matters, at least—less experienced artizan. With this object in view, we shall endeavour, as much as possible, to divest our remarks of all legal technicalities, and to present the substance of those decisions to our readers in a plain, familiar, and intelligible shape.

CLAPHAM v. LANGTON.—This was an action tried at the sittings at *Nisi Prius*, before Mr. Justice Wightman, on the 15th ult. The plaintiff, who is a shipbroker at New-castle-on-Tyne, sued the defendant, who is a broker and underwriter at Liverpool, upon a policy of insurance which he had effected with the defendant upon an iron vessel named the *King Boriatinsky*. The defence was that the vessel in question was unseaworthy. It appeared that the vessel had been constructed in the year 1859, by Messrs. Mitchell & Co., at their Iron Ship Building Yard, at Newcastle-on-Tyne, according to specification. The vessel was a paddle steamer intended for river navigation, and as it was for the rivers in the Black Sea, it was constructed in a very light manner, and with a very shallow draught of water. As the vessel was approaching completion, and was warranted to sail on the 1st August, 1859, the plaintiff instructed the defendant to get the vessel insured at Liverpool. In order to prevent any dispute with the underwriters, the plaintiff instructed the defendant to have the description of the vessel inserted on the policy, and this was done as follows:—Length, 200ft.; breadth, 32, 25; draught about 3ft., tonnage, 404 tons. The vessel sailed from Newcastle on the 25th of July, 1859, and having put into Dartmouth to effect some trifling repairs to her engines, put to sea again on the 30th. It then encountered bad weather, and was obliged to return to Dartmouth, but again sailed on the 4th August. The weather was still bad, and the firemen and part of the crew failed on duty. The fact was that the plates of the vessel were only one-eighth of an inch in thickness, and, though they were plates of steel, the mariners feared to launch their frail bark on the Bay of Biscay, and the master was obliged to mend his way back and cast anchor in Plymouth Sound. He there got fresh hands, and again sailed, or rather steamed away on the 6th August, but he soon encountered a gale of wind from the S.W., and a heavy head sea from the Atlantic. The vessel laboured a good deal, and after a time it was discovered that one of the steel plates on the port side amidships was broken, and the vessel began to fill with water. An attempt was made to keep out the flood by means of the captain's blanket; but, as this was ineffectual, all sail was hoisted, and while the men worked the pumps, the vessel under steam and sail bore away for Falmouth, and arriving there in safety, was placed on a gridiron and repaired. The only question now was, whether the vessel was seaworthy for the voyage from Newcastle to Odessa, it being arranged that the amount of damage should, if necessary, be ascertained on a reference by Mr. Maude, the barrister. Several witnesses were examined on the part of the plaintiff to show that the vessel, strengthened as it had been by banks of timber, from end to end, was properly seaworthy for the voyage, and the damage done was by the perils of the sea, the perils insured against. On the part of the defendant also, evidence was given to show that, though the vessel in question might be quite fit for river navigation, for which it had been constructed, it was entirely unseaworthy for the particular voyage. The jury found that the vessel was seaworthy when she left the Tyne. A verdict was accordingly entered for the plaintiff.

NOTES AND NOVELTIES.

OUR "NOTES AND NOVELTIES" DEPARTMENT.—A SUGGESTION TO OUR READERS.

We have received many letters from correspondents, both at home and abroad, thanking us for that portion of this Journal in which, under the title of "Notes and Novelties," we present our readers with an epitome of such of the "events of the month preceding" as may in some way affect their interests, so far as their interests are connected with any of the subjects upon which this Journal treats. This epitome, in its preparation, necessitates the expenditure of much time and labour; and as we desire to make it as perfect as possible, more especially with a view of benefiting those of our engineering brethren who reside abroad, we venture to make a suggestion to our subscribers, from which, if acted upon, we shall derive considerable assistance. It is to the effect that we shall be happy to receive local news of interest from all who have the leisure to collect and forward it to us. Those who cannot afford the time to do this would greatly assist our efforts by sending us local newspapers containing articles on, or notices of, any facts connected with Railways, Telegraphs, Harbours, Docks, Canals, Bridges, Military Engineering, Marine Engineering, Shipbuilding, Boilers, Furnaces, Smoke Prevention, Chemistry as applied to the Industrial Arts, Gas and Water Works, Mining, Metallurgy, &c. To save time, all communications for this department should be addressed "19, Salisbury-street, Adelphi, London, W.C." and be forwarded, as early in the month as possible, to the Editor.

MISCELLANEOUS.

POSTAL SERVICE.—A return has lately been issued of the estimated expense of the Post-office packet service for the current year. The total amount, it appears, is estimated at £994,956, against £1,069,778 of last year, thus amounting to within £74,822 of the enormous total of the preceding twelve months. Of this sum the Cunard and Galway contracts absorb £249,349, being one quarter of the entire amount, although the Liverpool, New York, and Philadelphia Company and other steam lines of equal efficiency, would be willing to undertake the American service without any subsidy.

BIKENHEAD PENNY FERRY.—At a late monthly meeting of the Birkenhead Commissioners, it was stated that the income derived from this ferry, during the month of April, was £2606, against £2502, in the corresponding month of last year. The income for the year ending 24th of April last reached the large amount of £30,270, against £30,262 for the same period of the preceding year.

HAMELIN'S MASTIC for setting boilers is compounded as follows:—To any given weight of sand add two-thirds of that weight of powdered Bath, Portland, or other like stone, and to every 560lbs. of the mixture, add 40lbs. of litharge, 2lbs. powdered glass, 1lb. minium, and 2lb. gray oxide of lead. Pass the mixture through a sieve, and keep it in powder for use. When wanted for use, a sufficient quantity of powder is mixed with some vegetable oil in the manner of mortar, in the proportion of 605lbs. of the powder, to 5 gallons of oil, and the mixture is stirred and trodden upon until it assumes the appearance of moistened sand, when it is ready for use. This cement must be used the same day as the oil is added, as, otherwise, it will set in a solid mass.

THE ERECTION OF A NEW EXCHANGE is proposed in Liverpool. The outlay contemplated is £360,000, of which £310,000 has already been subscribed in shares. The present exchange was built in 1801, when the tonnage of the port was not more than 500,000 tons, whilst last year it amounted to full 5,000,000 tons.

THE SEA AND THE LAND.—About 50 years ago, when it was determined to erect a redoubt at Harwich, large quantities of stone were dredged up, and carried away from the neighbourhood of the harbour, a proceeding which, after a time, had the unexpected result of removing the natural barrier to the stroke of the sea, and leaving the sand and shingle to be driven along the beach, and deposited at the entrance of the harbour. Some years since, the government determined to carry out a jetty for 800 yards to stop this process, but only 500 yards were executed, and it has now become manifest, the mischief is increasing. Captain Washington reports that a large portion of Landguard east beach, including two martello towers, and a part of a graveyard, has been swept away, while Landguard point has advanced some 700 yards; and that the channel, in which there was a depth of 42ft. at low water, is now a dry beach six feet above high water, being a filling up of 80ft. perpendicular—a rate of increase unknown, he believes, in any other part of the British Isles. The extension of Landguard point, which has averaged 12 yards a year for many years, threatens to completely block up the entrance to this important harbour. Captain Washington considers that the extension of the jetty would no longer be efficacious, but he thinks a groyne, in a different spot, about 300 yards in extent, and not costing more than £10,000 to £12,000, would effect the object in view. The subject has been referred by the Lords of the Admiralty to the Treasurer for consideration.

THE METROPOLITAN BOARD OF WORKS AND THE EXHIBITION OF 1862.—At the ordinary weekly meeting held on the 17th ult., the report of the superintending architect was brought up, recommending the sanction of the board to the plans and drawings for the International Exhibition of 1862, and to allow the erection of the building under the supervision of the district surveyor, he having full authority to sanction those materials which would, under ordinary circumstances, be exceptional, and to require that all reasonable tests be employed to satisfy him as to the strength of any portion of the building so as to insure its safety for public use. Mr. Leslie moved that under the 56th section the board approve of the plans and the erection of the building. It was an exceptional one, but he did not think the board could avoid the responsibility of dealing with the question. Considerable discussion ensued as to whether the board could throw the responsibility on the district surveyor, or compel the Commissioners of the Exhibition to go to Parliament for a short bill. It was ultimately decided that they must assume the responsibility the Act placed upon them, and either sanction the building or refuse their consent. The motion was carried unanimously. The chairman said that a report had reached him that the board had delayed the Exhibition of 1862, but he wished to state that the plans had been deposited at the office on the 15th inst. last, and that to-day they had been approved. The other business was of a formal character.

"PYRONOME" TO SUPERSSEDE GUNPOWDER FOR BLASTING.—This substance has been invented by a Mr. Reynaud, who has named it pyronome. As compared with gunpowder its specific gravity is much lighter, and it produces the same effect. Its cost price is also considerably less than gunpowder, but it cannot be advantageously used for fire-arms. It is composed of nitrate of soda, 52 parts, residue of tan (after it has been used for tanning) 27.5, powdered sulphur 20.0. This product for the purpose above-named will be found far superior to gunpowder, and will doubtless be received as a boon both by miner and mine owner, and eventually come into general use. Arranged in cartridges no possible accident can happen, and besides being 15 per cent. cheaper than gunpowder, it possesses the rare quality of retaining its explosive powers after being subjected to damp or wet, simply requiring drying, and its preparation is so exceedingly easy as to be in the power of everyone to manufacture for himself.

DISCONTINUANCE OF PACKET SERVICE BETWEEN GALWAY AND AMERICA.—The following order has been issued by the Postmaster-General:—The Atlantic Royal Mail Steam Navigation Company having failed to fulfil the stipulations of their contract for the con-

voyance of mails between Galway and America, the Postmaster-General, with the approval of her Majesty's Treasury, has declared that contract at an end. All letters, &c., for Newfoundland will henceforth be forwarded *via* Halifax.

THAMES EMBANKMENT.—The total number of schemes for carrying out this embankment and railway before the Commissioners amounts to about 40, and it is stated that in the event of their recommending to Parliament the construction of an embankment between Westminster and London Bridges, they will couple with that recommendation another for the embankment of the river to a still greater extent, both above and below the bridges.

THE TWO IRON WATER WHEELS at the Catrine Works, Ayrshire, are each 50ft. in diameter, and 10ft. 6ft. wide inside the buckets. These wheels work under a fall of 48ft., and with a speed at their peripheries of 4ft. per second.

A LARGE DELIVERY OF THE ADMIRALTY SIGNAL LANTERNS, termed the "Ocean Marine Telegraph," has lately been received at Woolwich. The compactness of the apparatus—the ease, in which a complete set of lanterns is packed ready for immediate use, being only 15in. square—is a great advantage. The officials and signal-men state that, with the powerful burners of their (No. 3) pattern, signals might be transmitted intelligibly over a sea range of upwards of about twenty miles in ordinarily clear weather, and might be used with profit as day signals also, it being a readier method than that of flags, in consequence of the lanterns facilitating a much more rapid means of communication, both ashore and aboard, at short ranges, the shades forming the three great contrasts of red, white, and black.

POWELL'S STEAM CULTIVATORS are now being manufactured in France, by order of the Emperor.

STEAM SHIPPING.

CHINA AND JAPAN STEAM NAVIGATION COMPANY.—The prospectus of this company, formed for the purpose of supplying a regular, speedy, and safe communication along the extensive line of coast, and in the rivers of China, appeared a few days since. Hitherto these services have been very inadequately performed by unwieldy junks and private sailing vessels, with the addition of a few steamers owned by private firms. In order to meet the necessities of foreign and native trade, the company propose to construct a fleet of steam vessels, which will provide for the conveyance of passengers, mails, and general merchandise. The project, which has already been sanctioned by firms connected with the China trade, is brought forward under very respectable auspices, and the capital is fixed at £3,000,000, of which the first issue will comprise £150,000 in shares of £10 each, it being the intention of the directors to limit the operations of the company until experience has shown in what manner they can be best extended with advantage to the shareholders.

THE "ARCTHUSA," 51, converting from a sailing ship to a screw steamer, is ordered, when completed, to be fitted with machinery and engines of 500 horse power; and the following is to be her armament, viz., 10 guns each of 65 cwt., 22 of 56 cwt., 18 of 45 cwt., and one 68-pounder swivel gun 10ft. in length.

THE "PHAETAN," 51, screw steam frigate, 400 horse power (fitted with one of Smith's common screws, with the leading edges cut off), was taken out of Sheerness Harbour, on the 7th ult., for the purpose of testing her machinery and speed. Although both the wind and tide were against the vessel, the trial was pronounced very satisfactory, and was attended with the following results:—Draught of water forward, 18ft. 6in.; aft, 21ft. 2in.; mean revolutions, 66; vacuum, 25½; mean speed, 12 knots.

THE "CHALLENGER," 22, 400 horse power, screw steam corvette, was taken out of Sheerness on the 3rd ult., for the purpose of trying her machinery, and also to test certain appliances which had lately been introduced into the ship, with a view to its more efficient ventilation. The vessel proceeded to the Maplin Sands, and both as regards the machinery and ventilation answered remarkably well; mean speed attained, 10½ knots per hour; revolutions of engines, 56; draught of water forward, 16½; aft, 19½.

THE "LILY," Her Majesty's screw steam sloop, recently built at Millwall, having received her engines of 200 horse power at Woolwich, went down the river on the 8th ult. on her first trial trip. The Inspector of Steam Machinery on behalf of the Admiralty attended the trial, and reported most favourably on the working of the engines, and the speed of the vessel.

THE "DEFIANCE," screw liner, recently launched at Pembroke, has the following dimensions:—Length between perpendiculars, 254ft. 9in.; length of keel for tonnage, 219ft. 11½in.; breadth, extreme, 55ft. 4in.; breadth, moulded, 53ft. 8in.; depth of hold, 24ft. 6in.; burden in tons, 347½, and nominal power of her engines, 800 horses.

THE "ULSTER" AND "MUNSTER," the two new Holyhead and Kingstown steamers, have oscillating engines, with cylinders 8ft. in diameter, and 7ft. stroke. These engines work up to 4100 indicated horse power. The eight boilers of each boat have 18,400 square feet of heating surface. The engines weigh 220 tons, the boilers 230 tons, the water in the boilers 170 tons, and the paddles 110 tons, making a total weight of 730 tons for 750 nominal horse power.

THE "LORD OF THE ISLES," iron paddle-wheel steamer, intended for the station between Southampton, the Isle of Wight, and Portsmouth, had a trial, at the measured mile in Stokes Bay, on the 6th ult., where she attained a mean speed on her first two runs of 14.7 knots, and 14.18 on the other two. The *Lord of the Isles* was built by the Thames Iron Shipbuilding Company, from a design of Mr. James Ash, and her engines are of 60 nominal horse power:—Her length between perpendiculars is 130ft.; extreme breadth, 18ft.; depth, 7ft. 6in.; burden, 205 tons builders' measurement; and she only draws four feet of water.

THE "NEWCASTLE," 51, screw steam frigate, made her official trial at Sheerness on the 9th ult. Her engines are 600 nominal horse power, and worked beautifully, and showed very little variation in their revolutions. Her steering qualities are also very good. She made six runs at the measured mile, the vessel drawing 19ft. 10in. of water aft, and 15ft. 7in. forward (Griffith's screw, pitch 27, diameter 28). The average of the six runs gave a speed of 13.286 knots per hour. Revolutions of engines, 60; pressure of steam, 20; vacuum, 25. There was a total absence of hot bearings, and the machinery worked very satisfactorily.

MESSRS. NAPIER AND SONS are laying down the keel of another iron-cased war frigate, but she is to be more completely armour-cased than the *Black Prince*, lately launched and built by the same firm. This new vessel will be 250ft. in length, 66ft. breadth of beam, tons, 4080 horse power, 800; so that it will be 450 horse power, 2000 tons, 40ft. in length; and 2ft. in breadth smaller than the *Black Prince*. The price, however, is larger than the *Black Prince*, for the contract has been taken at £41 10s. per ton, the *Black Prince* being only £37. The augmentation of price arises from the new vessel being plated entirely round from below the water-line upwards. Its stem will be ram shaped, formed inwards at the top. The armour plates, like the *Black Prince*, will be 4½in. thick, and of the best quality of iron.

THE "ROYAL OAK," 91, screw steamer.—Admiralty orders were received at Chatham a few days since, ordering the above vessel to be completed as a 51-gun screw frigate, and to be clad with shot-proof iron-armour plates, similar to those used in the construction of the *Warrior* and *Achilles*, iron steamers.

INTER-COLONIAL ROYAL MAIL STEAM PACKET COMPANY.—At a meeting of shareholders held on the 17th ult., a report was read detailing the operations of the half-year. It was stated that the working account not only showed an increase in the aggregate receipts, but a material diminution of the gross expenditure as compared with the previous half-year. The net profits of the six months' working were £6679 6s. 8d., making, with the balance in hand, a total of £3310 3s. 8d., of which £4500 was appropriated for depreciation and reduction of preliminary expenses, leaving a balance of £3810 3s. 10d., out of which it was proposed to pay a dividend on the original and new shares at the rate of 7½ per

cent. for the last year. In moving the adoption of the report, the Chairman said that during the past six months the capital had been increased by £13,422, and liabilities paid off to the extent of £14,033. The balance, as compared with that on the 30th June last, showed an increase of £3200. 5000 shares yet remained unissued, and he urged the shareholders to get them taken up by their friends. It was then suggested to have more commercial men on the board, as likely to conduce to the prosperity of the company. The report was adopted, and the dividend as proposed was unanimously carried.

THE GREAT SHIP COMPANY propose to raise £35,000 in debentures having twelve months to run, at 10 per cent., to pay off existing claims. The security will be a mortgage on the vessel. If the money is not raised within a short time it is proposed to sell the ship, to meet the demands now standing over.

THE "HELICAN" 1-gun paddle despatch boat, ordered to be constructed forth with at Portsmouth, will have the following dimensions: length between perpendiculars 200ft.; length of keel for tonnage, 200ft. 1½in.; extreme breadth, 23ft. 2in.; ditto, for tonnage, 23ft.; ditto, moulded, 27ft. 2in.; depth in hold, 14 ft. 2in.; burden, tons, 834 53-94; horse power (nominal), 250. Each vessel of this class will have for her armament one of Armstrong's naval pattern 70-pounders, the gun with which it is said to be the intention of the authorities to supersede the present 100-pounders on board ship, so soon as a sufficient number have been manufactured for the purpose. It will be seen by the dimensions of the *Helican* that vessels of her class and description are destined in any future naval war to play even a more important part in relation to our steam fleets than did the fast frigate to the sailing fleets of olden times.

THE "DUNCAN" 101, screw, made her second experimental trial on the 15th ult., the propeller being a two-bladed one, with the blades of the common Admiralty form, and affixed to the boss on Messrs. Maudsley and Field's system. The vibration and lateral motion of the ship were considered greater than on her first trial.

THE TRIAL TRIP OF THE "MINOS" STEAM YACHT IN SWANSEA BAY.—The following are the particulars of the recent trial trip of the *Minos*, steam yacht, in Swansea Bay. She is fitted with Turner's Patent Metallic Surface Condenser and his other important improvements for economising fuel, and reducing the cost of steam power to a minimum. The dimensions of the engines are as follows:—

Diameter of cylinders	34in.
Length of stroke	34 "
Diameter of wheels (feathering)	14ft.
Number of cylinders (oscillating)	2
Number of boilers (cylindrical)	2
Length of boilers	14ft.
Diameter of boilers	5ft. 9in.
Fire-grate area	32ft.
Heating surface	1500ft.

Safety valves weighted to 55lbs. per square inch; the boilers are made to work safely at 150lbs. per square inch when required. Cooling or condensing surface in condenser, 500 square feet. The cylinders are surrounded with steam jackets according to patented arrangements, and fitted with cut off valves. The run lasted three hours, during which time the engines made thirty revolutions per minute; the steam was cut off at ¼th part of the stroke nearly; vacuum, 20in. The pumps, which are of the ordinary size and construction, returned the whole of the condensed fresh water to the boilers at the temperature of 180°. The water in the gauge glasses did not vary ½ of an inch whilst the trial lasted, during which time no water was taken from the sea. The consumption of fuel will not exceed 25cwt. per twelve hours, or about 2cwt. per hour. The boilers are constructed to work safely with salt water, should it be required in case of an accident. The salt water when used is always supplied through the condenser, where it is raised to the temperature of 180°. A very important feature in this condenser is that it can be used as an ordinary jet condenser; and one system can be changed for the other without stopping the engines. The expansion joints in this condenser are metallic, and will never require repacking; yet every tube is free to slide through the upper plate, according to any expansion or contraction, and this joint has been proved tight against a pressure of 100lbs. per square inch, when the difference in the expansion and contraction of the tube and outer casing of thick iron has been ¼ in., and the time occupied in this expansion, after the admission of steam, does not exceed fifteen seconds; the contraction to the same extent is much more sudden on the admission of cold water. These are facts deduced from careful experiments by the inventor of this system, and will no doubt prove interesting to many of our readers connected with this branch of engineering.

RAILWAYS.

ITALIAN RAILWAYS.—At a sitting at the House of Deputies on the 4th ult., the Minister of Public Works gave an explanation of the great railway enterprises, which are now in contemplation for the kingdom of Italy. The extent of railway lines (should these hills meet the approval of the Chamber) in operation, in course of construction, and to be given out for private speculation, will be 6133 kilometres (the kilometre to be computed two-thirds of an English mile); by adding to this the lines in operation or in course of construction in the Venetian and Pontifical States, the whole of the Italian lines will rise to 6900 kilometres. Of these the old state of Sardinia possesses the greatest extent of line, both in operation and in course of construction, and the old kingdom of Naples the least. The lines projected for Sicily, where as yet no railways exist, amount to 400 kilometres. The works under immediate contemplation will give as a result the opening of 550 kilometres of new railway lines within the present year, and 1500 more within another year. The shortest line between Turin and Ronc, along the shore by Genoa, Leghorn, and Civita Vecchia, would be 600 kilometres, a journey of 18 or 20 hours. Between Turin and Naples, the shortest route is through Bologna and Ancona, across the Abruzzi, a distance of about 800 kilometres, to be achieved in about 24 hours' journey. From Turin to Brindisi the line would extend to 900 kilometres; to Taranto, 863; to Otranto, 772; to Reggio, about 1300 kilometres. The shortest lines, however, will not in every instance be the first brought to a termination, owing to the natural difficulties which must needs retard their construction. The line from Turin to Naples, through Bologna, Ancona, Foggia, and Bari, will be about 950 kilometres in length, exceeding by 50 kilometres the line through the Abruzzi; but with the exception of the hills surrounding Ancona, and the pass of the Appennines, it runs along shore, and mostly along level ground, so that it is expected it will be greatly advanced the present year, and brought to a full termination within 1863. Most of these lines are of great importance, not only to parties travelling, but also as a means of rapid communication between distant countries. From London to Alexandria, the distance now, either through Marseilles or Genoa, is 188 hours' journey. It will be reduced to 155 hours, with an economy of 30 hours' time, as soon as the line to Ancona is opened, which is expected to take place before the end of the present year.

THE THAMES AND MEDWAY TUNNEL, originally constructed as a canal tunnel, but now used for the North Kent Railway, is the largest, as a whole, in the kingdom. It is 39ft. in extreme height, or 2ft. 6in. higher than the Box tunnel, and 12ft. 6in. higher than the Watford tunnel. It is 35ft. 6in. in extreme width, being only 6in. narrower than the Box tunnel, and 5ft. 6in. to 5ft. 6in. wider than ordinary tunnels. The length of this tunnel is 2 miles 440 yards, being 837 yards longer than the Box tunnel.

FALL OF A RAILWAY-STATION ROOF.—On the 4th ult., just after a passenger train had left the Blackburn-station, the girders forming the roof of the new station, numbering fifty to sixty, extending a length of about 100 yards, and having a span of about 100 feet, were blown down, and fell with a crash on the line, causing the greatest alarm to all in the vicinity of the station, but fortunately inflicting no personal injury.

The directors of the Ottoman Railway Company have announced an issue of £250,000

Six per Cent. Debentures, under the authority of the general meeting of the shareholders, and subsequently sanctioned by the Imperial Government. They are offered at a price which will pay 3 per cent., and holders will have the option, until November, 1865, being six months before the debenture is paid off, to convert them into the ordinary shares of the company at par. These debentures—the aggregate interest of which is £15,000 per annum—dependent of being the first charge on the entire share capital and property of the company, have also the first lien on the £72,000 per annum guarantee of the Government.

THE EXMOUTH RAILWAY WAS inspected by Colonel Holland, R.E., previous to its being opened for public traffic. The works are very heavy throughout. A viaduct over the river Clist is an important structure, which had been previously approved by the Admiralty; the iron girders were severely tested by placing two of the largest locomotive engines over each opening. The deflection was found to be but very slight. Masonry along the sea shore, where much Babbcomb stone has been used, was also carefully examined and approved.

RAILWAY ACCIDENTS.

SERIOUS RAILWAY ACCIDENT AT MANCHESTER.—On the 11th ult. an accident occurred at the Victoria Station, Manchester, which resulted in serious injury to one man, and in slight injuries to several others. The train which leaves Normanton at 6 a.m., and comes through Yorkshire, consists of eight carriages and three goods waggons, engine, and tender. The line from Miles Platting to the arch close to the station is a falling incline, and consequently, instead of steam power having to be used to draw a train from Miles Platting, the "break" has to be freely applied to keep the train in check. As the above train emerged from under the arch to enter the arrival platform, it was seen at once that it was coming too fast, and that the "break" was not answering its purpose sufficiently well. The passengers at this time were opening the doors and trying to get out, when the train ran with considerable force against the buffers and rebounded. One of the buffers was broken, the other was damaged, and the force of the concussion was such as to severely injure several of the passengers.

MILITARY ENGINEERING.

WARRY'S BREACH-LOADING RIFLED CANNON.—The superiority claimed for the invention, is the simplicity of the breech-loading action, with great facility in loading, and the rapidity with which it can be fired. The inventor of this kind of ordnance has offered to take any gun now in use in the service, which he will rifle and convert into a breech-loader at comparatively trifling expense, his object being to satisfy the Government that the whole of the field pieces and ships' guns now in use can be made available for that purpose.

MEDWAY DEFENCES.—The defences on the north side of the entrance to the Medway are to be materially strengthened. At present that portion of the river's entrance is defended only by a circular martello tower of great strength, mounting three 68-pounder guns, each of 93 cwt. The addition which it is proposed to make, however, will consist of two permanent works, on which will be mounted a powerful armament, consisting of 100-pounder long range Armstrong guns, and 68-pounder and 10-inch guns, and these in conjunction with the new line of fortifications about to be commenced on the south side of the estuary of the Medway will render the entrance to that river almost impassable to any hostile vessel.

Messrs. Westley Richards & Co. have lately completed an order from the Government for some of their breech-loading rifled muskets with Whitworth barrels. They are to be placed in the hands of a certain number of line regiments in order that a more extended trial may be given them, the Ordnance Select Committee having satisfied themselves of the value of the invention as a military weapon. These rifled muskets have an accurate range of 1200 or 1300 yards. They are the same length as the Enfield rifle, and of equal precision with the Whitworth; and, on referring to the Report of the National Rifle Association, it will be found that the three great prizes, each of 500, 900, and 1000 yards, and open to all comers of all nations, were each won by Westley Richards's breech-loaders, the guns used having been made for the Government. This firm has also large contracts on hand for breech-loading cavalry carbines, rifled on the same principle as the muskets. They are a light and handy weapon, being only 6lbs. in weight, and having an accurate range of 1000 yards. Some of these arms were sent to China for trial during the last war, and the report has been in every respect most satisfactory. The ammunition is represented as being the strongest and best adapted for military purposes of any that has been served to the troops; and, it is further added, that a miss-fire is almost unknown.

TELEGRAPHIC ENGINEERING.

THE "MALACCA" arrived at Gibraltar on the 2nd ult., with part of the cable now to be laid between Malta and Alexandria. This vessel was fitted up before her departure with huge water tanks to keep the cable cool, which they only partly accomplished; a part of the cable which was not near the tanks suffering very severely from overheating.

MALTA AND ALEXANDRIA SUBMARINE TELEGRAPH.—This line is to be laid in three sections, the first from Malta to Tripoli, and thence along the coast to Bengazi. Three dimensions of cable will be employed, one of about 2½ tons, the second of 5 tons, and the third of no less than 7 tons to the knot. These will be submerged along the coast in such wise as to keep as much as possible within a depth of 100 fathoms, so as to admit of the cable being raised to the surface for examination and repair at any point where a defect may occur. In one place, however, at the top of the Bay of Sidra, it will probably have to lie in about 300 fathoms. From Malta to Tripoli the greatest depth is 450 fathoms; but the bottom is little else but smooth sand, and this part of the line will consequently consist of the light cable. The same size will also be employed at the Alexandrian extremity.

THE NORTH ATLANTIC TELEGRAPH.—Colonel Shuffner's great project for connecting the old and the new world by a series of short submarine telegraph lines through high northern latitudes, in order to avoid the long sea route, which, practically speaking, has been found to present insurmountable difficulties, is progressing slowly but satisfactorily, and with every prospect of ultimate success. From Colonel Shuffner's project it will be seen that the longest line will be but one-fourth the length of that already attempted to be laid, thus avoiding the great difficulty of extreme length of line. According to this proposition there will be four short sections—from Scotland to the Farøes, 225 miles; from the Farøes to Iceland, 240 miles; from Iceland to Greenland, 670 miles; and from Greenland to Labrador, 510 miles = 1645 miles; and with the exception of these, the route will be entirely overland. Instead of a single cable over 2000 miles in length, the northern route admits of the longest length, allowing for slack, being reduced to less than 800 miles, and through such a cable three signals per second may confidently be relied upon. So far from the project presenting any insurmountable difficulty, the obstacles to be encountered have been so thoroughly ascertained, and are so carefully prepared for, that, comparatively speaking, the several cables will be as easily laid as were those which traversed the German Ocean.

RUSSIAN TELEGRAPH.—The extension of the electric telegraph across Siberia to the Pacific Ocean has so far progressed during the past four years, that at the commencement of 1861 the Russian Government had ordered the construction of lines extending 6000 kilometres, 2000 of them being in the country lately ceded to Russia by China, even to the most southern point of the new Russian territory on the sea of Japan. The Minister of Marine is ordered to provide the funds necessary for the construction from Kasan in Europe to Siberia. During the present year there will be opened a line of 2,000 kilometres from Kasan to Omsk in Siberia, and shortly afterwards this line will be extended 2500 kilometres further to Irkutsk. So that, within two or three years, a network of telegraph

lines will be extended from Europe on the one side to Irkoutsk in Asia, and on the other the Russian possessions on the Amoor and Ussuri will be put in communication with the principal Russian ports on the sea of Japan. Of the whole distance, estimated at 10,000 kilometres, there remains only that portion between Irkoutsk by Kiahta, as far as the town of Cabaronka, to be undertaken. But when the works now in hand have been concluded, this last line will be proceeded with immediately.

ADVICES from Malta state that, in consequence of the damaged state of the steamer, *Molacca*, having on board the Malta and Tripoli, and about half of the Tropoli and Bengazi portions of the Malta and Alexandria cable, some delay will occur in commencing the operation of laying that part of the line. The vessel was in her Majesty's dockyard at Valetta, under repairs. The cable had been tested, and, with the exception of a few knots, damaged by having been coiled under water in the dock, had been ascertained to be in perfect working order. The chief electrician employed in laying the Atlantic cable had arrived out on the part of Messrs. Glasse, Elliott, & Co.

LAUNCHES OF STEAMERS.

THE "BATTALION" iron screw steamer, was launched on the 5th ult., from the building-yard of Messrs. Palmer, Bros., at Howden. This vessel was designed by M. McClintock, of Jarro, and is 210ft. long, 28ft. broad, 17ft. deep, and coated with Day's patent cement; she will carry about 1100 tons dead weight, and will have engines of 80 nominal H.P.

THE "VOLUNTEER" a large iron screw steamer, was launched from the building yard of Messrs. S. and H. Morton on the 18th ult. This steamer, which is intended to trade between Leith and Rotterdam, is 600 tons gross register. Her engines, which are high pressure, and condensing (Marshall's patent) are 120 horse power, and she is classed A 1 at Lloyd's for 12 years.

THE "ACTIF," a beautifully modelled iron screw steamer, was launched on the 28th ult. from the building yard of Messrs. Scott & Co. of Curtsdyke. The *Actif* will be employed as a despatch boat of the Imperial Navy of France. She measures 310 tons builders' measurement, and is of the following dimensions:—Length, 134ft.; breadth, 22ft.; and depth, 12ft. She is to be fitted with Rowan's patent engines, of about 100 horse power, by the Greenock Foundry Company, and a four bladed screw propeller.

THE "LADY NYASSA," an elegant screw steam yacht, of about 110 tons O.M., built for the celebrated Dr. Livingstone, was launched, on the 15th ult., from the building yard of Messrs. Tod and Mc'Gregor, on the Clyde. The *Lady Nyassa* is to have a pair of high pressure direct-acting engines and will have the novelty of two screw propellers on separate shafts. She has been built for a light draught of water, and when ready for sea is not expected to draw more than 7ft., and as she has to be taken to the river Zambesi in pieces, she has been constructed on a new principle, and fastened with screw bolts, so as to be fitted up without riveting on reaching her destination.

DOCKS, HARBOURS, CANALS, &c.

HARBOURS OF REFUGE.—A parliamentary return just issued shows that the total estimate for works proposed for Dover is £650,000; for Alderney, £1,300,000; for Portland, £1,047,125. The votes still required to complete the works are—For Dover, £151,000; for Alderney, £363,000; and for Portland, £74,125.

HOLYHEAD HARBOUR.—Holyhead Harbour of Refuge is turning out to be rather a costly affair. The original estimate was £908,063, but various extensions of the plans have already brought up the estimates to £1,920,000, on account of which £1,680,000 had been voted by parliament from 1845 to 1860, and the sum of £65,000 is proposed to be set aside this year for the prosecution of the works, leaving £667,000 to be voted in subsequent years. The works seem very far from completion, and probably before they are pronounced finished, the national exchequer will have contributed much beyond the two millions now estimated as the "entire cost," while the harbour is by no means perfect as a place of refuge for storm-pressed shipping. But, so far as its accommodation extends, it has undeniably proved of advantage to vessels sailing to and from this port, so that grumbling at its costliness is out of place for Liverpool taxpayers, especially as the works in course of construction at Holyhead can never affect the trade which naturally centres here.

CHATHAM DOCKYARD.—The enlargement of this dockyard which the Government has determined on carrying out will involve the expenditure of nearly £1,000,000 sterling. These proposed improvements will necessitate the enclosure of a considerable tract of land on the eastern side of the dockyard, and adjacent to St. Mary's Creek and Island. On the Channel side of St. Mary's Island three large steam basins will be constructed, each connected with the other by locks. The largest of these basins will cover an area of 303 acres, with a length of 1550 feet on its least side, and a breadth of 700 feet, with a depth of 30 feet at neap tides. The basin will be connected with the river by two locks, each 500 feet in length, and will communicate with the smallest of the three basins, which will have an area of seven acres, with a length of 700 feet, and a breadth of 430 feet. The third basin will communicate with the river, the lock being opposite the powder magazine at Upnor Castle. Its area will be 22 acres, and greatest length 1550 feet, with a depth of 30 feet at neaps. Communicating with this basin will be five large docks, each capable of docking the largest line-of-battle ship in the service, three of the new docks being each 500 feet in length, and the other two somewhat smaller. Adjacent to the new basins it is intended to erect a steam factory at an expense of £180,000, exclusive of materials. This factory will include fitting and erecting shops, foundries, store-houses, and a large covered area.

SEWERAGE WORKS.

THE GREAT METROPOLITAN SEWER.—The works connected with this important undertaking in the West Ham district now extend over a great distance, and the depth of the cuttings average 14ft. to 15ft. below the surface of the high road. The works at outlet at Barking-creek will be first completed, and two tunnels will extend from that point to Stratford, forming a junction at Bow. The main sewer from Stratford-broadway to Bow-bridge is all but completed, and the remainder of the Stratford main drainage works will be completed in August.

BRIDGES.

THE PROPOSED LAMBETH BRIDGE.—This bridge, the bill for which has been passed by the Committee of the House of Lords, is to be constructed on the suspension principle, with two piers in the bed of the river, and three arches, of 280ft. span each, and with a headway 21ft. between the crown of the centre arch and Trinity high water-mark. It will be carried across the river from Church-street, Lambeth, to Market-street, Westminster, with approaches.

SPANISH RAILWAY BRIDGES.—Messrs. C. de Bergue & Co., of Manchester, are the designers and builders of the iron bridges on the Barcelona and Saragossa Railway, another portion of which has lately been opened for traffic. One bridge is erected over the river Sigre, at Lerida, in five spans of 132ft. each, with a total length of 712ft., and weighs 338 tons. The other is over the Cineu, at Mozan, and is in three spans of 200ft. each, with a total length of 630ft., and weighs 440 tons. The testing of both these bridges showed remarkable results, as proving the rigidity which may be obtained in lattice bridges. With four engines running over the latter bridge at thirty miles per hour, the deflection was only 1/8-1/16th inch, and with the same load standing in the centre the deflection was only 1/3-3/16th inch.

GAS SUPPLY.

THE PENNSYLVANIA RAILWAY COMPANY have their cars lighted with gas. This gas, which is made by the company, when received from the works is pumped into receivers under very high pressure, and by means of pipes is conducted from the stationary receivers to the cars, and there enters a receiver on each car, 7ft. 6in. high, 14ft. in diameter, and which, with a pressure of 600lbs. to 800lbs. contains sufficient to supply two 6ft. and one 3ft. burners from sixteen to eighteen hours.

BOILER EXPLOSIONS.

THE ASSOCIATION FOR THE PREVENTION OF STEAM BOILER EXPLOSIONS.—At the last ordinary monthly meeting of the Executive Committee of this Association held on Tuesday, April 30th, W. Fairbairn, C.E., F.R.S. in the chair, Mr. L. E. Fletcher, Chief Engineer, presented his monthly report, from which we have been furnished with the following extracts.—During the past month 210 visits have been made; 556 boilers, as well as 407 engines, have been examined, and the following defects discovered:—Fracture, 11; corrosion, 13 (two dangerous); safety valves out of order, 33; water gauges ditto, 15 (one dangerous); pressure gauges ditto, 10 (one dangerous); feed apparatus ditto, 3; blow-off cocks ditto, 11; fusible plugs ditto, 1; furnaces out of shape, 18; deficiency of water, 3; boilers without safety valves, 1 (dangerous); total, 124 (five dangerous); boilers without glass water gauges, 10; without pressure gauges, 2; without blow-off cocks, 32; without feed back pressure valves, 26. One boiler was found to have its safety valve placed between the stop valve and engine, instead of directly on the boiler, so that if at any time the stop valve should become closed and accidentally held fast, either by the gland or other cause, the communication between the boiler and its safety valve would be entirely cut off. Three boilers have exploded during the past month, neither of which, however, were under the inspection of this association. These accidents have been attended with loss of life, as well as serious injury to several persons, and considerable damage to property. I examined the scene of the explosion of one of these boilers, the day after the accident had occurred, and found that the ruin to the engine and boiler house, as well as to the chimney, was absolute, the bricks being scattered like grape shot, in all directions. One half of the boiler had been blown nearly one hundred yards from its bed, and the remainder torn into as many as eight pieces, which were scattered more immediately around its original position. The cause of the explosion was obvious; the plates had been so reduced in thickness by corrosion, that although originally $\frac{7}{16}$ of an inch in thickness, they had become in places literally no thicker than a shilling, and although the bursting pressure of this boiler would not have been less than 400lbs. on the square inch, had it been in good condition, it was so weakened as to explode when working with steam at somewhere about 25 or 30lbs. The dangerous condition of this boiler would at once have been apparent upon internal inspection, and none should be worked for any length of time without this, since corrosion is often in action when least suspected.

MINES, METALLURGY, &c.

A NEW ALLOY OF COPPER.—A substance resembling gold, and known as "oreide of gold," is extensively manufactured in the United States, under the licence of a French patentee; it is composed of 100 parts (by weight) of pure copper, 17 of zinc, 6 of common magnesia, 3/60 sal ammoniac, 1/80 quick lime, and nine of crude tartar. The copper is first melted in a crucible, then the magnesia added, then the sal ammoniac, lime and tartar separately, and in powder. These are kept from contact with the air, and are well stirred for about 20 minutes, until they are incorporated together. The zinc is now added in strips, which are thrust below the scum formed on the top of the crucible. The mass is now stirred, the lid put on the crucible, and the contents kept fused for about 25 minutes; after which the crucible is opened, the slug skimmed carefully off, when the molten alloy is ready for the moulds.

INDIAN AND AUSTRALIAN COALS.—Dr. Haine's reports on samples of coal from Australia, the Nerubudda Valley, and Nagpore, that the Australian coals are jet black and brilliant, very brittle, and breaks with a cubical fracture, like Newcastle coal. The Nerubudda coal is dull, black, heavy, and very hard, being pulverized with difficulty; it has a laminated structure and slaty cleavage; interspersed in its substance are seen here and there small lumps of half formed coal, like charcoal. The Nagpore coal is very similar in appearance to the Nerubudda coal, and has the same texture, except that the lamina are alternately dull and glossy. The Australian coal is bituminous, and cokes like Newcastle coal. The Nerubudda and Nagpore coals do not even unite together in coking; they would appear, therefore, to be not well suited for that operation. The ash of the Australian coal was of a dirty white colour; the table shows it to be rather abundant; that of the Nerubudda and Nagpore coals is much the same in appearance, but in very large proportion, and its abundance, by clogging the fire-bars, must detract a great deal from the utility of the coal, independently of the loss of the carbonaceous matter, whose place it occupies. The sulphur in all three specimens is in moderate proportion. The number of pounds of water raised from 80° to 212° by 1lb. of Australian, Nerubudda Valley, and Nagpore coal respectively, was 66.69, 53.81, 64.20; while the average for Welsh steam coal is 95.5, for Scotch, 78.54, and for Newcastle, 92.4. The number of pounds of water evaporated from 210° by 1lb. of Australian coal, was 5.64; by 1lb. of Nerubudda Valley, 4.54; and by 1lb. of Nagpore, 5.42. The averages for Welsh, Scotch, and Newcastle coal are 5.07, 6.64, 7.81.

IMPROVEMENTS IN THE MANUFACTURE OF STEEL.—M. Perinot, of Fourvoiray, France, has patented an invention, by which he hopes to effect an economy of nearly 60 per cent. in the manufacture of steel. His proposition consists in puddling with wood instead of charcoal, as at present. The inventor estimates that whilst the cost of producing 2000lbs. of steel with charcoal is £7, the cost with wood would be but £2 11s. 8d. By puddling with wood, more regular steels are obtained, more easily weldable, and more ductile than by Rivoise's method, and in the manufacture of iron for cementation (upon Comtoise's method), the advantage of using wood is still greater than for steels. Thus 2000lbs. of iron requires 3800lbs. of charcoal, equivalent to 30 cubic yards of wood, whereas puddling with wood only 5 cubic yards (equivalent to 660lbs. of charcoal) would be required. These calculations are stated to be the result of practical comparative experiments, and are based upon a two years' working of a single wood puddling furnace. It is anticipated that, with a double furnace, the comparison would be much more favourable.

APPLIED CHEMISTRY.

ACTION OF SULPHUROUS ACID ON METALS AND METALLIC OXIDES AT HIGH TEMPERATURE.—Scliff has recorded the following results of his experiments with sulphurous acid and some of the metals and metallic oxides at high temperature:—Cupric oxide when heated in the dry acid is only partially changed to cuprous oxide; a third of it passes into sulphate of cupric oxide:

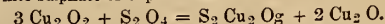

Zinc oxide undergoes no alteration. Lead oxide. The greater part is changed into sulphide, and some into lead sulphate. Quantitative analysis of the products gave widely different results. The carbonate of lead behaves like the oxide. Tungstic acid could only be reduced to the blue compound of tungstic acid and tungstic oxide. Iron (finely divided) undergoes combustion more or less actively even at a low temperature, and forms sulphide, and a small amount of sulphate of the protoxide. Lead (precipitated from the acetate by means of zinc) does not undergo combustion, but by long action is changed mostly into the sulphide. Tin (reduced from the chloride by zinc) undergoes active combustion below the melting point, and the metal is changed into a yellowish mass, which is a mixture of stannic oxide and bisulphide. If this product is heated in the sulphurous acid until the stannic oxide becomes insoluble in dilute acid, the bisulphide may be extracted. Antimony is attacked with difficulty; it is converted to the red amorphous sulphide. Arsenicum is only acted on by sulphurous acid when in the form of vapour, and then but slowly. Two sublimes are obtained; that nearest to the heat is in the most part sulphide of arsenic; the furthest is arsenious acid. Both have some sublimed arsenicum with them. Metallic copper, mercury, and bismuth undergo no change. Potassium burns rapidly when heated in sulphurous acid, and leaves a yellow residuum which contains little or no sulphurous acid, but consists of sulphate, hyposulphite, and polysulphuret of potassium.

APPLICATIONS FOR LETTERS PATENT.

NOTICE.—With the present Number we commence a new arrangement of our Monthly List of Patents. Instead of giving the List of Inventions Protected, as they have been passed by the law officer—the time of such passing being occasionally three to four months after the date of application, and thereby producing confusion in the numerical list—we now give a List of Patents in the numerical order in which they are daily applied for; and this arrangement will in future be followed.]

Dated January 9, 1861.

54. J. Fitton, Cavendish, and F. E. Fullerton, Chester, Windsor, State of Vermont, U.S.—Separating foreign matters from the droppings from carding machines.

55. J. Boulton and J. C. Boulton, Shoreditch—Machine for folding of envelopes.

Dated January 10, 1861.

60. J. A. Munn, 13, Earl-street, Red Lion-square—A spring window supporter.

Dated January 11, 1861.

78. M. C. E. Page, Valdoie, near Belfort, Haut Rhin, France—Kneading machine.

Dated January 12, 1861.

93. J. Gibbs, Brentford—Constructing submerged works.

Dated February 15, 1861.

382. E. Poulson, 3, Strathmore-terrace, Shadwell—Propelling all kinds of land carriages, barges, and boats.

388. M. B. Westhead, Manchester—Hoisting apparatus and railway carriages.

Dated February 18, 1861.

400. F. Barnes, New York, U.S.—Instruments for transmitting messages in any form of letter or character by means of electricity.

Dated February 19, 1861.

409. W. Pidding, Borough-road, Southwark—Envelopes and letters.

Dated February 23, 1861.

470. I. Spencer, Eccleston, near Prescott—Articles of earthenware.

471. J. Robinson, Rochdale—Machinery for sawing timber.

Dated February 25, 1861.

479. W. Dray, Farningham, Kent—Fire places.

480. E. F. Barnes, New York, U.S.—Railway chairs.

Dated February 28, 1861.

510. R. Hoyle, Bury, H. Spencer, Rochdale, and T. Holland, Padiham—Apparatus for preparing and spinning of cotton, and other fibrous substances.

Dated March 1, 1861.

523. F. Tolhausen, 35, Boulevard Bonne Nouvelle, Paris—Machine for gathering the sheaves or gavels of corn.

Dated March 4, 1861.

544. J. C. Haddan, 14, Pessborough-gardeus, Pimlico—Applying and securing the metal plates of armour-plated ships or vessels.

Dated March 5, 1861.

554. T. Petitjean, 4, Brydges-street, Covent-gardeu—Manufacture of glass.

Dated March 14, 1861.

636. W. Hodson, Kingsten-square, Hull—Propelling and steering carriage.

Dated March 15, 1861.

649. G. Dixon, 26, Cecil-street, Straud—Ploughs.

Dated March 16, 1861.

668. E. C. Morgan, Norwich—Protecting ships and fortifications.

673. G. H. Birkbeck, 34, Southampton-buildings, Chancery-lane—Marine propulsion.

Dated March 19, 1861.

687. B. West, St. James'-walk, Clerkenwell—Method of cutting and ornamenting the edges of books.

Dated March 20, 1861.

698. A. Symons, 63, Southwark Bridge-road—Propelling and steering vessels.

Dated March 22, 1861.

728. C. E. Swindell, J. Russell, and J. Price, Withywoor, near Dudley—Manufacture of horse nails.

Dated March 23, 1861.

734. W. T. Henley, 46, St. John-street-road, Clerkenwell—Electric telegraphs.

Dated March 25, 1861.

740. W. E. Manby, Victoria-wharf, Augustus-street, Regent's Park—Paper, linen, or other fabrics prepared with a preparation of blue, to be used for washing.

Dated March 26, 1861.

758. W. F. Brown, Westgate-street, Gloucester, and W. Jeffery, Eastgate-street, Gloucester—Method of attaching and securing hrooches and such like articles.

Dated March 27, 1861.

762. W. Jeffs, Manchester, and J. Pemock, Blackley, near Manchester—Steering ships or boats.

Dated March 30, 1861.

780. G. M. Coppo, 13, Rue Guillon, Paris—Machinery for fulfilling felt hats.

Dated April 1, 1861.

800. R. Searle, Woodford Wells, Essex—Telegraph cables and wires.

802. J. E. Boyd, Hither Green, Lewisham—Motive power for sewing machines.

814. C. S. Senton, Park-road, Clapham, G. Hawkins, Port street, Bermondsey, and E. Stansfield, Commercial-road, Peckham—Flap for covering the entrances of cellars and other places.

815. J. Brown, Glasgow—Preparing fabrics to render them suitable for packing goods.

816. J. Sickels, 67, Gracechurch-street—Apparatus for stitching, uniting and ornamenting leather.

817. W. Clark, 53, Chancery-lane—Stamping presses.

822. W. E. Newton, 66, Chancery-lane—Machinery for cutting and harvesting grain, grass, and other substances.

823. J. Seville, Oldham, and W. Lawton, Hollingwood—Starting and stopping railway trains.

824. A. C. Bamlett, Middleton Tyas—Reaping and mowing machines.

830. W. A. Shepard, Pall-mall—Street railways.

831. W. H. McNary, Brooklyn, New York—Apparatus for knitting.

832. A. V. Newton, 66, Chaucery-lane—An improved construction of bran duster.

Dated April 4, 1861.

833. W. E. Newton, 66, Chancery-lane—Machinery for cutting files.

834. M. Benson, 2, Royal Exchange-buildings—Generating steam.

835. J. S. Miller and T. P. Miller, both of Dalmarnock, North Britain—Colouring matters on textile fabrics.

Dated April 5, 1861.

838. W. Richardson, 24, New-walk, Leicester—Carriage and other axles.

839. D. Brown and W. Brown, both of Smethwick, Worcestershire, and E. Jones, Deepfields, Staffordshire—Manufacture of nails, railway spikes, or pins.

840. C. Storer, R. Jones, and J. Storer, Longford, Foleshill, Warwickshire—Railway braks.

841. R. B. Greenwood, 5, Durham-place East, Hackney-road—Candlesticks and candleholders.

842. W. Edwards, Wolverhampton—Manufacture of shoes for horses and other beasts of draught and burden.

843. W. E. Newton, 66, Chancery-lane—Breech-loading fire-arms.

844. G. Hawksley, Three Mill Lane, Bromley-by-Bow—Apparatus for measuring liquids.

845. A. Steuart, Croydon—Capstans.

846. J. Dunn, Preston—Apparatus for slubbing, roving, spinning, and doubling cotton.

847. J. Hutson, Richmond—Manufacture of bedsteads.

Dated April 6, 1861.

850. R. Wallwork, Bolton-le-Moors, and T. Sumner, Farnworth, near Bolton-le-Moors—Machinery for preparing cotton and other fibrous substances.

851. B. Knowles, Birmingham—Manufacture of paper mache blank trays.

852. J. Knight, 8, Crown-court, Chancery-lane—Manufacture of baths and trays and other vessels for photographic purposes.

853. T. G. Ghislin, 72, Hatton-garden—Preparing, applying, and adapting certain vegetable productions to further new purposes of manufacture.

854. J. H. Johnson, 47, Lincoln's-inn-fields—Looms for weaving figured fabrics.

Dated April 8, 1861.

858. H. Wilde, Manchester—Electro-magnetic telegraphs.

859. J. Clark, Glasgow—Apparatus for supplying paper to ruling, printing, and similar machines.

860. J. Walker and J. Barnes, Okenshaw—Manufacture of card cloth.

861. A. Shanks, 6, Robert-street, Adelphi—Washing machines.

862. H. W. Blake, Soho, Birmingham—Coining Machinery.

863. W. Clayton, Waterloo-road, Dublin—Fire-escapes.

864. R. A. Brooman, 166, Fleet-street—Apparatus for turning over leaves or sheets of music and other like sheets.

Dated April 9, 1861.

866. J. Wright, 42, Bridge-street, Blackfriars—Method of collecting letters, and mail matters in towns.

869. C. Gill, Newington—Construction of connecting instruments for chains, jewellery, and other articles.

870. W. H. Phillips, Nunhead—Combustion of fuel for generating steam and for other purposes.

871. W. Westbury, Aston, near Birmingham, and E. Cooke, Smethwick, Staffordshire—Fastenings for windows.

872. J. Higgins and T. S. Whitworth, Salford—Apparatus for preparing cotton and other fibrous materials for spinning.

873. A. Tweedale, South Cottage, Healey, near Rochdale, Lancashire, and J. Tweedale, Healey Hall, Lancashire, and S. Taylor, Rochdale, Lancashire—Temples for looms.

874. W. Wood, Birmingham—Breech-loading fire-arms and ordnance.

875. W. E. Newton, 66, Chancery-lane—Apparatus for drawing bolts.

876. F. Taylor, Romsey, Southampton—Apparatus for receiving, drying, and deodorising human excrement.

877. F. Ransome, Paris—Manufacture of artificial stone and cement.

Dated April 10, 1861.

878. T. A. Westou, Birmingham—Fastenings for fastening bands and belts and articles of dress.

880. A. Lamb, Southampton—Condensers.

884. J. Caw, jun., Halifax—Manufacture of metallic cords suitable for crinoline, suspending pictures, laces, and for other purposes.

885. W. R. Rogers, Gray's-inn-road—Dowels.

886. T. Taylor, 7, Wellington-row, Bethnal-green—Machinery for the manufacture of chenille and other circular pile fabrics.

890. W. Bury, Portman-street, Marylebone—Steam engines.

891. J. Lancelotti, 2, Brownlow-road, Dalston—Manufacture of sheet metal chains.

Dated April 11, 1861.

892. T. Don, 10, Poultry, and T. Smith, Tenter-lane, Leeds, and L. Horsfield, Bank Foundry, Leeds—Apparatus for drying and preparing grain, seeds, or berries, for food or other purposes.

893. C. Stevens, 31, Charing Cross Apparatus for raising liquids.

894. C. N. Kernet, Gloucester House, West Cowes, Isle of Wight, and M. D. Rucker, 166, Fenchurch-street—Obtaining ammoniacal salts and other valuable products from substances containing ammonia.

895. R. A. Brooman, 166, Fleet-street—Sizing or preparing paper and textile fabrics in order to render them waterproof.

896. R. Smith, Shaw House, Melksham Roller blind apparatus.

897. W. E. Newton, 66, Chancery-lane—Pressure gauges.

898. S. Roberts, Hull—Steam engines.

899. J. M. Dunlop, Manchester—Machinery for cleansing cotton.

Dated April 12, 1861.

900. S. C. Salisbury, Essex-street, Strand, and J. Turner, Dalston—Saving of cop waste.

904. J. Douglas, 255, Blackfriars-road—Kitchen ranges.

Dated April 13, 1861.

906. J. C. Rivett, Prestolee New Mills, Farnworth, Manchester—Machinery for carding cotton and other fibrous materials.

908. J. R. Cooper, Birmingham—Breech loading fire arms.

909. J. Silvester, West Bromwich—Spring baianes or weighing machines.

910. A. P. Delannoy, Paris—Lubricating the axles or journals of wheels.

911. G. Graham, Dalquhuru, Dumbarton Ornamental cotton fabrics.

912. H. Maden, Bacup, and J. Wheatler, Lancashire—Apparatus for spinning cotton, wool, flax, silk, and other fibrous substances.

913. E. Corke, South Borough, Tonbridge Wells—Instrument to be fixed on the bayonet or muzzle of a rifle for estimating distances.

914. C. Roberts, Douglas, Isle of Man—Boots and shoes.

915. C. D. Ahle, 20, Southampton-buildings, Chancery-lane—Construction of turntables.

916. W. T. Eley, Gray's-inn-road—Cartridge cases for breech-loading fire-arms.

917. C. D. Ahle, 20, Southampton-buildings, Chaucery-lane—Machinery for forging nails.

918. J. Wright, 42, Bridge-street, Blackfriars—Manufacturing postage letter paper, postage wrappers or covers for newspapers.

Dated April 15, 1861.

920. A. Shanks, 6, Robert-street, Adelphi—Machines for drilling and boring metals.

922. J. Smith, Seaforth, near Liverpool, and S. A. Chease, Liverpool—Engine for obtaining and applying motive power.

924. T. Miller, Fossaway, Perth—Machinery for preparing india rubber and other similar gums for insulating telegraphic wires.

925. R. C. Furley, Edinuhugh—Rendering pills tasteless by means of a coating of albumen.

926. F. Lenuard, Belgrave-gate, Leicester—Manufacture of looped pile fabrics.

927. F. Gye, Wandsworth-road—Obtaining light.

929. F. M. Eden, 5, Hare-court, Temple—Manufacturing silicate of lime or hydraulic cement.

930. F. M. Eden, 5, Hare-court, Temple—Cartridge for breech-loading guns.

931. P. Gipouloux, 20, Rue Thevenot, Paris—An improved cooking stove.

932. J. D. Malcoln, Brixton—Manufacture of nitric acid and caustic soda.

933. R. Ransome, Ipswich—Inkstands.

934. C. Fletcher, Nottingham—Manufacture of chenille.

935. R. Hoigson and E. Holden, Carlisle—Manufacture of soap.

936. D. Chalmers, Glasgow—Looms for weaving.

Dated April 17, 1861.

938. T. Jones, Bolton-le-Moors, and G. Mallinson, Salford—Manufacture of piled fabrics.

939. J. R. Hill, 7, Duke-street, Adelphi—Clutches or connections for machinery.

940. H. Anthonissen, Brussels, Belgium—Panification and simultaneous extraction of starch.

947. W. A. Dixon, Newport, Monmouthshire—Plastering walls and ceilings.

942. G. Leroy, Bristol—Vessels for containing aerated liquids.

944. B. Brown and R. Hacking, Bury—Apparatus employed in spinning cotton and other fibrous substances.

944. H. A. F. Duckham, Clerkenwell-green—Gas meters and regulators.
945. W. Clark, 53, Chancery-lane—Arrangement of atmospheric post for the transmission of letters.

Dated April 18, 1861.

947. C. Norton, 6, Hanley-street, Birmingham—Manufacture of ornamental eyelets.
948. H. Carstanjen, Cologne—Increasing the illuminating power of gas.
949. C. Stevens, 31, Charing-cross—Bauds for transmitting motion to machinery.
950. H. Jones, Birmingham—Certain kinds of breech-loading fire-arms.
951. T. B. Wilkinson, Deptford—Means for securing a watch in the pocket of the wearer.
952. E. Morgan, Liverpool—Ships and other pumps.
953. L. Brown and R. Hacking, Bury—Apparatus to be employed in preparing cotton and other fibrous materials for spinning.
954. J. Byson, Worcester-street, Birmingham—Weighing machines.
955. R. A. Brooman, 166, Fleet-street—Producing photographic pictures.
956. A. V. Newton, 66, Chancery-lane—Apparatus for cleaning cotton and other fibrous substances.
957. C. Jordan, Newport, Monmouthshire—Apparatus for drying the moulds and cores used for iron or other castings.
958. M. Buchanan, Glasgow—Gloves.
959. J. H. Johnson, 47, Lincoln's-inn-fields—Electric telegraph apparatus.
960. W. Benson, Allervash House, Hexman—Furnaces.

Dated April 19, 1861.

961. A. Eaves, Birmingham—Manufacture of the bezels or rings used in glazing the dials of clocks.
962. P. Mingaud, 42, Rue Laffitte, Paris—Drinks obtained by specially treating the fruits of a tree called Arbousier.
963. J. M. Brierley, Manchester—Manufacture of woven fabrics applicable to crinoline skirts and petticoats.
964. I. Riley and T. C. Wolstenholme, Blackburn—Heating apparatus for domestic purposes.
965. R. Maclaren, Glasgow—Joining or connecting pipes.
966. J. Ridley, Stagshaw—Steam generators and superheaters.
967. J. Ridley, Stagshaw—Cutting apparatuses for reaping and mowing machines.
968. J. Ridley, Stagshaw—Portable cinder sifting apparatus.
969. W. Grove, 104, Shoe-lane—Cylinder printing machines.
970. F. J. Jones, Aldermanbury—Braces.
971. J. P. Schenkl, Boston, U.S.—Packing for projectiles for guns or ordnance.
972. J. Jobson, Derby—Apparatus to be employed in boilers for consuming the smoke.
973. W. Hudson, Burnley, and C. Catlow, same place—Loom for weaving.
974. H. Parkes, Birmingham—Producing ornamental surfaces of metal and other materials.
975. J. Gjers, Middlesbro'-on-Tees—Apparatus for obtaining motive power.

Dated April 20, 1861.

976. W. Ryder, Bolton-le-Moors, and T. Ryder, same place—Machines for fluting rollers and shaping metals.
977. M. Smith, Birmingham—Annealing pots or pans.
978. J. Whitehouse, Birmingham—Manufacture of door knobs.
979. J. Pinchbeck, 35, Whiskin-street, Clerkenwell—Wet gas meters.
980. R. A. Brooman, 166, Fleet-street—Mills for grinding corn and other grain.
981. J. B. J. Noirot, 29, Boulevard St. Martin, Paris—An improved process for manufacturing india rubber pipes.
982. W. Clark, 53, Chancery-lane—Ornamenting porcelain and other earthenwares and glass.
983. J. Webster, Birmingham—Manufacturing oxygen gas.
984. S. B. Haskard, Wollaton-street, Nottingham, and J. Dean and E. Dean, both of Radford—Improvements in machinery for the manufacture of looped fabrics.
985. J. Waddle, 6, Hill-street, Knightsbridge—Drums.
986. A. Smith, Daisy Bank, Ledgley, Staffordshire—Apparatus for ventilating forges and other overheated workshops.
987. G. A. Huddart and J. D. E. Huddart, both of Brynknir, Carnarvon—Steam engines.
988. A. V. Newton, 66, Chancery-lane—A mode of bleaching and refining oils.
989. A. V. Newton, 66, Chancery-lane—Construction of liquid meters.

Dated April 22, 1861.

990. J. Leetch, 68, Margaret-street—Manufacture of breech-loading fire-arms.
991. H. Moore and A. Higgin, both of Burnley, Lancashire—Apparatus for spinning and doubling cotton.
992. T. Parry, Plymouth—Manufacture of cartridges.
993. E. D. Bourne and P. Lavis, Birmingham—Cornice poles and curtain rods.
994. A. Dugdale, Paris—Centrifugal governors for steam engines.
995. H. Tarbouriech, 42, Laffitte-street, Paris—A double system mixed press.
996. G. W. Belding, 3, Moor-lane, Cripplegate—Sewing machines.
997. G. W. Belding, 3, Moor-lane, Cripplegate—Machines for making pointed tape trimming.
998. J. T. Dowling, 21, Frampton Park-road, Hackney—Time keepers.

999. C. Carey, Kennington Green—Apparatus used in making infusions of coffee.
1000. A. Henry, Edinburgh—Fire arms.

Dated April 23, 1861.

1001. R. Shaw, Patricroft, Manchester, and W. Snodgrass, Waterford, Ireland—Machinery for spinning cotton.
1002. T. Y. Hall, Newcastle-upon-Tyne—Safety lamps.
1003. W. Clark, 53, Chancery-lane—Looms for weaving stays or corsets.
1004. T. Peters, Great Alie-street, Whitechapel—Apparatus for moving or transmitting bodies.
1005. J. Samuda, Poplar—Iron vessels of war.
1006. P. Ward, 2, Cloud Hill Villas, Bristol—Manufacture of sulphuric acid.
1007. J. Marshall, 4, Richard-street, Liverpool-road, Islington—Apparatus used for retarding and stopping railway carriages.
1008. T. Richardson, Newcastle-on-Tyne—Purification of coal gas.
1009. E. H. Bentall, Heybridge, near Maldon, Essex—Constructing the framing of various kinds of agricultural implements.
1010. E. H. Bentall, Heybridge, near Maldon, Essex—Machinery for cutting or pulping roots to be used as food for cattle.
1011. R. Warry, Cbatham—Construction of breech-loading ordnance.
1012. M. Henry, 84, Fleet-street—Aerated liquid apparatus.
1013. M. Henry, 84, Fleet-street—Telegraphic apparatus.

Dated April 24, 1861.

1014. A. Leightou, 9, Buckingham-street, Strand—Honey comb spring.
1015. S. Handley, Cauceel-street, Walworth—Apparatus for receiving and consuming the residues of candles or other fatty or oleaginous substances.
1016. E. Woodcock, Forest-hill—Treating flax, hemp, and other vegetable fibres.
1017. F. J. Bramwell, 35, Great George-street, Westminster—Machinery for spinning fibrous materials.
1018. E. Lecot, 26, Cecil-street, Strand—Nosbags for horses.
1019. C. Stevens, 31, Charing-cross—A new artificial manure.
1020. G. D. Davis, 3, Bromley-terrace, Saint Leonard's-road, and J. Davis, 20, Archer-terrace, East India-road—Machinery for raising anchors.
1021. W. Lord, Royton, near Oldham, and J. Hilton, same place—Self-acting mules.
1022. J. Rhodes, Morley, near Leeds, and R. Kemp, Leeds—Rag machines.
1023. F. N. Gisborne, 3, Adelaide-place, London-bridge—Construction of electric targets for rifle practice.
1024. G. H. Birkbeck, 34, Southampton-buildings, Chancery-lane—Separating or extracting silver from lead.
1025. W. Wilson, Newcastle-upon-Tyne—Manufacture of bats.
1026. D. Stone, Manchester—Apparatus for preventing water pipes from bursting by the action of frost.
1027. E. H. Bentall, Heybridge, near Maldon, Essex—Apparatus for transmitting motion to machinery to be driven by horse power.
1028. T. Greenwood, Leeds—Construction and working of saw frames.

Dated April 25, 1861.

1029. G. Scott, Alpha Works, Isle of Dogs—Steam Engines.
1030. T. Taylor, 7, Wellington-street, Betnal-green—Machinery for certain fabrics into strips.
1031. D. Barker, Clapham—Signalling apparatus.
1032. G. Bartholomew and W. Bisset, both of Hoxton-square—Portable fountains.
1033. P. C. Lefol, 4, South-street, Finsbury—Manufacture of iron wheels.
1034. C. Callebaut, 4, South-street, Finsbury—Sewing machines.
1035. W. Harris, Willow-street, Walworth—Treating hides and skins to render them suitable to be made into straps for driving machinery.
1036. P. G. Gardiner, New York, United States—Construction of springs.
1037. T. Garner, Moorside, Worsley—Apparatus for preparing and spinning cotton.
1038. R. Gray, Sheffield—Mode of hardening and tempering crinoline flattened wire or sheet steel.
1039. S. Fox, Stockbridge Works, Deepcar, near Sheffield—Hardening and tempering steel.
1040. E. Strangman, Waterford, Ireland—Method of intercepting and carrying off the sewage of large towns.
1041. J. S. Templeton, Glasgow—Looms for weaving pile fabrics.
1042. H. Hughes, Homerton, and C. G. Hill, Nottingham—Manufacture of rollers for printing.
1043. T. Moore, 33, Regent Circus, Piccadilly—Windlasses worked by capstans.
1044. A. V. Newton, 66, Chancery-lane—Apparatus for regulating the water level in steam boilers.
1045. S. C. Salisbury, Essex-street, Strand, and J. Starley, Lewisham—Combination sewing machine.

Dated April 26, 1861.

1046. J. Lunn, G. Hilly, and J. Lisle, Huddersfield—Apparatus for stretching fabrics.
1047. C. J. Hill, Coventry—Dials of watches and clocks.
1048. R. J. Cole, 11, Pembroke-gardens, Bayswater—Ornamenting the backs of brushes.
1049. E. Newby, 35, Camomile-street, Bishopsgate-street, Within—Connecting link.

1050. J. H. Brown Romsey, Hants—Apparatus for lubricating the barrels of fire-arms.
1051. F. C. Warlich, 14, London-street, Fenchurch-street—Preparing coal used in the manufacture of artificial fuel.
1052. W. Cowan, Edinburgh—Gas meters.
1053. E. Strangman, Waterford, Ireland—System of building or construction applicable to architectural purposes.
1054. W. Griffith, Upper Sydenham—Hooped petticoats or crinolines.
1055. J. Marshall, Liverpool-road—Preventing the fracture of metals from crystallization.
1056. J. Dellagana, Shoe-lane—Apparatus for embossing and taking casts.
1057. E. H. Joynson, St. Mary's Cray—Machinery for the manufacture of paper.
1058. J. Watkins, Birmingham—Carriage axles and axle boxes.
1059. S. C. Salisbury, Essex-street, Strand, and J. Starley, Lewisham—Sewing machinery.

Dated April 27, 1861.

1060. J. Poole, 42, Bridge-street, Blackfriars, and W. Milward, Camberwell—Tyres for wheels to be used on railways and tramways.
1061. J. Foster, Radford, E. H. Bramley, and E. Knntton, Nottingham—Manufacture of twist lace.
1062. T. V. Morgan and J. G. Dalke, Battersea—Filtering agents.
1063. J. B. Farrar and J. Farrar, Halifax—Apparatus for spinning wool, or other fibrous substances.
1064. T. W. Miller, Her Majesty's dock-yard, Portsmouth—Steam engines.
1065. G. G. Ray, Boston, Massachusetts, United States—An improved pen-holder.
1066. W. H. Parsons, Butler's-buildings, Cambridge Heath-road—Machinery for making nuts, bolts, and rivets.
1067. G. M. Story, 2, Coleman-street, and G. W. Edwards, 37, Mintern-street, Hoxton—Billiard tables.
1068. H. T. Wedlake, 327, Euston-road—Harmoniums.
1069. H. Bessemer, Queen-street-place, New Cannon-street—Projectiles and ordnance.
1070. W. E. Newton, 66, Chancery-lane—Gas burners.

Dated April 29, 1861.

1071. J. Mash, Manchester—Steam engines.
1072. F. A. Thoinier, Bourbon l'Archambault, Allier—Reaping machine.
1073. J. B. H. Desplas, Harfleur, Seine-Inférieure, France—Apparatus for protecting the legs of running horses from accidents.
1074. H. Dixon, 8, Park-street, Sydenham—Photography.
1075. W. Johnson, Little Malvern—Saddle trees.
1076. W. E. Newton, Chancery-lane—Desiccating and torrefying farinaceous and other substances.

Dated April 30, 1861.

1077. H. J. T. Labat, 29, Boulevard St. Martin, Paris—Apparatus for hauling ashore ships and vessels.
1078. G. Hulme, Rochdale—Process of carding wool, cotton silk, or other fibrous materials.
1079. J. Meyer, Berlin—New chemical combinations, and the application thereof to fixing aniline and pigment colours in printing and dyeing.

Dated May 1, 1861.

1080. T. A. Kendal, 103, Cowley-street, Saint George's in the East, and M. D. Rogers, 2, Bow-lane Cottages, Saint Leonard's-road, Bromley—Chain cable controller for ships' windlasses.
1081. W. Horn, 3, Butler's-terrace, Ossory-road, Old Kent-road—Steam and water tight joints for fixing tubes in plates.
1082. I. Hollis, Birmingham—Manufacture of the guards and trigger plates of rifles.
1083. J. Sicksel, 67, Gracechurch-street—Sewing machines.
1084. R. Laing, Ince, near Wigan, and I. Swindells, Wigan—Treatment of certain ores containing metals.
1085. F. J. Bramwell, 35A, Great George's street, Westminster and W. Owen, Phoenix Iron Works, Rotherham—Manufacture of articles of wrought iron or steel.
1086. A. E. Holmes, Derby—Landaus, socables, and other like headed carriages.
1087. F. Z. Roussin, 29, Boulevard St. Martin, Paris—Application of colouring matters to the dyeing and printing of fabrics.
1088. W. Browning, St. John-street, West Smithfield—Apparatus for ascertaining the distance of distant objects.
1089. T. Hooman, and J. Maliszewsky, 490, New Oxford-street—Photographic printing upon the interior of glass.
1090. J. E. F. Lüdeke, Marke, Hanover—Motive power engines.
1091. A. McNeile, Liverpool—Construction of targets.
1092. R. T. Pattison, Daldoroh House, Ayr—Method of fixing colours in connection with the printing and dyeing of woven fabrics.
1093. W. Walton, Ivy Cottage, Old Charlton, Kent—A new manufacture of overlapping wall facing.

Dated May 2, 1861.

1094. J. C. Wilson, 25, Bucklersbury—Centrifugal machines.
1095. J. C. Wilson, 25, Bucklersbury, London—Apparatus for the manufacture of sugar.
1096. W. Scholes, High Town, near Leeds—Carding engines, for carding wool or other fibrous substances.
1097. W. Hoyle, Greenhill-terrace, Greenhill, Oldham—Preparing, spinning, and doubling cotton and other fibrous substances.

1093. M. Winkler, 583, Gumpendorf, Vienna—Locks and other fastenings.
1099. E. De Bassano and A. Brudenn, residing in Brussels—Manufacture of stearine.
1100. L. J. Jordan, Bedford-square—An aphrodisiac phosphorised nerve tonic.
1101. W. Clark, 53, Chancery-lane—Imitation of gold and silver embroidery.
1102. L. Glatard, Roanne—Horse draughts and carriage fittings.
1103. R. A. Brooman, 166, Fleet-street—Solar time-keepers or chronometers.
1104. G. Davies, 1, Scrie-street, Lincoln's-inn—Gas burners.
1105. J. G. Brown, Croxton—Obtaining motive power.
1106. P. Wright, Dudley—Manufacture of wheels.
1107. W. Clissold, Durdridge—Driving belt.
1108. G. Mead, Bethnal Green-road—Portable canteen adapted for use in the army.
- Dated May 3, 1861.*
1109. M. A. F. Mennons, 39, Rue de l'Exchiquier—Manufacture of paper.
1110. A. F. Rhind, Norfolk-place, Lower-road, Islington—Fastening of pins, brooches, and other articles of jewellery.
1111. T. Bradshaw, Salford—Apparatus for doubling yarn or thread.
1112. G. Hayes, Elton, Huntingdon—Apparatus for applying motive power.
1113. O. Rowland, Wellington-road, Kentish Town—Electric telegraphs.
1114. P. A. Godefroy, 3, King's Mead Cottages, New North-road, Islington—Manufacture of gutta percha.
1115. J. A. Manning, Temple—Method of collecting ammonia from the waste gases arising from the combustion of coal.
1116. A. Wight, Friday-street, Cheapside—Manufacture of trimmings.
1117. W. E. Newton, 66, Chancery-lane—Treatment of copper ores.
1118. E. Humphrys, Deptford—Machinery for steam vessels.
1119. J. Johnson, 61, Leader-street, Chelsea—Show or window boards.
1120. W. Addy, Pigot-street, Manchester—Machinery for washing fabrics and for churning.
1121. G. Rydill, Dewsbury—Smoke consumer.
1122. G. W. Reynolds, Birmingham, and S. G. Taylor, Oldbury—Improved hand drill.
1123. W. Rowan, Belfast—Machinery for scutching flax and other fibrous substances.
1124. R. A. Brooman, 166, Fleet-street—An improved thread for weaving and other uses.
1125. W. C. Homersham, Adelphi-terrace—Engines and implements for ploughing and cultivating land.
1126. W. Palmer, 3, Evelyn-place, Brighton—Apparatus for facilitating and imbibing of liquids.
1127. J. M. Baab and P. O. Thomas, both of Gerrard-street, Soho—Apparatus for perforating paper.
1128. E. P. Smith, Weymouth—Construction of radial traversing carriages.
1129. E. B. Wilson, Great Wyder-street, St. James', and W. Fijon, Newland-street, Eaton-square—Manufacture of railway wheels, tires, and other hollow articles from cast steel or malleable cast iron.
1130. W. Birks the elder, Nottingham, W. Birks the younger, and J. Birks, same place—Manufacture of lace or net.
- Dated May 6, 1861.*
1131. J. V. Vignon, 34, Dean-street, Soho—Preparing enamel applicable to various purposes.
1132. G. Ager, Aylsham, Norfolk—Apparatus for breaking or opening land.
1133. J. C. Tiffany, New York—Promoting a more perfect combustion of fuel in furnaces.
1134. T. Blackburn and M. Knowles, of Blackburn—Apparatus for warping cotton, worsted, and other similar materials.
1135. E. T. Hughes, 123, Chancery-lane—Manufacture of artificial flowers.
1136. E. L. Paraire, 52, Rathbone-place—Propelling carriages on the common roads.
1137. W. Abbott, Richmond—Construction of cages for birds or animals.
1138. W. Johnson, Little Malvern, Worcestershire—Railway carriages or locomotive engines.
1139. W. Johnson, Little Malvern, Worcestershire—Apparatus for churning and kneading.
1140. G. H. Ellis, New Malton—Apparatus for cleaning boots.
1141. R. A. Brooman, 166, Fleet-street—Manufacture of threads, cords, fabrics, felt, and pulp from the hop plant.
1142. J. Drew, Hatton-garden—Apparatus to be employed for supporting structures while inserting girders therein.
1143. G. Coles, Gresham-street West, J. A. Jacques, J. A. Fanshawe, and T. Galpin, all of Tottenham—Manufacture of various articles of wearing apparel.
1144. W. E. Newton, 66, Chancery-lane—Lubricating compound.
1145. J. Burch, Cragg Hall, near Macclesfield—Construction of steam and others boilers.
- Dated May 7, 1861.*
1146. C. Stevens, 31, Charing Cross—Gutta percha and india-rubber toys.
1147. H. Hirsch, Berlin, Prussia—Electricity for telegraphic and other purposes.
1148. S. A. Beers, Brooklyn, New York, United States—Rails for street railroads.
1149. J. B. Jarlot, 4, South-street, Finsbury—Machinery for the manufacture of artificial fuel.
1150. W. E. Newton, 66, Chancery-lane—Apparatus for boiling substances and generating steam.
1151. F. Defaye, Capian, near Bordeaux—Hydraulic apparatus.
1152. W. E. Gedge, 11, Wellington-street, Strand—Apparatus for conducting or forcing the flow of water.
1153. J. Willis, Little Britain—Umbrellas and parasols.
1154. J. H. Johnson, 47, Lincoln's-inn-fields—Buttons for garments or other purposes.
1155. G. Davies, 1, Scrie-street, Lincoln's-inn—Apparatus for boiling sugar.
1156. W. Birks, the elder, Nottingham, W. Birks, the younger, same place, and J. Birks, same place—Manufacture of bobbin net or lace.
- Dated May 8, 1861.*
1157. J. Pickett, Chiswell-street, Finsbury—Covering or partially covering the sticks and handles of whips and parasols.
1158. T. Blackburn and M. Knowles, Blackburn—Looms for weaving.
1159. T. Elce, jun., Manchester—Machinery for combing wool, cotton, and other fibres.
1160. J. Nadal, 14, Brooke's-market, Brooke-street, Holborn—Candlesticks.
1161. J. T. Massiaux, Nouzon, France—Manufacture of nails.
1162. H. M. Nicholls, 9, Essex-street, Strand—Instrument for withdrawing corks from bottles.
1163. R. Bernard, Bordeaux—Means of catching flies.
1164. L. Wytenbach and P. Lugand, 12, Rue Caumartin, Paris—A life preserver in confagurations.
1165. J. Fitter, Birmingham—A new or improved table expander.
1166. J. R. Hunt, 3, Chichester-place, Wandsworth-road—Manufacture of gutta percha.
1167. W. W. Harrison, Sheffield—Tea and coffee urns.
1168. E. Hoskins, Birmingham—Joints for articles in metal.
1169. P. H. Williams, Bristol—Adaptation of plates of iron and other metal in the construction of dwelling houses.
1170. H. Swan, Hammersmith—Lubricating apparatus.
- Dated May 9, 1861.*
1171. J. Yeardon, Lancashire-hill, near Stockport—Manufacture of healds.
1172. C. Lenny, Croydon—Carriages.
1173. G. Carter, Blackburn—An improved thermometrical fire alarm and extinguisher.
1174. J. Stewart, Glasgow—Manufacture of cards for jacquard weaving.
1175. J. Burch, Cragg Hall, near Macclesfield—Apparatus for propelling ships and vessels.
1176. F. Stern, 75, Cannon-street, West—Fastenings for porte-monnaies, pocket-books, cigar-cases, and similar articles.
1177. J. N. Johnson, 47, Lincoln's-inn-fields—Decoloration and disinfection of liquids.
1178. H. Cater, Grove Steam Boiler Works, Southwark—Construction of steam boilers.
1179. I. M. Singer, New York, United States—An improved feed motion for sewing machines.
1180. H. Allen, Birmingham—Improvements in gloves.
1181. J. Browning, Minories, and W. Crookes, Mornington-road—Spectrum cameras.
1182. J. Paterson, Wood-street—Neck-ties.
- Dated May 10, 1861.*
1183. T. Curtis, Livesey, near Blackburn—Manufacture of healds.
1184. W. Parsons, 28, Scotland-street, Brighton, J. Dowling Gloucester-lane, Brighton, and J. Dowling the younger, Gloucester Cottages, Brighton—Railway and other passenger tickets.
1185. T. L. Jackson, Mile-end—Furnace bars.
1186. L. W. Roddewig, Sheffield—Steam boilers.
1187. A. Dunlop, Glasgow—Portable railways for facilitating the traction of draught of vehicles.
1188. A. L. E. Maulbon, 15, Passages des Petites Ecuries, Paris—Tile manufacturing machine.
1189. S. Barrett, Clifton-street—Projectiles.
1190. J. F. L. Baddeley, Major R.A., Royal Small Arms Factory, Enfield—Bands for fire-arms.
1191. P. Vallance, 4, Bolton-road, Abbey-road, St. John's Wood—Fire-arms and ordnance.
1192. P. A. Godefroy, 3, King's Mead Cottages, New North-road, Islington—Treatment of india-rubber.
- Dated May 11, 1861.*
1193. D. Zenner, Newcastle-upon-Tyne—Purifying lead.
1194. H. J. Sillem, Liverpool—An improved explosive shell.
1195. J. Wareing, Salford—Forging machine.
1196. H. J. Davies, Carlisle—Printing textile fabrics or materials.
1197. W. Wilson, Conisbro', Yorkshire—Wooden keys and trenails for railways and shipping.
1198. C. W. Lancaster, New Bond-street—Armour plates or bars for protecting ships and other structures.
1199. R. A. Brooman, 166, Fleet-street—An improved method of treating wood.
1200. A. C. de Meley, Paris—Treatment of natural phosphate of lime for several purposes.
1201. G. F. Jones, York, and J. Jones, York—Propelling and steering steam vessels.
1202. G. F. Jones, York, and J. Jones, York—Construction of vessels.
1203. H. Swindells, Handforth—Collars for horses.
1204. W. H. Tooth, Rhodeswell-road—Apparatus for reducing vegetable substances to a finely divided state.
1205. W. Clark, 53, Chancery-lane—Propulsion of life boats.
1206. W. Clark, 53, Chancery-lane—Machinery for planing lumber.
- Dated May 13, 1861.*
1207. F. Pulls, 25, Francis-terrace, Hackney-wick—A mode of preparing an oxidizing agent.
1208. R. Heaton and J. Stocks, Silsden, near Leeds—Looms for weaving.
1209. J. Birmingham, Cork—Apparatus for breaking stones and other hard materials.
1210. P. Chardemite, 4, South-street, Finsbury—Wind motive power engine.
1211. W. Clark, 53, Chancery-lane—Corking or stoppering bottles.
1212. G. Betjemann, G. W. Betjemann, and T. Betjemann, Pentonville—Inkstands or ink holders.
1213. J. Deakin, Harborne—Manufacture of slabs, panels, and other forms or articles in paper or paper pulp.
1214. T. Bell, Usworth House, Gateshead—Decomposition of the compounds of aluminium.
1215. C. F. Pollard, 26, Brompton-crescent—A sandal slipper particularly adapted for use in Turkish and other baths.
1216. A. C. Vautier, 9, Mincing-lane, City—Extracting new textile fabrics or fibrous matters of a silky or cotton nature.
1217. W. Clark, 53, Chancery-lane—The treatment of ammonia waters resulting from putrified urine.
1218. J. H. Johnson, 47, Lincoln's-inn-fields—An improved magic lantern.
1219. W. Smith, Little Woolston—Apparatus used when cultivating and tilling land.
1220. C. Oliver, Old Boswell-court—Apparatus for sounding bells on lighthouses.
1221. R. Hornsby, Spittlegate, Grantham—Ploughs.
- Dated May 14, 1861.*
1222. A. F. Hildebrand, Berlin—Apparatus for propelling and steering carriages.
1223. W. Clark, 53, Chancery-lane—Manufacture of steel.
1224. T. C. Boutet, 1, John's-place, Brunswick-road, Camberwell—A new motor applicable to all branches of industry.
1225. J. Bullough and J. Bullough, both of Baxenden, near Acreington—Looms for weaving.
1226. G. S. Goodall, Brigbouse—Wire card covering for carding tow.
1227. F. Bull, 165, London Wall—Show cases and boxes used in counting houses.
1228. R. A. Brooman, 166, Fleet-street—Working sugar refineries.
1229. R. W. Woolcombe, Stoke, Devon—Projectiles and fire-arms.
1230. J. J. L. Chazaren, Paris—Apparatus for containing and drawing off beer and other malt liquor.
1231. J. H. Johnson, 47, Lincoln's-inn-fields—Apparatus for the manufacture of aerated waters.
1232. J. Howard and E. T. Bousfield, both of Bedford—Apparatus to be employed in steam cultivation.
1233. J. Chedey, Grove, Great Guildford-street—Manufacture of glass rollers, plungers, and pipes.
- Dated May 15, 1861.*
1234. A. Whyte and M. Macdonald, Glasgow—Manufacture of frills, ruffles, or frilled trimmings.
1235. J. Wooler, Bradford—Apparatus for drying textile fabrics and materials.
1236. W. Clark, 53, Chancery-lane—Gas regulators.
1237. E. C. Kemp, Avon-place, Pershore-road, Birmingham, and T. Hall, Basinghall-street, Leeds—Gas lamps.
1238. J. Rile, Hapton, near Acreington—Certain materials to be used in the process of dyeing and printing.
1239. W. Mitchell, Manchester—Apparatus for printing paper hangings.
1240. H. Doulton, High-street, Lambeth—Vats and similar vessels for containing liquids.
1241. S. C. Lister and J. Warburton, Manningham, near Bradford—Spinning and treating yarns.
1242. W. E. Newton, 66, Chancery-lane—Machinery for cutting chaff.
1243. W. Jackson, Leeds—Mortising machines.
1244. J. Hicks, Hatton-garden—Self-registering thermometer.
- Dated May 16, 1861.*
1245. A. T. Watson, Middleton, Richmond, United States—Springs for railroad cars.
1246. F. N. Gisborne, 3, Adelaide-place, London-bridge—Electric targets for rifle and gun practice.
1247. C. Stevens, 31, Charing-cross—Mills.
1248. W. R. Bowditch, Wakefield, Yorkshire—Safety lamps.
1249. H. Gilbee, 4, South-street, Finsbury—An improved reaping machine to be called "comb beater."
1250. A. V. Newton, 66, Chancery-lane—Knitting machinery.
1251. G. Knight, Nottingham—Holders and cases for holding bonnet fronts.
1252. C. Clay, Walton, near Wakefield—Implements for cultivating land.
1253. D. K. Clark, 11, Adam-street, Adelphi—Furnaces.
1254. J. L. Bowhay, Moadbury, Devon—Reaping and mowing machines.
1255. B. Hudson, 25, Gloucester-crescent, Regent's Park—Construction of power looms.
1256. B. Hudson, 25, Gloucester-crescent, Regent's Park—Machine for applying steam in a mannerto cause direct rotation.

CLAY'S BRECH-LOADING CANNON.

FIG 1

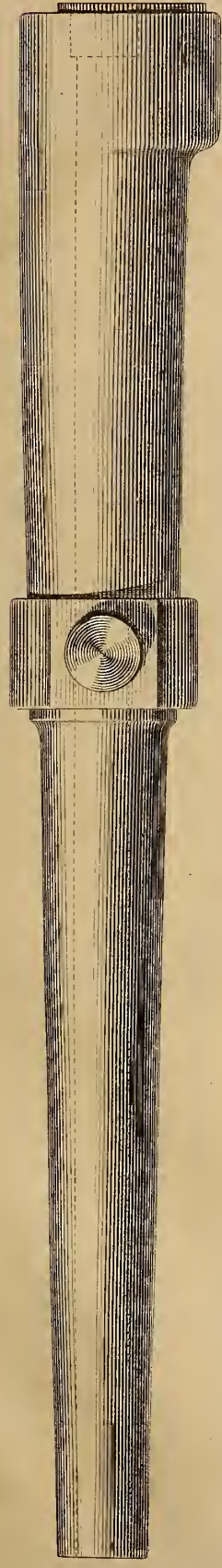
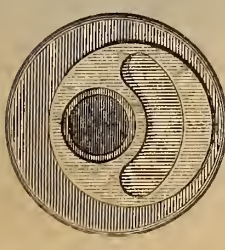
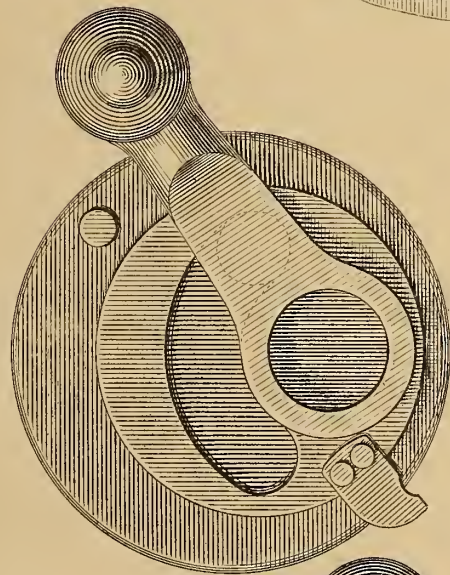
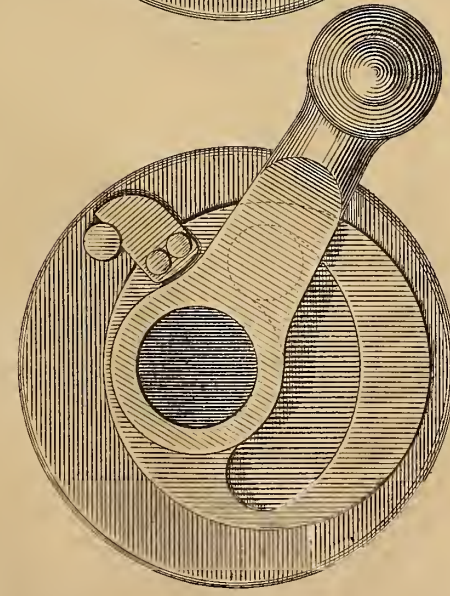

FIG 2.



OPEN

SHUT



Scale 1/2 = 1 Foot.

FIG 3.

Scale 3 = 1 Foot.

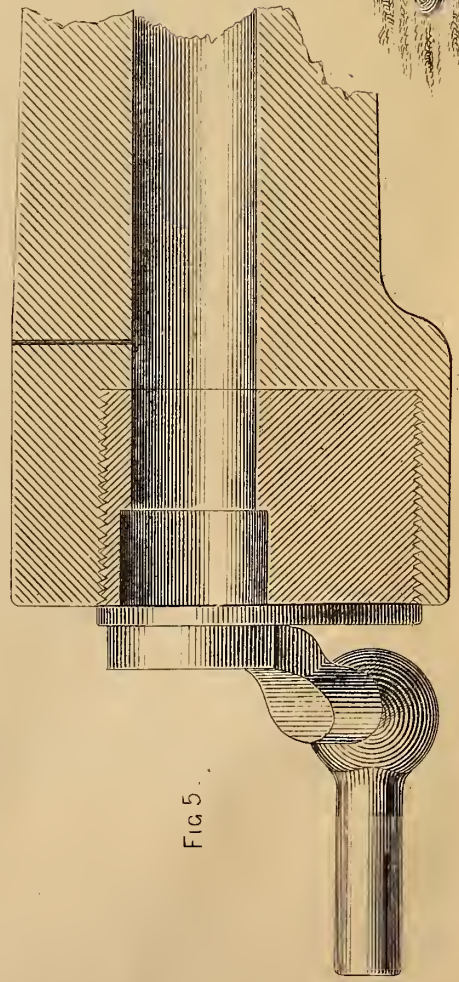
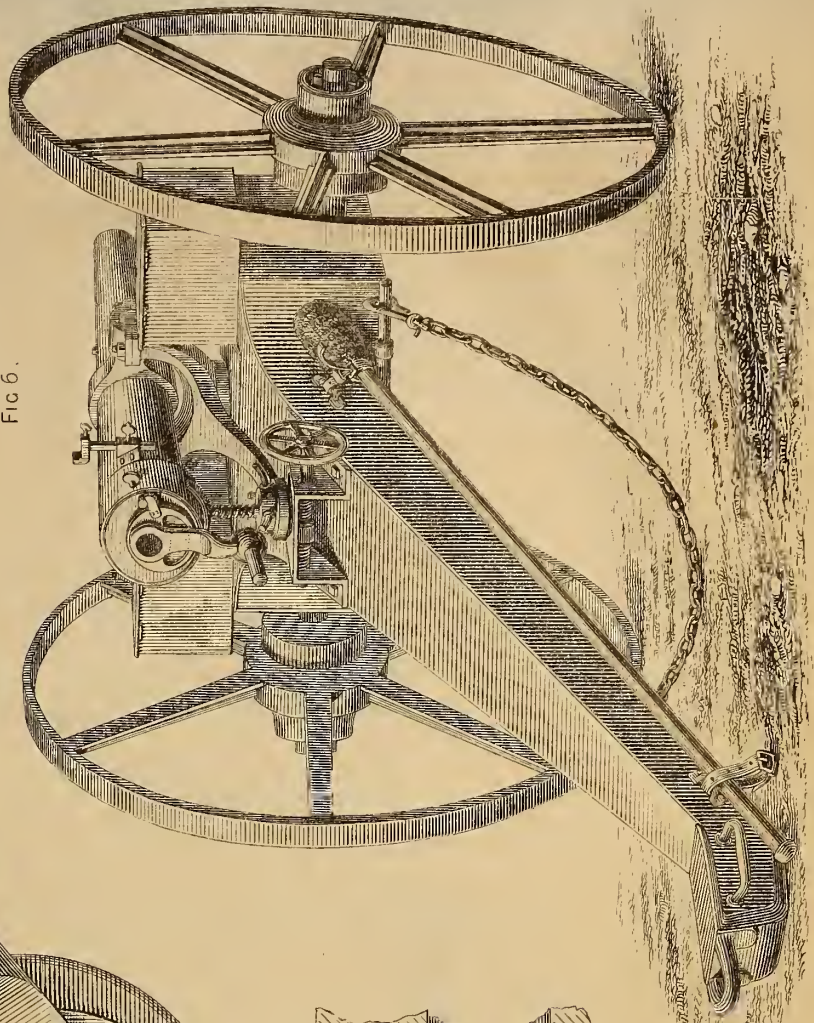

FIG 5.

FIG 4.

FIG 6.



INSTRUMENT FOR MEASURING DISTANCES.

By Lt.-Col. H. Clerk. R.A.; — F.R.S. &c. &c.

Scale, 3 ins = 1 ft.

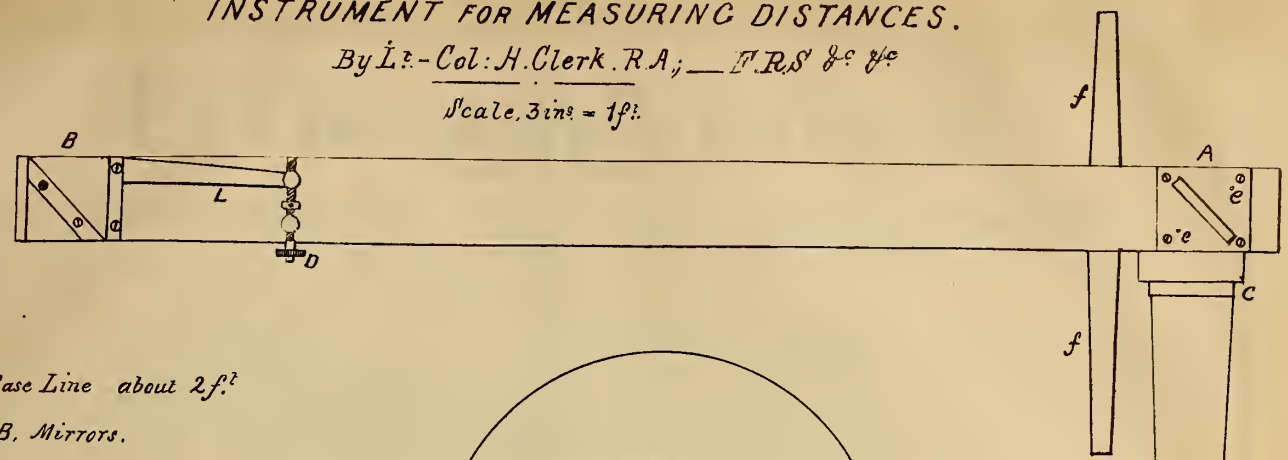

- A, B. Base Line about 2f.²
- A and B. Mirrors.
- C. Telescope.
- D. Adjusting Screw for Zero.
- e, e. do do for Verticality.
- f, f. Support for Instrument.
- L, Adjusting Lever.

Note. The Bar A. B is enclosed in a Case to keep out extraneous light.

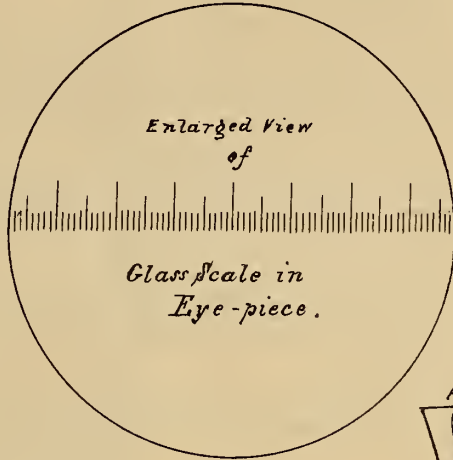

PLAN.

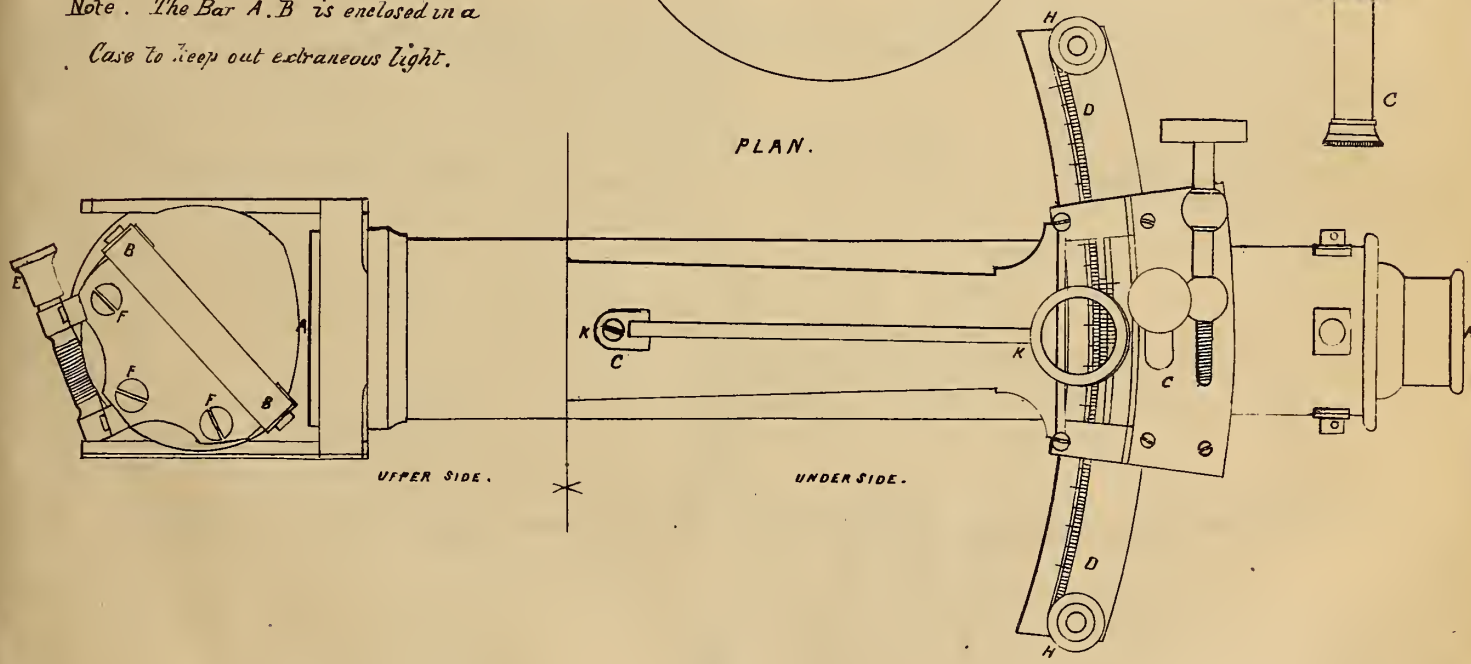

ELEVATION.

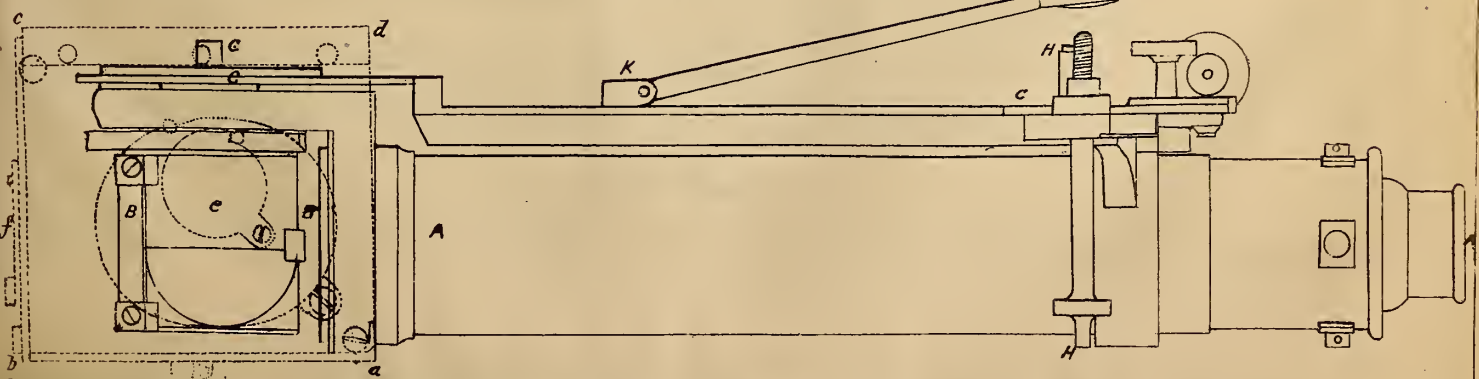

INDICATOR DIAGRAMS.

By Alban C. Stimers.

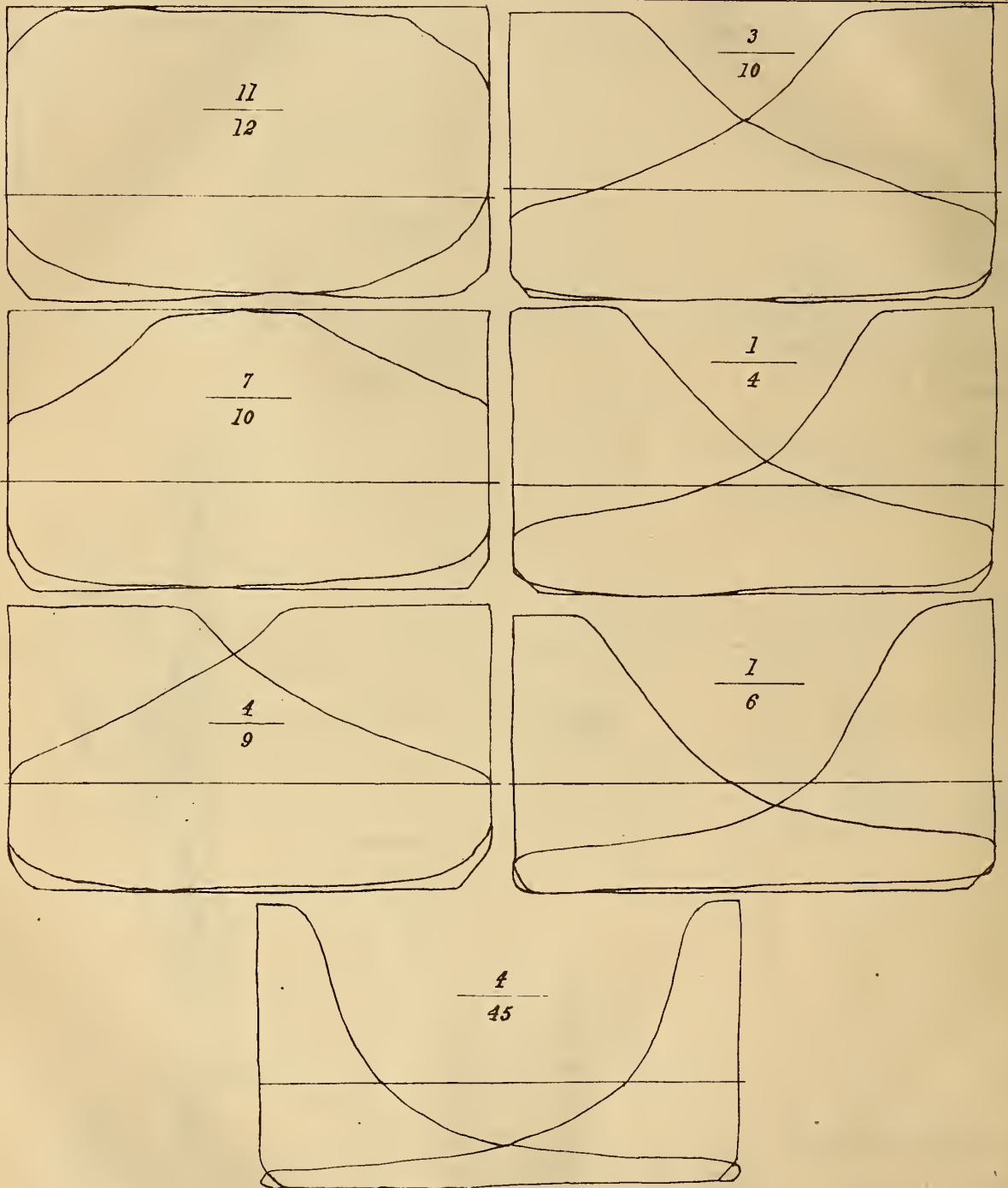

Scale, 1 inch = 22½ lbs

THE ARTIZAN.

No. 223.—VOL. 19.—JULY 1, 1861.

CLAY'S BREECH-LOADING CANNON.

(Illustrated by Plate 196.)

In the accompanying copper-plate engraving, we present our readers with several views of this very efficient piece of ordnance, the invention of Mr. William Clay, of the Mersey Steel and Iron Works, Liverpool.

Fig. 1 is a longitudinal elevation of the piece dismounted. Fig. 2. End view at the breech. Figs. 3 and 4. Enlarged views taken at the breech end; fig. 3 showing the breech piece in the position to allow of the insertion of the charge, and fig. 4 showing the bore closed, which has been effected by the means of the handle shown (figs. 3 to 5). Fig. 5 is a part longitudinal section of the breech end of the gun; and fig. 6 is a perspective elevation of the gun mounted upon its carriage, as equipped and ready for service.

We may add as a proof of the great rapidity with which this gun may be worked, that as many as eighteen rounds per minute have been discharged from it. This alone is a great recommendation, and, combined with the other advantages attained by the use of Mr. Clay's invention, warrants us in anticipating its entire success.

The following is the breech-loading arrangement adopted by Mr. Clay:—At the breech end the gun is formed with a projection, or extra depth, on its lower side, to allow for the boring out of a circular screw-threaded bore or recess of much larger diameter than the bore of the gun, and with its centre considerably below or eccentrically to the line of the bore. Into this recess is screwed a cylindrical screw-threaded block or breech-piece, which closes the bore of the piece when screwed home, but which has formed through it a cylindrical passage so placed that, when the breech-piece is turned back through one-half of a revolution, this passage comes exactly opposite to the bore of the piece, and allows of the charge being inserted. A pin is inserted at the upper right-hand portion of the end of the gun; this forms a stop for the handle to come against, and may be removed on loosening a thumb-screw that nips it, when it is desired to screw the breech-piece entirely out of place for cleaning the parts.

The gun itself is made by a rolling process, recently patented by Mr. Clay, and which enables him to manufacture cannon at a comparatively very reduced cost. The gun carriage is made from Mersey steel, and has, we understand, excited a good deal of admiration. The trunnions are formed in one, with a hoop shrunk on the gun, and are supported upon a strong bracket, which is pivoted upon the top of the carriage, and has a tail-piece extending backward, and is supported upon a box bracket fixed on the carriage near the top. In the extremity of the tail-piece is formed a slot through which rises the point of a nut or bolt (fig. 6), the head of which receives a transverse screw worked by a hand wheel. As this wheel is turned, the gun is traversed with the greatest nicety. The elevating screw is placed above the tail-piece, passing into a hand-nut below, and carrying a bracket above, in which the breech of the gun rests. This elevating and traversing arrangement is very neat, strong, and effective.

PRACTICAL PAPERS FOR PRACTICAL MEN.—No. V.

ON PROPORTIONING GIRDERS.

We purpose to devote the present paper to the consideration of the method to be followed in designing straight girders.

In order to produce a girder which shall withstand any given strain, we must make it of such size that its strength shall be equal to the stress to which it is to be subjected.

We have already, in our second paper, given equations whereby the moments of stress and direct stress on flanges may be found; and we have also found an expression for the strength of any plate girder having flanges of which the thickness is inconsiderable when compared with the depth of the girder; but we shall here principally occupy ourselves with the consideration of the strength of girders which are solid, or which are of such proportions that the above-mentioned expression will not apply to them.

Before proceeding further, we will pause to define the meaning of the term moment of stress.

We have already had occasion to employ the term moment, but merely

as a step to some further expression, but we shall now have occasion to use it independently of any other.

If we suppose a weight, say of two tons, to be supported by a table, or suspended by a string, we say that that weight is exercising a direct pressure, or force of two tons, in a vertical direction, which force is withstood by the elastic resistance of the table or string.

Let us now suppose that the weight is attached to the extremity of an arm, of which the other extremity is placed upon a centre, and let the distance from this supporting centre to the point of attachment of the weight be ten feet. In this case the tendency of the weight to fall will be exercised around a centre, and it may be withstood by some other force acting in a similar manner, and with the same intensity of force upon the same centre.

Let us now see in what manner we may compare forces thus acting round a centre. We must first observe that, as the weight descends, its action upon the centre will vary, for it will at first act at right angles to the arm to which it is attached; but, as it descends, it will operate in a direction of varying obliquity; therefore, we must not take as a datum the

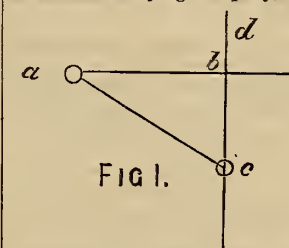

length of the arm to which the weight is attached, but the perpendicular distance of the weight b , or force from the centre of rotation. The method of measuring this is illustrated by the sketch Fig. 1; a represents a centre to which an arm, $a c$, is attached. At the further extremity of this arm we will suppose that the force of two tons acts in a direction, $b c$; then to find the effective distance of this force from the centre, a , we must produce $b c$, as shown; and from the centre, a , let fall the perpendicular $a b$ upon $c d$, then $a b$ will be the required distance.

We will now examine the effect of the length of this distance upon the action of the force.

If we suppose the centre to be fixed, there will be a certain twisting stress upon it, accompanied by a corresponding distortion; and, in producing this distortion, a certain amount of work will be done.

The amount of work done by any force is equal to the intensity of such force multiplied by the distance through which it acts.

Suppose the arm to revolve through any given space, say one-twentieth of a revolution, then will a weight at a distance of two feet pass in the same time through twice the space that a weight at a distance of one foot from the centre will do; hence, if the weights placed at these distances were equal, that at two feet distance from the centre of rotation would perform exactly twice the work of the other around that centre, wherefore the strain on the centre would be twice as great.

The strain on the centre will also evidently vary as the intensity or weight of the force acting; hence we may say that the effect of a force acting about a centre is equal to the force multiplied by its perpendicular distance from that centre, this being the rotating effect, which is termed the *moment of stress* about the given centre; hence, if we take feet as the lineal units, and tons as the units of weight, the moment of stress of two tons distant ten feet from the centre of moments will be,

$$M = 2 \times 10 = 20 \text{ foot-tons.}$$

M is the moment of stress. We consider it necessary to call this foot-tons, or inch-tons, &c., according to the units of measure employed, in order to recognise the value of the moment; but these terms must not be confounded with foot-tons, &c., meaning tons acting in a straight line through a certain number of feet.

From the foregoing equation, it will be observed that two moments may be equal, although the weights to which they refer may not be equal, thus,

$$M = 5 \text{ tons} \times 30 \text{ feet} = 150 \text{ foot-tons;}$$

also,

$$M = 15 \text{ tons} \times 10 \text{ feet} = 150 \text{ foot-tons.}$$

These moments are equal, and will, therefore, if acting upon the same centre, but in opposite directions, remain in equilibrio.

We have thus fully explained the meaning of the term *moment* of a force, because a perfect comprehension of it is absolutely necessary, in order to examine satisfactorily the subject of our present paper; and this explanation was the more requisite, because the term itself does not give any notion of the idea which it is intended to represent.

In a girder in equilibrium there will be two moments acting in opposite directions, and balancing each other; these will be the moment of stress and the moment of resistance, and it is the value of the latter to which we are now about to turn our attention.

The strength exhibited by any structure acted upon by a load not sufficient to break it, will be equal to the load acting upon it for the time being; thus, if to the lower end of a vertical rod we hang two tons, the rod will, by reason of its elasticity, be stretched to a certain extent, and will react with a tension equal to two tons; and the amount of elongation or extension will be in direct proportion to the load, and will vary simply as the load.

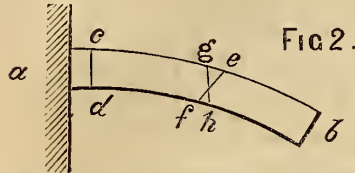

Let $a b$, Fig. 2, represent a deflected beam, but let lines $c d$, $e f$, parallel to each other, and at right angles to the length of the beam, be drawn previous to its deflection, then will all the fibres between the sections $c d$, $e f$, be of equal length.

When the beam is deflected, these lines, $c d$ and $e f$, will cease to be parallel, and will assume a position similar to that shown in the figure, the fibres on one side of the beam being compressed, and those on the other side extended, there being some point at which the strain changes from tension to compression, and at which there is therefore no strain: this part is called the neutral axis of the beam.

Draw $g h$ parallel to $c d$, then will the lines $e f$, $g h$ include spaces showing the elongation and compression of the fibres included between $c d$ and $e f$. An examination of the figure shows us that those fibres which are most distant from the neutral axis are most stretched, and, in fact, that the extension or compression of the fibres varies precisely as the distance from the neutral axis, but the extension is as the strain producing that extension, and the resistance or reaction of any fibre is equal to the strain; therefore, under any given load the effective resistance is as the distance from the neutral axis. The same remarks apply to the fibres in compression. From these observations we see that the outer fibres might be actually broken before the full resistance of those nearer the neutral axis has been brought into play. We may find the resistance per sectional square inch of the fibres in any layer by means of the following expression.

Let s = the greatest strain per square inch to which any part of the beam will be subject, and which, therefore, corresponds to that on the fibre most distant from the neutral axis, h = distance of this fibre from the neutral axis, s' = strain per square inch on any other fibre distant x from the neutral axis; then from the proportion mentioned above we find that

$$s' = \frac{s}{h} \cdot x$$

This will also be the resistance per square inch; and if a = the area of the fibre in inches, its total resistance will be

$$= \frac{s}{h} \cdot a \cdot x.$$

We must now determine the area of the fibre. This will evidently be its breadth multiplied by its thickness; or if x be the distance of the neutral axis from the bottom of the layer of fibres, and x' its distance from the top of the same, and b = breadth of layer,

$$a = b \{ x' - x \}$$

If the layer of fibres has any thickness, it will be more strained on the outer than on the inner surface, hence we cannot measure any fibre; we must therefore find some means of determining the aggregate strength of a number of them taken together. This may be most readily effected by means of one of the higher branches of algebraical analysis; but we shall here employ a more simple process—one which we have compared with the algebraical, and which we have found to yield exactly the same results.

We want to find the sum of the moments of resistance of all the fibres on one side of the neutral axis. The moment of the resistance of one fibre will be found by multiplying the foregoing quantities by the distance of the fibre from the neutral axis; but we must regard x and x' as having values approaching very nearly to each other; so that the value of the quantity $\{ x' - x \}$ is infinitely small, the mean distance of the fibre from

the neutral axis will be $\frac{1}{2} \{ x' + x \}$, and if we call m the moment of resistance of one fibre, then will

$$m = \frac{s b}{h} \{ x' - x \} \cdot \frac{\{ x' + x \}^2}{2}$$

$$= \frac{s b}{2 h} \{ x'^3 + x x'^2 - x' x^2 - x^3 \}$$

Let us now find an expression for the sum of the moments of resistance. We see from the figure that the values of the direct resistances of the fibres are shown by spaces included in a plane triangle, the base of which is the greatest strain upon the outer layer of fibres, and the height is the distance of the outer layer of fibres from the neutral axis; we may therefore consider that the sum of the direct resistances of all these fibres is represented by the area of this triangle. The strain per inch of thickness for the outer layer of fibres will be

$$= s \times b$$

But if the triangle represents the sum of the direct resistances, this sum will be

$$= s \times b \times \frac{h}{2}$$

We must now find the moment of this aggregate force about the neutral axis, for it is about this axis that we may consider the sections of the beam to revolve.

We may now have recourse to the well known principle that the whole of any weight or force may be considered as concentrated upon one point in the area over which it is distributed, that point being the centre of gravity; wherefore we will regard the above force as acting upon a point coincident with the centre of gravity of the triangle; but the centre of gravity of the triangle is situated at two-thirds of the height of the triangle from the apex thereof; hence the virtual distance of the above sum of the direct resistances from the centre of rotation or neutral axis will be

$$= \frac{2 h}{3}$$

and by multiplying the force by this quantity, we find its moment. Let M' equal this moment; then

$$M' = s \times b \times \frac{h}{2} \times \frac{2 h}{3}$$

$$= \frac{s b h^2}{3}$$

This will be the moment of resistance of all the fibres on one side of the neutral axis. The neutral axis will be so situated that the moments on each side of it are equal. Let the last equation apply to the upper side of a rectangular beam; and for the lower, let s'' = greatest strain per square inch, h' = distance of lowest fibre from neutral axis, and M'' = moment of resistance. Then,

$$M'' = \frac{s'' b h'^2}{3}$$

But because the two moments must be equal,

$$\frac{s b h^2}{3} = \frac{s'' b h'^2}{3}$$

therefore,

$$s h^2 = s'' h'^2$$

$$\frac{s}{s''} = \frac{h'^2}{h^2}$$

If the resistances of the top and bottom parts, that is to say, if the resistances to tension and compression be equal, or $s = s''$, then will $h'^2 = h^2$, and $h' = h$; or the neutral axis will be in the centre of the beam, h being equal to half the depth. Let d = the depth of the beam; then

$$M' = M'' = \frac{s b d^2}{12}$$

and if M''' equal the moment of resistance of the entire section,

$$M''' = \frac{s b d^2}{6}$$

which expression agrees with that obtained by the algebraical method. Equating this expression with the moment of strain produced by a load, we may find an expression for the load any given beam will support. Thus for an uniform load on a beam, the moment of greatest strain is at the centre, and

$$= \frac{W l}{8}$$

W being = total load, and l = span; but as the moments of strain and resistance must be equal,

$$\frac{W l}{8} = \frac{s b d^2}{6}$$

therefore,

$$W = \frac{4 s b d^2}{3 l}$$

This will be the strength, if the beam is of equal section throughout.

Let $s = 8$ cwt., $l = 10$ feet, $d = 10$ inches, $b = 7$ inches. All measurements must be in the same terms; therefore we must take the length in inches; it is = 120 inches, the strength of the beam will be,

$$W = \frac{4 \times 8 \times 7 \times 100}{3 \times 120} = 62.22 \text{ cwt.}$$

or a little over 3.1 tons: its resistance to a load concentrated at the centre of the span will be half this, or 1.55 tons. By means of the formula, at which we have arrived, we may determine the laws by which the variation of the strength of rectangular beams is regulated. These laws are tolerably simple, for we find that the strength of the beam varies directly as the breadth and as the square of the depth. This law is frequently all that is required for the determination of certain elements of bridge construction, when it is applied in the following manner. Let us suppose that it is required to determine the thickness of some cast iron plates intended to carry a roadway, and to be placed upon main girders, 4 feet apart. Let the load per square foot be 200 lbs., then it matters not what the breadth of the plates may be; from the other elements the thickness may be calculated. Let us suppose a portion of one of the roadway plates 1 inch in width, to represent a beam; then the dimensions, &c., will be, span, 4 feet; width, 1 inch; and the load

$$= \frac{200 \times 4}{12} = 66.66 \text{ lbs.}$$

which is uniformly distributed upon this beam, the greatest moment of strain, viz., that at the centre of the span, will be,

$$\frac{W l}{8} = \frac{66.66 \times 48 \text{ ins.}}{8} = 400 \text{ inch-pounds.}$$

But it has been determined experimentally that the safe moment of strain upon good cast iron is 1000 inch-pounds in round numbers; and we have shown above that the moment of resistance varies at the square of the depth of the beam; hence the depth of the beam to support 400 inch-pounds will be found from the proportion,

$$1000 : 400 :: 1 : \text{the square of the required depth.}$$

which will therefore be,

$$\sqrt{\frac{400}{1000}} = \sqrt{0.4} = 0.666 \text{ inches.}$$

This rule for determining the requisite thickness for roadway plates is exceedingly simple, and may be thus stated:—Multiply the load per square foot in lbs. by the square of the length (or distance between supports) in feet, divide by 8000 and the square root of the quotient will be the required thickness in inches. The calculation would be thus performed in the foregoing case, t being equal to the required quantity,

$$t = \sqrt{\frac{200 \times 4^2}{8000}} = \sqrt{\frac{2}{5}} = 0.666 \text{ inches}$$

as before obtained.

(To be continued.)

ON GAS LIGHTING.—DISCUSSION ON PUBLIC LIGHTING AND SUGGESTED IMPROVEMENTS.

BY SAMUEL HUGHES, CIVIL ENGINEER, F.G.S.

In my last paper I have shown, as the result of a great many experiments on the public lamps of the metropolis, that these do not consume on the average more than 15,501 cubic feet, when lighted throughout the year from sunset to sunrise.

If we now calculate what should be paid for this supply of gas, even at the same price as that paid by the private consumer, we shall find that a very excessive overcharge is made by the companies all over London. The prices now paid by the private consumer within the metropolis may be said to range from 4s. to 4s. 6d., as the exceptional cases in which more than 4s. 6d. is charged by one or two companies in remote parts of the metropolis are scarcely worth noticing in this general view.

We shall assume for the present that the service of lighting, cleaning, extinguishing, repairing, &c., is worth 13s. per lamp per annum, although we shall afterwards show that this is more than the cost to the companies, and much more than it could be done for by the parishes, should they choose to take it into their own hands.

The following, then, are the very highest prices which should be charged for gas when the consumer pays from 4s. to 4s. 6d. per 100 feet.

		Additional for Lighting. &c.		Extreme price which should be paid per lamp per Ann.			
s.	d.	£	s.	d.	£	s.	d.
15,500	at 4 0	3	2	0	13	0	3 15 0
15,500	at 4 2	3	4	7	13	0	3 17 7
15,500	at 4 3	3	5	10½	13	0	3 18 10½
15,500	at 4 6	3	9	11	13	0	4 2 11

Taking the fair price to be 75s. per lamp per annum, when the private consumer pays 4s. per 1000 feet, we may compare the following parts of the metropolis where the 4s. price prevails.

In the City of London the prices paid per lamp per annum are 82s. and 84s.

	£	s.	d.	£	s.	d.
In Mile End Old Town the price per lamp is	4	8	0			
In Limehouse.....	4	9	0	and	4	15 0
In Poplar	4	3	9	and	5	1 3
In part of Clerkenwell.....	4	4	0			
In Whitechapel.....	4	4	0	and	4	12 0

In the following districts, or in parts of them, the price has been reduced to 4s. 2d. per 1000 feet since the passing of the Metropolis Gas Act, and here the extreme price per lamp per annum should be £3 17s. 7d

	£	s.	d.	£	s.	d.
But in Camberwell the price ranges from	4	4	0	to	5	0 0
In Bermondsey the price paid is	4	0	0			
In Lambeth.....	4	18	6			
In St. George the Martyr	4	0	0			
In St. Mary, Newington	4	10	0			

The same overcharges are paid in the district supplied by the Phoenix Company, which has reduced its price to 4s. 3d. since the passing of the Metropolis Gas Act. The excess of price, however, is still greater in districts where 4s. 6d. is the price charged to the private consumer. The amount paid per lamp in these districts ranges from 90s. up to 110s., or 27s. in excess of the price which should be charged according to the quantity of gas consumed.

We shall show, presently, the very large saving which has already been made in all towns where the method has been adopted of burning the public lamps by meter.

There is also another saving which the provisions of the Metropolis Gas Act place within the reach of all local authorities in the metropolis. It is commonly understood that before the passing of this Act—at all events before the pressure upon the Companies, which prevailed during the passing of the Act—the common gas supplied in London did not exceed an illuminating power of 10 sperm candles; but since the passing of the Act all the gas companies in London are compelled to supply gas equal to 12 sperm candles, and they are liable to heavy penalties whenever the gas falls below this standard.

The present contracts for public lighting usually stipulate that each public lamp shall consume 5 feet an hour; and as the quantity of gas required to give a fixed light is in the inverse ratio of the illuminating power, it follows that, as 12 : 10 :: 5 : 4½; so that 4½ feet of 12-candle gas will give the same amount of light as 5 feet of the 10-candle gas.

There can be no doubt if the provisions for testing the gas be properly carried out, that 4 feet per hour consumed in the public lamps would give as much light as 5 feet of the gas which has hitherto been supplied in the metropolis.

EXPENSE OF LIGHTING AND EXTINGUISHING THE GAS, CLEANING, REPAIRING, AND PAINTING, &c.

It is usually calculated that a lamplighter can light from 100 to 120 lamps in an hour, and extinguish the same number in an hour at sunrise. The contracts usually stipulate that the lighting shall begin half an hour before sunset, and finish half an hour after sunset; also, that the extinguishing shall begin half an hour before sunrise in the morning, and finish half an hour after. This of course makes the mean time of burning from sunset to sunrise. The cleaning can be done in the daytime by the same man who lights and extinguishes; and in fact it is scarcely fair to assume that a whole day's pay will be required for an hour's work at sunrise, an hour some time in the day cleaning his lamps and putting his apparatus in order, and another hour at night engaged in lighting. However, let us see what the lamp lighting should cost on this principle.

In parts of London where the lamps are very close together the lighter can manage 120 lamps, and his wages for seven days a week shall be taken at £50 a year. This amounts to 8s. 4d. a lamp. Supposing he only lights 100 lamps, the cost then would be exactly 10s. a lamp. But when public bodies are seeking to economise, it is quite evident that this is a higher price than they are justified in paying, and higher than they would be required to pay if, by any contrivance, the spare time of the lamplighters

can be utilised either in the service of the local authority, or by working for themselves.

The system has occasionally been tried in London of paying the lamp-lighters for this duty exclusively per score of lamps, and the following are the prices:—

	<i>s.</i>	<i>d.</i>
Payment per week for lighting 20 Lamps	1	0
Ditto for extinguishing	1	0
Ditto for cleaning	0	6
Total	2	6

per score per week, or £6 10s. per annum for 20 lamps, this being equal to 6s. 6d. per lamp. This is believed to be about the proper cost of the service when done with ladders, and without the aid of the lighting rod, which will be described hereafter, and which enables the lamplighter to manage a considerably increased number of lamps.

During the progress of the Metropolis Gas Inquiry, information was obtained from many towns as to the actual cost to them of this service when performed by their own servants. It was found that at Blackburn the whole cost to the town for lighting, extinguishing, painting, and repairing the lamps, which burn 2486 hours was 9s. 4d. per lamp per annum. At Huddersfield, the lighting, cleaning, and extinguishing are let at 8s. per lamp per annum, the lamps burning 3750 hours in the year.

With these examples before us it may safely be assumed that 10s. per lamp per annum is a very liberal price for the metropolis, where the lamps are closer together than in provincial towns. In the latter, again, the wages are usually lower than in London; so that 10s. a lamp should amply cover the cost of lighting, extinguishing, and cleaning, together with the small outlay required for the use of ladder, lantern to light with, &c. The only other item is the painting and repairing, and this is commonly let by contract in the metropolis at 3s. per lamp per annum, making the whole cost per lamp, exclusive of gas, 13s. per annum, where the posts and lanterns belong to the local authorities. The London gas companies, however, claim 15s. for this service; and as this is their own claim, they ought to deduct 15s. per lamp when the work is performed by servants of the local authority.

PAYMENT FOR THE USE OF THE LAMP POST, LANTERN, &c.

In London the lamps and posts usually belong to the local authority, together with the service pipe within the lamp post, the company laying the service pipe from their own main to the foot of the lamp post. The cost to the company of laying the service pipe complete to the lamp post is, on the average, about 15s. each, and this is really part of the company's distributing apparatus. The companies are bound to lay these service pipes by the provision of the Metropolis Gas Act, 1860, which requires that they shall lay service pipes to premises not lying further than 50 yards from existing mains.—(See sec. 14 of the Metropolis Gas Act, 1860.)

The usual price of lamps and posts complete in London is about £3 each; but in country towns the casting of the lamp post is much lighter, and frequently does not cost more than 30s.; hence the price may vary from 30s. to four and even five guineas in certain cases. Where the lamp is the property of the gas company, an addition by way of rent must be made to the price paid for each lamp per annum. This rent should be such as to pay about 7½ per cent., or 1s. 6d. in the pound, on the cost of the lamp post. Thus the rent for a lamp post costing £2 should not exceed 3s. a year; and this is a common rent in provincial towns for the use of the lamp post, lantern, lamp irons, &c. Collecting these items together, we have—

	Per Lamp per Annum.
	<i>s.</i>
	<i>d.</i>
Cost of lighting, extinguishing, and cleaning	10 0
Repairing and painting	3 0
	13 0
Extra for use of lamp post, lantern, &c., when these belong to gas company	3 0
	16 0

WHEN THE LAMPS ARE LIGHTED AND EXTINGUISHED BY THE LOCAL AUTHORITY, BUT SUPPLIED WITH GAS BY METER AT A PRICE PER 1000 FEET.

I have already said that all over Scotland, as well as in many Lancashire towns, the local authorities light their own lamps, and only pay the company for the gas consumed. This payment, however, is made on an arbitrary estimate of the quantity consumed, and no meters are employed to ascertain the quantity. The use of meters would doubtless be much more satisfactory to both parties, provided they could agree to be guided by the registration of a given number of meters, attached to a small proportion of the lamps. The system of ascertaining the consumption of the public lamps by means of meters has been adopted for some years in Leicester, Lincoln, St. Ives, Worthing, Torquay, Plymouth, and other places.

In St. Ives and Torquay the proportion of meters used is only one for every twelve lamps, while in the other places the proportion of meters is very much less than this: for instance, in Leicester only 1 lamp in 70 is supplied with a meter. Of course, in all cases the registration of the meters regulates the charge for all the lamps. It is interesting to note what has been the consumption indicated by meters in towns where they have been employed at the public lamps. I am informed by the secretary of the Plymouth Gas Company that the public lamps, when tried by meter for twelve months, consumed, on the average, 16,100 feet per annum, as compared with nearly 22,000 feet, which the London companies profess to give at 5 feet an hour, from sunset to sunrise, throughout the year.

The return from St. Ives by Mr. George Bower, the lessee of the works, shows that during September, October, November, and December, which contain 1713 dark hours, the lamps have burnt, on the average, 4100 feet of gas, which is equivalent to 10,301 for the whole year. The returns from Torquay are, however, the most complete. By the Tormoham Gas Act, which passed seven or eight years ago, the local authorities were entitled to have their gas for public lamps supplied by meter; and the Act distinctly specified that the consumption should be ascertained by a meter attached to every tenth lamp. The company and the local authorities, however, subsequently agreed to adopt only one meter to 12 lamps, and the system has been in use ever since 1855 with the following results:—

		Cubic Feet.
In 1856 the average registration of the meters was.....		12,575
In 1857 " " " "		12,895
In 1858 " " " "		13,709
In 1859 " " " "		13,475

In 1860, the supply of gas was defective, and the surveyor says the return would be useless.

The enormous saving which has been effected in all these cases holds out the most ample encouragement to local authorities everywhere to insist on this mode of supply to their public lamps.

Considerable attention has been drawn, of late years, in the metropolis, to the subject of the public lamps burning by meter; but the local authorities have generally been alarmed at the expense of fixing a meter to every lamp. The London companies, so far as I am aware, have refused to be bound by the indications of any smaller proportion of meters, and have insisted that if the public lamps burn by meter at all, a meter shall be fixed to every individual lamp. Having been engaged by several of the principal metropolitan parishes in the investigation of this subject, I have inquired very fully into all the various modes which have been proposed and adopted for attaching meters to public lamps. I am prepared, as the result of all this investigation, to recommend that in preference to the present system of paying on a perfectly indefinite and unreliable estimate, it would be far better even to put up with the expense of attaching a meter to every lamp. I do not for a moment say that any such extravagant outlay is necessary. On the contrary, to put a meter to every lamp is a measure which a local authority is only compelled to resort to as a protection against oppression, for it must be quite evident that 1 in 12 would be quite sufficient, and perfectly fair as between both sides.

The usual mode of attaching meters to public lamps has been to place them under the footway at the base of the lamp post. In this position they require to be enclosed in a cast iron case, and to be placed at a sufficient depth to be protected from injury by the ordinary street traffic. All the underground meters fixed in this way have been expensive. For instance, the meters in Torquay cost 34s. each, with an additional 26s. for the case and for fixing. Those in Leicester cost £4 10s. each, fixed complete, and the meters at St. Ives cost about £2 each. All these prices, however, are higher than that for which meters can now be supplied. I have tenders from some of the most eminent meter makers to supply meters in cast iron cases for 27s. each, and to fix them complete for 8s. extra, making in all 35s. for each underground meter fixed complete. I am inclined, however, to recommend the trial of an open air meter, to be secured by clips to the lamp post, and suspended from the lamp iron. The size of the meter I propose is only about 6in. by 4½in. wide, and 9in. deep. In the streets of London, and in many other towns, the lamp iron is parallel with the curb stone; and as the meter hangs on the lamp iron, it only appears from the footpath, or to persons travelling on the carriage way, as a small object, 4½in. wide; whilst, looking at it transversely from the centre of the street, its full width of 6in. appears. I think no objection could be taken to these meters by the most fastidious on the score of obstruction, as so small an object could not interfere with the architectural beauty of the finest street. The accompanying drawings (figs. 1 and 2) show a lamp post, with the meter attached; fig. 1 being the view from the centre of the carriage way opposite to the lamp post, in which position the broad side of the meter is seen; but even from this point of view the meter is no larger, and presents no more obstruction than the notice board frequently suspended on lamp posts to indicate the position of post-offices, &c.

Fig. 2 is the view of the meter as it appears to persons travelling either on the footpath or in the carriage way.

a is a regulator attached to the lamps, which will be more particularly described hereafter.

b is the meter suspended from the lamp iron, *c*.

d is the clip by which the meter is attached to the lamp post.

These meters can be supplied for 22s. each, with a guarantee to keep them in repair for five years, or for 24s. with a guarantee for ten years. They require no case or other enclosure, and all expense of opening the ground to place and detach is, of course, avoided.

Finally, it may be useful, as a guide to local authorities, and others who are desirous of using meters, and do not wish to incur the expense of purchasing them, to know the terms on which the London companies offer to supply meters by way of an annual rental. In one of the principal

Fig. 1.

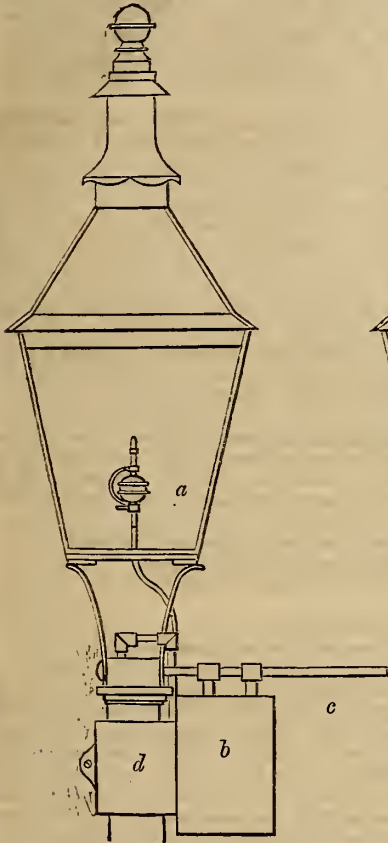
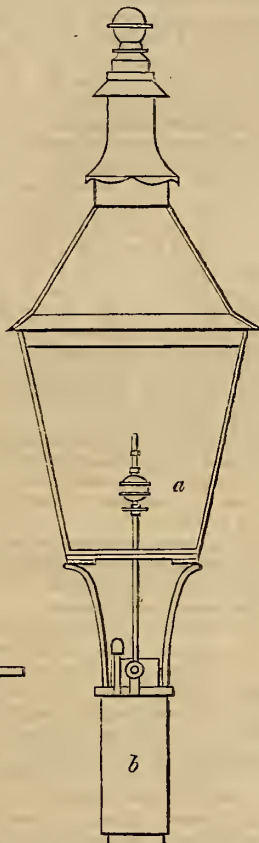

Fig. 2.



parishes of the metropolis, for which I was arranging the details of public lighting, the companies offered to fix and supply underground meters at a rental of 2s. 9d. each per annum—a price which seems to be based on a first cost of 27s. It is understood that the London companies consider themselves entitled to charge 10 per cent. on the first cost as rental for the use of meters; and it will be found that 2s. 9d. per annum is just over 10 per cent. on 27s.

Before leaving this subject of meters applied to public lamps, I take the opportunity of quoting some recent opinions expressed by a well known gas engineer, Mr. J. O. N. Rutter, of the Brighton and Hove Gas Works, in a pamphlet which he has lately published on the sale of gas to street lamps. Speaking of the present mode of contracting for a supply of gas without adopting any means of measuring the quantity, Mr. Rutter says:—

“The gas company has agreed to sell, and the public authorities have agreed to buy, say, five cubic feet per hour, in so many lamps, for a certain number of hours per night, varying according to the seasonal increase, and diminution of light and darkness.

“All this looks very plain, and easy, and intelligible. How is the quantity of gas to each lamp to be measured? By the eyes and hands of the lamplighter, who has to make such an adjustment at the stop-cock, as by experience he knows will be sufficient for the proper supply of the burner until he goes to it again in the morning.

“Is such adjustment practicable, so as to be in exact conformity with the terms of the contract? No. Gas companies know that it is utterly impossible, and public authorities know equally well, that it is utterly impossible to insure an uniform supply of gas to one-tenth part of the street lamps during the whole period between lighting and putting them out. This was known to all the parties concerned in the contract before it was entered into. It is one of the laws

which we are unable to alter, that gas of a given quality (specific gravity) will pass in equal quantities during equal periods of time through an aperture of a certain size, provided the pressure (force with which it is impelled) be uniform. If the rates of pressure be variable, the quantities of gas will also be variable.

“What is done to provide against this seeming difficulty, or to get over the actual impossibility? To make the best of it, the gas companies resort to what is called, although most improperly, an average rate of supply.”—Rutter *On the Sale of Gas*, p. 6: Parker & Son, London.

As to the necessity for immediate action on the part of the local authorities and ratepayers in the metropolis, Mr. Rutter has the following remark:—

“If those who represent the interests of so many of the metropolitan ratepayers are in real earnest about what they have undertaken—if the saving to be effected be only one-fourth of the sum they have stated it to be—the stake is too large to be any longer trifled with. The time now passing is surely too valuable to be wasted, either in much talking or much writing. There must be no slackening of pace, no going backwards. Let there be prompt and energetic action; all parties determining calmly to deliberate upon the topic whereon they differ, and heartily to co-operate in those about which they agree.

“In that way the supply of gas to street lamps would soon be settled; and settled on a basis which would be as intelligible as any other transaction between buyers and sellers.”—*Ibid.*, p. 14.

As the best mode of removing all complaints about the street lamps, and giving satisfaction to all parties, Mr. Rutter unhesitatingly recommends the meter system.

“It may now be advisable to attend a little to the inquiry. Are there any means of preventing complaints about the supply of gas to street lamps? This question can be promptly answered in the affirmative.

“The causes of the long existing complaints must be done away with. The complaints will then immediately cease.

“How is so great and so important a change to be effected? By making it compulsory that all gas supplied for street lamps shall be sold only by measure.

“No one who has thought about, or who knows but ever so little of, the present system, will deny that a change of some sort is necessary. On all sides, for years it has been confessed that the contract system is bad—as bad as anything can be—and wholly indefensible as being mixed up with a respectable branch of trade.

“The meter system, by long trial, has proved to be a good one. To the meter, gas lighting is indebted for its amazing progress, and for its great success. It has imparted to it a degree of vitality and of elasticity which is not known and cannot be understood, excepting by those who are old enough to remember the manifold evils of the contract system.

“The meter has done more in economizing the use, in cheapening the price, and extending the sale, of gas, than any other discovery, invention, or improvement, connected with the science of gas lighting, from its commencement to the present day.”—*Ibid.*, p. 18.

Mr. Rutter thus argues in favour of the public lamps burning by meter, and points out how simple and effective would be the application of the meter system.

“The case appears to be a very plain one, and would become so if left to the ordinary course of trade. It began wrong, and the wrong-doing has hung about it ever since. If the public authorities require gas to light the streets, they are, of course, the proper persons to purchase it; to ascertain that they receive the quantity they agree to pay for, and that it be carefully and economically used.

“How are these conditions to be complied with, whilst the gas is not measured, and its sole management is under the control of the servants of the gas companies? If the facts were not exactly as they are here described, it would seem an impossibility, or certainly an absurdity, that any plan could have been hit upon, and continued for so long a period, in every way so calculated to defeat the purposes of its originators.

“As respects a separate meter for each lamp, its cost, its adoption, its accessibility, and its security; these are matters which present only imaginary difficulties. If the difficulties were real, and greatly multiplied, they would be trifles in comparison with those which had to be grappled with when meters first began to be generally used by consumers of gas.

“The meters employed in supplying gas to street lamps, will have an advantage over those in use in private houses. They will work more uniformly, with fewer and shorter periods of interruption, and will, therefore, be likely to be more durable. All meters sustain greater injury by long and irregular intervals of rest than by keeping steadily at their work.”—*Ibid.*, p. 21.

As to the price which should be paid for gas supplied to the public lamps, Mr. Rutter is of opinion that this should be one-fourth less per 1000 feet than that paid by the private consumer.

“Returning to the price to be paid for gas to street lamps, let it again be noticed that the first, the most important, and the only real and beneficial change should be the total abandonment of the contract system. If meters be generally adopted (and the only certain way is by making it compulsory), the prices to be charged would never be an obstacle. Taking the (highest) rate of charge to private consumers, and the price to public authorities could be easily arranged at a reduction, probably, of one-fourth, more or less, according to circumstances.

“In the metropolis something must be done, and it ought to be done quickly: delay will be sure to evoke greater hostility. The sale and supply of gas, the rights of public authorities, and the rights of the companies, should be settled on so broad a basis that each party may know what they may do or require to be done, and also what they must refrain from doing. First of all, let the lighting of the streets be taken out of the control of the companies who sell, and passed over to the authorities who buy the gas.”—*Ibid.*, p. 36.

The following extract expresses an opinion that the gas companies could not reasonably object to the use of meters, and refers to the cost of attaching a meter to every lamp.

"The public authorities say that they pay for more gas than they receive, The companies say that more gas is supplied to street lamps than is set down in the contracts, and, consequently, more than they are paid for. *The remedy is close at hand—apply the meter test.* It is simple, could soon be brought into operation, and would immediately put an end to all disputing.

"After so many years' experience of the utility of meters, and having realized incalculable benefits from them, the companies could not, with any show of reason, object to their universal adoption.

"Is the cost of meters for street lamps likely to be made an objection? It scarcely merits serious consideration. Supposing the meters to be provided by the companies at a rent-charge, they would only be doing for large consumers what would be readily done, if circumstances required it, for a certain number of small ones. If the authorities purchased their own meters, the cost of them, with all the necessary fittings, would not equal the sum expended every year in repairing or renewing a few hundred yards of well-frequented road. Moreover, if the charges so often brought against gas companies be true, namely, that they fail in supplying the stipulated quantity of gas, the greater the necessity for adopting meters, and the sooner would they pay for themselves."—*Ibid.*, p. 37.

The importance of this subject, and its bearing on the public interests in all parts of the United Kingdom, must form my apology for making these long extracts from Mr. Rutter's pamphlet. I consider the evidence of this gentleman extremely valuable, because he must be viewed essentially as a champion of the gas companies, and unquestionably he writes with a marked and peculiar bias in their favour. Far from importing any hostile feeling into this question, which may be fairly discussed between gas companies and the public, without any but a desire to attain equitable results, it is very satisfactory to find the opinions of a close thinker and able gas financier like Mr. Rutter so highly conciliatory, and indicative of a desire that the companies should deal out justice in the matter of public lighting.

In the advice which Mr. Rutter gives to local authorities I fully concur, and can only hope that the liberal and enlightened opinions which he expresses may be universally adopted by the gas companies, in whose interest he writes, and whom, by association and habit, he is bound to serve and support.

(To be continued.)

UPON THE PRACTICAL RELATIVE ECONOMY OF USING STEAM WITH DIFFERENT MEASURES OF EXPANSION.

BY ALBAN C. STIMERS, CHIEF ENGINEER, U.S. NAVY.

(Continued from page 140.)

Manner of Making the Experiments.—The experiments were made with the starboard engine alone and with both boilers. The following are the quantities and the mode of obtaining them, which were ascertained by direct measurement or weights.

The number of double strokes made by the engine piston were registered by one of Rogers' engine counters.

The number of pounds of coal consumed, of ashes, clinker, and soot, forming the refuse from the coal, were accurately weighed on one of Fairbank's platform scales, quite new, and tested previous to its being used.

The steam pressure in the boilers was shown by one of Allen's spring gauges and by a mercurial syphon gauge, the two coinciding.

The vacuum in the condenser was denoted by one of Allen's spring vacuum gauges.

The steam pressure in the cylinder throughout the stroke of the piston was obtained by taking indicator diagrams hourly from each end of the cylinder with excellent instruments of the New York Novelty Iron Works manufacture. Those shown in the plate are fair samples of those taken during each experiment.

The pressure of the atmosphere was denoted by an aneroid barometer, which hung in the centre of the engine-room. This was used to determine in each case the back pressure in the cylinder.

The temperatures of the injection water, of the feed water in the tank, of the external atmosphere, and of the engine-room, were measured by thermometers of the ordinary description; that of the hotwell was shown by a large fixed thermometer having its bulb constantly immersed in the water in the interior of the well.

The feed water, before being pumped into the boilers, was first pumped into a wooden tank lined throughout with zinc, and as the hose through which the water was each time pumped into it and the pipe through which it was withdrawn by the feed pump passed over the top, there were no joints to cause leakage. In addition to this precaution against error, in measuring the amount of water evaporated, the tank was blocked up from the engine-room floor 3 ins.; so that if any leakage should occur from any cause, it would be immediately discovered. The internal dimensions of the tank were as follows:—length, 11½ ft., breadth, 1¾ ft., height, 3¾ ft. It was filled each time to a convenient mark which corresponded accurately with a capacity of 70 cubic feet. Great care was taken in making the

connections between this tank and the feed pump to shut off absolutely every other source from which the pump could be supplied, and to close all avenues of egress from the pump, except those which conducted the water to the boilers.

The boilers were fitted with the usual gauge cocks and with glass water gauges; these latter enabled the height of the water within to be noted with great exactness by tying a piece of small twine around the glass tube at the height of the water. When an experiment was commenced, the piece of twine was made to correspond exactly with the water level, which was brought again to the same level at the end of the experiment.

The water supplied to the boilers being fresh and almost absolutely pure, no blowing off was required; all the water, therefore, which was measured in the tank was available for making steam. Great care was taken before commencing the experiments to have all valves and cocks through which water or steam could leak from the boilers made absolutely tight, and afterwards a regular system of inspection was adopted that any new leak might be at once discovered. With regard to the boilers themselves, they were quite new, and, as far as could be ascertained by the most rigid scrutiny, were absolutely tight.

Each experiment lasted 72 consecutive hours, during which the engine was neither stopped, slowed down, nor in any way changed in condition. In commencing an experiment, the engine was operated for several hours to adjust it to the normal conditions required to be uniformly maintained during that experiment and to bring the fires to steady action. When all was ready, average fires and the proper steam pressure being in the boilers, the time and number of the engine counter were noted, and the experiment began. From this time up to the end of the 72 hours all the quantities were weighed or measured and noted hourly in a regular log, ruled with appropriate columns. As the end of the experiment approached, care was taken to bring the fires to the same state of cleanliness and to the same thickness which they had at the beginning. The means or totals then, as the case required, of the quantities entered in the log furnished, with the exception of the facts derived from the indicator diagrams, the data of that experiment.

Each of 144 diagrams taken during one experiment was carefully analysed and its results arranged in tabular form, so that the mean of the whole number was conveniently obtained by getting the mean of the whole number of quantities in each column of the table. The quantities thus found were—

- The pressure in the cylinder at the commencement of the stroke.
- The pressure in the cylinder at the point of cutting off.
- The final pressure at the end of the stroke of the piston.
- The mean back pressure.
- The mean gross effective pressure, and
- The fraction of the stroke completed when the steam was cut off.

At the close of the experiments, the pressure on the piston required to operate the engine *per se* was obtained by removing all the paddles from the wheels and running the engines, taking indicator diagrams to get the pressure. Of course the arms of the paddle wheels acted, to a certain extent, propulsively upon the water, and to eliminate this quantity the engine was run at various speeds, ranging from 8 to 22 double strokes per minute, and taking several sets of diagrams for each rate of speed to get a reliable mean. Now, the resistance to the passage of the paddle wheel arms through the water was variable and required an increased piston pressure with each increase in the speed, while the piston pressure required to overcome the friction of the engine would be constant for all speeds. By eliminating, then, the variable quantity, the constant quantity remaining would be the correct pressure required solely for overcoming the friction.

This was found to be 2.1 lbs per square inch.

In reporting the experiments, the Board made out two tables containing all the data and results observed and calculated, embracing only those trials in which all the conditions from beginning to end were such as could satisfy the most hypercritical, and moreover they are those which give the highest results to the greater measures of expansion. The first table contains the exact experimental determinations under the conditions noted, and is made out in great detail. The second contains the results detailed in the first, but calculated only for weight of steam used in rapport of power developed, and corrected for equality of back pressure against the piston, which equality they did not obtain in the experiments, but which it is necessary to adopt in order to show the *true* relative economy of the different measures of expansion employed; for whatever absence of back pressure can be obtained in one case can in any other. The second table of the Report contains, therefore, all that is really essential to a correct understanding of the results obtained by the experiments, and is the only one of the two given in this paper.

EXPLANATION OF THE TABLE.

For facility of reference, the quantities are arranged in groups, and the lines containing them numbered.

Line 4 contains the corrected back-pressure above zero, in pounds per sq. in. against the piston during its stroke. The quantity 2.7 pounds was

adopted for this purpose, because it is the least given during the experiments, and as with equal initial cylinder pressures the results are more unfavourably affected by back-pressure as the steam is used more expansively, it was deemed proper to accept the least practicable. The average with steam engines under the conditions of ordinary practice is about 4 pounds, which, if adopted, would make the economic results much less favourable to the greater measures of expansion.

Lines 5 and 7 have been corrected from the experimental determinations to what they would have been, had the back-pressure been uniformly 2·7 pounds.

Lines 9, 10, and 11 contain, respectively, the gross effective, the total, and the net indicated horse power developed by the engine when using the pressures given on lines 5, 18, and 7, and having a speed of piston corresponding to those given on line 15.

Lines 12, 13, and 14 contain, respectively, the number of pounds of feed-water consumed per hour to produce the gross effective, total, and net indicated horse power, as given before.

Line 17 contains the mean total pressure, or pressure above zero on the

piston, in pounds per square inch, that should exist according to the law of Mariotte. It is calculated for the experimental conditions of the steam comprised in the clearance and cylinder nozzles, and of the cylinder pressures at the beginning of the stroke, and at the point of cutting off the steam (lines 1 and 2). By comparing the quantities on this line with those on line 18, which are the mean total pressures on the piston as shown by the indicator, a remarkable coincidence will be found. That it is only a coincidence, is evident when it is remembered that, in order that the one should be a consequence of the other, it would be necessary that neither condensation, from any cause, nor re-evaporation should have occurred in the cylinder, from the point of cutting off to the end of the stroke of the piston, and that the steam should have expanded precisely in the inverse ratio of the spaces occupied.

Line 19 exhibits, comparatively, the economic result that should have been obtained with the different measures of expansion used for the steam, according to Mariotte's law. The calculation is made for the total horse power developed, and for the conditions which were obtained in the experiments, with the exception, only, that the steam is supposed to follow this

TABLE CONTAINING THE RESULTS OF THE EXPERIMENTS CALCULATED FOR EQUALITY OF BACK PRESSURE AGAINST THE PISTON, AND SHOWING THE TRUE RELATIVE ECONOMY OF USING STEAM WITH DIFFERENT MEASURES OF EXPANSION.

		FRACTION OF STROKE COMPLETED WHEN STEAM WAS CUT OFF.							
		$\frac{11}{12}$	$\frac{7}{10}$	$\frac{4}{9}$	$\frac{3}{10}$	$\frac{1}{4}$	$\frac{1}{6}$	$\frac{4}{45}$	
1 2 3 4 5 6 7 8	STEAM PRESSURE IN CYLINDER PER INDICATOR.	In pounds per sq. in. above zero at beginning of stroke of piston	34·8	33·3	34·5	34·4	34·3	34·2	34·7
		" " " at point of cutting off the steam	32·2	31·4	33·0	33·4	33·3	33·2	33·0
		" " " at end of stroke of piston	29·3	22·2	15·7	11·0	9·7	7·8	5·9
		" " " against piston during the stroke	2·7	2·7	2·7	2·7	2·7	2·7	2·7
		Mean gross effective pressure in pounds per sq. in. on piston during its stroke	31·3	28·4	24·4	20·2	17·4	13·7	9·8
		Pressure in pounds per sq. in. on piston required to work the engine, <i>per se</i>	2·1	2·1	2·1	2·1	2·1	2·1	2·1
		Mean net effective pressure in pounds per sq. in. of piston	29·2	26·3	22·3	18·1	15·3	11·6	7·7
		Per cent. which the mean net effective pressure is of the total pressure	85·9	84·6	82·3	79·0	76·1	70·7	61·6
9 10 11	POWER ABSO- LUTE.	Gross effective horse power developed by the engine	316·604	216·905	206·966	135·727	118·434	75·095	67·821
		Total horse power developed by the engine	343·915	237·527	229·868	153·869	136·812	89·895	86·506
		Net horse power usefully applied	295·362	200·867	189·153	121·617	104·140	63·584	53·288
12 13 14	POWER ECONO- MIC.	Pounds of steam consumed per hour per gross effective horse power	38·029	33·817	32·671	34·681	34·472	36·769	41·382
		" " " total " "	35·008	30·881	29·416	30·592	29·841	30·715	32·044
		" " " net " "	40·763	36·561	35·748	38·705	39·202	43·425	52·669
15		Speed of the piston in feet per minute	329·744	248·967	276·512	219·040	221·888	178·688	225·600
16 17 18 19 20 21 22 23	COMPARATIVE.	Comparative bulks of steam withdrawn from the boilers in equal times ...	1·000	0·609	0·561	0·391	0·339	0·229	0·233
		Mean total pressure on piston in pounds per sq. inch, by Mariotte's law	34·5	31·3	27·6	23·2	21·2	17·2	12·6
		" " " by experiment	34·0	31·1	27·1	22·9	20·1	16·4	12·5
		Comparative economic result, by Mariotte's law, for the total horse power ...	1·000	0·835	0·660	0·568	0·532	0·475	0·422
		" " " by experiment, for the gross effect. "	1·000	0·889	0·855	0·912	0·906	0·967	1·088
		" " " total " "	1·000	0·882	0·840	0·874	0·852	0·877	0·915
		" " " net " "	1·000	0·896	0·877	0·949	0·962	1·065	1·292
Comparative capacity of cylinder required to develop equal net horse power	1·000	1·110	1·309	1·613	1·909	2·517	3·792		
24 25	CONDENSA- TION.	Weight of steam condensed in the cylinder due to the heat annihilated in producing the total power, according to Joule's equivalent; expressed per cent. of the feed-water	7·80	8·74	9·04	8·59	8·77	8·45	7·94
		Discrepancy between the tank and indicator measurements of the feed-water; expressed in per cent. of the latter	2·91	6·60	18·14	33·07	30·84	33·66	37·16

law, agreeably to the general belief among engineers. In order to ascertain how nearly the steam comes up to the assumed law, in the ordinary steam engine cylinder, it is only necessary to compare the quantities in this line with those on line 21, which show the comparative cost of obtaining a given total horse power, with the different measures of expansion employed, as determined by the experiments.

It is plain from these figures that the law of Mariotte cannot be employed to determine, even approximately, the economy of any engine which is using the steam expansively to any extent; although, in calculations for simply determining the power, it appears to be as safe a reliance as has all along been supposed by the most firm believer in its applicability to steam when expanding in an engine cylinder. Indeed, engineers were in the habit of making this comparison, which is readily done from the indicator diagram itself when the clearance is known, and it was one of the evidences which satisfied the mind that there was no danger of making any material error in taking the diagram as an exponent of the economy of the engine. Any difficulty in getting the expected economy from large measures of expansion always appeared to be that the boilers failed to evaporate the proper amount of water per pound of coal, and either they or the coal itself were condemned as not being equal to expectation: the guilty engine not being even suspected.

Line 22 gives, comparatively, the cost in fuel of a given useful effect produced by the engine, and determines, *per se*, the practical relative economy with regard to fuel alone, of using steam with the different measures of expansion employed. To determine however the propriety of designing an engine with the view of using the most economical measure of expansion employed in the experiments, it is necessary to consider, in connection with this, the quantities on line 23, which show the comparative capacity of cylinder required to produce, *ceteris paribus*, a given power with the net effective pressures given on line 7. The weight, space occupied, and first cost of steam engines proper, decrease in a more rapid ratio than the capacities of their cylinders. It is, therefore, perfectly safe to assume that these quantities vary with those on line 23, and, when this is done, an estimate, however roughly approximative, points inevitably to the fraction of $\frac{7}{10}$ as being the most economical one for cutting off steam.

Lines 24 and 25 exhibit the difference, due to all causes, between the weight of feed-water pumped into the boilers, according to the tank, and the weight of steam discharged from the cylinder into the condenser at the end of the stroke of the piston, per indicator, expressed in per centums of the feed-water. Line 24 shows that part of it which is condensed in consequence of the heat annihilated in the cylinder to produce the total

power developed by the engine, according to Joule's equivalent of one pound of water raised one degree of temperature on Fahrenheit's scale for every 772 foot-pounds developed by the engine; which would make the thermal equivalent of one indicated horse power $\left(\frac{33000}{772}\right) = 42.7461$ lbs. of water raised one degree Fahrenheit.

To make the calculation, let k = the number of total indicated horse power (line 10) developed by the engine; e = the total heat of steam of the pressure at the end of the stroke of the piston (line 3), in degrees Fahr. according to Regnault; g = the temperature in degrees Fahr. of the same steam; and t = the time in minutes ($60 \times 72 = 4320$) during which the power, k , acted: then $\frac{k \times 42.7461 \times t}{e - g}$ = the number of pounds of steam condensed from this cause during one experiment. The per centum which this total quantity is of the total quantity pumped into the boilers during the experiment is then obtained for the quantities on line 24.

The causes of the remaining differences, given on line 25, may be numerous. If the boilers lose water by leakage, by priming, or by passing it over to the cylinder in the vesicular state, the quantity thus lost will be included. If the cylinder valves or the piston leak steam to the condenser, the quantity thus leaked will be included. If the steam be condensed in the steam-pipe, valve-chests, or cylinder, from any causes other than the production of the power, and if a portion of the water formed by this condensation be re-evaporated in the cylinder, then the difference of the weight condensed and re-evaporated will be included. By taking these quantities into consideration when comparing the economic results for total powers that should have been obtained according to the law of Mariotte (line 19) with those obtained by experiment (line 21), a very clear idea will be had of the great antagonistic cause that neutralises and reverses the economy promised by the purely abstract conditions on which that law is founded.

DISCUSSION OF THE RESULTS.

The Initial Pressure.—In examining the preceding table, it will be observed that particular care was taken to maintain the initial cylinder pressure (line 1) the same in all the experiments as nearly as practicable. That this is a proper condition for the purpose of the experiments will be obvious when it is considered that degree of pressure is purely a question of boiler, and not at all one of engine. It is just as feasible to carry a high pressure and cut off the steam at $\frac{7}{10}$ of the stroke of the piston, as it is when cutting off at $\frac{1}{10}$, if the cylinder of the engine be of the proper dimensions. In considering subjects of this nature, it is very important that they be properly analysed, so that but one element is determined at a time. To give the larger measures of expansion the benefit which is due to a higher pressure of steam is not the way to ascertain how much benefit there is to be derived from expansion *per se*,—the object of these experiments.

It is however very useful to know the relative economy of developing, in the same engine, the same power with different measures of expansion; the greater measures having a correspondingly higher initial pressure in the cylinder, so that equal mean net pressures are exerted upon the piston during its stroke. The principal gain in using a higher pressure of steam in the cylinder of a steam engine is to reduce the per centum of loss by the sum of the back and friction pressures; but when comparing results from total pressures alone, this element could not of course enter into consideration. Now, if we have with the different measures of expansion, different initial pressures, such as the *net* pressures are equal, we shall have also equal total pressures; as the back and friction pressures are constant quantities, and as, leaving out of consideration the slight increase of dynamic effect due to increased temperature in the higher pressures, any numbers which express the comparative economy of different measures of expansion in rapport of total power are independent of the initial pressure of the steam; they express also the comparative economy of the same measures of expansion in rapport of net power, when equal mean pressures are maintained during the different degrees of expansion. The numbers, therefore, in line 21 express the comparative economy of the different measures of expansion employed in the experiments when the same engine is used to exert the same power, but with increased initial pressure with each increase in the degree of expansion.

Modification of Power.—The economic efficiency of any given engine is greatest when using its maximum mean total pressure; because then it has both the advantages of the greater dilatation due to the higher temperatures and the greater proportion of net to total pressure. In most applications of the steam engine, however, it is necessary to sometimes use considerably less than the maximum power, and it becomes a question of considerable importance to know how to do it with the least loss of economical efficiency. There are three modes in common use for reducing the power of the engine below the maximum, as follows:—1st, by reducing the boiler pressure; 2nd, by partially closing the throttle valve and maintaining the same boiler pressure; and 3rd, by suppressing the steam at

an earlier portion of the stroke by means of an adjustable cut-off and maintaining the same boiler pressure.

The impression obtains very generally among engineers, that the second of these plans is a decided improvement upon the first, and that the third is a still more decided improvement upon the second.

The first method reduces the mean pressure without any change whatever in the degree of expansion. The third does it entirely by increasing the measure of expansion, and the second may be said to be a compromise between the other two methods. Now, it happens, fortunately, that the foregoing table furnishes all the necessary experimental quantities required for determining the relative economy of the first and third methods, and as the second falls between these two, it will hereafter be seen that it is not important to know its exact economy.

The first three and the fifth lines in the following table are taken from the foregoing general table. Line 1 represents the total pressures, line 2 the net pressures, and line 3 the per centum which the latter are of the former. These last quantities represent the relative net power, that would be obtained per unit of weight of fuel when using the steam with the same measure of expansion, but with the different net pressures on line 2; and by dividing unity by each of them we obtain a new set of quantities, that show the relative cost in fuel of the unit of net power. Then, calling the one unity which falls into the column headed $\frac{7}{10}$ (that being the point recommended for permanently cutting off the steam), we obtain the proportional quantities on line 4, which represent the comparative cost of the power when maintaining the same degree of expansion, and changing the net pressures to those found in the other columns on line 2 by varying the boiler pressure.

The quantities on line 5 are those on line 22 of the general table, but arranged for unity in the column headed $\frac{7}{10}$, instead of that headed $\frac{1}{10}$, and show the comparative economy of changing the net pressures to those found in the other columns on line 2 by retaining the same initial pressure and varying the measure of expansion.

The differences between the respective quantities on these two lines are given on line 6, and represent the per centum of loss or gain experienced by avoiding a complicated piece of mechanism, and reducing the power by merely reducing the boiler pressure without the assistance of any mechanism whatever.

FRACTION OF THE STROKE COMPLETED WHEN THE STEAM WAS CUT-OFF.

	$\frac{11}{12}$	$\frac{7}{10}$	$\frac{4}{9}$	$\frac{3}{10}$	$\frac{1}{4}$	$\frac{1}{6}$	$\frac{4}{45}$
1	34.0	31.1	27.1	22.9	20.1	16.4	12.5
2	29.2	26.3	22.3	18.1	15.3	11.6	7.7
3	85.9	84.6	82.3	79.0	76.1	70.7	61.6
4	0.985	1.000	1.027	1.061	1.111	1.196	1.373
5	1.116	1.000	0.978	1.059	1.073	1.188	1.442
6	Gain, 13.1		Loss, 4.9	Loss, 0.2	Loss, 3.8	Loss, 0.8	Gain, 6.9

It will readily be perceived that for greater measures of expansion than that obtained by cutting off at $\frac{7}{10}$, there is really no practical difference in the economy of the two methods; and as the use of the throttle valve, the most convenient of the three plans, comes between the other two in its economic efficiency, it may be considered as neither more nor less economical than the adjustable cut-off, but has the decided advantage of being extremely simple in its construction and convenient to manage.

Loss by Clearance in the Cylinder.—There is a loss of useful effect in every steam engine by being required to fill the clearance at every stroke; and the per centum of this loss is different with different measures of expansion. An examination of the subject will tend to explain in part why we do not obtain in practice the whole benefit promised by the theory of expansion.

When the engine is working full stroke, the per centum of loss is exactly equal to that which the amount of space comprised in the clearance is of the whole space filled with steam per stroke. In the case of using steam expansively, however, this ratio is modified; a part of the steam in the clearance producing a dynamic effect during expansion, and on the other hand, the space comprised in the clearance being constant, the shorter the steam is cut off the greater becomes the ratio which this space bears to that filled with steam before the valve closes.

To ascertain the per centum of loss experienced from this cause, it is necessary to imagine an engine running without any clearance whatever, and to compare its economy with that experimented upon. The results of such a comparison are given in the following table. Line 1 contains the effective pressures in pounds per square inch on the piston according to the law of Mariotte under the experimental conditions. Line 2 contains what would have been the net effective pressures according to the same law had there been no clearance and had the same amount of steam

been admitted to the cylinder per stroke; in which case the measures of expansion would have been correspondingly lessened. Line 3 contains the difference between the quantities on lines 1 and 2. Line 4 contains the per centums which the quantities on line 3 are of those on line 2.

FRACTION OF THE STROKE COMPLETED WHEN THE STEAM WAS CUT-OFF.

	$\frac{11}{12}$	$\frac{7}{10}$	$\frac{4}{9}$	$\frac{3}{10}$	$\frac{1}{4}$	$\frac{1}{6}$	$\frac{4}{45}$
1	29.7	26.5	22.8	18.3	16.4	12.4	7.8
2	29.9	26.9	23.9	19.8	17.8	14.1	9.1
3	0.2	0.4	1.1	1.5	1.4	1.7	1.3
4	0.07	1.49	4.60	7.58	7.86	12.06	14.29

An inspection of line 4 of the above table will show how rapidly the loss due to clearance increases with the measure of expansion.

Condensation in the Cylinder.—A comparison of the quantities on line 25 of the general table, will give at once a correct impression of the principal cause why we do not obtain in practice any approach to the gain promised by the theory when using steam expansively. The discrepancy between the indicator and tank measurements of the water evaporated, it will be observed, is very small, only 2.91 per centum, when cutting off at $\frac{11}{12}$, but rapidly increases to the enormous amount of 33.07 per centum, when cutting off at $\frac{1}{10}$, and this is considered as using expansion very moderately. In the 2.91 per centum is included every kind of leakage, and the condensation due to radiation of heat from the steam-pipe, steam chests, and cylinder; and as the loss from these causes was necessarily constant during all the experiments, it was evidently too small to be considered. Condensation within the cylinder, due to the varying temperature and pressures occurring therein at every stroke of the piston, is the only explanation which can be given; and the only accepted law of physics which could cause the condensation, requires that the surfaces with which the inflowing steam comes in contact, should be cooler than itself; the condensation taking place upon those surfaces.

The surfaces of the cylinder are cooled down below the temperature of the steam of initial pressure, partly by being in contact during a portion of each double stroke of the piston with vapour of less temperature, than that to which they have been raised by the steam of initial pressure; but if we consider the slowness with which steam already formed receives additional heat, and the small amount required to elevate the temperature of that in immediate contact with the surfaces to equilibrium, it will become evident to us that this cause is hardly worth considering.

There is, however, a powerful cooling influence, entirely independent of the varying temperatures, and dependent only upon the varying pressures. It is that of evaporation from the surfaces. Let us suppose that the engine is running full stroke, and that when the steam enters the cylinder at the commencement of the stroke, the surfaces with which it comes in contact are slightly cooler than itself; condensation of a portion of the steam upon those surfaces is the only manner in which the metal can be heated to an equilibrium by the steam. They become therefore immediately covered with a dew-like film of water. This water retains the same temperature as that of the steam with which it is in contact, and which it would itself have shown before its condensation, the latent heat only of the vapour condensed, entering the metal of the cylinder. Further, when the piston commences to move, it exposes to contact with the steam, the concave surface of the cylinder which had just previously been exposed to the lower pressure and temperature on the other side, and condensation takes place upon this surface as it is uncovered by the piston throughout the stroke, so that when the piston has arrived at the end of the stroke, and the cylinder is full of steam of initial pressure and temperature, its whole interior surface is covered with a thin film of water at exactly the boiling point due to that pressure. When the exhaust valve opens and the pressure falls to that of the back pressure, the temperature necessary for water to boil, falls with it. In the case of the experiments, the temperature of the water condensed under the pressure of the entering steam, was 120° Fahr. higher than the boiling point of water under the back pressure. This water therefore immediately evaporates, converting into the latent heat of the vapour formed, not only the surplus temperature contained within itself, but also that which had been imparted to the metal of the cylinder at the time of its condensation. In this case all the heat thus robbed from the cylinder, and which must be returned to it by a new condensation at the next stroke, goes off to the condenser and is a total loss.

In the case however of using steam expansively, this is modified; for, as soon as the cut-off valve has closed, the pressure commences to fall, and, although condensation upon the surfaces continually exposed by the piston still goes on, as in the case of maintaining the initial pressure to the end of the stroke, the water which had been condensed under the higher pressure commences to evaporate as soon as this pressure commences to fall; and this re-evaporation goes on throughout the remainder of the stroke of

the piston, so that the whole interior of the cylinder upon the steam side of the piston is being cooled down by evaporation from its surfaces, from the moment the cut-off valve is closed until the steam is again admitted to that side of the piston. The steam resulting from this re-evaporation before the end of the stroke is, of course, measured by the indicator, and is not accounted for by the quantities on line 25 of the table; and as during that portion of the stroke which was made by the piston while each particle existed in the form of water, such particle did not exert any dynamic force; the loss in dynamic effect due to condensation within the cylinder is greater than is measured by its amount as given in the table; but not so great as is due to the total quantity therein condensed, which quantity was not determined by these experiments.

STRENGTH OF MATERIALS.

DEDUCED FROM THE LATEST EXPERIMENTS OF BARLOW, BUCHANAN, FAIRBAIRN, HODGKINSON, STEPHENSON, MAJOR WADE, U.S. ORDNANCE CORPS, AND OTHERS.

By CHARLES H. HASWELL, Civil and Marine Engineer.

No. 1.—ELASTICITY AND STRENGTH.

The component parts of a rigid body adhere to each other with a force which is termed *Cohesion*.

Elasticity is the resistance which a body opposes to a change of form.

Strength is the resistance which a body opposes to a permanent separation of its parts.

Elasticity and *Strength*, according to the manner in which a force is exerted upon a body, are distinguished as—

1. *Tensile Strength*, or absolute resistance.
2. *Transverse Strength*, or resistance to flexure.
3. *Crushing Strength*, or resistance to compression.
4. *Torsional Strength*, or resistance to torsion.
5. *Detrusive Strength*, or resistance to shearing.

Modulus of Elasticity.

The *Modulus* or *Co-efficient of the Elasticity* of any substance is a column of the same substance, capable of producing a pressure on its base, which is to the weight causing a certain degree of compression, as the length of the substance is to the diminution of its length; or it is the measure of the elastic reaction or force of any substance.

To ascertain the *Extension or Compression in the Length or Height of a Body.*

$$Q l = E;$$

Q representing the quantity of a prism of any substance lin. square, and 1ft. in length, would be extended or diminished by a force or weight *f*; and *l* any other length of a prism of like section and substance.

To ascertain the *Modulus of Elasticity.*

RULE.—As the extension or compression of the length of any substance is to its length, so is the weight that produced that extension or compression to the result required.

Or,
$$\frac{f}{Q} = M;$$

M representing the weight of the modulus in pounds, for a section or base lin. square.

If W is the weight of the prism of lin. square and 1ft. in length,

Then,
$$\frac{f}{W Q} = H;$$

H representing the height of the modulus of elasticity in feet.

To ascertain the *weight which a given column, nearly perpendicular, is capable of supporting, omitting the effect of the weight of the column itself:—*

$$.8225 \frac{d^2}{l^2} H = W;$$

d representing the side of the column.

Illustration.—A column of pine, assuming the height of its modulus to be 9,000,000ft., lin. square, and 5ft. in length, may begin to bend with the weight of a like column, equal in length to

$$.8225 \times \frac{1^2}{(5 \times 12)^2} \times 9,000,000 = 2056 \text{ feet,}$$

or, with a weight of (2056 × .02 × 12, the product of the length and the weight of 12in.) 493.44 lbs., omitting the weight of the column itself.

The *Weight of the Modulus of Elasticity* of a horizontal bar fixed at one end is to a weight suspended from its extremity, as four times the cube of the length, to the product of the square of the depth and the depression.

The Height of the Modulus of Elasticity of a bar, supported at both ends, is $\sqrt[4]{156}$ of the fourth power of its length, divided by the product of the depression and the square of the depth.

The weight under which a vertical column or bar not fixed at its base may begin to bend, is to a weight laid on the middle of the same bar, when supported at its ends in a horizontal position, nearly in the ratio of $\cdot 002$ of the length to the depression.

MODULUS OF HEIGHT OF ELASTICITY OF VARIOUS SUBSTANCES, AND THE PORTION OF IT, WHICH, IF APPLIED LENGTHWISE TO THEM, WOULD PULL THEM ASUNDER.

SUBSTANCES.	Feet.	Height of the prism which would be severed by its own weight.	Proportion of Height of Cohesion to Elasticity.
Ash	4,617,000	42,080	109 th
Beech	4,180,000	38,940	107
Brass—Yellow	4,940,000	5,180	954
Brick	...	{ 970	...
Cane	1,400,000	{ 144	...
Cork	3,300
Copper—Cast	...	5,000	...
Deal	8,118,000	55,500	146
Elm	5,680,000	39,050	146
Fir	8,292,000	40,500	205
Glass	4,440,000
Gun Metal	2,790,000
Hempen Fibres	5,000,000
ditto Twine	...	75,000	...
Iron—Cast	5,750,000	6,110	941
ditto Wrought, Swedish	9,000,000	19,740	456
ditto ditto English	7,550,000	16,938	446
Ice	6,000,000	300	20,000
Limestone	2,400,000
ditto	1,600,000
ditto	625,000
Lignum Vitæ	1,850,000
Larch	5,096,000	42,160	121
Lance Wood	5,100,000
Lead—Cast	...	348	...
Mahogany	7,500,000
Marble—White	2,150,000	1,542	1,394
Oak	4,150,000	32,900	144
Rosewood	3,600,000
Slate	7,800,000	7,300	1,068
Steel—Cast	9,300,000	39,455	235
Stone—Portland	1,570,000	945	1,789
Tanned Cow's Skin	...	10,250	...
Teak	6,040,000	36,049	168
Tiu—Cast	...	1,496	...
Whalcbone	1,000,000	14,000	71
Willow	6,200,000
Writing Paper	...	8,000	...
Yellow Pine	9,150,000
ditto	11,840,000

MODULUS OF WEIGHT OF ELASTICITY OF VARIOUS SUBSTANCES.

SUBSTANCES.	Weight in lbs.	SUBSTANCES.	Weight in lbs.
Ash	1,525,000	Cast Iron	{ 13,000,000
Oak	1,713,600		{ 17,000,000
ditto—American	1,958,700	Steel Wire	29,500,000
Yellow Pine	1,856,400	Steel Plates	42,600,000
Pitch ditto	1,252,000	Spruce	1,244,000
Red ditto	2,142,000	Zinc	13,680,000
Bar Iron	23,400,000	Brass	8,930,000
Wire	28,081,000	Lead	720,000
Beech	1,316,000	Gun Metal	9,873,000
Mahogany—Spanish	1,255,000		

Tensile Strength.

Tensile Strength is the resistance of the fibres or particles of a body to separation. It is therefore proportional to the number of fibres or particles in the body, or to the area of its transverse section.

The Absolute Strength of materials, pulled lengthwise, is in proportion to the squares of their diameters.

TABLE OF THE TENSILE STRENGTH OF MATERIALS.
Power required to tear asunder 1 Square Inch in Avoirdupois Pounds.

METALS.	lbs.	WOODS—continued.	lbs.
Copper—Wrought	34,000	Oak—English	10,000
Cast, American	24,250	Seasoned	13,600
Wire	61,200	Riga	12,000
Bolt	36,800	African	14,500
Gold—Cast	20,000	Pine—Pitch (Fir)	12,000
Iron—Cast, Low Moor	14,076	Norway	13,000
Clyde, No. 1	16,125	American, white	11,800
No. 3	23,468	Poplar	7,000
Calder, No. 1	13,735	Quince	6,000
Stirling, mean	25,764	Sycamore	13,000
Mean of American, by Maj. Wade	31,829	Teak—Java	14,000
Greenwood, Americ.	45,970	Africa	17,000
Gun Metal, mean	30,232	Walnut	7,800
Wire	103,000	Willow	13,000
Best Bar, Swedish	72,000	COMPOSITIONS.	
Russian Bar	59,500	Gold 5, Copper 1	50,000
English Bar	56,000	Brass	42,000
Rivets, American	53,300	Yellow	18,000
Mean by Telford	65,520	Bronze—least	17,698
Brunei	68,992	greatest	56,788
Barlow	56,560	Copper 10, Tin 1	32,000
English Rivets	65,000	9, 1	17,250
Crank Shaft	44,750	8, 1gun metal	30,000
Turnings	55,800	Copper 8, Tin 1, small bars	50,000
Scrap	53,400	Yellow Metal	48,000
Plates, boiler	51,000	Silver 5, Copper 1	48,000
lengthwise	53,800	4, Tin 1	41,000
crosswise	48,800	Tin 10, Antimony 1	11,000
ship	44,000	10, Zinc 1	12,914
lengthwise	47,600	10, Lead 1	6,800
crosswise	40,600	MISCELLANEOUS SUBSTANCES.	
Inferior Bar	30,000	Brick, well burned	750
Lead, Cast	1,800	inferior	290
Milled	3,320	Chalk	118
Wire	2,580	Cement—Portland, 6 mos.	414
Platinum—Wire	53,000	7 "	400
Silver—Cast	40,000	Glass—Plate	9,400
Steel—Cast, maximum	142,000	Flint	4,200
Blistered soft	{ 133,000	Green	4,800
	{ 104,000	Crown	6,000
Shear	118,000	Hemp Fibres	6,400
Blister	104,000	glued together	9,200
Spring	72,500	twisted, 1/4 to 1 in. dia.	8,746
Puddled	67,200	1 to 3 "	6,800
Plates, lengthwise	96,300	3 to 5 "	5,345
crosswise	73,700	5 to 7 "	4,860
Razor	150,000	Ivory	16,000
Tiu—Cast block	5,000	Marble—White	9,000
Banca	2,122	Italian	5,200
Zinc—Cast	3,500	Rope—Manilla	3,200
Sheet	16,000	Wire	37,000
WOODS.		Hemp	6,400
Ash	{ 12,000	Mortar, 20 years	52
	{ 16,000	Plaster of Paris	72
Beech	11,500	Slate	12,000
Box	20,000	Sandstone, fine grain	200
Bay	14,000	Stone, Portland	{ 857
Cedar	11,400		{ 1,000
Chestnut—Sweet	10,500	Hales	360
Cypress	6,000	Craigleith	400
Deal—Christiania	12,400	Bath	352
Elm	13,400	Cement—Sheppy	24
Lance Wood	23,000	Harwich	30
Lignum Vitæ	11,800	Chalk 4, Blue	70
Locust	20,500	Clay 5	
Mahogany	21,000	Portland 1, Sand 3	380
Spanish	12,000	Whaleboue	7,600
Maple	10,500		
Oak—American, white	11,500		

Hemp ropes, 1 ton per lb. weight per fathom.
Wire ropes, 2 tons per lb. weight per fathom.
Cast Iron (Greenwood), at three successive meltings, gave tenacities of 21,300, 30,100 and 35,700 lbs.

Bronze (gun metal) varies in tenacity from 23,000 to 54,500 lbs.
The fibres of woods are strongest nearest the centre of the trunk or limb of the tree.

Experiments on cast iron bars give a tensile strength of from 4000 lbs. to 5000 lbs. per square inch of its section, as just sufficient to balance the elasticity of the metal; and as a bar of it is extended one five thousand

five hundredth part of its length for every ton of direct strain per square inch of its section, it is deduced that its elasticity is fully excited when it is extended less than the three thousandth part of its length.

The mean tensile strength, then, of cast iron being from 16,000 lbs. to 20,000 lbs., the value of it, when subjected to a tensile strain, may be safely estimated at from one-fourth to one-third of this, or of its breaking strain.

A bar of cast iron will contract or expand '000006173, or the 162,000ths of its length for each degree of heat; and assuming the extreme range of the temperature in this country, between the shade in winter and the sun's rays in summer, in the Middle States, to be 140° (- 20° + 120), it will contract or expand with this change '0008542, or the 1157ths of its length.

It follows, then, that as 2240 lbs. will extend a bar the 5500th part of its length, the contraction or extension for the 1157th part will be equivalent to a force of 10,645ths (4.75 tons) per square inch of section.

Experiments on wrought iron bars give a tensile strength of from 18,000 lbs. to 22,400 lbs. (10 tons) per square inch of its section, as just sufficient to balance the elasticity of the metal; and as a bar of it is extended the 10,000th part of its length for every ton of direct strain per square inch of its section, it is deduced that its elasticity is fully excited when it is extended the 1000th part of its length.

The mean tensile strength, then, of wrought iron being from 55,000 lbs. to 65,000 lbs., the value of it, when subjected to a tensile strain, may be safely estimated at from three-tenths to one-fourth of this, or of its breaking strain.

A bar of wrought iron will expand or contract '000006614, or the 151,200th part of its length for each degree of heat; and assuming, as before stated for cast iron, that the extreme range of temperature in the air in this country is 140°, it will contract or expand with this change, with a force equivalent to 20,740 lbs. (9.25 tons) per square inch of section.

The tensile force of metals varies with their temperature, generally decreasing as the temperature is increased.

In silver, the tenacity decreases more rapidly than the temperature; in copper, gold, platinum, and palladium, it decreases less rapidly than the temperature.

In iron, the tenacity is less at 212° than at 32°, and at 292° it is greater than at 32°.

Tensile strength of the strongest piece of cast iron ever tested, 45,970 lbs. This was a mixture of grades 1, 2, and 3 of Greenwood iron, and at the 3rd fusion.

Adhesion of Roman cement to blue stone 77 lbs. per square incl.

TABLE OF ELEMENTS CONNECTED WITH THE TENSILE RESISTANCE OF VARIOUS SUBSTANCES.

SUBSTANCES.	Tensile Strain per sq. in. for Limit of Elasticity.	Proportional Elongation for Strain of Limit of Elasticity.	Ratio of Strain in Column 1 to that causing Rupture.
	lbs.		
Oak.....	2,856	'00167	'23
Yellow Pine	3,332	'00117	'33
Beech	3,355	'00242	'30
Wrought Iron—ordinary	17,600	'00062	'30
„ Swedish	24,400	'00093	'44
„ English.....	{ 18,850 22,400	{ '00072 '00086	{ '37 '44
„ American	21,000	'00080	'40
„ Wire, No. 9, unannealed	47,532	'00165	'49
„ „ annealed ...	36,300	'00129	'58
Steel Plates, blue tempered	93,720	'00222	'67
„ Wire.....	35,700	'00120	'50
Cast Iron—English	4,000	'00116	'25
„ American	5,000	'00149	'25

ON THE DETERMINATION OF DISTANCES IN THE FIELD.

(Illustrated by Plates 194 and 197.)

By LIEUT.-COL. H. CLERK, R.A., F.R.S.

In consequence of the introduction into the service of guns of greater precision and range, a ready means of determining the distance of the object to be fired at, becomes very desirable; and having for some time past had this subject under consideration, I have drawn up the following account of the instruments experimented with, in the hope that it may be found interesting, and possibly lead to some more perfect form of instrument than any yet tried.

The most generally known means of ascertaining a distance, by one observation, is Cavallo's micrometer, which consists in a finely divided scale in the eyepiece of a telescope. The distance is estimated from the number of scale divisions which an object of known, or assumed, height covers; the angular value of a scale division being previously determined.

Roche's micrometer, and a very portable field glass called the "Emperor Napoleon's," are both on the same principle. (See Fig. 1, Plate 194.)

The objections to this method are that, in the first place it is necessary to know the height of the object very accurately; for an error in it will cause a proportionate error in the distance; thus, if the object be estimated at 5 ft., an error of $\frac{1}{10}$ th or 6 in. will cause an error of 100 yards in a distance of 1000 yards. In the second place, this method is only applicable when both the top and bottom of the object are visible.

These considerations led Professor C. Piazz Smyth, Esq., F.R.S., Astronomer Royal, Edinburgh, to devise, in November, 1855, an instrument in which this principle is reversed; i.e., instead of observing the angle a distant base line subtends, the instrument carries its own base line, and all that is necessary for the determination of the distance is a point. The same object being seen by direct vision and by reflection from each end of the base line. (See Fig. 2, Plate 194.)

Thus, the head of a man above a parapet or a light at night is sufficient for the purpose.

The principle of the instrument is shown in Fig. 3, Plate 194.

At the extremities of a base line A B are fixed two mirrors (or prisms), A and B, at about 45° to the base line. By means of a telescope, C, at right angles to the base, a distant object (d) is seen by direct vision through the unsilvered part of the mirror A. The same object is reflected into the mirror B, from it to A, and thence into the telescope.

The distance may be determined by either of the following methods:—

(1) By turning the mirror B through a certain angle, until the two objects coincide, keeping the base line a constant, and referring this angle to a table for the distance (as in Fig. 4), or

(2) The mirror B may be made to move backwards and forwards along the base line, the angle remaining constant as in Fig. 5. In this case, the distance is determined on the principle of similar triangles (the instrument being in the first instance adjusted to some known distance), or

(3) Neither base nor angle need vary, but the distance be obtained by observing the amount of separation of the two objects as seen in the eyepiece of the telescope, these objects having been previously made to coincide at some known distance, as zero.

The amount of separation can be measured either by a wire micrometer, or a finely divided glass scale, and the readings referred to a previously calculated table for the distance. (See Fig. 6.)

This is the method which I found most convenient, and an instrument was made for me by Messrs. Pastorelli and Co., London, in 1858, which I shall now describe. (See Plate 197.)

An ordinary telescope, C, is screwed in a right angle to a bar of metal, A B, about 2 ft. in length. At the extremities of this bar are placed the mirrors A and B at about 45°. The mirror B has a motion on its axis, and can be adjusted to any required angle by means of the screw D acting on the lever L. The mirror B being fixed vertically to the bar, the other mirror A can be adjusted so as to be parallel to it by means of the small screws e c. The bar f f acts as a support to the instrument when in use. In the eyepiece of the telescope is fixed a finely divided glass scale, of which an enlarged view is given in Plate 197. The mirrors and bar are enclosed in a case, to keep off all extraneous rays of light, and by means of small shutters either of the images may be shut out so as to render the other more distinct.

The ordinary mode of using the instrument is to rest it on something flat, the top of a limber-box for instance, and direct the telescope on to the object whose distance is required to be ascertained, making it to be bisected by one of the long divisions of the scale. The reflection of the same object will also be seen on the scale at a certain number of scale divisions from the former, according to the distance of the object, and the zero of the instrument, which may be any convenient known distance. The number of scale divisions is referred to a Table previously calculated, from which the distance of the object is at once ascertained. In order to calculate this Table it is necessary to know the angular value of a scale division, the exact length of the base line, and the zero of the instrument.*

The first point is to determine the angular value of a scale division.

To do this the number of divisions covered by a 5 ft. rod at several distances was observed, and the angle being calculated, the value of one division was readily ascertained.

OBSERVATIONS TO DETERMINE THE VALUE OF 1 SCALE DIVISION = α .

Distance.	Angle subtended by 5 ft.	No. of divisions.	Value of one div. = α .	Remarks.
ft.	° ' "		"	
300	0 57 17	44.0	78.1	$\alpha = \frac{\theta}{n}$ where $\tan \theta = \frac{5}{d}$ $d = \text{distance.}$
450	0 38 12	30.0	76.4	
600	0 28 39	22.0	78.1	
750	0 22 55	18.5	74.3	
900	0 19 6	15.0	76.4	
1050	0 16 22	12.8	76.8	
1200	0 14 19	11.0	78.1	
1350	0 12 44	10.0	76.4	
1500	0 11 27	9.0	76.4	
1650	0 10 25	8.2	76.2	
Mean	76.7	= 0° 1' 16.7"

* The zero of the instrument is that distance where the two images of the object, as seen by reflection and direct, exactly coincide. This may be either 100ft. or infinity; in the latter case, the sun can be used for adjustment.

Having the value of a scale division, the next point is to determine the exact length of the base line. For this purpose the instrument was set so that at a distance of 100 feet the images of the object as seen by direct vision and by reflection could coincide. Observations were then taken of the same object at several measured distances, and the number of scale divisions between the two images noted at each distance. The length of the base line is calculated as follows:—

$$L = \tan \theta \times \frac{100 d}{d - 100} \text{ where } \theta = an,$$

- L = length of the base line,
- a = angular value of the scale divisions,
- n = number of divisions read off,
- 100 = zero = 100ft.,
- d = any other distance of observation.

The following are the observations made,—

Distance feet.	Scale Reading.	Length of Base line.	Mean.
150	17.5	1.9523	
300	34.5	1.9244	
450	41.0	1.9602	
600	44.0	1.9637	
750	45.5	1.9525	ft.
900	46.5	1.9455	
1050	47.8	1.9647	1.9519
1200	48.0	1.9473	
1350	48.5	1.9485	
1500	49.0	1.9523	
1650	49.5	1.9596	

With these values of L and a, a table of distances and corresponding scale readings can be calculated by the formula

$$\tan(\theta = an) = \left(\frac{L}{100} - \frac{L}{D} \right)$$

$$n = \frac{\theta}{a},$$

if 100ft. be taken as the zero, or

$$\tan \theta = \frac{L}{D}, \quad n = \frac{\theta}{a}$$

if infinity be taken as the zero. If the latter case a distance of 100ft. would give a scale reading of 52.5, and this could be used to adjust the instrument by, supposing neither sun nor stars were visible.

In the former case, as the distance increases, the images of the object will appear to separate more and more till they get near the edges of the object glass; whereas, in the latter case, they gradually approach each other, and, except at very close distances, the observations can always be made near the centre of the object glass. For this reason the latter mode of adjusting the instrument will be found preferable. As the image seen by reflection is always much more indistinct than the one seen direct, it is advantageous to shut out the latter image, after having made it to be bisected by one of the long divisions, taking care not to shift the instrument in so doing, and a small shutter is provided for the purpose.

The following Table shows the value of the scale readings for every 100 yards up to 1000 yards:—

Adjusted to zero = 100 feet.		Adjusted to zero = infinity.	
Distance.	Reading.	Distance.	Reading.
100 yards	35.0	100 yards	17.5
200 "	44.0	200 "	8.8
300 "	46.6	300 "	5.8
400 "	48.0	400 "	4.4
500 "	49.0	500 "	3.5
600 "	49.8	600 "	2.9
700 "	50.1	700 "	2.5
800 "	50.3	800 "	2.2
900 "	50.5	900 "	2.0
1000 "	50.8	1000 "	1.8

It will be seen by an inspection of this Table that although at short distances the differences of readings are considerable, yet at 1000 yards the difference for 100 yards is only 0.2 of a scale division equal to about 15 seconds. This, in clear

weather and with a favourable object to observe, can be easily measured, and by practice the eye can readily determine tenths of a division; but as the object seen by reflection is generally very faint and indistinct, not much dependence can be placed on observations over 1000 yards, with an instrument having so short a base line as 2ft.

In garrisons or coast batteries, where portability is not essential, and there need be no limit either to the length of the base line or power of the telescope, distances of from 2 to 3000 yards could be readily determined by an instrument of this description, by a single observation of any object either by day or night.

For artillery purposes, in the field, an instrument having a base line of 5ft. would give good results up to 2000 yards; it could always be used resting on the top of a limber-box, and could be carried in the store limber waggon without inconvenience.

For observing at night, an arrangement would have to be made to illuminate the micrometer wires or glass scale.

Although an instrument on the principle just described will give distance up to 2000 yards with tolerable accuracy, yet there may be occasions when it is necessary to determine distances up to 4 or 5000 yards. For these distances it becomes necessary to measure an actual base line, and to measure at each end the angle subtended by the object and the opposite end of the base. For general purposes a base of 100 yards will be found sufficient, and as the triangle will be isosceles, or very nearly so (see Fig. 7), the distance can be calculated by the formula

$$D = \tan \frac{A + B}{2} \times \frac{AB}{2}.$$

The distances corresponding to the several values of

$$\frac{A + B}{2}$$

for a constant base can be formed into a Table, and consequently all that is necessary is to observe the two angles A and B, take their mean, and refer to the Table for the distance.

The angles could be measured by a pocket sextant; but as this instrument is only divided to minutes and has an index-arm of only about 2in. in length, it will not give the angles sufficiently accurate for long distances. The following is an instrument I have made for the purpose on the principle of the optical square, and which can be applied to any telescope. (See Plate 197.)

It consists in placing in front of the object glass of a telescope A A, at an angle of 45° to it, a mirror B B, having a motion on its axis. An index-arm C C gives motion to the mirror, and enables the angle through which it has been moved to be read off on an arc D D, graduated to 10 seconds, and supplied with a vernier and tangent scale. The index-arm is 7.5in. in length; consequently the angles can be read off with great accuracy with the assistance of a magnifying glass K K.

By means of the screw E the mirror can be adjusted exactly to 45°, so that the reading of 90° on the graduated arm shall exactly agree with a right angle. Any difference, if small, can be applied as an index error to the observation, instead of attempting to make the adjustment quite correct.

The mirror is adjusted to verticality by means of the screws F F.

A cover, a, b, c, d, encloses the mirror and object glass, keeping out all rays of light except such as are admitted through the small openings e, f, which are provided with sliding shutters.

By means of the foot-screws H H, the plane of the instrument can be adjusted to that of the objects observed, if the instrument is used resting on anything flat, such as the top of a limber-box, parapet, &c.

In the focus of the eye-piece are two cross wires at right angles to each other, and the objects must always be made to coincide exactly on the vertical wire.

There being only one mirror used in this instrument, the two objects do not remain in contact in any part of the field of view, as is the case in a sextant, but separate in contrary directions, for this reason care should always be taken that the contact is made on the vertical wire. For accurate observations the instrument should be used either resting upon something, or fixed to a light tripod stand. Having made the object seen by direct vision to be bisected by the wire (by moving the instrument on the stand), the instrument should remain fixed and the object seen by reflection be brought on to the wire by moving the index-arm. To prevent errors of collimation (that is, suppose the vertical wire is not exactly in the axis of the telescope), the eye-piece and diaphragm carrying the wires should always be used in the same position with reference to the plane of the instrument; any error arising from this cause will then be included in the index-error.

Although having only one reflection makes the objects less steady in the field of view, and necessitates the use of a stand or some support for the instrument, yet there is less loss of light and the reflected object is more distinct. The instrument is also simpler and more compact.

The axis of the mirror, or centre on which the index-arm rotates, should be exactly over the extremity of the base line, and the instrument is supplied with a plumb-bob for the purpose of effecting this. When time permits, it will be advisable to observe both the distant object and the end of the base line by direct vision as well as by reflection, the instrument being inverted in one case, any errors arising from the mirror not being vertical to the plane of the instrument will be eliminated.

The height of an object can also be obtained by this instrument, the distance having been first determined, by making first the top and then the bottom of the object coincide with the horizontal wire in the eye-piece, the instrument remaining fixed on the stand during the observations. The difference of the two readings gives the angles subtended by the object at that distance, and the height is obtained by the formula

$$H = D \sin C,$$

when H = height; D = distance; C = angle observed. The height corresponding to the various values of C for some one distance, 1000 yards for instance, can be formed into a table, and a simple proportion will give the height for the same value of C for any other distance.

The following Tables give the distance and height of an object, the one with a base line of 100 yards, the other at a distance of 1000 yards.

TABLE OF DISTANCES.*
Base = 100 yards.

Angle 87°	Distance yards.	Angle 87°	Distance yards.	Angle 88°	Distance yards.	Angle 88°	Distance yards.	Angle 89°	Distance yards.
0	954	30	1145	0	1432	30	1909	0	2864
2	965	32	1161	2	1456	32	1953	2	2963
4	976	34	1177	4	1481	34	1998	4	3069
6	987	36	1193	6	1507	36	2046	6	3183
8	999	38	1210	8	1534	38	2096	8	3305
10	1010	40	1227	10	1562	40	2148	10	3438
12	1022	42	1245	12	1591	42	2203	12	3581
14	1035	44	1263	14	1621	44	2261	14	3736
16	1047	46	1282	16	1652	46	2322	16	3906
18	1060	48	1302	18	1685	48	2387	18	4092
20	1074	50	1322	20	1718	50	2455	20	4297
22	1087	52	1342	22	1753	52	2527	22	4523
24	1101	54	1364	24	1790	54	2604	24	4774
26	1115	56	1386	26	1828	56	2685	26	5055
28	1130	58	1408	28	1868	58	2772	28	5371

* For distances over 4000 yards, the base line should be 200 yards, when the values in this Table will be doubled.

TABLE OF HEIGHTS.*
Distance = 1000 yards.

Height.	Angle.	Height.	Angle.	Height.	Angle.	Height.	Angle.	Height.	Angle.
ft.	° /	ft.	° /	ft.	° /	ft.	° /	ft.	° /
5	0 6	65	1 15	125	2 24	185	3 32	245	4 41
10	0 12	70	1 20	130	2 29	190	3 38	250	4 47
15	0 17	75	1 26	135	2 35	195	3 44	255	4 53
20	0 23	80	1 32	140	2 40	200	3 49	260	4 58
25	0 29	85	1 37	145	2 46	205	3 55	265	5 4
30	0 34	90	1 43	150	2 52	210	4 1	270	5 10
35	0 40	95	1 49	155	2 58	215	4 7	275	5 16
40	0 46	100	1 55	160	3 3	220	4 13	280	5 21
45	0 52	105	2 1	165	3 9	225	4 18	285	5 27
50	0 57	110	2 6	170	3 15	230	4 24	290	5 33
55	1 3	115	2 12	175	3 21	235	4 30	295	5 39
60	1 9	120	2 18	180	3 26	240	4 36	300	5 44

* 1 minute of arc = 0.9 feet.

When a base line can be measured, this method of determining the distance will be found the most accurate: but there are many occasions where neither time nor the nature of the ground allow of this being done, and it is then that an instrument which will give the distance by one observation will be found useful.

I have been lately informed by Professor Smyth that an instrument to measure distances by double reflection and carrying its own base line was contrived by Dr. Wollaston for one of the early Polar expeditions, the length of its base was 3ft., and that a similar principle has been carried out in Russia, by M. Otto Struve, Director of the Great Central Imperial Observatory at Pulkova.

INSTITUTION OF CIVIL ENGINEERS.

April 16, 1861.—GEORGE P. BIDDER, Esq., PRESIDENT, in the Chair.

ON THE FLOATING RAILWAY ACROSS THE FORTH AND TAY FERRIES.

By MR. WILLIAM HALL, Assoc. Inst. C.E.

The works described in this Paper were undertaken in connection with the Edinburgh, Perth, and Dundee Railway, for the purpose of establishing an unbroken communication between Edinburgh and the country north of the Tay, by which goods (and even passengers if required) could be conveyed across the Ferries, without removal from the waggons.

One of the chief difficulties which had to be overcome arose from the difference in the levels of low and high water, averaging 16 feet at spring tides. Several plans were proposed; among others hydraulic and steam cranes to lift, or lower

the waggons, but it was considered that this would be too slow a process, as well as be liable to damage the waggons. Another design proposed girders 100 feet in length, having one end hinged on shore, and the other attached to a floating caisson, to rise and fall with the tide; but, owing to the exposed situation, this would have rendered necessary the construction of costly protecting piers and jetties.

The works actually carried out at the Forth Ferry consisted, on the east, or sea-side of the piers at Granton and Burntisland of a slipway, having an inclination of 1 in 6, and constructed of solid masonry. Rails were laid upon this slipway, on which traversed a heavy platform, of a wedge shape, the upper surface being always horizontal. This platform was 65 feet in length and 21 feet breadth, and was formed of a wooden framework, having four main longitudinal timbers, into which rails were sunk. The platform rested upon twenty-four cast iron wheels, each 30 inches in diameter, with a flange cast on the middle of the rim, so as to allow the wheels to bear evenly on both sides of the rails. To the sea-end of this travelling platform were attached, by means of universal joints, four wrought-iron trough girders, for spanning the distance between the platform and the stern of the vessel. The girders were raised or lowered, as required, by two powerful winch crabs, placed on a staging elevated above the platform, at about the middle of its length. The two chains, one on each side, for lifting the girders, were passed round the barrels of the crabs, and thence over two derricks to the ends of the girders, counterbalance weights being attached to the other ends of the chains. To provide for the safety of the platform, in the event of the fracture of the hauling chain, two lines of racks were laid along the surface of the slipway, into which worked palls, attached to the axes of the wheels. Steel points, turning on hinges, were attached to the ends of the girders, and also to the pier-ends of the main timbers of the platform, to prevent an abrupt transition of the waggons to or from the vessel. Each of the universal joints, by which the girders were attached to the platform, consisted of a bolt, or pivot, 3½ inches in diameter, the middle of which was ball-shaped, and worked in a corresponding portion of a cup, or socket. This socket was circular, and was made in two parts, having a projecting collar and flanges, which were clipped by and were bolted to the plates fixed to the main timbers of the platform. The socket was shaped in a radial form, to allow the pivot full play, and to permit of the ends of the girders moving 3 feet on each side. By these means a range of position was obtained to the extent of 6 feet, to compensate for the pitching or rolling of the vessel.

A stationary steam engine of 30 H.P., similar to a locomotive with the wheels removed, was fixed on the quay for raising or lowering the platform, and for drawing the waggons off the vessel. On the crank shaft of the engine was fixed a pinion working into a wheel, on the shaft of which were three winding drums, one placed in the middle of each line of rails, and one in the centre of the intermediate space. The winding drums were 2 feet 10 inches in diameter, with flanges, on the periphery of which wood was bolted, and round which there was a wrought-iron friction band acting as a break. The speed of the engine was decreased by toothed wheels and pinions; seventy strokes of the engine giving thirty-five revolutions to the drums, and, by other intermediate wheels and pinions, three revolutions and one-fifth to the chain wheel. The weight of the platform was about 70 tons, and it was moved up and down the incline at a velocity of 18 feet per minute.

The steam vessel, named the *Leviathan*, for conveying the goods traffic across the Forth, was built by Mr. R. Napier. It was constructed of iron, 172 feet long, 54½ feet in breadth over, and 34 feet between the paddle wheels, with 11 feet depth of hold. The draft of water when loaded was 6½ feet, and when unloaded 4½ feet. The vessel was propelled by two steeple engines, each working its own paddle, of the collective nominal power of 210 H.P. On the deck there was stanchion for three lines of waggons, the end ones on each line being "scotched." The description of rail used throughout was the inverted bridge-rail, weighing 53 lbs. to the yard, the same as on the Granton Pier; and they were sunk into the longitudinal timbers, so as to be flush with the surface of the deck.

The works at Granton and Burntisland on the Forth, including the slipways, platforms, stationary engines and gearing, cost £10,000, and the *Leviathan* complete, £16,226. The working expenses for six months ending July last were £768 for the stationary engines and machinery, and £1305 for the vessel.

The *Leviathan* generally made from four to five double trips, a distance each way of 5½ miles, in the day of twenty-four hours, and could take from thirty to thirty-five waggons at a time. During the last six months 37,618 trucks had been so conveyed across the Forth. The time occupied in making a single trip was twenty-six minutes, and the operations of loading and unloading were performed in from five to eight minutes.

At the Tay Ferry some modifications, suggested by experience, were made. The inclination of the slipway was 1 in 8, and it was formed of timbers resting upon wooden piles. The length of the ferry was only ¼ths of a mile. The vessel the *Napier* was 140 feet in length, 40½ feet in breadth over, and 22 feet clear between the paddle wheels; and she was propelled by a pair of oscillating engines of 112 H.P. There were two lines of rails on the deck, with stanchion for fifteen waggons. The vessel made from six to seven double trips, and carried on an average one hundred and eighty waggons per day. The works cost, including the slipways, platforms, stationary engines and gearing, £8800, and the vessel *Napier* complete £9182.

These works were designed by Mr. Bonch (M. Inst. C.E.), and were executed under his directions by the Author; Messrs. Anderson being the contractors for working the Ferries.

In conclusion, the Author remarked that the "Floating Railway" might be adopted with advantage in all places where the expense of a bridge or a tunnel offered an insurmountable obstacle, or where the navigation would not admit of interruption by the erection of a bridge, as at the Mersey and Bristol Channels, and across the Straits of Dover.

MANCHESTER LITERARY AND PHILOSOPHICAL SOCIETY.

ON THE TEMPERATURE OF THE EARTH'S CRUST, AS EXHIBITED BY THERMOMETRICAL OBSERVATIONS OBTAINED DURING THE SINKING OF THE DEEP MINE AT DUKINFIELD.

By W. FAIRBAIRN, LL.D., ETC.

During the prosecution of researches on the conductivity and fusion of various substances, an opportunity occurred of ascertaining by direct experiments, under favourable circumstances, the increase of temperature in the crust of the earth. This was obtained by means of thermometers placed in bore-holes, at various depths, during the sinking of one of the deepest mines in England, namely, the coal mine belonging to F. D. Astley, Esq., at Dukinfield, which has been sunk to a depth of 700 yards.

The increase of temperature in descending, shown by these observations, is irregular; nor is this to be wondered at, if we consider the difficulties of the inquiry and the sources of error in assuming the temperature in a single bore-hole, as the mean temperature of the stratum. At the same time it is not probable that the temperature in the mine-shaft influenced the results. The rate of increase has been shown in previous experiments to be directly as the depth, and this is confirmed by these experiments. The amount of increase is from 51° F. to $57\frac{3}{4}^{\circ}$, as the depth increases from $5\frac{3}{8}$ to 231 yards, or 1° in 99 feet; but, in this case, the higher temperature is not very accurately determined. From 231 to 685 yards, the temperature increases from $57\frac{3}{4}^{\circ}$ F. to $75\frac{3}{4}^{\circ}$. This is a mean increase of 1° in 76.8 feet, which does not widely differ from the results of other observers. Walford and Arago found an increase of 1° in 59 feet; at Rehme, in an Artesian well 760 yards deep, the increase was 1° in 54.7 feet; De La Rive and Marcet found an increase of 1° in 51 feet, at Geneva. Other experiments have given 1° in 71 feet. The observations are affected by the varying conductivity of the rocks, and by the percolation of water. The author has exhibited upon a diagram, in which the ordinates are depths, and the abscissae temperatures, the results obtained between the depths of 231 and 717 yards. The strata of the mine are also shown in section. Additional to these, the author gives a table of similar results in another pit at the same colliery, taken between the depths of 167 $\frac{1}{2}$ and 467 yards, and showing an increase of temperature of 1° in 106 feet of descent.

Assuming as an hypothesis, that the law thus found for a depth of 790 yards, continues to operate at greater depths, we arrive at the conclusion that at 2 $\frac{1}{2}$ miles from the surface, a temperature of 212° would be reached, and at forty miles a temperature of 3000° , which we may suppose sufficient to melt the hardest rocks. The author then discusses the effect of pressure and increased conductivity of the rocks in modifying this result. If the fusing point increased 1° F. for every 500lb. pressure, as is the case with wax, spermaceti, &c., the depth would be increased from 40 to 65 miles before the fluid nucleus would be reached; but as the same increase is not observed with tin and barytes, the influence of pressure on the thickness of the crust cannot yet be determined. Again, Mr. Hopkins has shown that the conductivity of the dense igneous rocks is twice as great as that of the superficial sedimentary deposits of clay, sand, chalk, &c. And these close grained igneous rocks are those which we believe must most resemble the strata at great depths. Now, if the conductivity of the lower rocks be twice as great as that of the strata in which the observations were made, correcting our former estimate, we should probably have to descend 80 or 100 miles, instead of 40, to reach a temperature of $3,000^{\circ}$, besides the further increase due to the influence of pressure on the fusing point. On entirely independent data, Mr. Hopkins has been led to conclude that the minimum thickness of the crust does not fall short of 800 miles, in which case the superficial temperature of the crust would have to be accounted for from some other cause than an internal fluid nucleus.

BRIEF NOTES ON THE NATURE AND ACTION OF STEAM IN RELATION TO BOILER EXPLOSIONS.

By J. C. DYER, ESQ., VICE-PRESIDENT.

He stated that several essays had lately appeared on boiler explosions, wherein discordant theories and opinions are offered on the action of steam in some anomalous cases of explosion, and which may justify the bringing before the Society a few established facts and principles relating to the subject, in the hope of arriving at more settled views concerning causes and effects in such cases than appear to prevail at present among our most distinguished engineers. The author objected to the appeals made to Dr. Dalton's theory of atoms for explaining the nature of steam as an elastic force mechanically employed, since the law of definite proportions of Dalton had no reference to elastic vapours except as to the constituents of the liquors whence they arise. He then cited the fact that water, like steam, is an elastic body, and the pressure would therefore be of the same nature and force above and below the water line in a boiler; but that explosions from fractures above and below that line would have different effects, owing to the amount of expansion of water and steam being so widely different when issuing from similar apertures and under the same pressure. Many obscure cases of explosion would be explained by the more or less rapid generation of steam issuing under those circumstances, as set forth in the paper. That free space, when suddenly and amply afforded, is to highly heated water, under great pressure, nearly the same as fire is to gunpowder. And this will account for the most destructive cases of boiler explosions; whilst those of a more harmless nature show that the fractures were small at first, and then gradually extended.

He also objected to the term "superheated steam," as being inapplicable to it in any state; because, when steam is in contact with water, it will be of the same

temperature as the water; and if heated apart from water, the same laws of expansion by heat apply to steam as to air, and neither can be "superheated," though made very hot.

Again, steam can never be "mixed up with the water" in a boiler when both are under the same statical pressure, and the steam formed will rise into the chamber, so that the water will always be in contact with the boiler except when steam is drawn off. Still, in rapid escapes, it may drive out water and become entangled therewith, as in many explosions.

It having been shown that most, if not all, explosions are occasioned by simple steam pressure, acting on the weakest parts at first, and thence extending more or less rapidly, it would seem needless to seek for any other cause or force to account for them; yet, in some cases, the effects appear to imply a more sudden and violent action, like that of explosive compounds. In such instances, may they not arise from the actual decomposition of the water by heat alone? Although we have high authority (cited) against this, yet the author held it rash to conclude that water could not be resolved into its constituent gases by direct action of heat from the boiler upon water pressed into contact with the metal plates. It has been proved, long since, that by heat, in the most intense form known to us—that of electricity—water is decomposed and both of its constituent gases are liberated. Therefore, since no evidence has been adduced to show that this does not take place in any water when so confined and heated, the affirmative may at least be possible, and seems probable, in some instances, as before named.

However, he held it desirable that the question should, if possible, be set at rest by experiment; and to this end a method was suggested for putting the matter to a direct test; but he might not be able to make the experiment himself, and hoped it might be done by some one more competent to the task.

February 19, 1861.

DR. J. P. JOULE, President, in the Chair.

BRIEF NOTES ON THE FREEZING, THAWING, AND EVAPORATION OF WATER, AND ON THE CONDENSATION OF STEAM, WITH A VIEW TO INQUIRE INTO THE CAUSE OF THOSE CHANGES

By J. C. DYER, ESQ.

In these Notes the author merely aimed to place before the Society the apparent agency of heat, in the changes that water undergoes in passing alternately from one to the other of its conditions of ice, water, and steam, and *vice versa*; and that these mutations are caused by the taking up and giving out of heat, in its sensible or latent state, by the transitions reciprocally from one to the other of those states. The actual amount of the thermometric heat so passing from the latent to the sensible state was given, as taken from the common tables. On referring to the two ancient theories of heat, the one defining it to be "a material element, *sui generis*, and pervading matter," &c.; the other holding it to be "no other than the motions, mechanically excited in the minute particles of bodies," &c.—it was contended that, by the latter or the "force heat theory," the melting of ice by the action of the sun's rays could not be explained, since it is not by their force, but by the matter of heat that enters and becomes latent in the water. The author then submitted that the only solution, hitherto offered, of the absorption of sensible heat, in water and steam as latent in these, and the re-appearance of the same measure of heat, in a sensible state, by the acts of condensation and freezing, is to be found in the application of Dr. Black's "Latent Heat Theory." Considering the force heat theory, as directly conflicting with that of latent heat, they cannot both be sustained, and as the latter stands in elementary works as an established law in physics, and as it affords a clear explanation of the aqueous changes adduced, it seems incumbent on those who deny the entity of heat, to account for the alternate exhibition and extinction of the thermometric heat, that is, in fact, evolved and absorbed by those mutations of water.

The author, again referring to the long-standing controversies concerning the essential nature of heat, stated that more than one hundred works have been published on the subject during the last 200 years, and yet no conclusion has been arrived at as to the soundness of either of the original theories above cited, nor have any discoveries been made that explain the agency of heat, in the mutations of water, since the days of Bacon and Boyle, with the sole exception of those of Dr. Black, which appear to prove its latent state in bodies. And since we have no settled doctrine as to its essence, we must allow that the subject is of philosophical interest, and especially this branch of it concerning latent heat, in defence of which these notes are offered.

The President said that some very interesting experiments made by Mr. Dyer, many years ago, were in favour of the dynamical theory of heat, which he believed to be fully able to explain the phenomena ascribed by Black to "latent heat."

March 5, 1861.

DR. JOULE, President, in the Chair.

ON THE STRUCTURE OF THE LUMINOUS ENVELOPE OF THE SUN.

By MR. JOSEPH SIDEBOTHAM.

Mr. Nasmyth has made the discovery that the entire surface of the sun is composed of objects of the shape of a willow leaf; these objects average about 1000 miles in length, and 100 in breadth, and cross each other in all directions, forming a network; the thickness of this does not appear to be very great, as through the interstices the dark or penumbral stratum is seen, and it is this which gives to the sun that peculiar mottled appearance so familiar to observers. These willow leaf-shaped objects are best seen at the edges of a solar "spot" where they appear luminous, on a dark ground, and also compose the bridges which

are formed across a spot" when it is mending up; the only approach to symmetrical arrangement is in the filaments bordering the spot, and those composing the penumbra, which appears to be a true secondary stratum of the sun's luminous atmosphere; here these bodies show a tendency to a radial arrangement. Although carefully watched for, no trace of a spiral or vortical arrangement has been observed in these filaments; thus setting aside the likelihood of any whirlwind-like action being an agent in the formation of the spots, as has been conjectured to be the case. The writer does not feel warranted at present in hazarding any conjectures as to the nature and functions of these remarkable willow leaf-shaped objects, but intends pursuing the investigation of the subject this summer, and hopes to lay the results before the British Association during their meeting in this city. The paper was illustrated by three beautiful drawings. No. 1 represented one of the willow leaf-shaped objects; No. 2 the luminous surface of the sun as being entirely composed of these objects; and No. 3, a large drawing of a solar spot as seen on the 20th of July, 1860, exhibiting the surface of the sun composed of these objects, as also the penumbra and the bridges across the dark portion of the spot in which the exact shapes of these objects were to be seen most clearly.

Mr. Sidebotham stated that the image of the sun was examined by Mr. Nasmyth with a mirror of plain glass, set at an angle of 45 degrees; nearly the whole of the light and heat of the sun passed through the glass, and the rays used were those only reflected from its surface.

INSTITUTION OF NAVAL ARCHITECTS.

Saturday, March 2, 1861.

THE RIGHT HON. SIR J. S. PAKINGTON, G.C.B., IN THE CHAIR.

The first paper read was, "ON THE WAVE-LINE PRINCIPLE OF SHIP CONSTRUCTION," by Mr. J. Scott Russell, F.R.S., Vice-President, I.N.A., and formed the concluding lecture upon that subject—two previous ones having been delivered in March, 1860, and published in Vol. I. of the *Transactions* of the Institution. In the present paper the author, after recapitulating the leading features of his previous lectures, in which the nature of the Wave-Line Principle was set forth, proceeded to point out, with the aid of numerous diagrams, the effects of the wave-line upon the stability of ships, and on the area of the load water line; showed how it affected the structure of the vessel and the form of the deck; how vessels should be built upon that principle so as to have a maximum capacity, which it appears to militate against; how the various proportions of length, breadth, and depth affect resistance; how the whole form can be so constructed as to properly arrange the balance of the ship; how this form affects the rolling and pitching of a ship; what are the places for the centres of gravity of the hull and the after body; how the wave principle affects the quality of the materials with which a ship should be built; and how it affects the properties of sailing-ships and of paddle and screw steamers.

After the reading of this paper a brief discussion took place respecting the relations of length and breadth in a ship, and some other points referred to by the author.

The second paper read was "ON THE CLASSIFICATION OF IRON SHIPS," by Mr. J. Grantham, Member of Council, I.N.A. The author commenced by asserting that the evils incidental to the faulty construction of iron ships were on the increase, chiefly because the tendency to urge vessels to higher performances, and to increase their size, power, and capacity was interfered with by established rules. He observed that circumstances have raised up two powerful instrumentalities which exert an immense influence for good or harm on iron ships,—viz., those of a Government Department and of Underwriters. But besides these there were other influences at work. Theory and common sense demand, he said, that first safety, then profit, and then speed shall be secured; but of these the owner usually places "profit" first, then "speed," "safety" having to be looked for last. Nor do the public act more correctly. Their demand is (speed first, speed second, and speed third; leaving the owner to see to the profit, and taking the safety if they can get it. It therefore becomes the duty, the author contended, of all engaged in the construction of iron vessels to bring "safety" into the foreground. High speed is not incompatible with safety. Want of speed is a source of many accidents. But at present, the Board of Trade, Lloyd's Committee, owners, and shipbuilders do not agree in their requisitions; hence the Institution of Naval Architects, which is fortunately possessed of all the necessary elements for producing agreement—comprising, as it does, many of the leading representatives of all these several classes—is looked to for a remedy. He had heard many complaints of the existing Regulations made privately throughout the country; and he hoped that if the Institution should undertake to investigate the subject, with the co-operation of the Board of Trade, Lloyd's Committee, and their respective surveyors, these complaints, so freely expressed in private, would not be withheld when the question was thus brought forward publicly; because it is due to all parties, especially to the gentlemen who are publicly responsible, that the truth shall be fairly stated. The author next laid it down as a principle that all sea-going vessels should have a class; but contended that, for this purpose, the classes must be as varied as the objects for which steam vessels are employed, and so expansive as to keep pace with, and not retard, the improvements that are every day in progress. He then enlarged on some questions relative to the strength of iron ships, alleging that a ship might be viewed as a beam, but did not require to possess the full strength of a girder, as every ocean vessel is partially born up at all parts, whatever be the state of the sea. Again, when we have to consider the strains arising from rolling from the action of the masts or machinery, or from the shocks received by the concussion of the waves, we have to provide supports of another description. Then, again, we have to view the vessel as she is taking the ground, all ordinary attempts to provide for which in a very long ship are futile. It is simply a

question, not of safety, but of cost and of insurance, whether a ship shall be made strong enough to support herself when supported on shore at the middle, or at the ends; but as to securing the absolute safety of a vessel when knocked by the sea upon hard and pointed rocks, that, the author considered, is utterly impracticable. He showed, however, by several examples, that with water-tight bulkheads iron vessels do often go upon rocks, sustain severe local injury, and yet come off again safely. After dwelling upon these matters, the author said he felt confident that, as we pursue the question, we shall find that the length of iron ships may be greatly extended, but that there will be great difficulty in providing any code of rules that can even approximate to the circumstances of very long vessels. In maintaining this position he worked out the proportions assigned by Lloyd's Regulations to two ships, one double the length of the other, showing that the weight of the plates in the larger vessel would be increased about 17 per cent., and that of the frames 40 per cent.—on the whole, 28 per cent. At the end of the ship there was, he contended, no material difference in the strain, but an increase of about 150 tons weight; in the centre of the ship, however, the tensile strain on the upper part taken as a girder was increased from about 10 to 24, or 140 per cent., while the strength was only increased 28 per cent. A second example of a similar kind was also given. The discretionary power, which Lloyd's Committee now reserve to themselves, respecting the increase of scantling amidships for very long vessels, only proved the case, he said, against the Rules, and showed that they cannot be adhered to. The author next recommended that vessels should be classed by Lloyd's according to their capabilities, and their probable employment. A passenger vessel should be classed as such, with the addition of a distinguishing mark corresponding to the present letter and figure. A cargo vessel, the same. A vessel for a mixed trade the same, distinguishing whether for inland waters, for coasting trade, or for long voyages. These things should be denoted, or such other general descriptions be given as would enable underwriters to know at a glance what kind of risk they were taking. They would not, however, be confined by these definitions, or any other; they would simply be guided. He concluded by suggesting that the Institution should appoint a Committee of its Members and Associates to conduct an inquiry into this important subject, and the Board of Trade and Lloyd's Committee should be requested to allow their surveyors to take part in it in their official capacities.

The next paper read was "ON UNSINKABLE IRON SHIPS," by Mr. Charles Lungley, shipbuilder, Deptford. The author commenced by referring to a paper read by Mr. Charles Wye Williams, of Liverpool, before the British Association, as long ago as 1837, in which the adoption of vertical water-tight bulkheads, placed transversely across the ship, was strongly urged as a means of safety in iron ships; the author (Mr. Williams) at the same time giving an account of their advantageous application to several passenger ships over which he had control. "The plan is not restricted," said he, in concluding his remarks, "by any patent, and all are free to adopt it; and I expect hereafter to see this principle so adopted and improved that the security of steam vessels will keep pace with that greater utility and extension to which they seem destined." Nearly twenty-five years have passed, said Mr. Lungley, since Mr. Williams thus urged the use of water-tight bulkheads upon the attention of shipbuilders and ship-owners, and the invention has risen more and more in public estimation from that time up to the present. Many scores of persons now living owe their lives to this valuable invention. At the same time, it must be acknowledged, Mr. Lungley went on to say, that there are disadvantages connected with the use of transverse vertical bulkheads. When riveted to the sides in the ordinary manner, the rivet holes, being under each other and close together, weaken the plating of the ship most seriously. Such bulkheads also interfere very greatly with the stowage of the ship; and it often happens that the passages which are made through them, and are furnished with doors or valves, are found open at the very time when the safety of the ship depends upon the bulkheads being water-tight. These and some other considerations which have from time to time occurred to him in the course of his experience as a practical shipbuilder, have led the author to seek some new, or at least some modified, means of securing the safety of iron ships—especially of iron *passenger ships*—so that the terrible losses which even now frequently happen may be avoided. For this purpose he proposes to render iron ships unsinkable—unsinkable, that is, under circumstances in which ships are most commonly lost, such as when running upon rocks, from leaks, from fire, or on coming into collision with other vessels. His plan consists in dividing the lower part of the ship, or vessel, into two or more closed water-tight compartments, and in affording access to these compartments for the introduction of cargo or stores by means of water-tight trunks or passages led up from them to such a height that their upper or open ends shall never, in any practicable position of the ship, be brought quite down to the level of the water. Compartments thus formed may be used as ordinary cargo spaces, store rooms, chain lockers, or for any other like purposes, and may be ventilated by suitable trunks or tubes, always providing that all trunks or tubes of every kind which enter them shall be made water-tight, and shall rise to the height before-mentioned, in order that if by any mischance either compartment should be broken into, and the sea be admitted to it, the water should have no means of escaping therefrom into any other part of the ship. In carrying this system into effect, the author varies the mode of applying it according to the form of the vessel, and the service for which she is to be employed. In the case of a steam ship for carrying both passengers and cargo, he prefers to construct an internal bottom, or deck, in water-tight connection with the sides of the ship, and extending where the arrangement of the boilers and engines will admit of it, quite fore and aft, at a height of several feet from the outer bottom, or bottom proper. The compartment thus formed in the bottom of the ship may be divided transversely, if required, by bulkheads, such bulkheads extending either to the top of the compartment only, or to any greater height as may be desired. Above this lower compartment, or set of compartments, and along the sides of the ship he builds vertical or inclined bulkheads, forming other water-tight longitudinal compart-

ments, which again may be subdivided transversely, and which also are entered and ventilated by trunks or passages rising to the height before-mentioned. With these arrangements it is evident that any portion of the submerged skin of the ship may be stove in by collision with another ship, or betorn away by rocks, or otherwise, without causing the ship to sink, supposing the remaining internal water-tight portions to be (as he always makes them) of sufficient capacity to keep the ship buoyant and seaworthy, he sometimes forms apertures in the inner bottom or deck, for the purpose of letting any water that may get into the ship from above run down into the bottom, but these apertures are closed by valves or doors, which are never opened except for this purpose, and are closed directly the letting through of the water is completed. Vessels built with these improvements will not therefore be liable to those accidents which occur in ships fitted with water-tight compartments in the ordinary manner, and which result from passages through the bulkheads being formed, and left open. The space occupied by the engines and boilers of a steam vessel he closes entirely in by water-tight iron walls, or bulkheads, extending to the same height above the water-line as the trunks before referred to, in order that this space may be converted into a water-tight compartment, from which water could not escape into any other part of the ship, and into which water could not enter from any other part. Apertures are formed in these walls, or bulkheads, for the admission of coals from the coal bunkers, but these apertures are provided with valves, or doors, which may be closed either from below or from above. He sometimes further divides the boiler-room from the engine-room by a transverse bulkhead, in order that should the engine break down, or the engine-room become flooded, the boilers may still be kept at work, and the steam be used to work pumps by means of an auxiliary engine in the boiler room. He forms divisions by bulkheads across the ship above the skins, which he terms "between deck bulkheads," and which are made perfectly water-tight, and so as to divide the between-deck space in such manner that should the vessel ship seas, or otherwise get water on board, it may be confined to the part where it enters. A large model, and numerous illustrative drawings of the "unsinkable iron ships," were exhibited.

CIVIL AND MECHANICAL ENGINEERS' SOCIETY.

Thursday, June 6th.

ABSTRACT OF PAPER ON LOCOMOTIVE STEAM ENGINES ON COMMON ROADS.

BY MR. C. B. KING.

J. C. FRASER, ESQ., President in the Chair.

After sketching the history of steam carriages, the author proceeded to describe the various forms which have been introduced. Mr. Rickett's first carriage was designed for traction purposes; it weighed $5\frac{1}{2}$ tons, and the engine, which was affixed to the boiler, was connected with the driving wheel by means of an endless chain. That constructed for the Duke of Sutherland was designed to carry three persons at the rate of 10 miles an hour; it is mounted on two driving wheels, and a single steering wheel; one driving wheel only is keyed on the axle, the other being fastened with a clutch, which can be disengaged when it is required to turn sharp corners; the endless chain is retained, and the framework is made to answer the purpose of a tank. The steam and the steering gear are under the direction of the same person. A vertical boiler with horizontal tubes and link motion for reversing have been recently fitted to it. A trial of a similar carriage on a slightly larger scale was so successful as to induce the Earl of Caithness to order Mr. Rickett to build him one differing from it only in the fact that the endless chain is superseded by a spur wheel and pinion, of which there are two sets, one for high and one for low speeds to these wheels I object on account of the noise that they make. In a carriage on which Mr. Rickett is now engaged he endeavours to do away with the objection of blowing off steam to frighten the horses, by using a large condensing surface of air, in which he has succeeded somewhat at the expense of his combustion. The working pressure of this engine is 250lbs. per inch.

Of traction engines, Bray's is one of the most successful. Its arrangements are similar to those of a locomotive, except that cog wheel are introduced between the crank shaft and the driving wheels; the working pressure is about 80lbs. By means of an eccentric, which can be adjusted at pleasure, a series of spades can be made to project through slots in the periphery of the driving wheels, to ensure adhesion on stays, gradients, or soft ground. In an engine now nearly completed the boiler is mounted on trunnions, and is kept level when on a gradient by a self-adjusting apparatus. Some of these engines have drawn a load of 30 or 40 tons up an incline of one in six.

Boydell's endless rail wheels are known to all, but I think they are too complicated to answer.

One of Lorstaff and Pullan's traction engines is now working in London, and pulls 30 tons at the rate of four miles an hour up a gradual but continuous incline. In this engine the boiler is relieved of the strain of the engine by the use of an independent framing. This framing is double, the bearings of the driving axle and the cylinders being attached to the upper or vibrating frame, which is fixed on a lunge at the fore end. The wheels are a combination of iron and wood, in order to obtain

both strength and elasticity. If an increased hite is necessary, it is obtained by two small wheels, which, by means of an eccentric, are lowered, and come into gear with the large wheels. These small wheels are furnished with shallow teeth, the interstices of which are filled up with hard wood.

Mr. Taylor, of Birkenhead, has patented an engine in which the driving wheels can be placed in front, giving an advantage on entering soft ground. The funnel passes through the steam dome, and partially superheats the steam, and some of the waste steam is condensed and turned into the feed. A smoke consumer is also applied to the fire-box.

For farming purposes, Mr. Aveling has introduced a portable engine, made self-propelling by means of an endless chain, and furnished with moveable T-iron paddles, to enable it to cross ploughed fields; it is altogether well adapted for the purpose for which it is intended.

MEETINGS FOR JULY.

Thursday 4th, "On the best means of relieving the Street Traffic of London." By Mr. Rutt. Adjourned discussion.

Thursday 18th, "On Steam Boilers." By Mr. J. C. Fraser.

My experience in road locomotives leads me to the conclusion that to be successful they must have an engine direct acting on to the axle of the driving wheels, have a superheating apparatus, and a working pressure of at least 100lbs., all which distinctive features will be combined in an engine, the design of which I intend shortly to submit to the public. The paper was illustrated by several sketches and diagrams, and the discussion on it was extended over the evening of Thursday, June 20th.

THE LIFE-BELT OF THE NATIONAL LIFE-BOAT INSTITUTION.

Amongst the machinery in use for affording succour to shipwrecked persons, not the least important article is a life-boat, or life-jacket, as it is sometimes termed.

As a person with an efficient life-belt on cannot sink, and can, with little difficulty, maintain an erect position in the water, with the face raised well above it, although unable to swim, it will readily be conceived that, if thrown into the water by any accident, he will have a much better chance of being saved than if not so provided, especially in a rough sea.

Numberless instances have occurred in proof of this statement, but a recent melancholy accident to a life-boat, not belonging to the National Life-boat Institution, when eleven men out of twelve, who formed her crew, perished, they having a life-boat of an inferior description, whilst the only man saved, and who could not swim one yard, had on an efficient belt, has attached to the subject a certain amount of public interest. We think, therefore, that we shall be serving that interest by publishing a description and sketch of the life-belt worn by the fortunate survivor of the life-boat's crew above referred to, similar belts to which have been for the last seven years provided to their boat's crews by the National Life-boat Institution.

Various descriptions of belts, &c., have of late years been designed; but as all are not equally efficient, and especially as all are not alike adapted for the use of a person who must undergo great physical exertion, with his belt on, such as rowing in a boat against a head sea, we will offer an opinion on the qualities which we conceive a boatman's life preserver (and it is such we particularly have in view) should possess.

1st. It should contain as much buoyant power as would support one man, with his head and shoulders above the water, although he might be disabled by injury or otherwise, from swimming, or, as would enable a man, if a swimmer, to support with ease another person beside himself.

2nd. It should not be liable to lose its buoyant property by any accident to to which it might be exposed—such as by a heavy blow, or by absorption of water.

3rd. It should be of such a pliant, elastic, or soft nature as to conform readily to the shape of the body, and not to prevent the free use of the arms and upper part of the person, or to confine the chest, so as to impede the action of the lungs, or which the capability of enduring prolonged exertion or fatigue much depends.

It seems to have been generally supposed that the least possible amount of buoyancy which would suffice to raise the mouth above the surface of the water was all that was required, and, accordingly, many of the belts which are sold in the shops have only buoyant power equal to 6'8 or 10 lbs. A little consideration will, however, make it apparent that the largest amount of buoyancy which can be obtained, without seriously incommoding the wearer, and depriving him of the free use of his limbs, is no more than is requisite.

We believe that a life-belt for an adult person of average size ought to have, at the least, buoyant power equal to 20 lbs., and as much more as can conveniently be obtained.



The belts, as used by the crews of the boats of the Royal National Life-boat Institution, and invented by Captain J. R. Ward, R.N., its Inspector of Life-boats, have much greater buoyancy than any kind of cork belt previously introduced, and have other important peculiarities.

1. Their buoyant power is from 20 to 24 lbs.*

2. The cork is uncovered, so that its quality can always be discerned, and it is divided into many narrow pieces, each of which is separately sewn on to a strong linen or duck belt, covering the body from the arm pits to below the hips.

3. These pieces of cork are distributed in two rows, one above, and the other below the waist, the belt being secured closely about the body by strings passed round the waist, between the two rows of cork, and being further secured by other strings crossed over the shoulders, as men's trouser braces are worn. This division of the cork into two rows is one of the most important distinctions of these belts, as a sufficient quantity of cork to afford double the buoyancy of the ordinary cork belts can be thus attached, and in a manner which is much less inconvenient to the wearer than the lesser quantity in one row, which, not being secured round the waist, but round the chest, interferes with the free action of the lungs, and the muscles of the shoulders and arms. By this arrangement, in these belts, the trunk of the body is enveloped in cork, so attached as to be perfectly flexible, and to allow of all the ordinary movements of the body without inconvenience, whilst it affords great protection to the body against injury from a blow, and is a preservative of its heat in cold weather.

We consider it would be a great boon to the merchant service of our country if every merchant vessel were to have on board, and stowed in a chest on deck, as many of these belts as formed the number of her crew, so that in the event of their having to desert their vessel from wreck, leakage, collision, or fire, and take to their boats, each man might be supplied with an apparatus which, as it would make it impossible for him to sink, would, doubtless, be often the means of saving his life.

CORRESPONDENCE.

We do not hold ourselves responsible for the opinions of our Correspondents.

LOCOMOTIVE PLATE FRAMES.

We have been requested to give place in our columns to the following correspondence:—

MR. BEYER TO MR. ROBERTS.

* * * The locomotive engine frame spoken of by Mr. D. K. Clarke is not the frame used by the late firm of Sharp, Roberts, & Co., composed of a piece of timber, two thin plates, and a lot of bolts and nuts, but the more simple and mechanical framing, now extensively employed, consisting of one single piece of flat wrought iron, usually called the "plate frame."

The latter frame I applied in 1843, and to the best of my knowledge it was then new.

Please take the trouble to look into Mr. Clark's work on the Locomotive Engine, and you will see that none of Beyer, Peacock, & Co.'s engines have the frames which you made use of, and be good enough to do me the justice by correcting, in the next publication, the error you have fallen into in your letter dated April 20.

Gorton Foundry, May 3, 1861.

C. BEYER.

MR. ROBERTS TO MR. BEYER.

* * * On comparing the plate frames made by me in 1833 with those described as your invention, I find them the same in *profile* and *principle*, the only difference being that you make the frame plate of one instead of two thicknesses. This did not appear to me on consulting the drawing referred to, and the photographs of your engines in my office, the axleguards or horn plates of which are formed out of the framing, instead of being bolted on, as in the case of the engines I made. Such being the case, I cannot entirely admit the "error" imputed to me, although quite willing to believe that the alteration you have made, by substituting one plate for two, may be an improvement, but of which I have no experience.

R. ROBERTS.

10, Adam-street, Adelphi, May 28, 1861.

MR. BEYER TO MR. ROBERTS.

* * * I do not find your explanation satisfactory.

I believe I described in my letter to you, dated the 3rd instant, clearly the difference between the locomotive framing used by you and that introduced by me in 1843.

Both kinds of framings are well known, and if you will give my letter of the 3rd instant, and yours of yesterday's date, the same publicity as the one which has led to this correspondence, it will enable those interested in this matter to judge between us, and will save further trouble.

Gorton Foundry, May 29, 1861.

C. BEYER.

* To test its buoyancy, attach a weight equal to from 20 to lbs24, which it will sustain after (say)an hour's immersion.

STEAMSHIP PERFORMANCE.

To the Editor of THE ARTIZAN.

DEAR SIR,—Referring to the letter of our late lamented friend, Admiral Moorsom, in the current number of THE ARTIZAN, upon "Steamship Performance," and to the words following and preceding, "But who are they who possess such factors," I beg to explain that Messrs. Boulton and Watt gave this information to the public several years ago. If your readers will turn to Mr. Bourne's *Catechism of the Steam Engine*, Edition 1856, page 363, or to the recently published edition of THE ARTIZAN "Treatise on the Steam Engine," page 158, table and note, and page 381, chapter 10, they will there find the whole matter fully detailed, and the factors given for the fine types of vessels which were so carefully experimented upon. The classification, indeed, I may say, the suggestion of this plan is due to Mr. Brown, of that firm, under whom I have had the pleasure of serving for the past 36 years, and was therefore present at most, if not all the experiments referred to, and can vouch for their accuracy. Some of these experiments were very interesting, having been made upon ships in which the power had been increased from 100 to 120 horses, 40 to 50 horses, and 200 to 250 horses, and so on; also where the paddle-floats were in two lengths, and the results taken with the inner and with the outer half—indeed, with all sorts of peculiarities; but all this ceased long ago, the truth being made plain, and the laws of the cubes was fully established. I may mention that in 1817, upwards of 500 experiments were made upon the *Caledonian* alone, with varying pressures, wheels, powers, &c.

I am, yours very truly,

W. LANGDON.

18, London-street, City, E.C., June 25, 1861.

STRENGTH OF BOILERS.

To the Editor of THE ARTIZAN.

Sir,—I beg the favour of a corner in your columns to make my meaning clear to "Boiler Maker," who has evidently misunderstood my former letter. I agree with him that the fixed girder *uniformly loaded* is thrice as strong as the supported girder similarly loaded, the strengths being taken at the *centre* of each girder; but he appears to forget that the fixed girder is only half as strong at either point of *fixture* as at the *centre*, and we must take the strength at the weakest part. For an account of the strains on the fixed girder, I will refer "Boiler Maker" to page 78 of the present volume of THE ARTIZAN. Trusting these remarks will prove satisfactory,

I am, Sir, yours,

F. C.

NOTICES TO CORRESPONDENTS.

D. K. CLARK'S ARTICLE ON STEAM.—In some of the numbers of the ARTIZAN previous to June 1st we inadvertently omitted to mention that Mr. Clark's paper was in each case extracted from the 8th edition of the *Encyclopaedia Britannica*; but, at the request of Messrs. A. & C. Black, of Edinburgh, we now make good those omissions.

MISCELLANEOUS.—In the ARTIZAN for May, under the above title, it was inadvertently stated that Mr. J. Haswell of Vienna, had invented the application of a revolving wheel, in the interior of steam boilers for the purpose of increasing the circulation of the water and thereby facilitating the evaporation of water, and the generation of steam, and to prevent the burning of the fire surface plates. This however, appears to have been an error as Mr. Bodmer first applied this invention to marine boilers intended for the Danube Steam Navigation Company about six years ago. We should have stated that it is a modification of Mr. Bodmer's invention, which has been applied for the first time, we believe, by Mr. Haswell, with great success to locomotive boilers, for the purpose of preventing priming and incrustation on the tubes. Mr. Haswell's apparatus consists of a screw with two blades enclosed in a thin case of sheet iron, and has now been at work upwards of twelve months.

OMICRON.—Thanks for your communication and we shall be happy to have the promised particulars.

CALCAR.—We are prevented through want of space giving place to your very interesting communication in our present number.

C.D.C.—*Broxbourne*.—Thanks.—See answer to *Calcar*.

J.H. *Vienna*. We are obliged for your correction. It should have been merely the *novel* application you have made of the invention referred to, which should have been noticed. We will avail ourselves of your suggestion.

G. B.—Your question was as follows:—Given an arc, the cord of which is 50ft. with 15in. rise in the centre,—what will be the rise of a 15ft. cord to the same arc?

h = the rise or perpendicular distance from the centre of the cord to the centre of the arc, in feet.
 c = the cord, in feet.
 r = radius, in feet.

$$\therefore h = \frac{2r - \sqrt{4r^2 - c^2}}{2}$$

$$= \frac{2(209\cdot083) - \sqrt{4(209\cdot083)^2 - 15^2}}{2}$$

$$= \frac{419\cdot166 - \sqrt{174\cdot638\cdot36}}{2}$$

$$= \frac{419\cdot666 - 417\cdot898}{2} = \frac{1\cdot268}{2} = \cdot634 \text{ feet.}$$

$$= 7\cdot608 \text{ inches} = 7\frac{5}{8} \text{ inches nearly.}$$

The formula for finding r is—

$$r = \frac{c^2 + 4h^2}{8h} = \frac{50^2 + 4(1\cdot5)^2}{8(1\cdot5)} = \frac{2500 + 9}{12} = \frac{2509}{12} = 209\cdot083 \text{ feet.}$$

CENSUS OF ENGLAND AND WALES.

Tables of the population and houses enumerated in England and Wales, and in the islands in the British seas, on the 8th April, 1861, have been published, and presented to both houses of Parliament. From the tables have been compiled the following, which must be taken to represent the result of the census according to the statement of the local officers, previous to the revision now in progress.

Table I. comprising the population enumerated on April 8, 1861, in England and Wales, states that the population amounted to 20,205,504 persons; males, 9,825,246; females, 10,380,258. Islands in the British seas, 143,779. The portion of the army, royal navy, and merchant seamen out of the country at the time of the census is not included, and as it appears from official returns that the army abroad amounted to about 137,000, the royal navy and marines absent from the United Kingdom to about 42,900, and the merchant seamen absent on voyages to about 96,000, it may be assumed that the numbers of these classes belonging to England and Wales were collectively not less than 162,021, mostly adult males.

The number of houses enumerated shows 3,745,463 inhabited houses, as against 3,278,039 in 1851, exhibiting an increase in the interval of 467,464.

The table of population at each of the censuses from 1806-61 gives the following results, together with the actual increase and rates of increase in the decimal periods: Population, 1801, 9,156,171; 1811, 10,454,529; 1821, 12,172,664; 1831, 14,051,986; 1841, 16,035,198; 1851, 18,054,170; 1861, 20,223,746. Actual increase in the decennial period 1801-11, 1,298,358; ditto 1811-21, 1,718,135; ditto, 1821-31, 1,879,922; ditto 1831-41, 1,983,212; ditto 1841-51, 2,018,972; ditto 1851-61, 2,169,576. Decennial rates of increase: 1801-11, 14 per cent.; 1811-21, 16 per cent.; 1821-31, 15 per cent.; 1831-41, 14 per cent.; 1841-51, 13 per cent.; 1851-61, 12 per cent.

Table VIII., giving the number of houses and population in the principal cities and boroughs having defined municipal or parliamentary limits, states the population of London to be 2,803,034 in 1861, as against 2,362,236 in 1851; inhabited houses in 1861, 362,890; in 1851, 305,933.

Under the return of houses and population in the Superintendent-Registrar's districts on March 31, 1851, and on April 8, 1861, the London division shows the subjoined results:—

	Population enumerated.		Increase or Decrease in the Number of Persons between 1851 and 1861.	
	1851.	1861.	Inc.	Dec.
MIDDLESEX (part of).				
Kensington.....	120,004	186,463	66,459	—
Chelsea.....	56,538	63,423	6,885	—
St. George's, Hanover Square..	73,230	87,747	14,517	—
Westminster.....	65,600	67,676	2,067	—
St. Martin-in-the-Fields.....	24,640	22,636	—	2,004
St. James, Westminster.....	36,406	35,324	—	1,082
Marylebone.....	157,696	161,609	3,913	—
Hampstead.....	11,986	19,104	7,118	—
Paneras.....	166,956	198,882	31,296	—
Islington.....	95,329	155,291	59,962	—
Hackney.....	58,429	83,295	24,866	—
St. Giles.....	54,214	53,981	—	233
Strand.....	44,417	42,956	—	1,461
Holborn.....	46,621	44,861	—	1,760
Clerkenwell.....	64,778	65,632	854	—
St. Luke.....	54,055	56,997	2,942	—
East London.....	44,406	40,673	—	3,733
West London.....	28,833	27,144	—	1,689
London City.....	55,932	45,550	—	10,382
Shoreditch.....	109,257	129,339	20,082	—
Bethnal-green.....	90,193	104,905	14,712	—
Whitechapel.....	79,769	78,963	—	796
St. George-in-the-East.....	48,376	48,878	502	—
Stepney.....	54,173	56,567	2,394	—
Mile-end Old Town.....	56,602	73,064	16,462	—
Poplar.....	47,162	79,182	32,020	—
SURREY (part of).				
St. Saviour, Southwark.....	35,731	36,026	295	—
St. Olave, Southwark.....	19,375	19,053	—	322
Bermondsey.....	48,128	58,355	10,227	—
St. George, Southwark.....	51,824	55,509	3,685	—
Newington.....	64,816	82,157	17,341	—
Lambeth.....	139,325	162,008	22,683	—
Wandsworth.....	50,764	70,381	19,617	—
Camberwell.....	54,667	71,489	16,822	—
Rotherhithe.....	17,805	24,500	6,695	—
KENT (part of).				
Greenwich.....	99,365	127,662	28,297	—
Lewisham.....	34,835	65,752	30,917	—

The Superintendent-Registrars' districts are grouped together in eleven divisions, each comprising the whole, or nearly the whole, of the several counties named. In the columns showing the ascertained increase of population, and the ex-

cess of births over deaths in these divisions, may be traced the powerful stream of immigration into the principal centres of trade and the seats of mining and manufacturing industry. Thus, in London, where the excess of registered births over deaths was 253,989, the influx of persons from other parts had raised the actual increase to 440,798; in the Eastern division, consisting of the counties of Essex, Suffolk, and Norfolk, the ascertained increase was only 28,220, while the natural increase or excess of births over deaths was 129,726.

According to the returns of the Emigration Commissioners 2,249,355 emigrants sailed from the ports of the United Kingdom in the interval between the census of March 31, 1851, and the census of April 8, 1861. But 194,532 of the number were probably of foreign origin, leaving 2,054,823 emigrants from the population of the United Kingdom; of whom about 640,210 were of English origin, 183,627 were of Scotch origin, and 1,230,986 were of Irish origin.

REVIEWS AND NOTICES OF NEW BOOKS.

The Practice of Hand Turning in Wood, Ivory, Shell, &c.: With Instructions for Turning such Works in Metal as may be required in the Practice of Turning in Wood, Ivory, &c. With an Appendix on Ornamental Turning, &c. By F. CAMPIN. E. & T. N. Spon, Bucklersbury.

We have looked through Mr. Campin's work, and can recommend a perusal of its contents, as being very useful indeed to the amateur turner in wood or metal. It possesses, also, the recommendation of being much less bulky and costly than Holtzapffel's more complete work upon the same subject.

A Rudimentary Treatise on the Metallurgy of Silver and Lead. By DR. ROBERT H. LAMBORN.—JOHN WEALE, High Holborn, 1861.

The author, whose treatise on the metallurgy of copper has been so well received and become a recognised hand-book, has done good service by under-taking to give a general view of the present condition of the metallurgy of silver and lead, which he has successfully treated in his present work with his well-known ability.

RECENT LEGAL DECISIONS

AFFECTING THE ARTS, MANUFACTURES, INVENTIONS, &c.

UNDER this heading we propose giving a succinct summary of such decisions and other proceedings of the Courts of Law, during the preceding month, as may have a distinct and practical bearing on the various departments treated of in our Journal: selecting those cases only which offer some point either of novelty, or of useful application to the manufacturer, the inventor, or the usually—in the intelligence of law matters, at least—less experienced artisan. With this object in view, we shall endeavour, as much as possible, to divest our remarks of all legal technicalities, and to present the substance of those decisions to our readers in a plain, familiar, and intelligible shape.

RE YOUNG'S PATENT FOR THE MANUFACTURE OF PARAFFINE OIL.—An application was made to Sir R. Bethell, Her Majesty's Attorney-General, on the part of Mr. Gillespie of Torbane Hill, for leave to issue a writ of *seire facias* to repeal Mr. Young's Patent. This patent, which as is well known has been the subject of great litigation, is for the treatment of bituminous coals, so as to obtain therefrom paraffine oil, and from which oil paraffine is obtained. Prior to Mr. Young's patent solid paraffine was only known as a laboratory curiosity, and probably not more than a few pounds of it were in existence. At the present time it is produced by Mr. Young and his partners at the rate of several tons a week. The oil now so universally known as paraffine oil was also quite a novelty, so far as any purposes of utility were concerned. The bituminous coals, at present principally employed in this manufacture, are the well-known Boghead or Batgate gas coal, and Mr. Gillespie is the owner of a small portion of the coalfield. It may be mentioned that several years ago, and prior to the date of Mr. Young's patent, Mr. Gillespie granted a lease of the lands from which the coal is excavated to Messrs. Russell and Co., from whom Mr. Young and his partners have been in the habit of purchasing the largest portion of the coal used by them. Mr. Gillespie, it seems, has thought proper to attack the patent in Scotland, by an action of declarator and reduction in the Court of Session, and concurrently to apply to the Attorney-General for leave to sue out a writ of *seire facias*, which, if successful in inducing a jury to find in his favour, he would quash the patent. The "reasons" assigned by him were that, Mr. Young was not the inventor of the use of bituminous mineral substances for obtaining paraffine, and paraffine oil, the use of such substances for such purposes having been published and known long before the date of his patent; and that the interests of Mr. Gillespie were prejudicially affected by the said patent, and the illegitimate use made thereof to interfere with the sale and use of the Torbane Hill mineral found on his lands. On the 30th of May last, Mr. Ashton appeared before the Attorney-General to support the application. After hearing Mr. Ashton at length, and without calling on Mr. Young's counsel to reply, the Attorney-General, after the summing up, was of opinion that he ought to refuse the application.

PYM v. THE GREAT NORTHERN RAILWAY COMPANY.—This action was tried in the Court of Queen's Bench, on the 15th ult. The plaintiff in this action is the widow of the late Mr. Pym, a gentleman who possessed considerable landed property. On the 23rd of April, 1860, Mr. Pym was a passenger by the Manchester express train to Hitchin, and was killed by an accident which occurred on that journey, and the present action was brought by Mrs. Pym to recover damages from the loss which herself and nine children had sustained by his death. Evidence was given that the train was going at the rate of fifty miles an hour, and that the carriage in which Mr. Pym was travelling was thrown off the line, and dragged a distance of about 145 yards on its side, and that during its progress the door on one side was crushed, and the deceased thrown out on to the line, and found in a dying state. In order to show the defective state of the rail, evidence was given that it was cracked and bulged, and that in consequence of the defective state in which it was, orders had been given by the inspector to take it up and replace the whole crossing, of which it formed a part, and that the workmen were actually employed in preparing for so doing when the accident occurred. For the defence it was partially admitted that, although the rail was defective, it was not so bad as was represented. After a careful summing up from the Lord Chief Justice, the jury found a verdict for the plaintiff, damages, £13,000, being £1000 for the plaintiff, and £1500 for each of the children.

NOTES AND NOVELTIES.

OUR "NOTES AND NOVELTIES" DEPARTMENT.—A SUGGESTION TO OUR READERS.

We have received many letters from correspondents, both at home and abroad, thanking us for that portion of this Journal in which, under the title of "Notes and Novelties," we present our readers with an epitome of such of the "events of the month preceding" as may in some way affect their interests, so far as their interests are connected with any of the subjects upon which this Journal treats. This epitome, in its preparation, necessitates the expenditure of much time and labour; and as we desire to make it as perfect as possible, more especially with a view of benefiting those of our engineering brethren who reside abroad, we venture to make a suggestion to our subscribers, from which, if acted upon, we shall derive considerable assistance. It is to the effect that we shall be happy to receive local news of interest from all who have the leisure to collect and forward it to us. Those who cannot afford the time to do this would greatly assist our efforts by sending us local newspapers containing articles on, or notices of, any facts connected with Railways, Telegraphs, Harbours, Docks, Canals, Bridges, Military Engineering, Marine Engineering, Shipbuilding, Boilers, Furnaces, Smoke Prevention, Chemistry as applied to the Industrial Arts, Gas and Water Works, Mining, Metal lurgy, &c. To save time, all communications for this department should be addressed "19, Salisbury-street, Adelphi, London, W.C." and be forwarded, as early in the month as possible, to the Editor.

MISCELLANEOUS.

REAPING AND MOWING MACHINES.—An interesting paper on these machines was read before the Newcastle Farmers' Club, on the 1st ult., by Mr. J. Wilson of Woodburn. Mr. Wilson was at much pains in tracing former attempts at reaping down to the invention of the famous Hussey, in 1833. The earliest proposal for a mechanical reaping machine in Great Britain appeared to be described in Arthur Young's "Annals of Agriculture," in 1785, the Society of Arts having previously offered a gold medal or a premium of £50 for a machine for mowing or reaping grain crops. This was taken up in 1785, by Mr. Capel Loft, who combined the principle of reaping with that of reaping, leaving the straw to be collected at leisure. Referring to the most popular reaping machines of the day, Mr. Wilson divided them into two classes,—first, self-delivering machines, including Bell's, Burgess and Key's, Lord Kinnard's, Bright's, Atkins', Samuelson's, &c. Secondly, manual delivery machines, including Clithbert's, Trotter's, Wood's, Gardner and Lindsay's, Kemp, Murray and Nicholson's, Dray's, Stocker's, and Gibson's. As regards the first class of machines, Mr. Wilson remarked that Bell's implement was not nearly so popular in England as in Scotland, where it was extensively used; but wherever he had seen it at work, he had invariably been of opinion that the man at the helm did not enjoy a sincere, especially in her working on ridge and furrow. Its price was £40. Burgess and Key's machine was an improvement upon the original McCormick, by the addition of the Archimedean screw and other parts. It was self-acting, cutting and laying the corn in a continuous swath, at the rate, upon an average, of one and a half acres per hour. Mr. Wilson then stated that having seen it extensively used, he hesitatingly gave Burgess and Key's machine a preference for large farms over any other that had as yet come under his notice. Lord Kinnard's machine consisted also of McCormick's cutting parts, with the assistance of his Lordship's patent delivery, which was by means of endless bands, passing over a smooth surface, similar to Bell's. Mr. Gibson, of Newcastle, was this year bringing out a machine which might be called a "semi self-delivery," inasmuch as it required a man to ride on the machine to drop the rake in a proper position, so that it might afterwards sweep the corn off the platform by mechanical force. In the manual delivery class, Cuthbert's machine might be said to stand pre-eminent, being an improvement on the original Hussey, by making the drawing wheel of a larger diameter, and thus avoiding the liability to sledge on soft lands, or choke when running in a furrow. The department of mowing machines might be said to include two at the present time in England, namely, Wood's and Burgess and Key's. The former was a nice machine of light draught, and gave general satisfaction. The latter, however, was more generally used, being more simple and durable.

THE EXHIBITION OF 1862.—The following are some of the materials required in the construction of this enormous building. The foundations have already consumed 5000 tons of concrete, which, at the first time, is pretty fair. On these foundations will be laid nearly 60,000 tons, or 1,400,000 cubic feet, of brickwork, requiring upwards of 18,000,000 bricks to build it. To 18,000,000 bricks no less than 22,000 tons of mortar will be requisite. 10,000 tons of ironwork, viz., about 7000 tons of cast, and 3000 tons of wrought iron—will be used in the entire structure. As there are nearly 1,200,000 superficial feet of flooring, the same amount of timber as of iron is required—namely, 10,000 tons. The flooring along consumes 360 miles of planking, 7in. wide, and 270 miles' length, 9in. wide, or upwards of 600 miles' length of planking in all. The actual quantities are 1,200,000 and 2,000,000 lineal feet of each kind. For the windows no less than 103 miles' length, or 600,000 feet, of sashing will be required, to fill in which are required 500 tons of sheet glass and upwards of 50 tons of putty. The roof will need 600,000 square feet of felt; and among the minor items are between 200 and 300 tons of nails, 600 tons of paint, 300 tons of piping and so on. The cubical contents of the whole structure will be no less than 73,000,000 cubic feet.

CEMENT FOR RENDERING JOINTS STEAM-TIGHT.—The following receipt, forms a strong and durable cement for joining the flanches of iron cylinders of steam engines or hydraulic machines:—Mix boiled linseed oil, litharge, red and white lead together, to a proper consistence, always using a large proportion of white lead. This composition may be applied to a piece of flannel, and fitted to the joints. Cisterns built of large square stones, and put together with this cement, will never leak. When the cement is wanted for use, dissolve a portion of the paste in the water rendered slightly acid, and add a quantity of iron turnings or filings, sifted or powdered, to render the particles of uniform size. This mixture, put into the interstices of iron-work, will, in a short time, become as hard as stone. From experience, it is ascertained that in all cases of cement joint making it depends more upon caulking the joints than in mixing the cement.

GENERATION OF STEAM BY MEANS OF GAS.—A very interesting and important invention for applying steam generated by the heat from gas to engines was tried recently, at Messrs. James Taylor & Co., Britannia Works, Birkenhead. The engine to which the apparatus was attached was one employed for hoisting purposes, and from the satisfactory results obtained it bids fair to be generally adopted in warehouses with very great advantages. The patentee is Mr. Arthur Jackson, of Liverpool. The safety and cleanliness of gas, compared with coal, are in themselves a powerful recommendation in its favour. It is anticipated that the great rapidity with which the carts, &c., will be discharged will form one of the advantages of the apparatus in a local point of view, as it will tend to prevent the streets being choked up by carts, &c., waiting to be unloaded.

THE EXPORT TRADE.—It is only by making a detailed examination of the various branches of the export trade that their prodigious growth during the last fifteen or sixteen years can be fully appreciated. Comparing 1860 with 1845, the value of the exports of apparel, haberdashery, and millinery, increased 286 per cent.; beer and ale, 316 per cent.; brass and copper manufactures, 76 per cent.; coals, coke, and culm, 242 per cent.; cotton manufactures, 120 per cent.; cotton twist and yarn, 80 per cent.; earthenware and porcelain, 74 per cent.; hardware and cutlery, 73 per cent.; iron and steel, 246 per cent.; leather and leather wares, 361 per cent.; linen manufactures, 60 per cent.; linen yarn, 80 per cent.; silk, 412 per cent.; silk manufactures, 163 per cent.; woollen manufactures, 57 per cent.; machinery, 325 per cent.; and woollen and worsted yarn, 200 per cent.

SOCIETY OF ENGINEERS.—On the 11th ult. this society held their first *conversazione* in the lower hall, Exeter Hall. Nearly 200 persons were present, of whom fully one-half were members of the society. An interesting and large collection of models, photographs, drawings, and diagrams, which underwent careful examination, added materially to the interest of the occasion. About 80 new members joined the society last year, and it now numbers 220, and is in a highly prosperous condition.

UNITING PIPES OR TUBES.—Mr. A. Delaporte, of Paris, proposes to unite pipes or tubes by means of a collar free to slide along the tubes, and so formed as after being brought over the abutting ends of any two pipes required to leave a space between the inner surface and the pipes. Mastic or cement being poured into a collar through an aperture provided for the purpose, a permanent joint is formed.

ROTARY ENGINE.—Messrs. Grande, Olivieri, and Mongardino, Turin, propose in a circular machine or box a solid iron bar in the form of a semicircle, occupying half of the circumference of the box; the object of the bar is to force the steam which issues from the top of the box to bear continually on one side only. This machine or box contains a concentric wheel fixed immovably to an axle, being fitted with two pairs of articulated valves diametrically opposite to each other, and which, occupying successively the space in which the steam circulates, are forced by the current to give a rotary motion to the axle.

HIGH PRESSURE ENGINES AND BOILERS.—We have been furnished with the following table by Messrs. York & Co., of Royal Exchange Buildings, relating to Benson's boilers. This table gives at a glance a good idea of how much fuel can be saved by the use of steam of very high pressure, with a high degree of expansion, moderately superheated, and in cylinders protected by steam jackets; for although a boiler generating steam of 140 lbs. pressure, which is cut off in the cylinder at $\frac{1}{2}$ part of the stroke, produces four times the I.H.P. of a boiler generating steam of 20 lbs. pressure, cut off at $\frac{1}{4}$ ths of the stroke, the engine only uses the same number of pounds' weight of steam for each stroke of the piston. The boiler and engine also are specially applicable to cases where space is small and expensive, and for factories and other premises where much power is required. The use of this boiler and small engines attached to each main line of shafting, and worked at high velocity, with 120 to 150 lbs. of steam to the inch, superheated and used expansively, would save both space and fuel, but the leading advantage in many instances would be when required to stop any part of the works for repairs or other purposes; the remaining portions of the works could still be in motion, as each main shaft or shafts in each room would be driven by an independent engine.

Boiler.	Grate Area.	Ft. of Grate Area per I.H.P.	Steam Pressure.	Cut off.	Total I.H.P. of Boiler.	Boiler.	Grate Area.	Ft. of Grate Area per I.H.P.	Steam Pressure.	Cut off.	Total I.H.P. of Boiler.
No. 1.	11	0.79	20	7/8	14	No. 5.	29.8	0.71	20	7/8	42
"	"	0.42	40	9/16	26	"	"	0.38	40	9/16	78
"	"	0.3	60	3/8	37	"	"	0.27	60	3/8	110
"	"	0.24	80	5/16	45	"	"	0.22	80	5/16	135
"	"	0.22	100	1/4	50	"	"	0.19	100	1/4	156
"	"	0.21	120	3/16	53	"	"	0.19	120	3/16	161
"	"	0.2	140	1/6	56	"	"	0.17	140	1/6	168
No. 2.	15.3	0.74	20	7/8	21	No. 6.	34.5	0.7	20	7/8	49
"	"	0.4	40	9/16	39	"	"	0.38	40	9/16	80
"	"	0.31	60	3/8	51	"	"	0.27	60	3/8	126
"	"	0.23	80	5/16	67	"	"	0.22	80	5/16	157
"	"	0.21	100	1/4	75	"	"	0.2	100	1/4	181
"	"	0.19	120	3/16	81	"	"	0.18	120	3/16	188
"	"	0.18	140	1/6	84	"	"	0.17	140	1/6	196
No. 3.	20.3	0.73	20	7/8	28	No. 7.	39.3	0.7	20	7/8	56
"	"	0.39	40	9/16	52	"	"	0.39	40	9/16	102
"	"	0.27	60	3/8	75	"	"	0.26	60	3/8	150
"	"	0.23	80	5/16	90	"	"	0.22	80	5/16	180
"	"	0.2	100	1/4	100	"	"	0.2	100	1/4	200
"	"	0.19	120	3/16	107	"	"	0.18	120	3/16	214
"	"	0.18	140	1/6	112	"	"	0.17	140	1/6	224
No. 4.	25	0.71	20	7/8	35	No. 8.	44	0.7	20	7/8	63
"	"	0.38	40	9/16	65	"	"	0.39	40	9/16	114
"	"	0.27	60	3/8	91	"	"	0.27	60	3/8	166
"	"	0.22	80	5/16	112	"	"	0.22	80	5/16	202
"	"	0.2	100	1/4	125	"	"	0.2	100	1/4	225
"	"	0.19	120	3/16	134	"	"	0.18	120	3/16	240
"	"	0.18	140	1/6	140	"	"	0.17	140	1/6	252

A FINE NEW IRON LANNING STAGE, designed by Mr. Finch, of the firm of Finch & Heath, of Chepstow, has lately been opened at Newport, South Wales. It was erected for the Bristol Steam Navigation Company, and accommodates their boats through a range of tide of about 50ft. It is an iron pontoon rising and falling with the tide, and measures 65ft. long, 16ft. wide, and 5ft. deep. It is connected with the masonry of the pier by a bow-striking lattice bridge, 91ft. long, 9ft. wide, and capable of supporting 450 people. The whole cost of this work has been about £2000.

STEAM SHIPPING.

NEW STEAM NAVIGATION COMPANY.—Proposals have been issued for subscriptions to the River Salado Steam Navigation Company, constituted with a capital of £240,000. The object is to introduce an effective steam boat system on the River Salado, which is navigable for 1,100 miles through the most important interior provinces of La Plata, and joins the Parana about 250 or 300 miles above Buenos Ayres. It is stated that at present the consumption of European articles in the districts connected with the Salado is £1,200,000 per annum, while the average export of produce, much of which now takes its way via the Pacific, exceeds £1,600,000, and is capable of almost indefinite increase.

THE "PROBE," 51.—The engines of this screw steam frigate having been completed, a trial took place in Keyhan Basin on the 1st ult. The vessel has been lengthened 60ft. in three different places—forward, aft, and amidships. She is now 240ft. long between the perpendiculars, 206ft. for tonnage, 51ft. 6in. extreme breadth, 51ft. for tonnage, and 50ft.

moulded; depth of hold, 17ft. 2in., and burden 2843 tons. The engines, by Messrs. R. Napier & Son, of Glasgow, are of 500 horse power nominal, but capable of working up to 2,100 horses. The length of the screw shaft is 96ft.; diameter, 12in.; diameter of the screw, 18ft.; pitch of the screw (Griffith's), 23ft. The engines of the *Phæbe* are similar to those on board the *Royal William*, *Orestes*, and several other gunboats.

THE "DUNCAN."—The result of the series of trials with the *Duncan*, which has lately been concluded, is to prove that whatever advantage may have been gained by the three-bladed over the two-bladed propeller, it is more than counterbalanced by the impossibility of raising the screw when the ship might be at sea under canvas, and the frequent necessity its use would impose of docking the ship.

PENINSULAR AND ORIENTAL STEAM COMPANY.—This company's fleet now numbers 52 steamers, of 70,479 tons and 17,111 horse power, and eight transport, store, and coal ships, of 10,277 tons.

THE "RINALDO," 17, screw, made her official trial of speed on the 6th ult., at the measured mile in Stokes Bay. The mean results of the run gave the ship a speed of 10 knots, at a draught of water of 15ft. 9in. aft, and 13ft. 8in. forward. The machinery worked satisfactorily. At her steam reserve trial on the 8th of August, 1860, she realised a speed of 11.781 knots, but at a draught of water of only 12ft. 6in. aft, and 10ft. 6in. forward.

MR. SCOTT RUSSELL has lately commenced the construction of an iron screw steamer of the following dimensions:—200ft. long, 30ft. beam, 10ft. depth, 100 H.P., and 850 tons. Her screw will be made to lift on a new principle—by means of a joint some distance up the rod, by which, when being lifted, the screw will describe a part of a circle.

THE "WESTERN" SCREW STEAMER made a trial trip on the 11th ult., attended with the most successful results. This vessel, which is fitted with Rowan's patent engines (by R. Stephenson and Co.) of 110 H.P., is intended for the Australian passenger trade. The following are the results of the trial:—Mean of all the runs, 10.9 knots; coal consumed during four hours trial, exactly 6tons. During this time the indicated H.P. was 380 = 1.42lbs. of coal per I. H.P. per hour. Afterwards she ran for speed alone, and attained 12 knots.

THE *PHLETON*, 51, screw steam frigate, 400 H.P., attached to the steam reserve at Chatham, is ordered to have her 95cwt. pivot gun taken out, and its place supplied by a 100-pounder Armstrong rifled gun; she is also to be furnished with two 40-pounder Armstrong guns.

THE *DRAGON*, 6, paddle-wheel steamer 560 H.P., in lieu of four 10in. guns, and two 68 pounders, is to be supplied with two of the 100-pounder rifled Armstrong guns; she will also receive two 24-pounder howitzers and one 12-pounder howitzer, as well as one 6-pounder brass gun for her pinnaces and launches.

THE *OCEAN*.—Orders have been received at Devonport, for converting the *Ocean*, 91, laid down as an ordinary screw steam ship, into an iron-plated vessel. As the vessel is not far advanced the alterations will not involve much loss. As there are 1000 tons of iron plates to be used, this weight will be met by an addition of 60 feet to the length of the vessel, which will now be 275 feet. She will also be reduced one deck from the original design.

IN ANTIPODES to the *Achilles*, 40, iron steamer, and the *Royal Oak*, 50, iron plated frigate in progress at Chatham, the Lords of the Admiralty have given directions for the following line-of-battle and other steamers to be built at the same dockyard:—The *Pitt*, 91; the *Baudica*, 50; the *Pomona*, 51; the *Ganymede*, 28; the *Talmonth*, 22; the *Tees*, 19; the *Diligence*, 17; the *Albatross*, 4; and the *Salanus*, 4.

THE *ORESTES*, 121, screw corvette, 400 H.P. is ordered to be supplied with the following armament from Chatham, viz.:—One 100-pounder Armstrong rifled gun, and twenty 8in. guns, each of 60cwt., in addition to which she will be furnished with two brass howitzers, one a 24-pounder, and the other a 12-pounder, and one brass 6-pounder gun for the pinnaces and launches.

THE *CYGNET*, 5, screw, was tested on the 11th ult. at the measured mile in Stokes Bay, and attained a speed of rather over 9½ knots. She carries two 25-pounder Armstrongs as pivot guns.

FRENCH STEAM SERVICE ON THE INDIAN OCEAN.—The French minister of finance has recently entered into a contract with the Company des Services des Messageries Impériales, by virtue of which a postal service will shortly be established between Suez and Saigon, in Cochinchina, with branches from Aden to Réunion and the Mauritius; from Point de Galle to Calcutta, touching at Madras and Pondichery; from Singapore to Batavia; from Sargan to Manila; and finally from Sargan to Hong Kong and Shanghai. This postal service will be carried on by twelve steamers of 3,625 H.P., making monthly voyages.

THE RUSSIAN NAVY.—The Russian Admiralty by an official report, states that, including the ships in course of construction, the Russian navy was thus composed in 1860:—

STEAMERS.		SAILING VESSELS.	
Ships of the Line.....	9	Liners.....	10
Frigates.....	13	Frigates.....	6
Corvettes.....	22	Corvettes.....	3
Clippers.....	12	Brigs.....	5
Steam Frigates.....	9	Schooners.....	17
Gunboats.....	79	Luggers.....	2
Yachts.....	2	Lenders.....	3
Schooners.....	25	Transports.....	13
Transports.....	8	Yachts.....	2
Small Craft.....	49		
Sloops and Barges.....	11		
Floating Docks.....	3		
		Total	71

Total 242

Total of steam and sailing vessels, 313, carrying 3851 guns. The steamers were of 36,935 horse power. Besides these, the Russian Government owns 474 ships for service in the different harbours, and for transport. In the course of 1860, 156 vessels of different size and class (among which seven liners, six frigates, &c.) were fully equipped for sea. Of these twenty-nine were sent out for long voyages.

THE "OCEAN," 91, SCREW STEAM SHIP.—The keel of this vessel, being converted into an armour cased frigate, is laid, and she is about two-fifths or nearly half in frame. It will be necessary now to take down the fore part of the frame for the purpose of lengthening. Her altered dimensions will be, length between the perpendiculars from the fore part of the stem to the after part of the stern post at the broad line, 273ft.; length of keel for tonnage, 233ft. 5-8ths.; breadth, extreme, 58ft. 5in.; for tonnage, 57ft. 2in.; moulded, 56ft. 4in.; depth of hold, 19ft. 10in.; burden in tons, 105 26-94. The ship will be cased throughout, from three to four feet below the water line up to the plank sheer. The plates are to be 4½in. thick on 8in. flanking. She is technically called an "iron cased 60-gun ship," but will probably carry not more than 32 of the newly invented guns.

THE "CANADIAN," mail screw steamer, belonging to the Montreal Ocean Steam Navigation Company, was lost on the 5th ult., about 5 miles off Belle Isle. The *Canadian* was going "dead slow," the weather at the time being thick, and a short sea on, when she struck a large piece of sunken ice, the top of which was flush with the water, and which appears to have ripped up the bottom of the vessel to a large extent, causing her to sink almost immediately. One of her boats, in being lowered, capsized on being let loose from the davits, and all on board, mustering above thirty, perished. The *Canadian*

was built by Messrs. Steele & Co., of Greenock, and sailed on her first voyage in March, 1860. She was nominally of 2000 tons burden and 400 horse power, and valued at about £60,000.

THE "DEFENCE," iron mail-clad steamer, is to have her masts, yards, and gear supplied from Cbatham Dockyard, and workmen are now engaged in preparing her yards, &c. Her lower masts and bowsprit are to be of iron. She will be furnished with two pivot, and 16 100-pounder Armstrong rifled guns, four 40-pounders, one 25-pounder, and one 12-pounder.

THE "ROTHESAY CASTLE."—This celebrated new river steamer, built and engine by Messrs. W. Simons & Co., was for the first time tried between the Lights on the 17th ult., and accomplished a speed of 20.1-8th. miles per hour, consuming during the run the ordinary quantity of steam coals.

THE "ALARM," river steam tug, was lying at Bristol on the 15th ult., under the bow of the West Indian *Minerva*, when those on board were alarmed by a tremendous noise. They saw, at the same time, the various parts of a steamer blown in the air. One fragment was projected over the funnel of a large steamer, and fell upon a warehouse at Radcliffe Wharf, destroying about 50ft. of shedding. There were four men and a boy on board at the time; the boy, being below, went down with the vessel, and the men, though bound a considerable distance from the vessel, but alighting in the water, were not seriously injured. It is supposed that the cause of the accident was the boy, who, being a stranger, is supposed to have meddled with the machinery.

LANCHES OF STEAMERS.

THE "VILLAGE BLACKSMITH," iron screw, was launched a few days since from the building yard of Mr. Oswald, at Pallion. This vessel is of 880 tons, N.M., 978 B.M., 214ft. long between perpendiculars, 220ft. over all, 31ft. in breadth, 18ft. in depth, fitted up with direct acting engines of 120 nominal H.P. by Richardson & Sons, of Hartlepool. She is intended for the London and Baltic trade.

THE "PRINCE OF WALES" iron paddle was successfully launched on the 8th ult., from the building-yard of Mr. Lunley, Deptford. This vessel is intended for the Hunter River (Australia) Steam Navigation Company. Her engines were made by Messrs. Dugdon & Co., and are oscillating, with 45in. cylinder, and 5ft. stroke. The paddle-wheels are provided with feathering floats. The following are her dimensions:—Length on water-line 210ft.; length over all, 232ft.; breadth on deck, 27ft.; breadth at water-line, 25ft.; breadth outside paddle-boxes, 44ft. 6in.; draft of water, light, 5ft. 9in.; do. loaded, 7ft. 6in.; builder's tonnage, 648; gross register, 549.

RAILWAYS.

THE LEASE OF THE WEST MIDLAND RAILWAY to the Great Western Company has lately been approved by the shareholders of both companies. The lease is for 999 years, the Great Western to have 81½ per cent., and the West Midland 17½ per cent., of the net receipts of both companies.

THE FRENCH GOVERNMENT have issued a return of the traffic on the railways in France during the first quarter of the present year, which shows an augmentation over the same period of 1860 of 2.65 per cent. in the mileage, and of 13.28 per cent. in the receipts. The increase has occurred principally on the old lines.

RAILWAYS IN INDIA.—The sums which have been from time to time advanced by the Government of India for payment of the guaranteed interest to the railway companies amounted at the end of last year to £5,299,709; namely, East Indian Railway Company, £2,736,059; Great Indian Peninsular, £1,207,328; Madras, £778,092; Bombay, Baroda, and Central India, £232,412; Scinde, £159,420; Punjab, £73,403; Eastern Bengal, £55,544; Indus Steam Flotilla, £23,740; Great Southern of India, £19,169; and Calcutta and South Eastern, £14,042. But from this advance of £5,299,709 must be deducted the net profits of the railways which have been received by the Government, and which amounted a year ago to £880,931. The annual sum payable by the Government to the shareholders for interest was about £1,450,000 at the beginning of this year, and by the end of the year it will amount to £1,900,000 a year; but the profits for the railways for the year 1860-61 (June to June) are expected to be £400,000. It is hoped that, as soon as the railways are completed, and in working order, they will pay the guaranteed interest as it accrues, and that the large arrears due to the Government will be ultimately repaid out of half the excess profits above five per cent.

THE NEWCASTLE, DERWENT, AND WEARDALE RAILWAY BILL was passed by the Committee on the 21st ult., and the competing line of the North-Eastern Railway from Blyden to Coside was thrown out.

THE CARLISLE AND SILLOTH BAY RAILWAY AND DOCK BILL has been thrown out by the Committee.

RAILWAY ACCIDENTS.

A FATAL ACCIDENT took place on the morning of the 11th ult., on the Coventry and Leamington branch of the London and North-Western Railway. It appears that between Leamington and Kenilworth, which are distant from each other between five and six miles, there is a road passing between the embankment of the railway, crossed over by the line by means of a wooden bridge. Shortly before day-break the fast up goods train, consisting of the engine and tender and several trucks laden with general goods, left Leamington on its way to Coventry for London and other places, and proceeded at its usual speed, when, on arriving at the wooden bridge in question, the bridge suddenly gave way, and the engine and tender followed, by which a considerable portion of the train was precipitated to the ground beneath, with a tremendous crash, which was heard both at Kenilworth and Leamington stations. The only other persons with the train, besides the engine driver and the fireman, were the guard and porter, who, fortunately for themselves were in the break at the rear of the train, and which, by force of the collision with the preceding part and snapping of the coupling irons, was driven back upon the rails. Assistance speedily arrived from both stations and the line was at once blocked at each end. The bodies of the engineer and fireman were found in the midst of the debris of the fallen bridge and engine, mutilated as well as scalded in so frightful a manner that death must have been instantaneous.

FATAL ACCIDENT AT GRATELEY.—On the evening of the 5th ult., a goods train left Grateley Station, on the South Western Railway. On reaching Andover the engine-driver discovered that only a portion of the carriages were attached to the locomotive. He slung back for the remainder, expecting to find them on the spot where they had become detached. Unfortunately, however, the station master proposed to allow the carriages to run on slowly after the train, which they could do, as the line slopes gently all the way to Andover. He, the porter at the station, and the breaksmen, got into them and lifted the break. There is only one line, and, as the engine was coming up the decline with speed, the two parts of the train came into violent collision. The engine drove seven of the descending carriages off the line, smashing them into pieces. When it stopped, the driver and porter, who were uninjured, got down and found the station master lying dead between two carriages, and the breaksmen insensible under a wagon which had been pitched over that on that which he sat. Owing to the serious injuries the breaksmen has received, there are no hopes of his recovery.

FRIGHTFUL ACCIDENT ON THE NORTH STAFFORDSHIRE RAILWAY.—An accident occurred a few miles from Burton-on-Trent, on Friday, 21st ult., to the 7.5 p.m. passenger train, running from the above named junction to Tutbury, to catch the main trains from Derby to Crewe, Chester, Liverpool, and Manchester. The engine and guards' van broke away from the passenger carriages, and tumbled one on the top of the other, down an embankment, 20ft. deep. The driver, John Smith, was scalded, or rather boiled to death by the steam which escaped before he could be extricated. The stoker, John Tams, was

taken out alive; but the guard, Robert Gardner, was crushed to death on the spot. The stoker was at once conveyed to Tutbury, where he died next day. The passengers escaped in a miraculous manner; although most of them are seriously injured, there is no apprehension of any fatal consequences. The accident, it appears, was caused by the engine running off the line, but how, or in what way, is at present a mystery.

ALARMING RAILWAY COLLISION.—On the 23rd ult. a collision of an alarming character took place at the junction of the South-Eastern and South Coast lines, near the St. Leonard's station. An excursion train on the South Coast line was, at present, half an hour behind time, and, after setting down passengers at St. Leonard's, proceeded on its way to Hastings, and was slowly entering the tunnel, when a South-Eastern excursion train, which had been deserted by the engine-driver and stoker, ran into it from behind, and completely divided it into two parts. Fortunately no lives were lost, but many of the passengers received severe contusions. It is believed that the driver and stoker of the second train, having passed the danger signals, and being unable to pull up in time, jumped off the engine for safety.

MILITARY ENGINEERING.

LIQUID IRON SHELLS.—In accordance with orders received at Chatham from the war department, upwards of 2000 of Martin's liquid iron shells have been supplied to the principal batteries in the Chatham district, the greater number having been distributed to Tilbury Fort and New Tavern Fort, and the defences at the entrance to the River Medway. Cupolas for melting the iron have also been furnished to each of the stations named. The cupola for preparing the molten iron, with which Martin's shells are charged, consists of a cylindrical shell of thick wrought iron, lined with prepared fire-bricks, with a blast fan attached. The cupola and fan are mounted on a frame furnished with four travelling wheels, each of which is twenty-four inches in diameter. An apparatus contrived for driving the fan by manual labour is connected with the cupola when in use, by two tie-rods, each about 1½ ft. in length; but these are removable, so that when in motion the cupola and driving apparatus are entirely separate. The driving gear of the fan is so constructed that, whenever steam power is available, it can at once be applied, instead of manual labour, Aveling's portable agricultural steam-engines, and others of the same kind being well adapted for this purpose. When the blast fan is driven by manual labour eighteen men are required to work it, with short reliefs. In about twenty minutes after the fire in the cupola is lighted the iron is put in, and in about a quarter of an hour after the fan has been put in motion the molten iron can run off into the shells. A ton of metal can be melted in about thirty minutes. Allowing, therefore, for waste, the number of shells that can be filled in one hour is 140 of the 8-inch 68 pounders, and the same number of the 10-inch 96-pounders. The estimated weight of the machine is 4 tons 13 cwt.

ARTILLERY EXPERIMENTS AT SHOEBURNESS.—A series of interesting experiments have been lately carried out at Shoeburness, for the purpose of fully testing the power of the old smooth bore and the new rifled guns against the strongest combination of iron plates and timber yet experimented on. It will be seen by the following official detail that the result of the experiments was entirely conclusive as to the immense superiority of rifled ordnance. The battery, or target, consisted of a solid wall of iron, 10 ins. thick, built up on Thornycroft's system of dovetailing; and this was backed in the strongest manner by heavy timber, and braced with iron bars. The first attack was made with heavy guns, 68 pounders, of the old service pattern; but the various projectiles fired by these smooth bore guns made no perceptible impression, and it was evident the battery would stand any amount of pounding from these weapons; in fact, after all the ammunition was expended, the wall of iron and timber appeared to be for all practical purposes indestructible. One of the Armstrong 120 shunt guns was then placed in position, and fired with a projectile weighing 120 lb. The extraordinary power of the weapon was instantly apparent. Such was the effect of the firing of this mass, combined with its velocity, that at a range of 600 yards it cleaned out one of the 10-inch plates, at the same time carrying away the back support. The next gun fired was one of the ordinary 100 pounder Armstrongs, with a solid projectile weighing 110 lbs. The battery was struck in another part, and a breach was made clean through the structure, the fabric itself being so weakened as to ensure ultimate destruction. The third shot, with the same weight of projectile, was directed against another part of the battery, and fully tested the stability of the superincumbent mass. The result was conclusive, as the whole fabric of the battery (already weakened) came down above the point which was struck.

EXPERIMENTS ON IRON PLATES.—At Portsmouth a series of experiments have lately been completed on two ½ in. iron plates, supplied by two private manufacturers, and fastened on the broadside of the *Sirius*, target ship. The gun used to propel the shot was a 63-pounder, smooth bore, of the ordinary pattern. The two experimental plates, one of which was a large, and the other a small one, were furnished by different makers, and the *Sirius* was moored at a distance of 200 yards from the *Stork* gunhoat, from which the solid 68-pounder cast-iron shot was fired with the common service charge. The largest plate of the two was composed of metal; although perforated and broken by successive shots, it proved to be of great tenacity and superior fibrous matter in the composition of its metal, inasmuch as it displayed no cracks throughout the whole extent of its surface, and no damage except that occasioned in the immediate locality of the perforation. The smaller plate was more brittle, and was not only perforated, but fractured. One shot struck with such tremendous force as to be almost flattened, and very much resembles an Enfield rifle bullet, the cone of which has struck a target, and has formed a cavity by the sides spreading out around it.

COST OF ALDERSHOTT.—It appears that £1,421,153 have been expended at Aldershot in the purchase of land, erection of barracks and huts, supply of water, and other works. Further works approved by the Government will cost £91,563; and a vote of £54,563 towards that sum, it is said, will be proposed this session.

IN THE ARSENAL AT TROY, U.S.—There is a machine for making bullets which is capable of producing 60,000 per day. By changing the dies, conical or round bullets may be made at pleasure. Only two similar ones are said to be in existence, one owned by the State of New York, and one presented to the Japanese last summer.

TELEGRAPHIC ENGINEERING.

PROPOSER ENGLISH, NORWEGIAN, AND RUSSIAN LINE.—It is proposed to lay down a telegraphic cable between some point in the north of England and Norway, with a continuation to Russia *via* Gothland. The cable will be landed on the Norwegian coast at Eckersland.

THE REPORT OF THE JOINT COMMITTEE appointed by the Board of Trade to inquire into the best form of covering for submarine telegraph cables has just been issued. Up to the present time 11,364 miles have been laid, but only about 3000 are actually working. The lines not working include the Atlantic, 2200 miles; the Red Sea and India, 3499 miles; the Sardinia, Malta, and Corfu, 700 miles; and the Singapore and Batavia, 550. The Committee give a succinct history of these as well as of all the others, and state their conclusions. The failure of the Atlantic is attributed to "the cable having been faulty, owing to the absence of experimental data; to the manufacture having been conducted without proper supervision, and to the cable not having been handled after manufacture with sufficient care;" and they add that "practical men ought to have known that the cable was defective, and to have been aware of the locality of the defects before it was laid." The Red Sea and India failure is considered to be attributable to the cable having been designed "without regard to the conditions of the climate or the character of the bottom of the sea over which it had to be laid, and to the insufficiency of the agreement with the contractor for securing effectual supervision during manufacture and control of the manner of laying." Looking at these circumstances, and similar ones in connection

with other lines, the Committee point out that the failures in every case are assignable to defined causes which might have been guarded against. They next detail the various methods hitherto employed for the construction and laying of submarine cables, and state the result of experiments in demonstrating the superiority of caoutchouc to gatta-percha for the insulating covering. They likewise express their opinion as to the best method of external protection and the plans for laying and maintenance, and recommend the construction of a vessel specially for the purpose, which they believe, when not employed in laying cables, would be found extremely useful for the ordinary purposes of commerce. In conclusion, they repeat their belief that the exercise of due care might have prevented all the unsatisfactory results that have thus far attended this branch of enterprise, and that if proper regard be henceforth bestowed upon the question, the results will prove as successful as they have hitherto been disastrous. The evidence appended is extremely voluminous, and occupies 520 pages.

MALTA AND ALEXANDRIA CABLE.—The first section and the greater part of the second length of this cable have now been laid without the slightest check or accident. The mileage of the entire route is as follows: Malta to Tripoli, 320 knots; Tripoli to Benghazi, 450 knots; Benghazi to Alexandria, 550 knots; showing a total length of 1290 knots. The section between Malta and Tripoli is completed. Three hundred miles, being the whole of the cable coiled on board the *Mutava* steamer, have been paid out along the second section, in the direction of Benghazi. The end of this portion had for the present been carried into shallow water, near shore, and buoyed to await the junction to it of the remainder, which was daily expected.

TOULON AND CORSICA CABLE.—This cable has lately been submerged with perfect facility and success by Messrs. Glass, Elliot & Co., who were the contractors employed in the work by the French Government. On some portions of this work the water is of great depth.

BOILER EXPLOSIONS.

ASSOCIATION FOR THE PREVENTION OF STEAM BOILER EXPLOSIONS.—The monthly meeting of the Executive Committee was held on Tuesday, May 23, at the offices, 41, Corporation-street, Hugh Mason, Esq., Vice-President, in the chair.—Mr. L. E. Fletcher, chief engineer, presented his monthly report, from which the following is extracted:—"During the month, we have made 195 visits, examined 501 boilers, and 339 engines. The following are some of the principal defects which have been found to exist in the boilers inspected, and to which the attention of the owners has in each case been called:—Fracture, 14; corrosion, 16 (four dangerous); safety valves out of order, 21; water gauges ditto, 12; pressure gauges ditto, 8; feed apparatus ditto, 2; blow-off cocks ditto, 17 (one dangerous); fusible plugs ditto, 3; furnaces out of shape, 9 (two dangerous); over pressure, 1; deficiency of water, 1; total, 104 (seven dangerous.) Boilers without glass water gauges, 65; ditto pressure gauges, 9; ditto blow-off cocks, 22; ditto feed back pressure valves, 76. After alluding to a case where a tubular boiler had been materially injured by encrustation, the report went on to state:—"I am so constantly meeting with cases of this sort, where, from the neglect of the simple precaution of blowing out, a good deal of property is sacrificed, that, even at the risk of reputation, I cannot forbear calling the attention of members to it. I am constantly asked what should be done to remove encrustation which should never have been allowed to form; and heg to recommend, as the most simple means for its prevention, regular blowing out from the surface when the water is in ebullition, and from the bottom when it is at rest. I find the blow-out apparatus in many boilers very inconvenient, if not entirely unfit for use, some of the taps being so made that they cannot be opened,—or, if opened, cannot be closed; others being rammed full of horse dung till quite choked, to prevent leakage; while many have no waste pipes, so that the boilers can only be blown out when the pressure is low, for fear of scalding the men, and thus the practice is too frequently confined to the week end. I would strongly urge upon our members the importance of depriving their enginemakers of all excuse for neglect, by having the apparatus for blowing out, both from the surface of the water as well as from the bottom, put in complete working order, and then let it be understood that further encrustation in their boilers is not to occur. This, I can assure them, would save them the trouble and expense incurred by many of constantly dosing their boilers with patent medicines. I may add, that perhaps as little trouble is experienced with a tap made with a close hottom, entirely of brass, and fitted with a gland, as with any other arrangement."

GAS SUPPLY.

THE EDINBURGH GAS CONSUMERS are forming a new Gas Company, with a capital of £75,000; which, it is stated, will secure a better plant than has cost the Edinburgh Gas Light Company £150,000. The company is to contract with consumers for the supply of gas, for any period up to ten years, at 3s. 6d. per 1000 cubic feet; the quality to be equal to what is at present supplied to the city.

QUARTERLY REPORT ON THE GREAT CENTRAL GAS.—At the weekly meeting of the City Sewers Commissioners, Dr. Letheby reported on the illuminating power and chemical quality of the gas supplied to the city by the Great Central Gas Consumers Company during the quarter which has just expired. He stated that the gas had been tested at two places, *viz.*, at the laboratory of the London Hospital, and at his laboratory in Finsbury-square. At the first named place there had been 232 experiments, and at the last 109, making in all 341 experiments, on the illuminating power of the gas. Each experiment was the mean of ten observations, and the results were as follows:—At the London Hospital the illuminating power was equal to that of 11'37 sperm candles, or 12'99 wax; and at Finsbury-square it was equal to 11'38 sperm and 13'00 wax. The gas was burnt at the rate of five entire feet per hour, and the candles were reduced to the standard consumption of 120 grains per hour. These results are satisfactory, for they show that the power of the gas has been about nine per cent, above the requirements of the Great Central Gas Act. Dr. Letheby drew attention to the fact that the illuminating power of the gas had not suffered by the passage of the gas along the main of nearly two miles in length. This indicated a good and permanent quality of gas, such as should at all times be supplied to the public. The Great Central Company have relied upon this and have not hesitated to extend their main from the city boundary to Finsbury-square, in order that the gas may be tested as frequently as possible. The results of the testings during the last three months have justified the confidence which they had in the illuminating power of the gas, and they have established the fact that the position of the testing place is not a matter for consideration, excepting in those cases where the gas is of an inferior quality, and will not bear a journey of more than a thousand yards from the works. Dr. Letheby also stated that the pressure of the gas had been uniformly very good, for it had rarely been below an inch of water. Even at Finsbury-square, which is at the extreme end of the main, it ranged in most cases between an inch and a half and an inch and three quarters. The chemical quality of the gas had also been good as regarded the complete absence of sulphuretted hydrogen, and the presence of but few traces of ammonia.

MALTA AND MEDITERRANEAN GAS COMPANY.—A prospectus has been issued of this company, with a capital of £60,000, in £5 shares. It is proposed to purchase the existing gasworks at Valetta, the chief city of Malta, and to erect other for the supply of the three cities of Senglea, Cospicua, and Vittoriosa.

DOCKS, HARBOURS, CANALS, &c.

INDIAN CANALS.—An official paper lately received from Calcutta, gives an account of results of the Ganges Canal in preventing famine. The Superintendent-General of Irrigation, states that the beneficial operation of the canal during the past season cannot be over estimated. In some districts the land was ploughed with the aid of water taken

from the canal, the seed was sown with the same aid, and would not have germinated without it, and the produce was as full and fine as it could have been in the most prosperous season. "Had there been no canal, there would have been no crop on broad lands which are now covered with wheat and other cereals in great abundance." Besides other beneficial results from this canal, it has afforded means to the community for transporting grain from the lower provinces, and which has been greatly taken advantage of. The boats plying the canal at the commencement of the year have been doubled within the last six months; new boats are being daily built, and such are the profits that, though prices have risen much, the value of the boat is in a very short time recovered. The Ganges Canal Navigation Company are about to call a meeting for the purpose of building 100 new boats, and though this great demand for water carriage may not be permanent, yet the great stride which navigation, as also irrigation, has made this year must, to a great degree be lasting.

LOCH LOMOND.—A survey of this lake has lately been completed. This survey was called for by the numerous accidents occurring to steamers plying on the water during the summer months, carrying thousands of tourists. The many rocks, shoals, and hidden dangers are now delineated by a most careful and detailed survey, and beacons are to be forthwith placed on those in the usual track of steamers.

MINES, METALLURGY, &c.

MANUFACTURE OF CAST STEEL.—An invention by Mr. R. Mushet, of Coleford, has lately been patented, which consists in melting blister, steel-bars, or puddled steel, or scrap steel, or mixtures of these varieties of steel, or a mixture of malleable iron and carbonaceous matter, in the proportions which constitute steel, with New Zealand iserine or titaniferous iron-sand and carbonaceous matter; or adding the said titaniferous iron-sand and carbonaceous matter to the steel, or to the mixture of malleable iron and carbonaceous matter during the melting of the same, or after it is melted and reduced to a liquid state; and, lastly, in adding to highly carbonized steel, New Zealand iron-sand, without additional mixture of carbonaceous matter, and melting the highly carbonized steel and the titaniferous iron-sand together. In this case the excess of carbon contained in the highly carbonized steel suffices in place of any further addition of carbonaceous matter to reduce the iserine or titaniferous iron-sand, either partially or wholly to the metallic state.

NEW METALLIC ALLOY.—Mr. Aiehs of Brussels, has introduced a new metallic alloy, which is much cheaper than new copper, and even lower in price than brass, while it can advantageously replace those metals in naval constructions and other branches of industry. It has more tenacity than copper or brass, and is much less subject to oxidation. It possesses the great advantage of working as well cold as when heated; it may be forged without losing its cohesion; it melts readily, and can afterwards be submitted to the operations of hammering, rolling, and punching. In a state of homogeneous fusion, this alloy consists of 60 parts copper, 35.2 of zinc, and 1.8 of iron.

DR. WOON'S FUSIBLE METAL.—This metal is an alloy composed of 8 parts lead, 15 parts bismuth, 4 parts tin, and 3 parts cadmium; it possesses the following properties:—It is permanently silver white, and has a brilliant metallic lustre; it is not so brittle or hard but that it may be obtained in thin leaves or flexible plates; it has a fine-grained fracture, and may be filed without stopping up the file. In dry air it keeps its polish. It expands in cooling, but not so much as bismuth or antimony. Its specific gravity is from 9.4 to 9.41. It softens between 131° and 140° Fahr., and near 140° becomes perfectly fluid. The above properties show that the alloy may be applied to some useful purposes. It may supersede all the quicksilver-alloys for stopping teeth; it may be used as a solder whenever the metals soldered are not likely to be exposed to heat. Tin, lead, and Britannia metal may be soldered together under water above 160° Fahr. Zinc, iron, copper, and brass may also be soldered with the greatest ease under water, to which a little hydrochloric acid has been previously added. The alloy is so easily fusible that it may be melted on a piece of paper over a spirit lamp. In the preparation of the alloy the author recommends the use of the purest bismuth.

AUSTRALIAN MINING.—A return recently laid before the Parliament at Melbourne shows the rapid progress made to the 31st December last, in applying steam and machinery to the production of gold in that colony. It shows that, on the above date, there were 107,572 adult miners, viz., 60,374 Europeans, and 28,100 Chinese engaged in alluvial workings, and 18,570 Europeans and 28 Chinese engaged in quartz-mining. The number of steam-engines employed in alluvial workings for winding, pumping, puddling, &c., was 294, amounting to 4137 horse power. Besides steam engines there were 3957 horse puddling machines, 354 horse wms, 128 water wheels, and 56 horse pumps. In quartz-

crushing and mining there were engaged 420 steam engines, equal to 6696 horse power, 153 wms, six water wheels, 26 whips, and 40 horse crushing machines. The approximate value of all this mining plant is set down at £1,259,660.

THE ARTESIAN WELL OF PASSY.—This well known work, which has been six years in progress, has, according to Paris letters, now begun to flow: at least the water is said to be within a few feet of the level of the ground. The depth bored is about 577 metres, or about 1875ft. English.

APPLIED CHEMISTRY.

APPLICATION OF CYANIDE OF POTASSIUM IN SOLDERING METALS.—In the operation of soldering metals says, Dr. Augustus Vogel, it is very essential to keep the metallic surfaces to be united clean and bright, so that the solder may adhere firmly when in a melted condition. For the purpose of protecting the metallic surfaces from the oxidising action of the atmosphere, certain fusible substances are usually rubbed on with the solder and immediately form a thin layer over the surface of the metal. These substances produce however, not only a protective, but also a reducing action. In practice it is sought to ensure these two essential conditions in the choice of the substances generally employed, viz., for soft soldering, resin turpentine, olive oil, powdered sal-ammoniac, mixed either with oil, or with tallow and resin, or a very concentrated solution of chloride of zinc. For hard soldering, borax, or a melted mixture prepared from borax, potash, and common salt, and, in the special case of iron, pounded green glass is generally used. It is well known that the substances above mentioned fulfil to a greater or less extent these two conditions of soldering, viz., deoxidation and protection of the metal from the atmosphere. A material possessing these two qualifications, in the highest degree, would of course, best effect this purpose. As the result of a great number of experiments, I have come to the conclusion that the ordinary commercial quality of cyanide of potassium possesses decided advantages in this respect over all other substances. It melts very readily, covering the surface of the metal with a very efficient protective layer, and at the same time is known to exert a strong reducing action, a property which has gained for it many important applications both in technical and analytical chemistry. Cyanide of potassium will be found particularly useful when the surfaces to be soldered cannot be thoroughly brightened. It is difficult, and sometimes impossible, to solder metals when their surfaces are at all corroded, or when they are incapable of bearing the high temperature necessary in this operation, with the ordinary agents, on account of their inferior reducing; power but cyanide of potassium, from its extraordinary energetic action, is able to deoxidise all rusty particles standing in the way of the perfect union of the solder with the metal. The mode of applying the cyanide of potassium in soldering is the same as with borax. Some powdered cyanide of potassium is kept ready at hand in a well-closed glass bottle, and sprinkled over the metallic surface after it has been slightly moistened. In some cases of soldering at very high temperatures, which, by practice, are soon ascertained, it will be found expedient to use a compound of borax and cyanide of potassium, for the purpose, on the one hand, of increasing, by this addition, the small reducing power of the borax, and on the other hand, of diminishing the volatilising tendency of the cyanide of potassium. Another reason for preferring the employment of this agent is, that during the operation no corrosive vapours capable of acting on the soldering tools are generated, as is the case with chloride of zinc.

PECULIAR PRODUCT FROM SOME COAL OILS.—MM. Riche and Bardy have examined with some minuteness a yellow body obtained when certain coal oils are treated with nitric acid. As first obtained, it is a solid black mass smelling, strongly of nitrobenzine, and straining the skin yellow like picric acid. Purified by repeated filtration through moistened bibulous paper, to remove the black viscid oil, crystals of a deep yellow colour are procured which no longer smell of nitrobenzine. Their analysis gave results which led to the formula $C_{12}H_7N_3O_{12}$. On drying the crystals in a vacuum for four days, they broke up and became reddish. The analysis of them in this condition gave the composition $C_{12}H_7N_3O_{10}$, showing that the crystals had lost two atoms HO. The exact nature of this body the authors have not been able to determine. It gives precipitates with salts of most of the metals, and the compounds formed with lead and silver easily crystallize. The silver compound blackens in the light, and explodes with violence at a very slight elevation of temperature.

COMPARATIVE ACTION OF NITRATES AND AMMONIA ON VEGETATION.—We may here quote the results some experiments by Ville which go to prove that nitrate of potash has a much greater influence on the growth of plants than ammonia—that in fact the nitrogen of nitrates is much more assimilable than the nitrogen of ammonia.

APPLICATIONS FOR LETTERS PATENT.

Dated May 17, 1861.

1257. T. Dunn, Pendleton, near Manchester—Watches.
1258. T. Dunn, Pendleton, near Manchester—Apparatus for altering to the position of locomotive engines.
1259. S. Tearne, Birmingham—Producing designs in enamel on articles of brass.
1260. S. Pitts, 14, Catherine-street, Strand—Billiard and hagatelle tables.
1261. A. Allan, Perth—Locomotive steam engines.
1262. J. C. M. Beziat, 114, Rue Mouffatte, Paris—Apparatus for raising casks and other vessels.
1263. G. Davies, 1, Searle-street, Lincoln's-inn—Advertising.
1264. A. Turner, Leicester—Manufacture of elastic fabrics.
1265. W. Paley, junior, Lombard-street, and J. Richardson, Brewer-street, Clerkenwell—Manufacture of brushes.
1266. W. Clark, 53, Chancery-lane—Manufacture of artificial alizamine.
1267. P. Ashcroft, South Eastern Railway, London Bridge Station—Railway chairs and fastenings.

Dated May 18, 1861.

1268. W. H. Bennett, 42, Parliament-street, Westminster—Apparatus for regulating the supply of gas.
1269. A. C. Pontou, 9, Arlington Villas, Clifton, near Bristol—Combining together siliceous powder into solid masses of any form by means of sulphur.
1270. G. Neville, Birmingham—Construction of the sacking of bedsteads and couches.
1271. S. L. Sotheby, Wellington-street, Strand—Bindings or coverings of books and portfolios.
1272. J. W. Greaves, Port Madoc, Carnarvon—Apparatus for dressing slates.
1273. D. G. F. Gerald, Cambridge-street—Obtaining electric currents for telegraphing purposes.
1274. D. G. F. Gerald, Cambridge-street—Batteries for producing voltaic electricity.
1275. J. Hughes, Newport—Plates to be used in ships and other structures for receiving armour plates or bars.
1276. F. O. Ward, Hertford-street, May Fair—Manufacturing manure.

1277. R. King and K. Bobson, Sheffield—Consuming and destroying smoke as emitted from engine or other chimneys.
1278. W. Clark, 53, Chancery-lane—Electric telegraph apparatus.
1279. B. F. Stevens, Trafalgar-square—Tracto-motives or engines for running upon common roads.

Dated May 20, 1861.

1280. W. C. Forster, 37, Gibson-street, Lambeth—Method of manufacturing bricks and slabs, impervious to damp.
1281. G. Buckley, Salford—Construction of rollers for doubling frames and other machines.
1282. J. Sidebottom, Harewood, near Mottram—Cop tubes and parial tubes.
1283. J. Jobin, 2, South Island-place, Clapham-road, Surrey, and J. Weber, St. Martin's-le-Grand—Manufacture of cigars and cigarettes.
1284. W. Parkinson, Ripon—Washing, wringing, and mangling machines.
1285. M. Scott, Parliament-street, Westminster—Ordnance.
1286. G. E. Donisthorpe, Leeds—Sizing, drying, and warping yarns for weaving.
1287. A. J. Robertson, 26, Parliament-street, Westminster—Ships and vessels.
1288. O. Papengouth and L. I. Lehmann, Blackfriars-road—Propelling vessels.
1289. E. Humphrys, Deptford—Construction of iron ships, batteries, and forts.

Dated May 21, 1861.

1290. H. B. Barlow, Manchester—Looms for weaving.
1291. M. A. F. Memmons, 39, Rue de l'Exchequier, Paris—Coupling or connecting joints of pipes.
1292. G. F. Griffin, New Adelphi Chambers, Adelphi—Construction of railway chairs.
1293. W. P. Dreaper, 56, Bold-street, Liverpool—Piano-fortes.
1294. Y. Parrey, Pimlico Wheel Works—Construction of carriage wheels.
1295. T. Aveling and H. Rawlinson, Rochester—Locomotive engines.

1296. W. Tasker jun., Waterloo Iron Works, near Andover, Hants—Apparatus for tilling or cultivating land.
1297. T. Sykes, B. C. Sykes, and J. W. Crossley, Cleckheaton, Yorkshire—Boilers and furnaces.

Dated May 22, 1861.

1298. J. Bleasdale, Acerington—Manufacture of fluted rollers for preparing and spinning fibrous materials.
1299. S. P. Matthews, Monmore Green, Wolverhampton—Door locks, lock spindles, and knobs.
1300. J. R. Chesneau, 39, Rue de l'Exchequier, Paris—Pen and pencil holders.
1301. H. B. de Beaumont, Geneva—Ploughs.
1302. G. E. Donisthorpe, Leeds—Apparatus used in getting coal.
1303. G. B. Naglost, Vienna—Cannon and projectiles therewith.
1304. W. E. Newton, 66, Chancery-lane—Printing Machinery.

Dated May 23, 1861.

1305. L. Lumh, Brotherhold Mills, near Rochdale, and W. H. Butterworth, Reed Hill, Rochdale—Undercovers of carding engines.
1306. C. Nuttal, 34, South-lane, Rochdale—Machinery for grinding the cards of carding engines.
1307. J. Hynam, Wilson-street—Apparatuses for arranging splints for matches.
1308. W. Tehhet, Loughborough—Ventilating rooms in buildings of every description.
1309. J. H. Dart, 5, Church-court, Clement's-lane—Manufacture of paper.
1310. R. Mushot, Coleford—Casting ingots of steel.
1311. R. A. Brooman, 166, Fleet-street—Portable cooking apparatuses.
1312. E. Partridge, Smethwick—Method of lubricating carriage axles.
1313. H. M. F. de la Tour-du-Breuil and A. M. de la Tour-du-Breuil, 29, Boulevard St. Martin, Paris—A copying press, so called telegraph press.

Dated May 24, 1861.

1314. C. Batty, 196, Marybone-road—Apparatus for warming and ventilating rooms.

1315. B. Collingham, Keighley, and M. Mason, Manchester—Machinery for preparing and spinning fibrous substances.
1316. F. H. Danchell, Red Lion-square—Ascertaining and removing impurities contained in water.
1317. R. Joslin, 36, King William-street—Gentlemen's scarfs.
1318. G. Herbert, Summer-hill, Dartford—Apparatus for striking bells.
1319. J. Patterson, Wood-street—Clasps or buckles.
1320. E. Prece, Clapham-road—Floors.
Dated May 25, 1861.
1321. H. Waller, Lickhill, near Calne—Improved horse rake.
1322. E. H. C. Monckton, Parthenon Club, Regent-street—Obtaining and applying magnetic motive power.
1323. W. Roberts, Millwall, Poplar—Vices and screw benches.
Dated May 27, 1861.
1324. W. Kay, Bolton-le-Moors, and I. Kay, Lever-hridge, near Bolton-le-Moors—Machines for spinning and doubling.
1325. E. Green and J. Cadbury, Birmingham—Buttons for general use.
1326. W. Smith, J. Lord, and H. Barlow, Green's Nook Mill, Lancashire—Looms for weaving.
1327. T. Moore, 99, Southwark Bridge-road—Apparatus for raising water and other fluids.
1328. M. de Albytre, Bordeaux (Rue Laporte, 14), Gironde—Tallow candles.
1329. C. S. Duncan, Kildare-terrace, Bayswater—Construction of electric telegraph cables or ropes.
1330. Lord Alfred Spencer Churchill, 16, Rutland-gate, and E. W. H. Schenley, 14, Princes-gate—Buffing and coupling apparatus for railway carriages.
1331. J. Lee and B. D. Taplin, Patent Crank Works, Lincolnshire—Manufacture of portable or traction steam engines.
1332. W. B. Holbeck, Thurlaston Lodge, Leicestershire—Apparatus for sowing seeds.
1333. W. N. Nicholson, Newark-ou-Trent—Machines for making and collecting hay.
1334. G. H. Birkbeck, 34, Southampton-buildings, Chancery-lane—Apparatus for transmitting motive power.
Dated May 23, 1861.
1335. E. B. Burnham, Liverpool—Manufacture of boots and shoes of india rubber.
1336. P. A. Millward, Wednesbury, Staffordshire—Manufacture of coke.
Dated May 29, 1861.
1337. G. W. Rendel, Elswick Ordnance Works, Northumberland—Manufacture of wrought iron cylinders.
1338. R. M. Letchford, Old Montague-street—Manufacture of matches.
1339. G. Asher, Birmingham—Manufacture of metallic fenders.
1340. H. Crichtley, Birmingham—Ornamentation of metallic chimney pieces or mantel pieces.
1341. E. H. C. Monckton, Parthenon club, Regent-street—Obtaining and applying magnetic motive power.
1342. J. Halliwell, Baslow, Derbyshire—Churns.
1343. C. Ching, Castle-street, Long-acre—Gas chandeliers.
1344. T. Hale, 21, Barnsbury-row, Park-road, Islington and A. Wall, 12, Canton-street, East India-road—Furnaces.
1345. W. E. Newton, 66, Chancery-lane—refining and purifying iron.
Dated May 30, 1861.
1346. W. B. Roof, 7, Willow-walk, Kentish-town—Window-seat.
1347. W. P. Savage, Roxham, Downham—Reaping and mowing machines.
1348. F. A. Whitehead, 7, Whiteheads-grove, Chelsea—Treating cream or milk.
1349. C. Garrod, Penge, Surrey—Horse rakes and harrows.
1350. J. H. Johnson, 47, Lincoln's-inn-fields—Apparatus for regulating the pressure of gas.
1351. T. Y. Hall, Newcastle-upon-Tyne, and J. Stockley, same place—Apparatus for communicating signals.
1352. J. Ronald, Liverpool—Manufacture of thread, cord, cable, and other cordage.
1353. A. Blake, 17, Russell-place, Fitzroy-square—Brewing.
1354. A. Oudry, Paris—Suspension-bridges.
1355. L. Heinemann, Cannon-street, West—Fastening for purses, reticules, hags, belts, bands, pocket-books, cigar, writing, and instrument cases.
Dated May 31, 1861.
1356. W. Bywater, Leeds—Apparatus for finishing and drying thread, twine, cords, and ropes.
1357. M. Henry, 84, Fleet-street, London—Manufacture of shirt fronts.
1358. W. Hunter, Glassford-street, Glasgow—Looms for weaving.
1359. H. B. Mackay, Ballymoney, Antrim—Cleaning flax.
1360. W. E. Gedge, 11, Wellington-street, Strand—Cutting stone.
1361. R. A. Brooman, 166, Fleet-street, London—Apparatus to be applied to the shoes of horses to prevent them from slipping in frosty weather.
1362. F. Tolhausen, 35, Boulevard Bonne-Nouvelle, Paris—Revolving fire-arms.
1363. E. C. Healey, 163, Strand—Ordnance and fire-arms.
1364. E. Hartnall, Ryde, Isle of Wight—Manufacture of paper.
1365. G. Glover, 8, Queen-square, Westminster—Gas meters and pneumometers.
1366. P. Cameron, Glasgow—Instrument for measuring, indicating, and regulating the pressure or flow of fluids.
1367. R. Laming, Priory-road, Kilburn—Manufacture of alkaline carbonates.
1368. The Right Hon. Lord C. Beauleck, Riding Manor House, Northumberland—Propelling vessels.
Dated June 1, 1861.
1369. M. Wiggell, Friars Green, Exeter—Improvement in iron, and other metallic alloy, for making nails and other similar driving articles.
1370. M. Enrke, Liverpool—Manufacture of folding metallic chairs, bedsteads, and sofas.
1371. T. Coradine, Glasgow—Apparatus for cutting or dividing metal.
1372. R. Wilson, Liverpool—Anchors.
1373. G. Watson, Commercial-road—Apparatuses for boats.
1374. J. Taylor and R. King, Oldham, Lancaster—Improvements in machinery or apparatus for preparing cotton or other fibrous materials to be spun.
1375. P. Gondola, 29, Boulevard St. Martin, Paris—An improved kneading machine.
1376. L. Bilon and J. E. J. Nappey, 29, Boulevard St. Martin, Paris—Apparatus for manufacturing bricks and tiles.
1377. H. Stansfield, 41, Back Drake-street, Rochdale, Lancaster—Improvements in punching machines.
1378. F. N. Gisborne, 3, Adelaide-place, London Bridge—Means of indicating the course to be steered in ships at sea and in galvanic batteries to be used in some cases therewith.
1379. B. C. Ransome, Ipswich, Suffolk—Reaping and mowing machines.
1380. W. A. Shepard, Pall-mall—Steam boilers.
1381. C. Garrod, Penge, Surrey—Cultivators and horse hoes.
1382. W. A. Shepard, Pall Mall—Obtaining products from coal.
1383. T. Ambler, Keighley, Yorkshire—Top rollers for spinning and drawing frames.
Dated June 3, 1861.
1384. W. Harwood, Stowmarket, Suffolk—Reaping and mowing machines.
1385. H. Allman, 13, Bedford-row—Construction of castors for furniture.
1386. H. N. Penrice, Witton House, near Norwich—Machinery for tunnelling and driving galleries through rock and other strata.
1387. W. R. Jeune, Flower-terrace, Campbell-road, Bow—Manufacture of kamptulicon.
1388. G. B. V. Arbuckle, Charlton, Kent—Armour coating for ships, fortifications, and other structures.
1389. J. Fowl, Plumstead, Kent—Propelling vessels.
1390. J. D. Davidge, 3, City-terrace, Old-street-road—Construction of arches or other curved structures.
1391. O. Muck, 4, South-street, Finsbury—Machinery or apparatus for the manufacture of matches.
Dated June 4, 1861.
1392. M. A. F. Mennons, 39, Rue de l'Echiquier, Paris—Combination of metal for the production of a white alloy resisting the action of vegetable acids.
1393. M. A. F. Mennons, 39, Rue de l'Echiquier, Paris—Miniature microscopes.
1394. H. Allman, 39, Bedford-row—Window-sash fasteners.
1395. S. Hargreaves and R. Holden, Helmsshore, and H. Holt, Newchurch—Apparatus for sizing warps and yarns.
1396. H. H. Hazard, Nelson-terrace, City-road—Cartridges.
1397. A. Prince, 4, Trafalgar-square, Claring-cross—Manufacture of gas.
1398. J. M. Stevenson, 5, Prospect-place, Cheyne-walk, Chelsea—Manufacture of boots and shoes.
1399. D. W. Thomas, of the firm of Messrs. Fawcett, Preston, and Co. of Liverpool—Centrifugal machines.
1400. W. R. Floyd, Commercial-road, East—Apparatus for sporting knapsacks and packs.
1401. J. Ford, Thames Iron Works, Blackwall—Ship's rudders.
1402. J. L. Hancock and F. L. Hancock, Pentonville—Implements for pulverizing, ploughing, and grubbing land.
1403. J. H. Holdsworth, of the firm of Holdsworth and Son, of Wakefield—Finishing piece goods.
1404. A. Hubbell, Salisbury-street, Westminster—Apparatus to be used in washing clothes and other articles.
1405. A. Hubbell, Salisbury-street, Westminster—Churns.
1406. H. G. B. Roeber, Silvertown, Essex—Manufacture of insulators for telegraphic wires.
1407. S. Standfast, Hackney—Composition for building to be used in substitution for brick and stone.
1408. J. A. Van Braam, New York—Barrels of fire-arms.
1409. J. A. Williams, Wiltshire—Machinery for cultivating land by steam power.
1410. H. L. Buff, Osnabruck, Hanover—Treatment of fatty and oily substances.
1411. E. C. Stanford, Worthing, Sussex—Obtaining products from sea weeds.
Dated June 9, 1861.
1412. M. Dodsworth, and W. Smith, New Malton, York shire—Boot and shoe-cleaning machine.
1413. A. Duguet, 15, Newman-street—Manufacture of pianos.
1414. E. Smith, Hamburg—Wet gas meters.
1415. F. J. Manceaux, Paris—Breech-loading arms.
1416. O. Chapman, Clerkenwell—Dressing and writing case.
Dated June 6, 1861.
1417. J. Baker, 315, Oxford-street—Finishing off and closing loaded cartridge cases.
1418. D. Nichols, Manchester—Apparatus for cutting paper or other materials.
1419. J. Bailey and W. H. Bailey, Albion Works, Salford—Apparatus for indicating the speed flow pressure and vacuum of liquids, fluids, and other bodies.
1420. H. T. Coles, Silchester, Hants—Apparatus for locks and bolts and other fasteners.
1421. L. J. P. de Mirimonde, Paris—Axle boxes.
1422. J. Wright, 42, Bridge-street, Blackfriars—Separating foreign matters from the droppings from carding machines.
1423. S. Moore, Liverpool—Apparatus for dressing and polishing rice.
1424. H. Rigby and P. W. Lowe, Salford—Steam boilers.
1425. C. Stratford, 1, Groom's Hill Grove, Greenwich—An equilibrium steering apparatus.
1426. G. Baker, Birmingham—Apparatus for churning and beating eggs.
1427. T. Hamilton and J. Hamilton, Glasgow—Cop tubes.
1428. J. Rust, Lambeth Glass Works, Carlisle-street, Lambeth—Hardening and preserving stone.
1429. H. Turner and T. Yates, Leicester—Manufacture of elastic web.
1430. S. Hawkins, 2, John-street, Kingsland-road—Expanding tables.
1431. H. Turner and T. Yates, both of Leicester—Railway signals.
1432. W. O. Johnston, Newcastle-upon-Tyne—Pillars for supporting the roof in coal and other mines.
1433. B. D. Godfrey, Massachusetts—An improved boot or shoe uppers, and india rubber soles.
1434. S. C. Lister and J. Warburton, Bradford, Yorkshire—Treating, spinning, and doubling yarns.
1435. E. Hewett, St. Leonards-on-Sea, Sussex—Apparatus for creating or increasing air draughts in flues or other channels for ventilation.
1436. A. Smith, Hull—Drying, sweetening, and otherwise improving wheat and other grain.
1437. J. Platt and W. Richardson, Oldham—Apparatus for making bricks.
1438. W. E. Newton, 66, Chancery-lane—Facilitating the transport of carriages containing goods and passengers across arms of the sea, rivers, lakes, and inland waters.
1439. J. Platt and W. Richardson, Oldham—Apparatus, commonly called "gins," for cleaning cotton from seeds.
Dated June 7, 1861.
1440. W. Riddle 1, Basford-street, Islington, and H. G. Coombs, 17, Union-street, Southwark—Shops.
1441. J. Vaughan, Middlesborough Iron Works, Middlesborough-on-Tees—Manufacture of railway sleepers.
1442. R. Harlow, Heaton Norris, Lancashire—Fire bridges and tubes of steam boilers.
1443. H. A. Balsac, Paris—Electro-thermometrical alarm.
1444. J. Leeland, Birmingham—Sacking of bedsteads and couches.
1445. H. De Simencourt, Corbyn's Hall, near Dudley, and J. K. Blackwell, 73, Gloucester-terrace, Hyde Park—Reverberatory and other furnaces.
1446. S. Bennett, junr., Handsworth, Staffordshire—Utilizing waste or defective pieces of tubing made of iron or of other metal or metallic alloy.
1447. W. Wood, Shildon, near Halifax—Looms for weaving
1448. A. A. Croll, Coleman-street—Manufacture of sulphate of alumina.
1449. E. A. Cowper, Great George-street, Westminster—Protecting ships of war and land batteries from the effects of projectiles.
1450. W. Leopard, Hurstpierpoint—Railway brakes.
1451. R. L. Cole, Minerva-place, Kennington-road—Glove for currying horses and other cattle.
1452. C. W. Lancaster, New Bond-street—Method of sheathing ships and vessels with copper sheathing.
1453. J. F. Clarke, 26, Moorgate-street—Apparatus for regulating the supply of fluids.
1454. W. A. Sands, New York, U.S.—Manufacture of sails for ships.
Dated June 8, 1861.
1455. J. Whines, Pimlico—Double action box spring hinges for swing doors.
1456. W. Robertson, Manchester—Manufacture of drawings and delivering rollers used in preparing and spinning fibrous materials.
1457. H. D. Mont, 150, Rue de Rivoli, Paris—Photographic apparatus.
1458. J. M. Worrall, and T. Lawrence, Ordsall—Apparatus for brushing, raising, and dressing the surfaces of cut-pile and looped fabrics.
1459. R. M. Latham, 71, Fleet-street—Hooped or hoop skirts.
1460. J. Mason, Nottingham—Woolen article as a substitute for a sponge.
1461. J. Howard and E. T. Rousfield, Bedford—Haymaking machines.
1462. J. Roman, Liverpool—Economising fuel.
1463. P. O'Hanlon, Kingston-upon-Hull—Marine and land steam hollers.
1464. J. Martin, Myrtle Hall, Sidmouth—Ironing stove.
1465. J. Rymer, 33, Avenue-road, Regent's-park—Permanent way of railways.
1466. J. Hutchinson, Appleton Lodge, Widnes, near Warrington—Treatment of wool.
1467. J. McKay, Glasgow—Apparatus for cleaning chimneys or flues.
1468. W. Clark, 53, Chancery-lane—Composition for cleaning and polishing metals and glass.
1469. W. Clark, 53, Chancery-lane—Constructing casks, tubs, and other like vessels.

- Dated June 10, 1861.*
1470. J. Whitehead, David-street—Looms for weaving.
1471. A. L. C. de Montagu, 4, South-street, Finsbury—A cone preventing smoke and extinguishing fires in chimneys.
1472. R. Armstrong, North Woolwich—Marine steam boilers.
1473. A. Brown, Waterloo-road, Liverpool-road—Obtaining fresh water at sea by means of distilling apparatus.
1474. D. Rollo, Liverpool—Valves for steam and other engines.
1475. W. Wheller, Mile End—Apparatus for supplying fuel to furnaces.
1476. J. Oldroyd, Dewsbury—Combing or mixing various colours of wool in the preparation of yarns for textile fabrics.
1477. M. Mason, Manchester—Flyers and spindles of machinery for preparing, spinning, and doubling fibrous substances.
1478. W. Grofts, Lenton-terrace, Park Side, Nottingham—Apparatus employed in the manufacture of fabrics by lace machinery.
1479. C. F. Whitworth, Moses Gate, near Bolton—Apparatus employed in signalling on railways.
1480. J. Langdale, jun., South Stockton-on-Tees—Washing machine.
1481. J. Steart, 5, St. James's-road, Blue Anchor-road, Bermondsey—Treating skins for the manufacture of leather.
1482. M. Hawdon, Blaydon—Apparatus for constructing moulds for casting metals.
1483. R. Romaine, Devizes—Machinery applicable to steam cultivation.
1484. C. F. Varley, 4, Fortess-terrace—Electric telegraphs.
1485. J. B. Carter, Wilford-road, Nottingham—Apparatus used in dressing lace or other fabrics.
1486. M. Henry, 84, Fleet-street—Fire-arms.
- Dated June 11, 1861.*
1487. F. E. Schneider, Rue de Gaillon, Paris—Breech-loading fire-arms.
1488. C. Stevens, 31, Charing-cross—An improved crushing and pulverising machine.
1489. C. Stevens, 31, Charing-cross—Impermeable varnish for leather.
1490. T. O. Small, Newcastle-upon-Tyne—Optical instrument for the use of designers and others.
1491. P. M. Crane, Irish Peat Works, Athy, Ireland—Manufacture of peat fuel.
1492. J. D. Harding, Barnes, and W. H. Windsor, Rathbone-place, Middlesex—Drawing materials and apparatus for the use of artists.
1493. E. T. Hughes, 123, Chancery-lane—Extracting oil from seeds.
1494. C. Cheyne, Great George-street—Constructing rifle and other gun "ranges."
1495. R. W. Smith and G. Scattergood, Nottingham—Machinery for manufacturing looped fabrics.
1496. S. B. Singer, Southsea—Card of compasses.
1497. C. Chalmers, Edinburgh—Gas stoves.
1498. W. E. Newton, 66, Chancery-lane—Gunstocks.
- Dated June 12, 1861.*
1499. W. H. Walker, Liverpool—Floating hydraulic lift stage for raising navigable vessels.
1500. J. A. Dauncey, Bury—Apparatus for supplying liquid nourishment to infants and invalids.
1501. J. Hope and W. Greenhalgh, Bedford—Apparatus for cutting turnips, roots, or other substances.
1502. W. E. Gedge, 11, Wellington-street, Strand—An improved reaping and sowing machine.
1503. J. A. Callaud, Nantes, France—Construction of electrical piles.
1504. J. Durrant, Fitzroy-square, and N. A. Harris, Bayswater—Form and construction of chimney tops.
1505. H. Mason, Ash-ton-under-Lyne—Apparatus for preparing and spinning cotton.
1506. L. J. J. Petre, 29, Boulevard St. Martin, Paris—A smoke-consuming grate.
1507. J. Watt, 2, Westmoreland-place, Camberwell—Mode of converting vegetable fibrous substances into pulp.
1508. J. Drew, Belgrave-terrace, Weymouth—Adaptation of plates or shields to fixed floating and batteries.
1509. G. Cox, 17, Victoria-place, Queen's-road, Holloway—An improved floor dog or cramp.
1510. J. Napier, Edinburgh—Stereotyping.
1511. D. Walmsley and J. Rostron, both of Disley—Improvements applicable to hoisting machinery used in warehouse.
1512. R. Jobson, Dudley, and C. F. Varley, 4, Fortess-terrace, Kentish Town—Posts or supports for telegraph wires.
1513. J. P. Girard, Coutances, Manche—Coffee mill.
- Dated June 13, 1861.*
1514. C. Swan, College-hill—Travelling bags.
1515. W. E. Gedge, 11, Wellington-street, Strand—Beating apparatus for picking and cleaning substances used in making or manufacturing woven or textile fabrics.
1516. E. Chalouet, jun., La Rochelle, France—Machine to open covers for tin boxes or cases for packing sardines or other provisions.
1517. H. Holland, Birmingham—Manufacture of umbrellas and parasols.
1518. J. Knowles, Bolton-le-Moors—Machinery for preparing cotton and other fibrous materials.
1519. E. Bing, Ramsgate—Construction and fittings of sliding window sashes.
1520. J. Illingworth, Bradford—Arranging sizing houses, brewhouses, dye-houses, and other houses and chambers to facilitate the removal of steam set free therein.
1521. F. Gregory, Manchester—Apparatus for cutting hay and chaff, or other similar purposes.
1522. S. Cook and W. H. Hacking, Bury—Apparatus for plaiting or folding woven fabrics.
1523. The Honourable C. Duncombe, Cameloff House, Hereford-street, Park-lane—Machinery for sawing wood and other substances.
1524. B. Blackburn, 1, York-buildings, Adelphi—Applying oil or lubricating fluid to locomotive and other axle-trees.
1525. T. M. Downing, Handsworth—Manufacture of corks and bungs.
1526. W. Bayliss, Monmore-green, Wolverhampton—Chain-harrows for harrowing land.
- Dated June 14, 1861.*
1527. W. C. Thomas, 6, Wells-street, Oxford-street—Metal casing or armour for the defence of ships and batteries.
1528. J. Summerscale, Keighley, Yorkshire, and M. Mason, Manchester—Gas singeing apparatus.
1529. J. Leeming, Manchester—Improvements applicable to steam boilers, furnaces, and flues.
1530. A. F. Johnson, Boston—Improvements in machinery for sewing cloth or other materials.
1531. P. Langlade, Aubusson, Creuse—Manufacture of tapestry and other weavings.
1532. T. W. Wedlake, Hornchurch, Essex—Hay-making machines.
1533. G. Leach, Leeds—Implements for tilling and cultivating the soil, and in boilers for supplying steam to engines for driving the same.
- Dated June 15, 1861.*
1534. H. J. Kennard, 36, Great George-street, Westminster—Means of excavating sand and gravel under water.
1535. R. W. Pitfield, Bolton, Lancashire—Self-acting mules for spinning cotton and other fibrous substances.
1536. T. Knowles, P. Aldred, Manchester, and J. Haworth, Salford—Apparatus for raising crested surfaces or rollers.
1537. S. Barnwell, jun., Coventry—Manufacture of upholsterers' fringes.
1538. S. Grant, St. James's-street, Westminster—Breech-loading fire-arms and fowling pieces.
1539. F. Potts, Birmingham—Metallic posts for supporting telegraph wires.
1540. W. Smith, Little Woolton, Bucks—Machinery for giving motion to ploughs, cultivators, and other agricultural implements.
1541. T. Page, Middle Scotland-yard, Westminster—Means and apparatus for facilitating the working and discharge of ordnance placed below the water level.
- Dated June 17, 1861.*
1542. H. C. Simpson, Shrewsbury—Improved vehicle or car.
1543. T. Gray, 19, Hill's Cottages, Union-road, Wandsworth—Bleaching coloured rags and vegetable fibres.
1544. S. R. Smyth, Dover—Improved steam boiler.
1545. D. B. White, Newcastle-upon-Tyne—Plummets and gauges for indicating the depth and the height or level of liquids.
1546. J. Lewis, 51, High-street, Bloomsbury—Machinery for cutting and boring wood and other substances.
1547. T. Mellowdew, Oldham, Lancashire, C. W. Kessel-meyer, Manchester, and J. M. Worrall, Salford—Dyeing and printing velvets, velveteens, and other fabrics with floated threads.
1548. T. Routledge, Eynsham Mills, near Oxford—Manufacture of paper.
1549. W. Clark, 53, Chancery-lane—Letters, designs, and other articles of mica variously coloured or metallized.
1550. W. Clark, 53, Chancery-lane—Batteries, and breech-loading ordnance and projectiles for the same.
1551. J. Perry, Earle-street East, Marylebone—Washing machines.
1552. W. and J. Todd, Heywood, Lancashire—Improvements in power-looms for weaving.
- Dated June 18, 1861.*
1553. A. R. de Normandy, Odin Lodge, King's-road, Clapham Park—Refrigerating the fresh water produced by condensing steam.
1554. J. Banks, Salisbury-street, Adelphi—Electro-magnetic telegraph printing apparatus or marking instruments.
1555. J. Miller, Greenwich, and H. E. Skinner, Wapping-wall, Shadwell—Rotary engines.
1556. F. Ziffer, Vienna—Carding engines for carding cotton and other fibrous substances.
1557. R. Walker, Glasgow—Propelling vessels.
1558. R. Fell, 9a, Great Saint Helen's—Obtaining motive power.
1559. W. B. Taylor, Balnes-road, London, N.—Heating by means of lamps.
1560. W. Fleming, Edinburgh—Apparatus for manufacturing snuff.
1561. S. Sbarp, Birmingham—Printing machines.
1562. A. W. Gibson, Belfast—Mills for the manufacture of barley and rice.
1563. J. Dunn, Preston—Apparatus for slubbing, roving, spinning, twisting, and doubling cotton.
1564. J. A. Limbert, Woodville-terrace, Gravesend—Mounting and fitting ships' guns and other ordnance.
1565. W. E. Newton, 66, Chancery-lane—Apparatus for transmitting motion.
1566. M. McKay, Birmingham—Manufacture of cements or adhesive solutions.
1567. W. E. Newton, 66, Chancery-lane—Electro-magnetic engines.
1568. T. Webb and J. Craig, Tutbury, Staffordshire—Apparatus for spinning, doubling, and winding cotton.
1569. J. E. Kirby, Banbury, Oxon—Steam engines.
1570. J. Dixon, Gallowgate Works, Newcastle-on-Tyne—Water-closets and cocks used therewith.
1571. T. T. Jobling, Sunderland—Machinery for the manufacture of bolts, spikes, screw-blanks, and rivets.
- Dated June 19, 1861.*
1572. J. Louch, 69, Fenchurch-street—Furnaces, boilers, and condensers of steam engines.
1573. C. E. Dutler, Birmingham—Manufacture of riddles or sieves.
1574. W. Clark, 53, Chancery-lane—Umbrellas and parasols.
1575. J. Fiske, 17, Wharf-road, City-road—Glazing by steam, horse or water power textile fabrics which have been worn, made up for use, or sewn together.
1576. P. Schafer and F. Schafer—Golden-square—Travelling bags or cases.
1577. P. Pradel, 4, South-street, Finsbury—An improved clasp or fastener.
1578. J. Faulding, 340, Euston-road, N.W.—Locomotive engines.
1579. G. T. Bousfield, Loughborough Park, Brixton—Brakes for railroad cars.
1580. J. F. Williams, 10, Queen-square, Saint George the Martyr—Compounds of india rubber and gutta percha with other substances.
1581. W. J. Harris, Liverpool—Dry gas meters.
1582. J. Cullen, North London Railway, Bow—Preserving wood and iron.
- Dated June 20, 1861.*
1583. L. Hannart, Brussels, Belgium—Manufacture of gloves.
1584. J. Fletcher and J. W. Fuller, both of Salford—Machines for planing, boring, and turning.
1585. C. Stevens, 31, Charing-cross—Spiral spings.
1586. M. F. A. T. de Menonville, 42, Rue Lafitte, Paris—System of condensing and ventilating.
1587. H. Lawford, 31, Berners-street—Articles for sitting, reclining, and lying upon.
1588. C. Stevens, 31, Charing-cross—Smoke consuming furnaces.
1589. W. E. Gedge, 11, Wellington-street, Strand—Apparatus for drying, sifting, and cleansing grain and other agricultural produce.
1590. A. N. Leseur, 78, Boulevard des Armandiers, Paris—A new system of crockery-ware, pannels, or of materials of the same kind.
1591. R. A. Brooman, 166, Fleet-street—Pianofortes.
1592. C. Hodgson, Ballard Rathdrum, Wicklow—Manufacture of fuel from peat.
1593. C. Hodgson, Ballard Rathdrum, Wicklow—Method of partially drying peat before removing the same from the bog.
1594. J. H. Bartholf, New Oxford-street—Construction of nursery chairs.
1595. W. E. Marsily, Antwerp—Velocipedes.
- Dated June 21, 1861.*
1596. G. Turner, Rose-terrace, Brompton—Apparatus for beating eggs and for beating or agitating other fluids, compounds, or matters.
1597. J. S. Wright, Birmingham—Reels or spools.
1598. J. Hannan and J. Hamilton, Glasgow—Engine indicators.
1599. T. R. Harding, Leeds—Pointing of steel or other wire for teeth of cards and in setting and fixing such or similar teeth into sheets or fillets.
1600. W. F. Henson, 15, New Cavendish-street—Manufacture of floorcloth, and in the means of ornamenting the same.
1601. W. Hobson, Sheffield—Steam hammers.
1602. W. Hobson and T. Cavill, Sheffield—An improved piston.
1603. J. H. Johnson, 47, Lincoln's-inn-fields—Reproduction of forms of objects applicable to the production of printing surfaces.
1604. A. L. Le Harivel, 33, Tuffnell Park-road, Upper Holloway—Manufacture of papier mache, cardboard, and other similar articles.
1605. P. H. A. C. Sapia, Paris—Instruments for measuring angles and distances.
1606. J. Church, Upper Kennington-lane, Vauxhall—Stand or rest for pianofortes or other musical instruments.
1607. J. H. Johnson, 47, Lincoln's-inn-fields—Manufacture of floor tiles or paving blocks.
1608. J. Comrie, Stirling—Churns.
- Dated June 22, 1861.*
1609. R. Ormerod, Manchester—Manufacture of ornamental or fancy ribbons.
1610. R. Russell, Sheffield—Valve to regulate the passage of fluids.
1611. J. S. McArdale, Galway—Treatment of sea weeds for the purpose of obtaining therefrom certain valuable products.
1612. John Cole and Joseph Cole, Coventry—Construction of watches.
- Dated June 24, 1861.*
1613. E. Dance, Bolton, Lancashire—Crimoline fastener.
1614. R. Moore, Cannon-street, West—Construction, steering, and propelling of ships and other floating bodies.
1615. J. Ferabee, Phoenix Iron Works, Stroud, Gloucestershire—Machines for fulling woolen and other fabrics and in the method of driving the same.
1616. R. Howson, Middlesbro'-on-Tees, Yorkshire—Barometers.

SCOTLAND RAILWAY.

'S SMOKE CONSUMING APPARATUS.

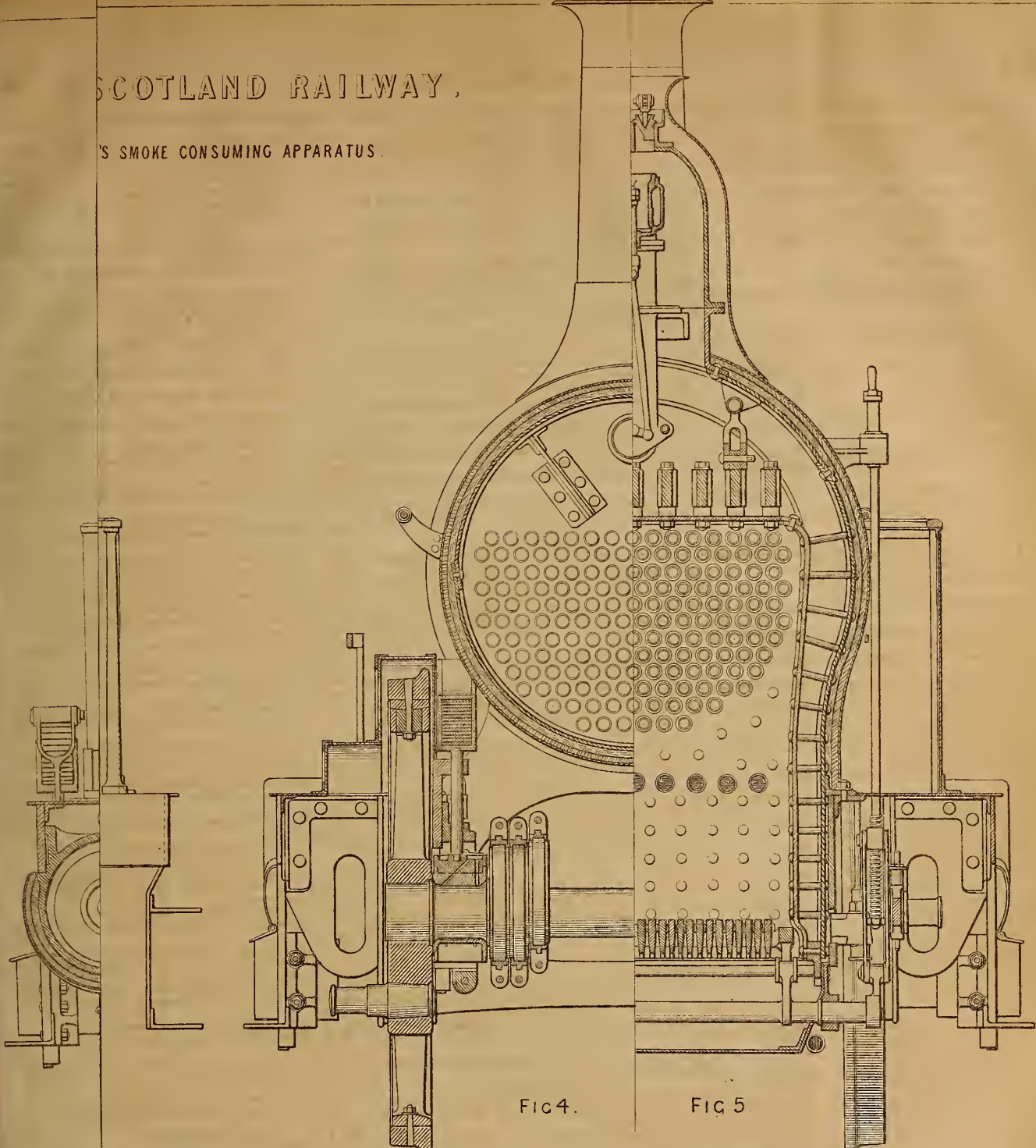
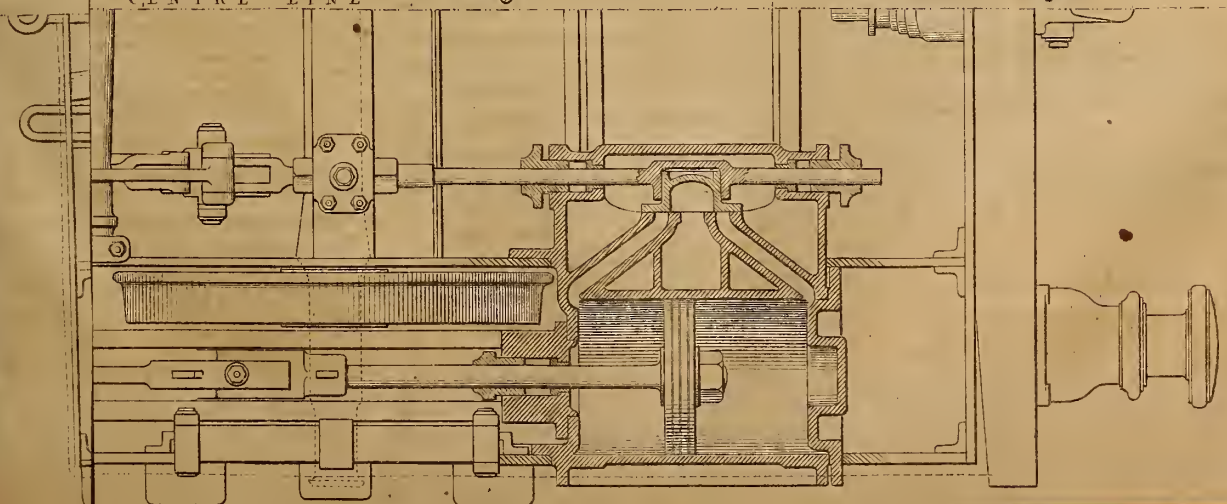

FIG 4.

FIG 5.

CENTRE LINE



GOODS ENGINE FOR THE GREAT NORTH OF SCOTLAND RAILWAY.

DESIGNED BY M^r WILLIAM COWAN, ABERDEEN

WITH D. H. CLARK'S SMOKE CONSUMING APPARATUS

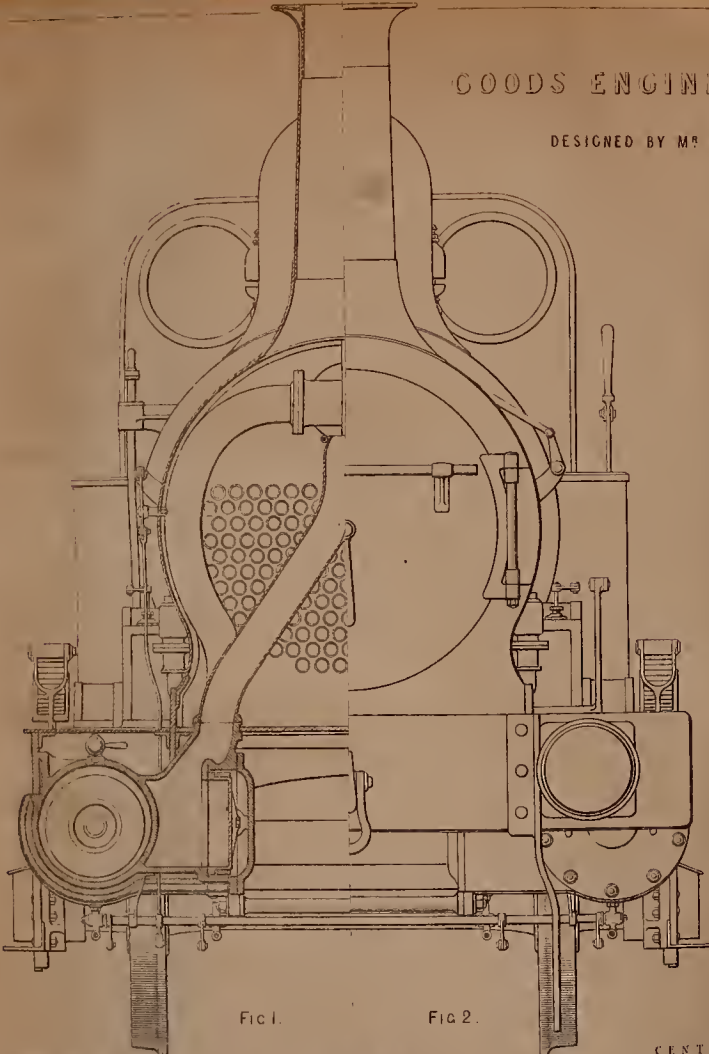

FIG 1.

FIG 2.

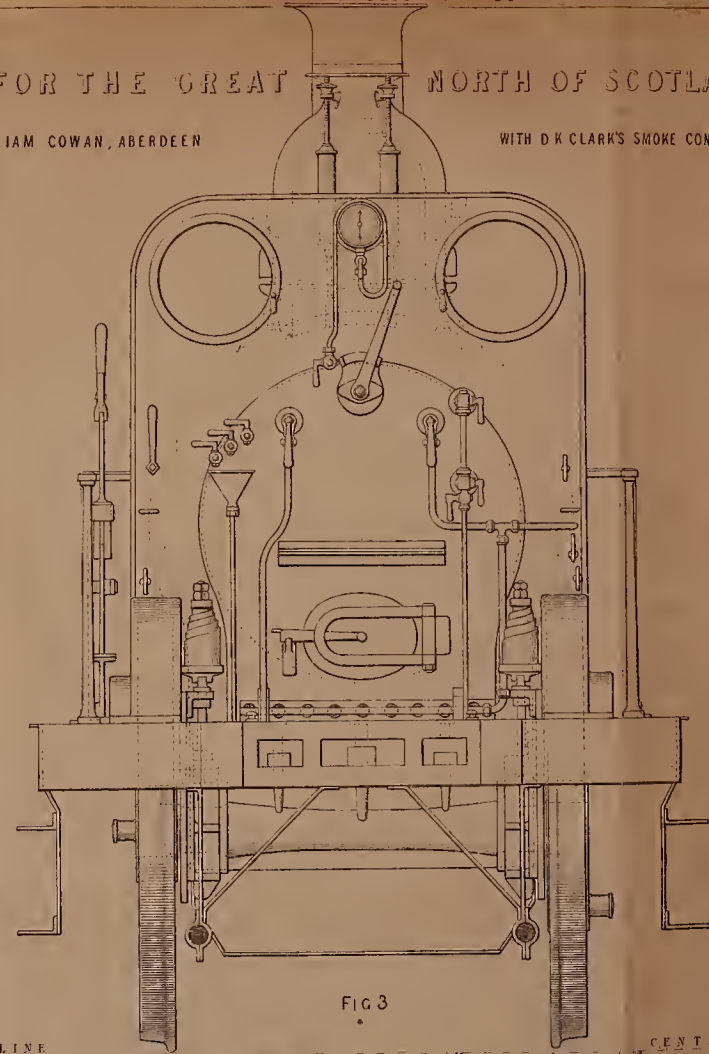

FIG 3

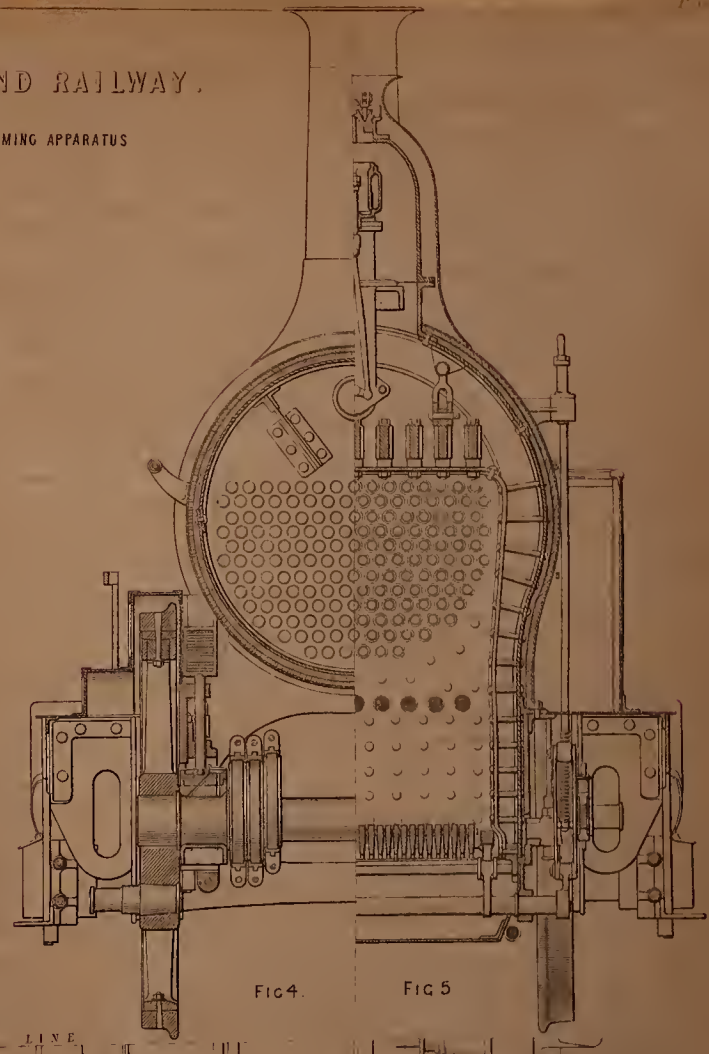

FIG 4.

FIG 5

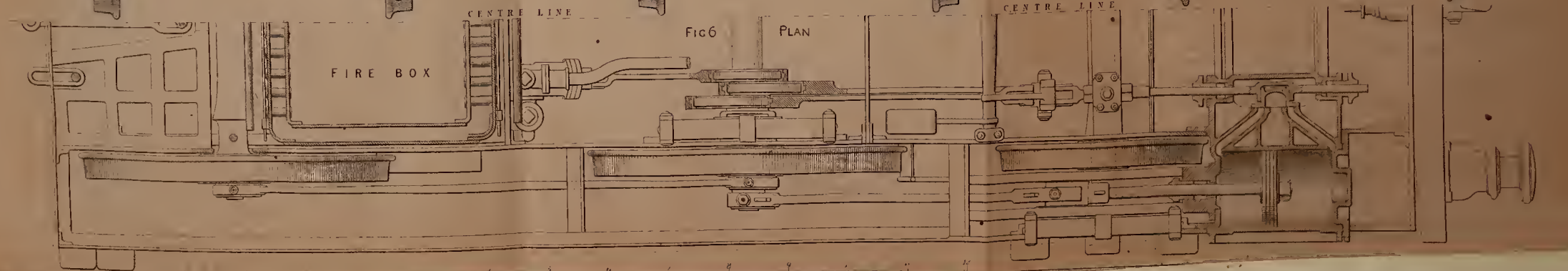

FIG 6

PLAN

FIRE BOX

CENTRE LINE

CENTRE LINE



N G.

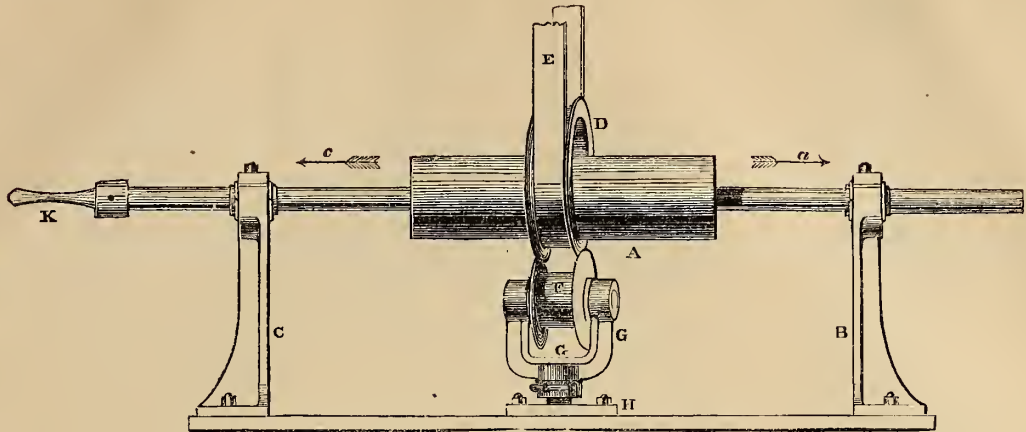

FIG. 4.

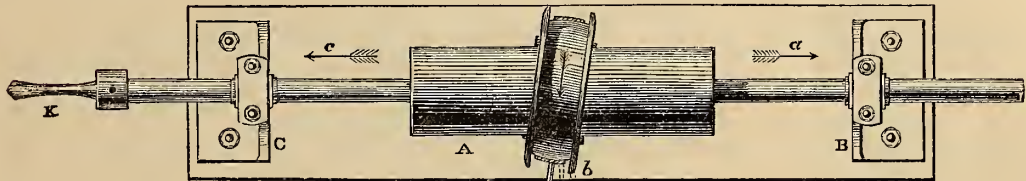

FIG. 5.

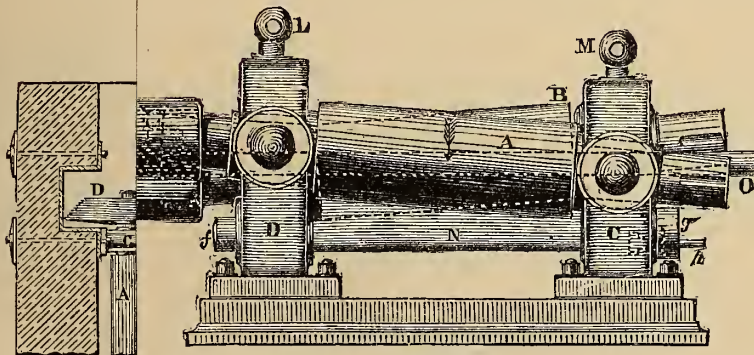

FIG. 13.

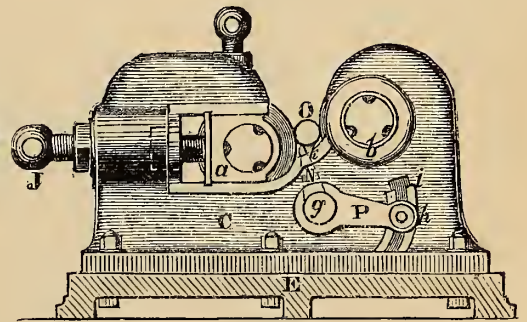

FIG. 15.

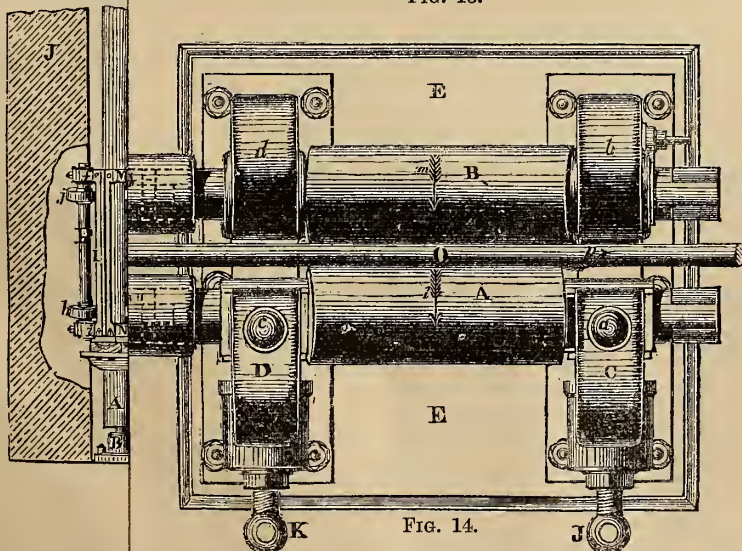

FIG. 14.

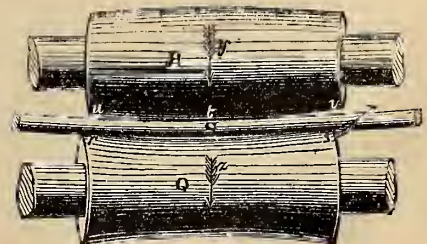

FIG. 16.

PATENT FRICTION GEARING.

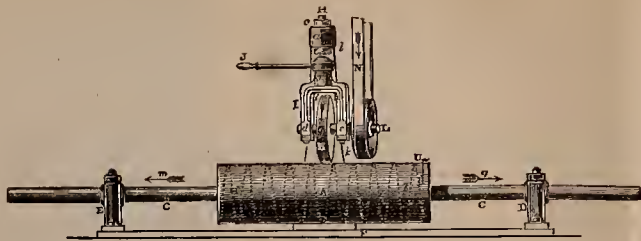

FIG. 1.

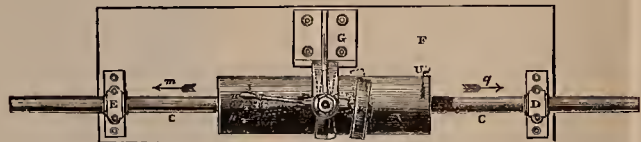

FIG. 2.



FIG. 3.

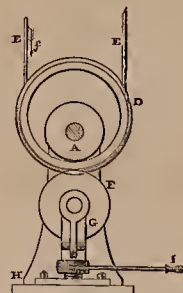

FIG. 6.

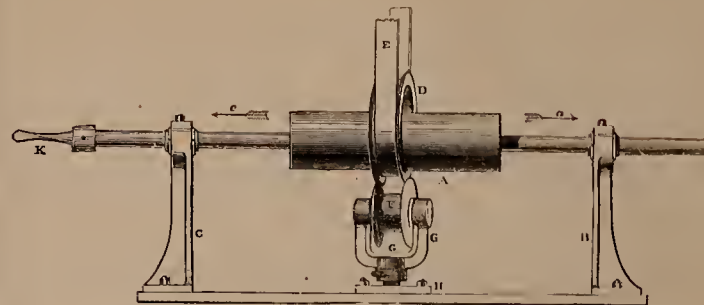

FIG. 4.

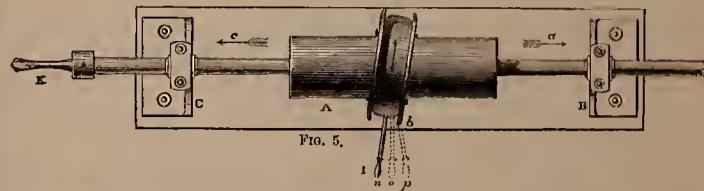

FIG. 5.

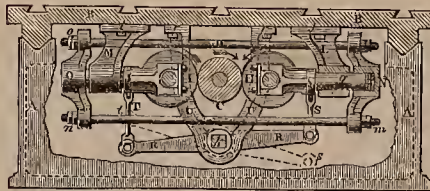

FIG. 11.

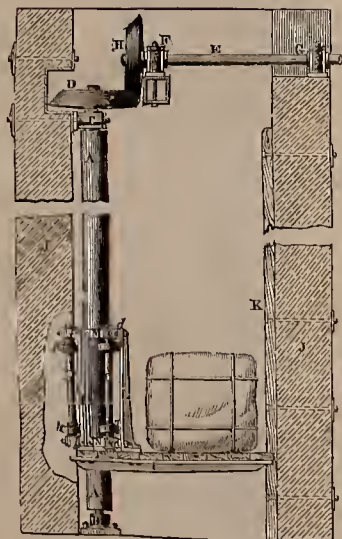

FIG. 7.

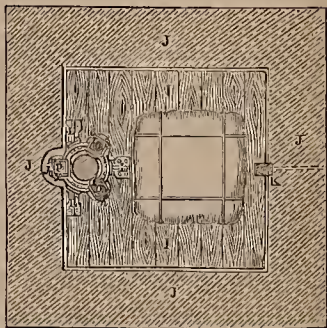

FIG. 8.



FIG. 9.



FIG. 10.

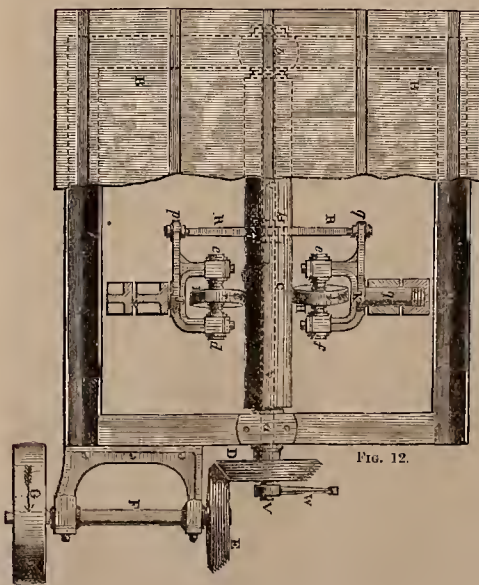

FIG. 12.

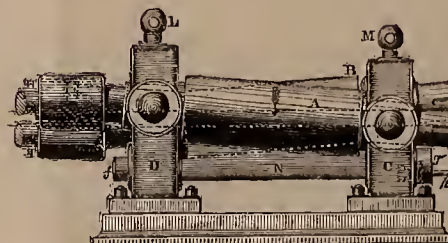

FIG. 13.

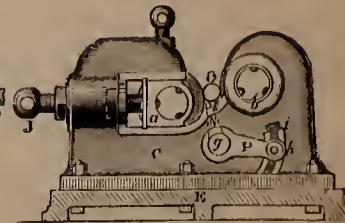

FIG. 15.

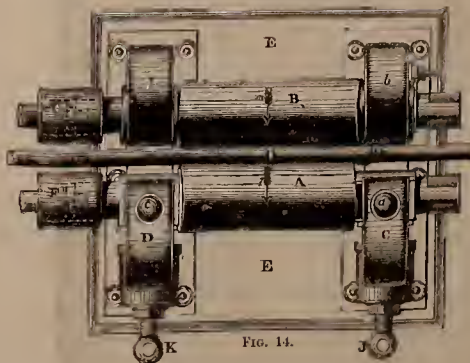
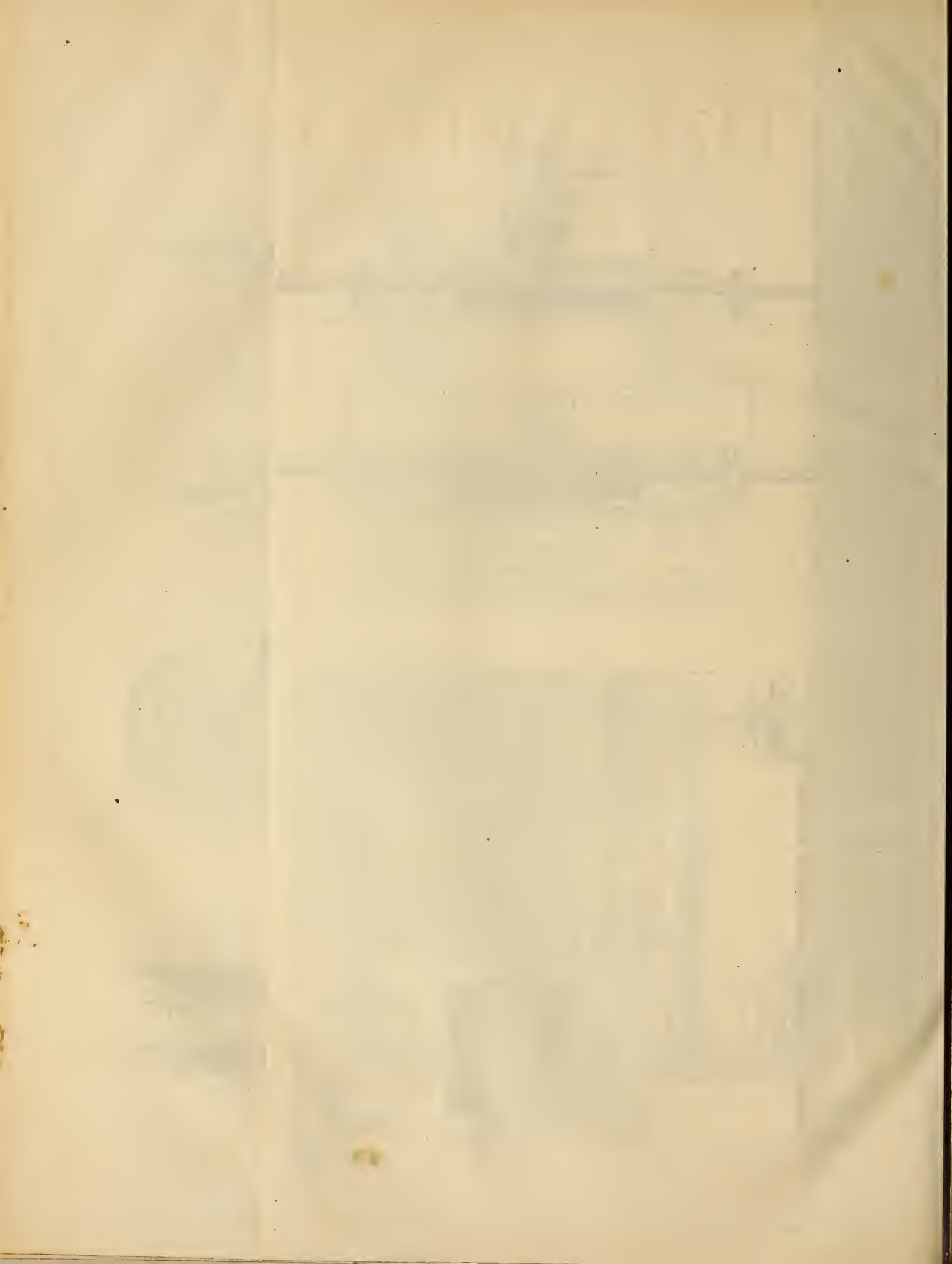

FIG. 14.



FIG. 16.



THE ARTIZAN.

No. 224.—VOL. 19.—AUGUST 1, 1861.

GOODS ENGINE FOR THE GREAT NORTH OF SCOTLAND RAILWAY.

(Illustrated by Plate 199.)

We now present our readers with a plate, containing further details of the engine, of which we gave a side elevation in plate 164. Fig. 1, represents a section through the cylinders; Fig. 2, the front elevation; Fig. 3, the back elevation; Fig. 4, a section through the driving axle; Fig. 5, a section through the fire-hox; and Fig. 6, a sectional plan taken through the centre line of the cylinder. These engines, a great number of which have been constructed for the Great North of Scotland Railway, have all been fitted with Mr. D. K. Clark's apparatus for smoke prevention. This apparatus has entirely done away with the smoke, even from very bituminous coals, and in so doing, saves a considerable amount of fuel. The perfect success of the apparatus should cause it to be adopted on all the lines where coals are used instead of coke for locomotive engines. These engines were constructed by Messrs. R. Stephenson & Co., of Newcastle, for and from the designs of Mr. W. Cowan, the Engineer of the Great North of Scotland Railway.

PRACTICAL PAPERS FOR PRACTICAL MEN.—No. V.

ON PROPORTIONING GIRDERS.

(Continued from page 151.)

Let us now see at what conclusion we should arrive, if we take the direct resistance of cast iron to tension and compression as data upon which to base our calculations. The tensile resistance we will take at 3000 lbs. per square inch for safe load, and the compressive resistance at 16,000 lbs. We will determine the moment of resistance of a section of cast iron 1 inch square. We have already observed that the neutral axis must be so situated that the moments above and below it are equal, hence in the present case it will not pass through the centre of gravity of the section, we must first determine the position of the neutral axis. Let a = distance of neutral axis from the top of beam, and b = distance of neutral axis from bottom of beam, then the moment of resistance of the upper part of the beam, if it be in compression, will be

$$= \frac{16,000 \times 2 \times a^2}{2 \times 3} = 5333 a^2$$

and that of the lower part of the beam in tension will be

$$= \frac{3000 \times 2 \times b^2}{2 \times 3} = 1000 b^2$$

but these two moments of resistance must, when the forces acting within the beam are in equilibrium, be equal, therefore,

$$5333 a^2 = 1000 b^2$$

$$b^2 = 5.33 a^2$$

$$5.33 = \left(\frac{b}{a}\right)^2$$

and extracting the square root,

$$2.309 = \frac{b}{a}$$

but the depth of the beam is 1 inch, therefore

$$a + b = 1$$

$$\frac{a}{a} + \frac{b}{a} = \frac{1}{a}$$

$$1 + 2.309 = \frac{1}{a}$$

$$\therefore a = \frac{1}{3.309} = 0.302 \text{ inches,}$$

and, therefore,

$$b = 1 - 0.302 = 0.698 \text{ inches,}$$

the moment of resistance will, therefore, be for the upper part,

$$= \frac{16,000 \times 2 \times (0.302)^2}{2 \times 3} = 486.6$$

and that of the lower part

$$= \frac{3000 \times 2 \times (0.698)^2}{2 \times 3} = 487.2$$

these two quantities nearly coincide, whereby we are assured that our calculations are correct; the total moment of resistance is

$$486.6 + 487.2 = 973.8 \text{ inch lbs.}$$

or nearly that determined from experiment.

These quantities are those which may be assumed in practice; but we will now, for further satisfaction, apply this method of calculation to a specimen which has been tested in every way, taking the breaking weights as our data.

We may first state, the formula resulting from the above calculation in a rectangular beam—the distance of the neutral axis from that surface of the beam which is in compression—is equal to the depth of the beam divided by the square root of the quotient of the compressive strength of the material divided by the tensile strength of the same, plus one.

We will calculate the transverse strength of a specimen of iron of which the tensile resistance per square inch is 25,810 lbs., and the compressive 99,524 lbs., the ratio of these will be,

$$\frac{99,524}{25,810} = 3.856$$

and for a beam 1 inch deep the distance of the neutral axis from the surface in compression will be

$$\frac{1}{2.963} = 0.337 \text{ inches,}$$

and the moment of resistance will be

$$\frac{99,524 + 2 \times (0.337)^2}{2 \times 3} = 3767.6$$

for the part in compression, and

$$\frac{25,810 \times 2 \times (0.663)^2}{2 \times 3} = 3781.4$$

for the part in tension, and the total moment of resistance will be

$$3767.6 + 3781.4 = 7549 \text{ inch lbs.}$$

The breaking weight, by experiment, was found to be 7159 inch lbs., the error being a little more than one twentieth of the strength, which may be partly accounted for by want of homogeneity in the material upon which the experiments were performed. We will now proceed to consider the application of this method to the calculation of the girder

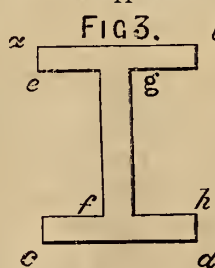

of the form shown in fig. 3. In this case it is evident that the strength of the beam will be equal to that of the square section $a b c d$, minus the sum of the strengths of the elements $e f$ and $g h$; but in order to find the strength of these elements, we must calculate the greatest strain on the outer fibres of one, or we may find the area of the triangle of direct strains by subtracting that portion which is situated on the edge of the flange.

Let the girder be of rolled iron 12 inches deep, 7 inches wide, and 1 inch thick, and allow 4 tons per square inch for the maximum strain on the outer fibre, then by proportion we find that the strain at the outer surface of the vacant space would be

$$4 \times \frac{5}{6} = 3.33 \text{ tons,}$$

because the strain on any fibre varies directly as its distance from the neutral axis.

By the formula derived from our previous investigations, we find the total strength of the square $a b c d$, the span of the beam being 130 inches,

$$W = \frac{4 s b d^2}{3 l} = \frac{4 \times 4 \times 7 \times 12^2}{3 \times 130} = 41.38 \text{ tons}$$

equally distributed over its length; from this we must subtract the strength of the spaces, which taken for the two together will be

$$W = \frac{4 s b d^2}{3 l} = \frac{4 \times 3.33 \times 6 \times 10^2}{3 \times 130} = 20.5 \text{ tons.}$$

Hence the strength of the beam will be

$$41.38 - 20.50 = 20.88 \text{ tons}$$

uniformly distributed along its length. To find its useful strength we must subtract its own weight, which is easily calculated upon the datum that 1 yard of inch square iron weighs 10 lbs., the weight of the beam will be

$$24 \text{ sq. ins.} \times 10 \text{ lbs.} \times 3.64 \text{ yards} = 0.39 \text{ tons,}$$

and subtracting this from the above quantity, we have for the useful strength 20.49 tons distributed, or 10.24 tons at the centre of the beam.

We have already, in a previous paper, shown the readiest method of treating a girder with thin flanges. From the foregoing observations it would appear that, theoretically speaking, the further the flanges are from the neutral axis of the girder the stronger will it be; but this is not practically accurate, for the increasing depth of the girder will require an increasing thickness of web, which will, when a certain point is arrived at, counterbalance the advantage gained by the depth of the beam; in practice it is found desirable not to increase the depth beyond one-tenth, nor to diminish it below one-twelfth of the span of the girder; if the latter be continuous the greatest effective span must be regarded in this calculation. We will now find an expression for the strength of a rectangular element of any dimensions distant from the neutral axis.

Let h = distance of outer surface from neutral axis.
 k = distance of inner surface from neutral axis.
 b = breadth of element.

Then if the elements were continuous to the neutral axis, its strength would be

$$W = \frac{4 s b h^2}{3 l}$$

or if l is taken in feet, the other quantities remaining as above,

$$W = \frac{s b h^2}{9 l}$$

From this must be subtracted the strength lost by the space, which would be

$$W = \frac{b k^2}{9 l} \cdot s \cdot \frac{k}{h} = \frac{s b k^3}{9 l h}$$

hence the strength of the element will be

$$W = \frac{s b}{9 l h} \{ h^3 - k^3 \}$$

Let us apply this formula to an example such as might occur in practice. Let the element be 30in. from the neutral axis, 2in. thick, and 20in. wide; let the span of the girder be 50ft.; then the strength of the element in distributed load upon the girder will be (s being 4 tons),

$$W = \frac{4 \times 20}{9 \times 50 \times 32} \{ 32^3 - 30^3 \} = 32 \text{ tons.}$$

If a girder be made up of such elements it is evident that its strength will be equal to the sum of the strengths of all the elements. We will now proceed to find an expression for the moment of resistance of a circular section, the results of which may be applicable to wrought iron shafts.

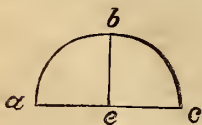

FIG 4.



the diminution of the heights; but we may consider that the whole of the direct resistances are included in the semicircular wedge, having for its

surface on each side the area $a b c$, and for the length at the back the base of the triangle d . This wedge is shown at f , and will contain all the resistances exerted by one-half the beam; hence the solid content of the wedge will represent the sum of these resistances. The depth of the wedge being equal to the base of the triangle d , is equal to the greatest strain per square inch, or = s . By a principle of Guldin, the content of the wedge is equal to the area of the semicircle multiplied by the thickness of the wedge at the centre of gravity of the semicircle. The thicknesses vary as the distance from the neutral axis $a c$; and the distance of the centre of gravity of the semicircle from its diameter is, if r = radius,

$$0.425 r \text{ nearly,}$$

the area of the semicircle will be

$$\frac{3.1416 r^2}{2} = 1.5708 r^2$$

the thickness of the wedge at the centre of gravity of the semicircle will be

$$0.425 r \frac{s}{r} = 0.425 s.$$

Hence the solid content of the wedge, or the sum of the direct resistances of the fibres in one half of the beam will be

$$1.5708 r^2 \times 0.425 s = 0.66759 s r^2$$

To find the moment of these resistances we must multiply them by the distance of the centre of gravity of the wedge from the neutral axis, which is known to be

$$\frac{3 \times 3.1416 r}{16} = 0.589 r.$$

the total moment of resistance for half the beam will therefore be,

$$M = 0.66749 s r^2 \times 0.589 r = 0.393 s r^3$$

and the moment of resistance of the whole section will be twice the above, or,

$$2 \times 0.393 s r^3 = 0.786 s r^3$$

Equating this expression with the moment of strain, we find for the strength of a circular beam at a given maximum stress per square inch the uniform total load, thus:—

$$\frac{W l}{8} = 0.786 s r^3$$

$$W = 0.786 \frac{8 s r^3}{l} = 6.288 \frac{s r^3}{l}$$

Let us illustrate the application of this formula by an example.

What is the uniform load which a cylindrical beam of wrought iron, 4in. in diameter and 8ft. long, will bear, the maximum stress per square inch for tensile or compression being taken at 4 tons?—

$$6.288 \frac{4 \times 2^3}{96} = 2.096 \text{ tons.}$$

If we wish to calculate the radius of a shaft to carry a given load, we find a formula by transforming the above expression, when

$$r = \sqrt[3]{\frac{W l}{6.288 s}}$$

Suppose we require a wrought iron shaft 6ft. long to carry half a ton at its centre; this will be equal to 1 ton of distributed load, and the radius of the required shaft will be

$$r = \sqrt[3]{\frac{1 \times 72}{6.288 \times 4}} = 1.42$$

say, $1\frac{1}{2}$ inch radius, or 3 inches in diameter.

We will now offer a few remarks upon the determination of the position of the neutral axis.

When we have to deal with sections of a complicated form, it will be exceedingly tedious to calculate the position of the centre of gravity; hence we consider it desirable to determine it by the mechanical method, which may be conducted in the following manner. Accurately draw, on a piece of stout paper of uniform thickness, a section of the girder under consideration; suspend it freely from a pin, then hold a plumb line so that the string intersects the point of suspension of the paper, and mark the point of intersection of the plumb line on the lower edge of the section; draw a straight line from this point to that of suspension; then perform the operation again, after altering the position of the paper section;—the intersection of the straight lines upon the section will be the centre of gravity of the same.

We have shown, in a foregoing part of the present paper, that in a rectangular cast iron beam the neutral axis will not pass through the

centre of gravity of the section, on account of the inequality of the resistances to tension and compression; but it is possible to design a beam of such section that the neutral axis shall pass through that point. We have said that the elongation of any fibre is as the force producing such elongation: hence, if the material of the beam exhibits five times as much resistance to compression as to tension, we may conclude that the fibres may be compressed through five times the space that they may be extended through.

If we so dispose the material that the centre of gravity is five times as far from the compression as it is from the tension surface, then will the neutral axis pass through it. The best method of procedure will be to make the top part of the beam of sufficient strength for the strain to which it will be exposed, and then to make the lower part of equal strength, the beam being flanged.

It has been usual with writers upon the subject of which we are treating to consider a multiplicity of forms, but we think that the foregoing observations will be sufficient for all practical purposes.

We may here observe that a method similar to the above has already been proposed for rectangular beams, and one somewhat similar, but far more complicated, for flanged girders; but we are not aware that it has ever been attempted to treat the circular section by any other than the ordinary process, which cannot be explained without employing the higher branches of algebraical analysis, which we have considered as unsuited to the solution of cases intended for the perusal of practical men, and which we have therefore determined to exclude entirely from the present series of papers.

NOTES ON THE CONSTRUCTION OF ENGINES AND MACHINERY;
MORE PARTICULARLY MARINE ENGINES.

(Continued from page 134.)

In proceeding it will be useful to show the difference between the three kinds of horse power, the nominal, indicated and actual.

Watt called one horse power, 33000lbs lifted 1ft. high in a minute.

THE NOMINAL HORSE POWER.

THE NOMINAL HORSE POWER is fixed by the *Admiralty Rule* (which is generally adopted all over the country), as follows:—

Multiply the area of cylinder by 7lbs. pressure, by the speed of piston in feet per minute, divide the product by 33000; the quotient is the NOMINAL HORSE-POWER of a steam engine.

Thus,

$$\frac{\text{Area of cylinder in square inches} \times 7 \text{ lbs.} \times \text{feet per minute}}{33,000} = \text{N.H.P.}$$

Example: diam. of cylinder, 30in.; stroke, 5ft.; revolutions, 21; what is the nominal horse power? 30in. diam. = 706.86 sq. in. in area, 2 x 5ft. (stroke) x 21 rev. = 210ft. speed of piston, 7lbs. pressure.

Thus,
$$\frac{706.86 \times 7 \times 210}{33,000} = 31.48 \text{ N.H.P.}$$

THE INDICATED HORSE-POWER.

THE GROSS OR INDICATED HORSE POWER is found thus:—

RULE: Multiply the average pressure, as shown on the card, taken by the indicator, by the area of piston in square inches, by the speed of the piston in feet; this product divided by 33000, will give the GROSS or INDICATED HORSE POWER of the engine.

- Let d = diameter of piston in inches.
 a = area of piston in square inches.
 s = stroke of piston in feet.
 r = revolutions or double strokes of the engine in a minute.
 p = average pressure on piston in lbs. per square inch.

For condensing engines the vacuum must be included in the pressure, p .
 Example: Required the indicated horse-power of a marine engine of the following dimensions.

- d = 76 inches.
 a = 4538 square inches.
 s = 3ft. 6in.
 r = 55 revolutions.
 p = 20lbs. average pressure of steam + 13lbs. vacuum.
 = 33lbs. average pressure per square inch of piston.

Formula :

$$\text{I.H.P.} = \frac{a \times 2s \times r \times p}{33,000}, \text{ (the speed of piston} = 2s \times r)$$

$$\text{I.H.P.} = \frac{4538 \times 385 \times 33}{33,000} = 1746.$$

THE ACTUAL HORSE POWER.

Now to find the third kind of horse-power, viz., THE ACTUAL—it is necessary to introduce into the last named formula, a "friction coefficient."

This coefficient is found to be about 30 per cent for condensing engines, and about 25 per cent for high pressure non-condensing engines.

Applying this to the last example we get :

$$1746 \times .70 = 1222.20 \text{ Actual H.P. (100 - 30 = 70 per cent.)}$$

Example: Required the actual horse-power of a high pressure non-condensing engine of the following dimensions.

- d = 18 in.
 a = 254 square in.
 s = 3ft.
 r = 70 revolutions.
 p = 50lbs. to the square inch.

Then,

$$\text{I.H.P.} = \frac{a \times 2s \times r \times p}{33,000},$$

$$\text{I.H.P.} = \frac{254 \times 420 \times 50}{33,000} = 161.6.$$

Deducting 25 per cent. (161.6 x .25 = 40.4)

161.6 - 40.4 = 121.2 Actual Horse Power.

AVERAGE PRESSURE.

RULE for calculating the average pressure after expansion: Multiply the pressure at the commencement of the stroke by the distance travelled by the piston before the steam is cut off; divide the product by the whole length of stroke; multiply the quotient by one added to the hyperbolic logarithm of the whole length of stroke, divided by the distance travelled before steam is cut off, and the result is the average pressure throughout the stroke.

- Let a = area of piston in square inches.
 S = the whole stroke of piston in inches or feet.
 s = the distance travelled by piston before steam is cut off in inches or feet.
 r = revolutions.
 p = pressure in lbs. per square inch of piston.

Then,

$$\frac{s \times p}{S} \left(1 + \text{hyp. log.} \frac{S}{s} \right) = \text{average pressure throughout the whole stroke.}$$

Example:

- diameter = 6½ in.
 a = 33.183 square inches.
 S = 1ft. or 12in.
 s = 7in. (cut off at 7in.)
 p = 70lbs. per square inch.

This represents one cylinder of a pair of engines for a portable engine.

Then,

$$\frac{7 \times 84.7}{12} \left(1 + \text{hyp. log.} \frac{12}{7} \right) = .5833 \times 84.7 (1 + \text{hyp. log.} 1.714285)$$

$$= 49.4 (1 + .536493)$$

$$= 49.4 \times 1.536493$$

$$= 75.902 \text{ lbs.}$$

Deducting 14.7 lbs. = 61.2 lbs. average pressure during the stroke.

or as $\frac{7}{12} = .5833$ and $\frac{12}{7} = 1.714285,$

and hyp. log. of 1.714283 = .536493.

Then, $.5833 \times 84.7 = 49.4$

$$.5365 \times 49.4 = 26.50$$

$$= 75.9$$

and 75.9 lbs. - 14.7 lbs. = 61.2 lbs.

Hence, area 33.183 x 61.2 = 2030.8

$$2030.8 \times 320 = 649,856$$

$$649,856 \div 1000 = 649.856 \text{ H.P.}$$

Introducing the co-efficient for loss and friction

$$19.69 \times .75 = 14.768 \text{ Actual H. P.}$$

We consequently get a collective actual Horse-Power of 29.53.

When the steam is cut off at $\frac{1}{2}$, $\frac{1}{3}$, $\frac{1}{4}$, &c.,— $\frac{1}{10}$ of the whole stroke, it is only necessary to find the hyp. log. for 2, 3, 4, &c.—10, add 1 thereto, multiply the number found by the pressure in lbs. (atmosphere included), and divide the product by the ratio of expansion.

Example: Given 70lbs. pressure (atmosphere included), rate of expansion 10.

Then the hyp. log. to 10 is 2.303 + 1 = 3.03.

$$\frac{3.03 \times 70}{10} = 21.12$$

$$\text{deducting } \frac{14.7}{10}$$

8.42 lbs. the average effective pressure.

In calculating the average pressure in practice, the atmospheric pressure should *always be included*.

When we introduce the "friction coefficient" into the formula for Indicated Horse Power, we will at once get a ready formula for Actual Horse Power.

Thus for condensing engines (the letters as before):

$$\begin{aligned} \text{Actual H.P.} &= \frac{a \times 2 s \times r \times p}{33,000} (1 - .30) \\ &= \frac{a \times s \times r \times p}{23571.4} \end{aligned}$$

For high pressure engines: Actual H.P. = $\frac{a \times 2 s \times r \times p}{33,000} (1 - .25)$

$$= \frac{a \times s \times r \times p}{22,000}$$

Calling the two divisors,—in the formula,

$$\frac{a \times s \times r \times p}{23,571.4} \text{ and } \frac{a \times s \times r \times p}{22,000}; -x$$

then we ascertain the other quantities by simple arithmetic:

$$a = \frac{H x}{s r p}$$

$$s = \frac{H x}{a r p}$$

$$r = \frac{H x}{a s p}$$

$$p = \frac{H x}{a s r}$$

RULES FOR THE PROPORTIONS OF SOME OF THE MOST IMPORTANT PARTS OF MARINE ENGINES.

To find the area in square inches of the safety valve.

Multiply the number of lbs of coal burned per hour on the firegrate, by .0417, the result is the area of the safety valve in square inches.

Example: Supposing the grate surface contains 4 square feet, and 18lbs. of coals are burnt per square foot of fire grate; what is the area in square inches of the safety valve?

$$72 \times .0417 = 3 \text{ square inches; } 3 \text{ sq. in. equal to 2in. nearly in diameter.}$$

To find the area of steam pipe and passages.

Multiply .96 by the nominal horse-power, the product is the area in square inches.

Example: Find the area of a steam-pipe for a steam-engine of 50 horse power nominal, viz.:

$$.96 \times 50 = 48 \text{ sq. in.; diam.} = 7\frac{3}{4} \frac{1}{16} \text{ in.}$$

The exhaust steam pipe equal to area of steam pipe $\times 1.6667$.

$$\text{Thus: } 48 \times 1.6667 = 80 \text{ sq. in.}$$

The reason why we use the Nominal Horse-Power in the calculation in this particular case is on account of the difference in speed of steam, of 7lbs. and 100lbs. to the sq. in., being so very little, viz. 1900 and 2000 ft. in a second, respectively; but as the speed of steam in an engine should never be more than about 8ft. per second; there is ample reason for using the nominal horse-power in this case.

INJECTION WATER.

About 25 cubic inches injection water are allowed in practice for each cubic inch of water in the shape of steam, used in the cylinder; the temperature of condenser being about 100°, and the injection water about 50°.

RULE for finding the correct number of cubic feet of injection water required for the condensation of each cubic foot of water in the shape of steam exhausted into the condenser, so that the condenser is kept at a certain temperature.

Let H = Total heat of steam exhausted into the condenser in degrees Fahr.
T = temperature of the water after condensation in degrees Fahr.
t = temperature of injection water in degrees Fahr.
n = number of cubic feet of injection water required to keep the condenser at a certain temperature.

$$\text{Then, } n = \frac{H - T}{T - t}$$

Example: Let the exhaust steam of an engine be at the temperature corresponding to the sensible heat of 212°, and the condenser is to be kept at a temperature of 110°; the injection water being 60°; then according to the rule above

$$\frac{1178.1 - 110}{110 - 60} = \frac{1068.1}{50} = 21.36 \text{ cubic feet.}$$

If H remains the same, T equals 105°, and t, 60°.

$$\text{Then, } \frac{1178.1 - 105}{105 - 60} = \frac{1073.1}{45} = 23.84$$

$$\text{Thus, } n = 23.84$$

INJECTION ORIFICE.

The area of the injection orifice is to be determined from the quantity of water, necessary to condense the steam used in the engine. Supposing the vacuum is to be kept at the usual amount of, say 26in., then to find the speed at which the water will enter the condenser, we must take the equivalent to 26in. of mercury, viz., a column of water 29.5 feet high. And, according to the rule for falling bodies, the velocity is obtained by extracting the square root of the space passed through in feet, multiplied by 8.0207. Thus $\sqrt{29.5 \times 8.0207} = 43.562$ the velocity in feet per second, when entering the condenser. Now as about 25 cubic feet are allowed in practice for the condensation of one cubic foot of water in the shape of steam used per hour, or 12 cubic inches per second, the orifice must be large enough to admit that amount at a speed of 43.562ft. per second, or 534.75in. per second. Dividing 12 cubic inches by 534.75 we get an area of .0244 square inches, and allowing 100 per cent for the real discharge, makes .0488, say .05 square inches, still allowing something for friction and bend of the pipes, makes .07 sq. in. for each cubic foot of water used in the engine in the shape of steam per hour.

SIZE OF AIR-PUMP.

The size of the air-pump is ascertained by finding the amount of water to be extracted from the condenser. This is very easy as we know the amount of water required for each cubic foot of water in the shape of steam, used in the engine per hour. Taking this at 25 cubic feet, we get 26 cubic feet of water per hour to remove from the condenser for each cubic foot of water in the shape of steam used in the cylinder. Example:—Supposing we have 360 cubic feet water in the shape of steam, used per hour in the engine—

$$\begin{aligned} \text{then } 360 \times 26 &= 9360 \text{ cubic feet per hour} \\ &= 156 \text{ cubic feet per minute} \end{aligned}$$

15 revolutions of engine = 10.4 cubic feet per stroke, being single acting.

length of stroke = 4ft.

$$\frac{10.4}{4} = 2.6 \text{ square feet area of air pump bucket}$$

but allowing 50 per cent = 1.3

$$= 3.9 \text{ square feet}$$

$$3.9 \times 144 = 561.6 \text{ square inches}$$

$$= 20.75 \text{ inches in diameter}$$

Some makers allow 100 per cent. to ensure a complete acting pump.

$$\text{Thus } 2.6 + 2.6 = 5.2$$

$$5.2 \times 144 = 748.8 \text{ square inches}$$

$$= 30.875 \text{ inch diameter of air pump bucket.}$$

SIZE OF FEED-PUMP.

In finding the size of the feed-pump we must first ascertain the amount of water to be evaporated per hour in the boiler. Having found that to

be as in the last example 360 cubic feet per hour, we must proceed thus:—

360 cubic feet per hour = 6 cubic feet per minute.
15 revolutions of engines makes 4 cubic feet per stroke, being single acting.
= 691.2 cubic inches per stroke
length of stroke being 4ft. (48") = $691.2 \div 48 = 14.4$ square inches or
= $4\frac{1}{4}$ in. diameter.

This result is the *theoretical* size, but as there must be allowed for blowing off in boiler, slip of pump, waste of steam, leakage, &c., besides *only one* pump being generally in use at a time in a *pair* of engines, the feed pump is always made $2\frac{1}{2}$, and sometimes even $3\frac{1}{2}$ times the theoretical size, which in this case would be respectively $6\frac{3}{4}$ full and 8in diameter.

THE BILGE-PUMP.

The bilge pump is generally made the same size as the feed-pump, except where the engines are rather small in proportion to the ship, for instance, where merchant ships are provided with an auxiliary engine.

PISTON RODS.

In calculating the diameter of the piston rod it is only necessary to take the crushing force into consideration, being less than half that of the breaking weight of wrought iron, viz., about 27,000lbs. to the square inch.

RULE:—Multiply the area of the piston in square inches by the highest pressure, that will at any time be applied, in lbs., and divide the product by the safe co-efficient of the crushing force; the result will be the area of piston rod in square inches.

Putting A = area of piston in square inches.
p = pressure in lbs. per square inch.
f = the co-efficient of the crushing force.
a = area of piston rod in square inches.

$$\text{then } a = \frac{A \times p}{f}$$

Example:—Supposing we have a piston of 3000 square inches area; pressure, 20lbs. steam + 13lbs. vacuum, making a total of 33lbs.; what is the diameter of the piston rod?

$3000 \times 33 = 99000$ lbs.; $f = \frac{1}{10}$ part of the crushing force, viz., 2700 lbs.
 $99000 \div 2700 = 36.667$ square inches = $6\frac{1}{2}$ in. diameter nearly.
allowing $\frac{1}{8}$ inch for wear = 7in. diameter.

SLIDE RODS.

To find the size of the slide rod we must first ascertain the full pressure on the slide, divide that by the co-efficient of friction, and the result is the weight to be lifted or pushed by the slide rod. Having thus found the weight, divide that by f (= 2700), as in the above example, and the result is the area of the slide rod in square inches.

Example:—Supposing we have a slide 24in. by 20in.; pressure (if low pressure vacuum must be included) 100lbs. on the square inch; what is the diameter of the slide rod?

$$24 \times 20 = 480; 480 \times 100 = 48000\text{lbs.}$$

Taking the co-efficient of friction for cast iron on cast iron, when first oiled and then wiped off again, which is equal to .14 (this being the way slides must be considered)—

we get $48000 \div 7 = 6857$ lbs. ($\frac{1}{2} = .14$)
and $6857 \div 2700 = 2.54$ = area in square inch of slide rod
 2.54 square inch = $1\frac{3}{4}$ in. diameter
and allowing $\frac{1}{8}$ in. for wear = $1\frac{1}{2}$ in. diameter.

CONNECTING RODS.

In calculating the diameter of the connecting rod, we use exactly the same rule as for the piston rod, with exception of the co-efficient of crushing force which is in this case $\frac{1}{10}$ instead of $\frac{1}{15}$.

Thus using the same letters as for piston rods we get $\frac{A \times p}{f} = a$ at the end of the connecting rod; considering the ends to be in the very centre line of the bearings at the extremity of the rod.

Example:—Using the same example as for piston rods, we have the total weight on piston 99000lbs.; $\frac{1}{2}$ part of the crushing force is 3000lbs., and $99000 \div 3000 = 33$ square inches = 6 $\frac{1}{2}$ in. diameter. Having found the diameter of the connecting rod at the ends, we have another point to take into consideration, viz., the stiffness of the rod; and to make it stiff enough, it is necessary to enlarge it considerably at the middle. Bourne has given a very applicable rule, viz.

Multiply .0035 by the length of the rod in inches, add unity and multiply this sum by the diameter of the ends of the rod in inches; the product is the diameter of the connecting rod in inches at the middle.

Putting d = diameter at the ends in inches
D = diameter at the middle in inches
L = length of rod in inches
then $D = (.0035 \times L + 1) d$

Applying this to the above example, where $d = 6\frac{1}{2}$ in., $L = 8$ ft. = 96in.
we get $.0035 \times 96 = .336$
 $.336 + 1 = 1.336$
 $1.336 \times 6.5 = 8.69 = 8\frac{3}{4}$ in. full say $8\frac{1}{2}$ in. at the middle.

The connecting rod should *never* be made less than four times the length of the crank, and if it can conveniently be made from five to six times longer, so much the better.

Before we leave the piston rod, slide rod, and connecting rod, it is necessary to remark that some makers even go so far as to use only $\frac{1}{2}$ part of the crushing force, but this is quite unnecessary and a mere waste of metal. The only case in which the co-efficient of the crushing force might be increased to $\frac{1}{10}$ part or 2500lbs. to the square inch, is where the stroke is very long in proportion to diameter of cylinder.

In steeple engines either horizontal or vertical it is of course quite necessary to allow something for the very long piston rods to keep them stiff.

In oscillating engines where the piston rod is the connecting rod also, and where the piston rod is exposed to the momentum of the vibration of the cylinder, which tends to break the piston rod across, a still greater allowance must be given. The co-efficient of crushing force is in this case generally $\frac{1}{12}$ part (2250 lbs.), and sometimes even $\frac{1}{15}$ part or only 2000lbs. to the square inch.

All the other rods in an engine, working under similar circumstances to the connecting rod, alternately exposed to pulling and pushing, should be calculated exactly in the same manner, and made stouter at the middle in accordance with the above rule.

CRANK PINS.

The joint that connects the connecting rod with the crank is the crank pin, and is to be calculated as a gudgeon.

GUDGEONS.

RULE: Extract the square root of the weight in lbs on gudgeon, and divide this by 28 or 30 for wrought iron; the quotient is the diameter of the gudgeon in inches.

Putting d = diameter in inches; W = weight in lbs.

$$\text{Then, } d = \frac{\sqrt{W}}{28} \text{ or } d = \frac{\sqrt{W}}{30}$$

The divisor 28 is generally used, where the length of the bearing does not exceed the diameter, and 30 where it does exceed the diameter.

Example: Supposing we have got 22500lbs on gudgeon

$$\text{Then, } d = \frac{\sqrt{22,500}}{30} = \frac{150}{30} = 5 \text{ inches,}$$

length of gudgeon = $1\frac{1}{2}$ diam. thus = $7\frac{1}{2}$ inches.

It is necessary at this place to show that the bearing is large enough in respect to friction; for a bearing should never be loaded with more than 800lbs. to the square inch, or else the oil will be pressed out between the two surfaces in contact, and it is better always to have it considerably under that pressure, if circumstances will allow of it.

The square inches, upon which the pressure is reckoned, are found by multiplying the diameter by the length of the bearing and not the circumference by the length.

Applying this to the present example we get diam. 5in. \times length $7\frac{1}{2}$ in. = 37.5sq. in. $22500\text{lbs.} \div 37.5 = 600\text{lbs.}$ on the square inch.

We thus see that this rule gives a fair amount of rubbing surface, not at all likely to heat or to cut, as it would be, when we exceeded the extreme of 800lbs. to the square inch.

It will also be useful to show that this rule gives a strong gudgeon in respect to transverse strain, which will be seen by considering it as a beam (round), and then find the diameter accordingly.

$$\text{As } c = \frac{W L}{S} \text{ (see (3) page 132) we get by inserting the real values of the letters; } c = \frac{22,500 \times 625 \text{ feet}}{118} \\ = \frac{14,062.5}{118} \\ = 119.1 \\ \sqrt[3]{119.1} = 4.92 \text{ inches diameter.}$$

S being in this case the breaking weight for a beam No. II. (see page 132) and taking 10 as the factor of safety, will be 118.

We thus see that the rule above (which gave 5in.) gives a very strong gudgeon.

CRANKSHAFTS.

In calculating crankshafts it is necessary to use the *highest pressure* that can at any time be applied to the piston, and therefore it is not correct to calculate it from the horse power of an engine, for neither the nominal nor the indicated (which gives the average pressure), nor the actual (the friction being deducted) give the extreme pressure on the piston.

RULE: *Multiply the weight on the piston in lbs per square inch by the length of the crank in feet: extract the cube root of the product, and divide the result by a coefficient; the quotient is the diameter of the crankshaft in inches.*

This coefficient is to be determined according to circumstances as will be seen in the following.

- Let W = weight on piston in lbs. per square inch.
- R = length of crank in feet.
- d = diameter of crankshaft in inches.
- c = coefficient.

Then,
$$d = \frac{\sqrt[3]{WR}}{c}$$

There are two different coefficients for *Crankshafts in Paddle-Boats*, viz.: One for river steamers and vessels intended for smooth waters.

Here $c = 6.25$.

Another coefficient is used for steamers intended to encounter gales and heavy seas.

Here $c = 5.75$.

There are likewise two coefficients for *Crankshafts used in Screw-Boats* viz. :-

- One for larger engines, $c = 5.25$.
- and another for smaller ones, $c = 5.15$.

EXAMPLE.—The diameter of cylinder 92in., stroke 4ft., pressure on piston 20lbs. steam + 13lbs. vacuum; what is the diameter of crankshaft?

92 inches diameter = 6647.6 square inches in area.

$6647.6 \times 33 \times 2 \times 2 = 877,480$ (*the last 2 = No. of engines)

$\sqrt[3]{877,480} = 95.74$

$95.74 \div 5.25 = 18.236$ inches, say $18\frac{1}{4}$ inches.

CRANKS.

In calculating a crank we must first find the size of the crankshaft and crankpin, and then consider the crank itself entirely as a single beam (I) (see page 132); from this we will find the breadth and depth of the crank itself. Make the area of a section of the large eye on one side of the shaft equal to $\frac{1}{8}$ part of the crushing force.

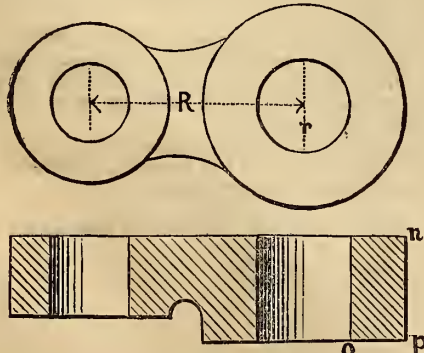

This will be better understood by referring to an example. Supposing we have 93,291lbs. on piston, crankshaft 12in., and length of

crank 2ft. 3in. Making the length of the crankpin $1.25 \times$ diameter, we get the diameter of pin = 10in. Now considering the web of crank as a single beam, and using 10 as the factor of safety, we get (S) = 100, and using the formula for beams, we get the constant $(b d^2) = 2099$.

Fixing $b = 8$; $2099 \div 8 = 262.3$.

$\sqrt{262.3} = 16.2$.

This is the depth of the web at the crankshaft centre. We have now to fix the sizes of the metal of the large eye of crank, and in doing so we must find, how many square inches the area *n.o.* ought to contain to resist the crushing force upon it.

Setting W = weight on piston in pounds per square inch.

R = length of the crank in inches.

r = half diameter of crankshaft in inches.

and 4500 lbs. = $\frac{1}{8}$ part of the crushing force upon wrought iron.

Then,
$$\text{area} = \frac{WR}{r \times 4500}$$

RULE.—*Multiply the weight in pounds per square inch on piston by the length of crank in inches, divide the product by half the diameter of the shaft in inches times $\frac{1}{8}$ part of the crushing force of wrought iron; the quotient is the area in square inches of the section of one side of the large eye of crank.*

This rule applied in this case gives 93 square inches. $93,291 \times 27 = 2,518,827$; $6 \times 4500 = 27,000$; $2,518,827 \div 27,000 = 93$ square inches.

A very near approximation is obtained by considering r as unity, and then $r \times 1.125 = o p$, and $r \times 2.25 = p n$.

Giving in this case $6 \times 1.125 = 6.75$ inches, and $6 \times 2.25 = 13.5$ inches.

$6.75 \times 13.5 = 97$ square inches.

In respect to the small eye, call diameter of crank pin = d, then diameter of the small eye = 2d, and height of ditto = d.

KEYS, PINS, AND COTTERS.

It may be useful here to make a few observations about the shearing force of keys, pins, and cotters, applied to connect the moving parts of an engine. As for straps and cotters, the cotters either consisting of one, two, or three parts should have the same sectional area to resist *shearing force* as the rod has to resist the *tensile strain* (not the crushing). The same rule applies to keys.

In fixing the size of pins, a different point has to be considered, namely, whether the rubbing surface is large enough or not. Taking this into consideration, the **RULE** is this: *Extract the square root of the weight in pounds, lifted by the rod, and divide the result by 28; this will give the diameter of the pin in inches.* Make, when possible, the length of the pin between supports $1\frac{1}{2}$ times the diameter.

EXAMPLE.—Having, for instance, a rod of 1 inch diameter, carrying 2356 lbs., what is the size for a pin for that rod?

$\sqrt{2356} = 48.5$; $48.5 \div 28 = 1.74$, say, $1\frac{3}{4}$ inches.

$1.75 \times 2.625 = 4.59$ sq. ins., giving 512 lbs. to the sq. in. of rubbing surface.

WROUGHT IRON BEAMS AND CROSSHEADS.

The first of these two must be calculated according to the rules for beams (see page 132), and likewise if of cast iron.

Crossheads with gudgeons at the ends are to be calculated, the gudgeon according to the rule for them, and the other part as a beam; in this case, however, it is not usual to make the depth at the middle more than $3\frac{1}{2}$ times the breadth.

CYLINDERS.

RULE.—For fixing the thickness of the metal:

Extract the square root of the diameter and multiply it by .2, which will give the thickness of the metal in inches. The flange is equal to the thickness of the metal multiplied by 1.125.

Of course, for horizontal cylinders, a good allowance must be made for wear at the bottom side of the cylinder.

EXAMPLE.—Cylinder (horizontal) 82 inches diameter

$.2 \sqrt{82} = 2 \times 9.06 = 1.81 = 1\frac{3}{4}$ inch nearly,

being horizontal, the cylinder should be at least $2\frac{1}{4}$ in. at the bottom, when finished.

RULE for fixing the thickness of the metal in jacketed cylinders :
Multiply $\cdot 16$ by the square root of the diameter in inches ; the product is the thickness of the inner cylinder in inches. For the outer cylinder or shell use the coefficient $\cdot 13$ instead of $\cdot 16$.

For the inner cylinder $t = \cdot 16 \sqrt{D}$;

For the outer cylinder $t = \cdot 13 \sqrt{D}$.

t being the thickness in inches, and $D =$ diameter of cylinder in inches.

The outer cylinder must be connected with the inner one with strengthening ribs.

FRICITION OF CYLINDERS.

The friction of one large cylinder is in proportion to the friction of any number of cylinders, (the sum of their areas being equal to the area of the large one) as the square root of the number to the number.

For instance the friction of

1 cylinder : 4 cylinders :: $\sqrt{4} : 4$
:: 2 : 4

Thus the friction is in this case only one-half of the friction of 4 cylinders of the same collective area.

PISTONS.

To find the whole height of a piston in the direction of the length of the cylinder.

RULE.—Multiply the square root of the diameter of the cylinder by $1\cdot 3$; the product is the whole height of a piston for a HORIZONTAL or OSCILLATING cylinder ; for a VERTICAL or UPRIGHT cylinder, multiply by $1\cdot 162$.

To find the height of the piston ring.

RULE.—Multiply the square root of the diameter of the cylinder by $\cdot 81$; the product is the height of the piston ring for a HORIZONTAL or OSCILLATING cylinder ; for a VERTICAL or UPRIGHT cylinder, multiply by $\cdot 72$.

ABSTRACT OF ENGINEER'S LOG OF THE "GREAT EASTERN"—SECOND VOYAGE FROM NEW YORK TO LIVERPOOL.

Date of each Day, ending at Noon.	PADDLE ENGINES.				SCREW ENGINES.				Total quantity of Coals used each Day.	Number of Knots run by the Paddle Engines.	Number of Knots run by the Screw Engines.	Distance run by the Ship, in Knots.	REMARKS.
	Revolutions of Engines each Day.	Average Revolutions per minute.	Average Pressure of Steam in Engine Room.	Tons of Coals used each Day.	Revolutions of Engines each Day.	Average Revolutions per minute.	Average Pressure of Steam in Engine Room.	Tons of Coals used each Day.					
Saturday, May 25	1,670	9'	20	48	13,765	37	18	83	131	{ Left Sandy Hook at 8.30 A.M. ; Light Ship 9.40.
Sunday ,, 26	13,604	9'7	20	132	52,065	31'1	18	157	289	351	376	337	Dense fog ; standing by engines.
Monday ,, 27	13,866	9'9	21½	128	53,685	38'2	19	162	291	360	390	300	Dense fog ; standing by engines.
Tuesday ,, 28	14,049	10'	21	132	54,405	38'3	19	163	295	363	390	351	Dense fog ; standing by engines ;
Wednesday ,, 29	13,401	10'	21	128	53,149	39'	19½	159	287	345	386	309	{ Dense fog ; Stopped to take Soundings.
Thursday ,, 30	14,485	10'3	22	136	54,873	39'	19	165	301	370	396	350	Light fair wind ; sea smooth.
Friday ,, 31	14,812	10'6	22	132	55,172	39'4	19½	167	300	376	397	348	Light fair wind ; sea smooth.
Saturday, June 1	15,943	11'35	22	134	56,460	40'	19½	167	301	407	408	346	Light fair wind ; sea smooth.
Sunday ,, 2	15,491	11'15	21	128	54,515	38'73	18	160	288	393	388	330	{ Engines stop'd 10 min. to speak A. Mail S. from Southampton.
Monday ,, 3	14,532	10'3	20½	135	52,464	37'3	17	158	293	373	380	320	{ Coals running very small ; run in 600 tons of water to trim her.
Tuesday ,, 4	5,477	11'2	20	53	19,854	40'5	19	65	118	134	136	90	{ Arrived off the Light Ship at 8.10 P.M.
Totals	137,430	10'4	21½	1287	520,407	38'5	18½	1606	2893	3456	3646	3083	{ Actual time steaming, 9 days, 3 hours, 8 min.

OR, Multiply the whole height of the piston by $\cdot 62$, the result is the height of the piston ring.

The thickness of the piston ring is ascertained by multiplying the height of the piston ring by $\cdot 14$.

All the dimensions for these rules are in inches.

EXAMPLE.—The cylinder is 64ins. diameter ; what is the height of the whole piston and the piston ring for a horizontal engine ?

$\sqrt{64} \times 1\cdot 3 = 10\cdot 4$; say, $10\frac{1}{2}$ inch = the whole height of the Piston.

$\sqrt{64} \times \cdot 81 = 6\cdot 48$; say, $6\frac{1}{2}$ inch = the height of the Piston Ring.

$6\cdot 5 \times \cdot 14 = \cdot 91$; say, 1 inch = thickness of the Piston Ring.

All the preceding rules are given under the supposition that every engineer designing engines and machinery has got his TABLES beside him, and thus the rules given will save a great deal of time.

As it has now been shown how to calculate the principal parts of a marine engine, it is not intended for the present to enter upon any further details in this respect ; but, before concluding, it might be useful to show how a steam boiler can be calculated without referring to nominal horse power, or any horse power at all.

(To be continued.)

"GREAT EASTERN" STEAMSHIP.

We have been favoured with the following two abstracts of the logs of the *Great Eastern* ; the first giving the performance during her voyage from New York to Liverpool, lasting from May 25th to June 4th, the actual time being 9 days 3 hours. The second log gives her performance on her voyage from Liverpool to Quebec, lasting from June 27 to July 6, the actual time being 8 days 22 hours.

Density of Water in Boilers, $1\frac{1}{2}$; Vacuum in Paddle Engines, 25 ; ditto in Screw, 26. Immersion, leaving New York, 22ft. 9in. forward ; 25ft. 5in. aft. Extreme diameter of Paddle Wheel, 51ft. 6 in. Effective diameter of Wheel, 49ft. 6in. = 155ft. 6in. each Revolution. Screw, 44 feet Pitch. No perceptible wear on Screw-shaft-bearing. Immersion, on arrival at Liverpool, 19ft. 4in. forward ; 24ft. 2in. aft.

ABSTRACT OF ENGINEER'S LOG OF THE "GREAT EASTERN."—FIRST VOYAGE FROM LIVERPOOL TO QUEBEC.—JUNE TO JULY, 1861.

Date, each day ending at Noon.	PADDLE ENGINES.				SCREW ENGINES.				Total quantity of Coals used each Day.	Number of Knots run by the Paddle Engines.	Number of Knots run by the Screw Engines.	Distance run by the Ship, in Knots.	Latitude.	Longitude.	Course.	GENERAL REMARKS, &c.
	Revolutions of Engines each day.	Average Revolutions per Minute.	Average Pressure of Steam in Engine Room.	Tons of Coals used each Day.	Revolutions of Engines each Day.	Average Revolutions per Minute.	Average Pressure of Steam in Engine Room.	Tons of Coals used each day.								
June 27	N.	W.	Left Liverpool at 11.30 a.m.
" 28	13,193	9.8	22	143	50,110	37.0	19½	195	338	325	361	302	51.17	9.57	s. 77 w.	Pilot left at 2 p.m. Full speed at 2.20 p.m.
" 29	14,119	9.62	22	145	53,850	36.7	19½	214	359	349	388	302	51.26	18.4	n. 86 w.	Light breeze; sea smooth; cloudy.
" 30	14,768	10.07	22	170	54,120	36.9	19½	218	388	366	390	326	51.9	26.41	s. 87 w.	Thick fog; standing by engines from 10 p.m. till 8 a.m.
July 1	14,972	10.23	21½	153	54,870	37.5	19½	187	340	371	395	328	50.51	35.10	s. 87 w.	Thick fog; standing by engines.
" 2	15,684	10.38	22	150	55,460	38.3	19	179	329	384	395	330	49.26	43.25	s. 75 w.	At 4.30 a.m. steamship <i>Arabia</i> ahead; stopped engines 7 minutes.
" 3	15,155	10.48	22	132	53,940	37.1	19	178	309	390	391	326	47.26	51.04	s. 69 w.	Passed several icebergs; paddle engines stopped 53 minutes; screw engines 10 minutes.
" 4	14,784	10.16	22	130	51,880	35.67	19	167	297	367	376	299	46.40	58.12	s. 80 w.	Thick fog; paddles stopped 5 min.; both sets of engines going easy 6 hours and 55 minutes.
" 5	15,525	10.66	21	146	52,410	36.0	18	169	315	381	379	320	49.24	64.50	n. 57 w.	Thick fog; both sets of engines going easy 1 h. 30 m.
" 6	13,015	10.0	21	114	45,700	33.38	18	142	256	327	334	280	At 7.15 p.m. stop'd engines to take pilot on board; at 8.40 went on full speed; both sets of engines going easy 5 h. 15 m.; log made up till 12 noon; afterward the engines steaming easy up to our moorings; came to anchor at 7 p.m.
Totals...	131,219	10.2	22	1282	472,340	36.78	19	1649	2931	3260	3409	2803	Actual time steaming 8 days 22 hours.

Density of Water in Boilers, 1¼; Vacuum in Paddle Engines, 25; ditto in Screw, 26. Extreme diameter of Paddle Wheel, 50 feet; Effective diameter, 48 feet = 150.79 feet each Revolution; Screw 44 feet pitch. Immersion on leaving Liverpool, 23ft. 4in. forward; 28ft. 1in. aft. Immersion on arrival at Quebec, 21ft. 6in. forward; 25ft. 6in. aft. The Injectors working well. No perceptible wear on Screw-shaft-bearing.

ON THE CONSUMPTION OF GAS AS AFFECTED BY PRESSURE, OR THE LAW ACCORDING TO WHICH PRESSURE REGULATES THE CONSUMPTION OF GAS.

(Continued from page 154.)

It has usually been assumed that when gas issues from an orifice, the consumption varies as the square root of the pressure. This law is not accurate, as I have made many hundreds of experiments on various kinds of fish-tail and batswing burners at all variations of pressure, and have found that the law accords very unsatisfactorily with the results of actual experiments. According to this law the consumption of gas at a pressure of 4-tenths should be double the consumption at a pressure of 1-tenth.

The following results taken at random from an extensive series of experiments show how far from the truth the theory would lead us in this case:—

No. of Experiment.	Consumption at a Pressure of 1-tenth.	Theoretical Consumption at a Pressure of 4-tenths.	Actual Consumption by Experiment.
1	.85	1.70	2.72
2	.98	1.96	2.65
3	1.16	2.32	3.14
4	1.14	2.28	3.30

Again, the consumption at 9-tenths should, according to theory, be 50 per cent. more than the consumption at 4-tenths; but the following are the actual results of experiments:—

No. of Experiment.	Consumption at Pressure of 4-tenths.	Theoretical Consumption at a Pressure of 9-tenths.	Actual Consumption by Experiment.
1	3.77	5.65	6.04
2	2.30	3.45	3.90
3	3.50	5.25	5.71
4	2.72	4.08	4.78
5	2.65	3.98	4.69
6	3.14	4.71	5.62
7	3.30	4.95	5.58

Applying these results to the case of the street lamps, if we take the known consumption at a small amount of pressure, say 4-tenths, and calculate the corresponding consumption at a high pressure, according to the common theory we should obtain quantities considerably too small. But, on the contrary, if we calculate the consumption for a low pressure, the result is considerably greater than that which actually obtains.

Thus, suppose a lamp at the first hour of lighting is burning with a pressure of 16th-tenths, and consuming 5 cubic feet an hour, and in the small hours of the morning the pressure goes down to 4-tenths. According to theory the consumption should be 2½ feet at 4-tenths, but in reality it is only 1.87 feet, so that theory gives a result 25 per cent. in excess of the true quantity.

Let *p* be any given pressure of gas.
q the quantity of gas delivered or consumed at pressure *p*.
P any given pressure for which the consumption is required.
Q the quantity of gas consumed, corresponding to pressure *P*

Then, according to the theory already quoted, we have—

$$\sqrt{p} : \sqrt{P} :: q : Q;$$

$$\frac{q \sqrt{P}}{\sqrt{p}} = Q, \text{ or } q \left(\frac{P}{p} \right)^{\frac{1}{2}} = Q \dots (1)$$

It has been contended that in the passage of gas through an orifice there is always a resistance which is uniform and entirely independent of pressure, and that the equation should, therefore, contain an expression entirely independent of p . After making many hundreds of experiments however, I can discover no empirical rule of this kind which will agree with experimental results. I have tried in vain numerous formulæ of the form $\sqrt{p + n p}$, but have never succeeded in this direction in obtaining even a fair approximation to the experimental results. On the contrary, I find that the consumption varies far more consistently according to $p^{\frac{7}{2}}$ than according to any other form of p .

I have, therefore, confined myself to a determination of the value of n or the index of the power which should be taken for p . The very numerous experiments I have made conclusively show that the consumption really varies as $p^{\frac{7}{2}}$ or as $\sqrt{p^7}$. Thus I find that

$$p^{\frac{7}{2}} : P^{\frac{7}{2}} :: q : Q, \text{ or } \frac{P^{\frac{7}{2}}}{p^{\frac{7}{2}}} = Q \dots (2)$$

As it is troublesome to calculate this fractional root of the pressure without a table of logarithms, I have thought it useful to append a table showing the 7-tenth root of all pressures varying by half a tenth from 1-tenth up to 30.

TABLE SHOWING THE PROPORTIONATE CONSUMPTION OF GAS AT PRESSURES VARYING FROM ONE-TENTH OF AN INCH TO 3 INCHES OF WATER.

Pressure in tenths of an inch or value of p .	Consumption in cubic feet or value of $p^{\frac{7}{2}}$.	Pressure in tenths of an inch or value of p .	Consumption in cubic feet or value of $p^{\frac{7}{2}}$.	Pressure in tenths of an inch or value of p .	Consumption in cubic feet or value of $p^{\frac{7}{2}}$.	Pressure in tenths of an inch or value of p .	Consumption in cubic feet or value of $p^{\frac{7}{2}}$.
1.0	1.00	8.5	4.47	15.5	6.81	23.0	8.98
1.5	1.33	9.0	4.65	16.0	6.96	23.5	9.11
2.0	1.62	9.5	4.83	16.5	7.11	24.0	9.25
2.5	1.90	10.0	5.01	17.0	7.27	24.5	9.38
3.0	2.16	10.5	5.19	17.5	7.41	25.0	9.52
3.5	2.40	11.0	5.36	18.0	7.56	25.5	9.65
4.0	2.64	11.5	5.53	18.5	7.71	26.0	9.78
4.5	2.87	12.0	5.69	19.0	7.85	26.5	9.91
5.0	3.09	12.5	5.87	19.5	8.00	27.0	10.04
5.5	3.30	13.0	6.02	20.0	8.14	27.5	10.17
6.0	3.51	13.5	6.18	20.5	8.28	28.0	10.30
6.5	3.71	14.0	6.34	21.0	8.43	28.5	10.43
7.0	3.90	14.5	6.50	21.5	8.56	29.0	10.56
7.5	4.10	15.0	6.67	22.0	8.70	29.5	10.69
8.0	4.29	22.5	8.84	30.0	10.81

It is easy from equation (2) to see the mode of using this table, for,

$$q \frac{P^{\frac{7}{2}}}{p^{\frac{7}{2}}} = \frac{q}{p^{\frac{7}{2}}} P^{\frac{7}{2}} = Q \dots (3)$$

Hence, when q and p are given, it is only necessary to divide q by the tabular number or consumption opposite to p in the table, and multiply the quotient by the tabular number opposite to P ; the product is the consumption corresponding to pressure P .

Thus, suppose a burner at a pressure of 10-tenths consumes 4 feet of gas, what will it consume at a pressure of 6-tenths?

Here we have $q = 4$, $p = 10$, and $P = 6$; also by the table $p^{\frac{7}{2}}$, or $10^{\frac{7}{2}} = 5.01$, and $P^{\frac{7}{2}}$ or $6^{\frac{7}{2}} = 3.51$. Hence,

$$\frac{4}{5.01} \times 3.51 = 2.80,$$

the consumption at a pressure of 6-tenths.

The following will be the rule in words showing the method of using the table: Divide the given consumption by the tabular number opposite the corresponding pressure, and call the quotient c . Then the product of c by the tabular number opposite the pressure for which the consumption is required, will give that consumption in cubic feet.

It will be observed that c , which is merely the quotient of any consumption, divided by the 7 root of the corresponding pressures, becomes a constant for any particular burner, and may be used in determinations of consumption at all other pressures. Of course when c is more than unity, the burner is larger than the one for which the table is calculated, and *vice versa*, when c is less than unity, the burner is smaller.

It is obvious that by the use of this table it is very easy when once the constant of the burner is determined, to calculate the consumption of that burner for all other pressures. Thus it is only necessary to make an accurate experiment by means of a graduated gas holder, or an experimental meter as to the quantity of gas which a burner will consume at one given pressure; then this quantity divided by the tabular number gives the constant of that burner from which all other consumptions at other pressures can be determined as I have shown, without the necessity for any further experiments with the meter or gas holder.

Of course there is nothing in all this which dispenses with the necessity for determining accurately the pressures at which the gas is burned, but this being done, a great deal of labour in experiment is saved by adopting the table for calculating the consumptions.

ON THE LAWS OF PRESSURE AND MODE OF DETERMINATION.

1. If we conceive coal gas to issue from any gas holder under a fixed and determinate pressure as so many inches of water, and to be diffused throughout a system of perfectly horizontal pipes with every orifice closed and no burners in action, then the pressure will be identically the same in every part of the system. It will be perfectly independent, both of the size of pipes and of distance from the holder.

2. But if the pipes are laid at irregular inclinations, the pressure will vary according to the height above or below a horizontal line. Thus it is usually assumed that the pressure will increase 1-tenth of an inch for every 10 feet of elevation, or 1-hundredth of an inch for every foot of elevation, and will diminish in a corresponding manner for every 10 feet of depression.

3. When the system of pipes has a number of orifices from which the gas is escaping—in other words when, many burners are in action, and there is a great draught on the pipes at various and irregular points—the rule of pressure becomes varied accordingly, and results quite opposed to those which would be derived from considering elevation alone are frequently obtained.

The pressures here spoken of are those taken at any part of a distributing apparatus, without reference to any particular burner, and are to be distinguished from those taken actually at the burner, namely between the tap and the point of consumption when the gas is actually burning, or the gas escaping unburnt.

The former pressure I shall hereafter call the *stopped pressure*, and the latter the *pressure at burner*.

I now proceed to describe the most convenient apparatus for taking the pressure of gas at the individual burners, particularly with reference to street lamps, and the determination therefrom of the consumption due to the pressure.

The figure 1 shows the form of pressure gauge which I am in the habit of using for taking the pressure of gas burnt in the street lamps. It consists essentially of a glass tube bent in the form of the letter U, with a horizontal arm communicating with the tube, and which arm is screwed to a contrivance called the T piece. The burner is in its turn screwed into the T piece, and the gauge being filled with coloured water* to the zero line on the scale, the instrument is complete and ready for use. This gauge is a great improvement on the old fashioned form which consisted of an additional pipe and several more joints than mine. It was also very inconvenient to use, as it had no union joint at the end of the horizontal arm, and had simply to be hung by means of a conical bored socket upon a corresponding projection and was consequently very liable to drop off and get smashed during the course of an experiment. The following letters of reference are used in the figure, which will render the whole apparatus very intelligible.

a is the service pipe through which the gas passes to the burner.

b is the T piece screwed in its place, and the form of which will be more particularly seen from the separate elevation, fig. 2.

c is a screwed cap to fit the top of the T piece when we wish to take the stopped pressure or the pressure of the gas when not burning, and subject to no influence from the draught of the particular burner.

* The coloured water for the gauge is made by infusing a little pounded cochineal in hot water, and adding a few drops of hydrochloric or nitric acid, which prevents the colour from fading, and preserves the bright scarlet of the original infusion. The infusion must be filtered, and is then ready for use.

MODE OF TAKING PRESSURE.

Blow out the flame, unscrew the burner or tip of the street lamp without in any way disturbing the cock as adjusted by the lamplighter. Then screw the T piece into the socket of the burner, and replace the latter by screwing it into the top of the T piece; then suspend the gauge from the horizontal projection of the T piece and read the pressure, first while the gas is stopped from escaping through the orifice, and, secondly, while the flame is actually burning exactly as turned on by the lamplighter.

Enter both observations or readings under the proper hour. The gauge may then be taken off, the T piece unscrewed, and the burner restored in its original place.

It may be observed that this mode of taking the pressures is much more easy to perform than to describe, and if any difficulty arises in understanding the preceding description, Mr. Hughes, 14, Park-street, Westminster, will be happy to show, by actual experiment, the mode in which it is proposed the pressures should be taken, together with the form of gauge and T piece which is recommended for use.

The pressures should be taken if possible, at every hour throughout the night, or if taken at longer intervals these should correspond with the times at which the pressure at the works is known to vary.

In any case the observations should be continued during at least six or seven days, at the end of which time the burner of each lamp experimented on should be taken off and carefully replaced by another and a similar burner, so that the public lighting may not be interrupted.

The burners so taken off, being first carefully numbered to correspond with the observations, are then to be forwarded to the managers for the purpose of having their actual consumption tested at various pressures.

The sheets containing the nightly pressures should at the same time be forwarded to the managers.

The following table, which has been carefully computed from the "British Almanac," will be useful to surveyors and others who superintend the public lighting arrangements. The table shows the complete period in each month of the year, from sunset to sunrise, and by means of the figures here given it is easy to calculate the hours of burning when any other time is fixed on for lighting and extinguishing, or when, as in some places, the street lamps are not lighted on moonlight nights.

TABLE SHOWING HOURS BETWEEN SUNSET AND SUNRISE.

MONTH.	Hours from midnight to sunrise, being the sum of the times at which the sun rises, as taken from the British almanac.		Sum of the times at which the sun sets.		Hours from sunset to midnight, being the amounts in column 2 deducted from twelve times the number of days in each month.		Total hours from sunset to sunrise, being sum of the hours in columns 1 and 3.	
	H.	M.	H.	M.	H.	M.	H.	M.
January	247	29	134	42	237	18	484	47
February	203	55	145	33	190	27	394	22
March	193	27	188	2	183	58	377	25
April	153	10	207	30	152	30	305	40
May	129	27	239	24	132	36	262	03
June	113	0	247	20	112	40	225	40
July	126	0	251	12	120	48	246	48
August	148	49	226	28	145	32	294	21
September	168	19	186	08	173	52	342	11
October	200	01	157	05	214	55	414	56
November	220	10	124	54	235	06	455	16
December	248	17	119	31	252	29	500	46
	2152	04	2227	49	2152	11	4304	15
Addition in leap year	6	49	5	37	6	23	13	12
	2158	53	2233	26	2158	34	4317	27

AVERAGE DURATION FROM SUNSET TO SUNRISE.

3 years 4304.15 = 12,912.45
 1 year 4,317.27
 4)17,230.12
 Average..... 4,307 Hours, 33 Minutes.

(To be continued.)

STRENGTH OF MATERIALS.

DEDUCED FROM THE LATEST EXPERIMENTS OF BARLOW, BUCHANAN, FAIRBAIRN, HODGKINSON, STEPHENSON, MAJOR WADE, U.S. ORDNANCE CORPS, AND OTHERS.

(Continued from page 9.)

To ascertain the Transverse Strength of a Rectangular Bar or Beam.

When a Bar or Beam is fixed at one end, and loaded at the other.

RULE.—Multiply the Value of the material in the preceding tables, or as ascertained, by the breadth, and square of the depth, in inches, and divide the product by the length in feet; the quotient is the result in pounds.

NOTE.—When the beam is loaded uniformly throughout its length, the result must be doubled.

EXAMPLE.—What are the weights each that a cast and a wrought iron bar, 2in. square and projecting 30in. in length, will bear without permanent injury.

The Values for cast and wrought iron in this and the following calculations are assumed to be 250 and 200.

Hence, $250 \times 2 \times 2^2 = 2000$, which $\div 2.5 = 800$ lbs.
 $200 \times 2 \times 2^2 = 1600$, which $\div 2.5 = 640$ lbs.

Or, if the dimensions of a Bar or Beam be required to support a given weight at its end.

RULE.—Divide the product of the weight and the length in feet, by the Value of the material, and the quotient will give the product of the breadth and the square of the depth of the bar or beam.

EXAMPLE.—What is the depth of a wrought iron beam, 2in. broad, necessary to support 640lbs. suspended at 30in. from the fixed end?

$640 \times 2.5 = 1600$, which $\div 250 = 6.4$, which $\div 2$ in. for the breadth, = 4, and $\sqrt{4} = 2$ = the depth required in inches.

When a bar or beam is fixed at both ends, and loaded in the middle.

RULE.—Multiply the Value of the material in the preceding tables, or as ascertained, by six times the breadth, and the square of the depth in inches, and divide the product by the length in feet, the quotient is the result in pounds.

NOTE.—When the beam is loaded uniformly throughout its length, the result must be doubled.

EXAMPLE.—What weight will a bar of cast iron, 2in. square and 5ft. in length, support in the middle, without permanent injury?

$250 \times 2 \times 6 \times 2^2 = 12,000$, which, $\div 5 = 2400$ lbs.

Or, if the dimensions of a bar or beam are required to support a given weight in the middle, between the fixed ends.

RULE.—Divide the product of the weight and the length in feet, by six times the Value of the material, and the quotient will give the product of the breadth, and the square of the depth of the bar or beam.

EXAMPLE.—What dimensions will a cast iron bar, 5ft. in length, require to support without permanent injury, a stress of 2400lbs?

$\frac{2400 \times 5}{250 \times 6} = \frac{12000}{1500} = 8$, which, $\div 2$ in. for the assumed breadth, = 4, and $\sqrt{4} = 2$ = the depth required in inches.

When the breadth or depth is required.

Divide the product obtained by the preceding rules by the square of the depth, and the quotient is the breadth; or by the breadth, and the square root of the quotient is the depth.

ILLUSTRATION.—If 128 is the product, and the depth is 8—

Then, $128 \div 8^2 = 2$, the breadth.

Also, $128 \div 2 = 64$; and $\sqrt{64} = 8$, the depth.

When the weight is not in the middle between the ends.

RULE.—Multiply the Value in the preceding table, or as ascertained, by three times the length in feet, and the breadth and square of the depth, in inches, and divide the product by twice the product of the distances of the weight, or stress from either end.

EXAMPLE.—What is the weight a cast iron bar, fixed at both ends, 2in. square and 5ft. in length, will bear without permanent injury, 2ft. from one end?

$\frac{250 \times 3 \times 5 \times 2 \times 2^2}{2 \times 2 \times 3} = \frac{30,000}{12} = 2500$ lbs.

When a bar or beam is supported at both ends, and loaded in the middle.

RULE.—Multiply the Value of the material in the preceding tables, or as ascertained, by four times the breadth, and the square of the depth in inches, and divide the product by the length in feet, the quotient is the result in pounds.

NOTE.—When the beam is loaded uniformly throughout its length, the result must be doubled.

EXAMPLE.—What weight will a cast iron bar, 5ft. between the supports, and 2in. square, bear in the middle, without permanent injury?

$$250 \times 2 \times 4 \times 2^2 = 8000, \text{ which, } \div 5 = 1600 \text{ lbs.}$$

Or, if the dimensions be required to support a given weight.

RULE.—Divide the product of the weight and length in feet, by four times the Value of the material, and the quotient will give the product of the breadth, and the square of the depth of the bar or beam.

When the weight is not in the middle between the supports.

RULE.—Multiply the Value of the material in the preceding tables, or as ascertained, by the length in feet, and the breadth, and the square of the depth in inches, and divide the product by the product of the distances of the weight, or stress from either support.

EXAMPLE.—What weight will a cast iron bar, 2in. square and 5ft. in length, support without permanent injury, at a distance of 2ft. from one end or support?

$$\frac{250 \times 5 \times 2 \times 2^2}{2 \times (5 - 2)} = \frac{10,000}{6} = 1666\text{.}67 \text{ lbs.}$$

To ascertain the pressure upon the ends or upon the supports.

RULE.—1. Divide the product of the weight and its distance from the, nearest end or support, by the whole length, and the quotient will give the pressure upon the end or support furthest from the weight.

2. Divide the product of the weight and its distance from the furthest end, or support, by the whole length, and the quotient will give the pressure upon the end or support nearest the weight.

EXAMPLE.—What is the pressure upon the supports in the case of the preceding example.

$$\frac{1666\text{.}67 \times 2}{5} = 666\text{.}67 \text{ lbs. upon support furthest from the weight.}$$

$$\frac{1666\text{.}67 \times 3}{5} = 1000 \text{ lbs. upon support nearest to the weight.}$$

When a Bar or Beam, fixed or supported at both ends, bears two weights at unequal distances from the ends.

Let m represent distance of greatest weight from nearest end.
 n represent distance of least weight from nearest end.
 W represent greatest weight.
 w represent least weight.
 L represent whole length.
 l represent distance from least weight to furthest end.
 l' represent distance of greatest weight from furthest end.

Then,
$$\frac{m \times W}{L} + \frac{l \times w}{L} = \text{pressure at } w \text{ end,}$$

and
$$\frac{n \times w}{L} + \frac{l' \times W}{L} = \text{pressure at } W \text{ end.}$$

When a Bar or Beam is fixed at one or both ends, or supported at both ends, and the weight increases as the distance from the free end, or from one of the supports, as the case may be.

The effect of the weight is $\frac{3}{4}$ of that which would be produced if it was applied at the end or in the middle; hence, for all practical purposes it may be taken as doubled.

When the Plane of the Bar or Beam projects obliquely upwards or downwards.

When fixed at one end and loaded at the other.

NOTE.—When the weight is laid uniformly along its length, the result must be doubled.

RULE.—Multiply the Value of the material in the preceding tables, or as ascertained, by the breadth and square of the depth, in inches, and divide the product by the product of the length in feet and the cosine of the angle of elevation or depression.

EXAMPLE.—What is the weight an oak beam, 5ft. in length, 3in. square, and projecting upwards at an angle of $7^\circ 15'$, will bear without permanent injury?

$$55 \times 3 \times 3^2 = 1485, \text{ which, } \div 5 \times \cos. 7^\circ 15' = 1485 \div 5 \times \text{'99} = 299\text{.}391 \text{ lbs.}$$

To ascertain the transverse strength of cylinders, ellipses, &c.

When a Cylinder, Rectangle (the diagonal being vertical), Hollow Cylinder, or Beams having sections of an ellipse and equilateral triangle, are either fixed at one end and loaded, the load applied in the middle, or between the supports.

RULE.—Proceed in all cases as if for a rectangular beam, taking for the breadth and depth and Value of the material, as follows:—

Cylinder,	diameter ³	× '6 of Value.
Rectangle,*	side ³	× '7 of Value.

* The strength of a rectangle, the diagonal being vertical, compared to that of its circumscribing rectangle, when the direction of the strain is parallel to the side of it, is 245 to 1.

Hollow cylinder (diam.³ — diam.^{'3}), × '6 of Value.

Ellipse, transverse diam. vertical conj. × transverse², × '6 of Value.

Fixed at One or Both Ends.

Equilateral triangle, edge up, breadth × depth², × '2 of Value.

Equilateral triangle, edge down, breadth × depth², × '34 of Value.

T bar or beam, edge up, breadth × depth², × '42 of Value.

Supported at Both Ends.

Equilateral triangle, edge up, breadth × depth², × '34 of Value.

Equilateral triangle, edge down, breadth × depth², × '2 of Value.

└ bar or beam, edge up, breadth × depth², × '42 of Value.

To ascertain the diameter of a Solid Cylinder to support a given weight.

When fixed at one end, and loaded at the other.

RULE.—Multiply the weight to be supported, in pounds, by the length of the cylinder, in feet; divide the product by '6 of the Value of the material, and the cube root of the quotient will give the diameter.

NOTE.—When the cylinder is loaded uniformly throughout its length, the cube root of half the quotient will give the diameter.

EXAMPLE.—What should be the diameter of a cast iron cylindrical beam 8in. in length, to support 1500lbs. without permanent injury?

$$8 \text{ inches is '66 feet. } \frac{15,000 \times \text{'66}}{\text{'6} \times 250} = 66,$$

and

$$\sqrt[3]{66} = 4\text{.}04 \text{ inches.}$$

When fixed at both ends, the weight applied in the middle.

RULE.—Multiply the weight to be supported, in pounds, by the length of the cylinder in feet; divide the product by '6 of the Value of the material, and the cube root of one-sixth of the quotient will give the diameter.

NOTE.—When the cylinder is loaded uniformly along its length, the cube root of half the quotient will give the diameter.

EXAMPLE.—What should be the diameter of a cast iron cylinder 2ft. in length between the ends, to support 21,000lbs. without permanent injury?

$$\frac{21,000 \times 2}{\text{'6} \times 250} = 280, \text{ and } \sqrt[3]{\frac{280}{6}} = 3\text{.}59 \text{ inches.}$$

When supported at both ends, the weight applied in the middle.

RULE.—Multiply the weight to be supported in pounds, by the length of the cylinder between the supports in feet; divide the product by '6 of the Value of the material, and the cube root of one-fourth of the quotient will give the diameter.

NOTE.—When the cylinder is loaded uniformly along its length, the cube root of half the quotient will give the diameter.

EXAMPLE.—What should be the diameter of a cast iron cylinder, 2ft. between the supports, that will support 60,000lbs. without permanent injury?

$$\frac{60,000 \times 2}{\text{'6} \times 250} = 800, \text{ and } \sqrt[3]{\frac{800}{4}} = 5\text{.}85 \text{ inches.}$$

And what its diameter, if loaded uniformly along its length?

$$\frac{800 \div 2}{4} = 100, \sqrt[3]{100} = 4\text{.}64 \text{ inches.}$$

To ascertain the relative value of materials to resist a transverse strain.

Let v represent this Value in a beam, bar, or cylinder, one foot in length, and 1in. square, side, or in diameter; w , the weight; l , the length; b , the breadth; d , the depth; m , the distance of the weight from one end; and n , the distance of it from the other.

NOTE.—In cylinders, for $b d^2$ put d^3 .

1. Fixed at one end. Weight suspended from the other.

$$\frac{l W}{b d^2} = V.$$

2. Fixed at both ends. Weight suspended from the middle.

$$\frac{l W}{6 b d^2} = V.$$

3. Supported at both ends. Weight suspended from the middle.

$$\frac{l W}{4 b d^2} = V.$$

4. Supported at both ends. Weight suspended at any other point than the middle.

$$\frac{m n W}{l b d^2} = V.$$

5. Fixed at both ends. Weight suspended at any other point than the middle.

$$\frac{2 m n W}{3 l b d^2} = V.$$

From which formulæ, the weight that may be borne, or any of the dimensions, may be found by the following:—

$$1. \quad \frac{V b d^2}{l} = W; \quad \frac{V b d^2}{W} = l; \quad \frac{l W}{V d^2} = b; \quad \sqrt{\frac{l W}{b V}} = d.$$

In rectangular beams, &c., b and $d = \sqrt[3]{\frac{l W}{V}}$.

$$\frac{6 b d^2 V}{l} = W; \quad \frac{6 b d^2 V}{W} = l; \quad \frac{l W}{6 d^2 V} = b; \quad \sqrt{\frac{l W}{6 b V}} = d.$$

In rectangular beams, &c., b and $d = \sqrt[3]{\frac{l W}{6 V}}$.

$$3. \quad \frac{4 b d^2 V}{l} = W; \quad \frac{4 b d^2 V}{W} = l; \quad \frac{l W}{4 d^2 V} = b; \quad \sqrt{\frac{l W}{4 b V}} = d.$$

In rectangular beams, &c., b and $d = \sqrt[3]{\frac{l W}{4 V}}$.

$$4. \quad \frac{l b d^2 V}{m n} = W; \quad \frac{m n W}{b d^2 V} = l; \quad \frac{m n W}{l d^2 V} = b; \quad \sqrt{\frac{m n W}{l b V}} = d.$$

In rectangular beams, &c., b and $d = \sqrt[3]{\frac{m n W}{l V}}$.

$$5. \quad \frac{3 l b d^2 V}{2 m n} = W; \quad \frac{2 m n W}{3 b d^2 V} = l; \quad \frac{2 m n W}{3 l d^2 V} = b; \quad \sqrt{\frac{2 m n W}{3 l b V}} = d.$$

In rectangular beams, &c., b and $d = \sqrt[3]{\frac{2 m n W}{3 l V}}$.

When the weight is uniformly distributed, the same formulæ will apply, w representing only half the required or given weight.

When the weight increases as the distance from the free end or from one of the supports, as the case may be, the same formulæ will apply, w representing $\frac{1}{2}$ the required or given weight.

(To be continued.)

DANCHELL'S PATENT WATER TEST APPARATUS.

By this little ingenious Apparatus for testing water, invented by Mr. F. H. Danchell, any sort of impurities contained in the water, can be detected immediately, and as all the tests are made dependent on the appearance of the water after the addition of one or another of the test fluids, it is brought within the reach of every one to ascertain, what kind of water they drink; without going to the expense of applying to a chemist to have it examined.

The apparatus consist of seven small bottles, containing the standard test fluids; they are arranged to detect:—1. Ammonia; 2. Decomposed organic matter; 3. Absence of lead; 4. Presence of lead; 5. Carbonate (bicarbonate) of lime; 6. Sulphate of lime and sulphuric acid; 7. Iron;

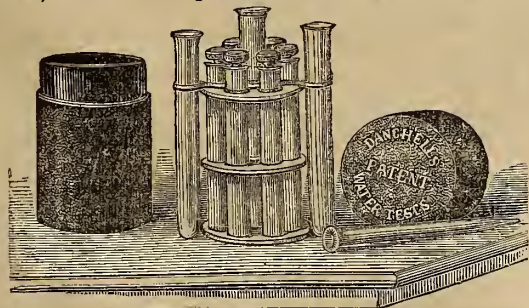

besides these there are provided two test tubes, so as to permit of a comparison for instance between filtered water, and the same water unfiltered, whereby their respective purities, and the use of the filter can be made evident at once. A dropping glass is also provided for convenience.

For further details we must refer our readers to a very clear and well written little work, by the same gentleman: *Water; its Impurities and Purification*;* which contains, besides the directions for the use of the apparatus, much valuable information for everyone, and especially for agriculturists, brewers, dyers, owners of steam boilers, manufacturers, and many others. Thus it is shown how, with the assistance of this

* Published by Henry Renshaw, 356, Strand.

little apparatus, and even without the slightest knowledge of chemistry, anyone can find out for himself what foreign matter is contained in the water tried. It points out to us what water we can safely drink, and what we ought to be careful of; it informs us of the means that can be employed in removing the impurities from the water, and what means are ineffective. In fact, it contains just that kind of information about water, which everyone, for his own sake, ought not to be without. The book accompanying the apparatus (but also sold separately), is throughout written in a very popular and intelligible manner

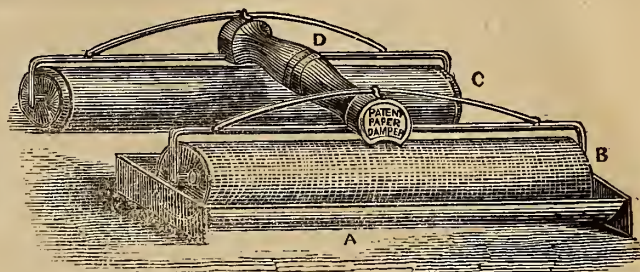

PATENT DAMPER FOR COPYING LETTERS.

In the illustration of this little machine, patented by Mr. F. Bertram, A is a brass trough wherein the wet felt roller B is placed when the machine is not in use. B is a hollow brass roller containing water, perforated all round with holes to admit the water to pass out and saturate the felt surrounding the brass roller. C is another roller surrounded with blotting paper. D is the handle of the machine.

This very useful machine, which we have ourselves tried and found exceedingly handy, dispenses entirely with the use of either brush, sponge, or damping sheet in copying. It will contain within itself sufficient water for many hundred copies, is always ready, and very effective.

FRICITIONAL GEARING.

INVENTED BY MR. J. ROBERTSON.

(Illustrated by Plate 200.)

Frictional screws are advantageously applicable to many useful purposes, and mechanical effects produced by them in greater variety than is obtainable by the common groove threaded screws. The properties they possess of indefinite variation of screw or pitch of thread producible in one screw, and of reversing the direction of the thread without changing the direction of the rotary motion of the nut or screw, chiefly produce these advantages; but there are also many properties possessed by these screws in point of application to purposes in the manufactures and arts, which differ so much in frictional from ordinary screws, that the application of frictional screws elicits many new arrangements and useful effects, different from anything attainable by other mechanical motions.

The primary principle of these will be understood by reference to the engravings, Figs. 1, 2, and 3, which represent their form and illustrate their action in its simplest condition. Fig. 1 is a side elevation, Fig. 2 a plan, and Fig. 3 an end elevation of a frictional screw and nut, consisting of a barrel or cylinder, A, and pulley B. The barrel, A, in its action, representing and forming the screw, and the pulley, B, representing and answering the same ends as are obtained by the common screw nut. The action is as follows:—Motion being given to the pulley, B, in the direction of the arrow shown on the belt, x , it communicates rotary motion to the barrel, A, and when the axis of the pulley, B, is placed in an angular position to the axis of the barrel, A, as shown in Fig. 2; the barrel also moves on end in the direction of the arrow, q , any point of the surface of the barrel describing a regular helix or screw. The proportion of motion on end to each revolution of the barrel or pitch of thread, is determined by the degree of angle which the axis of the pulley, B, is made to form with the vertical plane of the axis of the screw barrel, the position in which it is set, as seen in Fig. 1, producing the dotted helix, $t t$, shown on the barrel. On the handle, j , being turned round to the position shown at p , the direction of the rotary motion remaining the same, the axis of the pulley, B, is set at an angle to the axial line of the screw barrel, the opposite direction from that given to it when it was in the position at n , and the barrel moves in the direction of the arrow, m . When the handle, j , is turned into a central position, as seen at o , and the axial vertical plane of the centres of the pulley, B, and barrel, A, made to coincide, it simply gives rotary motion to the barrel, without motion on end in either direction. The several positions which the handle, j , can be placed, within a range of 180° of the circle, will produce any variation or regular pitch of thread in either direction, between rectilinear motion on end to simple rotary motion.

Fig. 11 is an end elevation, and Fig. 12 a plan of a planing machine, with a frictional screw motion applied for giving motion to, and reversing the action of the travelling table. Portion of the machine is broken off to shorten it, and part of the end of the slide bed, as also portion of the travelling table are broken off to show the arrangements of the screw motion.

In this example the screw barrel is the driver, and the nut pulleys and reversing gear affixed to the travelling table. The screw barrel and frictional nut being

disposed underneath the travelling table, much in the same way as the common screw where applied for this purpose.

This motion is peculiarly well suited for this and similar purposes, as when once a moderate speed is established for the screw barrel, it is easily practicable to give any variation of speed to the table, from an infinitely slow motion up to a motion several times greater than that obtained in mid-working position. As no rotary reversing motion is required, the noise and vibration usually attendant on the use of these is avoided, and as in common with all frictional means of transmitting motion, sudden stoppage cannot injure the screw; they can be reversed quickly although working at high speed.

Any required degree of "bite" or driving hold can also be given to these screws for such purposes, and if properly arranged, are less liable to cause loss of power by friction than the common screw.

Fig. 7 is a side elevation, and Fig. 8 a plan of an application of these screws to a hoist, in which three double pulleys compose the nut. The angle of the nut pulleys in this example are set permanently to one pitch of thread, and the cage or platform is lowered by reversing the rotary motion of the screw barrel; its action, therefore, very much resembling that of the common groove threaded screw. The barrel also forms a steady and convenient guide for the platform, and as it cannot run down suddenly, or injure by being sent too far up; it is a very safe description of hoist.

Fig. 9 is an elevation, and Fig. 10 a plan of a frictional nut and screw, in which the contact pressure is maintained on three sets of nut pulleys or rolls, similar to those described in Figs. 7 and 8.

Fig. 13 is a side elevation, Fig. 14 a plan, and Fig. 15 an end elevation of a set of rolls for straightening round bars, tubes, and similar articles in which a frictional screwing motion is employed, and is example of the use of the principle in positions to which common screws do not apply.

Fig. 16 is a plan of a pair of rolls, differently formed from those described, but for placing in the same angular position as those described in connection with Figs. 13, 14, and 15.

Fig. 4 is a side elevation; Fig. 5, an end elevation; and Fig. 6 a plan of a frictional screw in which a "speed ring" acts as the frictional nut. It affords very direct means of transmitting the screw motion to the barrel, and bears a closer resemblance to the common grooved nut than any of these frictional nuts described. It has, however, besides the properties of reversing and varying the thread, the property of transmitting rotary motion, which is not possessed by the ordinary screw nut, nor by the frictional nut described in connection with Figs. 8 and 9. From its simplicity and quick action, this motion is peculiarly well suited for light boring, and boring substances like wood, as by it the drill can be made to advance to, and recede from, the object to be bored rapidly, and at the same affords a yielding pressure to the drill, which can be intensified or reduced at pleasure by the same handle that reverses and regulates the screwing action.

Want of space prevents a more extended description of the uses and applications of the friction gearing being given for the present; but the very numerous and useful applications of the invention in its various forms demand a further notice, for which space will shortly be found.

4. A second copper cube is also filled with boiling water, and its rays fall upon the second face of the thermo-electric pile. The two cubes thus radiating upon the opposite faces of the pile tend, of course, to neutralize each other.

Between the last-named cube and the adjacent face of the pile is introduced a screen, being attached to an apparatus of Ruhmkorff's, capable of extremely fine motion; by the partial advance or withdrawal of this screen the two sources of heat can be caused to neutralize each other perfectly.

The tube and the chamber, being both exhausted, the needle of the galvanometer is brought exactly to zero by means of the screen. The gas or vapour to be experimented with, is now admitted into the tube, and if it possess any sensible absorbing power, it will destroy the previously existing equilibrium. The consequent deflection of the galvanometer, properly reduced, is the measure of the absorption. In this way the action of eight gases and thirteen vapours have been examined, and also the action of atmospheric air.

Oxygen, hydrogen, nitrogen, and atmospheric air, respectively absorb about 0.3 per cent. of the calorific rays; this is the feeblest action which has been observed.

The most energetic action is that of olefiant gas, which at the tension of one atmosphere absorbs 81 per cent. of the calorific rays. Between those extremes stand carbonic oxide, carbonic acid, nitrous oxide, and sulphuretted hydrogen.

Below a certain tension, which varies for different gases, the amount of heat absorbed is exactly proportional to the density of the gas. Above this tension, the rays on which the principal absorptive energy is exerted become gradually exhausted, so that every augmentation of density produces a diminished effect.

In the case of olefiant gas, for example, where a unit measure $\frac{1}{1000}$ th of a cubic inch in capacity was made use of; for a series of fifteen such measures, the absorption was exactly proportional to the quantity of gas; subsequently, the ratios of the successive absorptions approached gradually to equality. The absorption produced by a single measure of olefiant gas of the above volume, moved the index of the galvanometer through an angle of 2.2 degrees; the tension of the gas being only $\frac{1}{11000}$ th of an atmosphere.

In the case of vapours, the most energetic is that of sulphuric ether; the least energetic is that of bisulphide of carbon. Comparing small volumes and equal tensions, the absorptive energy of sulphuric ether vapour is ten times that of olefiant gas, and ten thousand times that of oxygen, hydrogen, nitrogen, or atmospheric air.

On a fair November day the aqueous vapour in the atmosphere produced fifteen times the absorption of the true air itself. It is on rays emanating from a source of comparatively low temperature that this great absorptive energy is exerted; hence the aqueous vapour of the atmosphere must act powerfully in intercepting terrestrial radiation; its changes in quantity would produce corresponding changes of climate; subsequent researches must decide whether this *vera causa* is competent to account for the climatal changes which geologic researches reveal.

Oxygen obtained from the electrolysis of water exerted four times the absorptive energy of the same substance when caused to pass through iodide of potassium; the greater action being due to the presence of ozone.

The radiative power of gases was examined by causing them to pass over a heated sphere of metal, and ascend in a column in front of the thermo-electric pile; various precautions were taken to secure accuracy in the results. It was found that the order of radiation was exactly that of absorption; that any atom or molecule which is capable of accepting motion from agitated ether, is capable in precisely the same degree of imparting motion to still ether. Films of gas on surfaces of polished metal were found to act like coats of varnish.

The speaker also investigates the physical connection of radiation, absorption, and conduction. In the foregoing experiments *free* atoms and molecules were dealt with, and upon them individually was fixed the responsibility of the effects observed. These effects are thus detached from considerations of cohesion and aggregation, which suggests themselves in the case of liquids and solids.

The reciprocity of absorption and radiation is a simple mechanical consequence of the theory of an ether.

But why is one molecule competent to stop or generate a calorific flux so much more powerfully than another? The experiments prompt the following reply:—The elementary gases which have been examined all exhibit extremely feeble powers both of absorption and radiation, in comparison with the compound ones. In the former case we have oscillating atoms, in the latter oscillating systems of atoms. Uniting the atomic theory with the conception of an ether, it follows that the *compound* molecule which furnishes *points d'appui* to the ether must be capable of accepting and generating motion in a far greater degree than the single atom, which we may figure to our minds as an oscillating sphere. Thus oxygen and hydrogen, which, taken separately, or united mechanically, produce a scarcely sensible effect, when united chemically to form oscillating systems as in aqueous vapour, produce a powerful effect. Thus,

ROYAL INSTITUTION OF GREAT BRITAIN.

ON THE ACTION OF GASES AND VAPOURS ON RADIANT HEAT.

BY JOHN TYNDALL, Esq., F.R.S.

The discourse commenced by a reference to the researches of Leslie Forbes, and Knoblauch; but more especially to the admirable investigations of Melloni on Radiant Heat. These eminent men had left the gaseous form of matter practically untouched, and to extend our knowledge into this wide region was the object of the investigation on which the present discourse was founded.

The apparatus made use of, and which was applied in the experiments of the evening, consists of the following parts:—

1. A copper cubic-shaped vessel, containing water, kept constantly boiling, and one of whose faces, coated with lamp-black, forms the source of radiant heat.

2. A brass tube, 2.4 inches in diameter, which is divided into two portions.

The one portion of the tube is intended to receive the gases and vapours; it is stopped air-tight at its two ends by plates of rock-salt, and is attached to a good air-pump, by which it can be exhausted at pleasure. The length is 4 feet.

The other portion is an air-tight chamber between the tube and the cubic vessel. It is kept constantly exhausted, and the calorific rays therefore pass from the radiating plate through a vacuum into the tube, thus retaining the quality which belonged to them at the moment of emission.

To prevent the transmission of heat by conduction from the cubic vessel the tube, the chamber is partly embraced by an annular space, in which cold water continually circulates.

3. A thermo-electric pile furnished with two conical reflectors, and connected with an excellent galvanometer. One of the faces of the pile receives the rays which have passed through the tube.

also, nitrogen and hydrogen, which, when separate or mixed, produce but little action, when combined to form ammonia, produce a great action. So also nitrogen and oxygen, which when mixed as in air, are feeble absorbers and radiators, when united to oscillating systems, as in nitrous oxide, are very powerful in both capacities. Comparing small volumes and equal tensions, the action of nitrous oxide is 250 times that of air; a fact which perhaps furnishes a stronger presumption than any previously existing, that air is a *mixture*, and not a compound. Carbonic oxide is about 100 times as powerful as its constituent oxygen; carbonic acid is 150 times as powerful, while olefiant gas, as already remarked, is 1000 times as powerful as its constituent hydrogen. In the case of the hydrocarbon vapours, when the atomic groups attain a higher degree of complexity, the action is even greater than that of olefiant gas.

The speaker also refers to the experiments and observations of Niepce, Angstrom, and Foucault; but more especially to the admirable researches of Kirchhoff and Bunsen, as regards the influence of the period of oscillation on the rate of absorption. He points out how the grouping of atoms to systems in a resisting medium must tend to make their periods of oscillation longer, and thus bring them into isochronism with the periods of the obscure radiations made use of in the experiments.

With regard to conduction, the speaker would illustrate his views by reference to two substances—rock-salt and alum. He was once surprised to observe the great length of time required by a heated mass of rock-salt to cool; but this was explained by the experiments of Mr. Balfour Stewart, who shows that rock-salt is an exceedingly feeble radiator. The meaning of this is that the molecules of the salt glide through the ether with small loss of *vis viva*. But the ease of motion which they are thus proved to enjoy must facilitate their mutual collision. The motion of the molecules, instead of being expended on the ether between them, and then communicated in part to the ether external to the mass, is transferred freely from particle to particle; or in other words, is freely conducted. This *à priori* conclusion is completely verified by the author's experiments, which prove rock salt to be an excellent conductor. It is quite the reverse with alum. Mr. Balfour Stewart's experiments prove it to be an excellent radiator, and the author's experiments show it to be an extremely bad conductor. Thus it imparts with ease its motion to the ether, and for this very reason finds difficulty in transferring it from particle to particle; its molecules are in fact so constituted that when one of them approaches its neighbour, a swell is produced in the intervening ether; this motion is immediately communicated to the ether outside, and is thus lost for the purposes of conduction. The lateral waste prevents the motion from penetrating the alum to any great extent, and hence it is pronounced a bad conductor. These considerations seem to reduce the phenomena of absorption, radiation, and conduction to the simplest mechanical principles.

ON BUNSEN AND KIRCHHOFF'S SPECTRUM OBSERVATIONS.

By HENRY ENFIELD ROSCOE, Esq., Professor of Chemistry in Owen's College, Manchester.

The speaker commenced by stating that the researches of Bunsen and Kirchhoff, which he had the honour of bringing before his audience, marked a new era in the science of Analytical Chemistry; that by means of these discoveries the composition of terrestrial matter becomes revealed to us with a degree of accuracy and delicacy as yet unheard of, so that chemical elements supposed to be of rare and singular occurrence, are shown to be most commonly and widely distributed, and on the first practical application of this new method of analysis two new and hitherto undetected alkaline metals have been discovered.

The importance of these researches become still more strikingly apparent, when we hear that the conclusions derived from them outstep the bounds of our planet, enabling us to determine with all the certainty of definite experiment the actual presence of a number of elementary bodies in the sun.

The colours which certain bodies impart to flame, have long been used by chemists as a test for the presence of such bodies. Thus soda brought into a colourless flame produces a bright yellow light, and substances containing soda in any form give this yellow colour. Potash gives a violet flame, lithia and strontia impart to flame a crimson colour, whilst salts of barium tinge it green. These colours are produced by the incandescence or luminosity of the heated vapour of the various bodies placed in the flame. It is only because these substances are volatile, or become gases at the temperature of the flame, that we observe the peculiar colour. If any substance, such as platinum, which is not volatile at the temperature of the flame, be placed in it, no colouration is observed. The higher the temperature of the flame into which the same substance is placed, the greater will be the luminosity; and the more volatile the salt of the same metal, the more intense is the light produced.

Heated to the point of incandescence in any other manner, the vapours of these metals and their salts give out the same coloured light. Thus, if we burn gun-cotton, or gun-paper, steeped in solutions of these various salts, we get the characteristic colours. The well-known coloured fires owe their peculiar effects to the ignition of the vapour of some particular substance. Thus, in red fire we have strontium, in green fire we have barium, salts present in the state of luminous vapour.

These facts have long been known and applied, but it was reserved for Bunsen and Kirchhoff to place these beautiful phenomena in their true position, to apply to them the modern methods of exact research; and thus to open out a new and rich field for most important investigations. This they accomplished in a most simple and beautiful manner, by examining these coloured flames, not by the naked eye, but by means of a prism or an apparatus for separating, decomposing, or splitting up the light produced by the incandescent vapour into its different constituent parts.

If we pass white sun-light through a prism, we get the well-known solar spectrum discovered by Newton. The red, or least refrangible rays appear at one end, and we pass through all gradations of colour—noticing on our way certain dark lines or spaces, showing the absence in solar light of some particular rays, lines with which we shall have much to do—until we arrive at the violet, or most refrangible end of the spectrum. If instead of using white sun-light, we pass the rays from the yellow soda flame through the prism, we get the soda spectrum; and we find that instead of a continuous spectrum, all we see is one bright yellow line, showing that every kind of light except that bright yellow ray, is absent in the soda flame; or that the soda flame gives out only one *kind* of light.

And as each metal, sodium, potassium, lithium, calcium, strontium, barium, &c., communicates a distinct tint to flame, so each gives a distinct and characteristic spectrum, consisting of certain bright coloured lines, or bands of light of the most peculiar form and tint.

The actual spectra of these metals can be beautifully seen in the simple apparatus designed by Bunsen and Kirchhoff.

In each spectrum of these metals, the form, number, position, colour, and tone of the bright lines remain perfectly constant and unvarying, so that from the presence or absence of one of these lines, we may with absolute certainty draw conclusions respecting the presence or absence of the particular metal, as we know of no two substances which produce the same bright lines. None of the bright lines produced by any one metal interfere in the least with those of any other, and in a mixture of all these metallic salts together, each ingredient can thus be easily detected.

As an example of the exactitude with which a very small quantity of a most complicated mixture can thus be analysed, the speaker quoted Bunsen's words. "I took," says Bunsen, "a mixture of chloride of sodium, chloride of potassium, chloride of lithium, chloride of calcium, chloride of strontium, chloride of barium, containing at most $\frac{1}{10000}$ part of a grain of each substance. This mixture I put into the flame, and observed the result. First, the intense yellow sodium line appeared, on a background of a pale continuous spectrum; as this began to be less distinct, the pale potassium lines were seen, and then the red lithium line came out, whilst the barium lines appeared in all their vividness. The sodium, lithium, potassium, and barium salts were now almost all volatilized, and after a few moments the strontium and calcium lines came out, as from a dissolving view, gradually attaining their characteristic brightness and form."

We can thus detect the most minute traces of any one of these bodies, if mixed with the largest quantities of any other substance. The delicacy and accuracy of these reactions is without parallel, as is seen from the following statements:—

1. *Soda* $\frac{1}{1000000}$ part of a milligramme, or $\frac{1}{100000000}$ part of a grain of soda can be detected. Soda is always present in the air. All bodies exposed to air show the yellow sodium line. If a book be dusted near the flame the soda light can be seen.

2. *Lithia* $\frac{1}{1000000}$ part of a milligramme, or $\frac{1}{100000000}$ part of a grain of lithia can easily be detected. Lithium was only known to occur in four minerals. It is now found by spectrum analysis to be one of the most widely distributed elements. It exists in almost all rocks; it has been found in three cubic inches of sea, river, and Thames water; in the ashes of tobacco, and most plants; in milk, human blood, and muscular tissue.

3. *Strontia* $\frac{1}{1000000}$ of a milligramme, or $\frac{1}{100000000}$ parts of a grain of strontia can easily be detected.

4. *Lime* $\frac{1}{1000000}$ of a milligramme, or $\frac{1}{100000000}$ of a grain may be easily detected.

In examining the spectra of the alkalies obtained from certain mineral waters, Bunsen observed the occurrence of two bright blue lines which he had not seen before, when he examined alkalies from other sources. Hence he concluded that these bright lines must be produced by a new, hitherto undetected, alkaline metal. Subsequent search proved the validity of the supposition. The new metal was found and isolated. The analogy between this discovery and a celebrated one in another branch of physical science,

will be at once understood. As Adams and Leverrier discovered Neptune so Bunsen discovered "*Cæsium*" by the perturbations produced in the spectra of the other alkaline metals.

This is, however, not all. A few days ago the speaker received a letter from Bunsen, which contains the following most interesting information:—"The substance which I sent you as impure tartrate of *Cæsium* contains a *second* new alkaline metal. I am at present engaged in preparing its compounds. I hope soon to be able to give you more detailed information concerning it. The spectrum of the new metal consists of two splendid red lines situated beyond the red line *K a* in the ultra red portion of the solar spectrum. Hence I propose to call the new metal '*Rubidium*.'"

That this same method of investigation can be extended to all the metallic elements is more than probable, for Kirchhoff writes—"I have assured myself that even the metals of the rarest earths, as yttrium, erbium, and terbium, can be most quickly and certainly determined by help of the spectrum analytical method."

Experiments are being carried on with the view of making this mode of examination practically applicable to all metals.

To turn, now, to the second, and, if possible, to the more interesting part of the subject, namely, the conclusions drawn from these observations respecting the composition of the sun's atmosphere. The solar spectrum invariably contains a large number of dark lines, or spaces, or shadows. These have been called Fraunhofer's Lines, from the name of their discoverer. They show us that in the sun's light certain kind of rays are wanting; and as these lines are always present, exactly in the same position, we see that certain kinds of rays are always absent in solar light. There are many thousands of these lines in the whole length of the spectrum. Only a few have been, as yet, mapped and named.

What is the cause of these constant dark lines? And we must remember that it is in sunlight alone that these particular lines occur; in the light of the fixed stars, as well as in artificial lights, other lines are found. It is the discovery of this cause by Kirchhoff which gives the subject such peculiar interest, as it enables us to draw conclusions respecting the composition of the sun's atmosphere. The points of the case are put as concisely as possible under the following heads:—

1. The solar spectrum invariably contains certain fixed *dark* lines, called Fraunhofer's Lines.

2. The spectra produced by the luminous vapour of all metals contain certain fixed *bright* lines, invariable, and distinct for each metal.

3. All and each of the bright lines thus produced by certain metals—viz., sodium, potassium, magnesium, and iron—are found to coincide exactly with certain of the dark lines of the solar spectrum.

4. Hence there must be some connection between the bright lines of the metal and the dark solar lines.

5. The connection is as follows:—Each of the dark fixed lines in the solar spectrum is caused by the presence in the sun's atmosphere of the luminous vapour of that metal which gives the coincident bright line.

By taking a special case we may more easily understand the matter. Let us examine the question why it is to be concluded that *Sodium* occurs in the sun's atmosphere? In the following sentences the reasoning on this subject is rendered clear:—

1. The light emitted by luminous sodium vapour is homogeneous. The sodium spectrum consists of one double bright yellow line.

2. This bright double sodium line is exactly coincident with Fraunhofer's dark double line *D*.

3. The spectrum of a Drummond's Light (like that of all incandescent solids) is continuous. It contains no dark lines or spaces.

4. If between the prism and the Drummond's Light a soda flame be placed, a dark double line identical with Fraunhofer's dark double line *D* is produced.

5. If instead of using Drummond's Light we pass sunlight through the soda flame, we see that the line *D* becomes much more distinct than when sunlight alone is employed.

6. The sodium flame has, therefore, the power of absorbing the same kind of rays as it emits. It is opaque for the yellow "*D*" rays.

7. Hence we conclude that luminous sodium vapour in the sun's atmosphere causes Fraunhofer's dark double line *D*. The light given off from the sun's solid body producing a continuous spectrum.

8. In a similar manner the presence in the solar atmosphere of potassium, iron, magnesium, nickel, and chromium has been proved.

Kirchhoff's own words may perhaps render this matter still more plain. "The sun," says Kirchhoff, "consists of a glowing gaseous atmosphere, surrounding a solid nucleus which possesses a still higher temperature. If we could see the spectrum of the solar atmosphere without that of the solid nucleus, we should notice in it the bright lines which are characteristic of the metal it contains. The more intense luminosity of the internal nucleus does not, however, permit the spectrum of the solar atmosphere to become apparent; it is *reversed* according to my newly-discovered proposition; so that, instead of the *bright* lines which the luminous atmosphere by itself would have shown, *dark* ones

appear. We do not see the spectrum of the solar atmosphere itself, but a negative image of it. This case, however, with an equal degree of certainty serves to detect the metals present in the sun's atmosphere. All that we require for this purpose is a very accurate knowledge of the solar spectrum, and of the spectra of the individual metals."

Kirchhoff is at present engaged in continuing these observations; and, although only eighteen months have elapsed since the first discovery was made, he has already mapped more than seventy lines in the solar spectrum, between *D* and *E*, which are produced by iron. He has shown that the well-known group in the green, known as *b*, is caused by magnesium, whilst other coincident lines prove the presence of nickel, chromium, potassium, and sodium in the solar atmosphere.

The speaker regretted that he was unable to show even a drawing of these coincident lines, as no representation of them has yet been completed.

The lines produced by many metals possessing very distinctly marked spectra are seen to coincide with *none* of the dark solar lines; and hence the conclusion is drawn, that these metals—for instance, silver, copper, zinc, aluminium, cobalt, lead, and antimony—do not occur at all, or at any rate occur only in very small quantities in the sun's atmosphere.

The speaker said that he should not soon forget the impression produced on his mind when visiting his friends in Heidelberg last autumn, by seeing the splendid spectacle of the coincidence of the bright lines of the iron spectrum with the dark solar lines. In the lower half of the field of the telescope were at least seventy brilliant iron lines of various colours, and of all degrees of intensity and of breadth; whilst in the upper half of the field, the solar spectrum, cut up, as it were, by hundreds of dark lines, exhibited its steady light. Situated *exactly* above each of the seventy bright iron lines was a dark solar line. These lines did not only coincide with a degree of sharpness and precision perfectly marvellous, but the intensity and breadth of each bright line was so accurately preserved in its dark representative, that the truth of the assertion that iron was contained in the sun, flashed upon the mind at once.

The speaker concluded by remarking that these researches are still in their earliest infancy; that the dawn of a new stellar and terrestrial chemistry has been announced, thus opening out for investigation a bright prospect of vast fields of unexplored truth.

ON SOME PHENOMENA ATTENDING COMBUSTION IN RAREFIED AIR.

BY E. FRANKLAND, F.R.S.

The investigation forming the subject of this discourse had its origin in some experiments which the speaker made upon the summit of Mont Blanc, in the autumn of 1859, for the purpose of ascertaining the effect of atmospheric pressure upon the amount of combustible matter consumed by a common candle. He found, as the average of five experiments, that a stearin candle diminished in weight 9.4 grammes, when burnt for an hour at Chamonix; whilst it consumed 9.2 grammes when ignited for the same length of time on the summit of Mont Blanc. This close approximation in the quantity of combustible matter consumed under such widely different atmospheric pressures, goes far to prove that the rate of combustion is entirely independent of the density of the atmosphere. This result was subsequently confirmed by a repetition of the experiments in air, artificially rarefied, until it supported a column of only 9 in. of mercury.

In burning the candles upon the top of the mountain, it was noticed, in the subdued light of the tent in which the operation was performed, that their luminosity was much less than usual. The lower and blue portion of the flame, which, under ordinary circumstances, scarcely rises to within a quarter of an inch of the apex of the wick, now extended to the height of one-eighth of an inch above the cotton, thus greatly reducing the size of the luminous portion of the flame; and, on subsequently repeating the experiments in artificially rarefied atmospheres, and measuring the amount of light emitted in each case, it was found that as the rarefaction proceeded, the blue, or non-luminous portion of the flame gradually extended upwards until it finally expelled, as it were, the yellow or luminous part even from the apex of the flame. During the progress of the rarefaction, the flame became somewhat enlarged, assumed an ellipsoidal shape, and ultimately became almost globular, whilst a large external shell of bluish pink flame gradually came into view, as the last portion of yellow light was disappearing from the apex of the flame, which had alone been previously visible. It is scarcely necessary to add, that during these changes in the flame, the light underwent a rapid diminution; the rate of its decrease, however, was subject to considerable irregularities from the heating of the apparatus surrounding the candle, and the consequent guttering and unequal combustion of the latter. For the accurate measurement of the diminution of light, therefore, recourse was had to coal gas, which, although also liable to certain disturbing influences, yet yielded results, during an extensive series of experiments, exhibiting sufficient uniformity to render them worthy of confidence.

By passing the gas through a "governor," uniformity of pressure in the delivery tubes could be secured; and by other appropriate arrangements, a uniform amount of gas, viz., 0.65 cubic feet per hour, was made to burn in each

FIRST SERIES.

Pressure of Air in inches of Mercury.	Illuminating Power of Experimental Flame.	
	Observed.	Calculated.
29.9	100	100
24.9	75.0	74.5
19.9	52.9	49.0
14.6	20.2	22.0
9.6	5.4	3.5
6.6	.9	1.88

light given by the experimental flame when burning under the full atmospheric pressure—is taken at 100.

SECOND SERIES.

Pressure of Air in inches of Mercury.	Illuminating Power of Experimental Flame.	
	Observed.	Calculated.
30.2	100	100
28.2	91.4	89.8
26.2	80.6	79.6
24.2	73.0	69.4
22.2	61.4	59.2
20.2	47.8	49.0
18.2	37.4	38.8
16.2	29.4	28.6
14.2	19.8	18.4
12.2	12.5	8.2
10.2	3.6	2.0

a less rapid ratio. One of the columns headed "Calculated," in the above tables, exhibits the illuminating power calculated from the constant just given, and it will be seen, that these calculated numbers nearly coincide in most cases with the observed amount of light.

THIRD SERIES.

Pressure of Air in inches of Mercury.	Illuminating Power of Experimental Flame.	
	Observed.	Calculated.
30.2	100	100
29.2	95.0	94.9
28.2	89.7	89.8
27.2	84.4	84.7

temperature to which these carbon particles were heated. Now, the temperature of a flame might be affected by imperfect combustion in rarefied air; but it had been proved by the analysis of the products that combustion was equally complete in the above experiments under all pressures; in fact, it was found that complete combustion could be far more easily secured in rarefied air, than in air at the ordinary atmospheric pressure. Other experiments also showed that the temperature of a flame was not materially affected by the pressure of the air in which it was burning; consequently, it was inferred that the diminution of luminosity in rarefied atmospheres was not due either to imperfect combustion, or to reduction of temperature.

The diminution of light must therefore arise from the decrease of the amount of solid carbon separated within the flame; and this the speaker believed to be due to the admission of oxygen in larger quantities into the interior of the flame when the atmosphere was rarefied. It was shown by experiment that the admission of a comparatively small amount of air, and consequently of oxygen, into the interior of a gas flame, immediately reduced the illuminating power of the latter to a very marked extent; the carbon particles, instead of being separated as such in the interior of the flame, being at once oxidized to carbonic oxide. This increased access of oxygen to the interior of a flame burning in rarefied air was believed to be due to the greater mobility of the particles of expanded gases, which enabled the gases of the flame and the circumambient air to commingle more rapidly than at ordinary atmospheric pressure.

The cause of the less rapid decrease of the light of flames burning in atmospheres below 14in. of mercurial pressure was due to the comparative prominence assumed by the light of the incandescent gaseous matters of the flame at such high stages of rarefaction, this gaseous illumination being affected by pressure to a much less extent than that afforded by incandescent carbon particles.

experiment within the atmosphere of varying density. This experimental flame was placed at one extremity of a Bunsen's photometer; whilst, as a standard for comparison, a similar jet of gas, surrounded by a glass shade, and burning freely in the air with a uniform consumption, was fixed at the opposite end of the photometer. In the case of the experimental flame, the products of combustion were completely removed, and a steady supply of fresh air constantly supplied.

The following table contains a summary of the results of these determinations, the illuminating power given under each pressure being the average of twenty closely accordant observations. In each series the maximum illuminating effect—that is, the

An inspection of these results indicates that even the natural oscillations of atmospheric pressure cause a considerable variation in the amount of light emitted by gas flames. In order to determine these variations, the following special series of experiments was made, the pressures being very accurately ascertained by means of a water gauge.

It is thus evident that the combustion of an amount of gas which would give a light equal to 100 candles, when the barometer stands at 31in., would afford a light equal to only 84.4 candles, if the barometer fell to 28in.

The results of these three series of observations taken together show, that beginning at atmospheric pressure, and with 100 units of light, a decrease of almost exactly 5.1 units of light is the result of each diminution of mercurial pressure to the extent of 1in., until the barometer stands at 14in., below which the diminution of light takes place in

In his celebrated researches on flame, Davy had not overlooked the diminution of light by decrease of pressure, but he had not determined the diminution quantitatively nor indicated its cause.

The speaker stated, in conclusion, that he had only yet imperfectly extended his inquiry to pressures higher than that of the atmosphere; but, so far as these experiments went, they appeared to indicate that the law which had been elicited for lower pressures, also held good for pressures above that of the atmosphere.

INSTITUTION OF CIVIL ENGINEERS.

THE NATIONAL DEFENCES.

By MR. G. P. BIDDER, JUN., B.A.

GEORGE P. BIDDER, Esq., President, in the Chair.

The Author commenced by stating that it was not his intention to offer any opinions or to propose any schemes of his own, or to dogmatise on those of others; but merely to bring together and arrange the several questions requiring consideration, so as to facilitate their discussion. The subject was one of intricacy, from the changes which modern improvements were necessitating in the art of warfare and in the means of defence, as well as from the apparent want of any clearly defined principles of construction. Its importance was undeniable, and might be judged of from the fact, that during the last eight years £29,000,000 had been expended in the maintenance and reconstruction alone of the navy,—about £8,000,000 representing the value of new ships,—besides which £12,000,000 had been recently voted for the construction of military coast defences.

The first question which arose was, whether reliance should be placed on the Navy alone, and the energies of the country be devoted to the task of rendering it of such a character and strength as would ensure to Great Britain the mastery of the seas, especially of those surrounding these islands; or, whether a part of the resources of the nation should be employed in providing a supplementary protection to the shores, by means of land fortifications. The insular position of Great Britain rendered it peculiarly liable to invasion, at a great number of points, which could not all be protected by land fortifications. But an enemy making such an attempt must have ample means of transport, as well as convenient ports of embarkation. Now, on the French coast there were but three ports fit for such a purpose,—Cherbourg, Brest, and L'Orient; and there were not any others between the Cattegat and the Coast of Portugal, excepting Flushing. Again, if the Russian fleet desired to combine with that of France, it would have to force a passage through the Straits of Dover, or sail round the whole of the Island. The substitution of steam ships for sailing vessels, while it increased the rapidity and certainty with which troops could be transported, at the same time augmented the efficiency of a marine force in protecting a given extent of coast, and gave greater facilities for watching, or blockading an enemy's ports, as well as for conveying intelligence. There was scarcely a point round the extensive seaboard of this kingdom without an adjacent port, or harbour, capable of being rendered fit, at a moderate cost, for the reception of vessels of war, for replenishing stores and ammunition. Added to which, the railway system would enable an unlimited supply of coal, of ammunition, and of warlike stores to be conveyed to these harbours, at the shortest notice; and would place the entire mineral and mechanical resources of the country at the disposal of the Government. These facts were important, as in future warfare a base of operations must be provided for a fleet, as formerly for an army, and the naval base must rest on an ample supply of coal.

As the main strength of Great Britain lay in her exhaustless mineral resources and numberless harbours, so the chief strength of the power from which alone invasion might be feared lay in its enormous army. A good steam fleet interposed a barrier which must be destroyed, before an invading expedition could be despatched with a chance of success. Such an enterprise as an invasion would seem hopeless, in the face of a quick, vigilant, and powerful fleet. But, if that fleet were worsted, the enemy would have all the advantage of his superior military organisation. Such a contingency should be provided for by improvements in the coast lines of railway; and, if it occurred, the labouring power of the country should be employed in throwing up earthworks, in destroying roads and bridges, and in impeding the advance of an invading army,—a service in which the members of the Institution might be made eminently useful.

It was contended, that any attempt to protect the shores generally, by the erection of land fortifications, must be hopeless, on the ground of expense alone. The question, therefore, reduced itself to the advisability of fortifying the dockyards and arsenals, and possibly two or three other places palpably open to invasion. This could only be effected at great cost, and the forts, when erected, would require a large number of troops to man them. If the same amount of money were employed in the construction of additional ships of war, this end might be answered quite as effectually; and an attack on the arsenals could scarcely be contemplated so long as the Channel fleet remained intact.

Assuming, then, that it was considered essential to render the Channel fleet as strong and as effective as possible, it was submitted, having regard to the modern improvements in gunnery, and the application of steam power to propulsion, that vessels of war should be adapted to utilise and develop, to the greatest extent, the peculiar resources of this country, iron and coal. That they should also be adapted to economise the actual supply of effective seamer. That they should be designed to attain the highest speed, consistent with other

qualities, by giving them finer lines and greater length, such as it was hopeless to attempt with the heavy, bluff bows at present in favour. As to the material which should be used in the future navy, it had been proved that the present vessels were inadequate to support the additional weight imposed on them; and it was well known that there was an increasing scarcity of wood suitable for ship-building purposes. On the other hand, there was at home an inexhaustible supply of iron, and the skilled labour for producing iron ships. The principal objections to the use of iron were then noticed; and it was remarked that the destructive effects of both shot and shell were now of much greater importance than the secondary effects produced by splinters. The advantages in the use of iron were the great strength attainable, the comparatively little repair and renovation required, and the freedom from danger, or loss by fire.

The next point was the much-vexed question of the fortification of ships of war, by means of iron plates. It had been ascertained that a thickness of iron of at least 5 inches was required to resist completely the heavier description of shot. It was clear that such a defensive armour would involve an immense addition to the weight of a ship, and must greatly impair her efficiency in other respects. Allusion was then made to the two notable examples of this system, the French vessel *La Gloire*, and the English ship the *Warrior*, the former of which was admitted to be a successful and formidable vessel, and the latter, although much larger, was but partially fortified, having her extremities unprotected. This, it had been asserted, was to render her more seaworthy; but if a necessity, which was more than doubtful, it was a great imperfection in the system. It was clear that if the *Warrior* had been constructed of the same proportions, with plates throughout of the same thickness, she would have been a faster ship and more seaworthy than *La Gloire* on account of her greater size. It was also suggested whether the removal of the spar deck would not so lighten the *Warrior*, as to admit of the extremities being plated uniformly with the sides, without in any way impairing its efficiency. The guns would then be worked entirely from the spar deck, free from the obstruction of smoke. The bulwarks might be made sufficiently high and staunch to afford complete protection to the men. In such a ship, it was contended, the spars and rigging should be of a subordinate description. But on this subject of the fortification of ships, it was still a matter for inquiry whether the greatest general efficiency would not be obtained by adopting the system of protective armour on a more moderate scale.

Another point bearing on this question was, whether, owing to the greater range and accuracy of ordnance, naval engagements would not necessarily be fought at longer distances than formerly. As at long ranges the height of a target was more important than its breadth, this seemed to show the propriety of reducing ships to single decks, making them as low in the water as possible.

If these considerations were correct, it was submitted that they indicated as the proper description of vessels to be employed for Channel service, iron vessels built of great length, having fine lines, and considerable power to insure speed, and carrying an armament of very heavy guns on the spar deck alone. That they should be as low in the water as was consistent with safety, and be protected by plates of moderate thickness throughout their whole length; and that they should be fitted with spars and rigging of the lightest description.

As to "Steam Rams," it could hardly be doubted that, if properly constructed, and of sufficient size, power, and speed, their effect among a hostile fleet, especially a fleet of transports, would be terrific. Any attempt, however, to combine the qualities of a "Ram" with those of a fighting ship would only impair its efficiency. The expense attending the construction of these "Rams" would be very great, and the service would be very dangerous; but still it might be advantageous to construct these "Rams" if by their means three or four of the enemy's ships could be destroyed before the "Ram" itself.

Attention was next directed to the best mode of dealing with the present navy, and of converting the old men of war into efficient ships. The usual plan was to lengthen them, and to put in powerful engines, and an armament of heavy guns of the same number as before; but it was suggested whether it would not be a wiser course to cut them down, so as to have all the guns on one—the spar—deck, and to dispense with the heavy spars and rigging. This would reduce the weight sufficiently to compensate for the addition of the engines, and perhaps to admit of the fortification of the sides; while, by bringing the vessel higher out of the water, it would give a finer line of floatation.

It was noticed that, the subject of the Paper being "The National Defences," the observations on ships had been exclusively confined to those intended for service in the home seas; and were therefore not necessarily applicable to the case of vessels required for foreign stations.

LAUNCH OF THE SCOTIA.

On the 25th of June, 1861, the steamship *Scotia*, the second iron paddle-wheel liner built for the British and North American Royal Mail Steam Packet Company, was launched from the building yard of Messrs. Robert Napier and Sons, at Govan. The *Scotia* is intended to be a sister ship to the *Persia*, a vessel belonging to the same owners, and built by the same architects.

The preliminary arrangements were the extreme of simplicity, but also of effectiveness. After the launch of the *Black Prince* from the same yard in February last, little anxiety as to the result was felt among the numerous visitors who had assembled to witness the launch of the *Scotia*. There was no hydraulic ram applied to the bow of the vessel, as there was to that of the war frigate, the success of the launch being trusted to the gravity of the vessel. There were however, attached to her bow two chain cables, which stretched across the river, and were fastened to anchors weighing five tons each, firmly fixed into the ground on the north side. The chain cables were of 2½ in. diameter, and were each capable of resisting a strain of 120 tons. There was

no checking gear on the south side of the river. The inclined plane or sliding plank, along which the vessel was to glide into the water, was constructed in the usual manner, as were also the framing, the bilgeblocks, and dogshore.

Excepting the *Great Eastern*, the *Scotia* is the largest mercantile steamship afloat in the world, far exceeding in length, strength, tonnage, and steam power, the other vessels of the line, and exceeding, by 450 tons the tonnage of the *Persia*, and by 1900 tons the internal capacity of any other of the present splendid Cunard liners. Her chief proportions may be summed up as follows:—

Length of keel and fore-rake.....	360 feet
Length over all	400 "
Breadth moulded	47 "
Depth	32ft. 6 in.
Tonnage, Builder's measurement	4050 tons

Stupefied as the *Scotia* is, the lines of beauty have been so well worked out in the preparation of her model, that her appearance is singularly graceful and lightsome. Yet this mighty fabric, so beautiful as a whole, is made up of innumerable pieces of ponderous metal, welded, jointed, and rivetted into each other with exceeding deftness. The keel consists of several bars of iron, about 35ft. in length each, joined together by long scarfs, and is, as a whole, 14in. deep by 4in. thick. The framing is constructed in a manner at once peculiar, and securing the greatest possible amount of strength. Amidships the framing is of plates, with four angle irons running up to the gunwale; and towards the stem and stern there are angle irons in the usual way. The framing of the ship is very heavy. The space between each frame is 21in., and the powerful frames or ribs themselves vary in breadth, from 10 to 7in. in depth, with double angle irons at outer and inner edges. The bow is constructed in a manner at once peculiar, and affording the greatest possible strength to this important part of the ship. The framing of the bow is placed diagonally, the effect of which is, that in the case of collision with other ships, or with rocks or icebergs, the strain would fall upon the very strongest material within the structure, and the *Scotia* would have a good chance of safety and successful resistance, while ordinary vessels would indeed be in great peril. In addition to the keelsons and girders of the usual form, keelsons and girders of a novel form have been introduced, in order to give the ship prodigious strength. The ship, under any circumstances, must be of tremendous strength to pass the Government surveyors; but the builders have gone further than even this, and have put backbone and ribs into the vessel to give her an extra strength. The vessel is not clinker built, as some vessels now are; the plates of the ship being laid alternately, so that one adds strength to the other, and they form a whole of wonderful compactness and solidity. The keels plates are 1½ of an inch in thickness; at the bottom of the ship the plates are 1⅝ of an inch in thickness; from this section to the loadwater they are ⅔ of an inch, and above this they are 1¼ and 1⅓ of an inch in thickness.

The *Scotia* has seven water-tight compartments. The goods are to be stowed in two central divisions, 75ft. each in length, 20ft. in breadth, and 20ft. in height. These goods stores, or rather tanks, are placed in the centre line of the ship, and are capable of receiving 1500 tons of measurement goods. These chambers are perfectly water-tight, and, in the event of accident to the hull, these tanks would, of themselves, float the ship, the vessel being so constructed as to have, in reality, a double bottom under the goods chambers, so that if the outer were beaten in or injured, the inner would, in all likelihood, protect the cargo dry and intact. These goods holds are entered by three water-tight tanks from the upper deck. On each side of these tanks are the coal-cellars or bunkers, capable of containing 1800 tons of coal. She will have side lever engines, with two cylinders of 100 in. diameter each, and 12ft. stroke of piston. The paddles measure 40ft. 8in. in diameter, over the rings. She has four large tubular boilers, and two funnels; and we need only speak of her machinery in general, which is all ready, as being first-class.

The vessel has 157 state rooms, affording sleeping accommodation to 300 passengers, disposed along the main deck, lying immediately above the goods and coal stores. These cabins are nine feet in height; and, coupled with the excellent system of ventilation introduced into all the Cunard liners, we need scarcely say that they will be alike pleasant, airy, and healthful. In the fore-castle are the berths for the seamen and firemen; and amidships is the accommodation for some of the officers and engineers. Behind these are the galley and cook's quarters; while aft, on each side of the wheel, are the cabins of the chief officers. Provision has also been made for the conveyance of mails. Above the main deck there is a deck-house covered, the roof of which affords a promenade from stem to stern. The fore saloon measures 45ft. in length, by 20ft. in breadth, and 8ft. in height; the main saloon is 62ft. in length by 20ft. in breadth, and 8ft. in height. They will be copiously lighted from the sides by plates of glass placed in the alternate panels, and will afford dining accommodation for 300 passengers. In front is that important adjunct, the pantry; and before the funnels is the kitchen with its cooking ranges, exceeding most and equalling any of the culinary establishments of the most extensive and noted hotel in the kingdom. On this deck and below it are also to be found the bakery, the butcher's shambles, the scullery, the cow-house, the carpenter's workshop, lamp-house, doctor's shop, and ice houses.

The weight of the iron in the *Scotia*, as launched, was 2500 tons, and when the hull is finished its weight will be 2800 tons. When the engines are on board the weight of the immense mass will be 4050 tons, and when loaded to 22ft. draught will displace about 6500 tons. The engines are 883 horse power. Steam is the grand agent here; and the *Scotia*, like the other steamers of this line, is accordingly rigged only lightly with two masts. Each mast is 30in. in diameter. The figure-head is a classic figure.

In connection with this subject, we give a vidimus of the majestic mercantile steam fleet belonging to the British and North American Packet Com-

pany. The table shows the year in which the vessels were built, the materials of which they were built, the tonnage, power, and other particulars:—

Name of Vessel.	When Built.	Material.	Paddle or Screw.	Tonnage.	Power.	Builders.	Engine Makers.
America	1848	wood	P.	1826	650	R. Steele & Co.	R. Napier & Sons
Niagara	1848	wood	P.	1825	650	R. Steele & Co.	R. Napier & Sons
Europa	1848	wood	P.	1918	800	John Wood	R. Napier & Sons
Canada	1848	wood	P.	1831	670	R. Steele & Co.	R. Napier & Sons
Satellite*	1848	iron	P.	157	80	R. Napier & Sons	R. Napier & Sons
British Queen	1849	iron	S.	763	150	W. Denny & Bros.	Caird & Co.
Asia	1850	wood	P.	2227	750	R. Steele & Co.	R. Napier & Sons
Africa	1850	wood	P.	2226	750	R. Steele & Co.	R. Napier & Sons
Arabia	1852	wood	P.	2393	830	R. Steele & Co.	R. Napier & Sons
Balbec	1853	iron	S.	838	150	W. Denny & Bros.	Tulloch & Denny
Melita	1853	iron	S.	1255	180	W. Denny & Bros.	M'Nab & Clark
Karnak	1853	iron	S.	1127	150	W. Denny & Bros.	Tulloch & Denny
Jackal*	1853	iron	P.	180	100	J. & G. Thompson	J. & G. Thompson
Jura	1854	iron	S.	2241	440	J. & G. Thompson	J. & G. Thompson
Stag	1854	iron	P.	499	240	W. Denny & Bros.	J. & G. Thompson
Lynx	1854	iron	P.	499	240	W. Denny & Bros.	J. & G. Thompson
Persia	1856	iron	P.	3300	900	R. Napier & Sons	R. Napier & Sons
Stromboli	1856	iron	S.	734	100	J. & G. Thompson	J. & G. Thompson
Australasian	1857	iron	S.	2761	700	J. & G. Thompson	J. & G. Thompson
Leopard	1858	iron	P.	691	320	W. Denny & Bros.	Tulloch & Denny
Palestine	1858	iron	S.	1377	280	R. Steele & Co.	M'Nab & Clark
Olympus	1860	iron	S.	1794	250	J. & G. Thompson	J. & G. Thompson
Marathon	1860	iron	S.	1784	250	R. Napier & Sons	R. Napier & Sons
Hecla	1860	iron	S.	1785	250	R. Napier & Sons	R. Napier & Sons
Atlas	1860	iron	S.	1794	250	J. & G. Thompson	J. & G. Thompson
Heron	1860	iron	S.	624	150	W. Denny & Bros.	Tulloch & Denny
Ostrich	1860	iron	S.	624	150	W. Denny & Bros.	Tulloch & Denny
Graffe	1860	iron	P.	677	290	J. & G. Thompson	J. & G. Thompson
Kedar	1860	iron	S.	1783	250	W. Denny & Bros.	Tulloch & Denny
Scotia	1861	iron	P.	4000	1000	R. Napier & Sons	R. Napier & Sons
Sidon	} Bldg.	iron	S.	1785	250	W. Denny & Bros.	Tulloch & Denny
Morocco		iron	S.	1785	250	W. Denny & Bros.	Tulloch & Denny
China	iron	S.	2550	550	R. Napier & Sons	R. Napier & Sons	

NOTICES TO CORRESPONDENTS.

- J. W.—As you have not given us data enough, we can only answer you approximately, viz., from 25 to 28 trucks. We do not recollect either the first valve gear or the pass-over valve mentioned. The last one mentioned is not practical. The best one is the common link motion, and as long eccentric rods as practical; there is no advantage whatsoever in short eccentric rods, only disadvantage in causing the valves to work improperly. Your second communication was received after we had gone to press.
- A SUBSCRIBER OF SEVERAL YEARS' STANDING.—We had received the report of the performance of the *Western* in the usual way for insertion amongst "Notes and Novelties," and having seen the identical report in *The Steam Shipping Chronicle* of 14th June, 1861, page 196, and this journal being an authority upon shipping matters, caused us to insert it without looking into the correctness of the statement; but after having gone into the calculation, we find that, if the *Western* had consumed 6 tons of coals in 4 hours, with an I.H.P. of 380, it would have given a result of 8'842lbs. per hour per I.H.P., instead of 1'42lbs. as stated. And, on the contrary, if she had consumed only 1'42lbs. per hour per I.H.P., it would have given 2158'4lbs. for 4 hours, or 1 ton barely instead of 6 tons, as stated to have been consumed during a trial of 4 hours.
- A FRENCH SHIP-BUILDER AND ENGINEER (Liverpool).—You will find in our pages all the particulars you can require respecting the *Royal Charter*; and, as you appear to be on the spot, you can easily obtain whatever else you require.
- D. (Genoa).—Apply to Messrs. Randolph, Elder, & Co., Glasgow; send the dimensions and particulars of requirements.
- "GRECCO."—We will enquire about the new kind of boiler; we did not know of its existence. Messrs. Forrester & Co., Liverpool, have recently built a ship with a stern wheel propeller for Egypt.
- ALPHA.—We do not know the exact power indicated by the engines of the *Connaught* and *Leinster* Holyhead Packets. Messrs. Ravenhill & Co. have not supplied diagrams. These boats smoke now much less than formerly. We very recently watched the performance of the sister ship with engines by James Watt & Co.; the machinery worked admirably.
- C. D. C.—A proof of the paper is ready and will be sent to you immediately.
- H. B.—We have obtained some particulars, but not all you require.
- J. W. (Alexandria).—A new kind of apparatus is under trial which is said to be a great improvement. We only await such results to furnish particulars.
- A CARELESS READER.—As you confess, we must forgive. The *Warrior* is 380ft. long between perpendiculars, and 337ft. 5 $\frac{1}{2}$ in. on keel for tonnage. Her breadth, 58ft., and depth, 41ft. 6in. The tonnage, as given, is 6038 $\frac{1}{2}$ tons. The late Admiral Moorsom made a series of calculations respecting her probable performance on the measured mile and at sea.
- J. L. W. (Edinburgh).—Your suggestion is good, we will see what can be done.

RECENT LEGAL DECISIONS
AFFECTING THE ARTS, MANUFACTURES, INVENTIONS, &c.

UNDER this heading we propose giving a succinct summary of such decisions and other proceedings of the Courts of Law, during the preceding month, as may have a distinct and practical bearing on the various departments treated of in our Journal: selecting those cases only which offer some point either of novelty, or of useful application to the manufacturer, the inventor, or the usually—in the intelligence of law matters, at least—less experienced artizan. With this object in view, we shall endeavour, as much as possible, to divest our remarks of all legal technicalities, and to present the substance of those decisions to our readers in a plain, familiar, and intelligible shape.

THE THAMES IRON WORKS AND SHIPBUILDING CO. V. THE ROYAL MAIL STEAM PACKET CO.—This was an action brought in the Court of Common Pleas on the 1st. ult., by the plaintiff to recover the sum of £2049, the balance of principal and interest due on a contract to build two steamships for the defendants. The defendants paid the sum of £224 into court, and claimed to deduct the residue £1623, for 65 days penalties at £25 per day for delay in the completion of the contract as to one of the vessels. By the contract, the vessel was to be delivered to the defendants, by the 17th of October 1853, and time was stated to be the essence of the contract. By the specification she was to be bark rigged, but the defendants subsequently, to their minds, and directed her to schooner rigged; when the schooner rigging had advanced a great way towards completion the defendants reconsidered the matter, and communicated to the plaintiffs, desiring them to hold their hands, and ultimately, on the 27th October, wrote to the plaintiffs, stating that they preferred the vessel being bark rigged, according to the original specification. The alteration was thereupon made, and the vessel delivered to the defendants on the 21st of December. The contract contained a stipulation that if by any act, requirement or default of the defendants any delay should be occasioned the penalty of £25 per day should not be enforced. When application was made by the plaintiffs for the balance due in respect to the contract price the defendants claimed to deduct £1625 for 65 days delay in delivering the vessel to the defendants—viz, from the 17th October to the 21st of December, at £25 per day. After a conflict of testimony as to what passed with reference to the alteration from schooner rigging to bark rigging, the jury found in favour of the plaintiffs for the amount claimed, £1625, beyond the amount paid into court.

BURGESS V. WICKHAM.—This was an action brought in the Court of Queen's Bench by the Oriental Inland Steam Navigation Company to recover £4000, for which a new vessel, the *Ganges*, was underwritten by the defendant, who represent the Victoria Royal Marine Insurance Company. The vessel was lost on a voyage to India, and the defendants denied their liability on the grounds that, being only a river steambark, the *Ganges* had not been properly strengthened for the sea voyage, and that she was not seaworthy. It was proved that a very much higher rate was paid for the risk than the current rate on ocean-going steamers, and that the vessel had been strengthened in a proper manner. The result was a verdict for the plaintiff for the full amount claimed.

AUSTEN V. THE ASPHALTUM COMPANY (LIMITED).—This was an action tried in the Court of Common Pleas, on the 2nd ult., to recover damages for an alleged breach of an agreement under the following circumstances.—The company was established under the limited liability act for the purpose of working in Cuba for a substance called asphaltum, and manufacturing oil therefrom. The company had established works at Poplar, and found that in the course of the manufacture, there remained in the asphaltum after the oil was extracted a certain quantity of tar. The company had been in the habit of selling this tar at a penny per gallon. The plaintiff proposed a process by which it would be turned to a better account by extracting a larger quantity of oil and selling the residue. His estimate was that, out of 600 gallons of tar, costing £35 13s., he could extract 250 gallons of oil and one ton of residuum; the former to sell at 2s. 3d. per gallon, making £93 10s.; the residue at £20 per ton, making £52 10s., and leaving thus a profit of £16 12s. The company entertained his project, and entered into agreement with him for the purpose of carrying it out, and it was for a breach of that agreement on their part the present action was brought. The junior counsel on both sides settled the case, and a verdict was taken by consent for £75.

SMITH V. BOWLES.—This was a case tried in the Gateshead County Court on the 15th ult. The plaintiff sued for damages caused to his wheat crop by the smoke and noxious vapours from the defendant's Springwell Colliery. The question of law raised in the case had been decided in two of the superior courts of law; in one the decision was in favour of the plaintiff, and in the other in favour of the defendant. His Honour, therefore, confined his judgment to the question of fact, and on this he had no doubt that, having regard to the *ratio decidendi*, he ought to determine in favour of the plaintiff, and he, therefore, gave judgment in his favour, and assessed the damages at £22.

NOTES AND NOVELTIES.

OUR "NOTES AND NOVELTIES" DEPARTMENT.—A SUGGESTION TO OUR READERS.

We have received many letters from correspondents, both at home and abroad, thanking us for that portion of this Journal in which, under the title of "Notes and Novelties," we present our readers with an epitome of such of the "events of the month preceding" as may in some way affect their interests, so far as their interests are connected with any of the subjects upon which this Journal treats. This epitome, in its preparation, necessitates the expenditure of much time and labour; and as we desire to make it as perfect as possible, more especially with a view of benefiting those of our engineering brethren who reside abroad, we venture to make a suggestion to our subscribers, from which, if acted upon, we shall derive considerable assistance. It is to the effect that we shall be happy to receive local news of interest from all who have the leisure to collect and forward it to us. Those who cannot afford the time to do this would greatly assist our efforts by sending us local newspapers containing articles on, or notices of, any facts connected with Railways, Telegraphs, Harbours, Docks, Canals, Bridges, Military Engineering, Marine Engineering, Shipbuilding, Boilers, Furnaces, Smoke Prevention, Chemistry as applied to the Industrial Arts, Gas and Water Works, Mining, Metallurgy, &c. To save time, all communications for this department should be addressed "19, Salisbury-street, Adelphi, London, W.C." and be forwarded, as early in the month as possible, to the Editor.

MISCELLANEOUS.

THE MERCANTILE MARINE FUND.—From an account just published of the gross income and working expenditure of this fund for the year ending December 31st, 1860, it appears that the gross income amounted to £371,606, and the expenditure to £281,585, being an excess of income over the working expenditure of £90,021.

WESTMINSTER PALACE.—From parliamentary returns just issued it appears that the cost of gas in lighting the Houses of Parliament in the year ended March 31st last, was £3,153 5s. 2d.; the cost of oil, £2,178 6s. 11d.; and of wax, £378 10s. 2d. The cost of the clock and bells subsequently to April, 1859, has been £1,667, 18s. 6d. The whole sum

expended in the building, furnishing, lighting, and ventilating the new palace at Westminster since December 31st, 1859, is £35,769 15s. 1d.; and this amount does not include the cost of decoration of the building with fresco paintings and statuary, the expenditure for maintenance and repairs of the buildings and furniture, nor the current expenses of lighting and ventilating.

NEW COPPER COINAGE FOR INDIA.—The Secretary of State for India has issued instructions for the immediate supply of a new copper coinage for India. The contract, for 400 tons, is taken by Messrs. Ralph Heaton and Sons, of Birmingham, and is likely to be completed in seven or eight months.

THE DEBUSSCOPE.—M. Debus has invented a new form of kaleidoscope, which will be very useful to those engaged in the art of designing patterns. The common kaleidoscope is a tube enclosing two mirrors inclined to each other, so as to give a large number of images. One extremity of this tube is placed in a box which receives a number of small objects, transparent or opaque, coloured or uncoloured; in the other extremity is a hole through which the objects are viewed. The combined images of these objects form regular figures, which are varied with every agitation of the tube, and each displacement of the objects. Lately, the kaleidoscope was improved so as to present images of natural objects, dead and living, which passed under the eye of the spectator. The kaleidoscope under both these forms, however, has only been a toy, which was only occasionally used by the designers of embroidery. These mirrors of glass are replaced in the debusscope by two plates of silver highly polished, placed vertically, so as to form between them an angle of 45°, at the bottom of a box, which has the form of an elliptical half-cylinder. At the bottom the box has a triangular opening; in front, and at the top, the opening is half-oval. By taking any design, regular or irregular, and placing it above the triangular opening of the debusscope, and looking at it through the upper opening, the most irregular outline appears transformed into a regular and beautiful design. The novelty of the debusscope is not simply the substitution of a polished plate for two mirrors, but the arrangement of the apparatus, the idea of reducing the kaleidoscope to two vertical mirrors, and the use of a fixed object instead of small moveable objects. The debusscope may be made of any size. Instead of placing the mirrors in it at a fixed angle, they may be made to move round a vertical hinge, so as to obtain at pleasure any number of images. A graduated arc of a circle placed horizontally upon the apparatus, enables the observer to place the mirrors at any angle, and to reproduce any design. Every change in the apparatus, to the right or left, backwards or forwards, produces a new design.

TESTING ANCHORS AND CABLES.—The Tynemouth Chamber of Commerce has opened a public test for anchors and cables on the Tyne, and there is little doubt but that it will be generally adopted by the Insurance Clubs, as a number of the more active members of their committee are directors of the Chamber.

FIRE INSURANCE DUTY.—From a table showing the increase of the year 1860 over that of 1859 in the amount of Government duty paid by the various offices, we learn that the Royal Insurance Company is at the head of all the fire offices, the increase being £8,939 18s. 9d. The Phoenix, Imperial, Sun, and Queen, stand next in the list, the increase in each case being £2,500.

EMBANKMENT OF THE THAMES.—The Commissioners appointed to examine into plans for embanking the river Thames have just issued their report, which is as follows:—"We are of opinion that by establishing a spacious thoroughfare between Westminster-bridge and Blackfriars, by means of an embankment and roadway; and that the new thoroughfare thus created should be continued on eastward from Blackfriars-bridge by a new street, from the west-end of Earl-street, across Cannon-street, to the Mansion House. The line of embankment at Westminster would coincide with the terrace of the Houses of Parliament, and from thence to Blackfriars-bridge. The general level of the embankment and road would be four feet above Trinity high water. The road would commence at Westminster by an easy descent opposite the Clock Tower, and be continued on, 100ft. in width, to the eastern boundary of the Temple gardens; from this point the road would be reduced to 70ft. in width, and carried on a viaduct supported by piers of masonry, rising to the level of Blackfriars-bridge, so constructed as to leave a breadth of water for the convenience of the City Gasworks and the adjoining wharves of about 70 or 80ft. The spaces between the piers under the ascending road would be left available for barges to lie, and afford easy access to the water between this structure and the wharves. From Westminster-bridge to the eastern boundary of the Temple Gardens, the embankment—sustained by a river wall—would be solid in its whole breadth; which breadth opposite Richmond-terrace would be 220ft. from the existing river wall. At Hungerford it would be 320ft. from the existing wharf; at Somerset House about 120ft.; and at the Temple about 220ft. We propose that communications should be made with the intended roadway from Whitehall, opposite the Horse Guards, and also from some of the streets in the Strand; and that a new street should be formed, passing through the Savoy to Wellington-street. The frontage on these streets would offer eligible sites for building, as would also the inner frontage of the new road, if it should hereafter be thought fit so to utilise the ground. For the improvement of the navigation we recommend that the existing shoals between Waterloo and Westminster Bridges should be removed, due regard being had to the foundations of the former. Also that a uniform low-water channel of 6ft. in depth at ordinary spring tides, and 500ft. in width from the embankment wall, be secured, and thus the stream be more equalized in velocity. If at any future time any effect should be produced on the river from the diminution of its capacity for tidal water by reason of its embankment, arrangements may be made higher up the river by dredging, or by a tidal reservoir to compensate for the loss. The consideration, however, of this matter would naturally devolve on the Conservators of the River Thames. The embankment and street we have proposed will afford an opportunity of making the low level sewer without disturbing the Strand or Fleet Street, and at the same time facilitate the construction of the sewer eastward of the embankment. We are not prepared to recommend the construction of an embankment on the Surrey shore at present, but if hereafter it should be thought desirable or necessary to embank any portion of it, the scheme we have proposed for the Middlesex side will not in any way interfere with it. "With regard to that part of our instructions in which we are commanded by your Majesty to 'report on the costs and means of carrying the same into execution,' we beg to report that we estimate the cost of the land, making compensations, constructing the embankment and roadways, and also acquiring the property in the city for, and forming the new street to the Mansion House, at £1,500,000. This amount, however, would be reduced should it be thought right to dispose of any of the reclaimed land on the bank of the river for building purposes.

A YEAR'S TRADE AT LIVERPOOL.—In the comparative statement of the rates and duties received by the Mersey Dock and Harbour Board lately issued, evidence is given of the continued prosperity of the trade at Liverpool. There is one peculiar feature in the statement, namely, while there has been a slight decrease in the number of ships, there has been a very large increase of the tonnage which entered the port. This distinctly shows that the average size of the vessels trading to the Mersey is being considerably increased. The total revenue derived from "rates and duties" during the year ending June 24th, 1861, was £667,567 7s. 9d., against £604,269 13s. in the preceding year, thus showing an increase of £63,294 14s. 9d.

THE CENSUS OF IRELAND.—The returns of the Irish census for 1861 have just been issued. It appears that the population of Ireland on the 8th of April last, the day on which the census was taken, was 5,764,543, which shows an absolute decrease of population, compared with the census of 1851, of 787,842, or about 12 per cent.; compared with 1841, the decrease is 2,410,581, or 36 per cent. In the religious tables, which are now published for the first time, it appears that on the 8th of April the Catholic population

was about 4,500,000, while other persuasions are estimated at 1,273,960. Of this number more than half were of the Established Church, and about half a million Dissenters of other denominations. The following are the returns from the principal cities and towns showing the increase or decrease, as compared with the returns of the last census in 1851: Dublin (municipal), 249,733; decrease, 8,636. Dublin (suburbs), 46,231; ditto (county), 106,058; increase, 5,511. Belfast, 119,242; increase, 18,941. Cork, 78,892; decrease, 6,840. Waterford, 23,220; decrease, 2,077. Limerick, 44,626; decrease, 8,822. Kilkenny, 14,081; decrease, 5,894. Galway, 16,786; decrease, 7001.

CONTRACTS FOR TWO LARGE STEAM IRON TRANSPORTS have just been issued by the Admiralty, one to Messrs. J. Laird and Sons, of Birkenhead, and the other to Messrs. Samuda of Poplar. These transports have been designed in the Comptroller's department at Whitehall.

IMPROVED STEAM HAMMER.—At the Royal Agricultural Society, a single and double-acting steam hammer, exhibited by the Kirkstall Forge Company, is said to be capable of working up to 350 strokes per minutes, or "from three to four times faster" than any steam hammer previously constructed; and its manipulation by the attendant showed that the length of the stroke can be instantaneously and certainly varied.

BITUMINIZED PAPER PIPES.—The pipes are superior to iron pipes both in durability and strength, and they are, from their inoxidability, free from the objections which are continually being urged against the employment of that metal for the conveyance of water; besides possessing all the qualities necessary for the conveyance of any liquid, however admixed with mineral, and compared with iron, being but one fifth its weight, and one half its cost, they are peculiarly adaptable to mining and colliery operations. Experience has proved that the drier the soil through which iron pipes pass, the greater is the oxidation; whereas in damp clayey soils the oxidation is comparatively slight. Both at Aldershot and Victoria Docks, the dryness of the soil caused the most rapid oxidation of the iron pipes, and the consequent discolouration of the water which was conveyed by them. By the adoption of the bituminized paper pipes, however, this great objection has been altogether removed, as it is impossible for the fluid they convey becoming impregnated with any foreign substance. By the application of a new cement of great strength for the joints, and an ingenious plan of tapping, this important invention may now be stated to be complete in all its details, and one that will, when better known, be generally adopted.

SUPPLY OF COAL TO LONDON.—For the quarter ending June 30, the returns show that 353,263 tons 16cwt. of coal have been carried by various railways to the metropolis, and 4795 tons 10cwt. by canal, making a total of 358,059 tons 6cwt. For the six months ending this date there has been the large increase of 124,197 tons 13cwt. as compared with the corresponding period of last year, the coals by railway for the present year being 839,035 tons against 714,838 tons. The canals show an increase of 468½ tons for the six months. During the quarter, the London and North Western have carried 177,547 tons; Great Northern, 155,112 tons; Eastern Counties, 45,360 tons; Great Western, 23,770 tons; Midland, 14,014 tons; Hertford, Luton, and Dunstable, 4999 tons; South Eastern, 3554 tons; South Western, 2831 tons; Chatham and Dover, 337 tons; Tilbury and Southend, 198 tons.

NAVAL ENGINEERING.

THE "ROYAL OAK."—In order to give this vessel increased strength to bear the additional weight of the armour-plates with which her sides will be protected, about 20ft. have been added, which will make her little short of 300ft.

THE "ARETHUSA," which as been several months in the hands of the dockyard workmen at Chatham, undergoing the alterations to adapt her for a screw steamer, is expected to be completed, and ready to be put out of dock by the end of the present, or beginning of the ensuing month.

THE "BLACK PRINCE." The engines supplied by Messrs. Penn are found to work very well. At a trial of the large engines a speed of 120 revolutions per minute was attained with a pressure of 7lbs., the vacuum being 26½ in. As the propeller was not attached, only four of the ten boilers were lighted. The nominal power of the engines is 1,250 horses, but their indicated power will be little short of 6000 horses. The vessel, as regards her machinery is all but ready for sea, but other fittings will not be completed till towards the end of the present month.

THE "RATTLESNAKE," 21.—The launch of this fine screw corvette took place on the 9th ult., at Chatham Dockyard, and was attended with the most complete success. The *Rattlesnake* is one of the largest of the class of 21-gun screw corvettes, the extreme length of the vessel is 308ft., her extreme breadth being 40ft. 8in.; her burden is 1623 43-94 tons. A 4-gun paddle-wheel despatch steamer, to be named the *Salamis*, will be laid down on the slip from which the *Rattlesnake* was launched.

THE "HOVE."—At the second contractor's trial, on the 1st ult., of the engines of the screw steamship *Hove*, 121, outside Plymouth Breakwater, a mean speed 13.569 knots was obtained. This rate is said to be unexampled, and exceeds by nearly half a knot that obtained from the sister ship *Victoria*, 121, at Portsmouth. The trunk engines of the *Hove* are of 1000 horse power nominal; they can be exerted up to 4800, and on this occasion were worked up to that power. The four boilers are tubular; furnaces, 32; pressure of steam on boiler, 20lb.; mean pressure on the piston, 24lb.; Maudslay's shifting propeller was used; diameter of screw 20ft.; pitch, 28ft.; mean revolutions, 57½; maximum, 58.

THE "TRUSTY."—Steam was got up on the 20th ult. in Her Majesty's floating battery, *Trusty*, (14), 150 horse-power, in order to test the efficiency of her engines, preparatory to a first trial at sea of Capt. Cole's patent shot-proof gun shield. One of the great advantages derived from the aid of this shield is found to be the port-holes, which is entirely closed by the gun, save the small space sufficient to permit an elevation of 10, and a depression of 7 degrees. The horizontal motion or training, is effected by turning the shield itself, with the gun, screw, and platform on which they stand. The shield is provided with a hollow cylinder 3ft. in diameter, through which the powder is handed up from the magazine, and communication obtained. A current of air is likewise kept up through the hollow pivot by means of a fan, which causes the smoke, directly it leaves the breech of the gun, to escape through the opening immediately above it. The exposed portion above the gads of 3ft. 8in. (the entire shield being 7ft. high) is covered with blocks of iron, and the lower part is sunk into the deck, and protected by an iron glacis. The face of the shield presents a slanting surface of 45 degrees elevation, on a solid substance of 4½ in. plates of iron, backed up by 18in. timber blocks. It is calculated that any amount of pounding from an enemy's guns would produce no injurious effect, as no horizontal fire can strike this structure above the water line, except at an elevation of 40 degrees. It is completely protected against a vertical fire by its arched roof, and is supported on each side by stanchions.

THE "DEFENCE," iron-plated steam frigate is to be fitted with Cunningham's self-reefing topsails.

THE "BLACK PRINCE," iron-plated steam frigate.—The screw of this vessel consists of the bush and two leathers, forming three separate castings, afterwards fitted together, and is of brass, weighing about 36 tons, so that its value, at the current price of mere metal, will be upwards of £4000.

THE "ACHILLES."—On the 24th ult., steam was got up in the new factory, for preparing the iron work required in the construction of the *Achilles*, 50, under the direction of the chief engineer, for the purpose of testing the new machinery. The various machines, including those for punching, drilling, boring, planing, and otherwise preparing the large iron slabs, were all set in motion for the first time, when they were all found to work in a most satisfactory manner.

NAVAL ENGINEERS.—The following appointments of naval engineers have been made this month.—H. H. Small, Assistant Engineer to the *Cumberland*, for the *Lizard*; Thomas Scott, Assistant-Engineer to the *Asia*, for the *Myrtle*; J. J. Blumden, Engineer to the *Cumberland*, as supernumary; Edward Parsons, Engineer to the *Griffin*; and B. T. Brierly, acting Assistant-Engineer to the *Griffin*; C. Mullar, Assistant-Engineer to the *Figuard*, as supernumary; J. Bowker, Acting Assistant-Engineer to the *Cumberland*, as supernumary; George Duncan, Owen Douglas, William J. Hancock, George Thompson, Isaac Hall, George Hurst, James K. Weatherly, James J. Conway, Robert Goodwin, Thomas Hunter, William Moore, Augustine Kedware, William Harris, William Stracham, James Adams, Edmund Clark, George R. Beer, Henry Collier, William B. Rock, Henry Brown, James W. Anthony, William J. Robinson, John Flintoff, William J. Keates, James Pettis, W. Sumner, William Jones, John W. Owen, Augustus Stretton, John Dimmockie, J. R. Jackson, John Miller, and William E. Grig, Acting Second Class Assistant-Engineers, to the *Imperieuse* as supernumeraries; W. M'Neill, Assistant-Engineer to the *Figuard*, for the *Bristle*; W. T. Fry, to the rank of Engineer; A. Lawton, acting first-class Assistant-Engineer in the *Leopard*; Henry H. Symcock, acting second-class Assistant-Engineer to the *Asia*, for the *Wallace*; W. R. Abbott, acting second-class Assistant-Engineer to the *Asia*, for the *Traveller*; Alexander Beattie, and Jas. Sterling, acting second-class Assistant-Engineers to the *Himalaya*; John Robson, promoted to Chief-Engineer; William F. Cap, Engineer to the *Taurus*; and W. Powell, first-class Assistant-Engineer to the *Marborough*; Edwin Pearce, Engineer to the *Racon*; W. H. Bambury, first-class Assistant-Engineer to the *St. Jean d'Acre*; W. C. Brewer, first-class Assistant-Engineer to the *Asia*, for the *Escort*; and Richard Oliver, second-class Assistant-Engineer to the *St. Jean d'Acre*; John Lee, Chief-Engineer, to the *India*, for the *Leopard*; Herbert W. Hart, acting second-class Assistant-Engineer to the *Asia*, for the *Wallace*; James Radford, acting second-class Assistant-Engineer to the *Cumberland*, for the *Wildfire*; and Samuel Lloyd, acting second-class Assistant-Engineer, to the *Figuard*, as Supernumary.

THE "WARRIOR."—The small double-action steam engine of 30 horse-power, intended for the internal use of the *Warrior*, having been completed on the 24th ult., got up steam outside the factory at Woolwich, to test her working capabilities, which were found satisfactory. This engine will be fitted in the space between the ship's boilers and engines, and will be employed in cleansing out the vessel, blowing off the smoke after the fire of the broadside guns, pumping water, &c., and will be used in case of need, as a fire engine, for which it is well adapted.

THE TRIAL TRIP OF THE "BLACK PRINCE" took place on the 24th ult.—In the first trip this leviathan accomplished, as near as can be computed, 7 knots or 8 miles, in 30 minutes, equal to 14 knots, or 16 miles an hour. This, with but small pressure on at the time, was regarded as admirable steaming, and was said to more than come up to the most sanguine expectations. There was a perceptible vibration on board, but nothing more than had been anticipated. The second run, though it was difficult to pronounce an opinion from the distance not being entirely run through, yet it is supposed the speed attained could not be less than at the rate of 16½ knots, or 18½ miles per hour.

STEAM SHIPPING.

UNsinkable IRON SHIPS.—On the 6th ult. a handsome iron steamship, constructed upon a novel but simple plan, which the patentee affirms renders entire submersion impossible, whatever accident or damage may befall her, was launched from the yard of Mr. Lungley, at Deptford-green. She is divided into compartments by transverse iron bulk-heads, but in addition to this precaution, which the experience of the *Connaught* and some other iron steamships that have been lost during the last two or three years, shows is by no means an effectual safeguard under all circumstances, she is built in three distinct decks, each being in effect a ship in itself. The advantage of this arrangement is, that if a plate were removed, or a hole knocked through the side in either deck, or even if her bottom were torn away altogether, she would still float, there being no communication between either of the lower decks, each of which communicates with the upper deck by a separate shaft or hatchway. Not only is the danger of water thus guarded against, but the frequently more serious one of sea fire is brought completely under control. Were a fire to break out in the hold, or in either of the compartments, it would be only necessary to close the communicating shaft and leave it to die out of itself, which, as no air could get to it, the several decks being air-tight as well as water-tight, it must soon do; or any quantity of water might be pumped down, even to the entire filling of the space between decks where the fire existed. Her engines and furnaces are, of course, placed so high in the vessel that no amount of water in the lower decks would interfere with their free action. The name of the new vessel, which is the first that has been built upon this patent, is the *Briton*, and she is destined for the Cape mail service, having been constructed for the Union Steamship Company, who have the contract for that service. She is a fine ship of 1,100 tons, builder's measurement, her dimensions being—length between perpendiculars, 239 ft.; length, over all, 262 ft.; breadth, moulded, 25 ft. 5 in. There was a large company present at the launch, to whom were exhibited, by means of models, the capabilities of vessels constructed upon Mr. Lungley's patent of maintaining their buoyancy under the most adverse circumstances of leakage. Plugs were withdrawn from below the water line until first the one and afterwards the second deck were filled with water, but the hull still floated steadily, though deeper, showing that in no conceivable case would there be any difficulty in keeping a ship so built afloat until land was reached, even if by means of divers sent down below the leak could not be found and stopped. The *Briton* is now lying in the river off Mr. Lungley's wharf near the Deptford Dockyard, where she will remain for some time for the completion of her internal fittings, and as she is likely in some degree to aid in the solution of the problem of how far ships can be made impregnable, will no doubt become an object of attraction.

FROM A PARLIAMENTARY RETURN lately issued, we learn that 1,945 steam vessels were registered in the United Kingdom on or before January 1st, 1861. The registered tonnage amounted to 440,880 tons, the gross tonnage to 786,417. The total number of vessels employed in trade and commerce in Great Britain, exclusive of river steamers, is 20,019, of 4,251,739 tons.

THE "CITY OF NEW YORK," a fine new screw steamer built for the Liverpool, New York, and Philadelphia Steamship Company, by Messrs. Tod and Macgregor, lately arrived in the Mersey, and will shortly commence running between Liverpool and the "Empire City." The City of New York measures 350ft. in length over all, her moulded breadth is 50ft., and her depth 27ft. 6in. She is 2560 tons old measurement, and constructed on fine lines. She is divided into six water-tight and fire-proof compartments, by five strong bulkheads, passing right across her hull, from the top of the keel to the under surface of the upper deck, and to strengthen her still further she has steel plates running along her deck, and extending from the gunwales on each side to the outer side of the house on deck. These steel plates are securely rivetted to the beams, and, being placed so high in the hull, they constitute admirable ties, by which the whole framework of the vessel is firmly bound together. The *City of New York* is propelled by a screw of three blades, 18ft. in diameter, and 29ft. pitch. This screw is driven by two engines, which work horizontally, and have a direct action of nominally 550 horse power, but which may be worked to double that power. They are furnished with patent surface condensers, and have cylinders 85in. in diameter, with a 3ft. 6in. stroke.

STEAM BETWEEN HAVRE AND SOUTHAMPTON.—The mercantile community of Havre are endeavouring to get established a daily mail communication between that port and Southampton, by means of the South Western Company's steamers, for the purpose of facilitating the French mails to and from the West Indies, the Brazils, and the United

States. The French Government have offered to exempt the company from harbour and other dues, which would amount to upwards of £5000 a year, provided such daily communication is established. At present the communication is only tri-weekly.

THE GREAT EASTERN is to be employed regularly in the trade between Liverpool and New York, but at this season the prospect of receipts from visitors at Liverpool being good, it is intended to exhibit the ship at that port from the second week in the present month, when she is expected to return from Quebec, until about the middle of September, when she will sail for New York, returning to the Mersey about the middle of October.

RAILWAYS.

SPANISH RAILWAYS.—A Cadiz paper states that from the 28th of May until the 3rd of June, the railway trains between Seville and Cadiz conveyed 31,477 persons. During the same days the cars carried through the Alicante-Madrid Railroad 14,991, and by that of Madrid to Saragossa 10,843. This statement shows that the Seville, to Cadiz line has the greatest transit in all Spain.

THE SEVILLE, XERES, AND CADIZ RAILWAY accounts, lately presented to a meeting of the shareholders at Madrid, show that the line has cost an average of £7,500 per mile, and that the receipts, less the working expenses (54 per cent), will yield a return of 5 per cent. on the capital expended.

RUSSIAN RAILWAYS.—The concessions of the Great Russian Railway Company have been reduced by the Imperial Parliament to lines from St. Petersburg to Varsovia, from Kourou to the Prussian frontier, and from Moscow to Nijni-Novgorod. These lines are already in an advanced state, and the Russian Government, to accelerate their completion, propose to advance to the company the £4,000,000 or £5,000,000 required to complete them with the least possible delay (on condition of sharing the profits of working); it has also authorised the company not to execute the lines from Moscow to Theodosin. Thus the company, which had to realize an immense capital by successive issues of shares, can limit itself, or nearly so, to its actual capital. A guarantee of 5 per cent. is assured to the £20,000,000 which composes this capital, the expenditure being thus regulated:—Line from St. Petersburg to Varsovia, £13,600,000; line from Vitna to the frontier of Prussia, £1,777,440; line from Moscow to Nijni-Novgorod, £4,150,000.

NEW RAILWAY BRAKE.—Messrs. Du Tremblay and Martin are now exhibiting the model of a "pneumatic railway brake" of very ingenious construction. The pressure of the atmosphere is obtained by means of a cylinder of a diameter proportionate to the power required. The cylinder is supplied with a loose fitting disc or plate, to which is attached a rod, the air tight joint being a diaphragm of india-rubber. This apparatus being placed under the carriage, the rod is attached to the break crank, and when the air is exhausted the exterior pressure acting upon the diaphragm, presses the "shoes" against the wheels in the manner in which the operation has hitherto been performed by the screw. The air is exhausted by the pneumatic pump worked by an eccentric fixed upon the wheel axle. On the closing of the pipe which communicates with the exterior air, the pneumatic pump continues to work so long as the wheels are in motion, thus producing a vacuum always adequate to the power required to lock the wheels. For the formation of a vacuum, a small apparatus is also introduced, to which are attached the tubes communicating with the cylinders, being similar to a double tube, that forming the interior being a continuation of the one first mentioned. The distance between the two forms an annular, through which rushes a jet of steam from the boiler, the speed of which, by friction, exhausts the air and gives an exterior pressure of ten pounds to the square inch on the diaphragms in less than two seconds, at the pressure at which steam locomotives are generally worked. It is thus claimed for the invention that the whole control of the train is left with the engineer, who can regulate an inlet of air so as to use the power which he may require, the vacuum gauge affording all necessary information.

THE EASTERN BENGAL RAILWAY COMPANY has a concession to construct a railway from Calcutta to the river Ganges at Kooshtee, and ultimately to Duca, together with a branch to Jessore; the company have taken power under an act of incorporation, to increase their capital to £6,000,000, and to make arrangements for the construction of at least 600 miles of railway. Sufficient capital to construct the first section of 110 miles from Calcutta to Kooshtee, has at present only been raised.

INDIAN RAILWAYS.—Fifty-six millions sterling represent about the anticipated cost of railway works in India, already conceded to the fostering care of joint stock companies; this amount is to be invested with the Government of India at a guaranteed rate of interest of 5 per cent. per annum, with a prospect of an additional rate of interest from dividends.

SINDH RAILWAY.—This line from Kurrachee to Kutree, a distance of 105 miles, has been opened, and telegraphic instruments have been fixed at all the stations.

CYLON RAILWAY.—A great amount of correspondence is taking place in the Ceylon papers regarding this railway. Captain Moorsom declares his belief that the line can be done for £1,200,000. Messrs. Brassey and Co., the contractors for the Eastern Bengal, have offered to construct it for £1,300,000. Another proposal has also been made to construct a tramway at a cost of £400,000.

RAILWAY ACCIDENTS.

EXPLOSION OF A LOCOMOTIVE, ON THE LONDON AND NORTH-WESTERN RAILWAY.—On the night of the 5th ult., shortly after half-past ten o'clock, a fearful explosion of a powerful locomotive engine, which had brought down the Irish mail train from London, took place on the Trent Valley line, about four miles from this place, resulting in frightful injuries to the engine driver and fireman, a post-office clerk, and serious injury to several passengers, caused by the sudden break-down and stoppage of the train, as well as involving a vast destruction of property. It appears that the Irish mail left Euston Station at its proper time on Thursday evening, 8.30, and proceeded at the rate of a little over forty miles per hour, arriving at Rugby at 10.25. The engine then appeared to be in perfect order, and the driver, as is usual, proceeded to one of the stand pipes on the down line to take in water. Having filled his tank he came back, and coupled on to the mail train, and proceeded on his journey. The engine and train had proceeded about four miles down the Trent Valley line, and had just attained its usual running speed, when a frightful explosion took place, and the whole of the upper part of the engine and boiler, fire, and fire-box—indeed, every part of the structure, excepting some few of the tubes, being dashed into thousands of pieces. The framework of the engine, as well as the tender was thrown over and partially down an embankment, whilst the guard's break-van and the Post Office van, which was next to it, were in an instant heaped one upon the other, some being splintered and smashed. The explosion was of such a character that it was distinctly heard both at Rugby and Nuneaton, and, with a little delay, as possible, engines with assistance were despatched to the spot. The driver and stoker were found at the bottom of the embankment, dreadfully scalded and otherwise injured, the latter so much so that he had to be conveyed to an adjacent village, where he shortly after expired. A clerk in the Post Office was very severely injured, as well as five or six passengers who were injured more or less.

FALL OF A RAILWAY TUNNEL.—A dreadful accident occurred on the 2nd ult. on a new line of railway, which is being formed between the Rowsley terminus of the Manchester and Midland junction, and the watering town of Buxton, by which five men and a horse were killed, and several others received serious injuries. The facts of the case are as follows:—A tunnel is being formed about 200 yards below the ancient Hall of Hadon, in Derbyshire, and between three and four o'clock on the afternoon of the 2nd ult., whilst about seventeen men were at work in it, the centres upon which the stone arch had been formed, gave way, causing the massive stonework to fall down into the tunnel, and burying under it several of the workmen. The contractors had only just completed about twelve yards of the tunnel, about nine yards of which has fallen.

ACCIDENT OF THE NORTH KENT RAILWAY.—An alarming accident occurred on the North Kent Railway, near the Strood station, on the 13th ult., whereby a young man named Charles Whitehead, in the service of the South Eastern Company, lost his life, the accident, fortunately, being attended with no other fatal consequences, being confined principally to the destruction of the company's property. The train to which the accident occurred was a heavily-laden goods train, made up principally of coal trucks and waggons containing merchandise, in all about thirty trucks, drawn by a powerful engine, which was on the eve of starting from Strood station to Maidstone with its load, when the occurrence took place. The goods station at Strood is built at the foot of a steep incline, where the line for some distance, has a rise of one in about eighty four. In order to ascend the gradient it is usual for the goods trains proceeding from Strood to Maidstone to back a short distance, up the down line, in order to enable the engine to gain an impetus to draw the train up the incline. About eight o'clock on Saturday evening, the line having been reported all clear, the goods train was in the act of backing up the down line of rails, and had proceeded about 100 yards into the Strood tunnel, when the break-van, which was at the end, from some cause which cannot now be satisfactorily accounted for, gave a start and jumped off the line, falling over on its left side on to the up line of metals. The heavy waggons following the break-van instantly fell over the obstruction, and before the entire train could be stopped, the trucks and waggons at the extreme end were pulled on each other in one incongruous manner, reaching as high as the arch of the tunnel. The only occupants of the break-van at the moment of the accident were Fowler, the guard of that part of the train, and the deceased Charles Whitehead. It would seem that on the train leaving the metals the deceased opened the left-hand door of the break in order to get out, and was in the act of leaving the van when it turned over and fell on him, crushing him in a most horrible manner, and of course causing instantaneous death. Fowler the guard, who retained his place in the van, escaped with only a few slight contusions, and effected his escape through the window of the break.

MILITARY ENGINEERING.

GIGANTIC GUN.—A series of experiments have lately been carried out at Shoeburyness with a new description of gun, the invention of Mr. Thomas. This piece of ordnance is of gigantic size, its weight being about seven tons. The bore of the gun is rifled with seven grooves. The shot used weighed 145 lbs. The weight of powder used in firing was 25 lbs. During the experiment the gun suddenly burst while a 145 pounder shot was being fired from it, the fracture at the breech showing the iron to be faulty.

AN ARMSTRONG 120 POUNDER GUN, on a new arrangement, was landed on the 1st ult. at Woolwich, for the purpose of being tested. In this gun the screw for closing the breech is suspended by a wedge, the series of small rifle grooves are dispensed with, and three large grooves on the shunt plan are substituted in their place. This gun had recently been employed with success at Shoeburyness in demolishing the battery lined with 8 and 10 inch plates of iron, and at which a projectile was fired weighing 126 lbs.

COLONEL TULLOCH, R.A., superintendent of the Royal Carriage Department of the Woolwich Arsenal, and Inspector of Artillery, received, on the 11th ult, his appointment as Director of Ordnance. In his new capacity he will be charged with the important duty of advising the Secretary of State upon all questions relating to the supply and efficient maintenance of guns, small arms, ammunition, and other ordnance material. He is also entrusted with many other responsible duties, and will, in conjunction with the Inspector General of Fortifications, determine the armaments of all works of fortifications. He has been succeeded by Lieut.-Col. Henry Clerk.

ANCIENT GUN.—A wrought iron gun, made in the reign of Henry VI., was recently cut open at Woolwich for the purpose of ascertaining the nature of its construction. The gun proved to consist of longitudinal staves or bars, built up and hooped with a series of outer rings, the interstices being run in with lead. This process has undergone considerable examination and much scientific scrutiny.

TELEGRAPHIC ENGINEERING.

THE INTERNATIONAL TELEGRAPH COMPANY of London have obtained permission from the French Government to establish an electric communication between Dieppe and Newhaven, and the cable has been laid after a temporary misadventure. This company intends to transmit despatches by the Dieppe line to any part of Great Britain or Ireland for 3 francs, in place of 7½ francs, the charge made for sending messages by way of Boulogne and Calais.

THE CHANNEL ISLANDS TELEGRAPH.—It is understood that this cable, which has recently broken, will not be repaired at present, and that the existing alternative line from Jersey to Constance, on the coast of France, will work the telegraphic communication for the Channel Islands through Paris and thence to England. The reason assigned for this, is that the Channel Islands Telegraph Company do not find the enterprise to pay the working.

THE ALEXANDRIA AND MALTA CABLE.—The Rangoon has arrived at Malta, having successfully laid the second section of this cable.

AUSTRALIAN TELEGRAPHS.—The telegraph from Mudgee to Bathurst, a distance of 80 miles, has been completed, and connected with the Sydney line. Both of the northern extensions are in a forward state, and will soon be completed to the frontier of Queensland.

DOCKS, HARBOURS, CANALS, &c.

HARBOURS OF REFUGE.—From a return ordered by the House of Lords, and lately issued, it appears that the debts due by Whitby Harbour amount to £32,770; by Bridlington, £136,807; and by Dover, £46,518, to which harbour is a large property belonging. There is no debt due by Ramsgate Harbour. Last year there was paid out of public money, as compensation for differential dues, as much as £53,906.

IMPROVEMENT OF DOUGLAS HARBOUR, ISLE OF MAN.—The House of Keys and the Home Government have at last fixed on plans for the improvement of this harbour, and the work is to be proceeded with at once. The plan adopted is that of Mr. Abernethy, for a pier of 1100ft. extending from Douglas Head. It will be a cross-timber work on a rubble base, and the estimated cost is £38,000, towards which there are upwards of £10,000 of accumulated funds in the hands of the Lord of the Treasury. The balance will be obtained from the annual revenue of the island.

BRIDGES.

WESTMINSTER BRIDGE.—A return has lately been issued respecting the Westminster New Bridge. It is expected to be completed, "supposing the weather to be favourable," in the month of March next. The amount expended and required to complete the bridge are as follows:—Amount expended since the 6th of August, 1860, £49,460; ditto on the approaches, £1624. The expenditure in both cases was defrayed from funds voted by Parliament. The estimated expenditure for the completion of the bridge, £63,789; the estimated expenditure for completion of purchase of property for the approaches and execution of works, £136,135; it will be necessary to apply to Parliament, to complete the bridge, for the sum of £60,692; and for the approaches (in addition to vote 3, class 1, Civil Service estimate, £2500). The money arising from the sale of the stone of the old bridge and from the sale of plant now in use, will it is estimated, produce about £23,000, but the greater part of it will not be realized until after the completion of the works.

WATER SUPPLY.

TRANMERE WATERWORKS.—The foundation stone has been laid of the water tower and reservoir for the water works at Tranmere, in Cheshire. The site of the reservoir is the highest elevation in the township. The reservoir is 70ft. square, and, when puddled and cemented round, will have 21ft. depth of water, or 640,000 gallons, about equal to four days supply for the present population.

GAS SUPPLY.

THE KELSO GAS COMPANY at the annual general meeting declared a dividend of 10 per cent. on the paid-up capital of the company. The price was also reduced from 7s. 6d. to 6s. 8d. per 1000 cubic feet.

SWANSEA GAS COMPANY.—In accordance with a clause inserted in their recently-obtained Act of Parliament, this company has just reduced the price of gas from 5s. 10d. to 4s. per 1000 cubic feet.

AN IMPROVED APPARATUS for carburetting or naphthalizing gas has been invented by Mr. A. L. Leveque, of Paris. The working of the improved apparatus is based on the principle of keeping the carburetting or naphthalizing hydro-carbon liquid at a constant level in the apparatus.

BOILER EXPLOSIONS.

THE ASSOCIATION FOR THE PREVENTION OF STEAM-BOILER EXPLOSIONS.—At the last ordinary monthly meeting of the executive committee of this association, held at the offices, 41, Corporation-street, Manchester, on Tuesday, June 25th, Hugh Mason, Esq., of Ashton-under-Lyne, in the chair, Mr. L. E. Fletcher, Chief Engineer, presented his monthly report, from which we have been furnished with the following extracts:—"During the past month 208 visits have been made, 559 boilers as well as 461 engines have been examined, and the following defects discovered: Fracture, 7; corrosion, 13 (1 dangerous); safety valves out of order, 11; water gauges ditto, 13 (2 dangerous); pressure gauges ditto 13; feed apparatus ditto, 4; blow-off cocks ditto, 9; fusible plugs ditto, 4; furnaces out of shape, 11; over-pressure, 1; deficiency of water, 3; boilers without safety valves, 3 (dangerous); total, 89 (6 dangerous); boiler without glass water-gauges, 4; without blow-off cocks, 26; without pressure-gauges, 4; without feed-back pressure valves, 63. There is a description of feed-stop valve, which I find in very general use, the inconvenience and even danger attending which, I think, our members are not sufficiently aware of; and I wish to call their attention to this, that its use may be discontinued where new boilers are being erected, and the construction of existing ones corrected as far as possible. The valve to which I refer is constructed on the suspension principle; it being opened against the force of the feed by a spindle attached to it, so that, should the connection between them at any time fail, the valve drops to its seat and cuts off the feed. I have found very few cases in which this valve has been in use for any length of time, where this connection has not given way unawares, always causing more or less inconvenience—in some cases the stoppage of the works, and in one case explosion and loss of life. The remedy is simple and inexpensive. Dispense with the feed-stop valve proper altogether, and regulate the supply by controlling the lift of the back-pressure valve by a screwed spindle placed above it, but entirely disconnected from it. This arrangement makes one valve answer the double purpose; it is simpler and less expensive than that of having two distinct valves—is in very general adoption, and found to work well; and I shall be glad to see it entirely supersede the other arrangement. Although this is but a minor detail, still I attach importance to it, from the fact of loss of life having occurred from its malconstruction. I wish our members would avail themselves more regularly than they do of the opportunity afforded by this association, of having each of their boilers internally and "thoroughly" examined once a year. No external examination, however carefully made, can render this unnecessary, and I must therefore beg the co-operation of members in this respect. The ravages of corrosion are so silent and stealthy, that many boilers, supposed to be by their owners in a most healthy condition, are found, upon "thorough" inspection, to be so eaten away in places, that a blow with a hammer penetrates them; and seldom a month passes but I meet with cases of this sort. This, although not exclusively so, is most frequently met with in boilers set up on mid-feathers. Nothing could corroborate the above remarks more strongly than an explosion which has occurred since they were written, to a boiler not under the inspection of this association, and which has resulted in serious injury to two men, one of whom has since died in consequence. I examined the fragments yesterday, and found that the explosion had been caused entirely by external corrosion, the plates being thereby reduced from ¾ to less than ¼ of an inch in thickness. This did not manifest itself internally, but would have been detected, had a thorough examination been made of the surfaces of the plates in the external flues. Both the superintending engineer to the works, as well as the men more immediately in charge of the boiler, were taken quite by surprise at the state in which the plates proved to be, as well as at the devastation caused by steam at so low a pressure as twenty-five pounds. I trust, therefore, that the members of this association will not rely upon low pressure or internal examinations alone, but make arrangements for having their boilers "thoroughly" inspected, both internally and externally."

MINES, METALLURGY, &c.

THE RUSSIAN GOLD MINES of the Ural Mountains, yielded in the year 1860, 125 tons 12lbs., and those of Siberia, 1014 pounds 13lbs. As compared with the preceding year, the Ural mines show an increase of 12 pounds 6lbs.; the Siberian a decrease of 118 pounds 10lbs., caused partly by fewer hands being employed, and partly by the sands being less rich in gold than heretofore. But beyond Lake Baikal, the activity of the gold-seekers had increased, and the produce here amounted to 947 pounds 30lbs. The number of working licenses granted in 1860 were 39, of which 15 were granted to nobles and 24 to traders. In the same year 32 companies were formed for working the mines, and 167 new *placers* were declared. The total number of men employed in the mines were 23,899, and 700 women.

PRODUCTION OF PURE ALUMINA.—M. Louis C. Chatelier has lately patented an invention which he anticipates will remove the difficulty of obtaining alumina economically. He employs a mode of precipitation, which at the same time that it produces alumina by means of substances abundant in nature or in the arts, gives another substance, which possesses a value sufficient to pay at least a part of the expense of manufacture. He also employs the sulphate of alumina in a state of solution, or paste, without the necessity of bringing it to a solid state. The principle re-agents used are magnesia, chloride of sodium, and sulphate of barytes.

WAGNET IRON AND STEEL.—Capt. Blakely, R.A., of Holywood, County Devon, has patented an invention, which consists in bringing bars or hoops of steel or iron to a dull red heat, and in that state extending or pulling them out in the direction in which the increase of strength is required. He applies the pulling strain until they are cold, or nearly so; when cold it is said they will be found to have increased in tensile texture. The extension may be affected in any ordinary way.

THE NEWBUDA COAL AND IRON COMPANY have received the following from their managing agents in India. "I have fairly proved the coal at the outcrop, on each side of the stream have driven the level about 53 yards, and have raised about 200 tons of coal. I have sunk a pit nearly to the coal, but have discontinued it, as the work can be done for less than half the expense when I receive the blasting tools. I have put up a box of coal, which will be forwarded from Calcutta." The *Cherokee*; with the engines for pumping, winding, &c. on board, arrived at Calcutta, on May 17, and were about to be despatched to the interior at once.

ACCIDENTS IN COAL MINES.—The annual reports lately published by the Government inspectors of mines show an increase of no less than 22 per cent. in the number of lives lost from mining accidents in 1860 as compared with 1859. The quantity of coal in 1860 is estimated at 72,000,000 tons, and the proportion of deaths was from explosions from fire damp, one to each 193,347 tons raised; from falls in mines, one to each 185,567 tons; from accidents in shafts, one to each 395,604 tons; from miscellaneous accidents underground, one for each 590,164 tons; and from accidents at surface, one for each, 1,333,333 tons. The average number of lives lost for each million tons of coal raised was

15th in 1859, and 15th in 1860, the extraction of coal having rather more than kept pace with the increased sacrifice of life.

VENTILATION OF MINES.—An important system of ventilating collieries has recently been proposed by a working miner of Cambuslang. He considers the pit head to be the place for the furnace to be in use, and he provides that the air should be carried in from the bottom to the face of each mine where the pillars are formed in a systematic manner, and this is continued until the gas is drained out of the strata. He considers that the great mining error which is the cause of a number of explosions is the mode of dealing with the road heads or hrushing off long wall workings, the air being sent round the face of the workings, the road heads are not ventilated.

APPLIED CHEMISTRY.

THE BOILING-POINTS OF DIFFERENT LIQUIDS.—The laws relating to the boiling-points of different liquids at the ordinary pressure of the atmosphere have lately been investigated by Mr. Tate, and the results of his experiments are published in the *Philosophical Magazine*. He has made experiments with solutions containing the chlorides of sodium, potassium, barium, calcium, and strontium; the nitrates of soda, potassa, lime, and ammonia; and the carbonates of soda and potassa. He has found for all these salts that the augmentation of boiling temperature may be approximately expressed in a certain power of the per-centage of the salt dissolved. The salts enumerated may be divided into four distinct groups; namely, first, the chlorides of sodium, potassium, and barium, and the carbonate of soda; second, the chlorides of calcium and strontium; third, the nitrates of soda, potassa, and ammonia; fourth, the carbonates of potassa and nitrate of lime. In each of these four groups, the augmentations of boiling temperature of the solutions have a constant ratio to one another for an equal weight of salt dissolved. He has also ascertained by experiments that for an equal weight of salts, the boiling-temperatures are (approximately) in the inverse ratio of the chemical equivalents and their bases, and in the case of the nitrate of lime and the carbonate of potassa with the equivalents of the entire salts. Although the law thus indicated is not strictly true, it is sufficiently exact to warrant further inquiry, and the cases in which it is found to apply

are too numerous to be referred to accidental coincidence. Future researches may extend these laws to other substances, as it is quite consistent with analogy to suppose that the chemical composition of a substance affects the boiling temperature of its solution. It will readily be acknowledged that the prosecution of these experiments may throw additional light upon the generation of steam, the economy of fuel, and kindred questions of great practical importance to engineers.

GREEN COLOURS.—Some green colours, free from the objections which apply to the arsenical greens, are described by Elsner. The first, called "Elsner green," is made by adding a solution of sulphate of copper a decoction of fustic, previously clarified by a solution of gelatine; to this mixture is then added 10 or 11 per cent. of protochloride of tin, and lastly an excess of caustic potash or soda. The precipitate is then washed and dried, whereupon it assumes a green colour with a tint of blue. The "Tin-copper Green" is a stannate of copper, and possesses a colour which Genele states, is not inferior to any of the greens free from arsenic. The cheapest way of making this is to heat fifty-nine parts of tin in a Hessian crucible, with 100 parts nitrate of soda, and dissolve the mass when cold in a caustic alkali. When clear, this solution is diluted with water, and a cold solution of sulphate of copper is added. A reddish-yellow precipitate falls, which on being washed and dried, becomes a beautiful green. Titanium green was first prepared by Elsner in 1846. It is made in the following way.—Iserin (titaniferous iron) is fused in a Hessian crucible with twelve times its weight of sulphate of potash. When cold, the fused mass is treated with hydrochloric acid, heated to 50° C. and filtered hot; the filtrate is then evaporated until a drop placed on a glass plate solidifies. It is then allowed to cool, and when cold, a concentrated solution of sal-ammoniac is poured over the mass, which is well stirred and then filtered. The titanac acid which remains behind, is digested at 50° or 60° with dilute hydrochloric acid, and the acid solution, after the addition of some solution of prussiate of potash, quickly heated to boiling. A green precipitate falls, which must be washed with water acidulated with hydrochloric acid, and then dried under 100° C. Titanium green then forms a beautiful dark green powder.

APPLICATIONS FOR LETTERS PATENT.

Dated June 25, 1861.

- 1617. H. B. Barlow, Manchester—Knitting-machinery.
- 1618. W. E. Gedge, 11, Wellington-street, Strand—Apparatus for doubling and twisting the threads of any material by every material which can be carded or combed.
- 1619. J. Lafon, Bordeaux—Production of chromo lithographic impressions upon glass.
- 1620. L. Pierre, Niort, Deux Sevres, France—Iron Windows.
- 1621. W. Clark, 53, Chancery-lane—Apparatus for propelling vessels.
- 1622. J. Brown, Newport, Monmouthshire—Manufacture of iron.
- 1623. F. Warren, Birmingham—Machine used for cleaning cotton.
- 1624. C. Stevens, 31, Charing-cross—Nose-hand for stopping run-away horses.
- 1625. C. Stevens, 31, Charing-cross—Brick-making machine.
- 1626. A. Sacre, Brussels, Belgium—Machinery for preparing and spinning flax or other fibrous substances.
- 1627. J. Brown, 12, Upper King-street, Norwich—Window frames and blinds.
- 1628. J. Fowler, jun., Leeds—Machines for ploughing or tilling land by steam power.

Dated June 26, 1861.

- 1629. S. Wenton, Lower Rosoman-street, Clerkenwell—Ventilating apparatus.
- 1630. W. Holland, Warwick—Suspending and raising and lowering window sashes.
- 1631. J. Redfern, Hanley, Staffordshire—Apparatus for raising the temperature of air in order to warm churches, conservatories, houses, and other buildings or places.
- 1632. E. Abbotts, Lingard, Birmingham—Fastenings for jewellery.
- 1633. M. A. F. Mennons, 39, Rue de l'Echiquier, Paris—Caloric engines.
- 1634. J. R. Tussard and F. C. Tussard, Marylebone-road—Obtaining the separation of feathers, hair, or other covering from the skins of animals.
- 1635. H. A. Fletcher, Whitehaven—Railway wheels and tyres.
- 1636. H. Coulter, Philadelphia, United States—Lamps specially intended to burn oils and other inflammable fluids rich in carbon.
- 1637. J. Higgins and T. S. Whitworth, Salford—Apparatus for spinning and doubling cotton.
- 1638. S. A. Bell, Epping Villas, Stratford—Apparatus for arranging and securing splints, tapers, or matches in frames preparatory to dipping.
- 1639. A. Lion, 91, Rue de Malte, Paris—Fastening of hraelets.
- 1640. J. Cowan, Barnes, Surrey—Apparatus for reburning animal charcoal.

Dated June 27, 1861.

- 1641. D. F. Grimaldi, 60, Trinity-square, Borough, S.E.—Rotatory steam boilers.
- 1642. M. A. F. Mennons, 39, Rue de l'Echiquier, Paris—Cocks or taps for drawing off liquids.
- 1643. W. McNaught, Manchester—Steam engines.
- 1644. H. Coulter, Philadelphia, United States—Door springs
- 1645. H. Hamer, Horsford, near Leeds—Chimney tops and ventilators.
- 1646. J. C. Smart and A. Aitchison, both of Scarborough—Charcoal.
- 1647. J. Doughty, Craven-buildings, Drury-lane—Obtaining, and applying motive power.
- 1648. M. Henry, 84, Fleet-street—Construction of a certain description of castor.

Dated June 28, 1861.

- 1649. J. Gibson, Todmorden—Sewing machines.
- 1650. T. Swinnerton, Dudley, Port Tipton—A new or improved manufacture of coal gas by the surplus or waste heat of blast ovens and puddling furnaces.

- 1651. A. Ford, Suthrey House, Mortlake, Snrey—Manufacture of waterproof felt.
- 1652. J. W. Harland, Chorlton-on-Medlock, near Manchester—Manufacture of wood and other types or substitutes therefor.
- 1653. J. W. Graham, Manchester—Apparatus for cutting, shaping, and dressing stone.
- 1654. H. J. Rouse, Alexandria, Egypt—Hand lamps.
- 1655. D. B. White, Newcastle-upon-Tyne—Compressing and apparatus employed therein.
- 1656. S. Middleton and J. Wright, 42, Bridge-street, Blackfriars—Apparatus for the manufacture of hoots and shoes.
- 1657. M. Lane, Reading—Permanent ways of railways.
- 1658. C. Glashorow, Rheidol-Terrace, Islington—Pianofortes.
- 1659. J. B. Hawkins, North-street, Lincolnhouse—Construction of cocks for drawing off liquids.

Dated June 29, 1861.

- 1660. R. N. Eagle, Captain in the Cavalry of the United States of America—Riding stirrups.
- 1661. J. Dyer, Islington—Ornamentation of certain cabinet furniture.
- 1662. A. Wood, Lewes—Construction of fermenting tuns.
- 1663. W. Leopold, Hurstpierpoint, Sussex—Railway brake apparatus.
- 1664. W. Clark, 53, Chancery-lane—New locomotive apparatus having a movement resembling walking.
- 1665. W. Clark, 53, Chancery-lane—Excavating machinery.
- 1666. W. Clark, 53, Chancery-lane—Distillation of liquid and solid matters.
- 1667. I. Bragg, Hensingham, Whitehaven—Construction of reaping and mowing machines.
- 1668. A. V. Newton, 66, Chancery-lane—Lapping used in machinery for printing textile fabrics.
- 1669. W. Livesey, Park Cottages, Park Village East—Wet gas meters.

Dated July 1, 1861.

- 1671. J. H. Johnson, 47, Lincoln's-inn-fields—Apparatus for manufacturing and bottling aerated liquids.
- 1672. F. Potts, Lomhard-street, Birmingham, and R. Cox, Managing Engineer to the said F. Potts, Birmingham, aforesaid—Mode of treating tubes used for posts for metallic bedsteads and other purposes.
- 1673. J. Shepherd and W. Goodfellow, Mamchester—Improved surface screen and sediment collector for steam boilers.
- 1674. L. H. Spence, Hatton-garden—Apparatus for the manufacture of paper bags or envelopes.

Dated July 2, 1861.

- 1675. W. Barber, Stockport—Manufacture of hats.
- 1676. S. H. Gerstle, Paris—Manufacture of needle and tapestry work.
- 1677. J. P. E. Paignon, J. M. Vaudaux, and G. Gagniere, Paris—Jaquard machines.
- 1678. J. Potts, Flint-street, Old Kent-road—Machinery for sounding fog bells.
- 1679. J. G. Wilson, Rastrick, near Halifax—Apparatus employed for feeding steam boilers with hot water.
- 1680. A. Hill, Bamford Mills, Hathersage, Derby—Spinning and doubling machine.
- 1681. H. H. Bishop, Leicester-street, Leicester-square—Sewing machines.
- 1682. M. Henry, 84, Fleet-street—Pianofortes.
- 1683. S. Adams, West Bromwich—Omnibusses for street railways.

Dated July 3, 1861.

- 1684. H. B. Barlow, Manchester—Machinery for spinning.
- 1685. R. Richardson, 26, Great George-street, Westminster—Railway chair for railways.
- 1686. J. Terry, Birmingham—Manufacture of window sash pulleys, side pulleys, screw pulleys, and upright pulleys.
- 1687. J. Woollatt, Preston—Looms.
- 1689. J. Bennie and W. Moffatt, Johnstone, Renfrew, North Britain—Manufacture of heels, colg-irous, horse-shoes, chain-links, and similar articles.
- 1690. G. Davies, 1, Serle-street, Lincoln's-inn—Apparatus for grinding corn and other matters.

- 1691. C. Gilfoy, Sonthampton—Extinguishing fire in buildings or hoard ship.
- 1692. R. Jolly, 47, St. John-street, Smithfield—An air tight enclosure for heating, drying, or absorbing vapours and gases for manufacturing medical and domestic purposes.
- 1693. J. E. Spencer, Newcastle-upon-Tyne—Steam engines.
- 1694. J. Petrie, jun., Rochdale—Apparatus for washing and drying wool.
- 1695. P. Spence, Newton Heath, near Manchester—Economizing the manufacture of sulphuric acid.
- 1696. V. C. Givry, Old Bond-street—Sewing machines.

Dated July 4, 1861.

- 1697. J. Patterson, Beverly—Machinery for applying the power of horses to drive mills and other machines.
- 1698. J. Kull from Lenzburg, Canton Aargau, Switzerland, and C. A. Caspar, 1, Stanley-terrace, Studley-road, Stockwell—Level measurement on an entirely new principle called level balances.
- 1699. R. Mills, Bury—Washing, wringing, and mangling machines.
- 1700. J. M. Gale, Glasgow, and T. Kennedy, Kilmarnock, Ayr—Taps or valves.
- 1701. W. H. Ludford, Staveley, Derbyshire—Manufacture of hrooms and scrubbing brushes.
- 1702. W. E. Newton, 66, Chancery-lane—Engines for obtaining motive power.
- 1703. J. Webster, 64a, Gloucester-street, Pimlico—Compositious used for lubricating railway and other axles.
- 1704. T. Wilson and J. G. Tatters, Felling, near Gateshead-on-Tyne—Treating taur refuse or soda waste.
- 1705. M. A. F. Mennons, 39, Rue de l'Exchiquier, Paris—Construction and arrangement of apparatus for the manufacture of ice.
- 1706. B. G. Sloper, Hackney—Machinery for the amalgamating and for affecting the separation of gold from earthy and other matters containing the same.

Dated July 5, 1861.

- 1707. B. Fowler, junior, Liverpool—An improved sewer and sink trap.
- 1708. J. Hutson, Richmond—Cornices, laths, and panels for bedsteads.
- 1709. O. Williams, Dursley, Gloucestershire—Liquid for extinguishing fire.
- 1710. W. E. Gedge, 11, Wellington-street, Strand—Obtaining motive power.
- 1711. J. E. M. de Pradon and L. G. Lecoq, 4, South-street, Finsbury—Apparatus for lighting.
- 1712. R. Lakin, Ardwick, and J. Wain, Manchester—Machines used in spinning cotton, wool, and other fibrous substances.
- 1713. W. England, Wollaston Works, near Stourbridge—Manufacture of bricks.
- 1714. L. Roughton, Bedford-place, Old Kent-road—Apparatus for extinguishing fires.

Dated July 6, 1861.

- 1715. J. Dean, Derbyshire—Apparatus for propelling vessels.
- 1716. J. R. Black, 23, Summer-place, Onslow-square, and H. W. Spratt, Walbrook-buildings—Manufacture of boxes.
- 1717. R. A. Smith, 20, Devonshire-street, Manchester—Purifying gas.
- 1718. T. Wilson, Birmingham—Improvements in moveable spanners or screw wrenches.
- 1719. J. E. Reid, 20, Fleming-road, Newington—A safety window sash fastener and draught excluder.
- 1720. H. Schutt, Bradford—Spinning frames for spinning wool.
- 1721. T. Smith, 4, Bolton-place, Upper Church-street, Fulham-road—Bells.
- 1722. W. Park, Sydney, Gloucestershire—Procuring a very valuable colouring matter from iron stone.
- 1723. J. Ridsdale, 4, Stoke Newington-green—Inkstands applicable to the stoppers of bottles.

1724. L. A. Kelley, 12, Gloucester-terrace, Camden-hill Kensington, and W. A. O'Doherty, Swan-lane, Upper Thames-street—Apparatus for facilitating the process of grass edge cutting or edge cutting in general.
1725. C. Farrow, 18, Great Tower-street—Apparatus for affixing or applying capsules to the necks of bottles and other vessels.
1726. A. Noble, Bristol—Obtaining products from alkali waste and gas lime refuse.
1727. E. R. Handcock, Norfolk-street, Strand—Machinery for obtaining and applying motive power.
1728. G. Turfill, 83, City-road—Treating materials for the manufacture of banners and flags.
- Dated July 8, 1861.
1729. J. Snider, junior, 13, Rue Gaillon, Paris—Smooth-bore cannon.
1730. F. Warner, Crescent, Jewin-street, and T. Clark, Baldwin-street, City-road—Apparatus for supplying water to water closets.
1731. R. Hornsby, junior, Spittlegate Iron Works, Grantham—Machinery for washing, wringing, mangling, and churning.
1732. T. Cobby, Meerholz, Electorate of Hesse, Germany—Manufacture of fluo-silicates and silicates of lead and baryta.
- Dated July 9, 1861.
1733. T. T. Macneil, 23, Cockspur-street—Construction of barometers.
1734. T. Cobby, Meerholz, Hesse, Germany—Improved process for the treatment of silicates of metallic and non-metallic bases and other siliceous compounds.
1735. A. Priest and W. Woolnough, junior, Kingston-on-Thames, Surrey—Machinery for drilling and hoeing land.
1736. G. S. Parkinson, 10, Lambton-terrace, Kensington—Perforated materials in combination with india rubber.
1737. E. A. Penley, Cheltenham—Construction of drawing boards.
1738. F. S. Barff, Dublin—Preservation of stone.
1739. W. C. Parkinson, Cottage-lane, City-road—Frictionless bearing for gas meters.
1740. J. Keates and G. E. Keates, Leek, Staffordshire—Sewing machinery.
1741. C. Cochrane, Ormesby Iron Works, Middlesborough-on-Tees—Treatment gas in its passage from blast furnaces to the furnaces.
1742. R. Hornsby junior, Spittlegate Works, Grantham—Thrashing machines.
1743. J. German, 32, Friar Gate, Derby, and G. N. Browne, Kedleston-road, Derby—Apparatus to be used in shampooping.
- Dated July 10, 1861.
1744. T. T. Chellingworth, 12, Buckingham-street, Adelphi, and J. Thurlow, 37, Belvedere-road, Lambeth—Traction engines.
- Dated July 11, 1861.
1745. W. Cooke, 25, Spring-gardens—A wind guard for curing smoky chimneys.
1746. G. Weston, and J. Weston, Sheffield—Rotary steam engines and pumps.
1747. P. Adie, Strand—Machinery for preventing damage in railway accidents.
1748. J. Kidd, 293, Strand—Manufacture, application, and combustion of bases.
1749. J. C. B. Salt, Birmingham—Manufacture of street and other plates.
1750. J. Farron, Ashton-under-Lyne—Apparatus and fittings connected with steam engines and boilers.
1751. J. R. Cotter, Donoughmore Rectory, Cork, Ireland—Piano-fortes.
1752. T. Reeves, junior, Bratton Westbury, Wilts—Apparatus for applying salt or other materials to the roots of weeds.
1753. W. Wilkinson, Bayswater—Manufacturing and ornamenting brushes.
1754. T. G. Messenger, High-street, Loughborough—Construction of valves.
1755. H. Ashwell, New Basford, Nottinghamshire—Apparatus for washing, cleansing, scouring, getting up, dyeing, boiling, and steaming.
- Dated July 12, 1861.
1756. T. J. Smith, Queen-street, Cheapside—Photographic albums.
1757. W. B. Adams, Holly Mount, Hampstead—Locomotive engines.
1758. J. Adams, King William-street—Revolving fire-arms.
1759. S. Berchtold, 48, Frith-street, Soho—Perpetual calendars.
- Dated July 13, 1861.
1760. G. Rydell, Dewsbury, Yorkshire—Smoke consumer.
1761. P. J. De Rette, 9, Rue Guimard, Bruxelles—Wind instruments of music.
1762. C. Maschwitz, Birmingham—Taps or stop-cocks for liquids.
1763. I. Breamish, Liverpool, and N. Breamish, Egremont, Cheshire—Lubricating those parts of steam engines acted upon by the steam.
1764. J. Pickering, Clitheroe, H. Pickering, Burnley, and N. Pickering, Wingates, Westloughton—Self-acting mules for spinning cotton.
1765. L. George, Duke-street, Lincoln's Inn-fields—A mode of soldering together two or more printing type letters to facilitate the work of the compositor.
1766. F. Tolhausen, 35, Boulevard Bonne Nouvelle, Paris—Looms for weaving ribbons.
1767. T. Smith and G. Taylor, Vulcan Works, Ipswich—Horse rakes and cultivators.
- Dated July 15, 1861.
1768. T. Woycke, America-square, Minorities—Boots and shoes.
1769. E. Briggs, Castleton Mills, near Rochdale, Fearnley—Manufacture of piled fabrics.
1770. T. Walker, Otley, Yorkshire—Apparatus for polarising light, applicable to microscopes.
1771. G. Treble, Aldersgate-street—Show cases.
1772. T. Cobby, Meerholz, Hesse, Germany—Manufacture of metallic and earthy silicates or siliceous compounds of the same from the metallic and earthy bases.
1773. T. Goble, Meerholz, Electorate of Hesse, Germany—A process for preserving and indurating timber.
1774. R. Taylor and T. Price, of Ty-du-Tin Plate Works, Bassaleg—Manufacturer of tin and terne plates.
1775. J. C. Coombe and J. Wright, 42, Bridge-street, Blackfriars—Manufacture of pottery.
1776. T. Cobby, Meerholz, Electorate of Hesse, Germany—Manufacture of fluo-silicates of tin, zinc, and baryta.
1777. B. Browne, 52, King William-street—Machinery for clearing and smoothing spun thread or yarns.
1778. A. Topham, J. Topham, and J. Topham, all of St. Pierre les Calais, France—Manufacture of lace.
1779. J. H. Johnson, 47, Lincoln's-inn-fields—Apparatus for cleaning rice.
1780. J. T. Gossell, Moorgate-street—Railway carriages.
1781. W. Rigby, Glasgow—Manufacture of armour plates for defensive purposes.
1782. J. Mabson, Newcastle-upon-Tyne—Sewing machines.
1783. E. G. F. Provostais, 29, Boulevard St. Martin, Paris—Extracting the fibres from genista scoparia (broom), and their application to manufacturing paper and fabrics.
1784. W. Clark, 53, Chancery-lane—Stage scenery and apparatus.
- Dated July 16, 1861.
1785. J. Mapple, 2, Newman's-place, Kentish Town—Telegraphic apparatus.
1786. J. Coucher, Worksop, Nottingham—Stacking corn and other crops.
1787. J. S. Wells, Mount-street, Nottingham—Needle used in the manufacture of looped fabrics.
1788. J. Binkhorn, Chorley, Lancashire—Apparatus for working railway signals.
1789. R. Jones, Camden Town—Safety lamps.
1790. J. P. Gillard, Paris—Manufacture of soda.
1791. D. Holden, Thornhill-road, Bansbury—Foot and kneeling stools.
1792. C. D. Abel, 20, Southampton-buildings, Chancery-lane—Certain new alloys of silver with other metals.
1793. W. Palmer, Sutton-street, Clerkenwell—Lamps.
- Dated July 17, 1861.
1794. A. W. Harnett, 97, Gifford-street, Russell-square—Steam engines.
1795. J. H. Butterworth, Vickers Moss Mills, Rochdale—Apparatus for heating water or other fluids.
1796. J. H. Butterworth, Vickers Moss Mills, Rochdale—Apparatus for heating air.
1797. J. Parker, Ivy House, Bradford, J. Wells, and B. Wells, Bowling, near Bradford—Steam engines.
1798. J. Mason, Birmingham—Metallic pens.
1799. C. E. Redfern, 10, St. Paul's-street, New North-road, Islington—Construction of locks.
1800. Sir W. O'Shaughnessy Brooke, Westminster—Apparatus for suspending and insulating electric telegraph wires.
1801. Sir J. Hare, Hardelet Caske, Pas de Calais, France, and B. Russ, Russ-buildings, Frogmore-street, Bristol—Apparatus for heating cylinder-irons or heaters to be used for pressing the seams of garments.
1802. A. V. Newton, 66, Chancery-lane—Machinery for obtaining fibres from the stalks or leaves of fibre yielding plants.
1803. J. Trigwell, Terminus-street, Brighton—Slide valves.
1804. S. Tawell, Aldermanbury—Selvages of laces and other woven fabrics.
1805. A. Elliott, Manchester—Looms for weaving.
1806. C. West, 2, Derby-street, Parliament-street—Mode of insulating and covering wire.
1807. B. Johnson, 1, Surrey-place, Kennington-park, and W. H. Anderson, White Cottage, Stockwell-place—Pianofortes.
1808. M. E. Guaynard, 29, Boulevard St. Martin, Paris—Manufacture of shirt fronts, collars, and cuffs.
1809. J. Tillotson, Bolton—Manufacture of pawnbroker's duplicate tickets.
1810. P. Williams, Salford, and T. Parkinson, Bury—Carding engines for carding cotton.
1811. J. H. Johnson, 47, Lincoln's-inn-fields—Capstans and windlasses.
1812. G. Coles, Gresham-street West, J. A. Jaques and J. A. Fanshawe, Tottenham—Apparatus to be used for brushing and dressing cloth.
1813. J. A. Jaques, and J. A. Fanshawe, Tottenham—Apparatus for a mode of stopping, plugging, or closing inkstands, and other vessels of capacity.
1814. J. W. Rogers, Peat House, Roberts Town, Kildare—Mode of building ships and floating batteries.
- Dated July 19, 1861.
1815. R. Walker, Eccleston, near Prescott—Apparatus for stopping and packing bottles.
1816. D. Gallafant, 13, Stepney-causeway—Refrigerators for cooling liquids.
1817. R. Musket, Coleford—Manufacture of cast steel.
1818. P. Shaw, Boston, Suffolk, United States—Hot air engines.
1819. R. Laing and G. H. Cossius, Inc., near Wigan—Obtaining nitrous acid gas for making sulphuric acid.
1820. R. C. Newbery, President-street, West, Goswell-road—Manufacture of enamelled cards.
1821. W. Savory and Paul Savory, Gloucester—Winding apparatus.
1822. M. Henry, 84, Fleet-street—Production of paper pulp.
1823. R. A. Brooman, 166, Fleet-street—Propelling ships and other vessels.
1824. R. A. Rooman, 166, Fleet-street—Breech-loading ordnance.
1825. J. H. Johnson, 47, Lincoln's-inn-fields—Manufacture of ships' armour plates and other heavy forgings.
1826. W. E. Newton, 66, Chancery-lane—Apparatus for copying letters or writings and draughts.
1827. E. T. Hughes, 123, Chancery-lane—Apparatus for manufacturing woven seamless gloves.
- Dated July 20, 1861.
1828. M. Gilbert, Manchester—Boots and shoes.
1829. W. Price, Lambeth—Tools for cutting shives.
1830. R. Thatcher, Brook Mills, Oldham—Lubricating the various parts of machinery.
1831. T. Roberts and J. Dale, Manchester—Manufacture of gunpowder.
1832. John Platt and J. Buckley, Oldham—Machinery for doubling cotton.
1833. J. Cole and Jos. Cole, both of Coventry—Construction of watches.
1834. M. Henry, 84, Fleet-street—Lighting.
- Dated July 22, 1861.
1835. M. A. F. Mennons, 39, Rue de l'Echiquier, Paris—Safety locks.
1839. C. N. Kottula, Holborn—Manufacture of soap.
1837. A. Watson, Johnstone, Renfrew, North Britain—Brake apparatus for common road vehicles.
1838. J. B. Wood, Broughton, near Manchester—Manufacture of shuttle pickers.
1839. W. Hood, Railway Foundry, Reading, Berkshire—Beams and girders.
1840. W. E. Newton, 66, Chancery-lane—Engines for obtaining motive power.
1841. J. Beattie, Lawn-place, South Lambeth—Arrangements in buildings and ships with a view to the extinguishment of accidental fire therein.
- Dated July 23, 1861.
1842. C. Batty, 196, Marylebone-road—Preventing of the extension of fire in buildings.
1843. G. F. Griffin, New Adelphi Chambers—Permanent way of railways.
1844. T. Gray, 19, Hill's Cottages, Union-street, Wandsworth—Preparing flax from old materials for spinning and other purposes.
1845. N. E. Dumesnil, 12, Rue aux Loups, Sotteville-les-Rouen—Lubricating materials.
1846. R. Thompson, Charlton, Kent—Machine for cutting wood.
1847. J. H. Johnson, 47, Lincoln's-inn-fields—Forges.
1848. F. Hirschfeld, 24, Cannon-street West—Ornamenting or decorating articles of iron.
1849. W. Clark, 53, Chancery-lane—Condensation of steam in marine engines.
- Dated July 24, 1861.
1850. F. Hirschfeld, 24, Cannon-street West—Locks and keys.
1851. T. Hughes, Birmingham—An improved steam generator.
1852. F. Mills, Star Iron Works, Heywood, near Manchester—Carding cotton.
1853. J. Sidebottom, Harewood, near Mottram, Cheshire—Fire-arms and ordnance.
1854. J. Badard, 1, Rue St. Cecile, Marseilles—Turning and planing metals.
1855. H. Neville, Portsmouth—Photographic apparatus.
1856. W. E. Gedge, 11, Wellington-street, Strand—Preparation and clarification of the saccharine matters obtained from beet-root, &c.
1857. W. Cranston, 58, King William-street, London-bridge—grass-mowing machines.
1858. A. Wood, Lewes, Sussex—Apparatus employed for fermenting purposes.
1859. R. Threlfall, Bolton—Apparatus for spinning cotton.
1860. A. J. D. Seitz, Newcastle-upon-Tyne—Drying of bricks.
1861. J. Platt and W. Richardson, Oldham—Apparatus for cleaning cotton from seeds.
1862. H. Cook, Manchester—Pattern cards used in weaving figured fabrics.
1863. W. Longmaid, Inver Galway, Ireland—Manufacture of iron.
- Dated July 25, 1861.
1864. F. D. Blyth, 113, Penchurch-street—Tools.
1864. B. Brown and R. Hacking, Bury—Spinning cotton, wool, silk, and other fibrous substances.
1866. M. Klotz, 29, Boulevard St. Martin, Paris—Ornamenting tissues, papers, and other surfaces.
1867. D. Spink, Eastbourne, Sussex—Steam engines.
1868. R. Kelly, Wilden, near Stourport, and J. Shakespeare, Dudley—Manufacture of tin plates and terne plates.
1869. E. Haefley, Kearsley, Lancashire—Extracting copper from its ores.
1870. J. Simmons, Chemical Works, Wellington-lane, Battersea—Construction of buildings to enable them to withstand the action of fire.
1871. C. Robertson, Edinburgh—Sights for fire-arms.

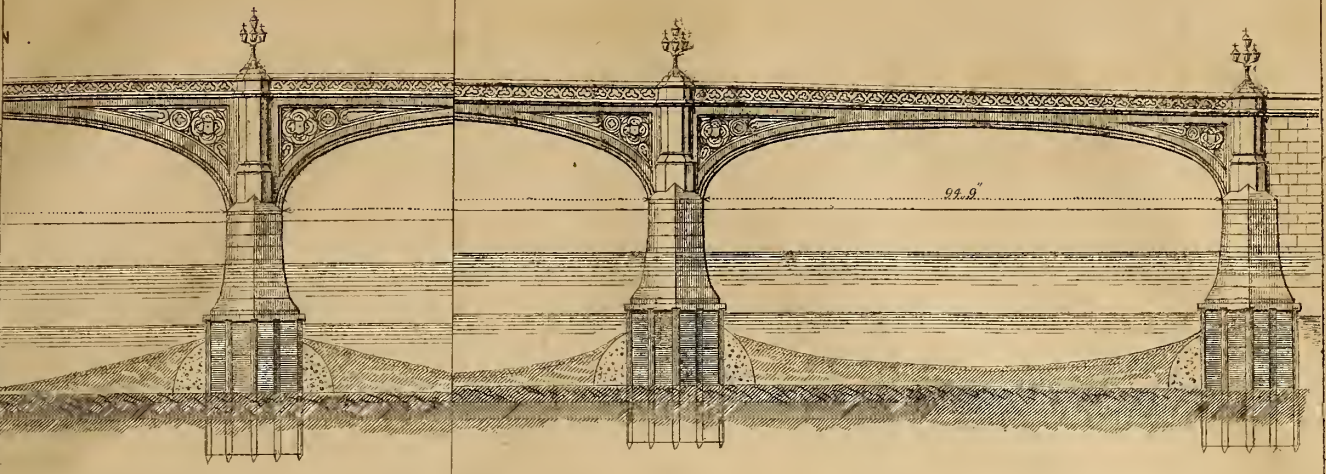

5.

SECTIONS OF
BRIDGE

Y

ESQ^R

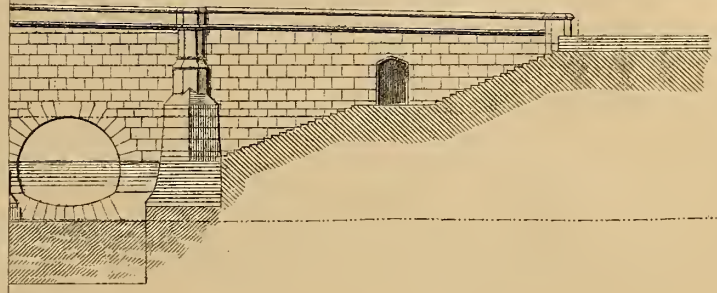

6.

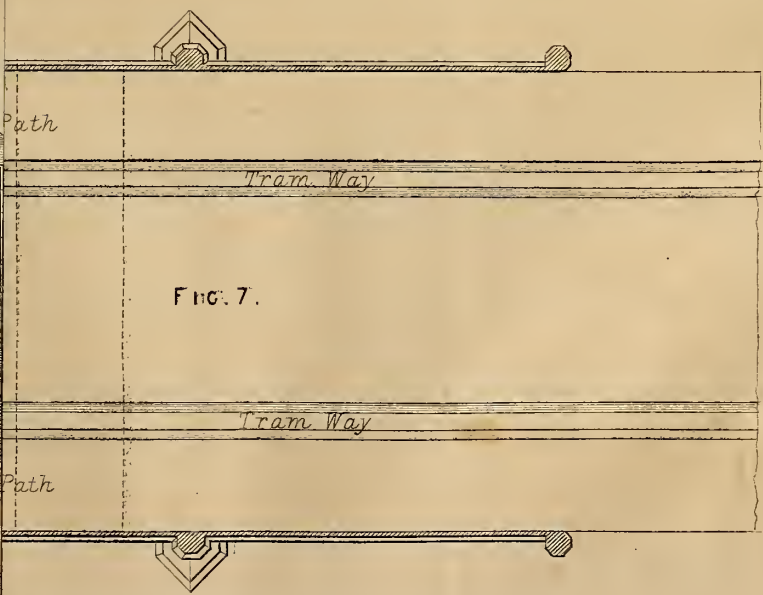
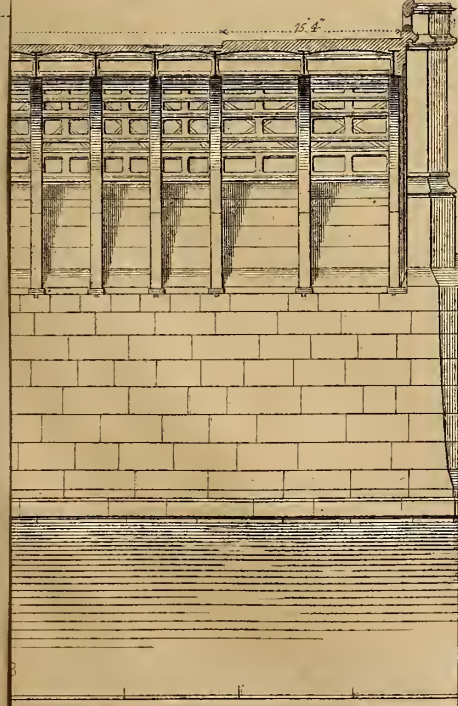
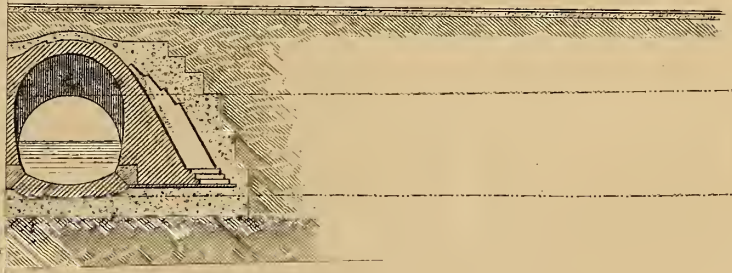

FIG. 7.

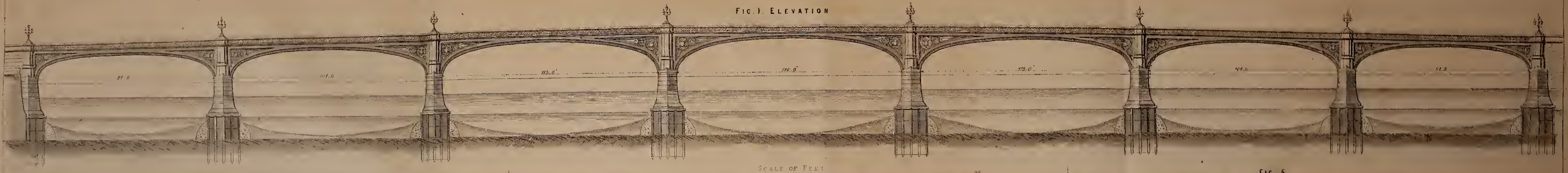

FIG. 1. ELEVATION

SCALE OF FEET

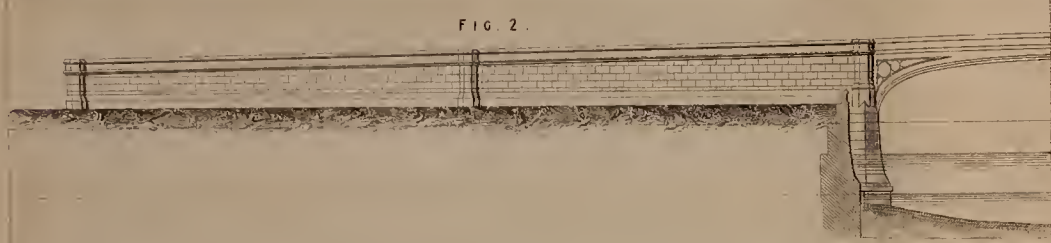

FIG. 2

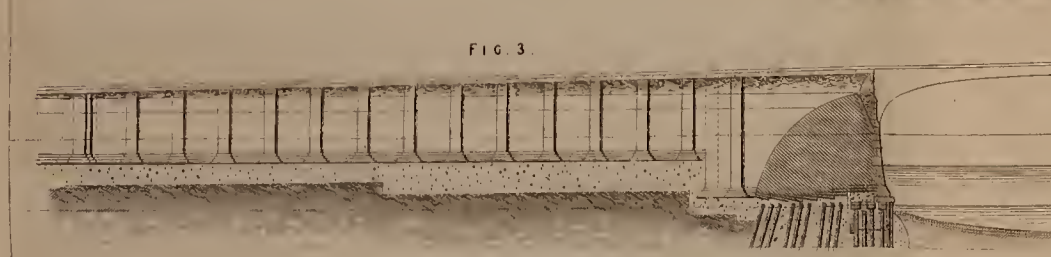

FIG. 3

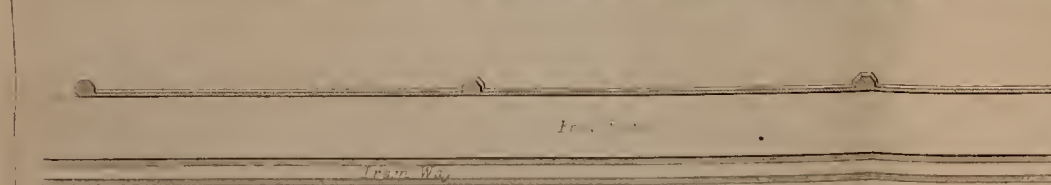
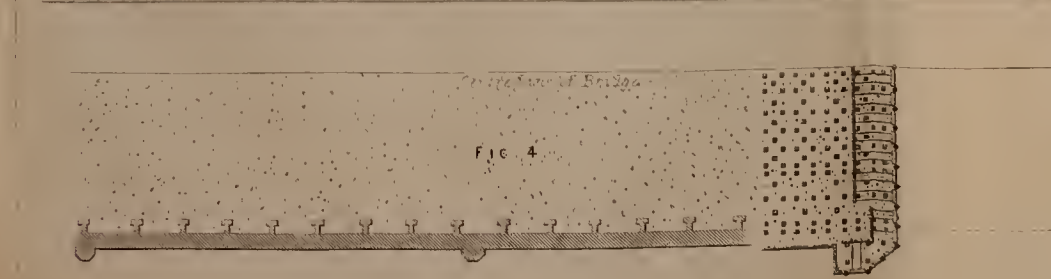

FIG. 4



ELEVATION PLANS AND SECTIONS OF
WESTMINSTER BRIDGE,

DESIGNED BY
THOMAS PAGE, ESQ^R

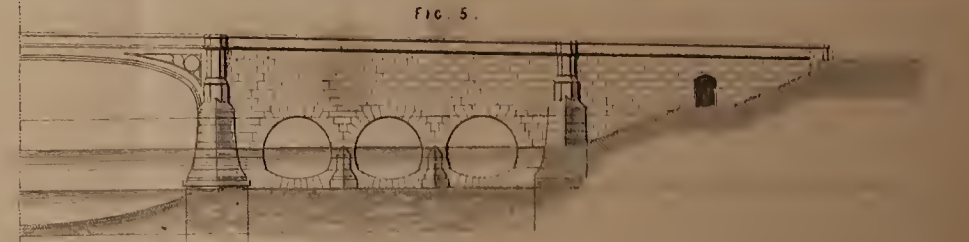

FIG. 5



FIG. 6

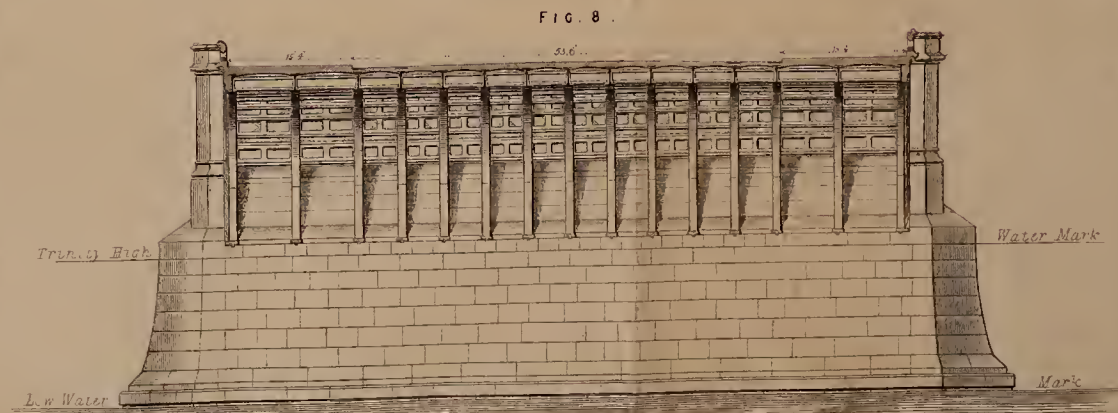

FIG. 8

Train Way High

Water Mark

Low Water

Mark

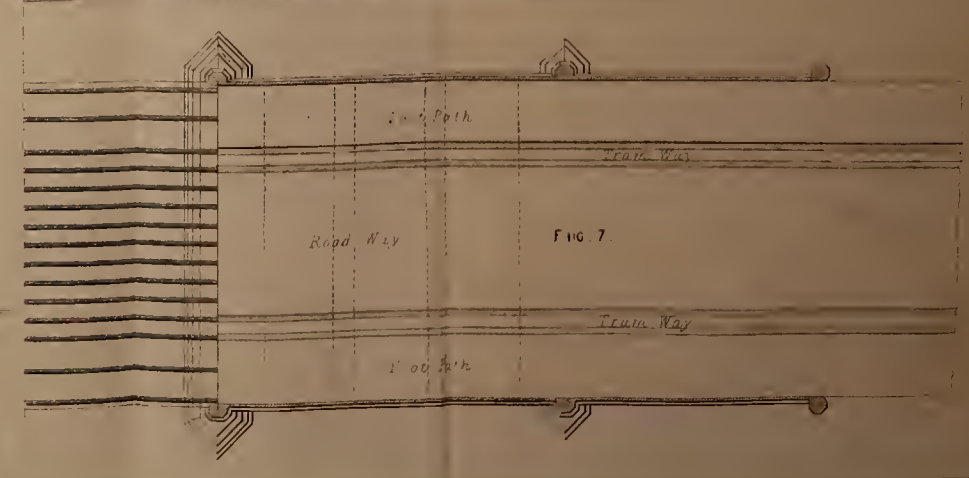
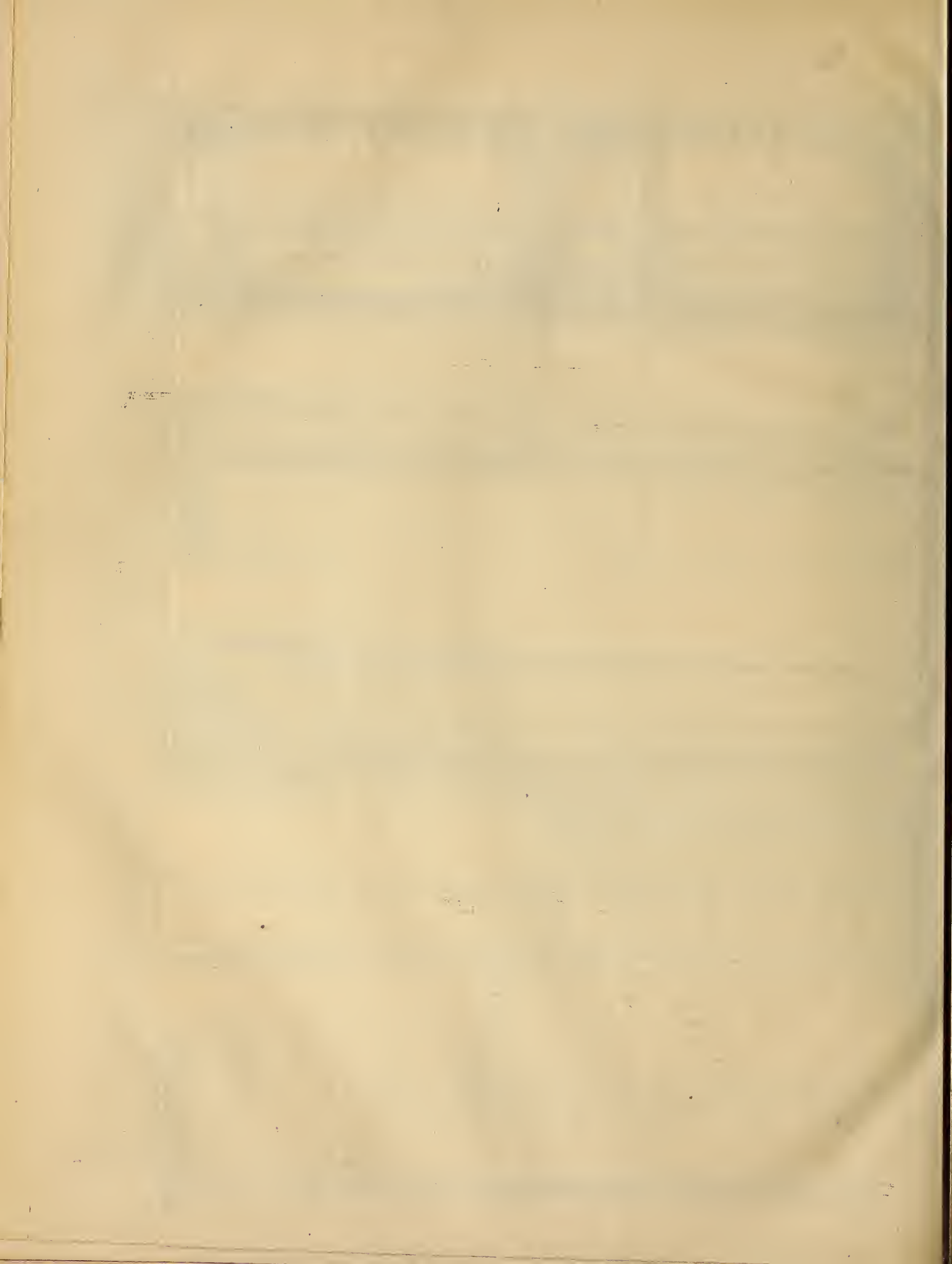

FIG. 7

SCALE TO FIG. 3



THE ARTIZAN.

No. 225.—VOL. 19.—SEPTEMBER 1, 1861.

NEW WESTMINSTER BRIDGE.

(Illustrated by Plate No. 201.)

As this magnificent structure is now rapidly approaching completion, we give with the present number the concluding plate of the series of illustrations which were promised to our subscribers.

The three plates already published, together with the present or fourth plate will form the most complete and accurate series of illustrations of the new Westminster Bridge and the details of its construction which it is possible to obtain, and we are much indebted to Mr. Page, the eminent engineer and talented designer of the bridge, for the use of the drawings and other facilities which he and his son, Mr. George Page, have, from time to time, kindly afforded us. Plate No. 150 contains thirteen views, being plans and details of the piers, piling, and other foundational parts of the structure. Plate No. 152 contains eight views of the superstructure and the details thereof, showing the roadway and the mode of supporting it, the introduction of the buckled iron plates employed for that purpose, also sections of the balustrades, &c. Plate No. 155 contains view of one span or the centre arch, one half being an external view or elevation, and the other half being a longitudinal section, showing accurately the dimensions of each part thereof, its characteristics, and the mode in which the parts were assembled and secured; besides there are eleven other figures, being details connected therewith, and most accurately drawn to scale.

The textual description and letter-press accompanying the issue of each of these plates was so ample as to render any further explanation now unnecessary.

The accompanying plate, No. 201, contains eight views: Fig. 1 showing the bridge in elevation from end to end, or the whole of the seven spans with the piers, foundations, and submerged works, clearly defined. Fig. 2 is an elevation of the abutment approach and side walls thereof on the Middlesex side, and showing part of the first arch. Fig. 3 is a sectional elevation of Fig. 2, Fig. 4 being a plan of Fig. 3, one-half being in section. Fig. 5 is an elevation of the abutment and approach on the Surrey side, showing the culverts or waterways formed therein. Fig. 6 is a sectional elevation of Fig. 5. Fig. 7 is partly a plan of the roadway over the Surrey side abutment, and also shows the arrangement of the ribs or spandrils forming the first arch on the Surrey side, being fifteen in number. Fig. 8 is a transverse elevation of a pier, showing the roadway, foot-paths, and side balustrades, as well as the ironwork forming the abutment for the arches springing therefrom; this view is to an enlarged scale.

In each of the plates, several views and details are shown with the utmost minuteness and with the greatest accuracy, having been reduced with great care from the working and other drawings supplied by the engineer, and from actual measurements of some portions of the works as they have progressed towards completion, so that we are enabled to submit, with confidence, the plates as being faithfully accurate.

With reference to the calculations of the strengths of the various parts, and certain novel arrangement of parts and dispositions of material, we may at some future time refer to them, and compare them with those employed in other bridge constructions.

With the present plate we therefore take leave of the subject, with the intention of resuming it upon some future occasion.

PRACTICAL PAPERS FOR PRACTICAL MEN.

No. 6.—COMPARISON OF GIRDERS.

In the present paper we purpose to compare the principles and the construction of the various forms of girders now in general use with a view to obtain a series of general formulæ sufficiently simple for practical purposes and sufficiently accurate for every form.

Before proceeding with the main subject of our present observations, it will be necessary to offer a few remarks upon the construction of girders as compared with the theoretical form of the same. Let us first speak of the flanges of an ordinary straight girder. The strain on either flange, supposing the girder to be discontinuous, that is to say, to be of one span only, will have its maximum value at the centre of the span, and will diminish as the ordinates to a parabolic curve, disappearing at the points of support. Theoretically speaking, the area of each ange should therefore diminish as ordinates to the same parabola being greatest at the centre of the span and nothing over the piers. If the girder be of cast iron we may diminish the area of each flange in this manner, leaving, however, a sufficient quantity of metal over and above that indicated by theory to sustain the load safely, but if the material used be wrought iron, then the flanges could not be reduced as above without incurring considerable expense, but the area would be reduced in the following manner:—Let the flanges be formed of plates, each 10ft. in length, calculate the thrust at every 10ft. for half the girder, then commencing at the centre of the girder, reduce the thickness of the plates at every 10ft. so as to make the sectional area decrease as the strain, but instead of decreasing gradually, it will decrease by steps, suffering a decrement at every 10ft. The form of one flange thus decreased would be as shown in Fig. 1.

FIG. 1.

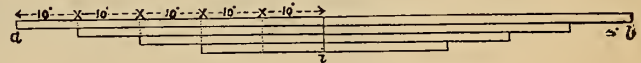

In this figure, z is the centre of the flange which is supposed to be of uniform width throughout, at the first joint 10ft. from z , no reduction in thickness is made, as that indicated by calculation is exceedingly slight, but at each of the following joints the thickness is reduced by omitting one plate, the result is that at every joint there is sufficient metal to withstand the strain to which the joint is subject, and at every other part of the flange there is an excess of material. One half only of the flange need be calculated, as the two halves should be exactly similar. If angle irons used to connect the flange to the web of the girder, or for any other purpose, run the whole length of the flange, a certain amount of sectional area will thereby be supplied, and on this account the thickness of the plate $a b$ may be proportionately reduced. Thus we see that it would in the present case be quite useless to calculate the strain on the flange of a plate girder at any point except where a joint occurs. Let us now examine the disposition of metal in the flanges of lattice and triangular web girders. In the case of a lattice girder with close lattice bars, the flanges may be treated in precisely the same manner as those of a plate girder, but when triangular webs having diagonals, far apart are used, a different course must be pursued. In this case the strain on the flanges will itself vary by sudden decrements instead of being capable of representation by the ordinates of a curve, but at every joint where two diagonals meet the flange, the strain will be quite, or nearly equal to the ordinate, to the curve of strain that would exist if the girder had a plate web, hence in designing the flange of a triangular girder we calculate the strain at every junction with the diagonals by the rule used for plate girders, and proportion each section of the flange accordingly.

From these examples we observe that in some cases we can proportion the various parts of girders according to theory, whereas in others we cannot conveniently do so, and we may say generally that plate webbed girders do not admit of being constructed in accordance with calculation as nearly as triangular girders, hence, we might reasonably expect the latter to be the more economical of the two, but we must on the other hand

remember that *theoretically* the plate girder requires less material than the triangular girder, a matter easily determined by calculation, and we find that taking all circumstances into consideration, the two forms require about equal quantities of material, but the advantage of cost is in most cases in favour of the triangular web system. It may be desirable here to insert the formula for calculating the strain at any joint on either flange of a plate, lattice, or triangular girder, for various proportions of depth to span of girder.

Let w = load per lineal foot.
 l = total span of girder.
 d = depth of girder.
 x = distance of any joint from one point of support.
 S = direct strain on any joint.

Then

$$S = \frac{w x}{2 d} \{ x - l \}$$

The depth of the girder, in order to insure the greatest possible economy, should not be more than one-eighth of the span, nor less than one-twelfth, this last being the most economical proportion; let the span be eight times the depth of the girder, then—

$$S = \frac{w x^2}{2 d} - 4 w x$$

$$= w x \left\{ \frac{x}{2 d} - 4 \right\}$$

or if W = the total load upon the girder,

$$S = \frac{W x^2}{16 d^2} - \frac{W x}{2 d}$$

$$= \frac{W x}{16 d^2} \{ x - 8 d \}$$

The load being supposed to be uniformly distributed over the whole length of the girder. Let the span be nine times the depth.

$$S = \frac{w x^2}{2 d} - 4.5 w x$$

$$= w x \left\{ \frac{x}{2 d} - 4.5 \right\}$$

$$= \frac{W x^2}{18 d^2} - \frac{W x}{2 d}$$

$$= \frac{W x}{18 d^2} \{ x - 9 d \}$$

If the span be ten times the depth.

$$S = \frac{w x^2}{2 d} - 5 w x$$

$$= w x \left\{ \frac{x}{2 d} - 5 \right\}$$

$$= \frac{W x^2}{20 d^2} - \frac{W x}{2 d}$$

$$= \frac{W x}{20 d^2} \{ x - 10 d \}$$

If the span be twelve times the depth.

$$S = \frac{w x^2}{2 d} - 6 w x$$

$$= w x \left\{ \frac{x}{2 d} - 6 \right\}$$

$$= \frac{W x^2}{24 d^2} - \frac{W x}{2 d}$$

$$= \frac{W x}{24 d^2} \{ x - 12 d \}$$

We here observe that some of the quantities are constant for all proportions; hence the general equation becomes, if the span be n times the depth.

$$S = \frac{W x^2}{2 n d^2} - \frac{W x}{2 d}$$

The strain at the centre may be found by the simple formula,

$$S = \frac{W l}{8 d}$$

Which becomes for various proportions.

When $n = 8, S = W.$
 $= 9, S = 1.125 W.$
 $= 10, S = 1.25 W.$
 $= 11, S = 1.375 W.$
 $= 12, S = 1.5 W.$

These formulæ are general for straight girders of every description having an equal depth throughout; but the last series, viz., those for finding the strain on either flange at the centre will also apply when used for arches, chains, or in fact for any kind of girder.

We will now pass on to bowstring girders. These should, properly speaking, be arches, of which the haunches are united by a tie; but in the generality of cases they act in quite another manner; for if the bowstring rib be braced to the tie, then will a portion of the strain be carried by the bracing, and the girder will act as a plate or lattice girder according to the construction of the web, but it will be much easier to calculate, for the following reasons:—

Let us suppose the arch of the bowstring to be curved in a circular segment. The moment of strain at any part of a girder is the ordinate to a parabola, but this parabola very nearly coincides with a circular arc touching its apex and its extremities. The moment of resistance at any point,

$$= a d$$

where a equals the direct resistance of the flange at that point. The moment of resistance must be equal to the moment of strain; hence it must vary as the ordinates to the parabola, or it will be sufficiently accurate if it varies as the ordinates to the circular arc. If d varies as these ordinates, the direct resistance of the flange must be constant, that is, its sectional area must be constant. In a girder with such a top flange as the arch above mentioned, the depth of the girder does vary as required; hence the sectional area of each flange will be constant throughout. It is evident, then, that in bowstring girders well braced, the sectional area of the arched rib, and also that of the tie, may remain constant throughout. It is true that sometimes the strain may be increased from the member being inclined instead of horizontal; but the arch being circular will, in some measure, make up for this, and at the haunches where the depth should become nothing, it is usually sufficiently great to withstand a much greater force than can possibly be brought to bear upon it; for although the obliquity of the top member will here be greatest, it is here that the horizontal strain altogether disappears; hence in practice we may regard the top member as horizontal at any section, provided it is of the form stated. From these remarks it appears that the flanges of the bowstring girder may be calculated by the very simple formula above stated, viz.:

$$\frac{W l}{8 d}$$

which will, if calculated for the centre of the span, give the strain on any section of either flange. If d is measured at the centre of the span, the above modifications of this formula will therefore apply in the present case.

Let us now compare the plate webbed bowstring girder, with the ordinary straight plate girder. In the bowstring rib the web will be reduced by one-third of its weight besides the saving in stiffeners; but each flange will be increased one-half *theoretically*, but not so much practically by reason of the method of diminishing the sectional area of the flanges. We will here consider the quantities obtained in practice, giving, however, only the results, as it would be useless to encumber our space with unnecessary calculations.

Let us suppose that a bridge is required to carry a single line of railway, to be 100ft. in span, and supported by two girders. We wish to ascertain whether a plate girder of the usual form, or a bowstring plate rib will be the most economical. The roadway will evidently be the same in both cases; hence we need only consider the girders, and the proportion will be obtained by comparing one plate with one bowstring girder. The weight of one ordinary plate girder will be as follows:—

In the flanges	8.00 tons.
In the web	4.00 "
In cover plates.....	1.50 "
In stiffeners	1.50 "
In rivet heads	0.54 "
Total.....	15.50 "

The weight of one bowstring plate girder will be

In the flanges	10'00 tons.
In the web	3'66 "
In cover plates	1'50 "
In stiffeners	0'75 "
In rivet heads	0'50 "
Total.....	15'41 "

From these quantities it appears that there is not any difference worthy of notice, the saving being about $\frac{2}{3}$ per cent. in favour of the bowstring girder. Both these girders might be made somewhat lighter, as they are calculated for a strain of 3'50 tons per sectional square inch, whereas the metal would safely carry 4 tons in compression and 5 tons in tension, per inch. It is unnecessary to enter into the relative weights of the braced bowstring and the plate bowstring, as it is only reasonable to conclude that they will bear the same proportion to each other as exists between the weights of the plate girder and triangular girder.

We have hitherto spoken only of the flanges of girders, let us now examine the webs.

Theoretically the triangular web is heavier than the plate web, but the latter is always made much heavier than theory would indicate—thus, in the plate girder bridge, of which we have given the quantities above, the web is, at the thickest part, $\frac{3}{8}$ of an inch in thickness, whereas, according to theory, it should only be $\frac{1}{10}$ of an inch thick at the thickest part; it must, however, be made sufficiently thick to prevent it from buckling, and in the diagonals very little excess of material is required for this purpose. The weights of the theoretical and practical webs for the plate girder, will be as follows, for the girder of 100 feet span mentioned above:—

In theoretical web	0'8 tons.
In practical web	4 "

hence the web, as actually constructed, is five times the weight of the calculated web.

Taking all these points into consideration, we decide in favour of the lattice or triangular system; the latter being superior in many ways to the former.

We have yet to notice arches and chains as compared with girders. In this case the arch and the chain have evident advantages, as the bottom flange in the one case and the top flange in the other, is entirely dispensed with, as also stiffeners, the chain or arch, as the case may be, doing the duty of the web and one flange. So great, indeed, is the economy of the suspension chain, that it will allow a stiffening girder to be added to the roadway or platform and will even then be far lighter than a girder.

So far as metal is concerned, we observe the very great superiority of arches and chains over girders, but (for we treat of single spans) we must not overlook the very important fact that some means must be provided to withstand the thrust of the arch and the pull of the chain; in the first case massive masonry usually is applied, and in the latter the chains are carried over high towers and anchored under a plate which is weighted down with masonry. These appliances are necessarily costly, and will, therefore, materially interfere with the application of arches and chains to single spans where considerable economy is required and appearance is not a prime consideration. We must now pass on to compare the values of the different forms of girders when applied to cross obstacles in several consecutive spans.

(To be continued.)

NOTES ON THE CONSTRUCTION OF ENGINES AND MACHINERY;
MORE PARTICULARLY MARINE ENGINES.

(Continued from page 179.)

BOILERS.

Supposing we have a marine engine, the cylinder being 50in. diameter; stroke, 80in.; steam cut off at $\frac{1}{2}$ stroke; revolutions, 20; $7\frac{1}{2}$ lbs. water (raised from 100° to 260°) evaporated per lb. of coal; pressure, 20lbs. on the square inch; the specific volume = 726;—what is the area of the fire-grate required in square feet?

- Let d = diameter of cylinder in inches.
- a = area of cylinder in square inches.
- s = stroke of piston under which steam is fully admitted, in inches.
- r = revolutions or double strokes per minute.
- p = pressure of steam in lbs. per square inch.
- k = the specific volume or cubic feet of steam from 1 cubic foot of water.
- x = number of lbs. of water raised from 100° to the temperature corresponding to the steam pressure, and evaporated per 1 lb. of coal, per hour.
- R = rate of combustion, or number of lbs. of coal burned per hour per square foot of fire-grate.
- h = proportion between grate surface and heating surface.

Before the RULE is laid down, it might be useful to show, by an example worked out in full, how we have obtained the rule.

- Let d = 50 inches.
- a = 1963'5 square inches.
- s = 40 inches (stroke of piston 80 ins. cut-off at $\frac{1}{2}$ stroke = 40 inches).
- r = 20 revolutions.
- p = 20 lbs. on the square inch.
- k = 726.
- x = 7'5.
- R = 20 lbs. of coal per square foot of fire-grate.
- h = $\frac{1}{30}$.
- $1963'5 \times 40 \times 2 = 157,080$.
- $157,080 \times 20 = 3,141,600$ cubic inches per minute.
- $3,141,600 \div 1728 = 1818'05$ cubic feet per minute.
- $1818'05 \times 60 = 109,083$ cubic feet of steam per hour.
- $109,083 \div 726 = 150$ cubic feet* of water to be evaporated per hour.
- $150 \times 64'2 = 9630$ lbs. of sea water.
- $9630 \div 7'5 = 1284$ lbs. of coal consumed per hour.
- $1284 \div 20 = 64'2$ square feet of fire-grate surface.

Collecting this into a formula, we get:

RULE FOR THE AREA OF THE FIREGRATE.

$$\frac{a \times 2s \times r \times 60 \times 64'2}{1728 \times k \times x \times R} = \frac{a \times s \times r}{k \times x \times R} \times 4'4583 = \text{area of fire-grate.}$$

Applying the formula in our case, we get:

$$\frac{1963'5 \times 40 \times 20}{726 \times 7'5 \times 20} = \frac{78540}{5445} = 14'4$$

$$14'4 \times 4'4583 = 64'2 \text{ square feet of fire-grate surface.}$$

$$h = \frac{\text{grate surface}}{\text{heating surface}} = \frac{1}{30}, \text{ consequently } 1284 \text{ sq. ft. of heating surface.}$$

THE CHIEF FEATURES OF THIS BOILER.

Say the coals are of such quality as to evaporate 12'5 lbs. of sea water per hour, the efficiency of boiler '67; then $12'5 \times '67 = 8'37$ lbs. of water evaporated per 1 lb. of coal per hour.

THE ECONOMIC VALUE or lbs. of water evaporated from and at 212° by 1 lb. of coal.....	8'37 lbs.
RATE OF COMBUSTION or lbs. of coal burned per hour per square foot of fire-grate	20'00 "
RATE OF EVAPORATION per hour per square foot of fire-grate in cubic feet of water from 100°	2'31 cub. ft.
TOTAL EVAPORATION per hour in cubic feet of water from 100°	150'00 "
RATIO OF HEATING SURFACE TO RATIO OF COMBUSTION ...	1'5 to 1
RATIO OF HEATING SURFACE TO GRATE SURFACE	30 to 1
RATIO OF EVAPORATION TO HEATING SURFACE in cubic feet of water per square foot of heating surface	1 cub. ft. to 12'84 sq. ft.

After having shown how to find the area of the grate surface, which is the first step to be taken in designing a boiler, we will now show how to find the areas of the other passages for the gases in accordance therewith.

Mr. Charles Wye Williams allows for the area over the bridge 2'4 square inches for each square foot of grate surface, but does not mention anywhere how many lbs. of coal are to be burned per square foot of grate, which evidently must make a very great difference.

Returning to our own example above, we will see that the rate of combustion is taken into account in calculating the grate surface, and it is equally necessary to take it into account in calculating the passages the gases have to pass through from the grate to their escape from the chimney.

RULE FOR THE AREA OVER THE BRIDGE.

Multiply the rate of combustion by the area of the grate in square feet and this product (which is the number of lbs. of coal burned per hour on the grate) by the co-efficient 1'75; the result is the total area of passage over the bridge, in square inches.

Thus $20 \times 64'2 = 1284$ lbs.
 $1284 \times 1'75 = 2247$ square inches.
 $\frac{2247}{144} = 15'6$ square feet.

* In practice we must add to this result from $\frac{1}{15}$ to $\frac{1}{10}$ part for blowing off, waste, &c.

RULE FOR THE AREA OF THE CALORIMETER.

Multiply the rate of combustion by the area of the grate in square feet, and this product by 1.625; the result is the total area of the calorimeter in square inches.

$$\begin{aligned} \text{Thus} \quad & 20 \times 64.2 = 1284 \text{ lbs.} \\ & 1284 \times 1.625 = 2086 \text{ square inches.} \\ & \frac{2086}{144} = 14.5 \text{ square feet.} \end{aligned}$$

RULE FOR THE AREA OF THE CHIMNEY.

Multiply the rate of combustion by the area of the grate in square feet, and this product by 1.05; the result is the area of the chimney in square inches.

$$\begin{aligned} \text{Thus} \quad & 20 \times 64.2 = 1284 \text{ lbs.} \\ & 1284 \times 1.05 = 1348 \text{ square inches.} \\ & \frac{1348}{144} = 9.36 \text{ square feet.} \end{aligned}$$

The openings for air admission through the door should be about 4 square inches per square foot of firegrate.

The space above the fire-bars should be at least 2ft. to 2ft. 6ins. high from the top of the fire-bars to the roof, at the middle of the grate.

The dimensions of the combustion chamber should be as ample as possible, remembering that the flame is between 30ft. to 40ft. long. In multitubular boilers the space in the combustion chamber from the bridge horizontally to the inner shell of the water space should be at least 3 to 4ft., and it may be made much longer if convenient, the distance from the end of the tubes horizontally to the inner shell of the water space should never be less than from 20in. to 24in.

The tubes should never be less than 3 to 3½ in. inside diameter, and not longer than 5ft. to 6ft., rather allowing some space for the run of the inflamed gases before entering the tubes, than making the tubes from 6ft. to 7ft., as is usually done.

A steam jet should always be provided in the chimney for regulating the draught.

Particular care should be taken in the construction of boilers that there is sufficient space for the circulation of the water, which, in respect to the tubes, will be obtained by keeping them at a proper distance from each other, and by not having too many rows of tubes above each other, because the large number of steam bubbles, that ascend to the surface of the water, will make it almost impossible for the water to be maintained in close contact with the upper rows, and replace the ascending current of steam bubbles, so that the tubes will then be surrounded with a bath of steam instead of water, whereby the efficiency of the tubes will be very much reduced, and their strength much impaired by rapid corrosion.

The writer, in concluding the subject, hopes that his "Notes on the Construction of Marine Engines" may be considered worthy of attention, as they are the result of many years' experience, careful thought and calculation, and as evidence, wherever he has applied these rules in practice, they have been found to give very satisfactory results.

[The subjoined note on Cranks was by mistake omitted in the last number, and should follow the article "CRANKS."]

NOTE.—The area obtained by this rule will be rather in excess, and it will therefore be better in practice to add to r half of the length of $o. p.$ (see Illustration of Cranks), which will be better understood by referring to the following example.

Using the same example as above, and taking the half of $o. p.$ as equal to 3ins., we get

$$\begin{aligned} \text{Area} &= \frac{93,291 \times 27}{9 \times 4500} \\ &= \frac{2,518,827}{40,500} \\ &= 62.2 \text{ sq. in. nearly.} \\ 62.2 \div 6 &= 10.37 = 10\frac{3}{8} \text{ in.} = n p. \end{aligned}$$

If the half of $o. p.$ be taken as equal to 2½ in., we get

$$\begin{aligned} \text{Area} &= \frac{93,291 \times 27}{8.5 \times 4500} \\ &= \frac{2,518,827}{38,250} \\ &= 65.85 \text{ sq. in.} \\ 65.85 \div 5 &= 13.17 = 13\frac{1}{8} \text{ in.} = n p. \end{aligned}$$

GAS LIGHTING.—ON SOME RECENT IMPROVEMENTS IN PUBLIC LIGHTING BY THE USE OF REGULATORS, AND MORE CONVENIENT MODES OF LIGHTING AND EXTINGUISHING THE LAMPS.

(Continued from page 183.)

I.—REGULATORS FOR STREET LAMPS.

Soon after the introduction of gas for lighting purposes it was found essential to have some means of regulating the pressure, and of keeping this uniform, independently of the gas holders and of the draught on the mains. The governor was accordingly designed to answer this purpose. It consists essentially of a small gas holder with an inlet and outlet pipe. The inlet pipe is provided with a cone, which rises with the gas holder as the pressure of the gas increases and on the contrary falls when the pressure of the gas decreases. The rise of the cone checks the passage of the gas, while the falling of it opens a freer passage; and thus the rise and fall of the cone regulates the admission of gas, inversely as the pressure; admitting less gas as the pressure increases, and more gas as the pressure decreases.

When a governor acts properly the volume of gas which it admits to pass from a gas holder to a main, should be uniform and invariable, whatever be the pressure on the holder, and whatever be the draught on the main.

The governor is particularly described and shown by a drawing in my treatise on gas works, published in Weales' Rudimentary Series, page 230.

Smaller instruments on the principal of the large governor have long been used to regulate the pressure of gas in large buildings. These require to be applied on each floor where the building is extensive, and so long as they are in order, and are properly attended to, there is no doubt they effect the desired end.

In hotels and large buildings of a public character where it is difficult to exercise a minute control over the servants, it is possible that these regulators may afford the best means of producing a uniform pressure on the gas, and thus regulating the consumption so as to prevent waste on the one hand, and an insufficient supply on the other.

It is perfectly within the power of any private consumer, however, to regulate his own supply of gas without the use of the special instrument called the regulator.

The great mistake made by private consumers is that of attempting to regulate the gas at each individual burner by partly closing the tap so as to check the passage of the gas, to reduce the pressure and form a flame of the required size. Now gas never burns properly under these circumstances. The current of gas being impeded by the partial closing of the tap is deflected against the side of the pipe and issues in an irregular manner; the consequence is an irregular jagged flame which gives much less than the proper quantity of light.

The best method is to have all the taps of the individual burners turned full on so as to interpose no obstacle to the passage of gas near the point of combustion, and to effect the regulation at the meter. The gas has then time to recover itself before coming to the burners, and the flames are always regular and uniform in outline.

The regulation at the meter will serve for the supply of gas on the same floor, and on the floor above it. Thus if the meter be placed as usual in the basement, the regulation, by means of the meter cock, will regulate the pressure on the basement, and on the ground floor immediately above it.

In large buildings, however, where the gas has to be burnt on several floors in succession, there should be a regulating cock on each floor, and by means of these, and regulation at the meter, the most perfect uniformity of burning can be attained.

Should the pressure vary during the hours of burning, this may be adjusted, either at the meter, or by means of the regulating taps on each separate floor.

The advantages of this practice will at once be obvious in a variety of cases, where it is otherwise impossible to control the carelessness and inadvertence of persons to whom the use and management of gas are entrusted. Thus, suppose the master of an establishment trusts to the mere regulation at the burners, it is evidently in the power of any inmates of the rooms having access to the burners to waste the gas to an almost unlimited extent. But supposing the taps at the burners turned full on and the supply adjusted from an independent source, it is evident that no more gas can be had than that which is intended, and for which the pressure is adapted. Consumers of gas would effect a great saving by a little attention to this matter.

These things are generally managed better in the North of England than elsewhere in this country; but even amongst the knowing natives of the North I have frequently been in public rooms where a perpetual annoyance was caused by gas roaring and hissing through the burners, and the comfort of the guests continually interfered with by efforts of their own and those of the attendants to adjust the supply of gas by

means of the burner taps. Now this could have been effected at once at the meter, and, the burner taps being fully open, the gas would have burnt in peace and quietness with, at the same time, a large increase of illuminating power.

It is not unusual to hear complaints of the trouble and inconvenience occasioned by having to resort to the meter for the purpose of adjusting the supply of gas; and it must be confessed there is some justice in this complaint when the operator is obliged to resort to the debased locality in which the meter is commonly fixed.

By a very simple contrivance, however, the power of acting on the meter can be transferred to any part of the house, and there might be a dial, ornamental or otherwise, fixed in the most handsome dining-room or study, or any other part of the house, showing at a glance the degree to which the inlet of the meter was opened, and affording the means of regulating the supply by applying a key to an opening in the dial, just as simply as we turn the hands of a watch.

A contrivance of this kind is common in Leeds and other towns in the North of England. The dial and other apparatus can be procured from Carnaby, of Skinner-street, Snow-hill, London.

Let us return from this digression to the subject of regulators for street lamps. These, again, are still smaller affairs than the regulators which have been spoken of for rendering the pressure uniform in large buildings. The regulators for street lamps are, in fact, miniature governors applied to single lights. Like their larger prototypes they are all based on the original idea of the governor, and, with trifling modifications, they may all be described as miniature governors applied to single lights.

Like the great station governor employed to regulate the pressure of gas into mains of the largest capacity, these miniature instruments all embrace the fundamental principle of a gas-holder provided with an inlet and an outlet pipe, the former being furnished with a moveable cone acted on by the entering gas, just as in the larger machine.

In some of the regulators, however, such as Sugg's, and Paddon's, and Ford's, the gas-holder is of the dry form, with flexible sides, such as have been made on the large scale for exportation and use in our colonies, and foreign countries. In others, such as Clybran's mercurial regulator, the holder is of the ordinary bell shape, and works in mercury instead of water.

Fig. 1 is a full-sized representation of the regulator designed and manufactured by Mr. William Sugg, of Marsham-street, Westminster. This regulator was first adopted by the Chartered Gas Company in the Westminster district, comprising the parishes of St. Margaret and St. John the Evangelist. It has since been largely adopted by the Imperial, the Western, and other companies.

DESCRIPTION OF SUGG'S GOVERNOR.

A is the inlet pipe which screws on to the service pipe of the lamp or lantern.

B is the conical inlet chamber.

C is the half round ball-valve attached by a spindle to the top of the gas-holder, and which rises and checks the passage of the gas when the pressure increases, and, on the other hand, falls and admits more gas when the pressure diminishes.

D is a metal disc forming the top of the miniature gas-holder.

E is a flexible leathern cylinder enclosing the gas holder.

F is the outlet tube proceeding from the interior of the gas holder, and conveying the gas to the burner.

G G are leaden balance weights to regulate the pressure of the gas, so that when a given burner is used, a fixed volume of gas shall pass at all pressures exceeding the initial pressure with the regulator removed.

H is the screwed pipe to attach the burner on the adapter.

I the tinned external case of the regulator.

These regulators are sold at the price of 3s. each.

PADDON AND FORD'S REGULATOR.

Fig. 2 shows the regulator manufactured by Messrs. Paddon and Ford. These were first adopted in London by the Imperial Company for keeping down the pressure in the elevated parts of their district about Paddington and Hampstead Heath, and they have since been largely introduced in other parts of the metropolis.

DESCRIPTION.

A is the inlet which screws on to the service pipe of the street lamp.

B is the conical valve, formed of magnetized steel, which rises and checks the passage of the gas when the pressure is increased, and, on the

other hand, falls and admits more gas when the pressure diminishes. This cone is attached by a spindle to the top of the dry gas holder.

C is a soft iron case that attracts the cone and keeps it in its place.

D is a metal disc forming the top of the miniature gas holder.

F is the soft flexible leather forming the side of the gas holder.

G is the external case of the regulator.

H is the screwed pipe to attach the burner or adapter.

I is the screwed cone or adapter for the burner.

K is the burner.

L is the inlet pipe leading from the interior of the gas holder to the burner.

FIG. 2.

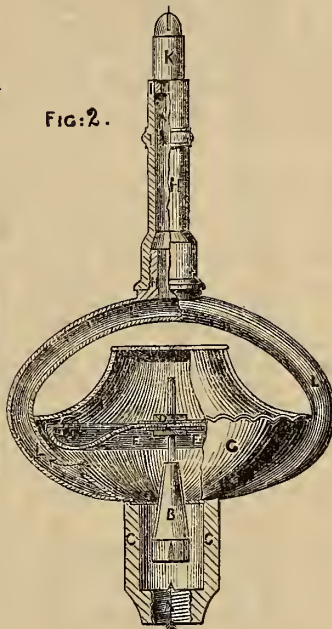
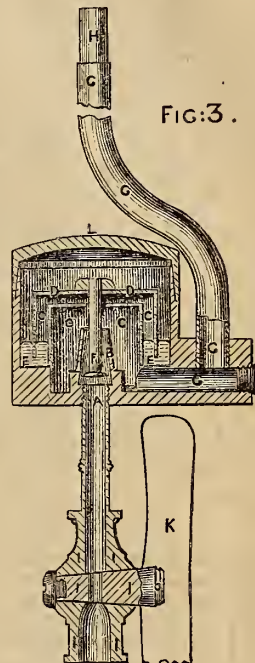

FIG. 3.



CYBRAN'S MERCURIAL REGULATOR.

Fig. 3 is a sectional view of this regulator, as used in Bolton and some other Lancashire towns, with the peculiar form of tap adopted where the lamps are lighted by means of the lantern rod, without the aid of a ladder.

A is the socket for attaching the regulator to the screw of the stop cock.

B the conical inlet for the gas.

C C spaces filled with gas when the regulator is in action.

D the bell of the miniature gas holder.

E annular space containing the mercury in which the gas holder works.

F valve and spindle attached to the gas holder, which falls and admits more gas as the pressure decreases, and, on the contrary, rises and checks the passage of the gas as the pressure increases.

G outlet for the gas conveying it to the burner H.

I the stop cock screwed to the service pipe.

K the lever of the stop cock acted on by the hook of the lantern rod for turning the gas on or off.

L moveable cover which is taken off when the mercury has to be added or replenished.

GENERAL REMARKS ON REGULATORS.

The use of these instruments has given rise to some difference of opinion as to whether they are advantageous or otherwise for the public lighting.

In the first place they produce an almost perfect uniformity of flame, which is a great improvement on the old system, under which the flame, in some cases, varied during the course of the night, from 5ft. an hour down to 1½ and 2ft.

2nd. The gas burns with a more uniform and steady light in consequence of the cock being fully open, and the passage for the gas being an annular one, formed of smooth and accurately turned surfaces. There is a considerable increase of illuminative power from this cause alone, even when the same quantity of gas is burnt. On the other hand, the system

of using regulators is liable to considerable abuse. If the regulator be so adjusted that it cannot pass the full quantity of gas at the minimum pressure, it is evident the public is defrauded of the proper quantity of light.

2nd. If the burners are too small, the use of the regulator interposes an obstacle to the passage of the gas which no adjustment of the taps can overcome.

3rd. If the regulator, from any cause, be out of order, so that the cone does not freely descend as the pressure of the gas decreases, it is evident the proper quantity of gas cannot pass.

All these sources of error render it absolutely necessary that local authorities should have the regulators examined, properly adjusted, and fitted with suitable burners before being used.

Local authorities should be as accurately informed as the companies themselves relative to the pressure which prevails in the district under their control, and for this purpose registering pressure gauges should be kept at work in several parts of the district. The registration on the pressure-sheets will at once show to any surveyor of ordinary intelligence, how the regulators should be adjusted, and then the whole, or a certain portion, of the regulators should be tried, with their appropriate burners, before being placed on the public lamps.

It is an essential condition of the regulators that when they are used the taps beneath them are to be fully open. The regulators are all constructed to act on this principle, and if the tap be not fully open, it is quite certain that at some part of the night the proper quantity of gas will not pass. This condition of having the taps always turned on is one of the chief arguments in favour of the regulators. The sight of the tap full on satisfies the passer-by that justice is being done, and prevents a great deal of the dissatisfaction which has hitherto prevailed in consequence of the taps being at half cock, or something like it.

When local authorities burn by meter, as they invariably should do, I recommend the use of the regulator in all cases, as it will contribute greatly to the saving of gas, will give a better light with the same quantity, and prevent the irregularity arising from the judgment of the lamplighter, however skilfully this judgment may be exercised.

CONTRIVANCES FOR LIGHTING AND EXTINGUISHING PUBLIC LAMPS WITHOUT THE USE OF LADDERS.

The practice of lighting by means of wands has been long practised in lofty rooms, where chandeliers and oil lamps have been lighted by means of a small taper affixed to the end of a long and slender wand. It has also been easy to apply the same principle to lofty interiors lighted with gas, as it was only necessary to add a small hook or projecting arm to act on the lever of the tap so as to turn on the gas.

In the open air, however, it becomes necessary to have a lantern at the end of a rod, so contrived as to burn in strong currents of wind and rain, and yet to be perfectly efficient when required for lighting a gas flame.

An apparatus of this kind has been used for some years in Paris for lighting the street lamps and does not differ materially from that shown in Figs. 4 to 8, which represent the apparatus used in Manchester at the present time.

Fig. 4 is the elevation of the lamp and jointed rod.

Fig. 5 is the elevation of the jointed rod and lantern complete with its perforated cap.

Fig. 6 is a section of the rod and lantern with the cap on, showing the wick and oil case.

Fig. 7 is an elevation of the top piece used to replace the lantern when the lamps are being extinguished.

Fig. 8 is a section of the top piece.

The following description will render the figures more intelligible.

A is the lower joint of the rod, made of deal 3ft. long, by 1½ in. diameter.

B is the upper joint of the rod, made of deal 3ft. long, by ¾ in. diameter.

C is the clip for attaching the separate joint of the rod, and keeping them together in one piece.

D is the lamp.

E is the clip for attaching either the lamp or the tap piece to the upper rod.

F is the oil case or reservoir for the oil and wick.

G the wick.

H the perforated cap with openings for ventilation and for ejection of the gas.

I spring to attach the cap and keep it in its place.

K perforated dome-like space through which the gas passes, in order to be ignited by the flames of the lamp,

L hook for opening or closing the top of the gas lamp.

M top piece with hook for extinguishing the lamps.

The mode of using the apparatus is so simple, as scarcely to require description. The wick being trimmed, and the lamp properly supplied with oil, the lamplighter goes forth with his jointed rod, and when he comes to a lamp, turns the tap on the service pipe by pressing it upwards with the hook L. The top of the lantern is then pushed up, and opens a

small hinged glass plate in the bottom of the public lamp. At the same instant the issuing gas enters the perforations at K and becomes ignited. The rod is then withdrawn, the small hinged plate shuts down, and the cock, if necessary, is adjusted by a touch of the hook L.

In the morning the lamplighter goes out without the lantern, in place of which he has the top piece M at the end of his rod. In extinguishing the lamp of course there is no necessity for the rod to enter the street lamp at all, but merely for the hook to act on the tap which turns off the gas.

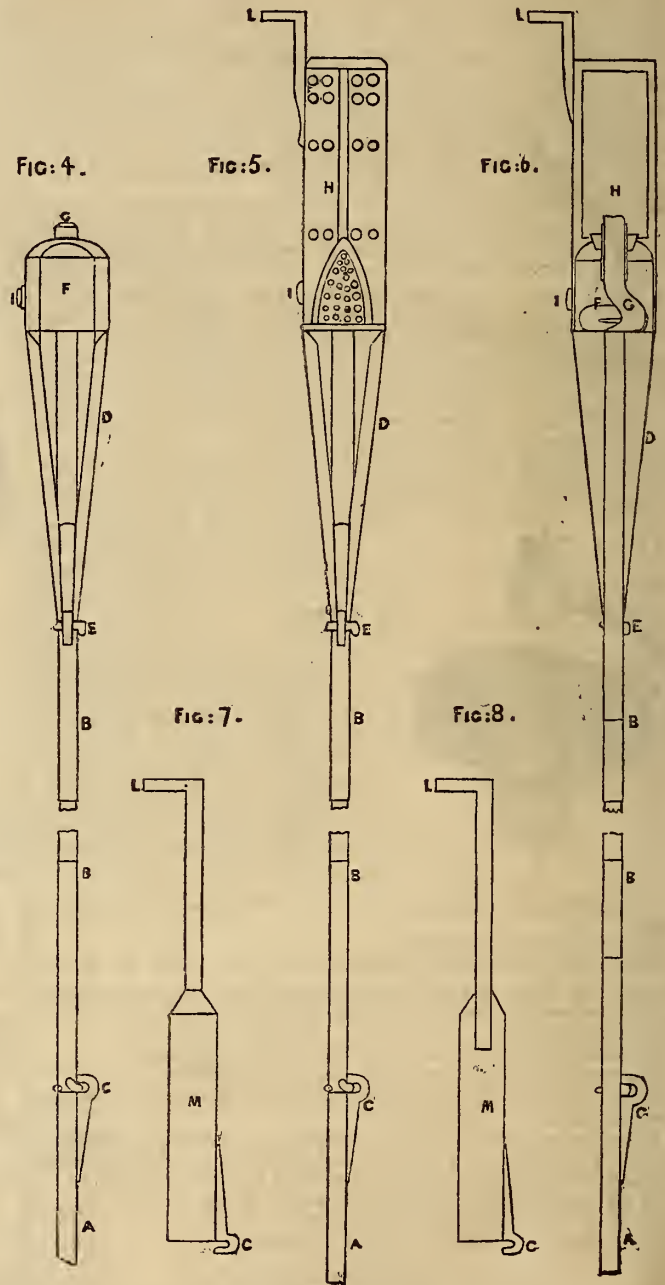

The whole apparatus is certainly simple and convenient, costing but a few shillings, while the alteration to the cock of the public lamp and putting a hinge to the glass bottom of the lamp, costs less than a shilling.

The saving is measured by the fact that the lamplighter, with less fatigue, and in the same time, lights 120 lamps in place of 100, and there is no necessity for a large stock of ladders, as these are only required for cleaning, so that one ladder is sufficient for the use of several lamp-lighters.

TABLE OF THE PROPERTIES OF SATURATED STEAM.

CALCULATED BY L. O.

In examining the existing Tables of the Properties of Steam we find that very few of them are correct, some because they are calculated from formulæ, based upon bygone and inaccurate experiments, and some because they are calculated from formulæ for steam in a gaseous state, which of course will not apply to saturated steam, generally used in practice. Having long felt the want for more correct Tables for the Properties of Saturated Steam, the Author has thought that the accompanying Table, calculated by him, according to the newest and the best authorities upon steam, might be considered useful. In respect to the columns three and four the author is indebted to Mr. D. K. Clark for the use of his formulæ.

Atmosphere included.		Temperature of Steam.	Specific Volume.	Number of Atmospheres.	Atmosphere excluded.	
Pounds per Sq. Inch.	Inches of Mercury.				Inches of Mercury.	Pounds per Sq. Inch.
Lbs.	Inches.	Fahr.	Sp. Vol.	Atmos.	Inches.	Lbs.
1	2.0355	102.1	20582	.068	-27.886	-13.7
2	4.0710	126.3	10721	.136	-25.851	-12.7
3	6.1065	141.6	7322	.204	-23.815	-11.7
4	8.142	153.1	5583	.272	-21.780	-10.7
5	10.178	162.3	4527	.340	-19.744	-9.7
6	12.213	170.2	3813	.408	-17.709	-8.7
7	14.249	176.9	3298	.476	-15.673	-7.7
8	16.284	182.9	2909	.544	-13.638	-6.7
9	18.320	188.3	2604	.612	-11.602	-5.7
10	20.355	193.3	2358	.680	-9.567	-4.7
11	22.391	197.8	2157	.748	-7.531	-3.7
12	24.426	202.0	1986	.816	-5.496	-2.7
13	26.462	205.9	1842	.884	-3.460	-1.7
14	28.497	209.6	1720	.952	-1.425	-0.7
14.706	29.922	212.0	1642	1.000	+ 0.000	+ 0.0
15	30.533	213.1	1610	1.020	0.611	0.3
16	32.568	216.3	1515	1.088	2.646	1.3
17	34.604	219.6	1431	1.156	4.682	2.3
18	36.639	222.4	1357	1.224	6.717	3.3
19	38.675	225.3	1290	1.292	8.753	4.3
20	40.710	228.0	1229	1.360	10.788	5.3
21	42.746	230.6	1174	1.428	12.824	6.3
22	44.781	233.1	1123	1.496	14.859	7.3
23	46.817	235.5	1075	1.564	16.895	8.3
24	48.852	237.8	1036	1.632	18.930	9.3
25	50.888	240.1	996	1.700	20.966	10.3
26	52.923	242.3	958	1.768	23.001	11.3
27	54.959	244.4	926	1.836	25.037	12.3
28	56.994	246.4	895	1.904	27.072	13.3
29	59.030	248.4	866	1.972	29.108	14.3
30	61.065	250.4	838	2.040	31.143	15.3
31	63.101	252.2	813	2.108	33.179	16.3
32	65.136	254.1	789	2.176	35.214	17.3
33	67.172	255.9	767	2.244	37.250	18.3
34	69.207	257.6	746	2.312	39.285	19.3
35	71.243	259.3	726	2.380	41.321	20.3
36	73.278	260.9	707	2.448	43.356	21.3
37	75.314	262.6	688	2.516	45.392	22.3
38	77.349	264.2	671	2.584	47.427	23.3
39	79.385	265.8	655	2.652	49.463	24.3
40	81.420	267.3	640	2.720	51.498	25.3
41	83.456	268.7	625	2.788	53.534	26.3
42	85.491	270.2	611	2.856	55.569	27.3
43	87.527	271.6	598	2.924	57.605	28.3
44	89.562	273.0	585	2.992	59.640	29.3
45	91.598	274.4	572	3.060	61.676	30.3
46	93.633	275.8	561	3.128	63.711	31.3
47	95.669	277.1	550	3.196	65.747	32.3
48	97.704	278.4	539	3.264	67.782	33.3
49	99.740	279.7	529	3.332	69.818	34.3
50	101.776	281.0	518	3.400	71.854	35.3
51	103.811	282.3	509	3.468	73.889	36.3
52	105.847	283.5	500	3.536	75.925	37.3
53	107.882	284.7	491	3.604	77.960	38.3
54	109.918	285.9	482	3.672	79.996	39.3
55	111.953	287.1	474	3.740	82.031	40.3
56	113.989	288.2	466	3.808	84.067	41.3
57	116.024	289.3	458	3.876	86.102	42.3
58	118.060	290.4	451	3.944	88.138	43.3
59	120.095	291.6	444	4.012	90.173	44.3
60	122.131	292.7	437	4.080	92.209	45.3
61	124.166	293.8	430	4.148	94.244	46.3
62	126.202	294.8	424	4.216	96.280	47.3
63	128.237	295.9	417	4.284	98.315	48.3

Atmosphere included.		Temperature of Steam.	Specific Volume.	Number of Atmospheres.	Atmospheres excluded.	
Pounds per Sq. Inch.	Inches of Mercury.				Inches of Mercury.	Pounds per Sq. Inch.
Lbs.	Inches.	Fahr.	Sp. Vol.	Atmos.	Inches.	Lbs.
64	130.273	296.9	411	4.352	100.351	49.3
65	132.308	298.0	405	4.420	102.386	50.3
66	134.344	299.0	399	4.488	104.422	51.3
67	136.379	300.0	393	4.556	106.457	52.3
68	138.415	300.9	388	4.624	108.493	53.3
69	140.450	301.9	383	4.692	110.528	54.3
70	142.486	302.9	378	4.760	112.563	55.3
71	144.521	303.9	373	4.828	114.599	56.3
72	146.557	304.8	368	4.896	116.635	57.3
73	148.592	305.7	363	4.964	118.670	58.3
74	150.628	306.6	359	5.032	120.706	59.3
75	152.663	307.5	353	5.100	122.741	60.3
76	154.699	308.4	349	5.168	124.777	61.3
77	156.734	309.3	345	5.236	126.812	62.3
78	158.770	310.2	341	5.304	128.848	63.3
79	160.805	311.1	337	5.372	130.883	64.3
80	162.841	312.0	333	5.440	132.919	65.3
81	164.876	312.8	329	5.508	134.954	66.3
82	166.912	313.6	325	5.576	136.990	67.3
83	168.947	314.5	321	5.644	139.025	68.3
84	170.983	315.3	318	5.712	141.061	69.3
85	173.018	316.1	314	5.780	143.096	70.3
86	175.054	316.9	311	5.848	145.132	71.3
87	177.089	317.8	308	5.916	147.167	72.3
88	179.125	318.6	305	5.984	149.203	73.3
89	181.160	319.4	301	6.052	151.238	74.3
90	183.196	320.2	298	6.120	153.274	75.3
91	185.231	321.0	295	6.188	155.309	76.3
92	187.267	321.7	292	6.256	157.345	77.3
93	189.302	322.5	289	6.324	159.380	78.3
94	191.338	323.3	286	6.392	161.416	79.3
95	193.373	324.1	283	6.460	163.451	80.3
96	195.409	324.8	281	6.528	165.487	81.3
97	197.444	325.6	278	6.596	167.522	82.3
98	199.480	326.3	275	6.664	169.558	83.3
99	201.515	327.1	272	6.732	171.593	84.3
100	203.551	327.9	270	6.800	173.629	85.3
101	205.587	328.5	267	6.868	175.665	86.3
102	207.622	329.1	265	6.936	177.700	87.3
103	209.658	329.9	262	7.004	179.736	88.3
104	211.693	330.6	260	7.072	181.771	89.3
105	213.729	331.3	257	7.140	183.807	90.3
106	215.764	331.9	255	7.208	185.842	91.3
107	217.800	332.6	253	7.276	187.878	92.3
108	219.835	333.3	251	7.344	189.913	93.3
109	221.871	334.0	249	7.412	191.949	94.3
110	223.906	334.6	247	7.480	193.984	95.3
111	225.942	335.3	245	7.548	196.020	96.3
112	227.977	336.0	243	7.616	198.055	97.3
113	230.013	336.7	241	7.684	200.091	98.3
114	232.048	337.4	239	7.752	202.126	99.3
115	234.084	338.0	237	7.820	204.162	100.3
116	236.119	338.6	235	7.888	206.197	101.3
117	238.155	339.3	233	7.956	208.233	102.3
118	240.190	339.9	231	8.024	210.268	103.3
119	242.226	340.5	229	8.092	212.304	104.3
120	244.261	341.1	227	8.160	214.339	105.3
121	246.297	341.8	225	8.228	216.375	106.3
122	248.332	342.4	224	8.296	218.410	107.3
123	250.368	343.0	222	8.364	220.446	108.3
124	252.403	343.6	221	8.432	222.481	109.3
125	254.439	344.2	219	8.500	224.517	110.3
126	256.474	344.8	217	8.568	226.552	111.3
127	258.510	345.4	215	8.636	228.588	112.3
128	260.545	346.0	214	8.704	230.623	113.3
129	262.581	346.6	212	8.772	232.659	114.3
130	264.616	347.2	211	8.840	234.694	115.3
131	266.652	347.8	209	8.908	236.730	116.3
132	268.687	348.3	208	8.976	238.765	117.3
133	270.723	348.9	206	9.044	240.800	118.3
134	272.758	349.5	205	9.112	242.836	119.3
135	274.794	350.1	203	9.180	244.872	120.3
136	276.829	350.6	202	9.248	246.907	121.3
137	278.865	351.2	200	9.316	248.942	122.3
138	280.900	351.8	199	9.384	250.978	123.3
139	282.936	352.4	198	9.452	253.014	124.3
140	284.971	352.9	197	9.520	255.049	125.3
141	287.007	353.5	195	9.588	257.085	126.3
142	289.042	354.0	194	9.656	259.120	127.3
143	291.078	354.5	193	9.724	261.156	128.3

Atmosphere included.		Temperature of Steam.	Specific Volume.	Number of Atmospheres.	Atmospheres excluded.	
Pounds per Sq. Inch.	Inches of Mercury.				Inches of Mercury.	Pounds per Sq. Inch.
Lbs.	Inches.	Fahr.	Sp. Vol.	Atmos.	Inches.	Lbs.
144	293.113	355.0	192	9.792	263.191	129.3
145	295.149	355.6	190	9.860	265.227	130.3
146	297.184	356.1	189	9.928	267.262	131.3
147	299.220	356.7	188	9.996	269.298	132.3
148	301.255	357.2	187	10.064	271.333	133.3
149	303.291	357.8	186	10.132	273.369	134.3
150	305.327	358.3	184	10.200	275.405	135.3
155	315.504	361.0	179	10.540	285.582	140.3
160	325.682	363.4	174	10.880	295.760	145.3
165	335.859	366.0	169	11.220	305.937	150.3
170	346.037	368.2	164	11.560	316.115	155.3
175	356.214	370.8	159	11.900	326.292	160.3
180	366.392	372.9	155	12.240	336.470	165.3
185	376.569	375.3	151	12.580	346.647	170.3
190	386.747	377.5	148	12.920	356.825	175.3
195	396.924	379.7	144	13.260	367.002	180.3
200	407.102	381.7	141	13.600	377.180	185.3
210	427.457	386.0	135	14.280	397.535	195.3
220	447.812	389.9	129	14.960	417.890	205.3
230	468.167	393.8	123	15.640	438.245	215.3
240	488.522	397.5	119	16.320	458.600	225.3
250	508.878	401.1	114	17.000	478.955	235.3
260	529.233	404.5	110	17.680	499.311	245.3
270	549.587	407.9	106	18.360	519.666	255.3
280	569.943	411.2	102	19.040	540.021	265.3
290	590.297	414.4	99	19.720	560.376	275.3
300	610.653	417.5	96	20.400	580.731	285.3
350	712.429	430.1	83	23.800	682.507	335.3
400	814.204	444.9	73	27.200	784.282	385.3
450	915.980	456.7	66	30.600	886.058	435.3
500	1017.755	467.5	59	34.000	987.833	485.3
600	1221.306	487.0	50	40.800	1191.384	585.3
700	1424.857	504.1	43	47.600	1394.935	685.3
800	1628.408	519.5	38	54.400	1598.486	785.3
900	1831.959	533.6	34	61.200	1802.037	885.3
1000	2035.510	546.5	31	68.000	2005.588	985.3

STRENGTH OF MATERIALS.

DEDUCED FROM THE LATEST EXPERIMENTS OF BARLOW, BUCHANAN, FAIRBAIRN, HODGKINSON, STEPHENSON, MAJOR WADE, U.S. ORDNANCE CORPS, AND OTHERS.

(Continued from page 185.)

TRANSVERSE STRENGTH OF CAST IRON.

As cast iron resists crushing or compression with a greater force than extension, it follows that the flanch of a Girder or Beam which is subjected to a compressing strain, according as the girder or beam is supported at both ends or fixed at one end, should be of less area than the other flange, which is subjected to extension or tensile stress.

The resistance of cast iron to compression and extension, or crushing and tensile strains, is for American, as 4.6 to 1, and for English, as 5.3 to 1. *

The mean tensile strength of American cast iron, as determined by Major Wade for the U. S. Ordnance Department, is 31,829lbs. per square inch of section; and the mean of English, as determined by E. Hodgkinson, Esq., for the Railway Commission, in 1849, is 16,330lbs.

The ultimate extension of cast iron is the 500th part of its length.

The mean transverse strength of American cast iron, also determined by Major Wade, is 681lbs. per square inch, suspended from a bar fixed at a one end and loaded at the other; and the mean of English, as determined by Fairbairn, Barlow, and others, is 500lbs.

The position of the Neutral Axis is at the centre of gravity of the section.

TRANSVERSE STRENGTH OF WROUGHT IRON.

As wrought iron resists crushing or compression with a greater force than extension, it follows that the flange of a girder or beam, which is subjected to a crushing strain, according as the girder or beam is supported at both ends, or fixed at one end, should be of less area than the other flange, which is subjected to extension or a tensile strain.

* The experiments of Mr. Hodgkinson on iron of low tensile strength gives a mean of 6.595 to 1.

The resistance of wrought iron to compression or extension, or crushing and tensile strains, is for American as 1.5 to 1, and for English, as 1.2 to 1.

The mean tensile strength of American wrought iron, as determined by Professor Johnson, in 1836, is 55,900lbs., and the mean of English, as determined by Captain Brown, Barlow, Brunel, and Fairbairn, is 53,900lbs.*

The ultimate extension of wrought iron is the 600th part of its length. The resistance to flexure acting evenly over the surface, is nearly one-half the tensile resistance.

The position of the Neutral Axis, alike to that of cast iron, is at the centre of gravity of the section.

GIRDERS, BEAMS, LINTELS, &c

The Transverse or Lateral Strength of any Girder, Beam, Bressummer, Lintel, &c., is in proportion to the product, of its breadth and the square of its depth, and also to the area of its cross section.

The best form of section for cast iron girders or beams, &c., is deduced from the experiments of Mr. E. Hodgkinson, and such as have this form of section (I) are known as Hodgkinson's.

The rule deduced from his experiments, directs as follows:—Area of bottom flange, six times that of the top flange. Flanges connected by a thin vertical web, only sufficiently thick to have the requisite lateral stiffness, and tapering both upwards and downwards from the neutral axis, and in order to set aside the risk of an imperfect casting, by any great disproportion between the web and the flanges, it should be tapered so as to connect them with a thickness corresponding to that of the flange.

When girders are subjected to impulses, and are used to sustain vibrating loads, as in bridges, &c., the best proportion between the top and bottom flange, is as one to four; as a general rule, they should be as narrow and deep as practicable, and should never be deflected to more than one five-hundredth of their length.

In public halls, churches, and buildings where the weight of people alone are to be provided for, an estimate of 175 pounds per square foot of floor surface is sufficient to provide for the weight of flooring and the load upon it.

In store houses and factories, the weight to be provided for, should be estimated at that, which may at any time be placed thereon, or which at any time may bear upon any portion of their floors: the usual allowance, however, is for a weight of 280lbs. per square foot of floor surface.

In all uses, such as in buildings and bridges, where the structure is exposed to sudden impulses, the load or stress to be sustained, should not exceed from one-fifth to one-sixth of the breaking weight of the material employed, but when the load is uniform or quiescent, it may be increased to one-third and one-fourth of the breaking weight.

An open web, girder or beam, &c., is to be estimated in its resistance, on the same principle as if it had a solid web. In cast metals, allowance is to be made for the loss of strength due to the unequal contraction in cooling of the web and flanges.

In cast iron, the mean resistance to crushing or compression and extension, are as 5.5 to 1, and in wrought iron, as 12 to 23; hence the mass of metal below the neutral axis, will be greatest in these proportions, when the stress is intermediate between the ends or supports of the guides, &c.

Wooden Girders or Beams, when sawed in two or more pieces, and slips are set between them, and the whole bolted together, are made stiffer by the operation and are rendered less liable to decay.

Girders cast with a face up are stronger than when cast on a side, in the proportion of 1 to .959, and they are strongest also, when cast with the bottom flange up.

The following results of the resistances of metals will show how the material should be distributed, in order to obtain the maximum of strength with the minimum of material:

	To Tension.	To Crushing.
Wrought Iron,	23 tons.	12 tons.
Copper,	16 "	3 "
Cast Iron,	8 "	51 "
	8 "	37 "

Hence, in a wrought iron beam, the upper flange should be as 23 to 12, or 2 to 1.

The best iron has the greatest tensile strength, and the least compressive or crushing.

The relative strength of girders or beams, cast vertical or horizontal, is as 536 to 514, or as 1 to .96.

The outline of a girder or beam, both in depth and width of bottom flange, may be reduced from the required dimensions in the middle, or at the end, as the case may be, at points intermediate between the centre and supports, or end and fulcrum, to correspond to the weight or stress to be borne.

* The results, as given by Telford, includes experiments upon Swedish iron, hence they are omitted in this summary.

When the top flange, the thickness of the web, the length and the depth are unaltered, the web being thin, the strength of the girder or beam, is nearly in proportion to the area of the bottom flange. (See Inquiry, &c., by Samuel Hughes, C. E., &c., in THE ARTIZAN, July, 1857.)

The most economical constructions of Girders or Beams, with reference to attaining the greatest strength, with the least material, are as follows:—The outline of their top, bottom, and sides, should be a curve of various forms, according as the breadth throughout is equal, or the depth throughout is equal, and as the girder or beam is loaded only at one end, or in the middle, or uniformly throughout.

When the Girder or Beam is fixed at one end, and loaded at the other.

1. When the depth is uniform throughout the entire length.

The depth being uniform: the section at every point must be in proportion to the product of the length, breadth, and square of the depth, and as the square of the depth is in every point the same, the breadth must vary directly as the length, consequently, each side of the beam must be a vertical plane, tapering gradually to the end.

2. When the breadth is uniform throughout the entire length.

The breadth being uniform: the depth must vary as the square root of the length: hence the upper or lower sides, or both, must be determined by a parabolic curve.

3. When the section at every point is similar, that is, a circle, an ellipse, a square, or a rectangle, the sides of which bear a fixed proportion to each other.

The section at every point, being a regular figure: for a circle, the diameter at every point must be as the cube root of the length, and for an ellipse, or a rectangle, the breadth and depth must vary as the cube root of the length.

When the Girder or Beam is fixed at one end, and loaded uniformly throughout its length.

1. When the depth is uniform throughout its entire length.

The depth being uniform: the breadth must increase as the square of the length.

2. When the breadth is uniform throughout its entire length.

The breadth being uniform: the depth will vary directly as the length.

3. When the section at every point is similar, as a circle, ellipse, square, and rectangle.

The section at every point being a regular figure: the cube of the depth must be in the ratio of the square of the length.

When the Girder or Beam is supported at both ends.

1. When loaded in the middle.

The constant of the beam, or the product of the breadth and the square of the depth, must be in proportion to the distance from the nearest support; consequently, whether the lines forming the beam are straight or curved, they meet in the centre, and of course the two halves are alike. The beam, therefore, may be considered as one of half the length, the supported end corresponding with the free end in the case of beams, one end being fixed and the middle of the beams similarly correspond with the fixed end.

1. When the depth is uniform throughout.

The depth being equal: the breadth must be in the ratio of the length.

2. When the breadth is uniform throughout.

The breadth being uniform: the depth will vary as the square root of the length.

3. When the section at every point is similar, as a circle, ellipse, square, and rectangle.

The section at every point being a regular figure: the cube of the depth will be, as the square of the distance from the supported end.

When the Girder or Beam is supported at both ends and loaded uniformly throughout its length.

1. When the depth is uniform.

The depth being uniform: the breadth will be as the product of the length of the beam, and the length of it on one side of the given point, less the square of the length on one side of the given point.

2. When the breadth is uniform.

The breadth being uniform: the depth will be as the square root of the product of the length of the beam, and the length of it on one side of the given point, less the square of the length on one side of the given point.

3. When the section at every point is similar, as a circle, ellipse, square, and rectangle.

The section at every point being a regular figure: the cube of the depth will be as the product of the length of the beam, and the length of it on one side of the given point, less the square of the length on one side of the given point.

GENERAL DEDUCTIONS FROM THE EXPERIMENTS OF STEPHENSON,
FAIRBAIRN, CUBITT, HUGHES, &c.

Fairbairn shows in his experiments that with a stress of about 12,320lbs. per square inch on cast iron, and 28,000lbs. on wrought iron, the sets and elongations are nearly equal to each other.

A cast iron beam will be bent to one-third of its breaking weight, if the load is laid on gradually, and one-sixth of it, if laid on at once, will produce the same effect, if the weight of the beam is small compared with the weight laid on.

Hence, beams of cast iron should be made capable of bearing more than six times the greatest weight which will be laid upon them.

In wrought iron beams, the upper flange should be larger than the lower, in the ratio of 2 to 1. The breaking weights in similar beams are to each other as the squares of their like linear dimensions. That is, the breaking weights of beams are found by multiplying together the area of their section, their depth, and a constant, determined from experiment on beams of the particular form under investigation, and dividing the product by the distance between the supports.

Cast and wrought iron beams, having similar resistances, have weights nearly as 2.44 to 1.

The range of the comparative strength of girders, of the same depth, having a top and bottom flange, and those having bottom flange alone, is from having but a little area of bottom flange to a large proportion of it, from less than one-half to one-quarter greater strength.

A box beam, or girder, constructed of plates of wrought iron, compared to a single rib and flanged beam I, of equal weights, has a resistance as 100 to 93.

The resistance of beams, or girders, where the depth is greater than their breadth, when supported at top, is much increased. In some cases, the difference is fully one-third.

When a beam is of equal thickness throughout its depth, the curve should be an ellipse, to enable it to support a uniform load with equal resistance in every part; and if the beam is an open one, the curve of equilibrium, for a uniform load should be that of a parabola. Hence, when the middle portion is not wholly removed, the curve should be a compound of an ellipse and a parabola, approaching nearer the latter as the middle part is decreased.

Girders of cast iron, up to a span of 40ft., are cheaper than of wrought iron.

Cast iron beams and girders should not be loaded to exceed one-fifth of their breaking weight, and when the strain is attended with concussion and vibration, this proportion must be increased, and they should not be subjected to a deflection exceeding .05 of their length, or to a test much exceeding the greatest stress to which they are to be subjected.

Simple cast iron girders may be made 50ft. in length, and the best form is that of Hodgkinson; when subjected to a fixed load, the flange should be as 1 to 6, and when to a concussion, &c., as 1 to 4.

The forms of girders for spaces exceeding the limit of those of simple cast iron, are various; the principal ones adopted are those of the straight or arched cast iron girders in separate pieces, and bolted together, the trussed, the bow string, and the wrought iron box and tubular.

The Straight or Arched girder is formed of separate castings, and is entirely dependent upon the bolts of connection for its strength.

The Trussed or Bow String girder is made of separate castings, on a single piece, and its strength depends, other than upon the depth or area of it, upon the proper adjustment of the tension, or initial strain, upon the wrought iron truss.

The Box or Tubular girders are made of wrought iron, and are best constructed with cast iron tops, in order the best to resist compression; this form of girder is best adapted to afford lateral stiffness.

FLOOR BEAMS, GIRDERS, &c.

The condition of the stress borne by a Floor Beam is that of a beam supported at both ends and uniformly loaded; but from the irregularity in its loading and unloading, and from the necessity of its possessing great rigidity, it is impracticable to estimate its capacity other than as a beam, having the weight borne upon the middle of its length.

To Ascertain the Depth of a Floor Beam, the Length and Breadth being Given.

When the distance between the Centres of the Beam is One Foot.

RULE.—Divide the product of the square of the length in feet and the weight to be borne in pounds per square foot of floor, by the product of four times the breadth and the Value of the material from the preceding table (page 8), and the square root of the quotient will give the depth of the beam, in inches.

EXAMPLE.—A white pine beam is 2in. wide and 12ft. in length between the supports; what should be the depth of it to support a weight of 175lbs. per square foot!

$$\frac{12^2 \times 175}{2 \times 4 \times 30} = 105, \text{ and } \sqrt{105} = 10.25\text{in.}$$

When the Distance between the Centres of the Beam is greater or less than one foot.

RULE.—Divide the product of the square of the depth for a beam, when the distance between the centres is one foot, by the distance given in inches by 12, and the square root of the quotient will give the depth of the beam in inches.

EXAMPLE.—Assume the beam in the preceding case to be set 15in. from the centres of its adjoining beams; what should be its depth?

$$\frac{10 \cdot 25^2 \times 15}{12} = 131 \cdot 25, \text{ and } \sqrt{131 \cdot 25} = 11 \cdot 45 \text{ in.}$$

Headers and Trimmer Beams.—The conditions of the stress borne or to be provided for by them, in floors, are as follows:—

Headers or Trimmers—Support one-half of the weight of and upon the tail beams inserted into or attached to them.

Trimmer Beams—Support, in addition to that borne by them directly as a floor beam, each one-half the weight on the headers.

Hence, the stress on a header is due directly to its length, or the number of tail beams it supports; and the stress on the trimmer beams is due to the half of the weight on the header supported by them.

NOTE.—The distance between the support of the trimmer beams and the point of connection with the header, does not in any wise affect the stress on the trimmer beams; for in just proportion as this distance is increased, and the stress upon them consequently increased by the suspension of the header from them nearer to the middle of their length, so is the area of the surface supported by the header reduced, and, consequently, the load to be borne by it.

Girder.—The condition of the stress borne by a Girder is that of a beam fixed or supported at both ends, as the case may be, supporting the weight borne by all of the beams resting thereon, at the points at which they rest; and its dimensions must be proportionate to the stress upon it, and the distance between its points of insertion or support.

ILLUSTRATION.—It is required to determine the dimensions of a pitch pine girder, 15ft. between its several points of support*, to support the ends of two lengths of beams each 20ft. in length, having a superincumbent weight, including that of the beams, of 200 pounds per square foot.

The condition of the stress upon such a girder would be that of a number of beams, 40ft. in length (20 × 2), supporting at both ends and loaded uniformly along their length, with 200lbs. upon every superficial foot of their area.

Hence, the amount of the weight to be borne is determined by 20 × 2 × 15 × 200 = 120,000lbs. = the product of twice the length of a beam,

* When a girder has four or more supports, its condition is that of a beam fixed at the ends.

the distance between the supports of the girder and the weight borne per square foot of area, and the resistance to be provided for, is that to be borne by a beam, 15ft. in length, fixed at both ends, and supporting 120,000lbs. uniformly laid along its length, equal to 60,000lbs. supported at its centre.

Consequently, $\frac{15 \times 60,000}{6 \times 50} = 3000 =$ quotient of the product of the length and weight ÷ the product of 6 times the Value of the material; and assuming the girder to be 12in. wide, then,

$$\sqrt{\frac{3000}{12}} = 15 \cdot 8 \text{ in., the depth required.}$$

(To be continued.)

THE "GREAT EASTERN" STEAMSHIP.

We have now the pleasure of presenting to our readers a copy of the log of the *Great Eastern* on her return passage from Quebec.

We have also in our possession indicator cards, taken during the voyage from both paddle and screw engines; but as they do not present anything remarkable, and reached us too late in the month to enable us to engrave them in time, we have given the figures representing the values from their summation.

The logs of previous voyages to New York and back and to Quebec were also furnished by Mr. Rorison, the chief engineer, who writes:—

"Enclosed is an abstract of our log; also four indicator cards. I am sorry to say that we have had very bad coals,* both out and home. We have very few repairs: our principal repairs are on the paddle wheels and boilers. Our machinery has worked well, not the slightest symptoms of hot bearings. There is no perceptible wear on screw-shaft-bearing.

"The revolutions and consumption of coal on the cards is the mean of twenty-four hours in both paddle and screw engines; the revolutions are taken from the counter.

"J. RORISON."

* We find on enquiry that the coals were supplied by about seven different contractors and some of the sorts could not be burnt. The directors should look to this. How is it possible for the *Great Eastern* to be economically worked if the coal bunkers are filled with stones, or, at the best, very inferior coals.—[ED. ARTIZAN.]

ABSTRACT OF ENGINEER'S LOG OF THE "GREAT EASTERN"—VOYAGE FROM QUEBEC TO LIVERPOOL.

Date, each day ending at Noon.	PADDLE ENGINES.				SCREW ENGINES.				Total quantity of Coals used each Day.	Number of Knots run by the Paddle Engines.	Number of Knots run by the Screw Engines.	Distance run by the Ship, in Knots.	Latitude.	Longitude.	Course.	GENERAL REMARKS, &c.
	Revolutions of Engines each day.	Average Revolutions per Minute.	Average Pressure of Steam in Engine Room.	Tons of Coals used each Day.	Revolutions of Engines each day.	Average Revolutions per Minute.	Average Pressure of Steam in Engine Room.	Tons of Coals used each Day.								
Aug. 6	36	48	84	N.	W.	...	{ Left Quebec at 4.45 a.m. Came to anchor at 7.45 a.m. off the Quarantine Ground.
" 7	12,251	10	21	122	46,470	36	20	158	280	320	336	289	49°22'	65°11'	N. 88 E.	Left at 2.20 p.m.; put out pilot at 5.10 a.m.
" 8	14,596	10°35'	21	152	53,080	37°6'	19½	181	333	360	381	314	47°03'	58°9'	S. 64 E.	Light breeze; sea smooth.
" 9	14,671	10°47'	21	162	53,140	38	19½	195	357	367	385	304	47°13'	51°4'	S. 85 E.	Light fair wind; sea smooth.
" 10	14,679	10°41'	21	166	53,110	37°6'	19	194	360	367	381	312	49°15'	43°56'	S. 67 E.	Light head wind; passed several icebergs.
" 11	14,725	10°5'	21	182	51,900	37	19	222	404	364	376	314	50°21'	36°04'	N. 78 E.	Head wind; sea smooth.
" 12	15,103	10°7'	20	184	50,810	36°2'	16¾	216	400	373	366	309	50°48'	27°47'	N. 83 E.	{ Light beam wind; coals running very small and bad quality.
" 13	15,335	10°9°5'	21	166	52,110	37°22'	18½	199	365	382	377	312	51°21'	19°33'	N. 84 E.	Strong beam wind.
" 14	14,547	10°07'	20	168	50,920	36°3'	17¾	181	349	348	368	306	51°50'	11°22'	N. 85 E.	Strong beam wind and heavy sea.
" 15	14,727	10°62'	21	158	50,020	36°1'	18	172	330	375	360	316	Steering by the land.	Strong beam wind; ship rolling heavy.
" 16	3,903	10°62'	21	50	13,182	36°3'	19	72	122	96	98	80	{ At 3.40 p.m. took pilot on board; at 6.30 p.m. off Bell Buoy; log made up.
Totals...	135,910	10°57'	21	1544	480,892	37°44'	19	1840	3384	3352	3428	2869	Actual time steaming from Quebec 8 days 22 hrs.

Indicated power of Paddle Engines, 3411 H.P.; ditto Screw Engines, 4886 H.P.; Total 8297 H.P. = 4·15lbs. of coal per hour per L.H.P.; Steam Ganges defective; Coals very bad; no perceptible wear on Screw-shaft-bearing; Density of Water in Boilers, 1¼; Vacuum in Paddle Engines, 25; ditto in Screw, 26; Extreme Diameter of Paddle Wheels, 50ft.; Effective Diameter 48ft. = 150°79ft. each revolution; Screw 44ft. Pitch; Immersion on leaving Quebec, 24ft. 6in. forward; 26ft. 4in. aft; Immersion on arriving at Liverpool, 21ft. forward; 23ft. aft.

J. RORISON, Chief Engineer.

THE QUEEN'S YACHT AND THE HOLYHEAD MAIL PACKETS

The *Times'* Correspondent in writing from Kingstown, Ireland, on the 22nd August says:—

The Royal Yacht arrived here safely soon after half-past ten o'clock last night. The time in which the Royal Yacht made the voyage last night seems to have quite puzzled the Kingstown people, who cherished the belief that there was no vessel as fast as the *Leinster*, Holyhead packet. The *Leinster* makes her best trips in little over four hours, and the Royal Yacht was considerably allowed five in all calculations. The *Victoria* and *Albert* accomplished the whole distance (64 miles from land to land) in little more than 3½ hours.

It is evident that the writer of the above paragraph knows nothing of performances of the New Holyhead Mail Packets.

The time occupied by the new packets in their best passages before the speed was reduced by order of the Directors of the City of Dublin Steam Company, was 3hrs. 18min. to 3hrs. 20min. between the timing places on each side.

The returns furnished by the owners of the four new Mail Packets show that the average during six winter months, ending March 31st, 1861, was only from 3hrs. 41min. for one of the ships to 3hrs. 52min. for another. These times include deteution by severe weather, fogs, &c., during that period.

In the ordinary run of these vessels, at their present reduced speed and more economical mode of working, they make the passage in 3hrs. 40m in to 3hrs. 45min.; the time occupied by the *Victoria* and *Albert* in making ber passage on the 21st Aug. was, we are informed, 3hrs. 45mins. actual time; the difference between the time observed on each side being 25min.

It will thus be seen that if the Queen's Yacht did its best, the *Times'* correspondent has committed a serious blunder, for instead of the *Victoria* and *Albert* being so much faster than the *Leinster*, the reverse is the fact, and the difference in speed would be about *two miles an hour* in favour of the new Mail Packets.

As, however, we shall have more time and better opportunity to work out the calculation minutely before our next publication, we will then give the accurate results. In the mean time we are enabled to state that at the present reduced rate of speed adopted by the Mail Contractors in the passages of their new boats, those vessels are equal in speed to that attained by the *Victoria* and *Albert* in the run from Holyhead to Kingstown.

[Since the above was in type, we have received a letter from a correspondent "A Marine Engineer," giving more accurately, particulars relating to the performance of the Queen's yacht and the Holyhead packets respectively; and we now refer our readers thereto, as the letter contains that which we proposed to undertake and publish next month.]

AEROMETRY.

TRANSLATED FROM THE HYDRAULICS OF D'AUBUISSON DE VOISINS.

BY J. BENNETT.

From the *Journal of the Franklin Institute.*

490. Aerometry, or the science of the motion of aeriform fluids, which may properly be termed aerodynamics, may be investigated under the three following conditions:—1st. When the fluids issue from the effect of compression, from a reservoir in which they are inclosed. 2nd. When they move in conduit pipes. 3rd. When they act as motors.

Before entering upon these subjects, let us refer to some of the properties of air, and more especially of atmospheric air.

Mechanical Properties of Air.

491. Atmospheric air, though composed of azote and oxygen, two essentially different gases, and simply mixed, is regarded in mechanics as a homogenous body.

492. *Elasticity.*—Like all aeriform fluids, it is eminently elastic. By reason of elasticity, it constantly tends to occupy a greater space; so that when inclosed in a vase, it exerts in virtue of this tendency, an effort or pressure against the sides of the vessel. According to the principles of hydraulics, and disregarding the weight of the fluid, the pressure is equal upon all points of the sides; so that if a manometer is placed upon one

of them, the height to which the mercury or other fluid may be raised, will indicate the *pressure*, or *tension*, or *elastic force* of the enclosed air.*

493. *Compressibility.*—The air is compressed under the weight with which it is loaded, and in proportion to the weight. This law, established by Mariotte, and verified long since for small loads, has been confirmed by the beautiful experiments of MM. Dulong and Arago†, up to the enormous load or pressure of 67-236ft. of height, a pressure of twenty-seven *atmospheres*, or equal to twenty-seven times that due to the weight of our atmosphere, and is indicated by the height of the barometer at the level of the sea, a height generally estimated at 2-49ft. = 29-85in. (The most exact observations give as a mean at this level, from my computations 2.5ft. = 30in., the mercury being reduced to 32° Fah. of thermometric temperature.

494. *Dilatation by Heat.*—Air is dilated by heat; and $\frac{1}{273}$ or 0-00208 its volume for each degree of Fahrenheit, starting from 32° of this thermometer; so that the volume of a mass of air, represented by 1 at 32°, will be represented by $1 + 0-00208 (t - 32°)$ at t degrees. All aeriform fluids follow this law of dilation, as well as that of compression proportional to the weight.

495. *Weight of Atmospheric Air.*—The density of bodies, their masses being the same, are in the inverse ratio of their volume; so that the densities of the same fluid mass at 32° and at t , will be to each other as $1 + 0-00208 (t - 32°)$ is to 1. Weights, under the same volume, follow the ratio of the densities; and so it will be with the *specific gravity* of bodies, which is their weight at a given unit of volume.

The specific weight of an aeriform fluid will then be a function of the load which compresses, and the heat which penetrates it; it will increase with the load, and diminish with the heat, in the ratio to be indicated.

From the experiments of MM. Biot and Arago, a cubic foot of dry atmospheric air at 2-493ft. of load, or barometer pressure, and at 32° of temperature, weighs 0-08112lbs. Thus under a barometric pressure represented by b , and at a temperature t , the weight of a cubic foot, or the specific weight of dry atmospheric air will be

$$0-081121 \frac{b}{2-493} \frac{1}{1 + 0-0028 (t - 32°)} = -032533 \frac{b}{1 + 0-00208 (t - 32°)}.$$

The aqueous vapour always existing in atmospheric air, in a greater or less quantity, being lighter than air, diminishes its weight in mixing with it; and as, other things being equal, its quantity is greater as the weather is warmer, we must regard its effect by increasing a little the multiplier of t , or raising it to -00222. We may accordingly establish the weight of a cubic foot of atmospheric air at

$$-032533 \frac{b}{1 + -00222 (t - 32°)}.$$

If 1 represent the weight of a volume of dry air, remembering that the vapour of water is lighter in the ratio of 5 to 8, we find that the weight of the same

volume, containing also a certain quantity of this vapour is $1 - \frac{3 n f}{8 b}$; an

expression in which b indicates the height of the barometer in this air, and $n f$ the elastic force of the vapour at the temperature t , in a space saturated with it; and we have

$$0-28 t - 0-000063 t^2 \\ \ddagger f = 0^m -00512 \times 10.$$

The number n is the ratio between the quantity of vapour contained in a space where the hygrometer is kept at a certain degree, and the quantity contained in the same space when it is entirely saturated, and when, consequently, the hygrometer is at 100°, the temperature being the same. M. Gay-Lussac has provided a table of the values of n , corresponding to the different degrees of the hair-hygrometer: the adjoining table is taken from it. I have elsewhere shown (1) that the substitution of the approximate factor

$$\frac{1}{1 + -00222 (t - 32°)}$$

For the theoretic factor,

$$\frac{1 - \frac{3 n f}{8 b}}{1 + -00208 (t - 32°)}$$

Hygrometer.	n .
100°	1-00
95	0-89
90	0-79
85	0-70
80	0-61
75	0-54
70	0-47
65	0-40
60	0-35
50	0-28

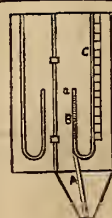

* The manometer used in the experiments to be reported hereafter consists of a glass tube bent round parallel to itself, inserted in a piece of wood with a hinged cover. The first of the three branches A B C of the tube passes behind the second; it is empty, and the two others contain in their lower half mercury or coloured water. The instrument is inserted by the conical end into a circular hole made in the air reservoir. When the fluid is compressed, as it communicates through the branch A with the top of the branch B, it presses the liquid downwards, and forces it up the branch C; then the difference of level of the liquid in the two branches is the manometric height, or measure of the elastic force.

† Annales de Chimie et de Physique. Tome xliiii, 1830.

‡ In metrical units; t being in centigrade divisions.

will not occasion an error of more than a thousandth in the weight of the air taken in the usual condition of the atmosphere.

496. *Weight of Air compared with that of Water.*—A cubic foot of water weighing 62.448 lbs., and the cubic foot of air .032533 lbs.

$$\frac{b}{1 + .00222(t - 32^{\circ})}$$

the ratio between these weights, which is 1919.5

$$\frac{1 + .00222(t - 32^{\circ})}{b}$$

expresses how many times the weight of the water exceeds that of the air; it will be 800 times, at 50° Fah., and at 2.493ft. of barometer.

497. *With Mercury.*—The cubic foot of mercury at 32° weighs

$$\frac{849.242}{1 + .0001(t - 32^{\circ})}$$

Thus the ratio between the weight of this substance, and that of air will be

$$\frac{849.242}{.032533} \frac{(1 + .0022(t - 32^{\circ}))}{b(1 + .0001(t - 32^{\circ}))} = 26103.8 \frac{1 + .00222(t - 32^{\circ})}{b}$$

observing that the factor .0001 (t-32°) is always very small; and in neglecting it we correct somewhat the effect of vapour upon the weight of the air.

I remark that 26099ft. is the height of the atmosphere, on the supposition of a constant density, the air being throughout at 2.493 lbs. pressure, and 32° of temperature.

498. *Weight of any Gas.*—Usually atmospheric air is taken as a term of comparison with other aeriform fluids or gases; if ρ be the ratio of density of any gas to that of air, or the *specific weight* of the gas, the weight of a cubic foot will be

$$.032533 \rho \frac{b}{1 + .00222(t - 32^{\circ})}$$

SECTION FIRST.

The motion of Air issuing from a Reservoir in which it is compressed.

499. *Force by Virtue of which the Fluid issues.*—Let us take for the reservoir a tight box, containing air in its natural state, or at the simple pressure of the atmosphere, a pressure which we always distinguish by b : if we make an opening at one of the sides, the molecules of air in its vicinity, being pressed on all sides alike, by the same force (effort) b , will remain in equilibrium; they will not issue and there will be no motion.

But if the interior air receives a pressure: for example, if the cover of the box be movable as a piston in the body of a pump, and charged with a weight, the air will be more pressed than that outside; and its molecules, yielding to the excess of pressure, will issue. Suppose a manometer fitted to the box is raised the height of H , this height will measure the resultant pressure of the weight upon the cover; the molecules in front of the opening will be urged outwards by the force $b + H$; they will be repelled by b ; these two forces, acting in opposite directions, will have for a resultant their difference, which is π . The issue will take place as if this force alone acted upon the air of the reservoir, and it issued in a void.

500. *Velocity of Issue.*—It is known that when a fluid issues from a vessel, by virtue of a pressure exerted upon it, its velocity is due to a height equal to that of a column of issuing fluid, whose weight is a measure of the pressure. This height is evidently H increased in the ratio of the density of the manometric fluid, to that of the issuing fluid. D being the first of these densities, and d the second, calling V the velocity of issue, we shall have

$$V = \sqrt{2g.H \frac{D}{d}}$$

If the manometric fluid is mercury, the air issuing under the pressure $b + H$, and having the temperature 32°, we have

$$\frac{D}{d} = 26103.8 \frac{1 + .00222(t - 32^{\circ})}{b + H} \quad (497):$$

Consequently, reducing and making $1 + .00222(t - 32^{\circ}) = T$,

$$V = 1296 \sqrt{H \frac{T}{b + H}}$$

In case of H being neglected by reason of its small ratio to b , this last quantity being usually estimated at 2.493ft., and admitting a temperature of 53.6°, we shall have

$$V = 840.4 \sqrt{H}$$

501. *Discharge.*—If S represent the area of section of orifice, the volume of air flowing in a second of time will be

$$1296 S \sqrt{H \frac{T}{b + H}}$$

This is the theoretic discharge.

But here also, the contractions experienced by the vein of air, in its passage through an orifice, reduce the discharge.

Let m be the co-efficient of reduction, and Q the actual discharge we shall have

$$Q = 1296 m S \sqrt{H \frac{T}{b + H}}$$

502. *Experiments to determine Co-efficients.*—We must now determine m for different kinds of orifices. I have devoted myself to this determination, and have made numerous experiments upon the subject, the details of which were published in the *Annales des Mines*, (Tome xiii., 1826.) I proceed to give a table of results, after giving a description of the apparatus used.

The principal part was a gasometer or cylindrical box, open underneath, with a diameter of 2.13 feet and 2.62 feet high. On its upper end, carrying a manometer with coloured water, I made at random orifices or ajutages differing in form and size. This gasometer was placed upon a cask full of water in which it descended, being enclosed between four vertical iron rods; it was charged successively with 17.64, 35.28, 52.92, 70.56, and 83.2 lbs., and sometimes with 4.41, 8.82, 13.23, and 26.46 lbs., so as to vary the velocities of the issuing air.

From the indications of the manometer, and the area of the orifices, was derived the theoretic discharge. By multiplying the section of the gasometer by the height of its fall per second, a height derived from the number of seconds required for its descent from a given elevation with a uniform motion, we have the real discharge. This divided by the first, gives the co-efficient sought.

503. *Orifices in a thin side.*—The air at first issued through circular orifices pierced in tin-plate, and the following results were obtained:

Diameter of Orifice.	Manometric Height.	Length of Descent.	Time of Descent.	Co-efficient.	
				By Experiment.	Mean.
feet.	feet.	feet.	seconds.		
.032	.0938	1.96	187	.623	.630
.032	.1640	1.96	141	.629	
.032	.2394	1.96	117	.628	
.032	.3215	1.96	102	.623	
.032	.3936	1.80	82	.642	
.032	.4724	1.80	76	.634	.652
.049	.0918	1.96	82	.643	
.049	.1640	1.96	60	.660	
.049	.2362	1.96	51	.647	
.049	.3215	1.47	32	.664	
.049	.4002	1.80	36	.648	.646
.065	.0885	1.96	46	.665	
.065	.1246	1.96	39.5	.642	
.065	.1640	1.96	34.7	.636	
.065	.1968	1.96	31.5	.641	
.098	.0885	1.96	20	.656	.673
.098	.1049	1.96	18	.686	
.098	.1246	1.96	16.5	.683	
.098	.1443	1.96	15.5	.675	
.098	.1640	1.96	14.7	.664	
General Mean649	

A discussion of these different experiments causes us to adopt 0.65 as the co-efficient of reduction for orifices made in a thin plate.

For the running of water we had as a mean 0.62.

The diminution in the discharge of air, is then the effect of a real contraction of the fluid vein; this may be rendered apparent by charging the air with smoke, when the contraction of the vein becomes distinct at its issue from the orifice.

NOTE.—A Swedish saven, Lagerliljehlm, has also made experiments upon the flow of air through orifices in a thin plate. Their diameter was .039 feet, .078 feet, and .108 feet; the manometric pressures were from 190 feet, up to 1.571 feet; the co-efficients obtained varied from 0.58 to 0.70, and their mean term was at 0.62. Most frequently the flow, having but a few seconds duration, and the results not presenting the same uniformity as ours, we cannot equally confide in them.

504. *Cylindrical Ajutages.*—The cylindrical ajutages, or small additional tubes which I used, had the same diameters as the circular orifices. They afforded the experiments shown in the following table:

Ajutage.		Mano- metric Height.	Length of Descent.	Time of Descent.	Co-efficients.	
Diameter.	Length.				By Experiment.	Mean.
feet.	feet.	feet.	feet.	seconds.		
'0328	'1312	'0885	'1968	132	'910	} -931
'0328	'1312	'1640	'1968	97	'912	
'0328	'1312	'2362	'1968	79.7	'925	
'0328	'1312	'3116	'1968	68	'927	
'0328	'1312	'3936	'1804	61	'940	
'0328	'1312	'4625	'1804	51.5	'940	} -924
'0492	'1476	'0885	'1968	59	'923	
'0492	'1476	'1640	'1968	43.5	'922	
'0492	'1476	'2362	'1968	36	'930	
'0492	'1476	'3149	'1804	29	'927	
'0492	'1476	'3936	'1804	26	'916	} -916
'0656	'1968	'0918	'1968	33	'896	
'0656	'1968	'1640	'1968	24.2	'915	
'0656	'1968	'2362	'1968	19	'934	
'0656	'1968	'3149	'1804	16	'919	
'0984	'2624	'0820	'1968	14	'964	} -933
'0984	'2624	'1017	'1968	13.3	'934	
'0984	'2624	'1279	'1968	12	'902	
Mean						'926

The accordance in these results is remarkable; it leaves no doubt as to the value of the co-efficient for cylindrical ajutages; it is from 0.92 to 0.93. That of incompressible fluids, 0.82, was much less. 505. It was desirable to know to what point the length of the additional tube might affect the value of the co-efficient. In consequence, four tubes of .039 ft. diameter, whose lengths are given in the following table, were chosen.

Length of Tube.	Co-efficient.	Discharge.	
		Real.	Calculated.
feet.		cubic feet.	cubic feet.
0.049	.938	.02571	.02489
0.147	.924	.02472	.02468
0.531	.838	.02217	.02263
1.066	.738	.02013	.02051

Many series of experiments were made on each; in the third column is given the mean discharge obtained, and in the second, the co-efficient derived from it. The rapidity of the decrease is very marked, and the theory to be unfolded in the next chapter, upon the effect of the resistance opposed by tubes to the motion of air, takes note of it, as appears from the last column of the table, which presents the discharge calculated in accordance with the theory.

(To be continued.)

ROYAL INSTITUTION OF GREAT BRITAIN.

ON THE PHYSICAL BASIS OF SOLAR CHEMISTRY

By JOHN TENDALL, Esq. F.R.S.

Omitting all preface, the speaker drew attention to an experimental arrangement intended to prove that gaseous bodies radiate heat in different degrees. Behind a double screen of polished tin was placed an ordinary ring gas-burner; on this was placed a hot copper ball, from which a column of heated air ascended: behind the screen, but so glazed that no ray from the ball could reach the instrument, was an excellent thermo-electric pile, connected by wires with a very delicate galvanometer. The thermo-electric pile was known to be an instrument whereby heat, was applied to the generation of electric currents; the strength of the current being an accurate measure of the quantity of the heat. As long as both faces of the pile were at the same temperature, no current was produced; but the slightest difference in the temperature of the two faces at once declared itself by the production of a current, which, when carried through the galvanometer, indicated by the deflection of the needle both its strength and its direction.

The two faces of the pile were in the first instance brought to the same temperature; the equilibrium being shown by the needle of the galvanometer standing at zero. The rays emitted by the current of hot air already referred to were permitted to fall upon one of the faces of the pile; and an extremely slight movement of the needle showed that the radiation from the hot air, though sensible, was extremely feeble. Connected with the ring-burner was a holder containing oxygen gas; and by turning a cock, a stream of this gas was

permitted to issue from the burner, strike the copper ball, and ascend in a heated column in front of the pile. The result was, that oxygen showed itself, as a radiator of heat, to be quite as feeble as atmospheric air.

A second holder containing olefiant gas was also connected by its own system of tubes with the ring-burner. Oxygen had already flowed over the ball and cooled it in some degree. Hence, as a radiator in comparison with oxygen, the olefiant gas laboured under a disadvantage. It was purposely arranged that this should be the case; so that if, notwithstanding its being less hot, the olefiant gas showed itself a better radiator, its claim to superiority in this respect would be decisively proved. On permitting the gas to issue upwards, it cast an amount of heat against the adjacent face of the pile sufficient to impel the needle of the galvanometer almost to its stops at 90°. This experiment proved the vast difference between two equally transparent gases with regard to their power of emitting radiant heat.

The converse experiment was now performed. The thermo-electric pile was removed and placed between two cubes filled with water kept in a state of constant ebullition; and it was so arranged that the quantities of heat falling from the cubes on the opposite faces of the pile were exactly equal, thus neutralizing each other. The needle of the galvanometer being at zero, a sheet of oxygen gas was caused to issue from a slit between one of the cubes and the adjacent face of the pile. If this sheet of gas possessed any sensible power of intercepting the thermal rays from the cube, one face of the pile being deprived of the heat thus intercepted, a difference of temperature between its two faces would instantly set in, and the result would be declared by the galvanometer. The quantity absorbed by the oxygen under those circumstances was too feeble to affect the galvanometer; the gas, in fact, proved sensibly transparent to the rays of heat. It had but a feeble power of radiation; it had an equally feeble power of absorption.

The pile remaining in its position, a sheet of olefiant gas was caused to issue from the same slit as that through which the oxygen had passed. No one present could see the gas; it was quite invisible. The light went through it as freely as through oxygen or air; but its effect upon the thermal rays emanating from the cube, was what might be expected from a sheet of metal. A quantity so large was cut off, that the needle of the galvanometer, promptly quitting the zero line, moved with energy to its stops: thus the olefiant gas, so light and clear and pervious to luminous rays, was a most potent destroyer of the rays emanating from an obscure source. The reciprocity of action established in the case of oxygen comes out here; the good radiator is found by this experiment to be the good absorber.

This result, which was exhibited before a public audience this evening for the first time, was typical of what had been obtained with gases generally. Going through the entire list of gases and vapours in this way, we should find radiation and absorption to be as rigidly associated as positive and negative in electricity, or as north and south polarity in magnetism. The gas which, when heated, is most competent to generate a calorific ray, is precisely that which is most competent to stop such a ray. If the radiation be high, the absorption is high; if the radiation be moderate, the absorption is moderate; if the radiation be low, the absorption is low, so that if we make the number which expresses the absorptive power the numerator of a fraction, and that which expresses its radiative power, the denominator, the result would be, that, on account of the numerator and denominator varying in the same proportion, the value of that fraction would always remain the same, whatever might be the gas or vapour experimented with.

But why should this reciprocity exist? What is the meaning of absorption? What is the meaning of radiation? When you cast a stone into still water, rings of waves surround the place where it falls; motion is radiated on all sides from the centre of disturbance. When the hammer strikes a bell, the latter vibrates; and sound, which is nothing more than an undulatory motion of the air, is radiated in all directions. Modern philosophy reduces light and heat to the same mechanical category. A luminous body is one with its particles in a state of vibration; a hot body is one with its particles also vibrating, but at a rate which is incompetent to excite the sense of vision; and, as a sounding body has the air around it, through which it propagates its vibrations, so also the luminous or heated body has a medium, called ether, which accepts its motions and carries them forward with inconceivable velocity. Radiation, then, as regards both light and heat, is the transference of motion from the vibrating body to the ether in which it swings; and, as in the case of sound, the motion imparted to the air is soon transferred to the surrounding objects, against which the aerial undulations strike, the sound being, in technical language, absorbed; so also with regard to light and heat, absorption consists in the transference of motion from the agitated ether to the particles of the absorbing body.

The simple atoms are found to be bad radiators; the compound atoms good ones; and the higher the degree of complexity in the atomic groupings, the more potent, as a general rule, is the radiation and absorption. Let us get definite ideas here, however gross, and purify them afterwards by the process of abstraction. Imagine our simple atoms swiveling like single spheres in the ether; they cannot create the swell which a group of them united to form a system can produce. An oar runs freely edgeways through the water, and imparts far less of its motion to the water than when its broad flat side is brought to bear upon it. In our present language the oar, broad side vertical, is a good radiator; broad side horizontal, it is a bad radiator. Conversely the waves of water, impinging upon the flat face of the oar-blade, will impart a greater amount of motion to it than when impinging upon the edge. In the position in which the oar radiates well, it also absorbs well. Simple atoms glide through the ether without much resistance; compound ones encounter this, and yield up more speedily their motion to the ether. *Mix* oxygen and nitrogen mechanically, they absorb and radiate a certain amount. Cause these gases to combine chemically and form nitrous oxide, both the absorption and radiation are thereby augmented 250 times!

In this way we look with the telescope of the intellect into atomic systems,

and obtain a conception of processes which the eye of sense can never reach. But gases and vapours possess a power of choice as to the rays which they absorb. They single out certain groups of rays for destruction, and allow other groups to pass unharmed. This is best illustrated by a famous experiment of Sir David Brewster's modified to suit the requirements of the present discourse. into a glass cylinder, with its ends stopped by discs of plate-glass, a small quantity of nitrous acid gas was introduced; the presence of the gas being indicated by its rich brown colour. The beam from an electric lamp being sent through two prisms of bisulphide of carbon, a spectrum seven feet long and eighteen inches wide, was cast upon a screen. Introducing the cylinder containing the nitrous acid into the path of the beam as it issued from the lamp, the splendid and continuous spectrum became instantly furrowed by numerous dark bands, the rays answering to which were struck down by the nitric gas, while it permitted the light which fell upon the intervening spaces to pass with comparative impunity.

Here also the principle of reciprocity, as regards radiation and absorption, holds good, and could we, without otherwise altering its physical character, render that nitrous gas luminous, we should find that the very rays which it absorbs are precisely those which it would emit. When atmospheric air and other gases are brought to a state of intense incandescence by the passage of an electric spark, the spectra which we obtain from them consists of a series of bright bands. But such spectra are produced with the greatest brilliancy, when, instead of ordinary gases, we make use of metals heated so highly as to volatilize them. This is easily done by the voltaic current. A capsule of carbon was filled with mercury, which formed the positive electrode of the electric lamp: a carbon point was brought down upon this; and on separating one from the other, a brilliant arc containing the mercury in a volatilized condition passed between them. The spectrum of this arc was not continuous like that from the solid carbon points, but consisted of a series of vivid bands, each corresponding in colour to that particular portion of the spectrum to which its rays belonged. Copper gave its system of bands; zinc gave its system; and brass, which is an alloy of copper and zinc, gave a splendid spectrum made up of the bands belonging to both metals.

Not only, however, when metals are united like zinc and copper to form an alloy, is it possible to obtain the bands which belonged to them. No matter how we may disguise the metal—allowing it to unite with oxygen to form an oxide, and this again with an acid to form a salt; if the heat applied be sufficiently intense, the bands belonging to the metal reveal themselves with perfect definition. Holes were drilled in a cylinder of retort carbon, and these being filled with pure culinary salt, the carbon was made the positive electrode of the lamp: the resultant spectrum showed the brilliant yellow lines of the metal sodium. Similar experiments were made with the chlorides of strontium, calcium, lithium, * and other metals; each salt gave the bands due to the metal. Different salts were then mixed together, and rammed into the holes in the carbon, a spectrum was obtained which contained the bands of them all.

The position of these bright bands never varies, and each metal has its own system. Hence the competent observer can infer from the bands of the spectrum the metals which produce it. It is a language addressed to the eye instead of the ear; and the certainty would not be augmented if each metal possessed the power of audibly calling out, "I am here!" Nor is this language affected by distance. If we find that the sun or the stars give us the bands of our terrestrial metals, it is a declaration on the part of these orbs that such metals enter into their composition. Does the sun give us any such intimation? Does the solar spectrum exhibit bright lines which we might compare with those produced by our terrestrial metals, and prove either their identity or difference? No. The solar spectrum, when closely examined, gives us a multitude of fine dark lines instead of bright ones. They were first noticed by Dr. Wollaston, were investigated with profound skill by Fraunhofer, and named from him Fraunhofer's lines. The bright lines which the metals give us have been also known to us for years; but the connection between both classes of phenomena was wholly unknown, until Kirchhoff, with admirable acuteness, revealed the secret, and placed it at the same time in our power to chemically analyze the sun.

We have now some hard work before us; hitherto we have been delighted by objects which addressed themselves rather to our æsthetic taste than to our scientific faculty. We have ridden pleasantly to the base of the final cone of Etna, and must now dismount and march wearily through ashes and lava, if we would enjoy the prospect from the summit. Our problem is to connect the dark lines of Fraunhofer with the bright ones of the metals. The white beam of the lamp is refracted in passing through our two prisms, but its different components are refracted in different degrees, and thus its colours are drawn apart. Now the colour depends solely upon the rate of oscillation of the particles of the luminous body; red light being produced by one rate, blue light by a much quicker rate, and the colours between red and blue by the intermediate rates. The solid incandescent coal-points give us a continuous spectrum, or in other words they emit rays of all possible periods between the two extremes of the spectrum. They have particles oscillating so as to produce red; others, to produce orange; others, to produce yellow, green, blue, indigo, and violet respectively. Colour, as many of you know, is to light what *pitch* is to sound. When a violin-player presses his finger on a string he makes it shorter and tighter, and thus, causing it to vibrate more speedily, augments the pitch. Imagine such a player to move his finger slowly along the string, shortening it gradually as he draws his bow, the note would rise in pitch by a regular gradation; there would be no gap intervening between note and note. Here we have the analogue to the continuous spectrum, whose colours insensibly blend together without gap or interruption, from the

rod of the lowest pitch to the violet of the highest. But suppose the player, instead of gradually shortening his string, to press his finger on a certain point, and to sound the corresponding note; then to pass on to another point more or less distant, and sound its note, then to another, and so on, thus sounding particular notes separated from each other by gaps which correspond to the intervals of the string passed over; we should then have the exact analogue of a spectrum composed of separate bright bands with intervals of darkness between them. But this, though a perfectly true and intelligible analogy, is not sufficient for our purpose; we must look with the mind's eye at the very oscillating atoms of the volatilized metal. Figure these atoms connected by springs of a certain tension, and which, if the atoms are squeezed, together push them asunder, or if the atoms are drawn apart, pull them together, causing them, before coming to rest, to quiver at a certain definite rate determined by the strength of the spring. Now the volatilized metal which gives us one bright band is to be figured as having its atoms united by springs all of the same tension; its vibrations are all of one kind. The metal which gives us two bands may be figured as having some of its atoms united by springs of one tension, and others by a second series of springs of a different tension. Its vibrations are of two distinct kinds; so also when we have three or more bands; we are to figure as many distinct sets of springs, each set capable of vibrating in its own particular time and at a different rate from the other. If we seize this idea definitely, we shall have no difficulty in dropping the metaphor of springs and substituting for it mentally the forces by which the atoms act upon each other. Having thus far cleared our way, let us make another effort to advance.

Here is a pendulum,—a heavy ivory ball suspended from a string. I blow against this ball; a single puff of my breath moves it a little way from its position of rest; it swings back towards me, and when it reaches the limit of its swing I puff again. It now swings further; and thus by timing my puffs I can so accumulate their action as to produce oscillations of large amplitude. The ivory ball here has absorbed the motions which my breath communicated to the air. I now bring the ball to rest. Suppose, instead of my breath, a wave of air to strike against it, and that this wave is followed by a series of others which succeed each other exactly in the same intervals as my puffs; it is perfectly manifest that these waves would communicate their motion to the ball and cause it to swing as the puffs did. And it is equally manifest that this would not be the case if the impulses of the waves were not properly timed: for then the motion imparted to the pendulum by one wave would be neutralized by another, and there could not be that accumulation of effect which we have when the periods of the waves correspond with the periods of the pendulum. So much for the kind of impulses absorbed by the pendulum. But such a pendulum set oscillating in air produces waves in the air; and we see that the waves which it produces must be of the same period as those whose motions it would take up or absorb most copiously if they struck against it. Just in passing I may remark, that if the periods of the waves be double, treble, quadruple, &c., the periods of the pendulum, the shocks imparted to the latter would also be so timed as to produce an accumulation of motion.

Perhaps the most curious effect of these timed impulses ever described was that observed by a watch maker, named Ellicott, in the year 1741. He set two clocks leaning against the same rail; one of them, which we may call A, was set going; the other, B, not. Some time afterwards he found, to his surprise, that B was ticking also. The pendulums being of the same length the shocks imparted by the ticking of A to the rail against which both clocks rested were propagated to B, and were so timed as to set B going. Other curious effects were at the same time observed. When the pendulums differed from each other a certain amount, A set B going, but the reaction of B stopped A. Then B set A going, and the re-action of A stopped B. If the periods of oscillation were close to each other, but still not quite alike, the clocks mutually controlled each other, and by a kind of mutual compromise they ticked in perfect unison.

But what has all this to do with our present subject? They are mechanically identical. The varied actions of the universe are all modes of motion; and the vibration of a ray claims strict brotherhood with the vibrations of our pendulum. Suppose ethereal waves striking upon atoms which oscillate in the same periods as the waves succeed each other, the motion of the waves will be absorbed by the atoms; suppose we send our beam of white light through a sodium flame, the particles of that flame will be chiefly affected by those undulations which are synchronous with their own periods of vibration. There will be on the part of those particular rays a transference of motion from the agitated ether to the atoms of the volatilized sodium, which, as already defined, is absorptive. We use glass screens to defend us from the heat of our fires; how do they act? Thus:—The heat emanating from the fire is for the most part due to radiations which are incompetent to excite the sense of vision; we call these rays obscure. Glass, though previous to the luminous rays, is opaque in a high degree to those obscure rays, and cuts them off, while the cheerful light of the fire is allowed to pass. Now mark me clearly. The heat cut off from your person is to be found in the glass, the latter becomes heated and radiates towards your person; what then is the use of the glass if it merely thus acts as a temporary halting-place for the rays, and sends them on afterwards. It does this:—It not only sends the heat it receives towards you, but scatters it also in all other directions round the room. Thus the rays which, were the glass not interposed, would be shot directly against your person, are for the most part diverted from their original direction, and you are preserved from their impact.

Now for our experiment, I pass the beam from the electric lamp, through the two prisms and the spectrum spreads its colours upon the screen. Between the lamp and the prisms I interpose this snapdragon light. Alcohol and water are here mixed up with a quantity of common salt, and the metal dish that contains them is heated by a spirit-lamp. The vapour from the mixture ignites, and we have this monochromatic flame. Through this flame the beam from the lamp is now passing; and observe the result upon the spectrum. You see a dark band cut out of the yellow,—not very dark, but sufficiently so to be seen by

* The vividness of the colours of the lithium spectrum is extraordinary: it contained a blue band of indistinguishable splendour. It was thought by many, during the discourse, that I had mistaken strontium for lithium, as this blue band had never before been seen. I have obtained it many times since; and my friend Dr. Miller, having kindly analyzed the substance made use of, pronounces it chloride of lithium.—J. T.

everybody present. Observe how the band quivers and varies in shade as the amount of yellow light cut off by the unsteady flame varies in amount. The flame of this monochromatic lamp is at the present moment casting its proper yellow light upon that shaded line; and more than this, it casts, in part, the light which it absorbs from the electric lamp upon it; but it scatters the greater portion of this light in other directions, and thus withdraws it from its place upon the screen, as the glass, in the case above supposed, diverted the heat of the fire from your person. Hence the band appears dark; not absolutely, but dark in comparison with the adjacent brilliant portions of the spectrum.

But let me exalt this effect. I place in front of the electric lamp the intense flame of a large Bunsen's burner. I have here a platinum capsule into which I put a bit of sodium less than a pea in magnitude. The sodium placed in the flame soon volatilizes and burns with brilliant incandescence. Observe the spectrum. The yellow band is clearly and sharply cut out, and a band of intense obscurity occupies its place. I withdraw the sodium, the brilliant yellow of the spectrum takes its proper place: I reintroduce the sodium and the black band appears.

Let me be more precise.—The yellow colour of the spectrum extends over a sensible space, blending on one side into orange and on the other into green. The term "yellow band" is therefore somewhat indefinite. I want to show you that it is the precise yellow band emitted by the volatilized sodium which the same substance absorbs. By dipping the coal-point used for the positive electrode into a solution of common salt, and replacing it in the lamp, I obtain that bright yellow band which you now see drawn across the spectrum. Observe the fate of that band when I interpose my sodium light. It is first obliterated, and instantly that black streak occupies its place. See how it alternately flashes and vanishes as I withdraw and introduce the sodium flame!

And supposing that instead of the flame of sodium alone, I introduce into the path of the beam a flame in which lithium, strontium, magnesium, calcium, &c., are in a state of volatilization, each metallic vapour would cut out its own system of bands, each corresponding exactly in position with the bright band which that metal itself would cast upon the screen. The light of our electric lamp then shining through such a composite flame would give us a spectrum cut up by dark lines, exactly as the solar spectrum is cut up by the lines of Fraunhofer.

And hence we infer the constitution of the great centre of our system. The sun consists of a nucleus which is surrounded by a flaming atmosphere. The light of the nucleus would give us a continuous spectrum, as our common coal-points did; but having to pass through the photosphere, as our beam through the flame, those rays of the nucleus which the photosphere can itself emit are absorbed, and shaded spaces, corresponding to the particular rays absorbed, occur in the spectrum. Abolish the solar nucleus, and we should have a spectrum showing a bright band in the place of every dark line of Fraunhofer. These lines are therefore not absolutely dark, but dark by an amount corresponding to the difference between the light of the nucleus intercepted by the photosphere, and the light which issues from the latter.

The man to whom we owe this beautiful generalization is Kirchhoff, Professor of Natural Philosophy in the university of Heidelberg; but, like every other great discovery, it is compounded of various elements. Mr. Talbot observed the bright lines in the spectra of coloured flames. Sixteen years ago Dr. Miller gave drawings and descriptions of the spectra of various coloured flames. Wheatstone, with his accustomed ingenuity, analyzed the light of the electric spark, and showed that the metals between which the spark passed determined the bright bands in the spectrum of the spark. Masson published a prize essay on these bands; Van der Willigen, and more recently Plücker, have given us beautiful drawings of the spectra, obtained from the discharge of Ruhmkorff's coil. But none of these distinguished men betrayed the least knowledge of the connection between the bright bands of the metals and the dark lines of the solar spectrum. The man who came nearest to the philosophy of the subject, was Angström. In a paper translated from Poggendorff's "Annalen" by myself, and published in the *Philosophical Magazine* for 1855, he indicates that the rays which a body absorbs are precisely those which it can emit when rendered luminous. In another place, he speaks of one of his spectra giving the general impression of reversal of the solar spectrum. Foucault, Stokes, and Thomson, have all been very close to the discovery; and, for my own part, the examination of the radiation and absorption of heat by gases and vapours, some of the results of which I placed before you at the commencement of this discourse, would have led me in 1859 to the law on which all Kirchhoff's speculations are founded, had not an accident withdrawn me from the investigation. But Kirchhoff's claims are unaffected by these circumstances. True, much that I have referred to formed the necessary basis of his discovery; so did the laws of Kepler furnish to Newton the basis of the theory of gravitation. But what Kirchhoff has done carries us far beyond all that had before been accomplished. He has introduced the order of law amid a vast assemblage of empirical observations, and has ennobled our previous knowledge by showing its relationship to some of the most sublime of natural phenomena.

INSTITUTION OF MECHANICAL ENGINEERS.

The annual meeting of this institution has been held this year in Sheffield. Sir W. G. Armstrong occupied the chair. The minutes of the last meeting having been read—

Sir W. G. Armstrong, proceeded to deliver his address, in which he made a severe attack on the patent laws.

A paper by Ald. John Brown, on "The manufacture of steel rails and armour plates," was then read by Mr. Marshall, the Secretary. A paper by Mr. Henry Bessemer, "On the manufacture of Cast Steel and its application to constructive purposes," was read. Next a paper by Mr. T. E. Vickers, of the firm of Naylor,

Vickers, & Co., was read, on "The effect of the combination of carbon with iron in increasing or diminishing its strength."

At the conclusion of the reading of each paper, some conversation took place upon it, and votes of thanks were awarded to the authors.

During the afternoon, several of the principal manufacturers were visited by the members of the institution. Messrs. Naylor, Vickers, and Co.'s works were the first inspected. The ingenious apparatus which Mr. T. E. Vickers, had employed for testing railway disc wheels, as alluded to in his paper given above, was inspected with much interest. It consisted of a ball, 830 lbs. in weight, suspended by an iron rod, which was drawn back by a crane to any required height, and then suddenly allowed to swing with great velocity against the wheel to be tested. The process of casting a large steel bell was also witnessed the workmen bringing up, and emptying in rapid succession, seventy-three, casting pot. After seeing other processes going on at these works, the visitors proceeded to Messrs. Bessemer and Co.'s, Carlisle street, where the Bessemer process of producing steel from the molten pig iron at one operation, as described in Mr. Bessemer's paper, was gone through. Owing to the giving way of the plug in the bottom of the vessel in which the molten iron was conveyed into the large converting vessel, much of the metal was lost, and such a shower of sparks was sent through the room that it was quickly cleared of visitors. The same process on a larger scale was also witnessed at Messrs. J. Brown and Co.'s works, to which the association next proceeded. The rolling of armour-plates, as described in Mr. Brown's paper, was also shown, and excited much interest. Unfortunately, owing to some slight accident to the machinery when the large plate was undergoing the last rolling process, the work could not be completed, but it was carried sufficiently far to show clearly to all the visitors how these wonderful defences are made. The first two plates that were sent by this firm for trial by government were not successful, and one of these, with the holes made by the balls, was exhibited, and created some interest. Other plates subsequently furnished by Messrs. Brown have very successfully resisted the battery to which they were subjected. Many of the other works in the town were also open to the members of the institution.

The meeting was resumed the next morning. Sir W. G. Armstrong again took the chair.

The first paper on the list was one by Mr. Parkin Jeffcock, of Derby, on "Mining in the South Yorkshire coal and iron district," but owing to the author having been summoned to the Clay Cross inquest, he was obliged to withdraw the paper. A paper by Lieut.-Col. Kennedy, "On the construction and erection of iron piers, and superstructures for railway bridges in alluvial districts," was therefore first read.

Mr. John Brown, of Barnsley, was the author of the next paper. The subject of which was "Metal tubing, used in sinking shafts."

Votes of thanks having been passed to the authors of papers, to the local committee, and the Hon. Local Secretary, (Mr. T. F. Cashin,) the meeting separated.

In the afternoon, the works of Messrs. Brown & Co. were again visited, to witness the process of rolling armour plates, in consequence of the mishap on the previous day; and the manufactory of Messrs. Geo. Brown and Sons, Rotherham, were also visited by members of the institution.

A full report of the papers will be given as usual.

LONDON ASSOCIATION OF FOREMEN ENGINEERS.

On the 3rd ult., the ordinary monthly meeting of the above society took place at their rooms, 35, St. Swithin's-lane, City. In the absence, through indisposition, of Mr. Joseph Newton, president, Mr. Keyte was unanimously voted into the chair. The first business presented to the consideration of the members, was in regard to a revision of the rules of the association, and upon this important subject a committee made its report.

Mr. Howbridge then read a paper

ON A WHEEL FOR LIFTING WATER AND OTHER FLUIDS.

The wheel represented is a bucket wheel, with hollow arms, made of sheet iron. Through these arms, which are in fact pipes, the water raised by the curved buckets during the revolution of the wheel would be discharged into the hollow shaft or axis upon which the wheel turned. Each arm was fitted with a self-acting gravitating valve, which would open and admit the water raised to the hollow shaft or axis, and close against its egress through the arms on the opposite side of the wheel. The arrangement of these valves appeared to be simple and yet ingenious. They would inevitably, as it seemed to us, receive the water as rapidly as it came to them, and pertinaciously refuse to part with it except through the central axis, whence it might be diverted to any channel. Mr. Howbridge remarked that the scoop wheel could not be made to throw water more than one-third its diameter, whilst the wheel he recommended would easily do so to the extent of *one-half*, thus demonstrating the fact that a smaller wheel would do the same amount of duty.

From calculations carefully made, he had satisfied himself that a 20ft. wheel, on his plan, with eighteen buckets, each 2ft. wide and 2ft. deep, and making eight and a half revolutions per minute, would lift twenty-six tons of water or other fluid per minute. This would require sixteen-horse power, or, adding one-fourth to that for overcoming the inertia of the wheel, say twenty-horse-power. The reader of the paper went further into detail, with a view to proving the superiority of the hollow armed wheel over all others yet known, and urged that it was well adapted for drainage, irrigation, and sewage purposes. On concluding he was much applauded, and, after a discussion, a vote of thanks was unanimously awarded to that gentleman. The proceedings of the evening then came to an ending.

THE YOUNG ENGINEER'S SCIENTIFIC ASSOCIATION.

A preliminary meeting of this society was held at the rooms of the association, No. 7, Salisbury Street, Adelphi, W.C.

The Chairman opened the proceedings by an address, stating that, in common with others then present, he had long felt the want of some means by which the junior members of the profession might interchange their experiences; it was therefore proposed to organise an association to discuss various subjects connected with engineering, civil and mechanical. At the conclusion of the address the code of rules was amended and finally agreed upon. The council was then elected for the ensuing year.

The ordinary session extends from December to June, inclusive, the meetings being weekly, but an extraordinary session was proposed and agreed to, to commence on Thursday, August 8th, when, after some minor matters having been disposed of, the meeting then adjourned.

On Thursday, August 8th, the President opened the proceedings by an address, in which he briefly reviewed the progress which had been made in engineering science during the present century.

At the conclusion of the address a paper was read "On Craddock's Patent Steam Boiler and Condenser," by Mr. F. Campin, Vice-President. Messrs. Potheary, Roberts, Rawlinson, and Campin partook in the discussion.

On Thursday, August 15th, a paper was read "On Cranes," by the President, Mr. A. Chapman.

REVIEWS AND NOTICES OF NEW BOOKS.

A Complete Treatise on Cast and Wrought Iron Bridge Construction, including Iron Foundations, in three parts, Theoretical, Practical, and Descriptive. By WILLIAM HUMBER, Assoc. Inst. C.E., Mem. Inst. Mech. Eng. London: E. and F. N. Spon, Bucklersbury.

The work before us consists of two bulky volumes, the first comprising about 230 pages of letter-press, and the second 80 plates. Our readers will remember that a few years since a work of a descriptive character was produced upon the same subject by the same author, and he commences the preface of the present treatise with an account of the motives which led to the issue of that work; he then proceeds to state that the work now issued is not a continuation of the subjects there treated, but quite distinct; and this statement is fully borne out by the contents of the volume.

The first, or "Theoretical Part," contains mathematical investigations of the principles involved in the various forms now adopted in bridge construction. These investigations are exceedingly complete, no step of importance being omitted in any of the calculations, and the results are brought to a practically useful form, so that the whole of this part will be found very valuable to students and the more so that there is no other work extant in the English language which so fully explains the application of mathematical science to engineering purposes.

The theories here brought forward do not appear to be entirely new, but they bear the aspect of having been very carefully considered, and they are certainly worked out to the utmost extent that can be desired by the practical man. The most striking portions of this part are embodied in the chapters on Cohesion and Elasticity, and on Shearing Strain. In the former, Mr. Humber supposes all solid bodies to consist of atoms or molecules having spheres of attraction and repulsion; and on this hypothesis he ingeniously explains the various phenomena of elasticity, ductility, and other properties of matter; he also suggests the cause of the different effects observed in cutting various materials, some splitting, whilst others are gradually divided. The author does not inform us whether he regards the atoms as at rest or in motion, information which, if sustained by evidence, would have been very acceptable. In the chapter on shearing strain the relation between vertical and horizontal force in girders is fully entered into, the investigation being also based upon the theory of *spheres of atomic attraction and repulsion*.

We now come to the second or "Practical Part," the first chapter in which is devoted to the "Practical Application of the Formula," and contains examples of the various methods of designing Iron Bridges. The author allows a considerable margin in some cases as regards strength, but this is certainly on the safe side, and it is very necessary to caution beginners against making their works too light. Instructions are also given for proportioning the bracing and other parts which do not admit of calculation. On the whole, we do not hesitate to pronounce this chapter to be very useful to all connected with bridge work. The following chapter, which treats of the manufacture of ironwork, is also useful; it contains an account of the manipulations to which the material is subject from the time it leaves the blast furnace until the girder is completed as far as can be done in the workshop; there are also some descriptions of the more complicated machinery used by the manufacturer. The very important subject of joints has been well and fully treated in the thirteenth chapter, where the strength of all kinds of joints used in bridge construction is discussed in detail, and also the proportions of the strengths of a joint and the solid plates joined, and, what is more important, the author shows how riveted joints should be arranged, in order to obtain the greatest possible efficiency.

In the chapter upon "Piers and Foundations," a rather elaborate calculation has been given, having reference to the spans suitable for piers of various heights, but, as Mr. Humber very justly observes, we must, before commencing designs, determine what is the smallest amount of metal to be practically employed in one pier of given height, and this is, to a certain extent, a matter of opinion,

hence the calculation will give different results in the hands of different persons. A brief account is given of cast iron piling and of the various methods of sinking large cylinders for iron foundations, Mr. Hughes's method being illustrated by a large plate. This chapter concludes the second part of the treatise, and here Mr. Humber's instructions are concluded, the third part being "Descriptive." Most of the bridges illustrated and described are of very considerable dimensions, and the accounts given of them are, as a rule, very complete, the specifications being in many instances inserted, thereby affording a vast amount of practical information of a very valuable character. Our author, at the commencement of each chapter in this part, gives a short review of the bridges described in that chapter, but we must here find some fault with him. He states in his preface that the bridges illustrated must not be supposed in every case to exhibit perfection but only practice, and we certainly think that he ought to have pointed out such structures as exhibit the results of gross errors of calculation. The Trent Lane, Saltash, Windsor, and some other bridges of good design are very fairly treated, due praise being awarded in each case, but why does Mr. Humber pass over the Bridge of Carlos Gomes with so slight a notice of its imperfections? it is true he does not praise it, but that would be almost impossible. This structure, a continuous girder bridge of two spans, has the same sectional area in each flange throughout, and has evidently been calculated upon the supposition that the maximum strain exists somewhere near the centre of one span, and this our readers may ascertain, by calculating the strain on the flanges over the piers, where they will find it amount to 8 tons per sectional square inch. This is, we think, the only work exhibiting such gross incompetency on the part of the engineer who designed it; but there are others which are by no means in accordance with received notions. The bracing of the Elbro Bridge is decidedly too light, whilst that in the Murillo is certainly heavy.

On the other hand we may point to the Lerida and Alcanadre Bridges as very excellent specimens of light, but sound designs, very creditable to their engineers.

The tables are of a very useful character, containing the results of the most recent experiments, and amongst them are some valuable tables of the weight and cost of cast and wrought structures actually erected.

The volume of text is amply illustrated by numerous woodcuts, plates, and diagrams, and the plates in the second volume do great credit to both draughtsmen and engravers. In conclusion, we have great pleasure in cordially recommending this work to our readers as being a great improvement upon the previous work on the same subject by the same author,

CORRESPONDENCE.

We do not hold ourselves responsible for the opinions of our Correspondents.

THE ROYAL YACHT "VICTORIA AND ALBERT."

To the Editor of the Artizan.

SIR,—The visit of Her Majesty to Ireland appears to have settled a very interesting scientific fact, namely, what is the speed of the yacht *Victoria and Albert*?

There has been a prevalent idea that she is the fastest vessel afloat and superior in speed to the new Holyhead Mail Packets recently put upon that station.

It may not be generally known that the *Victoria and Albert* was tried at Stokes Bay upon the 23rd July, 1855, and the following results were registered as having been obtained by the dockyard officials upon that occasion:—

Mean draft of ship	13ft. 11in.
Area of midship section	401 sq. ft.
Indicated power exerted	2980 horses.
Velocity per hour, in knots	16'82.

If, therefore we desire to obtain the "mechanical performance," or what our friend Mr. Atherton calls the index number of these experiments, we have

$$\frac{16'82^3 \times 401}{2980} = 640 \text{ ratio to knots.}$$

I have always considered these results as illusory and untrue, we all know that many of us can run one mile, but not two, and the general system observed on these occasions, that of getting up the steam to the highest point, and then starting on a run of a single mile is not a true way of deciding a question of speed, and such a course can only lead to false conclusions, and is nothing more than a delusion and entirely useless in a scientific point of view.

But a run across the Irish Channel is quite another affair, and the results may fairly be taken as an index of the capability of the ship.

The distance from Holyhead to the entrance to Kingstown Harbour is stated by the best authorities to be 64 statute miles, or barely 56 geographical miles.

Upon the evening of the 21st inst., the yacht left Holyhead for Kingstown, Her Majesty on board, and it is reasonable to conclude that all exertion was made to get across as soon as possible; the tide was fair and sea smooth, from the best authority, that of the pilot on board, she left Holyhead at 7.18 p.m., and reached Kingstown at 11.25, English time, or say running the distance of 56 knots in 4 hours and 7 minutes = 13'6 knots per hour.

We have no information as to the draft of water, or the indicator power exerted upon this occasion, but it is reasonable to infer that the latter would not be less than that used upon the trials at Stokes Bay, namely, 2980 horses. Then again searching for Mr. Atherton's index numbers, we have the following as the true speed and performance of the yacht *Victoria and Albert*.

$$\frac{13'6^3 \times 401}{2980} = 338'5 \text{ ratio to knots.}$$

Now let us turn our attention to what has been regularly done by the new

Holyhead packets for nearly twelve months past, during all sorts of weather, of a more than average bad quality.

There are four vessels in all, but it will be sufficient to confine our attention to two, the *Leinster* and the *Ulster*.

The shortest passage made by the *Leinster* was (under favourable circumstances) completed in 3 hours and 15 minutes, and a similar passage was made by the *Ulster* in 3 hours and 18 minutes; these varied from the foregoing to 3 hours 20 minutes up to 3 hours 30 minutes, from which we may very fairly strike an average.

The draft of these ships is about..... 13ft. 6in.
Area of midship section 350 sq. ft.
Indicator power exerted 4100 horses.

Say *Ulster's* passage of 3 hours 18 minutes = 16.97 knots per hour, our performance or index number then becomes this

$$\frac{16.97^3 \times 350}{4100} = 416.9 \text{ ratio to knots.}$$

But it may be argued these passages are exceptional, let us then take the average at 3 hours 30 minutes or 16 knots per hour, and we have thus

$$\frac{16^3 \times 350}{4100} = 349.6$$

With what truth then can it be asserted that the *Victoria and Albert* has a higher and, therefore, a better performance than that of the Holyhead packets? Certainly not from what has recently taken place, and it ought not to be deduced from the exceptional and solitary trial in Stokes Bay, before referred to. If there is any doubt, put the vessels alongside each other, and then the bubble will burst, and that very overweening Admiralty conceit will be abated, and it will be seen that the designer of the yacht must lower his colours and play second fiddle to Messrs. Samuda, of London, and Laird, of Birkenhead, the respective designers of the *Leinster* and *Ulster* mail ships.

I am, dear sir, yours very truly,
A MARINE ENGINEER.

26th August, 1861.

P.S.—A reference was made in the *Times* to the long passages of the *Comnaught*—it may perhaps be best to state that for some time past the passages of these packets have been purposely restricted to 3 hours 45 minutes, and this they perform with marvellous accuracy; if they are longer it must arise either from fogs or very bad weather. On a recent occasion, Lord Paget was, in your presence, informed that these packets were two knots an hour faster than the Yacht, and you also know, from personal observations, that the difference is great; it may be most unpalatable, but, nevertheless, it is so.

NOTICES TO CORRESPONDENTS.

LOCOMOTIVE.—1. The formula generally applied by the Admiralty is as follows:

$$128 \sqrt[3]{s} = \text{velocity of piston in feet per minute.}$$

$s = \text{stroke of piston in feet.}$

But in screw engines of high piston velocity, the actual velocity must be used in the formula for calculating the nominal horse power.

2. The power required to propel a vessel through the water is as the cube of the velocity; hence if you place a pair of engines of 450 horses' power into a ship that used to be propelled by 300 horses' powers at a velocity of $9\frac{1}{2}$ knots per hour, what will be the velocity?

$$\sqrt[3]{\frac{9.5^3 \times 450}{300}} = \sqrt[3]{1286.06} = 10.87 \text{ knots per hour.}$$

3. The rule for piston rods does hold good for locomotives, but you must remember that it is left to yourself to choose your co-efficient of crushing force, and what safety will be necessary for marine engines (as in our example) will not be required for locomotives; besides lightness is a material point to be considered in the construction of locomotives. At any rate the size of the piston rod for locomotives cannot be put down as $\frac{1}{4}$ or $\frac{1}{10}$ part of the diameter of cylinder, but the steam pressure must always be taken into consideration.

YOUNG ENGINEER.—The divisor 118 used in the example (page 177) is obtained

in the following manner:—In the formula $c = \frac{Wl}{S}$; S is the breaking weight in lbs. for a wrought iron bar 1 in. square and 1 ft. long, supported at the ends, which we will call as a good medium 4000 lbs.; but as the gndgeon in this case is a crankpin, belonging to a single crank, it must be considered as a beam No. II. (see page 132), which "Young Engineer" would have seen at the top of page 178; consequently S will be equal to 2000 lbs., and taking 10 as the factor of safety, makes 200 lbs. Now as all these rules (page 132) are for rectangular beams, and this present one is a round one, and a round one is only .589 in strength, when a square one is 1, we must of course multiply $200 \times .589$, which is equal to 117.8, say 118.

J. W. (Alexandria).—The additional information in your last communication does not materially alter our answer given last month. Shall be glad to hear from you in return as to anything of interest. Mr. Humphreys will write to you respecting the fuel apparatus.

D. C. L.—We will forward your papers to the proper quarter.

J. N. (Philadelphia).—Have been anxiously awaiting replies to our last two letters.

W. F. B. (Glasgow).—Send the remainder.

DELTA.—The work was written by a Dr. Zernikow, of Erfurt.

WELBY (Emerald Hill, Melbourne).—We await your reply.

D. R. (Dumfries).—Both excellent things.

GREAT EASTERN, R. N., YOUNG ENGINEER, B., &c.—The times given are the actual times.

C.—Apply to the Admiralty.

J. L. W. (Edinburgh).—Your design is under consideration.

R. B. (Newport, Monmouthshire).—We cannot find any such diagram or wood-cut as that referred to.

RECENT LEGAL DECISIONS

AFFECTING THE ARTS, MANUFACTURES, INVENTIONS, &c.

UNDER this heading we propose giving a succinct summary of such decisions and other proceedings of the Courts of Law, during the preceding month, as may have a distinct and practical bearing on the various departments treated of in our Journal: selecting those cases only which offer some point either of novelty, or of useful application to the manufacturer, the inventor, or the usually—in the intelligence of law matters, at least—less experienced artizan. With this object in view, we shall endeavour, as much as possible, to divest our remarks of all legal technicalities, and to present the substance of those decisions to our readers in a plain, familiar, and intelligible shape.

BAWER v. MACKAY.—CLAIM FOR PERSONAL INJURY.—The plaintiff, Dennis Bawer, was employed by the Great Northern Railway Company in taking an account of the cargo of the Australian ship *Ocean Chief*, while discharging in the Coburg Dock, in March last. Whilst so engaged two bales of wool rolled off a cart belonging to the defendant, who is one of the firm of Thompson, Mackay, & Co. carters, of Manchester and Liverpool. The man was severely injured, sustained concussion of the spine, and a serious shock to the nervous system, and in consequence of the injury was unable to work for upwards of a month. He had also incurred surgeons' charges to the amount of £3 5s. 6d. It was alleged that the accident occurred through the negligence of the defendant's servants, in not having properly secured the bales on the lorry, and in support of this version of the case several witnesses were called. On the other hand, it was urged that the occurrence was an entire accident, over which none of the defendant's servants had control, and that the plaintiff had exaggerated the extent of his injuries. The jury returned a verdict for the plaintiff, damages, £15.

NOTES AND NOVELTIES.

OUR "NOTES AND NOVELTIES" DEPARTMENT.—A SUGGESTION TO OUR READERS.

We have received many letters from correspondents, both at home and abroad, thanking us for that portion of this Journal in which, under the title of "Notes and Novelties," we present our readers with an epitome of such of the "events of the month preceding" as may in some way affect their interests, so far as their interests are connected with any of the subjects upon which this Journal treats. This epitome, in its preparation, necessitates the expenditure of much time and labour; and as we desire to make it as perfect as possible, more especially with a view of benefiting those of our engineering brethren who reside abroad, we venture to make a suggestion to our subscribers, from which, if acted upon, we shall derive considerable assistance. It is to the effect that we shall be happy to receive local news of interest from all who have the leisure to collect and forward it to us. Those who cannot afford the time to do this would greatly assist our efforts by sending us local newspapers containing articles on, or notices of, any facts connected with Railways, Telegraphs, Harbours, Docks, Canals, Bridges, Military Engineering, Marine Engineering, Shipbuilding, Boilers, Furnaces, Smoke Prevention, Chemistry as applied to the Industrial Arts, Gas and Water Works, Mining, Metallurgy, &c. To save time, all communications for this department should be addressed "19, Salisbury-street, Adelphi, London, W.C." and be forwarded, as early in the month as possible, to the Editor.

MISCELLANEOUS.

MONIES COINED.—Within the last ten years there have been coined at the Mint 48,911,848 sovereigns, 14,416,569 half-sovereigns, 466 crowns, 1,493 half-crowns, 15,633,372 florins, 23,025,506 shillings, 21,735,133 sixpences, 1,880,874 groats, 41,680 fourpences, 13,605,101 threepences, 47,520 silver twopences, and 73,408 silver pence. The copper and bronze money coined has been 23,232,384 pence, 35,739,421 halfpence, 22,456,276 farthings, and 3,535,776 half-farthings.

ROAD LOCOMOTIVES.—The bill to regulate the use of locomotives on common roads has now become law, and is expected to lead to important results in cheapening the transit of heavy goods. For many years back great efforts have been made to use steam on common roads, but they have perseveringly been defeated by the opposition of the local trustees, who imposed prohibitory tolls. Some time back experiments were made in conveying coals, &c., by traction engines, which proved, not only that an immense saving could be effected, but that the wear and tear of the roads was diminished. Yet the toll charged amounted to 4s. per ton, against 3½d. per ton for coal drawn by horses. The new bill, however, assimilates the tolls to be charged in a great degree to those charged for horse traffic; and although it comprises various regulations which will probably be found to be needless or vexatious, it seems sufficiently wide to enable the method to have at last a fair field.

THE MERCHANT SERVICE.—The 20,119 British vessels, exclusive of river steamers, employed in our home and foreign trade in the year 1860 (tonnage, 4,251,739), not including repeated voyages, were manned by 191,888 persons. The masters were 20,296 in number; the mates, 21,069; petty officers, 13,264; able-bodied seamen, 62,787; ordinary seamen, 17,514; apprentices and boys, 23,041.

BARRACKS AND HUTS.—Within the last twenty years there have been expended on barracks and huts.—At Colchester, £117,757; at Pembroke, £61,241; at Shoeburyness, £84,927; at Shorncliffe, £210,289; at Hythe, £26,864; at Fleetwood, £18,380. Much further expenditure is proposed, and has been approved by the government—£50,000 for cavalry barracks at Colchester; £27,000 for additional accommodation and works, including a new church at Shoeburyness; £4,000 at Sborncliffe; and about the same sum at Hythe; and at Fleetwood, £10,000 for purchase and alteration of bath house, &c., nearly £10,000 more for hut encampment, and in a future year £18,000 for permanent barracks and hospital.

BORING THROUGH MOUNT CENIS.—A communication from an engineer, addressed to a Milan paper, gives some details respecting the cutting of this tunnel. The opinion of the scientific men who were present at the experiment is, that the mechanical difficulties of the cutting will be fully overcome. The perforating machines in somewhat less than an hour, made seventy holes in the mountain at the end of the opening. The holes which were made in the centre, in order to permit a breach to be effected by blasting, were three centimètres (rather more than $\frac{1}{4}$ inch) in diameter; the others made round it for the same purpose were two centimètres. The depth of the holes was from 60 to 90 centimètres (rather more than 23 inches to about 35 $\frac{1}{2}$ inches). From repeated experiments made in masses of schist with a single perforating instrument, it was proved that ten minutes' labour was sufficient to make a hole of 60 centimètres; whereas, by the ordinary means, three workmen would be employed for an hour in effecting one. The machine cuts simultaneously twenty to thirty holes in a space of four square metres, that is one in which it would not be easy to employ three or four men. The machine, however, must be dragged back a distance of 100 metres or more, when blasting has to be resorted to, and it cannot be worked again until after the ground is cleared of the fragments of rock, and until the front of the mountain is made tolerably smooth. It is estimated that the cutting of the tunnel can be terminated in 1864.

CUTTING AND SHAPING FIGURES.—In constructing and working stamps for cutting and shaping metal, Mr. Wm. Darby, of Birmingham, proposes to make the ram or hammer of the stamp hollow, so as to constitute a box, into which he screws or otherwise fixes weights for adjusting the weight of the said ram or hammer to the work to be affected by it. The ram works between two uprights, as usual, and rises and falls thus:—To the upper part of the ram he fixes a projection or tooth, under which tooth curved arms or cams, on a rotating horizontal shaft or axis, engage and lift the said ram. When the ram has been lifted to the proper height by one of the cams, the cam escapes from under the fixed projection, and the ram falls by its own weight, and operates upon the sheet metal or article placed on the fixed die, on the bed of the stamp. The horizontal shaft carrying the curved arms or cams is fixed in bearings about the same height as the tooth or projection on the ram, and motion is given to the said shaft by steam or other power. Two or more stamps may be worked from the same shaft, and by shortening or lengthening the arms, the force of the blow may be regulated.

CENSUS OF PARIS.—It appears from the returns made by the officers appointed to take the late census, that the population of Paris amounts to 1,700,000 souls. In the year 1789 Paris contained but 650,000 inhabitants; in 1817, they amounted to 713,966; in 1841, to 935,261; and in 1851 they counted above a million.

THE SCIENCE MINUTE.—A short time since the foundation stone of a large Mechanics' Institution was laid at Wolverton Railway Works by the Duke of Sutherland. The building, with class room, lecture hall, reading rooms, and offices, will not cost less than £4000. As there are nearly 2000 men, apprentices, and others engaged on this station, and as many of them are anxious to improve the leisure of the long winter evenings, it was decided to hold a public meeting, and invite Mr. Buckmaster to deliver an address on the recent minute of the Department of Science and Art, with a view of seeing how far it could be applied to the secondary instruction of the mechanics in this locality. J. E. McConnell, Esq., the engineer of the company, occupied the chair, and expressed himself highly favourable to the object of the meeting, at the same time regretting that science instructors had hitherto met with so little encouragement. Mr. Buckmaster then explained the nature of the Science Minute, and the conditions upon which assistance is given to science classes in connection with mechanics' institutions. The function of the Science and Art Department merely extends to the certification of the teachers, the examination of pupils, and payments on successful results. Mr. Buckmaster then reviewed the gradual progress in inductive science, and concluded a very animated and practical address, which was listened to with great attention, and frequently applauded. The meeting was then addressed by Mr. McCrindle and other gentlemen; and, after the usual thanks to the lecturer and the chairman, the meeting separated with the understanding that classes would be formed, and placed in connection with the South Kensington Museum.

NEW DIVING APPARATUS.—The experiments with the diving apparatus on the plan suggested by Mr. White, surgeon, of Finchley, were resumed on the 3rd ult, at Portsmouth Dockyard, in the presence of the officials of the establishment, by order of the Commissioners of the Admiralty. Mr. White's invention consists of a cylinder in lieu of the ordinary diving dress, and of two vulcanized india-rubber tubes in lieu of an air-pump for the supply of air. The tubes are used by Mr. White both with the customary diving dress and helmet when the work to be done lies on the ground, and with the cylinder when the latter is used for cleaning the bottoms of iron ships. The cylinder in use on the 3rd ult, was roughly formed of wood, and hooped with iron. It leaked so much that it could be kept under water no length of time. The cylinder is constructed of sufficient size to contain a man, and with room enough to give play to his shoulders, his arms working free outside through holes in the case fitted with vulcanized india-rubber sleeves. These, however, can be readily dispensed with if the operation to be performed is simply the scraping of the vessel's bottom, a scraper being fitted in front of the cylinder with its handle working from the interior through an india-rubber valve. The top of the cylinder is closed by a cap, in which are glass lights to enable the man to see his work, and which is fastened by india-rubber springs and hooks from the inside. A brass nut screws into the centre of the cylinder cap through which pass two india-rubber tubes for the supply of fresh air, and the discharge of the heated air from the cylinder. The supply pipe is fitted with a mouthpiece. By a simple contrivance it is fastened over the mouth of the man inside the cylinder, who thus draws each breath directly through the tube from the surface of the water overhead. Each respiration of the air to any portion of the ship's bottom can be counted by those in charge of the tube ends by the working of a slight valve at the end of the supply tube, the stoppage of which will at once indicate that something is wrong below. There are other means of safety. Through the two tubes which supply the fresh air and discharge the heated air, conversation to any extent may be kept up between the man at work below, and those who are in attendance upon him above, by which means he also directs their movements of the cylinder to any portion of the ship's bottom to which his work may require him to go. In the event of any sudden and unforeseen danger, when there is no time to communicate by speech through the tube, the man can cast loose the springs of the cylinder cap, and, throwing it off, rise to the surface of the water in his inflated india-rubber life-jacket. Although the trial was necessarily short yesterday, owing to the leakage of the cylinder, it was

quite sufficient to prove the soundness of the principle, and its adaptability, at a wonderfully cheap rate, for cleansing the bottoms of iron ships when afloat, and without the means of docking.

PLATINUM COATING FOR PORCELAIN CRUCIBLES.—Elsner gives the following as a method by which a strong covering of metallic platinum may be given to porcelain vessels. Platinum-black is rubbed up with oil of turpentine, and the mixture is painted over the object to be coated, made red-hot. The vessel coated is then enclosed in a capsule, and well burnt in a furnace, after which it will be found perfectly covered with a strongly fixed covering of metallic platinum. Platinum-black was found to be fusible, in the strongest heat of the furnace oven in the Royal Porcelain Manufactory at Berlin.

IMPROVEMENT IN STREET LIGHTING.—It has been ascertained that by placing near the flame of ordinary gas burners a receptacle containing coal naphtha, the brilliancy of the light is much increased. If it further stated that by the use of this process a saving of one half may be made in the expense of lighting by gas. To test the accuracy of this assertion, experiments have lately been made in London under the authority of the Commissioners of Sewers. Moorgate Street was selected for the trial, there being in it few shops, and only one or two private lamps. The lamps experimented on were twelve in number, six upon the western side, fitted in the ordinary way with burners, and consuming upon the average five cubic feet of gas an hour; and six upon the eastern side fitted with burners having attached to them the newly invented apparatus, and consuming two and a half cubic feet an hour. The experiment extended over thirty nights. The burners without the apparatus consumed about 439 cubic feet per hour; while the burners with the apparatus consumed only 209 cubic feet per hour. The district inspector of the commission, who saw the lamps nightly, reported that the light given was perfectly equal. The engineer of the commission, who principally conducted the experiments is, however, inclined to think that the lights are not equal in density. He states that three cubic feet of gas, carburated by means of the Naphtha, are equal to five cubic feet of gas not carburated. On this assumption he shows that by the adoption of the new process the reduction of the cost of each lamp a year will be 20s., and that the annual saving in the city would be £2825.

LIME LIGHT.—On the 26th ult. this light was substituted for the ordinary oil light of Fresure, in the South Foreland Lighthouse, and will be continued for the next three months, by order of the Trinity Board. The effect of this light is very brilliant.

LIGHT.—M. de St. Victor has lately communicated to the Academy of Sciences, a new series of observations on the persistent activity of light. He exposes to a bright sunlight, for two or three hours, a piece freshly broken from an opaque porcelain plate, and afterwards laid it upon paper prepared with chloride of silver. After twenty-four hours of contact, there was a reduction of the salt of silver upon that part which had been exposed to the light, and none upon the remaining portion of the plate. A plate of steel partly polished, and partly unpolished, by means of a strong solution of aquafortis, and washed perfectly clean with alcohol, has been dried in the sun under the following regulations:—One-half of the before mentioned unpolished and polished plate, under an opaque screen, the other half under white glass. The plate was afterwards covered with paper prepared with chloride of silver albuminised. After twenty-four hours of contact, an impression was obtained upon the unpolished part which had been exposed to the light, but no impression was made upon the polished part or unpolished part placed under the screen. Glass treated in a similar manner gave similar results. M. Armand, a chemist of Turin, has repeated these experiments in different cases with the same results as in the open air. It has been often stated that light will magnetise a bar of steel, but, according to the experiments of M. de St. Victor, this is a mistake. He has tried several experiments upon fine needles, but he has not succeeded, and concludes, therefore, that this activity of light, illustrated by the preceding experiments, is not owing to electricity or magnetism. From his experiments with magnetised and unmagnetised needles, he concludes that light has no effect upon their electricity. He concludes from all his experiments that this persistent activity given by light to all porous bodies, even the most inert, is not the same as phosphorescence, as it does not last so long. There is, therefore, most probably, a radiation of light invisible to our eyes—a radiation which resembles that of gas, as it acts upon and does not pass through the glass. With light alone it is impossible either to magnetise or demagnetise any body.

NEW MOTIVE POWER ENGINE.—In an invention just patented by Mr. Newton, three stationary steam tight cylindrical chambers are employed, the middle one being fitted with a turbine of an approved construction, mounted upon a vertical shaft, which turns in bearings carried by the cylinder head. This middle cylinder is connected to each of the side cylinders by means of two pipes, one of which (from each cylinder) enters the middle cylinder above the face of the turbine, and the other below the turbine. Each pipe is governed by a shutter valve, the slots or shutters in the upper pipes opening inwards to the middle cylinder, while those in the lower pipes open to the side cylinders. These two side cylinders are connected at top by a branch steam pipe leading from a boiler, and in the prolongation of these branches (within the cylinders) cut-off valves are mounted. By the axial motion of these valves, the steam is cut off, and exhaust pipes brought into connection with the cylinders. The working of the valves is effected by annular floats that are suspended in the cylinders from pendant rods, and which, by means of cranks and horizontal rods, are connected to arms keyed to the bottom of the valve spindles. To ensure the proper relative action of these valves, the upper ends of their spindles are connected together by means of short levers, which they carry, being coupled by an adjustable coupling rod. A driving pulley is keyed to the turbine shaft for transmitting the rotary motion of that shaft to the mechanism to be driven by the engine.

COTTON MANUFACTURES.—The astonishing development of the British cotton manufacture of late years much surpasses the conceptions generally formed on the subject. Thus the value of the cotton exported in 1843 was £16,254,000, and of the cotton yarn £7,193,971. Three years later, in 1846, the totals had reached £17,717,778, and £7,982,048 respectively; in 1849 £20,071,046 and £6,704,089; in 1852 to £23,223,432 and £6,654,655; in 1855, to £27,578,746 and £7,200,395; in 1858 to £33,421,843 and £9,579,479; and last year, to £42,141,505 and £9,870,875. In the first half of the eighteen years the value of the exports of cotton goods was, in round numbers, £230,000,000, and in the second half £340,000,000, showing an increase of nearly 48 per cent. in the latter period over the former. It is to be remarked that while the value of the goods exported increased during the last nine years 48 per cent., the quantity of the raw material imported has increased 58 per cent., the difference in all probability being accounted for by increased home consumption.

NAVAL ENGINEERING.

STEAM CRANES.—The first of the powerful steam cranes which Messrs. Taylor, of Birkenhead, the patentees, have entered into a contract for supplying the Admiralty, has been successfully fixed in its place on the tramway which extends the whole length of the dock at Chatham, in which the *Achilles*, 50, will be built. Four of these portable steam lifts are to be employed in raising the massive beams, armour plates, and other heavy portions of the ironwork used in the construction of the vessel, and each will lift a weight of five tons.

THE "SALAMIS."—On the 11th ult., the shipwrights commenced laying the blocks at Chatham Dockyard for a new four gun despatch boat, to be called the *Salamis*. Her principal dimensions will be:—Length between perpendiculars, 220ft.; extreme breadth,

28ft. 2in.; depth in hold, 14ft. 6in. She will be fitted with a pair of engines of 250 H.P. (nominal).

THE "ARETHUSA," 51, which has been several months in progress at Chatham Dockyard, converting from a sailing ship to screw steamer, is at length completed; and the *Orpheus*, 31, 400 H.P., has taken her place to be completed for sea. The *Arethusa* is now one of the finest 51 gun frigates afloat. Her engines are of 500 H.P. (nominal).

THE "WARRIOR."—On the 8th ult. this magnificent frigate made her first brief voyage from Blackwall to Greenwich. Beyond the fact of its being the first voyage, there was not much of interest in the proceeding. She had the assistance of several powerful steam tugs, and was under steam herself, and answered her helm so readily as always completely to be in hand. With such aid, notwithstanding the very strong wind, and sharp turns in the river, she proved as manageable as a yacht, and, within two hours of her leaving the Victoria Dock, was quietly swinging to her anchor a little above Gravesend. The engines worked with an ease which, considering their immense size and newness, was almost marvellous. Not a single part required alteration, or even adjustment of any kind whatever. At full speed at sea, it is expected her engines will make 62 revolutions per minute, which will give her a speed of 18 knots, and, allowing one eighth for "slip," there will be a speed of 15 knots per hour.

THE "DEFENCE," "RESISTANCE," AND "ACHILLES."—The armaments intended for these iron-clad vessels are announced as follows:—The *Defence* and *Resistance*, of 1,462 tons each, and to be fitted with engines of 600 nominal H.P., and have two 100-pounders on the upper deck, sixteen 100-pounders as side guns on the main deck, and four 40-pounders also on the main deck. The *Achilles* will be provided with thirty-four 100-pounders on the main deck; on the upper deck there will be two 100-pounders on revolving carriages; there will be eight of the same on sliding carriages; four 40-pounders on truck carriages; and two 32-pounders, smooth bore, of the old cast iron ordnance; making a total of 50 to the *Achilles*, and 22 each to the *Defence* and *Resistance*.

THE "DUNCAN," 101, screw, was taken out of Portsmouth Harbour on the 26th ult. In her supposed final trial at the measured mile in Stokes' Bay, with a Griffith's propeller she realized a speed of 11.500 knots, accompanied, however, with an extraordinary amount of vibration.

NAVAL ENGINEERS.—The following appointments have taken place since our last:—A. M'Innes, Chief Engineer to the *Virago*; R. Humble and J. W. Lievenicht, Acting Second-class Asst. Engineers, to the *Fianguard*, as supernumeraries; P. M'Cormack, G. Nicholls, J. W. Compton, B. F. Levard, and G. Fabian, Acting second-class Asst. Engineers, to the *Asia*, as supernumeraries; W. C. Amos and D. Dixon, Acting second-class Asst. Engineers, to the *Cumberland*, as supernumeraries; J. Dows and G. Fraser, Acting second-class Asst. Engineers, to the *Virago*; Richard Williamson, Chief Engineer, to the *Indus*, for charge of the machinery of the *Valorous*; H. Ryder, F. Andrew, and W. H. Moon, Acting second-class Asst. Engineers, to the *Indus*, as supernumeraries; C. Salmon, Acting second-class Asst. Engineer, to the *Asia*, as supernumerary; T. H. Walker, Acting second-class Asst. Engineer, to the *Cumberland*, as supernumerary; W. H. G. Webb, W. S. Thompson, John Bailie, W. G. Paige, and W. R. B. Braving, Acting second-class Asst. Engineers, to the *Indus*, as supernumeraries; C. Alsop, Acting second-class Asst. Engineer, to the *Asia*, as supernumerary.

STEAM SHIPPING.

THE "VASCO ANDALUZ" was launched on the 11th ult. from the yard of Messrs. Tod & McGregor, of Partich, and is intended to run between Bilbao and Seville. Her dimensions are as follows: 163ft. long, 25ft. breadth of beam, 12ft. deep, and 495 tons burthen, and she is being fitted with a pair of direct acting surface condensing engines of 60 horse-power.

THE "HEBE."—A splendid screw steamer was lately launched from the building yard of Messrs. C. and W. Earle, at the Victoria dock on the Humber. This vessel is intended for the St. Petersburg trade, and her engines are of the most superior description, being of 100 H.P. Her dimensions are, length, 220ft.; breadth, 29ft.; depth, 21ft. Tonnage, builder's measurement, 1000 tons.

THE "MORPHER."—This fine iron paddle steamer of 700 tons, built for the Hunter River New Steam Navigation Company, of Australia, was launched from the building yard of Messrs. Mitchell's, on the 13th ult. Her dimensions are as follows: length on water line, 209ft.; breadth, 25ft. 3in.; depth, 13ft. This steamer has been designed for a high speed, from plans of Mr. Dudgeon, of London, and her builders guarantee a speed of 14 knots. The engines are being manufactured by Messrs. Morrison and Co., Osborne Engine Works. They are oscillating cylinders, of 53in. diameter each, and a collective power of 200 horses.

THE "PETERHOFF," an iron screw steamer of 930 tons register, built under special survey, and classed A 1 for nine years, was recently launched from the yard of Mr. T. R. Oswald. Her measurements are 220ft. extreme length, 29ft. breadth of beam, 17ft. depth of hold, and 1000 tons builder's measurement. Her engines are of 110 nominal H.P.

TRIAL TRIP OF THE "SICILIA."—The new screw steamer, belonging to the London and Mediterranean Steam Navigation Company, recently made her trial trip in the Thames. The *Sicilia* is a beautifully modelled craft of 800 tons builder's measurement. Her dimensions are: 200ft. long, 28ft. beam, 17ft. depth of hold. Her engines, which are 110 nominal horse-power, combine high and low pressure, with surface condenser, and cellular and tubular boilers, made by Messrs. Stephenson and Co., of Newcastle, under the patents of Messrs. Rowan & Co. of Glasgow. There are six cylinders, three on each side. The middle one of the three is 12½in. in diameter, and into this the steam is first directed, and then escapes into one of the other cylinders, which are each 25in. in diameter, and after being utilized in it and the third, passes into the surface condenser. The cylinders work with one connecting rod of 25½in. stroke. There is but one boiler, which is admirably constructed. It has 55 square feet of grating for the furnaces, which are four in number, and 2800 square feet of heating surface. The following are the results of the trial:—

- 1st. run against the tide, 9.2 or 6.642 knots.
- 2nd run with the tide, 5.0 or 12.000 knots.
- 3rd run against the tide, 7.58 or 7.531 knots.
- 4th run with the tide, 5.6 or 11.765 knots.

Mean speed of all the runs, 9.495 knots per hour; average of revolutions, 74; pressure, 115lbs. per square inch; coal consumed on a trial of several hours, averaged 5 cwt. per hour, which, at the power developed, would be equal to 1.36lbs. per indicated H.P. per hour, or considerably less than one-half of the consumption of the best class of ordinary mercantile or Government marine engines.

THE ATLANTIC ROYAL MAIL (GALWAY) COMPANY.—At a recent meeting of this Company, the report stated that the speech of Lord Palmerston in the House of Commons on the 6th ult., was considered, in effect, to amount to a positive assurance that the Government will restore the contract and subsidy, if the company can prove their ability to carry out the service. The shareholders are, therefore, called upon to subscribe towards the £600,000 preference capital about to be issued, which will insure the acquisition of a full and efficient fleet. Active measures have already been taken to strengthen the steam ships, and to adapt them to the requirements of the Admiralty, and contracts for that purpose have been entered into with Messrs. Laird, of Birkenhead,

After some discussion the report was adopted, and the resolution to raise £600,000 in 7 per cent. preference shares was confirmed.

"ST. ANDREW."—On the 8th ult. there was launched from the building yard of Messrs. Barclay, Curle, & Co., Whiteinch, a large screw steamer, which was named the *St. Andrew*. Her dimensions are 250 by 33½ by 22 feet—admeasuring about 1400 tons. She has a full poop and topgallant forecastle, with line of deck houses between. She is to have engines by the same firm, of 165 horse power, fitted with J. F. Spencer's surface condensers, and other modern improvements for the saving of fuel; working pressure, 50 lbs. The owners are Messrs. James & Alexander Allan, of the Montreal Ocean Steamship Company, and the ship is intended for the Glasgow and Montreal trade.

THE "ST. GEORGE," a fine screw of 1400 tons, was recently launched from the building yard of Messrs. R. Steele and Sons, of Greenock. This vessel is 250ft. long, 33ft. 6in. broad, and 22ft. deep. This vessel, which is intended to ply between Glasgow and Montreal, will be fitted with engines of 165 horse-power. A similar screw built for the same owners by Messrs. Barclay, Curle, & Co. of Whiteinch, is as nearly as possible of the same tonnage and dimensions; she is to be fitted with engines of 150 H.P., and is intended for the same line as the *St. George*.

THE "NOWEGIAN," screw steamer, fitted with Spencer's patent engines and surface condensers, and whose trial trip to Londonderry was so satisfactory, arrived on her return voyage home on the 27th ult., after a most rapid and successful run. This vessel is sister ship to the *St. George* and *St. Andrew*.

"NORTH EASTERN."—On the 24th ult. a splendid new iron screw steamer was launched from Messrs. J. W. Richardson & Co.'s yard, on the Tyne. The dimensions of the vessel—which is intended to form one of the new Diamond line to run between Tyne Docks and St. Petersburg—are, length, perpendiculars, 190ft.; breadth of beam, 27ft.; depth, moulded, 16½ft. She is rigged as a three-masted schooner, and will be fitted with all modern improvements—comprising, among others, water ballast, Brown & Harfield's patent windlass, worked by steam, four steam cranes, &c. Her engines and machinery are to be 70 horse nominal power, and will be supplied by the firm of Messrs. I. Thompson & Co., of Spring Garden Engine Works. Her capacity for cargo is computed at about 800 tons, and she is classed A 1, 12 years, at Lloyd's. She is the property of Messrs. W. Gray & Co., Sunderland, and was designed by Mr. C. J. D. Christie, from Messrs. Dennings, Dumbarton.

MESSRS. PALMER BROS. have eight or nine steamers building, several of which are to be engined by Messrs. R. & W. Hawthorn. This latter firm has given seven pairs of marine engines (screw) in hand—namely, two pair of 70 H. P. (collective), four pair of 90 H. P., and one pair of 140 H. P., fitted with Spencer's central surface condenser, and other improvements; working pressure 30 lbs. The ship of 1200 tons for these engines is being built by Mr. Andrew Leslie, in the Tyne. Messrs. R. & W. Hawthorn have also in hand two 100 H. P., with Spencer's surface-condensers, pumps, &c., complete, for land engines.

LAUNCH OF S. S. "HANSA."—The 23rd ult. was an important day in the annals of Greenock shipbuilding, as it witnessed the launch of the largest vessel ever constructed at this port—the iron screw steamer *Hansa*, built by Messrs. Caird and Co., for the extensive company in Bremen known as the North German Lloyds, for whom the builders of the *Hansa* have already built and engined several magnificent steamships. The *Hansa* is the largest vessel ever built at Greenock, being 10 feet longer and 34 tons larger than the *Atrato*. Her dimensions are:—Length over all, 360 feet; breadth, 42 feet; depth of hold, 33½ feet. She is 2,868 tons builders' measurement, and will register 3,500 tons. She has four tier of decks—spar, main, lower, and orlop—the main and lower being fitted from stem to stern for the accommodation of 250 first and second class, and 460 steerage passengers, while the orlop deck will be devoted to stores and a portion of the cargo. The bulk of the latter will be taken into the hold, which is capable of containing 1,000 tons measurement, and an equal weight of fuel will be stowed in the spaces set apart for that purpose. The height between decks is from 7 to 8 feet. Her engines will be direct-acting, of 600 h.p., fitted with Davidson's surface condensers and superheating apparatus. She will have three masts, and will be full-rigged as a barque.

THE "EUGENIE" paddle steamer, built for the South Eastern Railway Company, to ply between Folkestone and Boulogne, was, after several serious impediments launched from the building yard of Messrs. Samuelson, & Co. on the 9th ult. The *Eugenie* is a paddle steamer of 260 H.P., and is built to do 16 knots an hour. Her length over all is 220ft., breadth of beam, 24ft., extreme breadth over all, 42ft., tonnage, 539 tons, depth of hold, 12ft. 6in., and will draw 6ft. 5in.

THE "BERMUDA," a fine screw steamer was recently launched from the building yard of Messrs. Pearce & Lockwood, Stockton. She is intended for the Havannah trade, and her dimensions are as follows:—Length, 223ft.; breadth, 29ft.; and depth, 20ft. 3in. tonnage, 834 O.M., and is fitted up with two direct acting engines of 135 H.P.

THE "ANATON APCAE" Screw, underwent her trial trip on the 19th ult., and attained a speed of 12 knots an hour. Her engines worked very finely, and with very little vibration, making from 53 to 60 revolutions per minute.

RAILWAYS.

THE LUXEMBOURG AND TREVES RAILWAY was opened on the 14th ult. This line was constructed by Waring Brothers for the William Luxembourg Company.

TENBY LINE.—This short line has lately been opened for traffic. It is a single narrow gauge line about six miles in length, connecting the town of Tenbury with the Shrewsbury and Hereford Railway near Ludlow.

EXPORT OF RAILWAY MATERIALS TO INDIA.—The activity which prevailed last year in various branches of the iron trade is to some extent explained by the immense shipments of matériel to India, on account of the vast railway works now in progress. It appears from an official return that last year no less than 234,710 tons of materials were despatched to India of the collective value of £2,140,703, being the largest consignments made in any one year since the works were commenced. The proportion of matériel taken by each company was as follows:—East India, 56,488 tons; Madras, 39,343; Great Indian Peninsula, 25,971 tons; Bombay, Baroda, and Central India, 32,981 tons; Seinde, 2,056 tons; Punjab, 24,107 tons; Indus Steam Flotilla, 1,240 tons; Great Southern of India, 17,139 tons; Calcutta and South Eastern, 6,083 tons; Eastern Bengal 30,333 tons.

RAILWAY CAPITAL.—The annual return made to the Board of Trade shows that at the end of the year 1860, of the total capital raised by the Railway Companies of the United Kingdom, namely, £348,130,127.54.8 per cent, had been raised by ordinary shares, 19.5 per cent, by preference shares, 2.2 per cent by debenture stock, and 23.5 per cent by loans, the respective amounts being £190,791,067, £67,873,840, £7,576,874, and £81,888,546.

RAILWAY ACCIDENTS.

ON THE NORTH EASTERN RAILWAY, at the Gateshead station, an accident of an alarming character took place on the evening of the 10th ult. The train which was the subject of this unfortunate occurrence was that from the south and was due at Newcastle at about half-past ten o'clock. Being a mail, and it being a practice for it to stop only occasionally at Gateshead, the steam had been slackened at the usual distance from the point of landing, as is supposed to let down some passengers. The engine proceeded on its regular course until within about fifty yards of the station, when from some cause the fire axletree gave way. In the half shattered state to which it was now reduced it

continued on its way tearing up the rails and chairs as it went. So matters went on until the bridge across Hill Street was reached—a stone structure of great strength. Adjoining this part of the line is the station, a flat roofed building, covered with lead and about six feet from the level of the rails. Grazing slightly the wall as it passed along, it rushed violently against the bridge, knocking down a portion of the parapet, the stones falling thick and fast into the street beneath. Checked happily in its further progress by the luggage line of rails which intersect the passenger ones, the engine, with equally heavy force, dashed upon the roof of the first-class waiting room, there sticking fast in a partially inverted position. The shock to the entire building was immense. A chimney on the top was completely demolished, and the weight of the rubbish penetrated to the luggage room on the basement flat of the station. One of the broken wheels fell into the street, and the other shortly afterwards followed a similar course. It is gratifying, however, to state that with all this damage to property no loss of life occurred.

LONDON AND BRIGHTON RAILWAY.—TERRIBLE ACCIDENT.—An accident of a most fearful description took place on the 25th ult., on the London and Brighton Railway in the Clayton tunnel, about five miles from the Brighton terminus, whereby 22 persons lost their lives, many others being most dangerously hurt. It is necessary to state that an excursion train leaving Portsmouth for London at 6 a.m., calling at all the stations on the South Coast line, and is made due for departure from Brighton at 8 5 a.m. There is also an excursion train leaving Brighton at 8 15 a.m., and which runs to London without stopping. The regular parliamentary train stopping at all stations, leaves Brighton at 8 30 a.m. On the morning of this sad accident, the Portsmouth train left Brighton as above mentioned at 8 5 a.m., and duly arrived at the Clayton tunnel, where the "all right" signal was displayed. The train passed on without interruption. Immediately afterwards the 8 15 train from Brighton came within sight of the signal man. He, remembering that the Portsmouth train had only just gone by, states that he attempted to put on the "stop signal," which he found would not act. He then showed a red flag, indicating danger to the driver of the Brighton train, who, however, was close upon the signal-man's box, near the tunnel's mouth at the time. The engine driver, however, with great presence of mind, thinking from the signal that the train which he knew had preceded him, had not got clear, at once reversed his engine. From the impetus, however, with which the train had been travelling, it could not be pulled up until it had proceeded some distance into the tunnel. The signal-man at the Brighton end of the Clayton tunnel then perceiving that, in spite of the red flag the second train did not stop, imagined that the driver had not seen it, and immediately telegraphed to the other end of the tunnel to know whether the train had passed through, and received for an answer that it had. He did not know at the time that the driver of the second train had seen the red signal, that he had reversed his engine, and that the Brighton train was in the backward motion towards the south or Brighton end of the tunnel. Meanwhile the 8 30 parliamentary train came in sight, and the signalman having received the answer above referred to, gave the usual signal to proceed, which it did at the ordinary speed. Within a very short distance of the mouth of the tunnel a fearful crash ensued, the second train backing having come into violent collision with the other train which was rushing forward. The scene here was most heartrending, and upon assistance being procured, it was found that the engine of the parliamentary train had smashed the last carriage in the excursion train. The locomotive had also been pitched over the last carriage to the back of the last carriage but one, and shivered it into fragments. This carriage comprised four compartments, each containing ten persons, and the consequences cannot be adequately described; the unhappy passengers being scattered and mutilated in all directions, several being most fearfully scalded with the boiling water from the engine. The telegraph being quickly set to work, assistance was at once rendered to such of the sufferers as survived.

MILITARY ENGINEERING.

WESTLEY RICHARDS' BREECH-LOADER.—Her Majesty has been pleased to approve this carbine being adopted in the cavalry. The following is a description of this thoroughly efficient weapon.—Bore, 0.448in.; weight of hullet, 400 grains; length of barrel, 26in.; number of grooves, 8; charge, 2 drachms; pitch of rifling 1 turn in 20in.; weight, 6lb. 1 1/2oz.; sighted to 700 yards; hullet, cylinder-conoidal, with hollow base.

ON WHITE GUNPOWDER.—By F. Hudson.—Having lately prepared different samples of white gunpowder for some military engineering experiments, I have tried the process of separately grinding the materials, viz., chlorate of potash, ferrocyanide of potassium, and cane sugar, and then mixing them; also grinding them together with a little water added, and then dried at a temperature of about 150°. I find that those samples which were prepared moist and then dried are more easily exploded than those prepared by the dry process. In fact one sample exploded in an open porcelain dish by simple friction with a spatula, with which one of my assistants was crushing some of the larger pieces. Through the explosion he was laid up for several weeks, and nearly lost his eyesight. No samples prepared dry are as explosive as those prepared moist, the addition of water causing a more perfect mixing of the particles of its chemical constituents than can be effected by the dry grinding process. This accounts for the greater danger attending the use of white gunpowder prepared in the moist way. A cannon loaded with the white powder goes off on the application of a few drops of sulphuric acid (equally as well as with a light applied) to its touch-hole. This property of the gunpowder may possibly be applied to some advantage in the construction and preparation of bomb shells for long ranges. The shells would not explode (if filled with the white powder and containing a glass vessel with sulphuric acid) until they struck the object. No useless explosion of the shell could take place in the air, as is too often the case with the ordinary fusée shell. Its expansive or explosive force is also twice that of common gunpowder. In all experiments performed with this white gunpowder, care must be taken not to compress it too violently; otherwise accidents may frequently occur. A blow with a hammer upon stone with some of the powder upon it explodes all samples that I have prepared.

ARMSTRONG GUNS.—An order has been issued that the steel vent-pieces of the 100-pounder Armstrong guns are to be at once changed for others of wrought iron. Several of the steel vent-pieces having broken lately on the gun being discharged, and hence the issuing of the present order, which will be first carried out with respect to the guns issued to the fleet.

JONES'S TARGET.—The trial of this target took place on the 21st. ult. No repairs have been effected to the target since the trials in August last year, and the only alteration it has received to fit it for the late trial, has been the removal of the old plates, dubbing off 1 1/2in. of timber hacking to level it for receiving the new plates, and the fixing the new plates in their proper position. The target was on this, as on the former trial, fixed on the deck of an old Arctic vessel, the *Griper*, and presented its armoured face at an angle of about 50 degrees. The armour plates lie on 12in. of fine hacking, which is bolted to a plate of 5in. iron, that may be called the skin of the ship, the whole being supported on iron ribs and stanchions, and representing, so far as a target can, a section of a ships side on the sloping, or angulated principle. The four new plates manufactured for yesterday's trial are of rolled iron, from the works of Messrs. Beale, of Park-gate, Yorkshire, two of them being of 4 1/2in., and the remaining two of 5 1/2in. Their edges are laid square with each other, instead of being tongued and grooved similarly to those of the *Warrior* and others of our iron-clad fleet. This absence of the supposed improved rule to the edges of the plates, it was anticipated by Mr. Jones would preserve to the plates their natural strength as plain metal slabs, and which there is no doubt the tongue

and groove tends to weaken. To prepare the edges of the plates, however, to receive the impact of the shot, strips of five-eighths iron are let in the timber hacking, on which the edges of the plates, where they meet, rest. The plates themselves were hung in a peculiar manner, with the intention that should any of the bolts be started or broken, or the plates themselves destroyed, the inner skin or real hull of the ship should not be injured in any way, or caused to leak by the bolt-holes or otherwise. The practice was commenced from the *Stork*, moored at 200 yards, from her Armstrong gun, with a cast-iron bolt 12in. in length and 7in. in diameter, weighing 110lb. (the established service bolt), with a charge of 14lb. of powder. The firing was first directed at the two 4 1/2-inch plates, and No. 1 struck the outer plate in the centre—a splendid shot for testing the powers of both gun and target. The result was an indentation of 1in. only, with a circumference of 6in., and without the slightest sign of fracture, surface or otherwise. Other shots followed at the two 4 1/2in. plates, and the indentation varied from 1in. to 1 1/2in. In the spot where two shots struck upon each other's circumference, as in Nos. 7 and 11, a surface crack extended from the centres, but only admitting the point of a penknife, and extending apparently about 1in. in depth—the first layer of metal. At length, however, by good gunnery, aided by extraordinary luck, a line was drawn from the bottom of No. 2 plate from the right of the target (the inner 4 1/2-in.) to rather more than half-way up the outer edge of the outer 4 1/2-in. target, shot after shot being planted across that corner of the target on which the two plates stood in a most unprecedented manner, and apparently sufficient to cut that portion of the target off from the main part. An after examination of the target showed that six bolts had struck the target within a space—measuring from the centres—of 21in. by 12in., and three of these, all within an inch or two of the same spot, and consequently ponding each others' work, were close to the edge of the inner 4 1/2-in. plate. The result of this tremendous hammering might naturally have been expected to be such that the plate would have been driven clear through the target; but, on the contrary, the plate was merely driven in upon the pine backing to the depth of 3in. beyond the original level of the plate, and fractured at right angles, but not entirely separated from the main body. The results of sixteen shots on the two plates was the displacing, or rather separation, of the left hand corner of the inner 4 1/2in. plate, but the target was not penetrated. The success of the target as opposed to the 100-pounder Armstrong is altogether unprecedented in gunnery experiments of this kind. The 5 1/2in. plate had but one shot fired at it, and that made an indentation of only 3/4 of an inch. It is proposed by Captain Hewlett to place the 5 1/2in. plates vertically, and then renew the practice at them from the Armstrong. The following is a return of each shot and its effects:—

- No. 1. Depth, 1in.; indentation, 6 1/2in. diameter; no cracks; two bolts broken; four slightly started; no bolts through the skin started; the shell of the vessel quite sound.
- No. 2. Missed the target, flew over.
- No. 3. Indentation, 1 1/2in. deep, 6in. diameter; no cracks; four of the bolts through the armour plate slightly started.
- No. 4. Tore away logs in front of the target, and hurrying itself below the right hand armour plates, having pierced the 1 1/2 plate fixed for securing the foundation of the target.
- No. 5. Indentation, 1in. deep, 6in. diameter; two slight cracks from the bolt-head 3in. deep; two more bolts flown, from which and repeated blows the plate started 3in. at the top.
- No. 6. Indentation 3in., 6in. diameter; cracks none; on the 5 1/2in. plate five bolts through the armour-plates slightly started.
- No. 7. Indentation 1 1-16 in., 6in. diameter; no cracks, the plate about the shot bulged in about half an inch.
- No. 8. Indentation 1in., 6in. diameter; no cracks, grazed the edge of 5 1/2 plate.
- No. 9. A miss through the *Griper's* side.
- No. 10. Indentation 1 1/2in., 6in. diameter; on holthead (two fuses hung fire).
- No. 11. Indentation 1 5-10in., 6in. diameter; four cracks from the centre of No. 7 shot; 5in. from the centre of No. 7 to the centre of No. 11.
- No. 12. Indentation 3in., 6in. diameter.
- No. 13. Indentation 1 1/2in., 6in. diameter; no cracks.
- No. 14. Indentation 1 1/2in., 6in. diameter; causing cracks in No. 5.
- No. 15. Indentation 3 1/2in., 6in. diameter; on and above No. 3, broke an irregular piece of plate 8in. by 6in., and divided the welding to the extent of about of 2ft. This made the fifth shot (on the second plate from the left) within 1ft. 9in. by 1ft. from the centre of the extremes. The top edge of the second plate started 2in.
- No. 16. Missed the target, struck the *Griper's* side, making a large hole in the deck.
- No. 17. 3in. indentation, 6in. diameter; no cracks.
- No. 18. 2 1/2in. indentation, 6in. diameter; four small cracks in the indentation, two in the hole.
- No. 19. Missed the armour plates, damaging the framework of the target.
- No. 20. 1 1/2in. indentation, 6in. diameter; no cracks.
- No. 21. Above and slightly to the left of No. 11 shot.
- No. 22. On Nos. 15 and 3, carrying away the armour plates in irregular pieces between shots 15, 22, 3, 21, 11, 7, crushing the surface of the 12in. wooden hacking, but not in any way breaking through the same or damaging the shell of the vessel in the slightest degree.

EXPERIMENTS AT SHOEBURNESS.—FAIRBAIRN'S AND ROBERT'S TARGETS.—These interesting experiments were conducted at Shoeburness, under the superintendence of the Iron Plate Commission, upon two new kinds of targets, built up to resemble a portion of an iron-plated frigate's broadside. One target was sent in to be experimented upon by Mr. Fairbairn. This was about 10ft. long, by 6ft. high, and consisted of four plates 5in. thick, the upper and lower being each about 10ft., the two in the centre being only 5ft. each. The peculiarity of this target was that there was no wooden backing to the armour plating, for the attention of the Commission has lately been much directed to endeavouring to ascertain how far it is possible by a slight increase in the thickness of the plates to do away entirely with the weight and expense of the vertical and horizontal mass of timber beyond them. Another peculiarity was the effort to do away with the acknowledged source of weakness which arises from holes having to be drilled in the plates for the bolts to fasten them to the ship's side. In nearly all cases where plates have been fractured by shot the crack has commenced from one of the rivet holes. There were none of these in Mr. Fairbairn's target. The plates were fastened directly to what in an iron frigate would be its outer skin, which, in the case of the target, was represented by wrought iron three-quarters of an inch thick. From the inner side of this were rib girders much of the same kind as the iron ribs of a frigate would be. These were half an inch thick by about 11in. deep, and 18 apart, with stout angle irons fastening them to the outer skin. From inside this skin the rivets were let into the plate like tapped screws, penetrating 1 1/2in. into the 5in. armour plate. First, a flat-headed steel shot, about 11lbs. in weight, was fired against it to test the quality of the iron. This made only a dent a quarter of an inch in depth. Two of Armstrong's 40lb. shell, filled with sand, were next discharged point blank at a distance of 100 yards. They also dented the iron to the depth of about a quarter of an inch, but otherwise seemed to have but little effect, except upon the rivets of the angle iron inside the sheathing, which were apparently somewhat started. Two flat-headed 40-pounder solid cast-iron shot, fired at the same range, produced more effect. Their indentation was 3/4 of an inch, and the rivet heads holding the armour plates were evidently shaken, though apparently they held as firmly as ever. The 100-pounder Armstrong was next tried at 200 yards, with a shell filled with sand. This did not do much damage, and apparently seemed as strong

as ever. A solid 100-pounder shot was then fired, and this struck with a tremendous blow the centre of the target, the effect of which visibly started the plates from the iron skin, and rather curved them outwards at some of their joints. The effect of two shots from a solid 68-pounder smooth-bore gun, at 200 yards shook the armour-plates still more, starting them from the skin to which they were bolted, and denting them 1½ in. A 200lb. shot was then fired at 200 yards range. This ponderous missile not only made a very deep dent were it struck, but bulged the whole target in, shaking all the plates loose, breaking some of the screws which held them, and breaking one of the girder ribs. The last shot fired was with a 100-pounder, from an Armstrong muzzle-loading shunt gun, at 800 yards, and the effect of this was final. By the force of the concussion the upper plate, with one of the centre small ones, was completely detached, and came crashing down, leaving those that still remained in a very shaky and precarious condition. It was, however, considered to have withstood the assaults it had received in the most extraordinary manner. The screws held on a great deal longer than any one expected, while the plates, though of course much battered and defaced, were still capable of holding out much longer. On the whole, therefore, it was considered that the resistance offered by these 5 in. plates gave a better result than any other plates previously tested. The next experiments were made upon a target invented by Mr. Roberts. This was the very reverse in principle from Mr. Fairbairn's, inasmuch as the thickness of the iron plates was diminished, while the backing consisted of 18 in. oak timber. Mr. Fairbairn's target was intended to show bow shot-proof frigates might, with advantage, be made of iron only, while Mr. Roberts's was designed to prove that wooden ships could be as easily rendered shot-proof as if specially built for the purpose. The back of this target was formed of three wrought-iron plates. To these were fastened iron T plates, which on a frigate would run along the vessel's side fore and aft. Between these were fitted oak beams 9 in. square, which being all tight caulked, bolted the plates firmly in their position, so as to prevent lateral bend, and enable them to resist the maximum pressure due to their strength. Over this again comes another layer of beams and T plates, placed vertically, fitted in the same way and bolted firmly into the ship's side. Over all this comes the armour plates. Each of these latter are 3 in. thick, and 2 ft. wide, and made in an angular form, something like a wide shaped letter V. All the joints are planed so as to ensure accuracy of fit, and thus when a ship's side was covered with these plates, the alternate angular projections and recesses would resemble in shape, on a small scale, the ordinary ridge and furrow roofing used in glass buildings. Where the longitudinal joints occur a recess is cut in the plates, into which is fitted an iron rib 6 in. wide, and 4½ in. deep, the outside face of the rib being also angular. These joint ribs are fastened through with 1½ in. bolts, while the V shaped armour plates are secured by ¾ in. bolts, 18 in. apart. Each armour plate rises from the side of the ship to an angle of about 1 ft. in height, the face of each angle being also 1 ft. in depth. Mr. Roberts and Mr. Burn, C.E. (who is associated with Mr. Roberts in his invention), had, however, committed the serious fault of having their target made too small. It was only 6 ft. by 4 ft., and consequently, as all the shots were aimed low, they struck almost on the same spots, which wanted the surrounding support a larger target would naturally afford. So far the test of strength was taken at a disadvantage to the invention. The first shot fired at it with a 1 lb. flat-headed steel ball to test the quality of the iron, the average depth of inclination in the inclined plate was ¼ of an inch. Two 40 lb. shells, filled with sand, were then fired from an Armstrong at 100 yards, but did no perceptible damage. A flat-headed 40-pounder which was next fired struck one of the rib joint pieces we have spoken of between the angles, and broke it. It, however, still remained firm in its place, and a 100-pounder Armstrong shell, at 200 yards, did no apparent damage. Not so, however, with a 100 lb. Armstrong solid shot at the same range, which came full upon the edge of the angle of the centre plate, inflicting a deep dent, and slightly fracturing the plate itself. The next, a solid 68-pounder, from a smooth bore gun, bit full upon the same joint rib which had been struck and broken before with a tremendous blow. It split the rib joint at its outer rivet hole, breaking off the end of it entirely. Still, however, the target was quite firm apparently. The next 68-pounder fired struck full upon the extreme lower edge of the bottom plate with such force as to shatter the wooden frame which supported it, and turn the target completely over on its face. On the replacing of the target the experiments were resumed. The first trial was made with the 100-pounder Armstrong shunt gun, with solid shot at 800 yards' range. Three shots were fired at the target from this, but from the extreme smallness of the object (4 ft. by 6 ft.), and the high and very variable wind blowing at the same time, all three of them missed. Experiments were then made with a 200 lb. solid shot, fired from an Armstrong at the close range of 200 yards. Another result was shown by these experiments, viz., the necessity of having a timber backing to the armour plates, for the concussion from the shot started all the rivets that fastened the outer skin to the main ribs, and had the target been the side of a ship, it would have been rendered leaky in a very few minutes. The first shot struck full and fair upon the apex of the angle of the uppermost plate. Strange to say, however, it did no damage except to cause an indentation of 1½ in., and starting some of the upper fastenings which secured the edge of the plate to the target. The second shot of the same weight struck one of the upper joint ribs between the plates and broke it in three places, detaching one piece; but still the damage done was immaterial to the plates themselves, though some of the fastenings were then very loose, and the centre angle plate had slipped, and was almost half detached. The firing at this, therefore, was considered sufficient as regarded a test of the strength of the plates, and, above all, of their backing up with timber. The general result of the experiments has shown that the 5-inch iron plates of Mr. Fairbairn's target fastened to a ¾-inch skin, were perfectly able, as far as the plates were concerned, to withstand for a very long time what was, in fact, a concentrated fire from the heaviest and most powerful ordnance in the world. It also showed that the thinner plates of 3 in., rolled into an angulated form, and presenting at all points an inclined face to the blow of the shot, were equally well able to withstand a missile that under other circumstances would fracture a 4½ in. plate, and this was the object the inventor wished to demonstrate. The backing of the target, even after all the pounding it received, was still perfect, though only 18 in. thick, and had this been the hull of a ship, it would apparently, even if submerged, have remained quite watertight. The ribs which formed the backing to the skin inside the plates of Mr. Fairbairn's target were, perhaps, a little too weak for the enormous resistance they were expected to exert. The weak point of Mr. Roberts's target was the rib joint. This, though a piece of the best wrought iron, 6 in. by 4 in., was never strong enough to resist the blow of a 100, or even a 68-pounder. But for this fault and but for the small size of target, it would doubtless have held out much longer than even it did.

TELEGRAPHIC ENGINEERING.

MEDITERRANEAN EXTENSION TELEGRAPH COMPANY.—At the half-yearly meeting of this company it was stated that the arrangements made with the new Italian Government will lead to the acceleration of messages between Malta and this country; the time being considerably reduced. The government subsidy of £7,200 has been divided into two parts, so that, if the working should be interrupted, half the entire sum would still be received.

BURMESE TELEGRAPH.—At the Burmese capital it is currently rumoured that the King shortly intends to connect Mandalay with the British province of Pegu, by telegraph. A line of posts are to be constructed, during the dry season, for suspending the wires, and when the boundary is nearly reached, his Majesty will apply to be allowed the privilege of joining the telegraph system of India. Already in the royal city there are two or three short lines in operation.

INDIAN TELEGRAPHS.—As the point of contact between India and the West for tele-

graphic communication, must be Kurrachee, the Viceroy has authorised the officiating director-general of electric-telegraphs to take immediate measures for building an office at Kurrachee fit for the joint occupation of the government telegraph establishment, and that of every private company, or other agency, by which a cable may be brought to Kurrachee.

PRINTING TELEGRAPH.—By the printing telegraph, lately invented by Dr. Nydardin, of Lille, it is said that the entire alphabet can be reproduced in seven seconds, and eight alphabets in one minute. It will transmit and write in one minute a despatch of twenty-four words, or about one hundred letters.

DOCKS, HARBOURS, CANALS, &c.

SWANSEA HARBOUR WORKS.—At a recent meeting the report of the New Works Committee was read. This report states: "The outlay upon the Half-tide Basin Works has been as follows:—Works executed by the contractors, £15,160 17s. 6d.; compensation to contractors for delaying work in 1857, £1,195; amount agreed to be paid to contractors for giving up contract, for material on the ground, and for use of plant, £3,250; works executed under resident engineer, (less amount realized on sale of plant) £14,578 18s. 11d.; rents and compensation, 8,992 2s. 9d.; total, £35,784 9s. 2d.; less amount to be repaid to the trustees for works executed by them, £6,352 17s. 9d.; total cost, £29,431 11s. 5d."

EAST INDIAN IRRIGATION AND CANAL COMPANY.—The first report of this company has been issued, from which it is understood that all obstacles to this undertaking have been removed, and that the works for irrigating and draining the proposed districts will be commenced as soon as sufficient capital has been subscribed.

BURSTING OF A CANAL NEAR BARNESLEY.—The embankment of the canal at Raystone lately gave way. A sloop was close to the spot, and fell down a depth of nearly 12 ft., and was floated along the field a distance of 400 yards, where it became embedded among the standing corn, and was afterwards drawn to the canal by horses. Not far from the embankment there was fortunately, a culvert, which took a great deal of the water; considerable damage has been done, and the canal has been drained for a distance of nearly 11 miles.

A NEW DREDGER FOR GREENOCK HARBOUR was recently inspected at Carlsdyke by the members of the Harbour Trust. After a careful examination of the machinery and fittings of the vessel, the bucket ladder was lowered, and a punt brought astern. The punt was filled in fifteen minutes, its capacity being 33 cubic yards, equal to about 45 tons. Everything wrought in a most admirable manner, and gave complete satisfaction. The dredger is larger than any single ladder machine that has yet been made on the Clyde. The hull, which is of iron, is 110 feet in length, by 23 feet in breadth. The bucket frame is 70 feet long, made entirely of malleable iron, and the buckets, which with links weigh each upwards of half-a-ton, are 37 in number, each of capacity to contain 6 cwt. of stuff dredged. The machine will dredge to the depth of 27 feet, or if required could even dredge to the depth of 30 feet. The engine and boilers occupy the fore end of the vessel. The starboard side is entirely appropriated to the men, who sleep and mess on board, thus affording a most roomy and comfortable abode. The larboard side forms a store room for spare ropes, chains, and gear, lanterns, oil, &c. The dredger is dragged forwards and hauled back by power from the engine, working winches at the bow and stern. This machine, which was designed by Messrs. Bell and Miller, was contracted for by Messrs. Jas. Aitken and Co. The hull was built in Greenock by Messrs. Robert Steele and Co., and was engine and geared in Glasgow by Messrs. Aitken, and the whole machine has turned out a very creditable piece of workmanship.

BRIDGES.

CLIFTON SUSPENSION BRIDGE.—Of the £35,000 capital required for this structure £30,000 has already been subscribed. In addition to the contract which has been concluded for the purchase of the chains of the Hungerford Bridge and their erection at Clifton, arrangements have been also entered into for the supply and erection of the remainder of the ironwork and platforms of the bridge. The chains from Hungerford will be delivered so soon as the new Hungerford Bridge is in a sufficiently forward state, and the directors of the Charing Cross Railway Company are making every exertion to open their bridge at the earliest possible period.

THE NEW BRIDGE AT LAMBETH.—The working plans for this bridge, which is to connect Lambeth with Pimlico and Cbelsea, have been approved by the Admiralty and the Conservators of the Thames, the contractors have completed their arrangements for pile-driving. The bridge will have three equal spans of wire cables, made with barocool iron, each 290 ft. wide, supporting a wrought iron platform, with rigid lattice sides, similar to a girder; and thus differs from suspension bridges hitherto constructed, which support a wooden platform by small round vertical rods, without any other means of insuring rigidity, and preventing oscillation. The river piers will consist each of two cast iron cylinders, 12 ft. in diameter, driven 25 ft. into the bed of the river, and filled with concrete and brickwork, in the same manner as those now in course of erection for the new Hungerford Railway Bridge. The bridge will have a double carriage-way and two footways, the total width being 32 ft. In the event, however, of increased traffic, the bridge is so designed that an additional width for two lines of carriages may be added. The directors, after having obtained subscriptions for the greater part of the capital, proceeded to treat with contractors for the execution of the works; and they announce that contracts with Messrs. W. S. Newall & Co. as to the cables, and with Messrs. J. H. Porter & Co. as to the residue of the works, have been duly signed, at prices which will complete the works for less than £28,000, the contractors taking payment of £12,000 of this amount in paid-up shares. The directors have entered into arrangements for the purchase of nearly the whole of the land required. They were enabled, therefore, to state that the capital of £40,000 will be more than sufficient to meet every contingency. They trust the bridge will be opened sufficiently early in 1862 to benefit by the traffic of the International Exhibition.

WATER SUPPLY.

THE NEW RIVER COMPANY AND THE CITY PUMPS.—Dr. Letheby has just reported upon the water supply by the New River Company and by the city pumps, which shows that the water supplied by the company is quite satisfactory, but the water supplied by the city pumps are in a very dangerous state for the health of London. The water supplied by the company does not contain more than nineteen grains of solid matter per gallon of water, but Aldgate pump, for instance, contains 109.5 grains per gallon. Dr. Letheby remarks "that these results show that the city pumps are not only charged with decaying organic matter, but also with the saline products of its oxidation, the ammonia, for instance, is a sign of present putrefaction, and the alkaline nitrates of a past; besides which the existence of so large a quantity of common salt is suggestive of the filthiest impurities; as, for example, the fluid matters discharged from the human body, and the percolations from cesspools and sewers. Most of these waters are bright and sparkling, and they have a cool and agreeable taste. They are therefore much sought after for drinking purposes; but the coolness of the beverage and the briskness of its appearance are dangerous fascinations, for they are both derived from organic decay. Dead and decomposing matters have accumulated in the soil, and have been partially changed by its wonderful power of oxydation, and thus converted into carbonic acid and

nitre: These have given to the water the agreeable qualities which are so deceptive. In reality, the water from the city pumps is far worse than that from the muddy river, from which it is in great part derived; indeed, it may, at any moment, become charged with the active agents of disease; for no one can say when the salutary influence of the soil may fail, by being worn out or over taxed, and then the putrid organic compounds will pass into the wells unchanged. Many of the pumps are in close proximity to the fat graveyards of the city, and it is more than probable that all of them derive a portion of their water from these sources, for they are the principal gathering grounds for the surface springs; in fact, they are the only open spaces through which the rain can percolate to reach the shallow wells.

GAS SUPPLY.

THE HERTFORD GAS COMPANY have declared a dividend of $7\frac{1}{2}$ per cent. The Worcester New Gas Light and Coke Company, one of 7 per cent.; the Taunton Gas Company, one of 6 per cent.; The Banbury Gas Company, one of $7\frac{1}{2}$ per cent.; the Portsea Island, one of 6 per cent.; and the Willenhall, one of 10 per cent. The latter company have reduced their price to 4s. 6d. and 4s., according to quantity consumed.

BOILER EXPLOSIONS.

BOILER EXPLOSION AND LOSS OF LIFE.—On the afternoon of the 10th ult., an explosion of a very terrible character occurred at Messrs. B. and J. Groves' steam saw and planing mills, in Deverell-street, Old Kent-road. In the afternoon, at half-past three o'clock, about twenty workmen were busy at their ordinary avocations, and Mr. J. Grove, one of the proprietors, was in the yard, when one of the boilers suddenly burst with a tremendous report, rousing the inhabitants of various streets of small houses surrounding the works into instant alarm. Crowds of people rushed to the spot indicated by the sound, and several of the employes of the mills were met running out with great terror marked upon their countenances. Clouds of steam enveloped the premises, and as some portions had taken fire, and it was known that all the workmen had not escaped, engines and medical men were sent for simultaneously. Water was soon flowing on the burning materials, and the fire was rapidly extinguished. People now entered the yard for the purpose of rescuing those who might require their aid. The muster-roll was called, and then it was found that Thomas Knowles, the engine-driver, aged 46, and his son, 12 years old, were missing. Some other persons, who had either been in the yard or in the immediate neighbourhood, were found bruised and wounded—some seriously, some only slightly. The effects of the explosion were now apparent. Almost the whole building was in ruins. The walls had been thrown down and the roof blown into the air, while piles of timber had been hurled in all directions. The violence of the explosion can be imagined from the fact that a large stone (18 inches by 12 inches) was thrown from the building, a distance of about 200 yards (across one street and down another) on to the roof of a house at 17, Charles-street. The stone made its way through the roof into the top floor, and smashed to pieces a heavy wooden bedstead, on which a little child was sleeping. Fortunately the child was but slightly injured by the missile. Another singular circumstance was the fact of a brick or piece of stone, after being hurled from the works for a distance of about 150 yards, passing through a large lamp suspended outside the "Virginia Plant," public-house, at the corner of Lawson-street, merely breaking the glass. The body of the engine-driver and his son were both found among the debris, frightfully mutilated, and life utterly extinct.

THE ASSOCIATION FOR THE PREVENTION OF STEAM BOILER EXPLOSIONS.—At the last ordinary monthly meeting of the executive committee of this association, held at the offices, 41, Corporation Street, Manchester, on the 30th July, Hugh Mason, Vice-President, in the chair, Mr. L. E. Fletcher, chief engineer, presented his monthly report, from which we have been furnished with the following extracts:—"During the past month 239 visits have been made, 669 boilers, as well as 442 engines, have been examined, and the following defects discovered: Fracture, 7; corrosion, 11; safety valves out of order, 12; water gauges ditto, 11; pressure gauges ditto, 15; feed apparatus ditto, 4; hlow-off cocks ditto, 9; fusible plugs ditto, 1; furnaces out of shape, 19; over pressure, 7 (dangerous); deficiency of water, 2; boilers without safety valves, 1 (dangerous); total, 99 (8 dangerous); boilers without glass water gauges, 17; without hlow-off cocks, 20; without pressure gauges, 5; without feed back pressure valves, 54. "During the last month three explosions have come to my knowledge, each attended with loss of life, in neither case, however, have the boilers been under the inspection of this association; nor, I believe, under that of any other. I have not had an opportunity of examining any of these boilers since their explosion, but have been informed that two were of ordinary Cornish construction, one of which failed from deficiency of water. The third was of the tubular locomotive class, and the explosion arose from thinning of the plate just behind one of the laps situated in the cylindrical part of the boiler, and below the water line. I have known this to occur to stationary boilers, apart from corrosion, as caused by blowing joints or external damp, and attribute it to disintegration of the plate, consequent on the constant buckling action which is induced in close proximity to single lines of rivets by heavy strains. The constant occurrence of explosions from weak places in the plates, entirely unsuspected and only ascertained by a 'post mortem' examination, as it were, shows the imperative necessity for laying bare the plates of all boilers which have been in work for any length of time, and having a faithful and most searching examination made of them on both surfaces. A boiler is too apt to be considered in a state of rest when once it is fixed on its bed, whereas the fact is, that directly the fire is lighted all the parts are set in comparative movement one with the other; every fresh charge of coals expands the plates of the furnace tube; every draught of cold air through the furnace door contracts them; while the varying pressures of the steam and any irregularity in introduction of the feed water, more especially if cold, change the shape of the shell, so that the boiler is in a constant state of respiration, which must in course of time have an influence upon it. "This shows the importance, in the first construction of boilers, of having all the cylindrical parts truly circular, and without any flat places in them, so as to prevent constant alternate buckling action, while it appears to me to point to seams of double riveting as more enduring than single for continuous heavy strains; also, that in estimating the safety of boilers, time must always be considered as an element, and that nothing can be more fallacious than to argue that a boiler must be safe at a given pressure, because it has stood it for several years."

MINES, METALLURGY, &c.

MINING IN TURKEY.—The new Sultan has instituted a department—a special administration of mines and forests, and has it has for a long time been well known that Turkey possesses considerable mineral wealth, which only requires to be properly worked to return large profits to the adventurers, and to increase the revenue of the country, the most satisfactory results are anticipated. The new department has been placed under the direction of Dervish Pasha, who has had much experience in Russia, and all that now remains to be done is to regulate the conditions upon which Europeans may be allowed to undertake the regular working of the mines of the empire.

THE COAL TRADE.—The quantity of coal and coke exported during the month of July from the various coal ports in the United Kingdom was—coal, 785,426 tons; and coke, 25,975 tons. This quantity, when compared with the returns for the preceding month, shows a considerable increase in the quantity exported. During the month, 8359 vessels

were engaged in the trade, of which number 3236 were employed in the foreign, and 5153 in the home coal trade.

COMPRESSED COAL.—The process by which these compressed blocks are obtained is inexpensive, and without complication; while they only occupy one-third the space of ordinary coal, taking but 81 cubic feet to the ton, while raw coals average from 44 to 48 ft. The process is as follows.—In the first place, the pure coal-dust or slack is conveyed through a washing machine for the purpose of disconnecting it from any stony particles it may contain. It is then subjected to a steady heat, until its bituminous parts are rendered quite soft; after which it is passed into a moulding machine. This comprises a rotary table containing the moulds, around which are situated three presses, namely, the feeder, for filling the moulds; the main press, for condensing the blocks; and the discharge which removes the block out of the mould, whence it falls into a travelling web, which carries it away. The presses act simultaneously, and between each stroke the table makes one-third of a revolution, by which the coal is removed from one press to another. An apparatus is provided for extracting the gases from the coal during pressure, ingeniously opening out the air passages at each stroke, which would otherwise become choked by the bitumen. In these presses, necessarily of a very powerful description, breakages would be always occurring, but for a provision which has been made by the fulcrum of the levers of the main press resting on the ram of an hydraulic press, the safety valve of which is loaded only to the extent that the strength of the machine will bear. Each machine, which is inexpensive in construction, is capable, it is calculated, of making 28 tons per day, at an estimated cost of 25s. per ton.

GALWAY MAIL STEAM COMPANY.—The report of the Select Committee on the Atlantic (Galway) Mail Steam Company contract has just been published. It justifies the Postmaster-General in putting an end to the service on the ground of inefficiency, but recommends the company to favourable consideration in case it should be resolved to re-establish a postal communication between the west of Ireland and America. This recommendation is based partly on a belief that the company will be in possession of a fleet of steam ships in the course of the present year, and partly on the consideration of the "misfortunes" they have hitherto encountered.

ON CERTAIN COPPER AND ZINC ALLOYS, BY M. E. KOPP.—An alloy, by M. Gedge, remarkable for its malleability—for when hot it can be forged, stamped, rolled, and drawn with the greatest ease—gives on analysis, the following numbers:—

Copper	60.00
Zinc	38.15
Iron	1.50
	99.65

The proportion of zinc can be increased to 44 per cent. This alloy, which is recommended for sheathing vessels, seems identical with Aich's alloy to which the following composition is assigned:—

Copper	60.00
Zinc	38.20
Iron	1.80
	100.00

The colour of this alloy is rather darker than brass; its fracture is paler, bending at a red heat, and of fine grain. It takes a high polish. Its density is 8.37 when annealed, and when hardened 8.40. It is extremely ductile, though not so flexible as brass. Experiments made in the Austrian marine arsenals show that the Aich's metal possesses a high degree of tenacity; that it maintains its properties at red heat, provided the temperature is not raised to a clear red heat; that it can be puddled, hammered, and worked like the best forged iron; that when cold it can be considerably bent without cracking or breaking; that its absolute and relative resistance approximates to that of iron of good quality. It is very probable that these alloys are nothing more than malleable brass or Chumtz metal, concerning which M. Storer published a most interesting paper in the *Repertoire de Chimie Appl.*, 1860, p. 213. It is very likely that the iron is useful only in diminishing the nett cost of these alloys.

COMPRESSED FUEL.—W. A. G. Lassere, Bordeaux, has patented an invention for compressing peat, or small or waste coal, coke, and anthracite. The matters to be agglomerated are first heated in an oven, and mixed with a small proportion of pitch, tar, or resin, the mixing being effected by the aid of a shaft, furnished with arms or hars, placed within the oven. They are then formed into balls or blocks. A wheel is provided with 23 holes, made to receive a similar number of pistons, so fitted as to play freely. This wheel receives circular motion by means of toothed gearing. The material to be agglomerated runs continually through a hopper, aided by a butterfly-wheel, and fills the cavity between the two opposite pistons, which are to compress it. The wheel in its rotation carries with it the material, and the pistons, which carry at their extremities rollers, which, pressing against inclined planes, force the pistons to come in contact, so that the materials lodged in the hollow spaces at the end of the pistons is compressed between them. After the pressure has been exercised, the axes of the rollers come against cams, when the pistons retire, and the ball or block falls. To avoid adherence of the ball to the sides of the piston-spaces, a second piston inside the first exerts (as the pistons begin to separate) a pressure which completely isolates the ball from the other pistons. The material may be raised to the hopper by any mechanical means. A pump may be placed so as to inject water into the pistons to wash their interior, detaching matter that might otherwise remain, and preventing the balls, lumps, or masses from sticking together. When this fuel is intended to heat apartments, or for domestic purposes, Mr. Lassere proposes simply to steep the matter in a bath of arrillaceous matter, to avoid the disagreeable smell of the gas contained in the coal, tar, pitch, or resin. The agglomeration will be effected as readily, and in combustion the fuel will be almost smokeless.

APPLIED CHEMISTRY.

STOPPERS OF CAUSTIC SOLUTION BOTTLES.—It is well known that the stoppers of these bottles rapidly become incrustated; greasing is of little use, moreover, we have to consider that we may thus introduce fatty acids into the solution; now paraffine answers well: first, because caustic alkali does not act upon it, and secondly, because it perfectly lubricates the surfaces in contact.

A SENSITIVE REAGENT FOR SULPHUR.—By M. Schlossberger.—A solution of molybdate of ammonia in hydrochloric acid diluted with water, possesses the property of colouring blue, if traces of sulphur are present. By this means the presence of sulphur even in a single hair is easily recognisable.

NEW PROCESS FOR PREPARING NITRATE OF SILVER.—By M. Greiner.—Dissolve impure silver in nitric acid, and when the liquid is almost neutral and cold, add a solution of sulphate of soda to precipitate the sulphate of silver, which is to be washed in distilled water; after this digest it with heat, with a proper proportion of nitrate of baryta, thus forming sulphate of baryta, to be separated by filtering, and nitrate of silver, which can then be crystallised. It remains to be seen whether the product is pure;

the facility with which nitrate of silver combines with alkaline nitrates, makes it likely that it would also have a certain affinity for nitrate of baryta.

ON THE PREPARATION OF ROSOLIC ACID AND OF ROSOLATES, by M. JOUVIN.—M. Runge, in 1834, having remarked that in certain portions of a gas-making apparatus, the lime found therein became red, endeavoured to separate this coloured matter, and gave to it the name of rosolic acid, but without having well defined it. In 1854, Mr. McDougall, a Manchester manufacturer, having observed that the lime used in the preparation of dis-infecting coal-tar became, after a certain time, more or less red, took some of this substance to Dr. Smith, a chemist in the same town. After more attentive study than M. Runge had bestowed upon it, Dr. Smith succeeded in separating from it a solid brown substance, becoming yellow when dissolved in alcohol, and red on the addition to it of an alkali or of lime. He retained the name of rosolic acid given by Runge, for the first of these bodies, the red colouring matter being then considered as a rosolate. Wishing to obtain a certain quantity of this acid for analyses, Dr. Smith sought for the most expeditious method,—the process for separating rosolate of lime being not only tedious but yielding small results; for the red lime mentioned contains only a few grammes of rosolate to several kilogrammes of the staple matter. Supposing that rosolic acid was a modification of phenic acid, existing in the products used for the preparation of coal-tar, Dr. Smith passed phenic acid in vapour over lime in a red hot tube, and found that the lime became red-hot only after a certain time, and he obtained only a small quantity of rosolate of lime. Then he tried the following process, which he ultimately preferred, as being the most simple. He heated a mixture of phenic acid, soda, and peroxide of manganese, and again obtained, and in larger quantities, the red matter, rosolate of soda. Thus the question rested, when, having occasion to study phenic acid, I directly found

Dr. Smith's rosolic acid without then being aware of his researches; and I found that rosolic acid and rosolates could be much more easily obtained if, in the process given by the Manchester chemist, peroxide of mercury were substituted for peroxide of manganese. In short, with manganese are obtained, besides rosolate of soda, manganates of soda, which decompose when it is attempted to separate them for the purpose of purifying the colouring matter, forming oxides of manganese, which must be separated, and thus necessitating a lengthened purification, while if oxide of mercury is substituted for the oxide of manganese in the mixture of carbonic acid and soda, we very rapidly obtain (ten minutes suffices), and at a temperature below 150°, the transformation of carbonic into rosolic acid, and the formation of a rosolate of soda of a beautiful red. This salt then appears as an excessively viscous liquid, solidifying almost entirely when cooled, and simply needing decanting to purify it, which frees it from the reduced mercury which remains at the bottom of the vessel. This colouring matter, obtainable of various tints according to the quantity of oxidising matter employed, has not yet been used for dyeing, on account of its instability under the action of acids, which by neutralising the alkali gives to rosolic acid its arnatto colour; but I trust that trials now in operation will result in utilising it for dyeing. A fact, which I re-mention here, relating to phenic acid, is, that if heated with bichloride of mercury this acid will also yield rosolic acid, at the same time producing hydrochloric acid; and with a distilling apparatus, rosolic acid can be collected in the retort, while the excess of phenic acid, saturated with hydrochloric acid, condenses in the receiver and fumes excessively in the air. Rosolic acid proceeds from oxidised carbonic acid; for if the latter is represented by the formula C₁₂H₆O₂, that of the former becomes C₂₄H₁₂O₆. This formula is given as the result of three analyses.

APPLICATIONS FOR LETTERS PATENT.

Dated July 26, 1861.

- 1872. R. R. Swann, 12, The Grove, Blackheath—Apparatus for the extinction of fire.
- 1873. J. F. Bourne, Georgetown, British Guiana—Construction, armament, and equipment of batteries.
- 1874. F. Johnson and B. Hockin, North-street, Smith's-square, Westminster—Securing or fastening nuts for railway fish plates.
- 1875. F. N. Thurel, 4, South-street, Finsbury—Fastening shoes, stays, gloves, and other wearing apparel.
- 1876. E. Sang, 2, George-street, Edinburgh—Apparatus for indicating the direction of objects and measuring angles.
- 1877. W. Wigfall, Sheffield—Brooms and brooms.

Dated July 27, 1861.

- 1878. W. E. Gedge, 11, Wellington-street, Strand—An improved weighing machine.
- 1879. J. H. Johnson, 47, Lincoln's-inn-fields—Sewing machines.
- 1880. R. E. Garrod, High-street, Chelmsford—mitre boxes and shooting boards.
- 1881. J. B. Herbert, 8, Newman-street—Fire guards.
- 1882. W. H. Harfield, 2, Royal Exchange-buildings—Propelling ships and vessels.
- 1883. E. P. Colquhoun and J. R. Thompson, 1, Laurence Pountney-hill—Fire bars for furnace grates.
- 1884. C. E. Amos, Grove, Southwark, and J. Francis, Penrhyn Slate Quarries, near Bangor, North Wales—Machinery for dressing slates.
- 1885. J. Robertson, 53, Park-street, Mile-end—Apparatus for the treatment of the human body.
- 1886. Sir John Hare (Knight), Hardelet Castle, Pas de Calais—Manufacture of snags.

Dated July 29, 1861.

- 1887. G. Sturrock, Woolwich—Construction of breech-loading fire-arms.
- 1888. F. Tolhausen, Boulevard Bonne Nouvelle, Paris—Comforters, neck-ties, cravats, and the like articles of garment for the neck and chest.
- 1889. W. Busby and D. Busby, Liverpool—Street or road rails for omnibuses and other vehicles.
- 1890. R. Riley, Hull—Fusee signals.
- 1891. W. Melrose, 25, Kingsbridge-place, Millwall—Construction of railway wheels.
- 1892. C. C. J. Guffroy, Lille, France—Preparing medicinal substances and compounds from the livers of cod and other salt water fish.
- 1893. W. L. Scott, Bayswater—Preparing, red, purple, and certain other dyes.
- 1894. E. H. Joynson, St. Mary's Cray—Apparatus for dis-integrating, crushing, or drawing out vegetable fibres.

Dated July 30, 1861.

- 1895. P. Hall, Canada Works, Birkenhead—A simultaneous manifold drilling machine.
- 1896. T. Sanderson, 76, Princes-street, Dunston-road, Kingsland, N.E.—A pasteboard, millboard, and cardboard medal for advertising purposes in lien of handbills.
- 1897. T. Bradford, Cathedral Steps, Manchester—Washing, churning, wringing, and mangling machines.
- 1898. W. H. Ash, London, Canada West—Reaping and mowing machines.
- 1899. T. S. Cressy, Burton-on Trent—Machinery used in the manufacture of casks.
- 1900. A. Parkes, Birmingham—Sheathing metal for ships and vessels.
- 1901. M. Allen, 14, Worship-street, Finsbury—Construction of buildings.
- 1902. J. M. Hart, 76, Cheapside—Construction of parts of locks or fastenings.

Dated July 31, 1861.

- 1903. H. Potter, Manchester—Treating or preparing textile materials and fabrics.
- 1904. H. J. Holland, Bond-street, and W. Payton, Johnston-place, Harrow-road—Breech-loading fire-arms.
- 1905. A. Wood, Lewes—Refrigerating storehouses.
- 1906. F. F. Flanders, Wardrobe-place, Doctor's Commons—Machinery for splitting, dividing, or shaving leather, or skins, or sheets, of manufactured fabrics.
- 1907. J. Rylands, T. G. Rylands, and P. Rylands, Warrington—Joining wires for telegraphic conductors and other purposes.

Dated August 1, 1861.

- 1908. H. J. Walduck, Manchester—Apparatus for retarding and stopping railway engines and carriages.
- 1909. B. Browne, 52, King William-street—Self-acting tap or apparatus specially adapted for lighting cigars.
- 1910. H. Mearing, 18, Great Randolph-street, Camden Town—Procuring a light in the form of improved lucifer match.
- 1911. R. Harrison, Port Penrhyn, Llandegai—Apparatus for cutting slates or slabs.
- 1912. H. Shaw, 48, Lower Ormsdon Quay, Dublin—Wet gas metres.
- 1913. A. Powell, Liverpool—Boots, shoes, and other coverings for the feet.
- 1914. E. J. Mygridge, 6, St. John's Villas, Adelaide-road, St. John's wood—Apparatus for washing clothes and other textile articles.
- 1915. J. Cook, East India-road, Poplar—Smoke-consuming furnaces.
- 1916. M. Pratt, Fenton Potteries, Staffordshire—Manufacturing candle moulds.
- 1917. G. Edwards, 4, Park-road Villas, Battersea—Traction for railways, tramways, and other roads.

Dated August 2, 1861.

- 1918. J. Wright, 42, Bridge-street, Blackfriars—Machinery to be used in carding cotton and other textile substances.
- 1919. R. Benton, 5, Great College-street, Westminster—Motive power machinery.
- 1920. F. W. Turner, Llansamlet Works, Swansea—Apparatus for obtaining and applying the motive power of steam.
- 1921. J. E. Dronot, 4, South-street, Finsbury—Kneading machines.
- 1922. W. E. Newton, 66, Chancery-lane—machinery for cleaning rice, coffee, and other grains or seeds.

Dated August 3, 1861.

- 1923. E. Tomlinson and G. W. Wilson, Liverpool—extinguishing fires in warehouses.
- 1924. G. Bish, High-street, Stratford, and J. Dredge, 11, Adam-street, Adelphi—Forming bends and other forms or parts of non-metallic pipes.
- 1925. M. Merryweather and R. M. Merryweather, Long-acre—Pumps applicable to steam and other fire engines.
- 1926. J. Cross, Manchester—Fastenings for wearing apparel and in the application thereof.
- 1927. G. F. Jones and J. Jones, York—Protecting and arranging water pipes.
- 1928. C. Schinz, Offenburg, Grand Duchy of Baden—Glass furnaces.
- 1929. Viscount de Ponton D'Amécourt, Paris—An aëro-statical apparatus or helicopter.
- 1930. P. Habert, Barle-duc, France—Loom for weaving cloths of all kinds.
- 1931. J. Henderson and J. Broadley, Saltair, near Bradford—Apparatus employed in weaving.
- 1932. P. O'Hanlon, Nile-street, Kingston-upon-Hull—Marine and other steam boilers.
- 1933. J. Vavasseur, 28, Gravel-lane, Southwark—Machine for rifling cannon.
- 1934. A. Prince, 4, Trafalgar-square, Charing-cross—Palate and tooth plates for dental purposes.
- 1935. W. E. Newton, 66, Chancery-lane—An improved process for producing colouring matters or pigments from manganese.
- 1936. J. Lewis, Rathmines, Dublin—Producing and treating printing surfaces.

Dated August 5, 1861.

- 1937. F. Richmond and H. Chandler, both of Salford, and W. B. Ritchie, Belfast, Ireland—An improved sack holder.
- 1938. C. Burn, Delahay-street, Westminster—Mode of fastening iron armour plates to ships' sides.
- 1939. H. C. Meyer, Hoxton—Slide valves.
- 1940. S. S. Fitch, 16, Upper Seymour-street, Portman-square—An improved chest expander.
- 1941. E. D. Johnson, Wilmingon-square—Construction of centre seconds watches.
- 1942. J. Potter, Leeds—Straining pillars or posts for wire or other strained fencing.
- 1943. R. A. Brooman, 166, Fleet-street—Locks and other fastenings and keys.
- 1944. F. Seiler, Paris—Mode of overleaping differential levels.

- 1945. M. A. F. Mennons, 39, Rue de l'Echiquier, Paris—Grates of reverberatory and other metallurgic furnaces.

Dated August 6, 1861.

- 1946. J. A. Petit, 17, Red Lion-square—Manufacture of watches and clocks.
- 1947. M. A. F. Mennons, 38, Rue de l'Echiquier, Paris—An improved odontalgic elixir.
- 1948. W. Galloway and J. Galloway, Manchester, and J. W. Wilson, Barnsley, Yorkshire—Steam boilers.
- 1949. G. Potts, Edinburgh—Improved elastic steel mattresses.
- 1950. E. Wappenstein, Manchester—An improved cop tube and cover for rollers used in spinning.
- 1951. J. Turner and R. B. Dunnett, Liverpool—Stamping, endorsing, and embossing machines.
- 1952. F. Tolhausen, 35, Boulevard Bonne-Nouvelle—Mechanical contrivances increasing the effect of motive power.
- 1953. J. MacMorran, 33, Leicester-square, London—Machines for mincing meat.
- 1954. E. A. Cowper, Great George-street, Westminster—Protecting ships of war and land batteries from the effects of projectiles.
- 1955. A. A. R. Damoiseau, Paris—Apparatus for drawing blood or other fluids from the human or animal body.
- 1956. W. Clark, 53, Chancery-lane—Bleaching and clarifying saccharine matters.
- 1957. A. V. Newton, 66, Chancery-lane—Construction of reversible seats.
- 1958. P. Spence and J. Mellor, Newton Heath, near Manchester—Separating copper from its ores.
- 1959. F. Silveston, Warwickshire—Watches.

Dated August 7, 1861.

- 1960. W. H. Richards, Newton, Massachusetts, United States—A new and useful or improved combined knife, fork, and spoon for camp or other purposes.
- 1961. D. Miles, Newport, Monmouth—Construction of window sashes.
- 1962. N. A. Lessner, Boulevard des Amondiers, Paris—A new system of covering for houses.
- 1963. E. T. Hughes, 123, Chancery-lane—An improved wheel-barrow wagon.
- 1964. M. A. F. Mennons, 39, Rue de l'Echiquier, Paris—Certain descriptions of breech-loading fire-arms.
- 1965. W. R. Rogers, Gray's Inn-road—Machinery to be employed in the application of dowels to woodwork.
- 1966. T. G. Webb, Manchester—Manufacture of articles of glass.
- 1967. L. W. Viollier, U. S. Consul at Lyons—Machinery for doubling and twisting yarns.

Dated August 8, 1861.

- 1968. J. Eastwood and T. C. Eastwood, both of Marshall Mill, Manchester-road, Bradford—A new kind of yarn called the "Gorilla yarn," and the cloth woven therefrom called "Gorilla cloth."
- 1969. N. D. P. Maillard, Dublin—Self-acting and inexhaustible hydraulic and atmospheric motive power engines.
- 1970. J. Gedge, 11, Wellington-street, Strand—Apparatus for beating or threshing grain.
- 1971. J. Coldwell and W. Coldwell, both of Sheffield—Manufacture of sheep shears.
- 1972. R. Jukes, Sheffield—Puddling furnaces.
- 1973. W. S. Hogg, Rotherhithe Wall, Rotherhithe—Construction of doors, gates, and shutters.
- 1974. R. De Clercq and E. Chazelles, of Brussels, Belgium—System of machines to raise water or any other liquids.
- 1975. G. H. Bovill, Durnsford Lodge, Wimbledon—Construction of vessels.
- 1976. A. V. Newton, 66, Chancery-lane—Construction of sewing machines.
- 1977. A. V. Newton, 66, Chancery-lane—Single thread sewing machines.
- 1978. L. Le Laige, Mermex, near Antwerp, Belgium—Treating fatty and oily matters.
- 1979. H. Kinsey, Robin Hood Works, Nottingham—Steam engines and boilers.

Dated August 9, 1861.

- 1980. G. Haycraft, 23, Lombard-street—Powder flasks.
- 1981. A. J. Mott, Liverpool—Casks and other vessels.
- 1982. C. P. Moody, Corton Denham, Somersetshire—Construction of gates.

1993. J. Hemingway, Robert Town, Yorkshire—Apparatus for working coal, ironstone, or other minerals.
1994. L. Vassiviere, Lyons, Rhone—Smoke-consuming Apparatus.
1995. J. Griffin and C. Griffin, Walsall, Staffordshire—Machinery for cutting corks and bungs.
1996. H. Cbatwin, Birmingham—Manufacture of card, needle, pins, and other cases.
1997. A. V. Newton, 66, Chancery-lane—Machinery for sewing.
1998. C. Lee and T. K. Mace, Birmingham—Improvements in backing or covering the backs or foundations of raised and cut pile fabrics.
1999. J. Gray, T. Kershaw, B. Crowther, and A. Dean, Manchester—Mules for spinning.
1990. R. A. Godwin, 151, Newport-street, Paradise-street, Lambeth—Pumps.
1991. A. F. B. Falgas, 91, Rue de Malte, Paris—Composition of bandages for hernias and hydrogastric girdles.
1992. G. H. Birbeck, 34, Southampton-buildings, Chancery-lane—Construction of tents for military and other purposes
Dated August 10, 1861.
1993. A. S. and A. R. Stocker, Wolverhampton—Horse shoes.
1994. H. Wilde, Manchester—Electro-magnetic telegraphs.
1995. W. S. T. Clarke, Charing Cross, Westminster—A railway-break.
1996. T. Schneider, 74, Horseferry-road, Westminster, and C. E. Crawley, 17, Gracechurch-street—Inlaying wood, ivory, and other substances.
1997. A. Barday, Kilmarnock, North Britain—Apparatus for raising, lowering, or moving heavy bodies.
1998. M. Wigzell, Friars Green, Exeter—Apparatus for twisting ordinary nails and all other similar driving articles of a parallel or tapered form.
1999. M. Wigzell, Friars Green, Exeter—Apparatus for making plain twisted nails.
Dated August 12, 1861.
2000. H. Greaves, 22, Abingdon-street—Apparatus to be employed for the water conveyance and delivery of coals and other materials.
2001. A. Garzend, 29, Boulevard St. Martin, Paris—Apparatus for scraping wood of any kind.
2002. W. E. Gedge, 11, Wellington-street, Strand—Breaking apparatus for railway and other vehicles.
2003. W. E. and E. Edwards, Coventry—Apparatus applied to the breaks of railway carriages.
2004. A. Salomons, Old Change—A new or improved article of female apparel.
2005. V. Jankowski, Princes-street, Fitzroy-square—Apparatus to facilitate the sawing of wood and other substances.
Dated August 13, 1861.
2006. J. H. Elvans, 7, Guildford-place, Lower Kennington-lane—An improved steel bush or stay fastening.
2007. J. Humpage, Balsall Heath, King's Norton, Worcestershire—Reaping and mowing machine.
2008. J. C. Horner, Avenue-road, Hammersmith—Looms for weaving.
2009. J. Jacob, Brunn, Austria—Producing on porcelain and glass designs in colours.
2010. J. Lancaster, Princes-street, Bedford-row—A new method of producing sand.
2011. S. Andrew and S. Hornby, Staleybridge, Lancashire—Apparatus for opening, cleaning, and preparing cotton.
2012. J. G. Remy, Brussels—Manufacture of articles of furniture.
2013. C. Binks, Gray's Inn—Apparatus for treating linseed and other oils.
2014. N. Common, Brighton—Apparatus applicable to water-closets and urinals.
2015. B. Cooper, Froine—Machinery for spinning and doubling fibrous materials.
Dated August 14, 1861.
2016. W. Robertson, Manchester—Machines for preparing to be spun cotton and other fibrous materials.
2017. E. A. Ripplingille, Prestolee Farnworth, near Manchester—Steam engines.
2018. N. Cox, Chester—Iron ships.
2019. W. E. Gedge, 11, Wellington-street, Strand—Pressing boards for pressing cloth and other fabrics.
2020. F. Durand, Paris, France—Manufacture of metallic tubes.
2021. A. A. R. Demoiseau, Paris—Construction of kiln for baking bricks, tiles, or other similar articles.
2022. G. J. Wainwright, Dukinfield, Cheshire—Apparatus used in preparing and spinning cotton or other fibrous materials.
2023. R. A. Brooman, 166, Fleet-street—Coating wire with copper, silver, gold, or other metal or alloy in order to prevent oxidation.
2024. E. Edwards, 13, Beaufort-buildings, Strand—Apparatus for separating mineral ores, coal, and other substances from impurities.
2025. T. Silvester, West Bromwich—Spring balances or weighing apparatus.
2026. W. Wilds, Hertford—Apparatus for ventilating.
2027. J. Billing, 12, Abingdon-street, Westminster—Stoves.
Dated August 15, 1861.
2028. A. Lebaudy, 12, Rue de Douai, Paris—Towing vessels.
2029. S. Carey and W. M. Pierce, Animal Charcoal Works, East Ham, Essex—Apparatus for reburning animal charcoal.
2030. J. C. Rivett, J. Vickers, and S. Hayes, Prestolee New Mills, Farnworth, near Manchester—Apparatus for spinning and doubling fibrous materials.
2031. J. Bethell, 38, King William-street—Journals, axle-boxes, and bearings for machinery.
2032. J. C. Martin, High-street, Barnes—Treating bones.
2033. P. Webley and T. W. Webley, Birmingham—Elevating rifle sight.
2034. F. A. Kain, Redhill, Reigate—Manufacture of artificial stone.
2035. J. T. Hutebings, Cbarlton, Kent—Construction of tennis and racquet hoops with handle.
2036. S. Desborough, Noble-street, St. Martin's-le-Grand—Manufacture of umbrellas and parasols.
2037. A. F. Menard, 19, Rue de Strasbourg, Paris—Tanning.
2038. C. W. Kesselmeier, Manchester, and T. Melodew, Oldham—Manufacture of velvets and velveteens.
2039. J. Combe, Belfast—Machinery for heckling flax and other fibrous substances.
2040. J. Faucherre, Green Terrace—Manufacturing gold dials.
2041. R. D. Chatterton, Highbury-terrace—Transmitting motive power.
2042. T. Murecott and C. Hanson, Haymarket—Breech-loading arms.
Dated August 16, 1861.
2043. J. Livesey, New Lenton, Nottinghamshire—A new textile fabric for embroidery.
2044. A. V. Newton, 66, Chancery-lane—Knitting machinery.
Dated August 17, 1861.
2045. H. C. Hill, Stalybridge—Construction of fire-proof buildings.
2046. T. Settle, Bolton, Lancashire—Apparatus employed in preparing cotton.
2047. E. Sutton, Radcliffe—Apparatus for preparing cotton.
2048. M. H. Randle, 22, Ludgate-hill—Sous-juppe or under petticoats for distending articles of dress.
2049. P. Walters, Wolverhampton—Machinery for cutting, sawing, and slicing or planing wood.
2050. Z. Colburn, 15, Tavistock-street, Bedford-square—Apparatus for heating water intended for the supply of steam boilers.
2051. P. Hart, Hampton Wick—Mills for grinding.
2052. R. Caunce, Nottingham—Carding engines.
Dated August 19, 1861.
2053. W. Bennett, 14a, London-street, Paddington—A new composition for the lighting of fires.
2054. Z. Colburn, 15, Tavistock-street, Bedford-square—Construction of suspension bridges.
2055. J. Robb, Aberdeen—Ventilating.
2056. G. T. Selby, Smethwick—Surface condensers.
2057. E. S. Cathels, Shrewsbury—Compensating gas meters.
2058. W. H. Smith, Philadelphia, United States—Preparation, application, and manufacture of peat.
2059. W. Gossage, Widnes—Manufacture of certain kinds of soap.
2060. W. Firth, Burley, Leeds—Machinery for digging or turning up soil, moving, reaping, and other agricultural purposes.
2061. T. Pedrick, 5, Park-place, Brixton—Obtaining and applying motive power.
Dated August 20, 1861.
2062. B. Hargreaves and J. Hargreaves, Burnley, Lancashire—Valves of steam engines.
2063. G. Ingram, Old-street—Endless train to be used on common roads.
2064. A. S. Kostaing, Dresden, Saxony—Constructing spectacles.
2065. W. Fitkin, 88, Fleet-street—Apparatus for extracting teeth.
2066. H. Emes, Adelaide-road, Haverstock-hill—Dress fastenings.
2067. R. A. Brooman, 166, Fleet-street—Preserving meat and other animal substances.
2068. R. A. Brooman, 166, Fleet-street—Apparatus for transmitting motive power.
2069. S. Whittaker, Haverstock-hill, and R. A. Jones, Aylesbury—Operating upon railway signals.
2070. S. Warwick, Lower-road, Islington—Concertinas.
2071. J. Somerville, Maidstone—Apparatus for drilling and tapping gas and water mains and pipes.
2072. J. Platts, Glasgow—Looms for weaving.
2073. T. Sutton, King's College—Camera for taking photographic portraits.
2074. R. S. Lambert, White Hall, Clevedon—Vessel for removing sugar and other liquids from boiling pans.
2075. F. Gye, Royal Italian Opera, Covent Garden—Gasmeters and gasometer tanks.
2076. G. F. Muntz, French Halls, Birmingham—Sheathing iron ships or vessels.
2077. G. F. Muntz, French Halls, Birmingham—Apparatus for melting metals.
2078. N. Fisher, Milton, near Blisworth—Agricultural implements for grubbing and cultivating land.
2079. J. Ellis, 62, Minories—Mecbanism for sizing coaks.
Dated August 21, 1861.
2080. C. A. Wheeler, Swindon, Wiltsbire—Preventing wind draughts at the foot of doors.
2081. T. Lambert, Tborncroft Farm, Great Henny, Essex—Agricultural implement for rolling ridges and furrows or straight work.
2082. W. Mason, Liverpool—An improved soap.
2083. W. Clark, 53, Chancery-lane—Optical and illuminating apparatus.
2084. W. Clark, 53, Chancery-lane—Construction of buildings.
2085. A. Stein, Edinburgh—Distillation.
2086. N. Salamon, 3, Ludgate-street—Apparatus for sewing machines.
2087. A. J. Hennart, Tournay, Belgium—Economical smoke-consuming grates.
2088. M. A. F. Mennons, 39, Rue de l'Echiquier, Paris—Presses for lithographic printing.
2089. J. M. Murat, 91, Rue de Malte, Paris—Machinery for shearing mechanically the military pompons.
2090. A. Jervis, Coventry—Manufacture of pleated, ribbed, and looped fabrics.
2091. T. Green, Smithfield Iron Works, Leeds, and R. Mathers, 18, Stoke Newington-green—Apparatus for transmitting motion to machinery.
2092. T. Grahame, Worthing—Construction of boats, rafts, and other floating structures.
2093. W. Richards, Birmingham—Rifles and projectiles.
2094. J. Kane, Templemoyle, near Dungwen, Ireland—Treating, flax, hemp, and other analogous substances.
Dated August 22, 1861.
2095. A. I. Mahon, 25, Leinster-square, Rathmines, Dublin—Screw or spiral propellers.
2096. J. H. Johnson, 47, Lincoln's-inn-Fields—Preparation of pulp for paper.
2097. B. Samuelson, Banbury—Harvesting machines.
2098. E. Landsberg, sen, Paris, France—Porte-robos or buttons for bolting up the skirts of ladies' gowns.
2099. R. Telford, Birmingham, and J. Sanders, Clifton—A substitute for castors for furniture.
2100. L. M. Casella, Hatton Garden—Mercurial thermometers.
2101. T. F. Doyle, 3, Guildford-place, Russell-square—Apparatus for raising and forcing fluids.
2102. W. Baines, London Works, Smethwick—Construction of girders.
2103. T. Richardson, Newcastle-upon-Tyne, and R. Irvine, Hurlet, Renfrewshire—Manufacture of paper.
Dated August 23, 1861.
2104. J. Whitworth and W. W. Hulse, Manchester—Sights for small arms and ordnance.
2105. M. Blakey, Leeds—Rotary pumps.
2106. J. Dunn, Alnwick, Northumberland—Reaping machines.
2107. A. B. Childs, London—Dressing of millstones.
2108. S. Elson, Oldham—Apparatus for heating the feed water of steam boilers, superheating steam and surface condensation.
2109. W. D. Payer, Birmingham—Description of buttons commonly known as linen buttons.
2110. R. A. Brooman, London—Improved method of treating the hop plant to obtain a material resembling wool.
2111. H. Ingle, Shoe-lane, and J. Ingle, Pimlico—Printing machines.
2112. W. Evans, Willow-walk, and E. Concanen, Grange-road, Bermondsey—Pens or writing instruments.
- 2113.—G. T. Bousfield, Brixton—Apparatus for feed boilers.
Dated August 24, 1861.
2114. M. Hyams, Bath-street, City-road—Smoking pipes and cigar tubes, and preparing, washing, coating, covering, or otherwise impregnating them with aromatic substances in a solid, liquid, or aeriform state.
2115. J. Driver, Keighley, and J. Jessop, Bradford—Means or apparatus employed in washing, wringing, and mangling fabrics, and in the manufacture of part or parts of such apparatus.
2116. W. Clissold, Dudbridge Works, near Stroud—Apparatus for oiling wool.
2117. J. Branston, Birmingham—Construction of conservatories, orchard houses, and other horticultural erections.
2118. H. B. Coathupe, Junior United Service Club—Time-keepers.
Dated August 26, 1861.
2119. M. A. F. Mennons, British and Foreign Patent Offices, Paris—Propulsion and steering of ships or vessels, and in the construction and arrangement of the machinery connected therewith.
2120. R. W. Jones, Glenbrook Baths and Hotel, Cork—Heating and ventilating baths, especially applicable to Turkish baths.
2121. J. Clark, Glasgow—Envelopes and other covers, and in part applicable to the gumming of sheets of paper.
2122. H. Nelson, Manchester, J. Carr, Blackburn, and G. Harrison, Burnley—Self-acting mules for spinning cotton and other fibrous materials.
2123. G. Nye, 18, Mount-street, Lambeth—Apparatus for administering injection in a continuous stream, also applicable as an eye douche and other purposes.
2124. A. Leehene, 9, Stanhope-street, Hampstead-road, and C. Nathan, 17, Westmoreland-street, Pimlico—Imitation of embroidery for ladies' collars, cuffs, &c., and all sorts of embroidered articles.
2125. J. L. Field, Colton Haverthwaite, Lancashire—Construction of armour plates, and in their application to ships and batteries.
2126. F. Tolhausen, 35, Boulevard Bonne-Nouvelle, Paris—A kind of fur to be made by means of the Jacquard or other loom with silk or other textile material.
2127. F. Tolhausen, 35, Boulevard Bonne-Nouvelle, Paris—Producing dynamical electricity, thereby obtaining useful chemical compounds.
2128. J. C. Haddan, Bessborough-gardens, Pimlico, and C. Minasi, St. James's-terrace, Camden-town—Projectiles and cartridges.
2129. W. E. Newton, 66, Chancery-lane—Machinery for filtering liquids, decolorising saccharine and other juices, and rectifying alcoholic liquors.
2130. H. Attwood, Wapping-wall, Middlesex—Cleansing and feeding boilers.



RATIO OF BREAKING WEIGHT, WEIGHT, AND SPAN OF TUBULAR GIRDER BRIDGES.

ACCORDING TO THE FORMULÆ OF THE BOARD OF TRADE AND W. FAIRBAIRN, ESQ., C.E. LL.D. F.R.S.

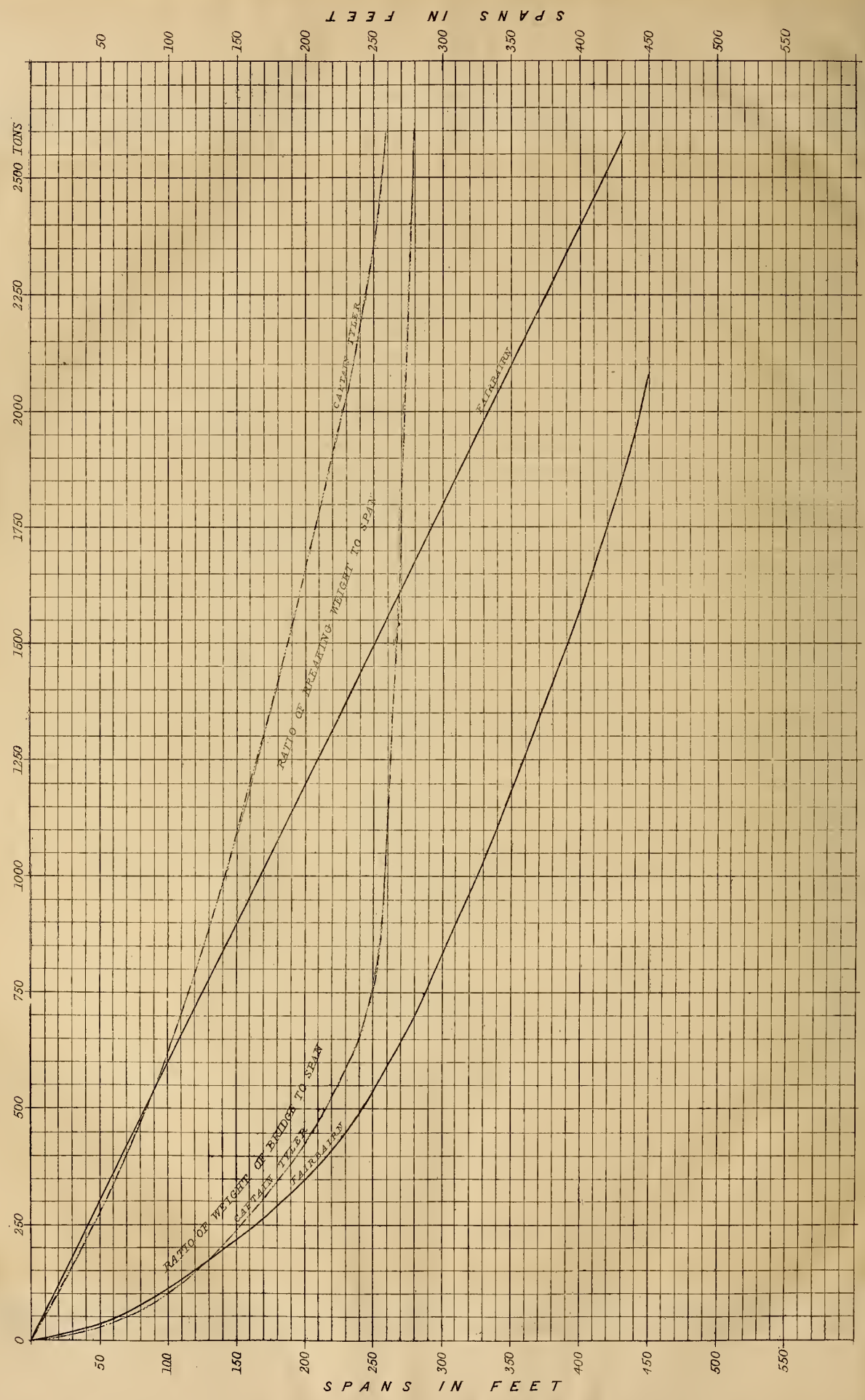



TESTING GIRDBERS FOR THE MANCHESTER

FIG. 1. SIDE ELEVATION

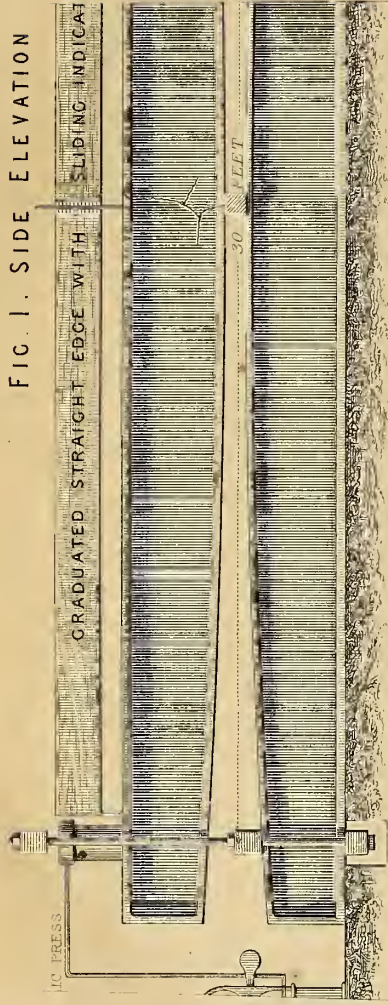

FIG. 3. GIRDER AFTER FRACTURE

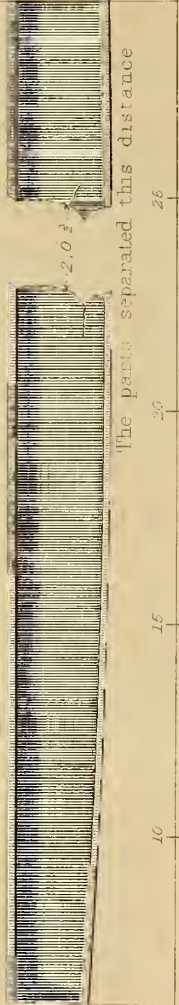
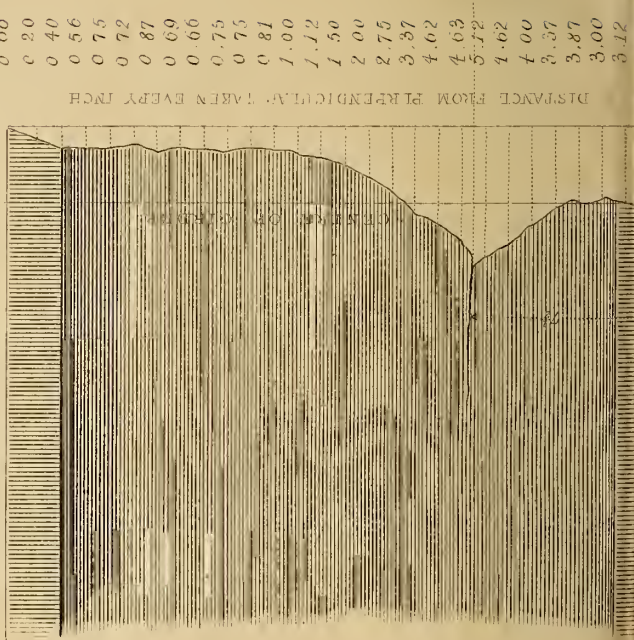

FIG. 4. DIAGRAM SHEWING FRACTURE



2.15
 .3
) Feet
 † CwL

4.03 5.44
 5.12
 4.62
 4.00
 3.37
 3.87
 3.00
 3.12

THE ARTIZAN.

No. 226.—VOL. 19.—OCTOBER 1, 1861.

TESTING GIRDERS FOR THE MANCHESTER CORPORATION.

(Illustrated by Copper-plate Engraving 202.)

In the accompanying Copper-plate engraving, illustrating the testing of girders for the Manchester Corporation, during the experiments made by Mr. J. G. Lynde, the City Surveyor. Fig. 1, is a side elevation of the girder to be tested, and its support, and the hydraulic press; Fig. 2, is an end elevation of the same: Fig. 3, represents the girder after the fracture; Fig. 4, is a diagram shewing an enlarged view of the fracture; and Fig. 5, is a sectional end view of the fracture.

The girder in question was one of a number being made by Mr. Walter Mabon, of the Ardwick Iron Works, for the Corporation of the City of Manchester, for covering the Medlock where it is intended to build gas retort houses, &c. over the river which at present divides their works.

MIXTURE OF IRON IN GIRDER.

Hematite Cleator,	Whitehaven,	15 cwt.
Glegarnock,	Scotch,	12 "
Summer Lee,	Scotch,	8 "
G. W. L.	Yorkshire,	10 "
Stockton,	Yorkshire,	10 "
Lane End,	Staffordshire,	8 "
Scrap,		21 "

Total 84 cwt.

RESULT OF TESTING.

Load in Centre.	Deflection.	Permanent Set.
Tons.	Inches.	Inches.
20	.37	.000
30	.55	.000
40	.77	.008
50	1.04	.060
55	1.20	not taken after 50 tons.
60	1.34	
65	1.52	
70	1.67	
75	1.85	
80	2.03	
85	2.30	
88	2.45	
90	broke.	

A bar of the same mixture of iron was cast, 1 inch square, and three feet 6 inches long, for the sake of comparing it with former experiments, on other kinds of iron, by other experimenters.

RESULTS OF TESTING A BAR 1 INCH SQUARE AND THREE FEET BETWEEN SUPPORTS.

Load in Centre.			Deflection.
cwt.	qrs.	lbs.	Inches.
6	2	0	.55
6	3	0	.62
7	0	0	.69
7	1	0	.69
7	2	0	.70
7	2	7	...
7	2	14	...
7	3	0	.73
7	3	7	broke

CALCULATION FOR TESTING GIRDERS FOR THE MANCHESTER CORPORATION.

The Ram of Cylinder is $5\frac{1}{2}$ inches diameter, the area is equal to 20 square inches: therefore when the pumps put one ton per square inch on the Ram, the pressure will equal 20 tons, and so in proportion for parts of a ton.

Calculation for tackling, or dead weight, will be as follows:

The Cylinder and Ram weigh $4\frac{1}{2}$ cwt. These being put at one end without counterbalance, gain a leverage of twice their weight on the centre	9 cwt.
The 2 cross pieces on top of beam and the 4 bolts weigh $10\frac{1}{2}$ cwt. These being at opposite ends give their weight only on centre,	$10\frac{1}{2}$
The beam itself weighs 3 tons 19 cwt. This being a distributed weight, and being half on each side of the centre point, will be equal to half its weight applied in the centre	$39\frac{1}{2}$

Total dead weight as applied at centre 59 cwt.

Every ton of pressure put on by the hydraulic press in the position shown in the Plate, will equal two tons of dead weight in centre to be added to the above.

It will be noticed that the permanent set was not taken after the pressure of fifty tons had been put on; as it was considered sufficient data had been obtained to shew where the set began.

It is part of the contract that the breaking weight of the girders shall not be less than 75 tons, applied at the centre. Each girder has a bar three feet six inches long and one inch square cast on it, for the purpose of testing its breaking weight, which is not to be less than $7\frac{1}{2}$ per cent. in its centre, between bearings three feet apart. Every girder to be tested to a pressure of twenty tons applied in the centre; and if the deflection exceeds five-eighths of an inch, or if it produce a permanent set, such girder to be rejected.

The experiments were conducted at the Ardwick Iron Works during the meeting of the British Association; the foundry and apparatus having been placed by Mr. Mabon at the entire disposal of Mr. J. G. Lynde, the Surveyor to the Corporation.

THE LIME LIGHT AT THE SOUTH FORELAND.

Five and thirty years ago Lieut. Drummond brought into notice the oxy hydrogen light, and applied it to a practical purpose. Having been appointed to conduct the ordnance survey in Scotland and Ireland, he used this light in the focus of a parabolic reflector on lofty eminences, where the stations were usually placed, as it was of the greatest importance in those operations to have certain and determinate signals, which could be seen, under any circumstances as to weather, at great distances. Thus he succeeded in connecting the shores of England and Ireland, near Holyhead, a distance of 65 miles, and afterwards, in Scotland, the summit of Ben Lomond with that of Knock Laid, no less than 95 miles apart. It did not escape the comprehensive mind of Drummond to perceive that such a light, if capable of practical application, would be invaluable for lighthouse purposes. With the means he devised, however, he failed to obtain anything approaching practical command over the continuity of the light; and as a light that is liable to go out is inadmissible for lighthouse purposes, it is not surprising that it was condemned.

Since Drummond's time, until quite recently, the oxyhydrogen, or lime light, has been used only for the purposes of the microscope, or to produce scenic effects; not that the value of a light of such power and intensity has been lost sight of, but because all attempts to render it practically available in a commercial sense had failed.

The impossibility of turning it to a useful purpose seems to have so taken possession of the public mind, scientific as well as general, that although within the last two or three years, exhibition after exhibition, varying in duration from hours to months, have given the most incontestable proofs that with Bartable's apparatus the lime light can be burned as easily and

PLAN OF TESTING GIRDERS FOR THE MANCHESTER CORPORATION

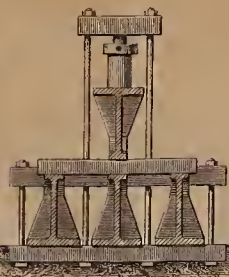

FIG. 2.
END ELEVATION

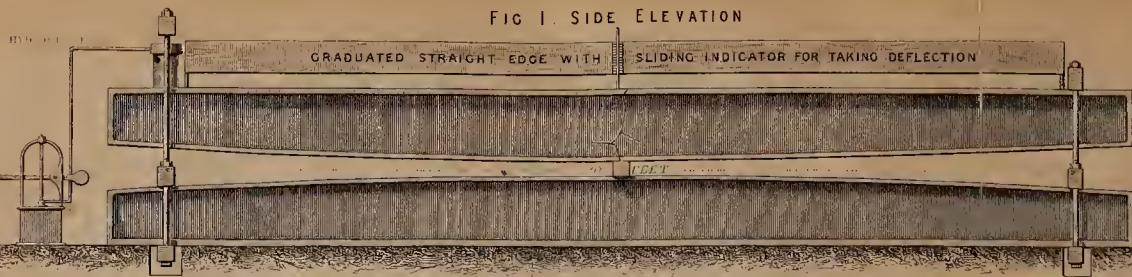

FIG. 1. SIDE ELEVATION



FIG. 3. GIRDER AFTER FRACTURE



FIG. 4. DIAGRAM SHEWING FRACTURE

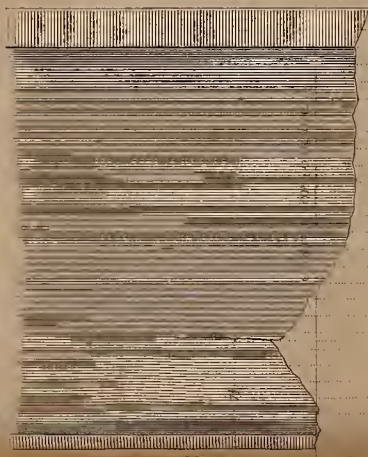

Inches

- 0 00
- 0 20
- 0 40
- 0 56
- 0 75
- 0 79
- 0 87
- 0 60
- 0 66
- 0 75
- 0 75
- 0 81
- 1 00
- 1 12
- 1 50
- 1 00
- 2 75
- 3 37
- 4 02
- 4 63
- 5 12
- 4 02
- 4 00
- 3 57
- 3 87
- 3 00
- 3 12
- 3 27

344

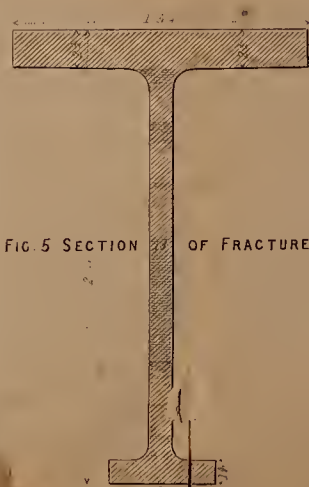

FIG. 5. SECTION OF FRACTURE

MEMORANDUM

Length of Girder	42.15
Thickness of Flange	2.3
Length of Flange	30 Feet
Weight of Girder	84 Cwt

certainly as a wax candle, yet, with a single but notable exception, not one eminent man of science has been found who has not scouted the idea of its practical utility. Upon almost every occasion of late when our men of science have condescended to mention the lime light, it has been condemned by them as impracticable, and the idea of its applicability to any useful purposes contemptuously dismissed; whilst the assumption that it can be used for ordinary domestic purposes has met with the most positive contradiction, interspersed, upon one or two occasions, with assertions as to the available sources and expense of oxygen gas, which, although valueless in themselves, are useful as indicating the amount and accuracy of information upon the subject possessed by some of those who have pronounced the severest condemnations of it. It has been the fashion in scientific circles to condemn the lime light, and there are few amongst those who have not compromised themselves more or less by decrying it; and experience will have taught us that from such we can expect but a tardy recognition of even a fact that is subversive of a long cherished dogma. This prejudice, which has seriously impeded the general introduction of the lime light, is traceable to its usual source—want of accurate information on the subject; for although the means were at hand, not one of those who ridiculed the idea that the lime light had been brought to a state of perfection, rendering its practical application to illuminating purposes easy and certain, took any trouble to make such an investigation as to the alleged fact as could justify the expression of any opinion at all. The public at large took the view of the *savans*, whose opinions were readily adopted and disseminated by those who are interested in the continuance of the present methods of producing artificial light; whilst the verdict of gas engineers, scientific advisers to gas companies, and other vested interests, upon the lime light was such as a notorious poacher might expect at the hands of a jury composed of cock-pheasants.

In the mean time, however, whilst the learned condemn it, and capital fought shy of it, the light went on burning steadily—carefully watched, examined, and, in course of time, appreciated by one, at whose hands truth never suffers, imposture is never spared, and whose opinions are ever formed for himself by patient and careful investigation, and not expressed until all doubt has been removed. Without having been made aware of the exact conclusions arrived at by this investigation, it must be supposed to have been favourable, as it led to a decision on the part of the Trinity Board to give the light a fair trial in a first order lighthouse, for which its peculiar qualities are pre-eminently fitted. To this end a contract was entered into with the Universal Lime Light Company by the Elder Brethren for the exhibition of the light in the South Foreland Lighthouse for three months, and upon its success will, in all probability, depend its extensive adoption for the purposes of coast lighting. The light was introduced on the 26th of August, and has continued to burn steadily and brilliantly every night since its substitution for the oil light. Indeed, after the report of Mr. Page, the engineer of Westminster bridge, upon the success of the lime light which for two months illuminated the finished part of that structure, no doubt can exist as to the facility with which it can be maintained, for no case of failure occurred there in maintaining regularly eighteen lights in nine different lamps, where the operation of making the gases had to be conducted upon temporary platforms, suspended between wind and water, and the whole arrangements necessarily of an incomplete and temporary character, added very largely to the ordinary risk of a failure occurring. The lamp at the South Foreland is fitted with eight burners, to meet the requirements of the Fresnel apparatus, which is composed of eight panels: only six out of the eight burners, however, are required, as the two panels towards the land are darkened. The manipulation of the lamp is perfectly simple, not necessitating an amount of intelligence greater than is required in the case of an ordinary Argand lamp. When the time for lighting comes the lime wicks are inserted, the clock which moves them wound up, and the gases turned on, and no further attention is required until the hour arrives for putting out the light, when the gases are turned off, and the clock is stopped; the lime wicks are then removed, and nothing further remains to be done. The brilliancy of the light has not escaped the notice of our friends on the other side of the Channel, many of whom have been over to visit it. It is but fair to state that the present apparatus in which the lamp is exhibited is not calculated to give the maximum effect, having been especially adjusted for the usual Argand oil lamp, which differs from the lime light in the essential particular of focal distance, which is measured from the centre of the former, but from the surface of the latter; the lime light, therefore, although of the same diameter as the oil flame, is too near the lenses by half its diameter—in this case by $1\frac{1}{2}$ inches. It is to be hoped that this light will be tried both in a French apparatus, specially adjusted, and in the focus of paraboloid, for it appears to possess every element, rendering it by far the best light for coast purposes ever introduced.

Amongst other attributes of the lime light is another of the very last importance. It is not affected by wind, even though unprotected by glass. At Liverpool, where the lime light was exhibited for two months upon the landing stage where the Birkenhead ferry boats ply, this

property was most severely tested. One night a gale of wind came on, and increased in violence until the glasses of the lanterns were dashed in, and the light was exposed to its full power. No apparent effect was produced upon them, for they continued to burn as steadily and brightly as before. It has happened, not so unfrequently as might be imagined, that the glass of our lighthouses has been broken, in violent gales, and the light blown out. On a future occasion it is intended to explain the methods in which the gases are manufactured; it is unnecessary to explain here what the lime light is, as most of our readers are probably well informed upon the sources of its production.

[We are obliged to defer, until next month, the description of the lamp and the wood-cut.—Ed.]

THE RECENT ACCIDENT TO THE "GREAT EASTERN."

The rudder broke off by torsional strain, inside the ship, below the lower tiller, but, fortunately, two-and-a-half feet above the deck of the lower steering room; about six inches above this deck a bell-shaped cylinder, about 3ft. in diameter, similar to a common capstan, was keyed on to the rudder spindle (10 inches diameter). Balls of iron were interposed between this capstan and the deck; and a large nut, 15in. diameter and 12in. high, screwed on to the spindle, kept the capstan in its place; directly above, and partially in this nut the fracture took place. An attempt was made to unscrew the large nut, and it was accomplished to the extent of $1\frac{1}{4}$ inches; but as this nut was originally intended to assist in the support of the rudder, it occurred to Mr. Towle that if this nut was quite removed the rudder might be totally lost. After two days had been fruitlessly spent in endeavouring to render the rudder workable by other schemes, Mr. Towle showed Capt. Walker a sketch illustrating the means he proposed to employ to enable the rudder to be worked in its then disabled state, and this plan was adopted.

To carry out Mr. Towle's plan it was first necessary to replace the nut to bring the rudder to its original bearings. This was a work of some difficulty to accomplish, owing to the weight of the rudder to be lifted, and there not being room to work a wrench when placed on the nut. To overcome this, Mr. Towle used the following ingenious plan:—Advantage was taken of the swinging of the rudder by the force of the waves, to render such action available for screwing the nut into its proper place. To accomplish this, the moment was watched when the rudder was on the proper side of the ship, when the wrench was placed upon the nut and firmly held, and as the position of the rudder was reversed by the succeeding wave, the nut was screwed down a certain distance, when the wrench was removed, and re-applied when the rudder resumed its first position; and thus, by a repetition of this manoeuvring, the screwing home of the nut was fortunately accomplished in about three hours.

The cone upon the head of the rudder-shaft being similar to a capstan head, chain cables of suitable size were firmly wound round this, and kept lashed down so that the ends only were free, and were carried one turn each around the "bits," and were held by a common pair of blocks. The steering gear from the old tiller was then unshipped, and, with a piece of $1\frac{1}{2}$ in. chain attached to a point in either side, near the chain drum, when by slacking out the rope and tackle on the side desired, the rudder could be worked as accurately as ever. By hauling in the slack by means of the rope tackle on the other side, safety was ensured in case a heavy sea should strike the rudder and break the $1\frac{1}{2}$ in. chain or its shackles, which did occur several times during the 48 hours' constant steering. The engines, however, never stopped, with the exception of about half-an-hour at the time of speaking the brig *Magnet*.

IMPROVEMENTS IN WET GAS METERS,

By MR. H. SHAW, DUBLIN.

This invention has been introduced with a view of removing the defects appertaining to ordinary wet meters from the change of water level, &c., and which are a constant source of annoyance. We are, therefore, glad to notice this improvement.

The illustration shows a front elevation of an ordinary meter with the improvements, viz., a reservoir C, a supply pipe D, and an inverted water valve B. The inverted valve is in connection with the hall float, and is raised and depressed with it. The valve when raised to its seat is a perfect security against water entering the meter, and when depressed it will admit water from the cistern and reservoir by means of the supply pipe until the valve is again closed.

The means by which the water line will remain undisturbed during the time the gas is being turned on or into the meter are simply an adjustment of the "opens," through which the water cannot pass from one chamber to the other until the pressure of the gas on both chambers are

alike—thus a dead level is maintained with certainty, unless disturbed surreptitiously or from evaporation, when the water valve will open and admit such quantity of water as will restore the level to the correct line.

The reservoir may be sufficiently capacious to hold a supply of water for years, and when emptied, notice thereof will be given by the depression of the ball float actuating the gas valve A, shutting off the gas altogether from the meter.

The inverted water valve is protected from decay, and its sensitiveness preserved by its being kept continually immersed in the pure water, and

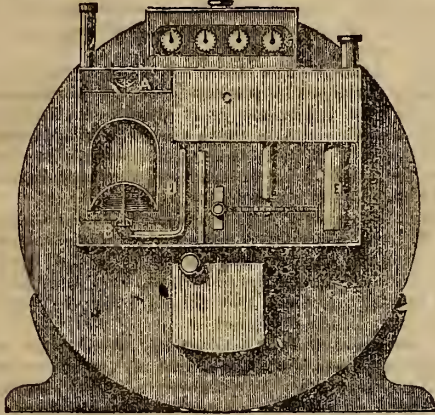

also that in the upper part it is covered *within* the concave of the bottom of the float. The entire range or action of the valves is limited to one-tenth of an inch, or what may be made a difference from the correct level line of one per cent.

E is the ordinary hydraulic pipe for re-filling the reservoir.

BRITISH ASSOCIATION FOR THE ADVANCEMENT
OF SCIENCE.

THIRTY-FIRST ANNUAL MEETING, HELD AT MANCHESTER, SEPT., 1861.

WILLIAM FAIRBAIRN, Esq., C.E., LL.D., F.R.S., PRESIDENT.

THE PRESIDENT'S ADDRESS.

GENTLEMEN OF THE BRITISH ASSOCIATION,—

Ever since my election to the high office I now occupy, I have been deeply sensible of my own unfitness for a post of so much distinction and responsibility. And when I call to mind the illustrious men who have preceded me in this chair, and see around me so many persons much better qualified for the office than myself, I feel the novelty of my position and unfeigned embarrassment in addressing you.

I should, however, very imperfectly discharge the duties which devolve upon me, as the successor of the distinguished nobleman who presided over the meetings of last year, if I neglected to thank you for the honourable position in which you have placed me, and to express, at the outset, my gratitude to those valued friends with whom I have been united for many years in the labours of the sections of this Association, and from whom I have invariably received every mark of esteem.

A careful perusal of the history of this Association will demonstrate that it was the first, and for a long time the only institution, which brought together for a common object the learned Professors of our Universities, and the workers in practical science. These periodical reunions have been of incalculable benefit, in giving to practice that soundness of principle and certainty of progressive improvement, which can only be obtained by the accurate study of science and its application to the arts. On the other hand, the men of actual practice have reciprocated the benefits thus received from theory, in testing by actual experiment deductions which were doubtful, and rectifying those which were erroneous. Guided by an extended experience, and exercising a sound and disciplined judgment, they have often corrected theories apparently accurate, but nevertheless founded on incomplete data, or on false assumptions inadvertently introduced. If the British Association had effected nothing more than the removal of the anomalous separation of theory and practice, it would have gained imperishable renown in the benefit thus conferred.

Were I to enlarge on the relation of the achievements of science to the comforts and enjoyments of man, I should have to refer to the present epoch as one of the most important in the history of the world. At no former period did science contribute so much to the uses of life and the wants of society. And in doing this it has only been fulfilling that mission which Bacon, the great father of modern science, appointed for it, when he wrote that "the legitimate goal of the sciences is the endowment of human life with new inventions and riches," and when he sought for a natural philosophy which, not spending its energy on barren disquisitions, "should be operative for the benefit and endowment of mankind."

Looking, then, to the fact that, whilst in our time all the sciences have yielded this fruit, engineering science, with which I have been most intimately connected, has pre-eminently advanced the power, the wealth, and the comforts of mankind, I shall probably best discharge the duties of the office I have the honour to fill, by stating as briefly as possible the more recent scientific discoveries which have so influenced the relations of social life. I shall, therefore, not dwell so much on the progress of abstract science, important as that is, but shall rather endeavour briefly to examine the application of science to the useful arts, and the results which have followed, and are likely to follow, in the improvement of the condition of society.

The history of man throughout the gradations and changes which he undergoes in advancing from a primitive barbarism to a state of civilisation, shows that he has been chiefly stimulated to the cultivation of science and the development of his inventive powers, by the urgent necessity of providing for his wants and securing his safety. There is no nation, however barbarous, which does not inherit the germs of civilisation, and there is scarcely any which has not done something towards applying the rudiments of science to the purposes of daily life.

Amongst the South Sea Islanders, when discovered by Cook, the applied sciences,—if I may use the term,—were not entirely unknown. They had observed something of the motions of the heavenly bodies, and watched with interest their revolutions, in order to apply this knowledge to the division of time. They were not entirely deficient in the construction of instruments of husbandry, of war, and of music. They had made themselves acquainted with the rudiments of shipbuilding and navigation, in the construction and management of their canoes. Cut off from the influence of European civilisation, and deprived of intercourse with higher grades of mind, we still find the inherent principle of progression exhibiting itself, and the inventive and reasoning power developed in the attempt to secure the means of subsistence.

Again, if we compare man as he exists in small communities with his condition where large numbers are congregated together, we find that densely populated countries are the most prolific in inventions, and advance most rapidly in science. Because the wants of the many are greater than those of the few, there is a more vigorous struggle against the natural limitations of supply, a more careful husbanding of resources, and there are more minds at work.

This fact is strikingly exemplified in the history of Mexico and Peru, and its attestation is found in the numerous monuments of the past which are seen in Central America, where the remains of cities and temples, and vast public works, erected by a people endowed with high intellectual acquirements, can still be traced. There have been discovered a system of canals for irrigation; long mining galleries cut in the solid rock, in search of lead, tin, and copper; pyramids not unlike those of Egypt; earthenware vases and cups, and manuscripts containing the records of their history; all testifying to so high a degree of scientific culture and practical skill, that looking at the cruelties which attended the conquests of Cortes and Pizarro, we may well hesitate as to which had the stronger claims on our sympathy, the victors or the vanquished.

In attempting to notice those branches of science with which I am but imperfectly acquainted, I shall have to claim your indulgence. This association, as you are aware, does not confine its discussions and investigations to any particular science; and one great advantage of this is, that it leads to the division of labour, whilst the attention which each department receives, and the harmony with which the plan has hitherto worked, afford the best guarantee of its wisdom and proof of its success.

In the early history of astronomy, how vague and unsatisfactory were the wild theories and conjectures which supplied the place of demonstrated physical truths and carefully observed laws? How immeasurably small, what a very speck does man appear, with all the wonders of his invention, when contrasted with the mighty works of the creator; and how imperfect is our apprehension, even in the highest flights of poetic imagination, of the boundless depths of space? These reflections naturally suggest themselves in the contemplation of the works of an Almighty power, and impress the mind with a reverential awe for the great author of our existence.

The great revolution which laid the foundation of modern astronomy, and which, indeed, marks the birth of modern physical science, is chiefly due to three or four distinguished philosophers. Tycho Brahe, by his system of accurate measurement of the positions of the heavenly bodies;

Copernicus, by his theory of the solar system; Galileo, by the application of the telescope; and Kepler, by the discovery of the laws of the planetary motions, all assisted in advancing, by prodigious strides, towards a true knowledge of the constitution of the universe. It remained for Newton to introduce, at a later period, the idea of an attraction varying directly as the mass, and inversely as the square of the distance, and thus to reduce celestial phenomena to the greatest simplicity, by comprehending them under a single law. Without tracing the details of the history of this science, we may notice that in more recent times astronomical discoveries have been closely connected with high mechanical skill in the construction of instruments of precision. The telescope has enormously increased the catalogue of the fixed stars, or those "landmarks of the universe," as Sir John Herschel terms them, "which never deceive the astronomer, navigator, or surveyor." The number of known planets and asteroids has also been greatly enlarged. The discovery of Uranus resulted immediately from the perfection attained by Sir William Herschel in the construction of his telescope. More recently, the structure of the nebulae has been unfolded through the application to their study of the colossal telescope of Lord Rosse. In all these directions much has been done, both by our present distinguished Astronomer Royal, and also by amateur observers in private observatories, all of whom, with Mr. Lassells at their head, are making rapid advances in this department of physical science.

Our knowledge of the physical constitution of the central body of our system seems likely, at the present time, to be much increased. The spots on the sun's disc were noticed by Galileo and his contemporaries, and enabled them to ascertain the time of its rotation and the inclination of its axis. They also correctly inferred, from their appearance, the existence of a luminous envelope, in which funnel-shaped depressions revealed a solid and dark nucleus. Just a century ago, Alexander Wilson indicated the presence of a second and less luminous envelope beneath the outer stratum, and his discovery was confirmed by Sir William Herschel, who was led to assume the presence of a double stratum of clouds, the upper intensely luminous, the lower grey, and forming the penumbra of the spots. Observations during eclipses have rendered probable the supposition that a third and outermost stratum of imperfect transparency enclosed concentrically the other envelopes. Still more recently, the remarkable discoveries of Kirchoff and Bunsen require us to believe that a solid or liquid photosphere is seen through an atmosphere containing iron, sodium, lithium, and other metals in a vaporous condition.

We must still wait for the application of more perfect instruments, and especially for the carefully registering of the appearances of the sun by the photoheliograph of Sir John Herschel, so ably employed by Mr. Warren de la Rue, Mr. Welsh, and others, before we can expect a solution of all the problems thus suggested.

Guided by the same principles which have been so successful in astronomy, its sister science, magnetism, emerging from its infancy, has of late advanced rapidly in that stage of development which is marked by assiduous and systematic observation of the phenomena, by careful analysis and presentation of the facts which they disclose, and by the grouping of these in generalisations, which, when the basis on which they rest shall be more extended, will prepare the way for the conception of a general physical theory, in which all the phenomena shall be comprehended, whilst each shall receive its separate and satisfactory explanation.

It is unnecessary to remind you of the deep interest which the British Association has at all times taken in the advancement of this branch of natural knowledge, or of the specific recommendations which, made in conjunction with the Royal Society, have been productive of such various and important results. To refer but to a single instance; we have seen those *magnetic disturbances*, so mysterious in their origin and so extensive in simultaneous prevalence,—and which, less than twenty years ago, were designated by a term specially denoting that these laws were wholly unknown,—traced to laws of periodical recurrence, revealing, without a doubt, their origin in the central body of our system, by inequalities which have for their respective periods, the solar day, the solar year, and still more remarkably, and until lately unsuspected solar cycle of about ten of our terrestrial years, to whose existence they bear testimony in conjunction with the solar spots; but whose nature and causes are, in all other respects, still wrapped in entire obscurity. We owe to General Sabine, especially, the recognition and study of these and other solar magnetic influences and of the magnetic influence of the moon similarly attested by concurrent determinations in many parts of the globe, which are now held to constitute a distinct branch of this science not inappropriately named "celestial," as distinguished from purely terrestrial magnetism.

We ought not in this town to forget that the very rapid advance which has been made in our time by chemistry, is due to the law of equivalents, or atomic theory, first discovered by our townsman, John Dalton. Since the development of this law its progress has been unimpeded, and it has had a most direct bearing on the comforts and enjoyments of life. A knowledge of the constituents of food has led to important deductions as to the relative nutritive value and commercial importance of different materials. Water has been studied in reference to the deleterious

impurities with which it is so apt to be contaminated in its distribution to the inhabitants of large towns. The power of analysis, which enables us to detect adulterations, has been invaluable to the public health, and would be much more so, if it were possible to obviate the difficulties which have prevented the operation of recent legislation on this subject.

We have another proof of the utility of this science in its application to medicine; and the estimation in which it is held by the medical profession is the true index of its value in the diagnosis and treatment of disease. The largest developments of chemistry, however, have been in connection with the useful arts. What would now be the condition of calico-printing, bleaching, dyeing, and even agriculture itself, if they had been deprived of the aid of theoretic chemistry?

For example: Aniline—first discovered in coal tar by Dr. Hoffman, who has so admirably developed its properties—is now most extensively used as the basis of red, blue, violet, and green dyes. This important discovery will probably in a few years render this country independent of the world for dye-stuffs; and it is more than probable that England, instead of drawing her dye-stuffs from foreign countries, may herself become the centre from which all the world will be supplied.

It is an interesting fact that at the same time in another branch of this science, M. Tournet has lately demonstrated that the colours of gems, such as the emerald, aqua-marina, amethyst, smoked rock crystal, and others, are due to volatile hydro-carbons, first noticed by Sir David Brewster in clouded topaz, and that they are not derived from metallic oxides, as has been hitherto believed.

Another remarkable advance has recently been made by Bunsen and Kirchoff in the application of the coloured rays of the prism to analytical research. We may consider their discoveries as the commencement of a new era in analytical chemistry, from the extraordinary facilities they afford in the qualitative detection of the minutest traces of elementary bodies. The value of the method has been proved by the discovery of the new metals Cesium and Rubidium by M. Bunsen, and it has yielded another remarkable result in demonstrating the existence of iron, and six other known metals, in the sun.

In noticing the more recent discoveries in this important science, I must not pass over in silence the valuable light which chemistry has thrown upon the composition of iron and steel. Although Despretz demonstrated many years ago that iron would combine with nitrogen, yet it was not until 1857 that Mr. C. Binks proved that nitrogen is an essential element of steel, and more recently M. Carou and Fremy have further elucidated this subject; the former showing that cyanogen, or cyanide of ammonium, is the essential element which converts wrought iron into steel; the latter combining iron with nitrogen through the medium of ammonia, and then converting it into steel by bringing it at the proper temperature into contact with common coal gas. There is little doubt that in a few years these discoveries will enable Sheffield manufacturers to replace their present uncertain, cumbrous, and expensive process, by a method at once simple and inexpensive, and so completely under control as to admit of any required degree of conversion being obtained with absolute certainty. Mr. Crace Calvert also has proved that cast iron contains nitrogen, and has shown that it is a definite compound of carbon and iron mixed with various proportions of metallic iron, according to its nature.

Before leaving chemical science, I must refer to the interesting discovery by M. Deville, by which he succeeded in rapidly melting thirty-eight or forty pounds of platinum,—a metal till then considered almost infusible. This discovery will render the extraction of platinum from the ore more perfect, and, by reducing its cost, will greatly facilitate its application to the arts.

It is little more than half a century since Geology assumed the distinctive character of a science. Taking into consideration the aspects of nature in different epochs of the history of the earth, it has been found that the study of the changes at present going on in the world around us enable us to understand the past revolutions of the globe, and the conditions and circumstances under which strata have been formed and organic remains embedded and preserved. The geologist has increasingly tended to believe that the changes which have taken place on the face of the globe, from the earliest times to the present, are the result of agencies still at work. But whilst it is his high office to record the distribution of life in past ages and the evidence of physical changes in the arrangement of land and water, his results hitherto have indicated no traces of its beginning, nor have they afforded evidence of the time of its future duration. Geology has been indebted for this progress very largely to the investigations of Sedgewick and the writings of Sir Charles Lyell.

As an example of the application of Geology to the practical uses of life, I may cite the discovery of the gold fields of Australia, which might long have remained hidden, but for the researches of Sir Roderick Murchison in the Ural Mountains on the geological position of the strata from which the Russian gold is obtained. From this investigation he was led by inductive reasoning to believe that gold would be found in similar rocks, specimens of which had been sent him from Australia. The last years of the active life of this distinguished geologist have been devoted

to the re-examination of the rocks of his native Highlands of Scotland.

Applying to them those principles of classification which he long since established, he has demonstrated that the crystalline limestone and quartz rocks which are associated with mica schists, &c., belong by their embedded organic remains to the Lower Silurian Rocks. Descending from this well-marked horizon, he shows the existence beneath all such fossiliferous strata of vast masses of sandstone and conglomerate of Cambrian age; and, lastly, he has proved the existence of a fundamental Gneiss, on which all the other rocks repose, and which, occupying the North-Western Hebrides, and the west coast of Sutherland and Ross, is the oldest rock formation in the British Isles, it being unknown in England, Wales, or Ireland.

It is well known that the temperature increases, as we descend through the earth's crust, from a certain point near the surface, at which the temperature is constant. In various mines, borings, and Artesian wells, the temperature has been found to increase about 1° Fahrenheit for every 60 or 65 ft. of descent. In some carefully-conducted experiments during the sinking of Duukinfield Deep Mine—one of the deepest pits in this country—it was found that a mean increase of about 1° in 71 ft. occurred. If we take the ratio thus indicated, and assume it to extend to much greater depths, we should reach at two and a half miles from the surface strata at the temperature of boiling water; and at depths of about 50 or 60 miles the temperature would be sufficient to melt, under the ordinary pressure of the atmosphere, the hardest rocks. Reasoning from these facts, it would appear that the mass of the globe, at no great depth, must be in a fluid state. But this deduction requires to be modified by other considerations, namely, the influence of pressure on the fusing point, and the relative conductivity of the rocks which form the earth's crust. To solve these questions a series of important experiments were instituted by Mr. Hopkins, in the prosecution of which Dr. Joule and myself took part; and after a long and laborious investigation, it was found that the temperature of fluidity increased about 1° Fahrenheit for every 500 lbs. pressure, in the case of spermaceti, bees' wax, and other similar substances. However, on extending these experiments to less compressible substances, such as tin and barytes, a similar increase was not observed. But this series of experiments has been unavoidably interrupted; nor is the series on the conductivity of rocks entirely finished. Until they have been completed by Mr. Hopkins, we can only make a partial use of them in forming an opinion of the thickness of the earth's crust. Judging, however, alone from the greater conductivity of the igneous rocks, we may calculate that the thickness cannot possibly be less than nearly three times as great as that calculated in the usual suppositions of the conductive power of the terrestrial mass at enormous depths, being no greater than that of the superficial sedimentary beds. Other modes of investigation which Mr. Hopkins has brought to bear on this question, appear to lead to the conclusion that the thickness of the earth's crust is much greater even than that above stated. This would require us to assume that a part of the heat in the crust is due to superficial and external, rather than central causes. This does not bear directly against the doctrine of central heat, but shows that only a part of the increase of temperature observed in mines and deep wells is due to the outward flow of that heat.

Touching those highly-interesting branches of science, Botany and Zoology, it may be considered presumptuous in me to offer any remarks. I have, however, not entirely neglected, in my earlier days, to inform myself of certain portions of natural history, which cannot but be attractive to all who delight in the wonderful beauties of natural objects. How interesting is the organisation of animals and plants; how admirably adapted to their different functions and spheres of life. They want nothing, yet have nothing superfluous. Every organ is adapted perfectly to its functions; and the researches of Owen, Agassiz, Darwin, Hooker, Daubeny, Babington, and Jardine fully illustrate the perfection of the animal and vegetable economy of nature.

Two other important branches of scientific research, Geography and Ethnology, have for some years been united, in this Association, in one section, and that probably the most attractive and popular of them all. We are much indebted to Sir Roderick Murchison, among other members of the Association, for its continued prosperity, and the high position it has attained in public estimation. The spirit of enterprise, courage, and perseverance displayed by our travellers in all parts of the world have been powerfully stimulated and well supported by the Geographical Society; and the prominence and rapid publicity given to discoveries by that body have largely promoted geographical research.

In physical Geography the late Baron von Humboldt has been one of the largest contributors, and we are chiefly indebted to his personal researches and numerous writings for the elevated position it now holds among the sciences. To Humboldt we owe our knowledge of the physical features of Central and Southern America. To Parry, Sir James Ross, and Scoresby, we are indebted for discoveries in the Arctic and Antarctic regions. Geography has also been advanced by the first voyage of Franklin down the Copper Mine River, and along the inhospitable shores of the Northern Seas, as far as Point Turn Again, as also by that ill-fated

expedition in search of a north-west passage; followed by others in search of the unfortunate men who perished in their attempt to reach those ice-bound regions, so often stimulated by the untiring energy of a high-minded woman. In addition to these, the discoveries of Dr. Livingstone in Africa have opened to us a wide field of future enterprise along the banks of the Zambesi and its tributaries. To these we may add the explorations of Captain Burton in the same continent, and those also by Captain Speke and Captain Grant, of a hitherto unknown region, in which it has been suggested that the White Nile has its source, flowing from one of two immense lakes, upwards of three hundred miles long, by one hundred broad, and situated at an elevation of four thousand feet above the sea. To these remarkable discoveries ought to add an honourable mention of the sagacious and perilous explorations of Central and Northern Australia by Mr. McDouall Stuart.

Having glanced, however imperfectly, at some of the most important branches of science which engage the attention of members of this Association, I would now invite attention to the mechanical sciences, with which I am more familiarly acquainted. They may be divided into theoretical Mechanics and Dynamics, comprising the conditions of equilibrium and the laws of motion; and Applied Mechanics, relating to the construction of machines. I have already observed that practice and theory are twin sisters, and must work together to ensure a steady progress in mechanical art. Let us then maintain this union as the best and safest basis of national progress, and, moreover, let us recognise it as one of the distinctive aims of the annual reunions of this Association.

During the last century, the science of Applied Mechanics has made strides which astonish us by their magnitude; but even these, it may reasonably be hoped, are but the promise of future and more wonderful enlargements. I therefore propose to offer a succinct history of these improvements, as an instance of the influence of scientific progress on the well-being of society. I shall take in review the three chief aids which engineering science has afforded to national progress, namely, canals, steam navigation, and railways; each of which has promoted an incalculable extension of the industrial resources of the country.

One hundred years ago, the only means for the conveyance of inland merchandise, were the pack-horses and waggons on the then imperfect highways. It was reserved for Brindley, Smeaton, and others, to introduce a system of canals, which opened up facilities for an interchange of commodities at a cheap rate over almost every part of the country. The impetus given to industrial operations by this new system of conveyance, induced capitalists to embark in trade, in mining, and in the extension of manufactures in almost every district. These improvements continued for a series of years, until the whole country was intersected by canals requisite to meet the demands of a greatly extended industry. But canals, however well adapted for the transport of minerals and merchandise, were less suited for the conveyance of passengers. The speed of the canal boats seldom exceeded from two and a half to three miles an hour, and in addition to this, the projectors of canals sometimes sought to take an unfair advantage of the Act of Parliament, which fixed the tariff at so much per ton per mile, by adopting circuitous routes, under the erroneous impression that mileage was a consideration of great importance in the success of such undertakings. It is in consequence of short-sighted views and imperfect legislation that we inherit the numerous curves and distortions of our canal system.

These defects in construction rendered canals almost useless for the conveyance of passengers, and led to the improvement of the common roads, and the system of stage coaches; so that before the year 1830 the chief public highways of the country had attained a remarkable smoothness and perfection, and the lightness of our carriages and the celerity with which they were driven still excites the admiration of those who remember them. These days of an efficiently worked system, which tasked the power and speed of the horse to the utmost, have now been succeeded by changes more wonderful than any that previously occurred in the history of the human race.

Scarcely had the canal system been fully developed when a new means of propulsion was adopted, namely, steam. I need not recount to you the enterprise, skill, and labour that have been exerted in connection with steam navigation. You have seen its results on every river and every sea; results we owe to the fruitful minds of Miller, Symington, Fulton and Henry Bell, who were the pioneers in the great march of progress.

Viewing the past, with a knowledge of the present and a prospect of the future, it is difficult to estimate sufficiently the benefits that have been conferred by this application of mechanical science to the purposes of navigation. Power, speed, and certainty of action, have been attained on the most gigantic scale. The celerity with which a modern steamer, with a thousand tons of merchandise and some hundreds of human beings on board, cleaves the water and pursues her course, far surpasses the most sanguine expectations of a quarter of a century ago, and indeed almost rivals the speed of the locomotive itself. Previous to 1812 our intercourse with foreign countries and with our colonial possessions depended entirely upon the state of the weather. It was only in favourable seasons that a

passage was open, and we had often to wait days, or even a week, before Dublin could be reached from Holyhead. Now this distance of sixty-three miles is accomplished in all weathers in little more than three hours. The passage to America used to occupy six weeks or two months; now it is accomplished in eight or nine days. The passage round the Cape to India is reduced from nearly half a year to less than a third of that time, whilst that country may be reached by the overland route in less than a month. These are a few of the benefits derived from steam navigation, and as it is yet far from perfect, we may reasonably calculate on still greater advantages in our intercourse with distant nations.

I will not here enter upon the subject of the numerous improvements which have so rapidly advanced the progress of this important service.

Suffice it to observe that the paddle-wheel system of propulsion has maintained its superiority over every other method yet adopted for the attainment of speed, as by it the best results are obtained with the least expenditure of power. In ships of war the screw is indispensable, on account of the security it affords to the engines and machinery, from their position in the hold below the water line, and because of the facility it offers in the use of sails, when the screw is raised from its position in the well to a recess in the stern prepared for that purpose. It is also preferable in ships which require auxiliary power in calms and adverse winds, so as to expedite the voyage, and effect a considerable saving upon the freight.

The public mind had scarcely recovered itself from the changes which steam navigation had caused, and the impulse it had given to commerce, when a new and even more gigantic power of locomotion was inaugurated. Less than a quarter of a century had elapsed since the first steam-boats floated on the waters of the Hudson and the Clyde, when the achievements thence resulting were followed by the application of the same agency to the almost superhuman flight of the locomotive and its attendant train. I well remember the competition at Rainhill in 1825, and the incredulity everywhere evinced at the proposal to run locomotives at twenty miles an hour. Neither George Stephenson himself, nor any one else, had at that time the most distant idea of the capabilities of the railway system. On the contrary, it was generally considered impossible to exceed ten or twelve miles an hour; and our present high velocities, due to high-pressure steam and the tubular system of boilers, have surpassed the most sanguine expectations of engineers. The sagacity of George Stephenson at once seized upon the suggestion of Henry Booth, to employ tubular boilers; and that, united to the blast pipe, previously known, has been the means of effecting all the wonders we now witness in a system that has done more for the development of practical science and civilisation of man, than any discovery since the days of Adam.

From a consideration of the changes which have been effected in the means for the interchange of commodities, I pass on to examine the progress which has been made in their production. And as the steam engine has been the basis of all our modern manufacturing industry, I shall glance at the steps by which it has been perfected.

Passing over the somewhat mythical fame of the Marquis of Worcester, and the labours of Savery, Beighton, and Newcomen, we come at once to discuss the state of mechanical art at the time when James Watt brought his gigantic powers to the improvement of the steam engine. At that time the tools were of the rudest construction, nearly everything being done by hand, and, in consequence, wood was much more extensively employed than iron. Under these circumstances Watt invented separate condensation, rendered the engine double-acting, and converted its rectilinear motion into a circular one suitable for the purposes of manufacture. But the discovery at first made little way, the public did not understand it, and a series of years elapsed before the difficulties, commercial and mechanical, which opposed its application, could be overcome. When the certainty of success had been demonstrated, Watt was harassed by infringements of his patent, and lawsuits for the maintenance of his rights. Inventors, and pretended inventors, set up claims, and entered into combination with manufacturers, miners, and others, to destroy the patent and deprive him of the just fruits of his labour and genius. Such is the selfish heartlessness of mankind in dealing with discoveries not their own, but from which they expect to derive benefit.

The steam engine, since it was introduced by Watt, has changed our habits in almost every condition of life. Things which were luxuries have become necessities, and it has given to the poor man, in all countries in which it exists, a degree of comfort and independence, and a participation in intellectual culture unknown before its introduction. It has increased our manufactures tenfold, and has lessened the barriers which time and space interpose. It ploughs the land, and winnows and grinds the corn. It spins and weaves our textile fabrics. In mining, it pumps, winds, and crushes the ores. It performs these things with powers so great and so energetic as to astonish us at their immensity, whilst they are at the same time perfectly docile, and completely under human control.

In war it furnishes the means of aggression, as in peace it affords the bond of conciliation; and, in fact, places within reach a power which, properly applied, produces harmony and good will among men, and leads to the happiest results in every condition of human existence. We may,

therefore, well be proud of the honour conferred on this country as the cradle of its origin, and as having fostered its development from its earliest applications to its present high state of perfection.

I cannot conclude this notice of the steam engine without observing the changes it is destined to effect in the cultivation of the soil. It is but a short time since it was thought inapplicable to agricultural purposes, from its great weight and expense. But more recent experience has proved this to be a mistake, and already in most districts we find that it has been pressed into the service of the farm. The small locomotive, mounted on a frame with four wheels, travels from village to village with its attendant, the thrashing machine, performing the operations of thrashing, winnowing, and cleaning, at less than one half the cost by the old and tedious process of hand labour. Its application to ploughing and tillage on a large scale is, in my opinion, still in its infancy, and I doubt not that many members of this association will live to see the steam plough in operation over the whole length and breadth of the land. Much has to be done before this important change can be successfully accomplished; but, with the aid of the agriculturist preparing the land so as to meet the requirements of steam machinery, we may reasonably look forward to a new era in the cultivation of the soil.

The extraordinary developments of practical science in our system of textile manufacture are, however, not entirely due to the steam engine, although they are now in a great measure dependent on it. The machinery of these manufactures had its origin before the steam engine had been applied, except for mining purposes; and the inventions of Arkwright, Hargreaves, and Crompton, were not conceived under the impression that steam would be their moving power. On the contrary, they depended upon water; and the cotton machinery of this district had attained considerable perfection before steam came to the aid of the manufacturer, and ultimately enabled him to increase the production of its present enormous extent.

I shall not attempt a description of the machinery of the textile manufactures, because ocular inspection will be far more acceptable. I can only refer you to a list of establishments in which you may examine their operations on a large scale, and which I earnestly recommend to your attention. I may, however, advert to a few of the improvements which have marked the progress of the manufacturing system in this country.

When Arkwright patented his water frames in 1767, the annual consumption of cotton was about four million pounds weight. Now it is one thousand two hundred million pounds weight,—three hundred times as much. Within half a century the number of spindles at work, spinning cotton alone, has increased ten-fold; whilst by superior mechanism, each spindle produces fifty per cent. more yarn than on the old system. Hence the importance to which the cotton trade has risen, equalling at the present time the whole revenue of the three kingdoms, or £70,000,000 sterling per annum. As late as 1820 the power loom was not in existence, now it produces about fourteen million yards of cloth, or, in more familiar terms, nearly eight thousand miles of cloth per diem. I give these particulars to show the immense power of production of this country, and to afford some conception of the number and quality of the machines which effect such wonderful results.

Mule spinning was introduced by Crompton, in 1787, with about twenty spindles to each machine. The powers of the machine were, however, rapidly increased; and now it has been so perfected that two thousand, or even three thousand spindles are directed by a single person. At first the winding on, or forming the shape of the cop, was performed by hand; but this has been superseded by rendering the machine automatic, so that it now performs the whole operation of drawing, stretching, and twisting the thread, and winding it on to the exact form, ready for the reel or shuttle as may be required. These, and other improvements in carding, roving, combing, spinning and weaving, have established in this country an entirely new system of industry; it has given employment to greatly increased numbers, and a more intelligent class of work-people.

Similarly important improvements have been applied to the machinery employed in the manufacture of silk, flax, and wool: and we have only to watch the processes in these different departments to be convinced that they owe much to the development of the cotton manufacture. In the manufacture of worsted, the spinning Jenny was not employed at Bradford until 1790, nor the power loom until 1825. The production of fancy or mixed goods from Alpaca and Mohair wool, introduced to this country in 1836, is perhaps the most striking example of a new creation in the art of manufacture, and is chiefly due to Mr. Titus Salt, in whose immense palace of industry, at Saltaire, it may be seen in the greatest perfection. In flax machinery, the late Sir Peter Fairbairn was one of the most successful inventors, and his improvements have contributed to the rapid extension of this manufacture.

I might greatly extend this description of our manufacturing industry, but I must for the present be brief, in order to point out the dependance of all these improvements on the iron and coal so widely distributed amongst the mineral treasures of our island. We are highly favoured in

the abundance of these minerals, deposited with an unsparing hand by the great Author of Nature, under so slight a covering as to bring them within reach of the miner's art. To them we owe our present high state of perfection in the useful arts; and to their extended application we may safely attribute our national progress and wealth. So that, looking to the many blessings which we daily and hourly receive from those sources alone, we are impressed with devotional feelings of gratitude to the Almighty for the manifold bounties He has bestowed upon us.

Previously to the inventions of Henry Cort, the manufacture of wrought iron was of the most crude and primitive description. A hearth and a pair of bellows was all that was employed. But since the introduction of puddling, the iron-masters have increased the production to an extraordinary extent, down to the present time, when processes for the direct conversion of wrought iron on a large scale are being attempted. A consecutive series of chemical researches into the different processes, from the calcining of the ore to the production of the bar, carried on by Dr. Percy and others, has led to a revolution in the manufacture of iron; and although it is at the present moment in a state of transition, it nevertheless requires no very great discernment to perceive that steel and iron of any required tenacity will be made in the same furnace, with a facility and certainty never before attained. This has been effected, to some extent, by improvements in puddling; but the process of Mr. Bessemer,—first made known at the meetings of this Association at Cheltenham,—affords the highest promise of certainty and perfection in the operation of converting the melted pig direct into steel or iron, and is likely to lead to the most important developments in this manufacture. These improvements in the production of the material must, in their turn, stimulate its application on a larger scale and lead to new constructions.

In iron shipbuilding, an immense field is opening before us. Our wooden walls have, to all appearance, seen their last days; and as one of the early pioneers in iron construction, as applied to shipbuilding, I am highly gratified to witness a change of opinion that augurs well for the security of the liberties of the country. From the commencement of iron shipbuilding in 1830 to the present time, there could be only one opinion amongst those best acquainted with the subject, namely, that iron must eventually supersede timber in every form of naval construction. The large ocean steamers, the *Himalaya*, the *Persia* and the *Great Eastern*, abundantly show what can be done with iron, and we have only to look at the new system of casing ships with armour plates, to be convinced that we can no longer build wooden vessels of war with safety to our naval superiority and the best interests of the country. I give no opinion as to the details of the reconstruction of the navy,—that is reserved for another place,—but I may state that I am fully persuaded that the whole of our ships of war must be rebuilt of iron, and defended with iron armour calculated to resist projectiles of the heaviest description at high velocities.

In the early stages of iron shipbuilding, I believe I was the first to show, by a long series of experiments, the superiority of wrought iron over every other description of material in security and strength, when judiciously applied in the construction of ships of every class. Other considerations, however, affect the question of vessels of war; and although numerous experiments were made, yet none of the targets were on a scale sufficient to resist more than a six-pounder shot. It was reserved for our scientific neighbours, the French, to introduce thick iron plates as a defensive armour for ships. The success which has attended the adoption of this new system of defence affords the prospect of invulnerable ships of war, and hence the desire of the Government to remodel the navy on an entirely new principle of construction, in order that we may retain its superiority as the great bulwarks of the nation. A committee has been appointed by the War Office and the Admiralty for the purpose of carrying out a scientific investigation of the subject, so as to determine,—first, the best description of material to resist projectiles; secondly, the best method of fastening and applying that material to the sides of ships and land fortifications; and, lastly, the thickness necessary to resist the different descriptions of ordnance.

It is asserted, probably with truth, that whatever thickness of plates are adopted for casing ships, guns will be constructed capable of destroying them. But their destruction will even then be a work of time, and I believe, from what I have seen in recent experiments, that with proper armour, it will require, not only the most powerful ordnance, but also a great concentration of fire, before fracture will ensue. If this be the case, a well-constructed iron ship, covered with sound plates of the proper thickness, firmly attached to its sides, will, for a considerable time, resist the heaviest guns which can be brought to bear against it, and be practically shot-proof. But our present means are inadequate for the production of large masses of iron, and we may trust that, with new tools and machinery, and the skill, energy, and perseverance of our manufacturers every difficulty will be overcome, and armour plates produced which will resist the heaviest existing ordnance.

The rifling of heavy ordnance, the introduction of wrought iron, and the new principle of construction with strained hoops, have given to all

countries the means of increasing enormously the destructive power of their ordnance. One of the results of this introduction of wrought iron, and correct principles of manufacture, is the reduction of the weight of the new guns to about two-thirds the weight of the older cast-iron ordnance. Hence follows the facility with which guns of much greater power can be worked, whilst the range and precision of fire are at the same time increased. But these improvements cannot be confined to ourselves. Other nations are increasing the power and range of their artillery in a similar degree, and the energies of the nation must, therefore, be directed to maintain the superiority of our navy in armour as well as in armament.

We have already seen a new era in the history of the construction of bridges, resulting from the use of iron; and we have only to examine those of the tubular form over the Conway and Menai Straits to be convinced of the durability, strength, and lightness of tubular constructions applied to the support of railways or common roads, in spans which, ten years ago, were considered beyond the reach of human skill. When it is considered that stone bridges do not exceed 150ft. in span, nor cast-iron bridges 250ft., we can estimate the progress which has been made in crossing rivers 400ft. or 500ft. in width, without any support at the middle of the stream. Even spans, greatly in excess of this, may be bridged over with safety, provided we do not exceed 1800ft. or 2000ft. when the structure would be destroyed by its own weight.

It is to the exactitude and accuracy of our machine tools that our machinery of the present time owes its smoothness of motion and certainty of action. When I first entered this city, the whole of the machinery was executed by hand. There were neither planing, slotting, nor shaping machines, and with the exception of very imperfect lathes and a few drills, the preparatory operations of construction were effected entirely by the hands of the workmen. Now everything is done by machine tools, with a degree of accuracy which the unaided hand could never accomplish. The automaton, or self-acting machine tool, has within itself an almost creative power; in fact, so great are its powers of adaptation, that there is no operation of the human hand that it does not imitate. For many of these improvements the country is indebted to the genius of our townsmen, Mr. Richard Roberts and Mr. Joseph Whitworth. The importance of these constructive machines is, moreover, strikingly exemplified in the government works at Woolwich and Enfield Lock, chiefly arranged under the direction of Mr. Auderson, the present inspector of machinery, to whose skill and ingenuity the country is greatly indebted for the efficient state of those great arsenals.

Amongst the changes which have lately contributed to the comfort and enjoyment of life, are the improvements in the sanitary condition of towns. These belong, probably to the province of social, rather than mechanical science; but I cannot omit to notice some of the great works that have of late years been constructed for the supply of water, and for the drainage of towns. In former days, ten gallons of water to each person per day was considered an ample allowance. Now thirty gallons is much nearer the rate of consumption. I may instance the water-works of this city and of Liverpool, each of which yield a supply of from twenty to thirty gallons of water to each inhabitant. In the former case, the water is collected from the Cheshire and Derbyshire hills, and, after being conveyed in tunnels and aqueducts a distance of ten miles, to a reservoir, where it is strained and purified, it is ultimately taken a further distance of eight miles in pipes, in a perfectly pure state, ready for distribution. The greatest undertaking of this kind, however, yet accomplished, is that by which the pure waters of Loch Katrine are distributed to the city of Glasgow. This work, recently completed by Mr. Bateman, who was also the constructor of the water-works of this city, is of the most gigantic character, the water being conveyed in a covered tunnel a distance of 27 miles, through an almost impassable country, to the service reservoir, about 8 miles from Glasgow. By this means forty million gallons of water per day are conveyed through the hills which flank Ben Lomond, and after traversing the sides of Loch Chon and Loch Aird, are finally discharged into the Mugdock basin, where the water is impounded for distribution. We may reasonably look forward to an extension of similar benefits to the metropolis, by the same engineer, whose energies are now directed to an examination of the pure fountains of Wales, from whence the future supply of water to the great city is likely to be derived. A work of so gigantic a character may be looked upon as problematical, but when it is known that six or seven millions of money would be sufficient for its execution, I can see no reason why an undertaking of so much consequence to the health of London should not ultimately be accomplished.

In leaving this subject, I cannot refrain from an expression of deep regret at the loss which science has sustained through the death of one of our Vice-Presidents, the late Professor Hodgkinson. For a long series of years he and I worked together in the same field of scientific research, and our labours are recorded in the Transactions of this and other Associations. To Mr. Hodgkinson we owe the determination of the true form of cast iron beams, or section of greatest strength; the law of the elasticity of iron under tensile and compressive forces; and the laws of resistance of

columns to compression. I look back to the days of our joint labour with unalloyed pleasure and satisfaction.

I regret to say that another of our Vice-Presidents, my friend Mr. Joseph Whitworth, is unable to be present with us through serious, but I hope not dangerous, illness. To Mr. Whitworth, mechanical science is indebted for some of the most accurate and delicate pieces of mechanism ever executed; and the exactitude he has introduced into every mechanical operation will long continue to be the admiration of posterity. His system of screw threads and gauges is now in general use throughout Europe. We owe to him a machine for measuring with accuracy to the millionth of an inch, employed in the production of standard gauges; and his laborious and interesting experiments on rifled ordnance have resulted in the production of a rifled small arm and gun which have never been surpassed for range and precision of fire. It is with pain that I have to refer to the cause which deprives me of his presence and support at this meeting.

A brief allusion must be made to that marvellous discovery which has given to the present generation the power to turn the spark of heaven to the uses of speech; transmit along the slender wire for a thousand miles a current of electricity that renders intelligible words and thoughts. This wonderful discovery, so familiar to us, and so useful in our communications to every part of the globe, we owe to Wheatstone, Thompson, De la Rive, and others. In land telegraphy the chief difficulties have been surmounted, but in submarine telegraphy much remains to be accomplished. Failures have been repeated so often as to call for a Commission on the part of the Government to inquire into the causes, and the best means of overcoming the difficulties which present themselves. I had the honour to serve on that Commission, and I believe that, from the report, and mass of evidence and experimental research accumulated, the public will derive very important information. It is well known that three conditions are essential to success in the construction of ocean telegraphs—perfect insulation, external protection, and appropriate apparatus for laying the cable safely on its ocean bed. That we are far from having succeeded in fulfilling these conditions is evident from the fact that out of 12,000 miles of submarine cable which have been laid since 1851, only 3000 miles are actually in working order; so that three-fourths may be considered as a failure and loss to the country. The insulators hitherto employed are subject to deterioration from mechanical violence, from chemical decomposition or decay, and from the absorption of water; but the last circumstance does not appear to influence seriously the durability of cables. Electrically, india rubber possesses high advantages, and, next to it, Wray's compound and pure gutta purcha far surpass the commercial gutta purcha hitherto employed; but it remains to be seen whether the mechanical and commercial difficulties in the employment of these new materials can be successfully overcome. The external protecting covering is still a subject of anxious consideration. The objections to iron wire are its weight and liability to corrosion. Hemp has been substituted, but at present with no satisfactory result. All these difficulties, together with those connected with the coiling and paying out of the cable, will no doubt yield to careful experiment and the employment of proper instruments in its construction and its final deposit on the bed of the ocean.

Irrespective of inland and international telegraphy, a new system of communication has been introduced by Professor Wheatstone, whereby intercourse can be carried on between private families, public offices, and the works of merchants and manufacturers. This application of electric currents cannot be too highly appreciated, from its great efficiency and comparatively small expense. To show to what an extent this improvement has been carried, I may state that one thousand wires, in a perfect state of insulation, may be formed into a rope not exceeding half-an-inch in diameter.

I must not sit down without directing attention to a subject of deep importance to all classes, namely, the amount of protection inventors should receive from the laws of the country. It is the opinion of many that patent laws are injurious rather than beneficial, and that no legal protection of this kind ought to be granted; in fact, that a free trade in inventions, as in everything else, should be established. I confess I am not of that opinion. Doubtless there are abuses in the working of the patent law as it at present exists, and protection is often granted to pirates and impostors, to the detriment of real inventors. This, however, does not contravene the principle of protection, but rather calls for reform and amendment. It is asserted by those who have done the least to benefit their country by inventions, that a monopoly is injurious, and that if the patent laws are defended, it should be, not on the ground of their benefit to the inventor, but on that of their utility to the nation. I believe this to be a dangerous doctrine, and I hope it will never be acted upon. I cannot see the right of the nation to appropriate the labours of a lifetime, without awarding any remuneration. The nation, in this case, receives a benefit; and assuredly the labourer is worthy of his hire. I am no friend of monopoly, but neither am I a friend of injustice; and I think that before the public are benefitted by an invention, the inventor should be rewarded either by a fourteen years' monopoly, or in some other way. Our patent laws are defective, so far as they protect pretended inventions;

but they are essential to the best interests of the State in stimulating the exertions of a class of eminent men, such as Arkwright, Watt, and Crompton, whose inventions have entailed upon all countries invaluable benefits, and have done honour to the human race. To this Association is committed the task of correcting the abuses of the present system, and establishing such legal provisions as shall deal out equal justice to the inventor and the nation at large.

I must not forget that we owe very much to an entirely new and most attractive method of diffusing knowledge, admirably exemplified in the Great Exhibition of 1851, and its successors in France, Ireland, and America. Most of us remember the gems of art which were accumulated in this city during the summer of 1857, and the wonderful results they produced on all classes of the community. The improvement of taste, and the increase of practical knowledge which followed these exhibitions, has been deeply felt; and hence the prospects which are now opening before us in regard to the Exhibition of the next year cannot be too highly appreciated. That Exhibition will embrace the whole circle of the sciences, and is likely to elevate the general culture of the public to a higher standard than we have ever before attained. There will be unfolded almost every known production of art, every ingenious contrivance in machinery, and the results of discoveries in science from the earliest period. The Fine arts, which constituted no part of the Exhibition of 1851, and which were only partially represented at Paris and Dublin, will be illustrated by new creations from the most distinguished masters of the modern school. Looking forwards, I venture to hope for a great success and a further development of the principle advocated by this Association the union of science and art.

In conclusion, my apologies are due to you for the length of this address, and I thank you sincerely for the patient attention with which you have listened to the remarks I have had the honour to lay before you. As the President of the British Association, I feel that, far beyond the consideration of merely personal qualification, my election was intended as a compliment to practical science, and to this great and influential metropolis of manufacture, where those who cultivate the theory of science may witness, on its grandest scale, its application to the industrial arts. As a citizen of Manchester, I venture to assure the Association that its intentions are appreciated; and to its members, as well as to the strangers who have been attracted here by this meeting, I offer a most cordial welcome.

SECTION G (MECHANICAL SCIENCE).

J. F. BATEMAN, ESQ., C.E., F.R.S., PRESIDENT OF THE SECTION.

THE FOLLOWING PAPERS WERE READ IN THE ABOVE SECTION.

ON THE EFFECTS OF VIBRATORY ACTION AND LONG CONTINUED CHANGES OF LOAD, UPON WROUGHT IRON BRIDGES AND GIRDERS,

BY WILLIAM FAIRBAIRN, ESQ., LL.D., F.R.S.

(Illustrated by Plate 203.)

It is upwards of fifteen years since a series of experiments were made to determine the value of wrought iron rivetted plates in the form of rectangular tubes, when employed as girders spanning rivers and ravines for the support of roads and railways. Those experiments led to the erection of the Conway and Britannia Bridges on the Chester and Holyhead Railway, and determined the form in which such structures should be designed, as also the strength necessary to resist the strain of the passing loads. A new theory of construction was thus developed and a new era established in the history of bridges. Since that time some thousands of bridges, composed entirely of wrought iron plates, have been erected, supporting roads and railways, with a degree of safety not attainable with any other description of material.

The construction of the Britannia and Conway Bridges of the tubular form led to the introduction of tubular girder, plate, and various forms of lattice bridges, all founded on the same principle.

The tubular bridges were originally designed so that their ultimate strength should be six times the greatest rolling load which could be placed upon them after deducting the weight of the tube. This was considered a fair margin of strength, but subsequent considerations have induced in many cases an increase of this margin of resistance to five or six times the maximum rolling load and permanent load taken together.

Owing to the great success in the first examples of wrought iron bridges, a great demand for them arose in every direction, and numbers were made without any regard to principle or the laws of proportion so clearly and satisfactorily developed in the Millwall experiments. The result of this was the erection of many weak bridges so disproportioned as to be at the point of breaking with little more than double their own weight. This, together with the bad system of contractors tendering by weight and the employment in some cases of *bad iron and bad workmanship* have brought discredit upon the margin of strength at first considered sufficient. No construction requires greater care or a more

TABLE I.

Beam loaded to one-fourth of its breaking weight.

Total moving load..... = 5809 lbs.
 Permanent load (or half weight of the beam)..... = 434 lbs.
 Margin of strength by Board of Trade..... = 3.4 to 1.
 Strain on bottom flange = 4.35 tons per sq. inch.

Date.	Number of Changes of Load.	Deflection at centre of beam.	Date.	Number of Changes of load.	Deflection at centre of beam.
1860.			1860.		
March 21.....		0'17	April 13.....	268,328	0'17
" 22.....	10,540	0'18	" 14.....	281,210	0'17
" 23.....	15,610	0'16	" 17.....	321,015	0'17
" 24.....	27,840	...	" 20.....	343,880	0'17
" 26.....	46,100	0'16	" 25.....	390,430	0'17
" 27.....	57,790	0'17	" 27.....	408,264	0'16
" 28.....	72,440	0'17	" 28.....	417,940	0'16
" 29.....	85,960	0'17	May 1.....	449,280	0'16
" 30.....	97,420	0'17	" 3.....	468,600	0'16
" 31.....	112,810	0'17	" 5.....	489,769	0'16
April 2.....	144,350	0'16	" 7.....	512,181	0'16
" 4.....	165,710	0'18	" 9.....	536,355	0'16
" 7.....	202,890	0'17	" 11.....	560,529	0'16
" 10.....	235,811	0'17	" 14.....	596,790	0'16

The beam took at first a permanent set of about 0'01 inch, which did not appear to increase afterwards. The beam was then subjected to experiment with an increased load, equivalent to one-third the breaking weight.

TABLE II.

Load Equivalent to One-third the Breaking Weight

Total moving load..... = 7406 lbs.
 Permanent load = 434 lbs.
 Margin of strength by Capt. Tyler's rule, ... = 2'7 to 1.
 " " by my own rule, ... = 2'9 to 1.
 Strain on bottom flange..... = 5'47 tons per sq. in.

Date.	Number of changes of Load.	Deflection in inches.	Date.	Number of changes of Load.	Deflection in inches.
1860.			1860.		
May 14.....		0'22	June 7.....	217,300	0'21
" 15.....	12,623	0'22	" 9.....	236,460	0'21
" 17.....	36,417	0'22	" 12.....	264,220	0'21
" 19.....	53,770	0'21	" 16.....	292,600	0'22
" 22.....	85,820	0'22	" 21.....	327,000	0'23
" 26.....	128,300	0'22	" 23.....	350,000	0'25
" 29.....	161,500	0'22	" 25.....	375,650	0'23
" 31.....	177,000	0'22	" 26.....	403,210	0'23
June 4.....	194,500	0'21			

The beam had now made a million strokes, partly with a load of one-fourth, and partly with a load of one-third the breaking weight. As it was uninjured, the load was increased to nearly one-half the breaking weight.

TABLE III.

Load equivalent to one-half the breaking weight

Total moving load = 10,050 lbs.
 Permanent load = 434 lbs.
 Margin of strength by Capt. Tyler's rule, = 2'05 to 1.
 " " by my own rule, = 2'09 to 1.
 Strain on bottom flange = 7'32 tons per sq. in.

Date.	Number of changes of Load.	Deflection in inches.	Remarks.
1860.			
June 27.....	0'35	
" 28.....	5175	—	The beam broke.

With a load of one-half the breaking weight the beam gave way after 5175 changes of load. It appears, therefore, that it is not safe to build bridges in which the rolling load would bear this proportion to the breaking weight.

The beam was then taken down and repaired; a patch was rivetted across the fracture in the bottom plate, so that the area of sound plate remained as before. The experiments were then renewed; 158 changes of load were sustained with a load equal to one-half the breaking weight. The load was then reduced to two-fifths the breaking weight, and 25,900 changes of load were sustained. Lastly the load was reduced to one-third of the breaking weight, and the results given in the following table were obtained.

TABLE IV.

Load equivalent to one-third of the Breaking Weight.

Total rolling load..... = 6359 lbs.
 Permanent load = 434 lbs.
 Margin of strength = 3'2 to 1.
 Strain on bottom flange = 4.74 tons per sq. in.

Date.	Number of Changes of Load.	Deflection in inches.	Date.	Number of Changes of Load.	Deflection in inches.
1860.			1860.		
August 13...	25,900	0'18	December 22...	929,470	0'18
" 16...	46,326	0'18	" 29...	1,024,500	0'18
" 20...	71,000	0'18	January 9...	1,121,100	0'18
" 24...	101,760	0'18	" 19...	1,278,000	0'18
" 25...	107,000	0'18	" 26...	1,342,800	0'18
" 31...	135,260	0'18	February 2...	1,426,000	0'18
September 1...	140,500	0'18	" 11...	1,485,000	0'18
" 8...	189,500	0'18	" 16...	1,543,000	0'18
" 15...	242,860	0'18	" 23...	1,602,000	0'18
" 22...	277,000	0'18	March 2...	1,661,000	0'18
" 30...	320,000	0'18	" 9...	1,720,000	0'18
October 6...	375,000	0'18	" 16...	1,779,000	0'17
" 13...	429,000	0'18	" 23...	1,829,000	0'17
" 20...	484,000	0'18	" 30...	1,885,000	0'17
" 27...	538,000	0'18	April 6...	1,945,000	0'17
November 3...	577,800	0'18	" 13...	2,000,000	0'17
" 10...	617,800	0'18	" 20...	2,059,000	0'17
" 17...	657,500	0'18	" 27...	2,110,000	0'17
" 23...	712,300	0'18	May 4...	2,165,000	0'17
December 1...	768,100	0'18	" 11...	2,250,000	0'17
" 8...	821,970	0'18	June ...	2,727,754	0'17
" 15...	875,000	0'18			

The following table gives a summary of the results obtained in this series of experiments.

TABLE V.

Summary of Results.

Experimental Table.	Load at Centre.		Ratio of Load to breaking Weight.	Tensile strain on Bottom.	Strain on Bottom after deducting Rivets.	Changes of Load.	Deflection.	
	Changing.	Weight of Beam or permanent Load						
I.	lbs. 5809	lbs. 434	3'4 : 1	tons. 4'35	tons. 5'91	596,790	0'17	Uninjured.
II.	7406	434	2'7 : 1	5'47	7'43	403,210	0'23	Uninjured.
III.	10050	434	2'05 : 1	7'32	9'92	5,175	0'35	Broke.
IV.	6359	434	3'2 : 1	4'74	6'42	2,727,754	0'17	Uninjured.

In using the numbers giving the strain in tons per square inch of the gross sectional area of the bottom, it must be remembered that a larger proportion is punched out for the rivet holes in this small beam than in bridges. Taking the next column, which gives the strain on the metal of the bottom after deducting the rivet holes, we find that the beam suffers no deterioration with strains of nearly 7½ tons per square inch. With 10 tons per square inch the beam broke, after 5172 changes of load. Now as the limit of elasticity is reached at about 9 tons per square inch in ordinary boiler plates and bridge plates, it would appear that it is unsafe to load structures subject to a continually varying load beyond that point. Within these limits, however, we have no evidence that a deterioration of the structure takes place.

The results given here apply chiefly to cases where nearly the whole load of the beam is a changing load, the weight of the beam itself being insignificant. It remains to be considered, in the case of large bridges, where the chief part of the load is permanent and stationary, and the lesser portion only changes, whether even greater strains than these would not be suffered with impunity. On this subject we have no experiments which apply to wrought iron, but in the case of cast iron, some results have been obtained which have an important bearing on the question.

In the first place, I have shown that where the whole load is permanent and stationary, cast iron bars, load with three-fourths of the breaking weight, suffer very slight deterioration in the course of time; thus in the experiments recorded in the "Report on the Effect of Time on Loaded Cast Iron Bars," published in the transactions of this Association, it was shown that the increase of deflection

of bars loaded with three-fourths of their breaking weight, amounted in the course of five years to 0'004in. in the case of cold blast iron, and to 0'009 in the hot blast iron. That is that there was a mean increase in five years of $\frac{3}{1000}$ of the whole deflection of the bar. With a cold blast bar loaded with above $\frac{5}{10}$ of the breaking weight, the increase in four years was $\frac{5}{1000}$ of an inch, or not more than $\frac{1}{135}$ of the whole deflection. These experiments would seem to show that, with a stationary load, materials may be loaded with impunity within the limit of elasticity, or nearly up to a force calculated to produce fracture.

Secondly, in the case where part of the load changes and part is permanent, some experiments were made by the Commission on iron structures, which gave the following remarkable result. That additional loads spread uniformly over a beam increased its power of resisting impacts. They found that beams of cast iron, loaded to a certain degree with weights spread over their whole length, and so attached as not to prevent the flexure of the bar, resisted greater impacts from the same body falling on them than when the beams were unloaded in the ratio of two to one. There is great difficulty in applying such results as these to the case of bridges of wrought iron, but at least they may serve to indicate the direction which should be taken in further experimental inquiries on this very interesting and important subject.

On some future occasion I may have again to refer to this subject. For the present, I would advise that in all beams and girders, tubular or plain, the permanent load, or weight of the girder and its platform, should not in any case exceed one-fourth of the breaking weight. And that the remaining three-fourths should be reserved to resist the rolling load in the proportion of six to one.

As a general rule, these ratios of strength would apply to all bridges, but the strains would be least on the smallest bridges, which, in my opinion, is requisite on account of the frequency of neglect of smaller structures.

I would earnestly direct the most careful attention to the laws which govern the resisting powers of girders exposed to transverse strains; to the best principle of uniting the joints and, above all, to the selection of the best material which, in the parts of girders subject to a tensile strain, ought always to sustain a test of from 22 to 24 tons per square inch. There is no economy in the use of inferior iron for this purpose, and its employment inevitably leads to a loss of character in the structure and danger to the public.

ON IRON CONSTRUCTION; WITH REMARKS ON THE STRENGTH OF IRON COLUMNS AND ARCHES.

BY FRANCIS W. SHEILDS, M. Inst. C.E.

1. It is almost needless to expatiate on the great and rapid development which the use of ironwork has received within a few years preceding the present meeting. In bridge-work, the ancient structures of masonry—in roofing, the employment of wooden framing, and in ship-building, the use of timber, both in the naval and mercantile marine—are being rapidly superseded by a material eminently possessed of the qualities of strength, durability, and cheapness, for engineering construction.

2. Nor is this change confined to England alone; the employment of British iron for such purposes has now become well-nigh universal. In fact, it appears almost anomalous, that iron for a bridge or other construction, manufactured in this country and conveyed abroad at considerable cost, should supersede, with considerable economy, in Australia, India, Russia, or Spain, the materials of the country, and found in abundance in most localities therein, and this when iron is more costly in itself than the materials of wood and stone which it supersedes.

3. Such apparent contradiction is explained by two causes. 1st. That iron possesses, size for size, much greater strength than any other substance in general use. And 2nd. That it possesses eminently the capacity of being manufactured in such variable shapes and sizes as the nature of the case may require; so that sufficient material may be supplied in each part of the structure to meet the stress or strain upon that part, without any being wasted or lost to use.

4. Under these circumstances, an iron construction of many parts, accurately proportioned for its purpose, should, when loaded, have every part strained to the just extent of its resisting power. If some of its parts be increased in scantling beyond this proportion such increase will add nothing to the strength of the structure as a whole, which is limited by the strength of its weakest part; and it will only involve the addition of useless weight and expense in the construction.

5. Nor is economy the only consideration which urges the necessity for progress in this respect. In a framing where the strains are transmitted from one portion to another throughout the structure, the insufficiency of one part may easily compromise the stability of the whole; and the element of safety enters largely into the consideration of the question in this view.

6. It follows, therefore, that the designer of iron structures should possess not only the workman's practical knowledge of the material with which he has to deal, but should be peculiarly acquainted with the scientific and mechanical principles by which the strains on each part are found, so as to enable him to apportion correctly the scantlings for those parts. And the practical men, also, dealing with ironwork should have a thorough knowledge of the mode of calculating the strains upon the usual constructions to which iron is applied.

7. It will not be attempted in this paper to give an abstract of the scientific principles in question, which the author of these remarks has lately ventured to lay briefly before the public, in reference to framed and other structures of comparatively complicated character, with strains varying both in nature and in amount. In respect to the more simple cases of cast iron columns, the experiments made and the principles laid down by Fairbairn and Hodgkinson may be safely referred to; but it is believed that practice in actual construction on a large scale will not be the least best guide. The conclusions to which experience

has led him as to the practical amount of loading which may be laid upon iron columns and arches, the results of which he has not previously made public.

The professional engagements of the writer on the construction of the Crystal Palace, at Sydenham, and other works, have given him much opportunity of ascertaining the amount of load which cast iron columns will sustain with safety. In his practice, accordingly, the following rules are adopted as the basis of calculation of their strength; the columns being supposed of good construction, with flat ends, and with base-plates at their bearings.

IRON COLUMNS.

For hollow columns of 20 to 24 diameters in length.

	Columns may be loaded with
If cast $\frac{3}{4}$ inch thick or upwards	2 tons per square sectional area of iron.
" $\frac{1}{2}$ " " " " " " " " " "	1 $\frac{3}{4}$ " " " " " "
" $\frac{1}{2}$ " " " " " " " " " "	1 $\frac{1}{2}$ " " " " " "
" $\frac{3}{8}$ " " " " " " " " " "	1 $\frac{1}{4}$ " " " " " "
For columns of 25 to 30 diameters in length.	

	Tons.
If cast $\frac{3}{4}$ inch thick or upwards	1 $\frac{3}{4}$ per inch.
" $\frac{1}{2}$ " " " " " " " " " "	1 $\frac{1}{2}$ " " " " " "
" $\frac{1}{2}$ " " " " " " " " " "	1 $\frac{1}{4}$ " " " " " "
" $\frac{3}{8}$ " " " " " " " " " "	1 " " " " " "

The cause of the modifications of loading from varying thicknesses, is that thin and light columns are more liable to fracture from inequalities of casting and from accident, and should, therefore, be less loaded in proportion than those of greater thickness.

IRON ARCHES.

In the apportionment of iron to meet the strain or thrust of an arch, it is usual amongst engineers to allow about 2 $\frac{1}{2}$ tons of thrust or pressure to each sectional inch of cast iron, and 4 tons of pressure to each sectional inch of wrought iron.

Independently of the compression of the arch, it is doubtless advisable in very flat arches, to consider the flat central portion as a girder, and to give to its top and bottom such flanges as a simple beam of its length and depth would require. Thus, in a segmental arch of wrought iron, struck with a radius of 300 feet, which the writer had recently to design, the central portion of 70 feet was considered as an independent girder, and treated in this manner.

ABSTRACT OF AN INVESTIGATION OF THE RESISTANCE OF SHIPS.

By W. J. MACQUORN RANKINE, C.E., L.L.D., F.R.S.S., London & Edinburgh.

This paper is a very brief extract of the results of an investigation of the laws of the resistance of ships, founded originally on experimental data supplied to the author by Mr. James R. Napier, in 1857, and first applied to practice in order to fix beforehand the engine-power required for a ship in 1858. To state all the mathematical details of the investigation would occupy much more time than can reasonably be allotted to one paper at a meeting of the British Association; the present communication, therefore, will be limited to a general view of the nature of the theory adopted, a statement of the practical rules to which it leads for computing the power required to propel a given ship at a given speed, an abstract of some comparisons between the results of that rule and those of experiment, a statement of some limitations to the application of the theory, and some general conclusions deduced from it.

I. GENERAL VIEW OF THE THEORY.

The importance of friction as one of the elements of the resistance of water to the motion of a ship has long been recognised. Colonel Beaufay made many experiments on models, expressly to ascertain its amount. Mr. Hawksley, some years ago, proposed a formula for the resistance of vessels, consisting of three terms, of which two, representing the effect of pressure on the bow and stern, depend on the area of midship section, and the figures of the bow and stern, while the third, representing the effect of friction, is proportional to the wetted surface of the ship. Mr. Bourne, in his work on the screw propeller, mentions friction as an element of the resistance of ships, which must depend on the girth rather than on the midship section.

It is to be remarked, however, that in all previous investigations as to the friction of ships in moving through the water, the velocity of the sliding motion of the particles of water over the ship's bottom has been treated as being sensibly equal to the forward velocity of the ship, and sensibly the same at every point of the ship's bottom; whereas, in fact, it must be different at different points of the ship's bottom, at some points less than the ship's speed, at other points greater; and on an average greater than the ship's speed, in a proportion which is greater, the more bluff the figure of the ship. No definite results are to be expected from any comparison of experiment with a theory which does not take account of those variations.

It is further to be remarked that the excess of the pressure of the water against the bow of a ship above its pressure against the stern is only an indirect effect of friction; for were it not for the loss of motive energy which takes place through friction, the particles of water would close behind the vessel with such speed as to exert a forward pressure exactly equal to the backward pressure of the particles of water which are forced aside at the bow.

The author was induced by these considerations to investigate the theory of the friction of the water against the bottom of a ship, taking into account the

various velocities of sliding at various points, as affected by the positions of those points and by the figure of the ship; and making only the following assumption: that the agitation in the water caused by the friction on the ship's bottom extends only to a layer of water which is very thin as compared with the dimensions of the ship. This assumption enables the ratio which the velocity of sliding at any point bears to the speed of the ship to be expressed as a mathematical function of the position of the point, and of the ship's figure, by the aid of the general equations of fluid motion; and from that function is deduced a certain integral which expresses the work performed in overcoming friction over the whole wetted surface of the ship, while the ship advances through a given distance, such as one foot; and to that quantity of work the force required to drive the ship against the friction of the water is proportional. The mathematical investigation is tedious and voluminous, and is reserved for a detailed paper.

The exact expressions arrived at were very complex, but were easily reduced to more simple expressions, giving an approximation sufficient for the purpose in view.

Upon comparing the formula thus obtained with the indicated power of actual ships moving at known speeds, it was found that the whole power required to propel the ships could be accounted for by friction alone, leaving none to be accounted for by any excess of pressure at the bow above that at the stern, except such excess as is indirectly caused by the friction, and virtually comprehended in the expression for the power required to overcome friction.

II. PRACTICAL RULE FOR THE POWER REQUIRED TO PROPEL A SHIP, WITH TROCHOIDAL OR NEARLY TROCHOIDAL WATER-LINES, *i. e.* WAVE LINES.

The first rule obtained in a form sufficiently simple for practical use, was the following:—

"The resistance of a sharp-ended ship exceeds the resistance of a current of water of the same velocity in a channel of the same length and mean girth, by a quantity proportional to the square of the greatest breadth, divided by the square of the length of the bow and stern."

The mean girth is found by taking the mean of the girths, as measured on the "body-plan" of the vessel, of the immersed parts of a series of equidistant frames or cross-section.

The algebraical expression of this rule is as follows:—

$$R = \frac{f w v^2}{2g} \cdot L G \left(1 + \frac{\pi^2 B^2}{L_1^2} \right) \dots \dots (1)$$

in which

- R denotes the resistance of a vessel.
- L her total length at the water-line, in feet.
- L₁ the length of her bow and stern together, in feet.
- B her greatest breadth, in feet.
- G her mean girth under water.
- π² = 9.87.
- v the ship's speed, in feet per second.
- g the acceleration produced by gravity in a second, or 32.2ft.
- w the weight of a cubic foot of salt water, or about 64 lbs.
- f a co-efficient of friction, whose value for iron ships in a clean state, as on their trial trips, is about .0036, or nearly the same with the co-efficient of friction of water at high speeds in cast-iron pipes.

The expression for the indicated horse-power of the engine, deduced from the preceding formula, is as follows:—

$$I. H. P. = \frac{k R v}{550} = \frac{k f w v^3}{550 \times 2g} \cdot L G \left(1 + \frac{\pi^2 B^2}{L_1^2} \right) \dots \dots (2)$$

In which *k* is a co-efficient expressing the ratio of the gross indicated power to the effective power, allowing for the friction of the machinery and slip of the propeller. Its average value is about 1.6; so that *k f* = about .00576 on an average for ships in a clean state.

But the most convenient formula for practice is one in which the velocity, *V*, is given in nautical miles per hour, and is as follows:—

$$I. H. P. = \frac{V^3}{C} \cdot L G \left(1 + \frac{\pi^2 B^2}{L_1^2} \right) \dots \dots (3)$$

C being a divisor, whose value is—

$$C = \frac{550 \times 2g}{4.8064 \times k f w} = \frac{115}{k f} \text{ nearly } \dots \dots (4)$$

or if *k f* = .00576, *C* = 2000 nearly.

This rule, with a co-efficient of resistance deduced from some experiments on previously existing vessels, was applied in 1858 to the computation of the engine-power required to propel a vessel then in course of construction (the *Admiral*); and at the trial trip of that vessel on the 11th of June 1858 (the particulars of which, together with a copy of her body-plan, have been communicated to the Committee of the British Association on Steam-ship Performance)* the actual

* See Report of that Committee to the Aberdeen Meeting of that Association, 1859. engine-power was found to differ from the theoretically computed engine-power by less than one-fiftieth part of its amount, the computed power being 758, and the actual power 744, and that notwithstanding that the *Admiral* differed materially in her proportions from the vessels from whose performance the co-efficient of resistance had been deduced. The rule was afterwards applied with equal success to fix the required engine-power of other vessels built by Mr. J. R. Napier.

III.—MORE COMPREHENSIVE RULE FOR THE POWER REQUIRED TO PROPEL A SHIP.

The rule in the form already given was deduced from a mathematical investigation based upon a trochoidal (or wave line) form of water-lines, and, therefore, although it could be applied with approximate accuracy to vessels approaching to that type, some doubt and difficulty arose in applying it to those which deviated widely from the trochoidal form. To obviate that difficulty, the rule was put into another form, which, while it was identical in its results with the original form for trochoidal water-lines, was more readily applicable to water-lines of other shapes. The alteration consists in this:—that instead of "a quantity proportional to the square of the greatest breadth divided by the square of the length of the bow and stern, there is to be substituted, a quantity proportional to the square of the chord of the mean angle of entrance of the water-lines," it being understood that the angle of entrance of a given water-line is the angle between its two tangents at opposite sides of the bow, at the points where it is most inclined to the keel; and that the mean value of that angle is to be taken for a series of equidistant water-lines or horizontal sections of the vessel.

The algebraical expression for the resistance now takes the following form:—

$$R = \frac{f w v^2}{2g} \cdot L G \left(1 + 4 \sin^2 \frac{\theta}{2} \right) \dots \dots (5)$$

in which the symbols are the same with those already explained, except *θ*, which denotes the mean angle of entrance as already defined. In what follows, for brevity's sake, the quantity $4 \sin^2 \frac{\theta}{2}$ is denoted by *b*².

The two expressions for the engine-power becomes respectively

$$I. H. P. = \frac{k f w v^3}{550 \times 2g} \cdot L G (1 + b^2) \dots \dots (6)$$

$$= \frac{V^3 L G (1 + b^2)}{C} \dots \dots (7)$$

The processes involved in this rule may be represented to the mind as follows:—

- 1.—Multiply together the length (*L*) of the vessel at the surface of the water, and the mean girth (*G*) of the immersed parts of the cross sections or frames; this gives the area of the internal surface of a channel or tube of the same length and mean girth with the vessel (*LG*).
- 2.—Increase that area in the ratio of unity, plus the square of the chord of the mean angle of entrance ($1 + b^2$) to unity; this increase is an approximate value of the allowance indicated by theory for the obliquity of the surface of the vessel, and for the excess of the speed of sliding of the particles of water over various portions of it, above the speed of the vessel. The result of this process ($LG (1 + b^2)$) may be called the "augmented surface."
- 3.—Compute the height from which a heavy body must fall to acquire the speed of the ship ($\frac{v^2}{2g}$) multiply that height by a coefficient of friction (*f*) deduced from experiment; conceive a layer of water of the thickness resulting from the last multiplication, to be spread over an area equal to the "augmented surface;" the weight of that layer will be the resistance of the vessel at the given speed (*R*).
- 4.—Multiply that resistance by the speed of the vessel in feet per second, and by a factor (*k*) ascertained by experiment, to allow for the loss of power by slip and by the friction of the engine and propeller; the result will be the power or mechanical energy expended in a second, which, divided by 550, gives indicated horse-power.
- 5.—The more convenient rule for finding the required indicated horse-power may be thus expressed:—multiply the "augmented surface" by the cube of the speed in knots, and divide by a divisor which is found by experiment.

$$\left(C = \frac{115}{k f} \right)$$

IV.—COMPARISON OF THE THEORY WITH EXPERIMENT.

In applying this theory to experimental data, the proper course is to compute from those data the value in each case, either of the gross co-efficient of resistance (*k f*), or of the divisor (*C*), which is inversely proportioned to that co-efficient; and should those values present such variations only as can be accounted for by ordinary variations in the efficiency of engines and propellers, and in the condition of the vessel's bottom, the influence is in favour of the soundness of the theory. It is necessary in every case to have access to the plans of the vessel, and hence complete sets of data are less abundant than could be wished.

The formulae to be employed are as follows:—

For the divisor,

$$C = \frac{V^3 L G (1 + b^2)}{I. H. P.} \dots \dots (8)$$

For the gross coefficient of resistance,

$$k f = \frac{115}{C} \dots \dots (9)$$

The following table gives nine examples of such calculations. Three of them are founded on experiments made by Mr. J. R. Napier and the author, on published data relative to Government vessels, and two are published reports of trial trips of vessels belonging to the Peninsular and Oriental Steam Navigation Company.

The breadth, mean draught of water, midship section and displacement, are given in each case, to show the variety of forms and sizes to which the calculations relate. The displacement ranges from 140 to 3000 tons; the proportion of length to breadth, from $5\frac{1}{2}$ to 10; the proportion of breadth to draught of water, from $2\frac{1}{2}$ to $4\frac{1}{2}$.

The final results show the *divisor* as ranging from 19210 to 20864, and the *gross co-efficient of resistance*, from '00599 to '00551.

Example.	Length.	Breadth.	Mean Draught	Midship Section.	Displacement.				Augmented Surface.	Speed Knots.	Divisor.	Co-efficient of Gross Resistance.	
						Mean Girth.							
	L. Feet.	Feet.	Feet.	Sq. Feet.	Tons.	G. Feet.	L. G. Sq. Feet.	$1 + b^2$	L.G. $(1 + b^2)$ Sq. Feet.	V.	I.H.P.	C.	k.f.
I. Vulcan (paddle)	160	16	4.5	56	140	14.75	2,360	1.1	2,596	14.5	412	19,210	'00599
II. Bk. Swan, now Ganges(s.)	244	36.5	13.8	385	1,670	40	9,760	1.2	11,712	12	970	20,864	'00551
III. Admiral (paddle)	210	32	7.5	214	820	31.5	6,615	1.36	9,000	11.9	744	20,385	'00565
IV. Rattler (screw)	178	33	11.25	274	870	32.5	5,785	1.4	8,099	10.07	428	19,360	'00593
V. Rattler (screw)	178	33	13.50	330	1,078	37.5	6,675	1.4	9,345	9.64	437	19,370	'00593
VI. Fairy (screw)	140	21.1	4.83	71.5	168	19.0	2,660	1.2	3,192	13.33	364	20,770	'00554
VII. Fairy (screw)	140	21.1	5.83	82	196	21.5	3,010	1.23	3,702	11.9	321	19,435	'00592
VIII. Ceylon (screw)	290	41	18.5	649	3,000*	52.4	15,196	1.16	17,625	13.34	2,054	20,371	'00665
IX. Nubia (screw)	280	39.5	17.25	515	2,100*	48.2	13,496	1.16	15,655	12.15	1,422	19,725	'00583

V.—LIMITATIONS TO THE THEORY.

The theory stated in this paper is not applicable to vessels which are so bluff at the bow and stern as to push before them or drag behind them a mass of water full of whirling eddies; for in such vessels the assumption already stated, that the water agitated by friction is a very thin layer, is not fulfilled.

Neither is the theory applicable to a vessel which raises a wave that buries a considerable proportion of her bows. This does not occur in well-shaped vessels of the sizes to which the experiments already quoted relate; but it may occur in models, as experiments made by Mr. James R. Napier and the author have shown. Small wooden models of vessels were made, of very various proportions, the proportion of length to breadth ranging from five to ten. The proportionate

resistance of these models when dragged in pairs at equal speeds were tested by means of suitable apparatus, and it was found that when the speed was so small as not to raise a wave exceeding the ordinary proportion of the height of the wave to the dimensions of the vessel in large ships (say, from $\frac{1}{10}$ to $\frac{1}{20}$ of the draught of water), the results of the experiments exactly agreed with the theory; but when the speed was increased until the wave buried from one half to the whole of the bows of the models, the resistance of the broader model was increased in a greater proportion than that of the narrower.

From the result of these experiments it follows that, in order that conclusions drawn from experiments on models may be applicable to actual ships, care should be taken not to move the model at a speed which raises a wave exceeding in proportionate height the wave raised by the large vessel; and, that such may be the case, the velocities of the model and of the ship should be proportional to the square roots of their linear dimensions. For example, the models already mentioned were about $\frac{1}{10}$ part of the linear dimensions of the vessel that they were intended to represent; and when dragged at $\frac{1}{10}$ of the speed of those vessels, or less, their resistance followed the same laws, but not otherwise. This conclusion is common to the theory of the present paper, and to Mr. Scott Russell's wave theory.

The effect of such waves as have been here referred to on the resistance might be taken into account by means of a supplementary theory, provided a sufficient number of experiments had been made on the large scale to determine the necessary data; but in the experiments on the large scale quoted in this paper, the resistance due to the wave at the bow seems to have been insensible, or to have been balanced, or nearly balanced, by the pressure of the wave at the stern. This balanced action is to be expected in vessels whose lengths, as prescribed by Mr. Scott Russell, are equal, or nearly equal, to the lengths of waves travelling with the same speed.

VI.—DEDUCTIONS FROM THE THEORY.

The approximate expression for the resistance may be divided into two terms, one of which is increased, and the other diminished, by increase of length. For a vessel of a given size and type there is some proportion of length to breadth which makes the resistance a minimum. To determine that proportion exactly by the method of maxima and minima would be a process of extreme complexity and difficulty; but from a series of approximate calculations made by way of trial, it would appear to be not very far from that of 7 to 1—a conclusion in accordance with that which some authorities on ship-building have deduced from practical experience. It appears further that of two vessels which deviate equally in opposite directions from the best proportion, the larger has less resistance than the shorter; this conclusion also agrees with practical experience.

If, as the comparison of the theory with experiment seems to show, the resistance of a vessel is proportional to what has been called the *augmented surface*, it is the area so designated, and not the midship section, which should regulate the areas of paddles and screws.

The results of the investigation described in the paper tend to prove that friction constitutes the most important part, if not the whole, of the resistance of ships that are well shaped for speed, and that its amount can be deduced with great precision from the figure of the ship by the aid of proper mathematical processes. On this, as well as other accounts, it is to be desired that the data which are collected by the Committee of the British Association on Steam Ship Performance should be accompanied as far as possible by drawings of the ships' lines; at all events, by the "body plans," from which the forms of water-lines can easily be constructed when the distances between the frames are known.

FREIGHT AS AFFECTED BY DIFFERENCES IN THE DYNAMIC PROPERTIES OF STEAM SHIPS.

By CHAS. ATHERTON, CHIEF ENGINEER, H.M. DOCKYARD, WOOLWICH.

The national importance of steam shipping is a theme which demands no demonstration, and any attempt to originate, promulgate, and popularise inquiry into the comparatively economic capabilities of the steamship as devoted to the international conveyance and interchange of the products of nature and of manufacturing art, irrespective of its application as an engine of war, is a task which requires no laboured introduction in support of its being favourably received for consideration by an association devoted to the advancement of science.

The former papers on "Tonnage," "Steam Ship Capability," and "Mercantile Steam Transport Economy," which the author of this further communication has been permitted to present to the British Association, and which appear in the volumes of its Transactions for the years 1856, 1857, and 1859, were devoted to an exposition of the technicalities of the subject as respects the mutual quantitative relations which displacement, speed, power, and coal hold to each other in the construction and equipment of steam ships with a view to the realisation of definite steaming results. So far, therefore, these investigations have had reference to the constructive equipment of steam ships; but the course of inquiry now submitted for consideration is intended to be a practical exposition of the extent to which the expense per ton weight of cargo conveyed is affected by the various conditions of size of ship, dynamic quality of hull with reference to type of form, weight of hull with reference to its build, the economic properties of the engines with reference to the consumption of fuel, and the steaming speed at which the service is required to be performed, all which circumstances respectively, and in their combinations, affect the economic capabilities of steamships for the conveyance of mercantile cargo, and consequently freights charged, to an extent not publicly known, because hitherto not specially inquired into nor promulgated by the press, and which, in the distinctive details above set forth, do not appear to have been duly appreciated even by the parties most deeply concerned in the mercantile control and prosecution of steam shipping affairs. The aggregate expenses incidental to the prosecution of steam transport service must generally regulate the average rates of freight at which goods are conveyed; and seeing to what an extent the ultimate cost of manufactured goods is dependent on the cost of transport, often repeated as freight charges generally are in the various stages of transition of material from the raw to its manufactured condition, and its ultimate consumption as a manufactured article, it becomes evident that this investigation especially concerns the manufacturing interests of the country. Economy of price inducing quantity of consumption, is the characteristic feature of the manufacturing enterprise of the present day, and it is the absolute cost of goods which affects consumption, irrespectively of the various causes in detail by which the cost may have been enhanced. Under these circumstances, it is remarkable to what extent the manufacturing interests, though keenly alive to legislative imposts, whether foreign or domestic, affecting the cost of goods, and sensitively jealous of legislative interference in the control of labour, as affecting the cost of manufacture, pass wholly unheeded deficiencies and imperfections in the practical control of shipping with reference to freight charges, though equally affecting the ultimate price of manufactures. Such incongruity demonstrates the necessity for popular exposition and inquiry into the various circumstances and combinations of circumstances which directly affect the expenses incidental to the conveyance of merchandise by steam ships, and by which the rates of freight are in the aggregate necessarily regulated. Freight,

therefore, is the text of the following discourse, to which attention is directed under the various aspects of steamship construction and management, by which freight charge is affected, and which may be classified under ten heads or sections, as follow:—

- SECTION A.—FREIGHT, as affected by variations of the size of the ship by which the service is performed.
 B.—FREIGHT, as affected by variations in the constructive type of form of the hull.
 C.—FREIGHT, as affected by variations in the working economy of the engines, with reference to the consumption of coal.
 D.—FREIGHT, as affected by variations in the constructive weight of the hull, with reference to its load displacement.
 E.—FREIGHT, as affected by variations in the constructive type of form, combined with variations in the working economy of the engines.
 F.—FREIGHT, as affected by variations in the size of ship, combined with variations in the constructive type of form, and in the working economy of the engines.
 G.—FREIGHT, as affected by variations of the steaming speed at which it is required that the service shall be performed.
 H.—FREIGHT, as affected by variations of the size of the ship, combined with variations of speed.
 I.—FREIGHT, as affected by variations of the speed, combined with variations of the working economy of the engines.
 K.—FREIGHT, as affected by variations of the speed, combined with variations in the type of form, working economy of the engines, and weight of hull.

It will be observed that it is not proposed to determine the actual amount of prime cost expenses incidental to the prosecution of steam-ship enterprise, by which the scale of freight charge may be chiefly regulated, but it is proposed to demonstrate, with reference to a specified unit of performance, the ratio or comparative scale of cost, in which the prime cost expenses incidental to the conveyance of cargo per ton weight of goods conveyed on a given passage is, *ceteris paribus*, affected by each of the various circumstances or conditions set forth under the ten different heads above referred to.

The fundamental consideration on which it is proposed to base this investigation is this, that, within moderate limits of variation, the investment incidental to the fitting out of steam ships for commercial transport service is approximately proportional to the quantity of shipping as measured by the constructor's load displacement of the ships, and the amount of working power employed, as measured by the indicated horse-power, also that the interest on investment, upholding of stock, and all other annual expenses incidental to the working of steamships, such as coals, stores, and wages, harbour dues, insurance, and pilotage, are approximately proportional to such investment; and further, as the mercantile service of steamships employed on a given station generally requires that their passages shall be periodical, it is assumed in the following calculations that the number of passages made annually by each ship is the same in all the different vessels assumed to be employed on the same service and brought into comparison with each other.

It is particularly to be observed that these calculations and deductions of comparative freight charges are not of general application to different services, but have reference only to the special service which, as an example of the system of calculation for any service, has been adopted as the unit of performance, namely, the performance of a ship of 5000 tons displacement, employed on a passage of 3000 nautical miles, and steaming at ten knots per hour, the co-efficient of performance by the formula

$$\frac{V^3 D^{\frac{3}{2}}}{I. H. P.} = C, \text{ being } C=250, \text{ and the consumption of coal being at the rate of } 2\text{lbs. per indicated horse power per hour, which data have been assumed at the base of the following tabular statement, consisting of 19 columns, the purport of which is as follows:—}$$

- Column 1st.—Reference to divisions or sections of the subject under consideration.
 2nd and 21st.—Designation of the vessels referred in the various sections.
 3rd.—Size of the ship as determined by displacement at the draft to which it is intended by the constructor that the ship shall be loaded.
 4th.—Steaming speed at which the vessel is required to perform the passage.
 5th.—Co-efficient of dynamic performance of the vessel by the formula

$$\frac{V^3 D^{\frac{3}{2}}}{I. H. P.} = C.$$

 6th.—Consumption of coal per indicated horse power per hour expressed in pounds.
 7th.—Co-efficient of dynamic duty with reference to coal consumed by formula

$$\frac{V^3 D^{\frac{3}{2}}}{W}, \text{ } W \text{ being the average consumption of coal expressed in cwts. per hour.}$$

 8th.—Power required to propel the vessel at the required speed expressed in indicated horse-power, and calculated by the formula, indicated horse-power =

$$\frac{V^3 D^{\frac{3}{2}}}{C}$$

 9th.—Length of passage to be performed by the ship without re-coaling, expressed in nautical miles.
 10th.—Weight of hull, including all equipment complete for sea (exclusive of engines, coal, and cargo) taken at 40 per cent. of the load displacement.
 11th.—Weight of engines and boilers in working order, including all equipment for sea, taken at the rate of 5cwts. per indicated horse-power.
 12th.—Weight of coal required for the passage, calculated on the foregoing data.

13th.—Cargo, as determined by the load displacement less the weight of hull, engines, and coal.

14th.—Investment in the hull of the ship, including rigging, furnishing, and all other equipment complete for sea, taken at £50 per ton weight of hull.

15th.—Investment in the engines, including spare gear and all equipment for sea, taken at £15 per indicated horse power.

16th.—Total investment in hull and engines.

17th.—Comparative rates of freight or ratios of cost expenses per ton of cargo, being proportional to the investment divided by the tons weight of cargo conveyed.

18th.—Ratios of cost expenses per ton of cargo, with reference to that incurred by Ship A, taken as the unit of performance, and which is expressed by the number 100.

19th.—Ratios of cost expenses per ton of cargo with reference to the cost incurred by ship A taken as the unit of performance, and which is expressed by £1 per ton.

20th.—Comparative freight on 100,000 tons of goods, assuming the freight by ship A to be at the rate of £1 per ton of goods conveyed.

21st.—Designations of vessels referred to in the sections.

The table may be interpreted as follows:—

SECTION A.—Freight, as affected (*ceteris paribus*) by variations of the size of ship.

By reference to the following table it will be observed that as the ship's size (column 3) is reduced from 5000 tons displacement to 4000 tons, the expenses per ton of cargo (column 17) become increased in the ratio of 49 to 51, that is, in the ratio of 100 to 104 (column 18), showing an increase of 4 per cent.; or, expressed in money, assuming £1 per ton to be the rate of freight by ship A, of 5000 tons displacement, the rate by ship A₁, of 4000 tons displacement will be £1 0s. 10d., and by following the table it appears that the rate of freight by ship A₂, of 3000 tons will, as compared with ship A, of 5000, be increased 8 per cent., amounting to £1 1s. 8d. per ton.

The comparative freight charges on 100,000 tons of goods (columns 20) by the vessels A, A₁, A₂, respectively, would be £100,000, £104,000, and £108,000.

Thus, in merely a mechanical point of view, and irrespectively of various mercantile and nautical considerations which may limit the size of the ship, we see the benefit of performing goods transport service by large vessels, in preference to small ones, provided that adequate cargo be always obtained, and that no delay be thereby incurred. But it is to be observed that if the 5000 tons ship, A, instead of being loaded with its full cargo of 2395 tons, be loaded only with the quantity of cargo (1878 tons) that could be carried by the 4000 tons ship, A₁, the freight expenses per ton of cargo would, in this case, be enhanced in the proportion of 63 to 49, that is, in the proportion of 128 to 100, or 28 per cent.; or, expressed in money in the proportion of £1 4s. 10d. to £1, the same being a higher rate by 24 per cent., than the freight charge at which the 4000 tons ship, A₁, would perform the service. By pursuing the calculations from the data adduced by the table, it will be found that the economic advantage of the 5000 tons ship, A, as compared with the 4000 tons ship, A₁, will be entirely sacrificed if its cargo be reduced from 2395 tons to 2305 tons, or be only 90 tons, or 3 $\frac{3}{4}$ per cent., deficient of its full load. Also, as compared with the ship, A₂, of 3000 tons, the advantage of the 5000 tons ship, A, will be lost if its cargo be reduced from 2395 to 2218, or be only 177 tons deficient of its full load.

Hence it appears that the superior economic capabilities of large ships in a mechanical point of view for the conveyance of goods, may, in a mercantile point of view, be very soon sacrificed by mismanagement in assigning larger vessels for the discharge of mercantile service than is demanded by the trade, notwithstanding the economic superiority of large ships when promptly and fully loaded.

SECTION B.—Freight, as affected (*ceteris paribus*) by variations in the constructive type of form of the hull.

The relative constructive efficiency of mercantile ships in a purely dynamic point of view as respects type of form (irrespectively of materials and workmanship) is now generally recognised as being determined by their co-efficients (C) of dynamic performance, as deduced from actual trial of the ships, and calculated

by the following formula $\frac{V^3 D^{\frac{3}{2}}}{I. H. P.} = C$, which may be expressed as follows:—

Multiply the cube of the speed (V³) by the cube root of the square of the displacement (D ^{$\frac{3}{2}$}), and divide the product by the indicated horse-power (I. H. P.); the quotient will be the co-efficient (C) of dynamic performance.

To enter upon the various uses to which this formula is applied would be irrelevant to the matter now under consideration. Suffice it to say that the numerical co-efficient obtained as above set forth affords practically a means by which the mutual relations of displacement, power, and speed of a steam ship of given type of form, and of which the co-efficient is known, may (*ceteris paribus*) be deduced, and it affords a criterion indicating, whatever be the size of the ship, the constructive adaptation of its type of form for mechanical propulsion, as compared with other types of form tested by the same rule, the condition of the vessels, as respects cleanness of immersed surface, stability, and other essential properties, being assumed to be the same; and now we proceed to show to what extent, under given conditions, freight per ton of goods conveyed is affected by variations of type of form, as represented by variations of the co-efficient of performance.

By reference to the table (Section B), it will be observed that as the co-efficient of dynamic performance is reduced from 250 to 150, the expenses become increased in the ratio of 100 to 132, or 32 per cent.; or, assuming the freight, by ship A, of which the co-efficient of dynamic performance is 250, to be at the rate of £1 per ton of cargo, the charge by ship B₁, of the same size, but of which the co-efficient is 200, will be £1 2s., being an increase of 10 per cent., and the charge by ship B₂, of the same size, but of which the co-efficient is 150,

will be £1 6s. 5d., being an increase of 32 per cent., as compared by the rate of freight by ship A, of which the co-efficient is 250.

The comparative freight charges on 100,000 tons of goods by the vessels A, B₁, B₂, respectively, would be £100,000, £110,000, and £132,000.

Seeing, therefore, that variations of the type of form, as indicated by variations of the co-efficient of dynamic performance, even within the limits of 250 and 150, which are of ordinary occurrence in steam shipping, affect the expenses incidental to the conveyance of mercantile cargo under the conditions referred to, and consequently affect the rate of freight, to the extent of 32 per cent., the co-efficient of dynamic performance which a ship may be capable of realising, being thus (*ceteris paribus*) a criterion of the economic working of the ship, with reference to power, becomes a highly important matter for directorial consideration in the purchasing or disposal of steam ships.

SECTION C.—Freight as affected (*ceteris paribus*) by variations in the working economy of the engines with reference to coal.

The relative working economy of marine engines as respects the consumption of coal per indicated horse-power per hour, is evidently an important element for consideration as affecting freight, to illustrate which, it has been assumed that variations in mercantile practice extend from 2lbs. per indicated horse-power per hour to 4lbs. The consumption of so little as 2lbs. per indicated horse-power per hour is not usually attained, but being now admitted to have been achieved, and such having become a matter of contract stipulation, it may, be looked forward to as the probable future consumption on board ship generally, although the ordinary consumption of existing steamers cannot, at the present time, be rated at less than 4lbs. per indicated horse-power per hour.

By reference to the table (Section C), it appears that under the special conditions of the service under consideration (namely vessels of 5,000 tons displacement, employed on a passage of 3,000 nautical miles, and steaming at the speed of 10 knots an hour) by increasing the consumption of coal from 2lbs. to 4lbs. per indicated horse-power per hour, the expense per ton of goods conveyed becomes increased in the proportion of 49 to 56, that is, in the proportion of 100 to 114, being an increase of 14 per cent., or, assuming the freight by the standard ship A, consuming 2lbs. of coal per indicated horse-power per hour, to be at the rate of £1 per ton of cargo conveyed, the rate of freight by ship C₁, consuming 3lbs. per indicated horse-power per hour, will be £1 1s. 2d., being an increase of 6 per cent., and the rate of freight by ship C₂, consuming 4lbs. per indicated horse-power per hour, will be £1 2s. 10d., being an increase of 14 per cent. per ton of goods conveyed under the conditions referred to.

The comparative freight charges on 100,000 tons of goods by the vessels A, C₁, C₂, respectively, would be £100,000, £106,000, and £114,000.

SECTION D.—Freight charge as affected (*ceteris paribus*) by variations in the constructive weight of hull with reference to the size of the ship as determined by the load displacement.

To illustrate this matter it has been assumed that the weight of hull, including the whole equipment complete for sea (exclusive of engines, coal, and cargo), may vary from 40 per cent. of the load displacement to 60 per cent., under which limitations, by reference to table (Section D), it appears that under the special conditions of the service under consideration, by increasing the weight of hull from 40 per cent. of its displacement to 60 per cent., and assuming the cost of the hull to be in proportion to its weight of materials, the expenses or freight charge per ton of cargo conveyed become increased in the proportion of 49 to 120, that is, in the proportion of 100 to 245, being an increase of 145 per cent., or, assuming the freight charge by the standard ship A, of which the weight of hull is 40 per cent. of the load displacement (2000 tons) to be at the rate £1 per ton of goods conveyed, the rate of freight by ship D₁, of which the weight of hull is 50 per cent. of the load displacement (2,500 tons) will be £1 10s. 7d. per ton, being an increase of 53 per cent., and by ship D₂, of which the weight of hull is 60 per cent. of the load displacement (3,000 tons), the rate of freight becomes £2 9s. per ton, being an increase of 145 per cent. per ton of goods conveyed under the conditions referred to.

The comparative freight charges on 100,000 tons of goods by the vessels A, D₁, D₂, respectively, would be £100,000, £153,000, and £245,000.

Hence, in the construction of steam ships we see the importance of quality of material and excellence of fastening as a means of reducing weight, and the disadvantage that attends heavy-built ships, such as war steamers, for discharging mercantile service. Hence also we see the deficient steaming endurance of high-speed armoured ships, unless built of enormous size, as measured by their load displacement.

SECTION E.—Freight is affected (*ceteris paribus*) by variations in the constructive type of form combined with variations in the working economy of the engines.

By reference to the table (Section E), it appears, under the special conditions of the service under consideration, that by an inferior type of form as indicated by the co-efficient of performance being reduced from 250 to 150, combined with an inferior construction of engines, as indicated by the consumption of fuel being increased from 2lbs. to 4lbs. per indicated horse-power per hour, thereby reducing the co-efficient of dynamic duty (column 7) from 14,000 to 4,200, the expense or freight charge per ton of goods conveyed becomes increased in the ratio of 100 to 179, being an increase of 79 per cent.; or, assuming the freight charge by the standard ship A, of which the co-efficient of performance is 250, and rate of consumption 2lbs. per indicated horse-power per hour (giving a co-efficient of dynamic duty 14,000) to be at the rate of £1 per ton of goods conveyed, the rate of freight by ship E₁, of which the co-efficient of performance is 200, and consumption of coals 3lbs. per indicated horse-power per hour (co-efficient of dynamic duty 7,467) becomes £1 4s. per ton, being an increase of 20 per cent., and by ship E₂, of which the co-efficient of performance is 150, and the consumption of coal at the rate of 4lbs. per indicated horse-power per hour (co-efficient of dynamic duty 4,200) the rate of freight becomes £1 15s. 10d., being an increase of 79 per cent. per ton of goods conveyed under the conditions referred to.

The comparative freight charges on 100,000 tons of goods by the vessels A, E₁, E₂, respectively, would be £100,000, £120,000, and £179,000.

Hence, in the control of steam shipping, we see the importance of the co-efficient of dynamic duty (column 7), as indicating the economic efficiency of the ship in a mercantile point of view, with reference to the merits of her hull and engine-construction, being made a subject of contract stipulation.

SECTION F.—Freight as affected (*ceteris paribus*) by variations in the size of the ship, combined with variations in the constructive type of form and in the working economy of the engines.

By reference to the Table (Section F), it appears, under the special conditions of service under consideration, that by the size of the ship being reduced from 5,000 tons displacement to 3,000 tons displacement, combined with an inferior type of form, as indicated by the co-efficient of performance being reduced from 250 to 150, and an inferior construction of engine, as indicated by the consumption of coals being increased from 2lbs. to 4lbs. per indicated horse-power per hour, the expense or freight charge per ton of goods conveyed becomes increased in the ratio of 49 to 113, that is in the ratio of 100 to 230, being an increase of 130 per cent.; or, assuming the freight by the standard ship A, of 5,000 tons, of which the co-efficient of performance is 250, and the consumption of coal at the rate of 2lbs. per indicated horse-power per hour, to be at the rate of £1 per ton of goods conveyed, the rate of freight by ship F₁, of 4,000 tons, of which the co-efficient of performance is 200, and the consumption of coal at the rate of 3lbs. per indicated horse-power per hour, will be £1 5s. 2d., being an increase of 26 per cent., and by ship F₂, of 3,000 tons displacement, of which the co-efficient of performance is 150, and the consumption of coal at the rate of 4lbs. per indicated horse-power per hour, the rate of freight becomes £2 6s., being an increase of 130 per cent. per ton of goods conveyed under the conditions referred to.

The comparative freight charges on 100,000 tons of goods by the vessels A, F₁, F₂, respectively, would be £100,000, £126,000, and £230,000.

SECTION G.—Freight as affected (*ceteris paribus*) by variations of the steaming speed at which it is required that the service shall be performed.

It is proposed to illustrate this most important elemental consideration by reference to rates of speed within the range of present practice, namely, from 10 to 14 knots per hour.

By reference to the table (Section G), it appears that, under the special conditions of the service under consideration, by increasing the speed from 10 to 12 knots per hour, the expense or required rate of freight per ton of goods conveyed becomes increased in the ratio of 49 to 64, that is, in the ratio of 100 to 131, being an increase of 31 per cent.; and by increasing the speed from 10 to 14 knots, the expense, or required rate of freight per ton of goods, becomes increased in the ratio of 49 to 93, that is, in the ratio of 100 to 182, being an increase of 82 per cent. Hence, assuming the freight by the standard ship A, of 5,000 tons, making a passage of 3,000 nautical miles, at 10 knots per hour, to be at the rate of £1 per ton weight of goods conveyed, the rate of freight by ship G₁, steaming at 12 knots per hour, will be required to be £1 16s. 2d. per ton weight of goods conveyed, and the rate of freight by ship G₂, steaming at 14 knots per hour, will be required to be £1 16s. 5d. per ton of goods conveyed.

The comparative freight charges on 100,000 tons of goods, by the vessels A, G₁, G₂, steaming at 10, 12, and 14 knots per hour respectively, would be £100,000, £131,000, and £182,000.

Hence we see how onerous are the obligations which usually impose on mail packets a rate of speed higher than that which would be adopted for prosecuting a purely mercantile service; and as no service can be permanently and satisfactorily performed which does not pay, it follows that the inadequacy, if any, of a high-speed postal subsidy must be made up by surcharge on passengers and cargo, and is, therefore, *pro tanto*, a tax upon trade.

SECTION H.—Freight as affected (*ceteris paribus*) by variations of the size of ships combined with variations of steaming speed.

We will suppose the size of ships to be 5,000, 4,000, and 3,000 tons displacement, and the steaming speed to be at the rates of 10 knots, 12 knots, and 14 knots per hour respectively.

By reference to the table (Section H), it appears that, under the special conditions of the service under consideration, by reducing the size of the ship from 5,000 to 4,000 tons, and increasing the speed from 10 to 12 knots per hour, the expense or required freight charge becomes increased in the ratio of 49 to 66, that is, in the ratio of 100 to 134, or 34 per cent.; and, by reducing the size of a ship from 5,000 to 3,000 tons, and increasing the speed from 10 knots to 14 knots, the required freight charge becomes increased in the ratio of 49 to 119, that is in the ratio of 100 to 243, being an increase of 143 per cent., or a multiple of 2½ times nearly. Hence, assuming the rate of freight by the standard ship A, of 5,000 tons, steaming at 10 knots, to be £1 per ton weight of goods conveyed, the required rate of freight by ship H₁, of 4,000 tons, steaming at 12 knots, will be £1 6s. 10d., and the required rate of freight charge by ship H₂, steaming at 14 knots per hour, will be at the rate of £2 8s. 7d. per ton weight of goods conveyed.

The comparative freight charges on 100,000 tons of goods by the vessels A, H₁, H₂, respectively, will be £100,000, £134,000, and £243,000.

SECTION I.—Freight as affected by variations of speed combined with variations of the working economy of the engines.

Assuming the rate of speed to be 10 knots, 12 knots, and 14 knots, and the consumption of coal to be 2lbs., 3lbs., and 4lbs. per indicated horse-power per hour respectively, by reference to the Table (Section I), it appears that by increasing the speed from 10 knots to 12 knots an hour, and the rate of consumption of coal being also increased from 2lbs. to 3lbs. per indicated horse-power per hour, the required freight charge becomes increased in the ratio of 49 to 72, that is, in the ratio of 100 to 147, or 47 per cent.; and by increasing the speed from 10 knots to 14 knots per hour, and the rate of consumption being also increased from 2lbs. to 4lbs. per indicated horse-power per hour, the required freight charge becomes increased in the ratio of 49 to 152, that is, in the ratio of 100 to 310,

being an increase of 210 per cent., or more than trebled. Hence, assuming the expense or required freight charge by the standard ship A, steaming at 10 knots per hour, and consuming 2lbs. coal per indicated horse-power per hour, to be at the rate of £1 per ton of goods conveyed, the required freight charge by ship I₁, steaming at 12 knots an hour and consuming 3lbs. of coal per indicated horse-power per hour, will be at the rate of £1 9s. 5d. per ton of goods, and the required freight charge by ship I₂, steaming at 14 knots per hour and consuming 4lbs. of coal per indicated horse-power per hour, will be at the rate of £3 2s. per ton of goods conveyed. The comparative freight charges on 100,000 tons of goods by the vessels A, I₁, I₂, respectively, would be £100,000, £147,000, and £310,000.

Hence we see how onerous are the obligations of increased speed, if attempted to be performed with engines of inferior construction, as respects economy of fuel.

SECTION K.—Freight as affected (*ceteris paribus*) by variations of the speed, combined with variations in the type of form, working economy of the engines, and weight of hull.

The object of this section is to show the effect, even of small differences, of practical construction, when operating collectively to the detriment of a ship, combined with the obligation of increased speed.

By reference to the Table (Section K) it appears, that under the special conditions of the service under consideration, by increasing the speed from 10 to 12 knots, with a ship of inferior type of form, as indicated by the coefficient of performance being reduced from 250 to 225, and of inferior engine arrangement, as indicated by the consumption of fuel being increased from 2 to 3lbs. per indicated horse-power per hour, the weight of hull being also increased 5 per cent., namely, from 40 per cent. to 45 per cent. of the constructor's load displacement; by this combination, the expense per ton of goods conveyed becomes increased in the proportion of 49 to 102, that is in proportion of 100 to 208, being an increase of 108 per cent., or more than doubled; or, assuming the freight by the standard ship A, to be at the rate of £1 per ton, the rate of freight by ship K₁, under the differences above referred to, becomes £2 1s. 8d., and it is to be observed that if the speed be increased to 14 knots, whilst at the same time the co-efficient of performance is reduced to 200, the consumption of fuel increased from 2 to 4lbs. per indicated horse-power per hour, and the weight of the hull increased 10 per cent., namely, from 40 per cent. of the load displacement to 50 per cent., under these conditions the entire load displacement of the ship K₂ will be appropriated by the weight of the hull, engines, and coal, leaving no displacement whatever available for cargo, that is to say, the vessel K₂ is entirely unable to perform the conditions of the service as a mercantile steamer.

The comparative freight charges on 100,000 tons of goods conveyed by the vessels A and K₁, respectively, would be £100,000 and £208,000.

As respects the relation which exists between the dynamic properties of vessel A, taken as the standard of comparison in the foregoing sections, and the dynamic properties of mercantile steam ships generally at the present time, it might be regarded as invidious to refer to and particularise the actual performances of vessels presently employed on commercial service, but it may be affirmed generally that the ocean performance of mercantile steam fleets does not average a co-efficient of economic duty by the formula

$$\frac{V^3 D^{\frac{3}{2}}}{W}$$

exceeding 5,600, whilst modern naval architecture and engineering has practically shown that with certain types of form the co-efficient of performance may be expected to vary from 250 to 300, and that some engines of modern construction have consumed only from 2lbs. to 2½lbs. of coal per indicated horse-power per hour, thus practically constituting a possible co-efficient of economic duty as high as 14,000, which has therefore been assigned to ship A in the foregoing table, and whereby, under the conditions of the service referred to, viz., ships of 5,000 tons displacement steaming at 10 knots per hour, on a passage of 3,000 miles, the conveyance of goods per ton weight may be expected to be performed at fully 30 per cent. less cost than would be necessarily incurred under the same circumstances by vessels of the same size, but of which the co-efficient of economic duty does not exceed 5,600, and this comparative difference would be greatly exceeded if the size of ships be reduced, the length of passage increased, or the speed accelerated.

From the foregoing statements it appears that public interests in the great matter of FREIGHT demand that steam ships only of the most effective construction, as respects hull and engines, be employed on mercantile service. Bad types of hull and wasteful engines necessarily, as we have seen, enhance freight, increase the cost of production, and consequently curtail consumption, thus constituting a blight on national industry. A check on these evils, highly conducive to the gradual reduction of freight expenses by steam ships, would at once be instituted by making it a matter of *contract stipulation*, that a definite co-efficient of DYNAMIC DUTY, by the formula

$$\frac{V^3 D^{\frac{3}{2}}}{W}$$

should be realised on test trial of the ship, at the builder's load displacement and steaming at the stipulated speed. Unquestionably, for years past, in our popular marine engineering, prejudice and expediency have retarded progress; marine engineering practice has not duly availed itself of the established truths and science of the times. High-pressure, expansion, superheating, and surface condensation, now being reanimated as the basis of modern improvements, are but the legacies of a by-gone age hitherto neglected.

It is only by directing public opinion to bear on such subjects of general interest, that any prevalent evil can be corrected; and surely an appeal on the important subject of "FREIGHT," as affected by differences in the dynamic properties of steamships, cannot be more appropriately made to any public body than to the British Association, under the presidency of a man especially distinguished and honoured in the path of practical science, and assembled at Manchester, the birth-place of free-trade, and the manufacturing capital of the world.

REVIEWS AND NOTICES OF NEW BOOKS.

Diagrams to Facilitate the Calculation of Iron Bridges. By FRANCIS CAMPIN, C.E. London: E. and F. N. Spon, Bucklersbury.

These diagrams are intended for the use of practical engineers and draughtsmen, and appear to reduce much the labour of calculation, enabling also such as are unacquainted with mathematics, to execute with ease, calculations of strain, referring to plate or lattice girder flanges, arches or chains, lattice webs of 45° and 60°; the strains being obtained on any part of the structure by measurement according to scale. Five hundred feet span is the general limit of girders, &c., to which the diagrams are applicable. There can be little doubt of the utility of the subject of these remarks to the class for whose use it is designed; it might certainly have been more satisfactory to a large portion of the engineering public, if Mr. Campin had appended the formulæ from which the six sets of curves, constituting the diagram, were calculated, in addition to the explanation of the method of using the same. This defect, however, does not in any way detract from the applicability of the diagram to practical purposes; and we have great pleasure in recommending these diagrams to the notice of engineers, as being of considerable assistance in the routine of office work.

CORRESPONDENCE.

We do not hold ourselves responsible for the opinions of our Correspondents.

STEAMSHIP CAPABILITY.

(To the Editor of the ARTIZAN.)

SIR,—Your correspondent, "A Marine Engineer," is in error in connecting my name with the application of the Midship Section Formula as a means of determining the relative dynamic efficiency of steamships. The midship sections, even if the ships be similar, only give the means of determining the ratio of the sizes of ships; but the displacements of the vessels designate their actual sizes as measured by the cubical masses or weights propelled through the

water. The displacement formula $\left(\frac{V^3 D^{\frac{3}{2}}}{I. H. P.}\right)$ has, therefore, been exclusively

used by me for determining the relative dynamic merits of the hulls of steamers as respects their form; but for determining the relative dynamic merit of steamers, embracing form of hull and efficiency of engines—that is, the ratio of the dynamic results with reference to coals consumed—the formula becomes

$\frac{V^3 D^{\frac{3}{2}}}{W}$, W being the weight of coals consumed in a given time, say cwts. per

hour, and it was with a view to popularising the displacement formula, involving as it does $D^{\frac{3}{2}}$ that I published tables showing the squares of the cube roots (or cube roots of the squares, which is the same thing) of numbers rising progressively from 10 to 50,000, and the cubes of numbers from 5 to 25, rising progressively by the decimal '01. These tables, as published in the appendix to my *Essay on Steamship Capability*, 2nd. edition, are, I believe, original; they are now out of print, but I purpose giving them more general publicity.

With reference to your correspondent's remarks on the relative dynamic merits of the Royal Yacht and the Holyhead Mail Packets, I would merely notice that your correspondent objects to the official measured knot speed (16.82 knots) of the Royal Yacht, on the ground that the working power and speed could not be continuously upheld on a sea voyage; nevertheless, your correspondent assumes that on the occasion of the Royal Yacht's run from Holyhead to Dublin, steaming at only 13.6 knots per hour, the power was continuously maintained at 2980 I. H. P., which on the occasion of the Stokes Bay trial gave 16.82 knots—this inference is, I submit, inadmissible.

The data quoted by your correspondent is altogether insufficient for determining the matter in question, which is well worthy of attention as a matter of science, not of professional rivalry, and as your correspondent has raised the question as affecting hull and engines collectively, I would suggest that if the mean displacements of the vessels, coals consumed, and speeds realised on the occasions referred to, or on any other continuous sea service can be ascertained, we shall then have the means of ascertaining the dynamic merits of both these specimens of steamship construction with reference to each other, and as compared with other systems of marine engineering now practically realised. We have heard a great deal about steamship improvement, and I venture to say that the inquiry above specified would, as set forth in detail in my papers on "Freight as affected by Differences in the Dynamic Properties of Steamships," lately presented to the British Association at Manchester, show the necessity, in a mercantile point of view, of giving attention to the improvement of marine engines.

I am, Sir, yours very obediently,
CHAS. ATHERTON.

CONVERSION OF IRON INTO STEEL.

(To the Editor of the ARTIZAN.)

SIR,—I have read with much interest the Baron de Rostaing's remarks, at page 83 of your April number, but I have not yet had an opportunity of seeing the preceding papers on the subject. I have seen lately many interesting notices of the late investigations of analytical chemists on the Continent and in this country, regarding the action of cyanogeneous gases in converting iron into steel, and it would seem to myself to be advantageous if some practical man would give us a compendious history of what has been done of late years, in an article in your pages. Having been myself engaged, some years ago, in researches

upon the best mode of smelting the magnetic iron ores of India, and into the mode of making cast steel as practised there, I shall be able to make some remarks upon these subjects, which may perhaps prove interesting both to yourself and to the Baron de Rostaing, if I can be allowed a place in your pages occasionally. But from want of skill and knowledge as an analytical chemist, and from want of the extensive apparatus requisite in the investigation of a subject so very difficult as the true theory of the cyanogeneous gases, I have been unable to decide the true composition of many substances of which I shall have to make mention; and, besides, at present I have not the means of referring to my manuscript notes on the subject, which are bulky and rather extensive, and I must, therefore, trust to memory. I therefore beg to crave pardon if I am led into any blundering assertions or errors on theoretical points which have been proved and acknowledged. I propose to proceed by stating a series of propositions which I have myself either satisfactorily proved, or which are acknowledged by persons of known accuracy; and I shall number each of these for the sake of easy reference, and then if any of them are doubted, denied, or controverted by others, I propose to enter upon detailed proofs and evidences, which might otherwise be considered superfluous.

Proposition 1.—The use of cast iron in making steeled instruments for rough purposes, by its reaction upon iron at a welding heat, has long been known for forming the coulters of ploughs, &c.—and many other things of a similar nature—and I have myself, many years ago, practised this method for making bill hooks, choppers, and cleavers of the very best quality (nearly as good as if made with cast steel) using only Indian iron, and the white cast iron made from the iron sand which is so prevalent all over the Mysore country. For this purpose the end of a broad flat bar was bent round and doubled back and united at a welding heat by the two contiguous edges on one side, leaving the other side open about an inch, thus forming a sort of deep spoon, which was filled up with rusted fragments of white cast iron, and the whole being raised to a welding heat in a common charcoal forge fire, and allowed to boil a little, until the cast iron had conglomerated into tough steel, it was then consolidated and forged in the usual manner; and the connection of this with the Baron's remarks, will, I think, require no comment from me at present.

Proposition 2.—All charcoal-made pig iron is capable of being made into natural or puddled steel when exposed to the action of heat along with any of the oxides of iron or pounded magnetic iron ore, or when exposed to the reaction of a blast of air while kept in a state of fusion; this, I suppose, will not be denied, as it seems to be Bessemer's process, and also the mode in which natural steel is made in the Catalan forges.

Proposition 3.—Charcoal-made pig iron is also converted into natural steel by its action, at a high temperature, upon fragments of malleable iron, the latter being corroded and dissolved much in the same way as if exposed to the action of an acid. This method is frequently practised by the natives of India in making an inferior kind of their Wootz steel, as the time and labour requisite to produce the fusion of the steel in the crucible is much decreased thereby.

Proposition 4.—In fusing portions of bar iron into cast steel, it is absolutely requisite that the crucibles should be deep and narrow, in order that the bottom part might be exposed to the focus of the heat, while the mouth is kept higher than the point where any oxygenous air can reach, otherwise the steel would be decomposed; therefore cast steel cannot be fused in a reverberatory furnace except it is enclosed in close crucibles.

Proposition 5.—In making cemented steel there is no reaction between the charcoal powder and the bar iron; the cyanogeneous gas formed by the combustion by a blast or by a strong draught, being the steelifying agent, and the only use of the charcoal powder is to prevent any free or uncombined oxygen getting into contact with the steel.

Proposition 6.—A true steelifying agent, by which bar iron is converted into steel, is the gaseous compound of nitrogen and carbon, or a cyanogeneous gas, formed by the action of the blast upon the fuel at a high temperature. This has been publicly stated, but not proved, by writers upon this subject in India, as long ago as the year 1845; but the matter seems to have been neglected, or has escaped attention, until lately, when some continental chemist of note has revived the same statement, but I do not know if any satisfactory proof has been put forward. The correctness of this assumption may be inferred from the well known fact of the action of the yellow salt of cyanide of potassium, in case-hardening iron; from the action of leather shavings, &c., for the same purpose, and from other phenomena.

Proposition 7.—That the true result of combustion in a closed furnace should contain some cyanogeneous gas has, I think, been stated long ago by Dr. Ure, or some other practical writer, in consequence of its not being at all likely that the nitrogen in the blast should remain quite neutral; and it may also be inferred, from the colour and appearance of a small flame from a hole in the furnace, at some short distance from the blast pipe, which is of a dull orange yellow colour, with a few scintillating sparks, while the flame of carbonic oxide would give a light blue; and also from the poisonous effects, caused by accidentally inhaling the gas, and the medical symptoms resulting therefrom. The carbonic acid and oxide, generally found to be the results of combustion in open fires, are probably derived from the secondary oxygenation of the cyanogeneous gases, when they come into contact with free atmospheric air.

Proposition 8.—The primary result of smelting any ore of iron in a blast furnace is a spongy mass of fibrous and malleable tough iron, which, by the continued action of the cyanogeneous gases at a high heat is converted into steel, then into white cast iron, and becoming more fusible, is then changed into grey cast iron, and then into black. That the statements generally received, as stated by writers upon this subject, are not true, can be simply and easily proved from the results of a small blast furnace not more than 3ft. high and 10in. wide, which can be worked with perfect certainty to produce any required result at pleasure. In this, if the charge of ore is very small and the blast strong, then the result is always very fusible black iron, and by increasing the charge and decreasing the blast, and also consequently the intensity of the

heat, then the result is always white pig iron, then thick and puddeny steel, then malleable natural steel, and lastly, with the lowest moderate heat, and least charge of fuel, and a soft and gentle blast, the result is fine malleable fibrous iron, as is always to be seen in working the little Indiau charcoal furnaces, &c.

Proposition 9.—It is probable that silicon or the metallic base of silica, may have something to do with the true theory of the conversion of iron into steel, and also into converting it into fusible pig iron, as a black silicate almost always appears upon decomposing these, either by gases or by oxides, and I have seen traces of what seemed to be fused silica upon the cast steel in the crucibles; but there would seem to be a difficulty in conceiving how the silicon could get into contact with the bar iron during the process of cementation into steel, while embedded in charcoal powder, unless the silicon has been found to be volatile at very high temperatures, or, under certain conditions, along with gases, as I think I have read of, as being a proved result by some analytical chemist.

Proposition 10.—Pieces of charcoal can be converted into plumbago, by the action of black cast iron at a very high temperature, retaining the form and the knots and fibrous appearance of the wood after removing the iron by an acid.

Proposition 11.—During the action of cast iron upon pieces of malleable iron in a crucible (*vide* Proposition 3), great quantities of a gas are evolved, with violent action and a boiling noise, and the lid of the crucible can be heard plainly to rise and open and to close again with a strong snapping noise. Is not this fact alone sufficient to prove that the steelifying agent is probably of a gaseous form, or whence comes the gas.

I remain, sir, your obedient servant,
CALCAR.

NOTICES TO CORRESPONDENTS.

W. H. G.—The paper is in type, but, owing to press of matter, must stand over till next month.

J. H. (Liverpool).—We will endeavour to find the table referred to, and let you know in our next.

G. W.—The suggestion has already been made to us by some half dozen others, and we have observed it made elsewhere. Mr. George Rennie was, we believe, the first to suggest the use of two screws. You are, however, quite right.

D.—You had better apply to some of the Clyde iron ship-building firms—as, Messrs. Randolph, Elder, & Co.; Reid & Co., &c.

F. G. S.—It is Mr. John Laird, sen. Write to him at Birkenhead.

OMEGA.—You have been forestalled; the same plan has been patented by a Mr. John Dean, of Derby.

SURFACE CONDENSATION.—The following are the particulars of the *Hibernian* and *Norwegian* :—

	feet. in.
Length between perpendiculars.....	290 0
Beam moulded	37 6
Depth moulded	25 6
Tonnage, O.M.....	2000 tons.
Diam. of cylinders	5 5
Stroke	3 6
Revolutions.....	44

Air, cold water, feed, and bilge pumps worked by separate engines. Main cylinders jacketed. Working pressure, 25lbs. Working vacuum, 26in. to 28in. Separate expansion slides. The *Norwegian* left Quebec on the 17th August, and arrived at Derry on the 26th.

D. S. (Bombay).—You are wrong. The *Colombo* was originally fitted with Lamb's patent boilers. Although the economy cannot be very accurately determined, it is stated that from 28 to 30 per cent. has been saved by the introduction of Lamb's superheating apparatus to the boilers of the same ship. The *Ceylon* has, with an increase of speed, effected a saving of 6002 tons of coal (representing £10,000 in money) in seventeen voyages.

X.—The address of Mr. Hughes, C.E., the author of the book—is Park Street, Westminster.

V. DE STAINS, B.A.—We fear your expedient for preventing railway accidents is totally impracticable.

G. H. M.—The error in the paper on "The Strength of Girders," &c., in *THE ARTIZAN*, of September, was, as you suggest, accidentally overlooked, and will be corrected. Thanks.

D. K.—The gas blow pipe is, we believe, that manufactured by L. J. Paine, of Broad Street, Golden Square.

P. S.—Messrs. Rennie & Son are, at the present time, constructing such a dock as that to which you refer.

X. X.—As to the Giffard Injector and the previous experiments, the following letter was received some time ago:—

"THE GIFFARD INJECTOR.

"To the Editor of *THE ARTIZAN*,"

"SIR,—I hear that much has been said and written upon this marvellous appliance, and so late as the 22nd December, 1860, Mr. C. Wye Williams writes to the *Engineer* (see page 420, column 2), 'That a given power is exercised in introducing the water into the boiler, as feed water, is manifest; but what that power is, or from what it proceeds, has yet to be determined; and to this ought our attention, in the first instance, be directed.'

"When steam, or air, or any fluid, moves with rapidity, it does not press equally in all directions, the lateral pressure may be removed, and the water may flow into the pipe, by virtue of its gravity. The steam does not 'drive the water before it,' but drags it after it and with it *continuously*."

"HENRY PRATT."

M. E.—The address of the Association of "Assistant Engineers" is, we believe, at 50, Gloucester Street, Mr. G. Fox being the Secretary.

LIFEBOATS.—Must stand over.

J. K. W. (Washington).—Received, and they are being engraved.

W. J. M. R.—The "Appendix" to your paper has *not* been received; therefore, the abstract sent is not quite intelligible.

T. GILMOUR.—Shall be glad to hear from you as you propose.

C. EDWARDS (Poplar).—Have you yet obtained the information you sought.

W. H. (Newcastle).—We have just learnt that the vessel in question was a total failure.

To give particulars thereof would therefore be perfect folly.

ARMOUR-CASED SHIPS.—It would be better to leave the matter in the hands of the Admiralty, and save your time, ink, and paper.

SUPERINTENDENT.—The best electro-magnetic apparatus for your purpose is Sandy's railway telegraph instruments; and, for the junction and distance signals, Saxby's patent apparatus is what you should adopt.

F. C. (Chowder).—We cannot inform you of the cost of treating the railway bars by Dodd's process. You had better address them, at Rotherham, or the Secretary to the Company, Mr. Cook, Sise Lane, Bucklersbury, London. We do not know the patent railway grease nor the boiler fluid to which you refer. The feeding apparatus must be "Giffard's Patent." Apply to Messrs. Sharp, Stewart, & Co., Manchester. The wheel tyres are made somewhere in Yorkshire. Write to Mr. Craven, the loco, at Brighton, he having used them extensively. Mr. McConnell, of the North Western, has constructed his locomotive boilers upon the same principle for some years past. We believe Mr. Beattie has abandoned bricks. The Great Northern boiler plates are, we believe, the best. Try "Bowling plates. We regret we have not space this month for further replies.

ALPHREDS.—The plan which we understand has been adopted for the improvement of the Danube navigation is that suggested by Mr. Rennie, and in accordance with his plan. You are wrong in describing them as the plans of Mr. Hartley. Mr. Rennie's plans, &c., were published and circulated about five years ago.

Loco.—The same thing has been done by Mr. Cowan, of the Great North of Scotland Railway.

Z.—Mr. S. Bateson is the patentee of the feed water heater, which has been successfully applied on the London and North Western Railway.

DOT AND LINE.—A similar scheme was proposed by a young electrician, Mr. Harrison, of Haverfordwest. The best and cheapest printing instrument is that recently patented by Mr. J. Banks.

HIGH PRESSURE.—Moderation is advisable. Progress gradually. As to condensers, Mr. J. F. Spencer has been the most successful amongst those who have tried surface condensation. We send him to have succeeded perfectly.

DYNAMICS.—See Mr. Atherton's paper in the present number.

NOTES AND NOVELTIES.

OUR "NOTES AND NOVELTIES" DEPARTMENT.—A SUGGESTION TO OUR READERS.

We have received many letters from correspondents, both at home and abroad, thanking us for that portion of this Journal in which, under the title of "Notes and Novelties," we present our readers with an epitome of such of the "events of the month preceding" as may in some way affect their interests, so far as their interests are connected with any of the subjects upon which this Journal treats. This epitome, in its preparation, necessitates the expenditure of much time and labour; and as we desire to make it as perfect as possible, more especially with a view of benefiting those of our engineering brethren who reside abroad, we venture to make a suggestion to our subscribers, from which, if acted upon, we shall derive considerable assistance. It is to the effect that we shall be happy to receive local news of interest from all who have the leisure to collect and forward it to us. Those who cannot afford the time to do this would greatly assist our efforts by sending us local newspapers containing articles on, or notices of, any facts connected with Railways, Telegraphs, Harbours, Docks, Canals, Bridges, Military Engineering, Marine Engineering, Shipbuilding, Boilers, Furnaces, Smoke Prevention, Chemistry as applied to the Industrial Arts, Gas and Water Works, Mining, Metallurgy, &c. To save time, all communications for this department should be addressed "19, Salisbury-street, Adelphi, London, W.C." and be forwarded, as early in the month as possible, to the Editor.

MISCELLANEOUS.

SHIP VENTILATING COMMITTEE.—The first important trial at Portsmouth of the method adopted by the Ship Ventilating Committee for improving the ventilation of Her Majesty's Ships, has been brought to a conclusion at Portsmouth on board the gunboat *Handy*, and which has been fitted on the plan recommended by the committee. The system was tested by getting up steam and keeping the engines going at full speed for three hours, when a certain temperature was gained. The ventilators were then opened, the engines still going at the same speed, and the temperature reduced in the engine and boiler room and stokehole 28 degrees, and in the forecabin 13½ degrees.

IRON DIVING-BELL BOAT.—Messrs. Simons and Co., of the London Works, Renfrew, recently launched a new iron diving-bell boat, for the River Clyde Trust. This craft is of peculiar formation, to suit the service for which it is designed, and is by far the largest and most powerful that has yet been used on the Clyde. It is capable of blasting and removing, 30 to 40ft. below the surface, the hardest and largest rocks. The diving-bell is 8ft. square, weighs nine tons, and it can safely accommodate four or five workmen. The apparatus for lowering and hoisting is of the most efficient construction, and it is supplied with air by large and complicated brass air-pumps. Arranged along the deck are powerful winches and cranes, and various other purchases, ready to meet any emergency. There are also comfortable cabins for twenty workmen.

ELECTRIC POSTAGE.—When the Post-office closed its account with the public revenue, in the year 1837—previous to the first alteration of the postage to 4d., as preliminary to the adoption of a general rate of a penny—the number of letters transmitted, at varying rates of 6d., 9d., and 1s. each, was more than 1,000,000 weekly. This has been regarded as furnishing a fair basis for calculating what may be done by an uniform rate of message by telegraph at one shilling; and the United Kingdom Telegraph Company are about to carry out this system upon their lines, which are fast spreading throughout the country northwards, and is now open as far as Manchester and Liverpool, for messages, at one uniform rate of a shilling each.

PHOTOGRAPHS OF MICROSCOPIC OBJECTS.—Professor Gerlach, of the University of Erlangen, Bavaria, has recently sent to the Imperial Academy of Vienna photographs of microscopic objects obtained by a new process. First he takes a negative of the object itself, then from this enlarged he takes a positive, and continues the process until he has obtained a picture containing more details than can be discovered by the best microscope now in use.

LONDON STREETS.—A return recently made from the Metropolitan Police Office states that within a radius of six miles from Charing Cross, there are 2637 miles of streets. Since 1840, the number of houses has increased by upwards of 60,000, and the length of streets by nearly 900 miles.

AMERICAN LOCOMOTIVE WHEEL TYRES.—It is stated that the use of the Griggs wheel on the heaviest locomotives of the Boston and Providence Railway has effected a saving of 52 per cent in the wear of the tyres. The body of this wheel is cast with dovetailed recesses on the brim, into which blocks of hard wood are driven with the grain crossing the rim. The tyre is turned to fit on the rim and has its bearing on the wooden blocks, which act as cushions to absorb the effect of the shocks received from the rail joints.

LUCIFER MATCHES.—Some astonishing statistics respecting this branch of manufacture have lately been given. The firm of Messrs. Dixon employ 400 workmen, and usually have on hand £8,000 to £10,000 worth of timber. Each week they consume one ton of sulphur, and make 43,000,000 matches, or 2,160,000,000 in the year. Reckoning the length of a match at 2½ inches, the total length of these would far exceed the circumference of the earth. The magnitude of the figures relating to the English manufacture of matches is, however, insignificant when compared with the Austrian production. Two makers alone, M. Polak, at Vienna, and M. Furth in Bohemia, produce the enormous quantity of 44,800,000,000 yearly, consuming 20 tons of phosphorus, and giving employment to 600 people. The import of matches into the United Kingdom are of the value of £60,000 yearly, representing the amazing number of 200,000,000 daily. The daily consumption is 50,000,000 more than the above number, or upwards of eight matches each day for every individual in the kingdom.

NEW ZEALAND, by the census of 1860, contains a population of 81,273, as compared with 71,508 in 1859, and 59,277 in 1858.

NAVAL ENGINEERING.

THE "DEFENCE," iron steam frigate, 22, 600 horse-power, steamed into Chatham Harbour on the 7th ult., having left the mouth of the Tyne on the night of the 5th. On the voyage her engines were found to work admirably, and, notwithstanding that only half speed was maintained, and occasionally scarcely that, 10½ knots an hour were easily made, the screw making 52 to 60 revolutions per minute, with a pressure of steam of only 20lbs. For six hours after leaving the Tyne violent southerly winds were experienced, but subsequently the wind was light from the South and South-west. The *Defence* being the first of the iron frigates which has actually been at sea, great anxiety was felt as to how she would behave when meeting the swell which always sets in from the German ocean, coupled with a strong gale. The result, however, was most satisfactory, the huge vessel pitching but very slightly. Although without a single spar, or an inch of canvas set, she steamed as steadily and was as easily managed as a river steamboat. The engines were never once stopped until the Shipwash was reached, 26 hours after leaving Tynemouth, the distance run during that time being 210 miles; the steamer never once being at full speed.

THE "HANDY" gunboat, 40 horse-power, was launched from the yard at Haslar on the 7th ult., with her steam up, to test the joints of her machinery: and the following day steamed over to the Dockyard, where her outfit will be completed for service in the African rivers.

THE "BOMBAY,"—This line-of-battle screw steamer, 81, 400 horse-power, has had the whole of her machinery fitted on board by the contract engineers, Messrs. Humphreys, Tennant & Co. In order to remedy the great inconvenience experienced in large line-of-battle ships of the want of proper ventilation in the magazines, the Lords of the Admiralty have given directions for the mode of ventilation recommended by the committee appointed by the Admiralty to be adopted on board the *Bombay*, the most satisfactory results having accrued from the trials made with it on board the *Marlborough*, 131, and some other vessels of war, where the system has been carried into operation.

THE SIX GUN BATS attached to the first-class steam reserve have exchanged their 68 and 32-pounder smooth-bore guns for 100 and 40-pounder Armstrongs, which they will retain as their permanent armament.

THE "COLLINGWOOD," got up steam on the 11th ult., for the purpose of testing her machinery, in the steam basin at Sheerness, after being subjected to water pressure. Her engines were found to work in a most satisfactory manner, no defect whatever being observable. By those who witnessed the trial, the machinery, which is of a novel description, is considered to be the most perfect and compact that has been introduced into use.

MR. CUNNINGHAM'S PRINCIPLE OF REEFING from the deck has been ordered by the Admiralty to be applied to the upper topsails of the iron-clad frigate *Resistance*. The *Defence* is being fitted also on the same plan. By this arrangement the chain topsail tye will be the only running gear required for setting and taking in the topsails, thus giving extreme simplicity to the equipments aloft, a point of great importance in screw ships of war, as lessening, if not entirely doing away with, the chance of fouling the screw, in the event of the masts being shot away in action. Another important feature in this mode of rig is that the upper topsails can be set and taken in by the crew under cover on the gun deck, without exposing them aloft, or even on the upper deck.

THE "UNDAUNTED," 51, left her moorings in Sheerness Harbour, on the 17th ult., to test her machinery at the measured mile. The trial was most successful, the working of the engines exceeding the most sanguine expectations. The trial was conducted under the disadvantages of being both against tide and wind, the wind being from North West, by North, with a force of six to seven. The results were:—Average speed, with full boiler power, 13 knots; revolutions, 61; pressure of steam 20lb.; vacuum, 25; draught of water aft, 20ft. 2in.; forward, 15ft. 6in.; Griffith's screw, diameter, 18ft., pitch, 20ft.; speed at half boiler power, 12½ knots, 51 revolutions. During the trial there was an entire absence of hot bearings and priming. The average temperature in the stokehole was from 78 to 82 degrees.

THE "OCTAVIA," 51, screw, tested her machinery in the steam basin at Portsmouth, on the 19th ult., the trial being attended with the most perfect success. The motion of the engines could scarcely be felt, which was attributed to the smoothness of action obtained by the introduction of the third crank. It is confidently anticipated that the consumption of the fuel will be 40 per cent. less than the average of the same power.

THE "LEANDER," screw steam frigate, 300 H.P., got up steam on the 22nd ult., at Sheerness, after being subjected to water pressure for the purpose of trying the effect of the new patent expansion gear of Messrs. Boulton and Watts. The trial was eminently successful.

NAVAL ENGINEERS.—The following appointments have taken place since our last:—W. Fabian, Chief Engineer to the *Cumberland*, for the *Arctusa*; C. P. Turner, Chief Engineer to the *Indus*, for the *Styx*; H. W. Edgar, Engineer to the *Fisgard*, for the *Rapid*; C. F. Jordan, Acting Engineer to the *Cumberland*, for the *Bullfrog*; H. Johnson, First-Class Assistant Engineer to the *Arrogant*, for the *Handy*; J. J. Finch, Second-class Assistant Engineer to the *Fisgard*, as supernumerary; L. Buckler and J. Hill, Second-class Assistant Engineers to the *Arrogant*, for the *Handy*; H. Brown, Acting Second-class Assistant Engineer to the *Dawnless*, vice Gill; John Heffernan, promoted to Engineer; J. Taplin, First-class Assistant Engineer, T. G. Punnett, Second-class Assistant Engineer, J. Murphy, Acting Second-class Assistant Engineer to the *Warrior*, to complete complement; O. N. Brooker, Chief Engineer to the *Indus*, additional for the *St. Jean d'Acre*, on the latter being paid off; George Rock, Chief Engineer to the *Fisgard*, for the *Niger*, on the latter being paid off; J. W. German, Chief Engineer, to the *Orestes*; W. Melville and S. P. Potts, First-class Assistant Engineer to the *Orestes*; T. Hartley, First-class Assistant Engineer to the *Cumberland*, additional, for charge of the *Cochin*, vice Melville; W. Stone, First-class Assistant Engineer to the *Plaver*, vice Hirsch; F. Pointon, Second-class Assistant Engineer to the *Orestes*; G. B. Blackwell and H. Benbow, Acting Second-class Assistant Engineers to the *Cumberland* as supernumeraries; S. G. Cox, Acting Second-class Assistant Engineer to the *Orestes*; E. Lewis, Engineer to the *Cumberland*, for the *Rosario*; J. Matthews, Engineer to the *Pelican*, in lieu of the Chief Engineer; J. Fielder, First-class Assistant Engineer to the *Pelican*; W. Ash, First-class Assistant Engineer to the *Asia*, for the *Blazer*; S. Judd, Second-class Assistant Engineer

to the *Ceyser*, vice Fielder; G. Duncan, Second-class Assistant Engineer to the *Impérieuse*, as supernumerary; W. J. Foster, Second-class Assistant Engineer to the *Pelican*; W. B. Rock, W. J. Robinson, J. Flintoff, and W. H. Keats, Acting Second-class Assistant Engineers, to the *Impérieuse*, as supernumeraries; J. Adanson, Acting Second-class Assistant Engineer to the *Pelican*; J. Syder, to Acting Chief Engineer, in the *Rinaldo*; W. Williamson, First-class Assistant Engineer to the *Revenge*, for the *Porpoise*; W. Edwards, Acting Second-class Assistant Engineer to the *Cumberland*, as supernumerary; G. J. Mayburg, Acting Second-class Assistant Engineer to the *Cumberland*, for the *Wildfire*; J. H. Keane and W. Holloway, supernumeraries of the *Asia* to engineers; A. Andrews, on the *Griffon*; C. H. Thompson, on the *Dawntless*; T. H. Kitto, on the *Cock-chaffer*; S. Judd, on the *Geysor*; L. Backler, on the *Arrogant*, for the *Handy*; J. W. Elliot, on the *Asia*, for the *Grinder*; E. Keen, on the *Rinaldo*, and F. Skelton, on the *Slanby* (acting), to the rank of First-class Assistant Engineers; Edwin West, Chief Engineer to the *Malacca*; J. Rock, Chief Engineer, additional, to the *Seringapatam*, at the Cape; H. Leslie, Engineer to the *Malacca*; J. Pearce, First-class Assistant Engineer to the *Malacca*; L. Backler, to the *Asia*, as supernumerary; W. J. Hawkins, Second-class Assistant Engineer to the *Arrogant*, for the *Hundy*, vice Backler; J. Stocks, Acting Second-class Assistant Engineer to the *Malacca*; W. Hair, Acting Second-class Assistant Engineer, to the *Hawke*, additional, for the *Maggie*, vice Hawkins; T. Smith, Acting Second-class Assistant Engineer, to the *Asia*, as supernumerary; A. Gillies, supernumerary, to be engineer; W. A. Houghton, in the *Dee*, to be First-class Assistant Engineer; G. Quick, additional, in the *Asia*, for the *Bullfinch*, confirmed as Second-class Assistant Engineer; R. Incoll, Chief Engineer of the *Renown*, appointed additional to the *Indus*, for the charge of the machinery of the *Renown*, when paid off; S. Shielder, Acting Second-class Assistant Engineer, additional, to the *Indus*, for the *Thais*; J. Melrose, Acting Second-class Assistant Engineer to the *Indus*, for the *Pike*; D. Crichton (B), Acting Second-class Assistant Engineer, additional, to the *Fisgard*, for the *Princess Alice*; W. R. Partridge, Acting Second-class Assistant Engineer, to the *Cumberland* as supernumerary; J. R. Harvey, Second-class Assis. Engineer, to the *Asia*; J. H. Keane, Supernumerary in the *Asia*, to Chief Engineer; G. M. Dovy, Acting Engineer from the *Fisgard* to the *Asia*, as supernumerary; J. Potts, Acting Second-class Assis. Engineer, additional, to the *Arrogant*, for the *Handy*, vice Hawkins; F. Brockton, Engineer, to the *Asia*, for the *Vigilant*; W. H. Edwards, to Engineer in the *Pantaloan*; G. F. Bell, Acting Engineer, to the *Cumberland*, for the *Zebra*; J. T. Payne, Acting Engineer, to the *Fisgard*, for the *Devastation*; R. Ditchbourn, Second-class Assis. Engineer, confirmed in the *Conqueror*.

JONES'S TARGET v. THE ARMSTRONG GUN.—These interesting experiments were resumed at Portsmouth, on the 18th ult., with the plates placed in an upright position, instead of at an angle of 50 degrees, as on the trial which took place on the 21st ult. The test of the 18th ult. can only be applied to the principle as advocated by Mr. Jones as affording comparative results of the effects of the 100-pounder Armstrong throwing a 110lb. bolt with 14lb. of powder upon iron plates placed in a vertical position and at an angle of 50 degrees. The results of the firing on this occasion and on the previous trial will afford most valuable data from which correct deductions may be drawn as to the precise effect of shot upon iron plates, whether of ships or batteries, at various angles of inclination. The target, it may be requisite to repeat, was faced with four plates, two on the left of 4½ in. iron, and two on the right of 5 in. The 5 in. plate on the former trial, with the plates at an angle, received only one shot, which made an indentation of ½ of an inch at its deepest indent. The 4½ in. plate averaged an indentation of 1¼ in. No. 1 shot yesterday struck the junction of the midship 4½ in. and 5 in. plates a little above the centre, making indents on the edge of the 4½ in. of 1¼ in., and on the edge of the 5 in. of 1½ in., but showed no symptoms of cracks. This shot was a remarkable illustration of the support afforded by the strips of iron plate let into the face of the wooden backing to support the edges of the armour-plates against the impact of the shot, and proves that the expensive process of "tongueing" and "grooving" the edges of the plates can only tend to render them vastly weaker than they would be in their normal state as plain metal slabs. The former trial proved this as conclusively as the one of the 21st ult. No. 2 shot struck the midship 4½ in. plate—the one that had been so tremendously pounded on the last trial—and brought it down upon the *Griper's* deck from off the face of the target, the parts of the plate where it had been so severely punished previously by the shot separating and flying off in large scales, and being scattered about the *Griper's* deck, while the main piece remaining on the deck, instead of unfortunately falling overboard, as one did subsequently, afforded a capital opportunity for its examination. No. 3 took effect in the centre of the midship 5 in. plate, making an indent of 1¼ in. No. 4 made an indent to the right of No. 3 of 1½ in., with several cracks, the diameter of the indent in all the instances being about 7 in.—that is, taking in the bulging inwards of the plate, the given depth of the indentation being only in the circumference of the part of the plate struck by the shot. No. 4 struck the upper part of the remaining 4½ in. plate on its outer edge, and broke out a semi-circular piece 18 in. in diameter, separating the layers of the metal to some distance, and driving portions of the surface of the plate on a level with its reverse. No. 7 struck the outside plate right on its centre line, one-third of its length from the top part, making an indent of 1½ in. No. 8 shot struck the same plate, on the same line as the last shot, but one-third of the distance from the bottom; and No. 9 struck on the same central line, and between 7 and 8, the indentations averaging 1¼ in., and the edges of the plate bulging outwards from the centre where the three shots had been planted in a perpendicular line. No. 10 shot struck the 4½ in. plate on the lower part of its inner edge, the outer circumference of the blow being 2 in., however, from the actual edge of the plate, and broke off an irregular-shaped piece 2½ in. in length by 17 in. in breadth, and causing a severe crack of 2 ft. distant from the centre of the blow, also starting one of the pine backing bolts back through the inner skin. No. 11 shot's outer and upper circumference touched No. 5, fracturing the plate 12 in. by 9 in., the broken piece being only supported in its position by the other portions of the plate. The 12th shot struck the outer edge of the outer 5 in. plate, carrying away a portion about the diameter of the shot, and causing a crack in a perpendicular line through Nos. 7, 8, and 9 shots on the same plate, the crack being 3 ft. in length, and open a quarter of an inch. No. 13, the closing shot, brought down the outer 5 in. plate from the target, and toppled it overboard, most unfortunately, so that any further examination of its state at present was precluded. The plate was immediately buoyed, and will be recovered for examination with the remaining two plates still on the face of the target, which will be removed from their present position for that purpose. Until this has been done no precisely accurate conclusions can be arrived at as to the actual difference in the effect of the shot, of the same calibre, fired at plates in an upright and oblique position. On laminated plates the great injury caused by the shot's impact, is not on the outer surface, where the blow is actually struck, but on the inner surface, or reverse, and consequently, as before stated, no positively correct results can be arrived at until the inner surface of the plates have been carefully examined and contrasted. From an examination of those portions of the plates which had bulged off from the pine backing, it could be, however, plainly ascertained that the fracture on the plates' reverse, caused by the indentation of the shot when the plates were upright as before, was vastly greater than when they were placed obliquely, as on the first trial. One matter was obvious at the close of the firing, and was one of no little importance. It was that if a plate's fastenings on an upright side of a vessel were destroyed, the plate itself must fall overhead and leave that portion of the side defenceless, whereas this would not so readily happen on sloping sides. When the plates have been removed from the target, and the one recovered that has been sunk, and all carefully examined, it will be necessary to return to the subject again, containing as it does points of the very highest importance. The principle advocated by Mr. Jones may be correctly termed deflection, whereas the one tried before was resistance.

STEAM SHIPPING.

THE "SALCA," paddle steamer, was recently launched from the recently acquired building-yard of Messrs. Randolph, Elder and Co. This vessel is the property of the Pacific Navigation Company, and is intended for coast and river traffic on one of the Company's subsidiary lines. Her dimensions are: length of keel and fore-rake, 190ft.; breadth of beam, 30ft.; depth of keel to under side of upper deck at amidships, 17ft.; height between decks, 6ft.; burthen, 800 tons. Her engines are Randolph, Elder, and Co.'s patent double cylinder, of 160 H.P. nominal.

THE "MINA," a fine screw steamer intended for the Spanish trade, was launched from the yard of Messrs. Richardson and Co., Stockton-on-Tees, on the 5th ult. Her dimensions are: length between perpendiculars, 208ft.; breadth, moulded, 39ft. 6in.; depth, moulded, 18ft. 3in.; tonnage, O.M., 880.

THE "ATHENS," a large iron screw steamer, the property of the Greek and Oriental Steam Navigation Company, and intended to trade between Liverpool and the Mediterranean, was launched on the 8th ult., from the yard of Messrs. Leslie and Co., of Hebburn quay. She is 1368 tons register, and her dimensions are,—length, 270ft.; breadth, 33ft. 9in.; and depth, 21ft. 6in. This vessel has been built under Lloyd's special survey, and is classed A 1 for twelve years. The *Athens* will receive her machinery from the establishment of Messrs. R. Morrison & Co. The engines are of 200 H.P.

THE "UNDINE," a beautiful screw steam clipper was launched on the 8th ult. from the building-yard of Messrs. Wingate of Whiteinch. This vessel, which is 600 tons register and engines of 200 H.P., has been built expressly for the China trade, and her accommodations are unsurpassed, being fitted up with the last ventilating improvements for tropical climates. Her engines will be fitted with Silver's patent marine governor, and other improvements.

THE "PERU," a magnificent iron paddle steamship of 1400 tons register, was launched on the 8th ult. from the yard of Messrs. John Reid & Co. This vessel is the property of the Pacific Steam Navigation Company, and is intended to ply between Panama and Valparaiso as consort to the *Callao*, *Valparaiso*, and other vessels built by the same firm. The *Peru* will be furnished with Messrs. Randolph, Elder & Co.'s patent double cylinder engines of 350 nominal H.P.; she is built of iron of the best boiler plate quality, and is classed A 1 for nine years.

THE "PLADDA," iron screw steamer, was successfully launched on the 8th ult., from the yard of Messrs. Blackwood and Gordon, Port Glasgow. This vessel is intended for the Glasgow, Cork, and Waterford trade, and her dimensions are:—Length overall, 176ft.; breadth 24ft. 6in.; depth in hold, 14ft.; tonnage, 502 B.M. Her engines are direct acting, 85 H.P. nominal, and fitted with Silver's patent governor.

ENORMOUS STEAMSHIP.—The steamship *Constitution* now building in New York, by the well-known ship builder, W. H. Webb, to run between San Francisco and Panama, will probably have with the exception of the *Great Eastern* the greatest capacity of any steamer afloat. Her length is 360ft., and her width 45ft.; extreme width over her wheels, 70ft. 6in. The Novelty Iron Works are constructing her engines, the cylinder of which is 105in. in diameter, with 12ft. stroke. She has four fine boilers, each 36ft. long, 13ft. diameter, and weighing 45 tons. Diameter of wheel, 20ft.

THE "LADY OF THE LAKE."—This little vessel recently underwent a trial trip, in which she attained the great speed of 16 miles an hour, giving extreme satisfaction to all concerned. The *Lady of the Lake* was built in the yard of the Thames Ship Building Company, Blackwall, and her dimensions are:—length between perpendiculars, 140ft.; length of keel for tonnage, 129ft. 2½ in.; extreme breadth, 18ft.; depth in hold, 8ft. 3in.; tonnage, 222 ⁹/₁₆. Her engines are by Messrs. Stewart and Sons, of Blackwall, and are of the collective power of sixty horses.

THE "VICTORIA."—This steamer, built by Messrs. Samuda, and engaged by Messrs. Penn, attained remarkable speed on her first voyage from Gravesend to Folkestone, preparatory to her employment in the South Eastern Company's daily service between Folkestone and Boulogne. The voyage, which is stated to give the highest speed ever attained by any vessel over a similar distance, was performed in three hours and fifty-two minutes, giving (as the total distance is 84 statute miles) an average speed of 21.7 statute miles per hour, equal to about 18½ knots. This included the assistance received from the tide, estimated by the pilot at under two miles.

EXTRAORDINARY RAPID PASSAGE.—The *Hebe*, a new screw steamer, belonging to Messrs. Wilson & Sons, lately made the passage between Hull and St. Petersburg, in the space of five days six hours, captains time, Russian time being two hours earlier than our own, reduces it to five days four hours, which, taking into consideration that the *Hebe* drew nearly 17ft. of water, and the amount of dead weight carried, is certainly a most wonderful performance. This vessel has been designed so as to do away with the deck cargoes, and is so arranged that the engine and boiler, are so completely housed in, that in case of her shipping the heaviest sea no water can affect the engine-room or remain on the deck more than a few seconds.

STEAM VESSEL FOR CHINA.—The *Island Queen*, a steam tug vessel, intended for China, is about 400 tons measurement and 110 horse-power, the engines being made on Messrs. Laird & Sons diagonal principle, which has been so successful in the *Inca* and other vessels. In this instance they are fitted with surface condensers, and, as this great improvement in machinery was looked forward to with considerable interest, we have ascertained the following particulars of several trials the *Island Queen* has made within the last few days. She made her first trial trip to Douglas, Isle of Man, thence to Holyhead, and from there to Liverpool, her average speed being 10 knots, and the consumption of coal equal to ten tons in twenty-four hours. During this trial the weather was bad, strong winds and heavy seas. The next was to ascertain her efficiency as a tug boat; and on Wednesday last she towed out to sea, from the Mersey, a new vessel called the *Edward Percy*. The *Edward Percy* is about 900 tons measurement, and was drawing fully 18ft. She towed this vessel easily at the rate of 8 knots per hour, which is considered a first-rate result, looking at the nominal power of the steamer and the size of the vessel towed. The consumption of coal during the time she was towing was at the rate of twelve tons in twenty-four hours. The surface condensers worked beautifully, the vacuum being steady at 28. Two other trials were made, each of four hours' duration. In one case she made a speed of 8 to 9 knots, with a consumption equal to six tons in twenty-four hours; going 10 to 11 knots, the consumption was equal to 10½ tons. So far, therefore, this approved class of engines, with surface condensers, has proved satisfactory, and its advantages will be more apparent when contrasted with engines on the common plan, especially for long voyages, the boilers being kept perfectly clean, and free from the incrustation usual when ordinary condensers are used. The various trials having been satisfactory, the *Island Queen* will be despatched for China in a few days.

THE "GREAT EASTERN," which sailed from Liverpool for New York on the 10th ult., arrived off Cork harbour on the evening of the 17th ult., in a very damaged state. She encountered a very heavy gale about 280 miles to the west of Cape Clear on the 12th ult., and had both paddles completely carried away. The top of the rudder post (a bar of iron 10 in. in diameter) was wrenched away, so that she was unable to answer the helm. She lay like a log in the trough of the sea from Thursday evening until 2 o'clock on Sunday, rolling all the time, her bulwarks almost touching the water. The furniture of the cabin and saloons was completely broken to pieces, and the greater part of the passengers' luggage was destroyed. A cow-shed with two cows in it broke into the ladies' cabin, and both cows were killed. The passengers and crew expected every minute that the vessel

would go down, and they spent a great part of the time at prayers. Between twenty and thirty of those on board, including several ladies, had limbs, ribs, &c., fractured, and numerous cuts and bruises were inflicted. A temporary steering gear was fitted on Sunday, and the vessel made for Cork harbour, sailing with her screw at the rate of nine knots an hour.

THE "PRINCE OF WALES."—A very satisfactory trial trip was made on the 11th ult., of a new paddle steamer called the *Prince of Wales*, built by Mr. Charles Langley, of Deptford, for the Hunter River Steam Navigation Company. Her dimensions are as follows:—Length between perpendiculars, 216ft.; breadth, extreme, 25ft.; depth, 13ft.; register tonnage, 530; builders' tonnage, 650; with a raised quarter deck, 2ft. 9in. This vessel was designed and built to float on a draught of 6ft. 9in., with 30 tons of coal on board, and to carry a dead weight of 200 tons at 7ft. draught, at a speed of 13 knots per hour. The engines are a pair of oscillating ones of 175 H.P.; diameter of cylinders, 45in.; length of stroke, 5ft., fitted with tubular boilers and with feed-heating apparatus of a novel construction. The number of revolutions made were 35, with steam at 30lb. pressure and vacuum at 26 degrees. The engines were made Messrs. Dudgeon of Millwall.

RAILWAYS.

RAILWAY RECEIPTS AND EXPENDITURE.—From two Parliamentary returns just issued, it appears that the aggregate number of miles of railway open for traffic in the United Kingdom at the end of 1860 was 10,433, against 10,002 miles at the end of 1859. The total number of passengers conveyed on those railways in the year 1860 was 163,435,678, against 149,757,294 in the year 1859, showing an increase of 13,678,384. The number of holders of season and periodical tickets in the year 1860 was 47,894, against 49,856 in the year 1859. The total receipts from passengers, parcels, horses, carriages, and dogs amounted, in the year 1860, to £13,055,756 and in the year 1859 to £12,530,646, showing an increase of £525,110. The total receipts for live-stock amounted to £570,950, against £609,723 in 1859, showing a decrease of £38,773. The total receipts for conveying 60,386,798 tons of minerals amounted to £4,951,899, against 51,756,792 tons conveyed in 1859 for £4,223,002, showing an increase of 8,630,096 tons carried and of £728,897 in the receipts. The total receipts for 29,470,931 tons of general merchandise amounted to £9,157,987, against 27,005,737 tons conveyed in 1859 for £8,373,284, showing an increase in the tonnage of 2,465,194 tons, and in the receipts of £784,703. The total traffic receipts for the year 1860 amounted to £27,766,622, against £25,743,502 in the year 1859, showing an increase of £2,023,120. The total working expenditure amounted to £13,187,368, or 47 per cent. of the receipts, not including that of three small railways, the united traffic of which only amounted to £18,136 for the year 1860. This latter being deducted from the above total receipts of £27,766,622 leaves £27,748,486 in respect of which the returns are perfect. The total expenditure being deducted from the latter sum, leaves the net receipts £14,561,118 for the year 1860, applicable to the purposes of interest and dividend on the loan and share capital of the various railway companies of the United Kingdom. Of the total working expenditure £2,437,362, or 18.45 per cent., was for the maintenance of the permanent way; £3,801,282, or 28.83 per cent., for locomotive power; £1,118,784, or 8.49 per cent., for repairs and renewals of carriages and waggons; £3,699,708, or 28.05 per cent., for traffic charges; £517,367, or 3.93 per cent., for rates and taxes; £363,174, or 2.75 per cent., for Government duty; £181,170, or 1.37 per cent., for compensation for accidents and losses; £1,068,521, or 8.10 per cent., for miscellaneous expenses; making the total working expenditure, as above, £13,187,368. The working stock consisted of 5,801 locomotive engines, 15,076 carriages of all kinds for the conveyance of passengers, and 180,574 waggons of all kinds for the conveyance of live-stock, minerals, and general merchandise. Of the total receipts for the year 1860, £23,454,610 were on 7,583 miles of railway in England and Wales; £2,925,229 on 1,486 miles of railway in Scotland, and £1,368,447 on 1,364 miles in Ireland. The total working expenditure was £11,258,104, or 48 per cent., £1,306,128, or 44 per cent., and £623,136, or 45 per cent., respectively; leaving £12,136,708 as the net receipts on railways in England and Wales, £1,619,101 on railways in Scotland, and £745,311 on railways in Ireland. The rolling stock on railways in England and Wales consisted of 4,696 locomotives, 12,333 passenger carriages, and 150,582 waggons of all kinds; on railways in Scotland, 791 locomotives, 1,876 passenger carriages, and 25,215 waggons; and on railways in Ireland, 324 locomotives, 867 passenger carriages, and 4,777 waggons of all kinds. Of the 163,435,678 passengers conveyed on railways in the United Kingdom during the year 1860, 20,625,851 were first-class, 49,041,814 second-class, 93,768,013 third-class, including Parliamentary. The receipts were £3,170,935 for first-class passengers, £3,944,713 for second-class, and £4,162,487 for third-class and Parliamentary passengers, £272,807 for holders of season and periodical tickets; making the total receipts for passengers, £11,550,942. The total receipts for excess of luggage, parcels, carriages, horses, dogs, &c., conveyed in passenger trains amounted to £1,008,892, and for mails to £525,922, making with the receipts for passengers a total of £13,085,756.

RAILWAY SIGNALS.—A circular has lately been issued by the authorities of the London, Brighton, and South Coast Railway, to the effect that a man, to be called the "travelling porter," will accompany every train. His business will be to ride on the seat placed for him on the tender, and to keep a steady and vigilant look-out on both sides, and along the top of the train; so that in case of any accident to any of the carriages or of any signal from the guard, or any apparently sufficient cause that may come to his observation, he may at once communicate to the engine-man, and, if necessary, stop the train. Further, it will be his business, generally, to have charge of the carriages forming the train, to see that, in every respect, they are in good condition, and properly coupled up.

SPANISH RAILWAYS.—Agents of the Spanish Government are now in the neighbourhood of Birmingham, endeavouring to negotiate for the supply of iron rails to the extent of 12,000 tons, besides about 50 locomotive engines, and some 600 railway carriages. The nature and extent of the trade of Birmingham with Spain is now of considerable local importance, there being every indication that the Spanish Government will become larger customers for railway engines and carriages.

RAILWAY ACCIDENTS.

NORTH LONDON LINE.—FEARFUL ACCIDENT.—On the evening of the 2nd ult. a terrible catastrophe occurred on the Hampstead Junction Line, causing the death of eleven persons, and fatally and seriously injuring many others. This line joins the North London at Camden-road station, and passes thence through Camden Town, and Kentish Town by Hampstead, and so on to Kew, where it runs close to the South Western Line. This line is much used by excursionists, so that in addition to the ordinary trains, excursion ones are being constantly run. On this occasion there were several special trains to Kew, and it was to one of these, this dreadful accident occurred. This train, which consisted of about thirteen or fourteen carriages, the first three being what are termed "saloon carriages," and of considerable length, left Kew directly after another excursion train, and which first train arrived at Camden Town station about a quarter past seven, without any impediment having been experienced. Nothing occurred to threaten danger to the second train until it reached the end of the embankment and beginning of the viaduct on which the railway is constructed across the Kentish Town Fields, when just as it approached the arch under which a road is intended to pass from Hampstead Road to Kentish Town, a train laden with ballast was being shunted off the rails, but before it had entirely cleared the rail the engine of the excursion train came into collision with it, and in an instant the engine was tumbled down the embankment, dragging after it three long saloon carriages and an ordinary second-class carriage, to a depth of upwards of 35ft.

into the fields. The first carriage fell on its side, the wheels towards the fields, and the head carriage to the wall of the embankment, and was utterly smashed. The next two carriages fell sideways on to the first carriage, and the fourth carriage fell on its side on the bank. The engine was separated from the train, thrown a great distance into the fields, and almost literally broken to pieces. The scene that ensued was most heart-rending, but not a moment was lost in rendering assistance to the sufferers, and the carriages being broken open, means were thus afforded to rescue those whose injuries were such as admitted of relief of any kind.

FATAL ACCIDENT ON THE EASTERN COUNTIES RAILWAY.—On the morning of the 21st ult., an accident happened near the Colchester station of the Eastern Counties Railway, resulting in the death of one of the company's servants, and the narrow escape of another. It appears that about the hour of six, a platelayer named Woolvett, accompanied by a ganger named Earle, were crossing the line a short distance from the goods shed, situated on an angle of the permanent way near the passenger station, when they were surprised by the approach of a heavily-laden goods train from the Hythe station within a few feet of them. With a bound they cleared the line, and reached the vacant space between the metals of the up and down lines, where they would have been perfectly safe in remaining; but they hastened up to the other side, not perceiving that another equally heavily laden train was there shunting its carriages. The buffer of the break van in an instant violently struck Woolvett, and threw him upon the line, when six of the goods carriages passed over his body, causing instantaneous death. The ganger, Earle, escaped by clinging to the buffer of the break van, which carried him beyond the reach of danger.

FALLING OF A PORTION OF A RAILWAY TUNNEL.—On the night of the 11th ult., the passenger traffic on the up line of the North Kent Railway was entirely stopped for about two hours, in consequence of the falling of a portion of the Blackheath tunnel. Fortunately no accident resulted, as the station-master of the Blackheath station, immediately telegraphed to down stations to stop all up traffic. A gang of workmen were employed to clear the line, and the up train leaving Maidstone at 7.30, after remaining at Woolwich Arsenal station about one hour, proceeded slowly through the tunnel, and arrived at London Bridge-station at 10.50, or one hour and twenty-five minutes behind time. This train is express from Woolwich to New-cross; and, but for the prompt action of the Blackheath station-master, a serious accident might have occurred.

COLLISION ON THE MIDLAND RAILWAY.—At five minutes past three o'clock on the 23rd ult., a goods train, not far from Mangotsfield—the nearest station to Bristol on the Midland line, proceeding towards Gloucester—was being shunted off across the down line to the siding there, to await the passing of the third class train that left this city at 4.45. While the trucks were in process of being shunted off, Marcus's excursion train, returning from Liverpool, was nearing the station, it appears quite unexpected by any of the officials then on duty, who imagined this special train would not be due so soon. As the excursion train approached the station the engine-driver saw that the line was blocked by something bulky, and his experienced eye at once suspected what was taking place. The breaks were put on instantly, but as there is a considerable incline just at Mangotsfield, and the two trains were within a very short distance of each other before the engine man of the special train caught sight of the trucks that barred the rail, owing to the great curve at this part of the line, the rapid motion of the carriages could not be immediately checked. The engine would have stopped, but that the impetus of the cars drove it against the side of the train of goods trucks, and the buffers coming in contact with them, the excursion train was made to rebound. Several persons were injured, but only one case is at all serious, and this it is not anticipated will be attended with any fatal result.

MILITARY ENGINEERING.

BROWN'S TARGET.—The two iron armour plates supplied by Messrs. John Brown, & Co., Atlas Iron and Steel Works, Sheffield, for the *Valiant*, were some time since tested at Portsmouth, but with contrary results in each case, the two plates differing materially in their mode of manufacture. No. 1 plate proved unsuccessful in resisting the shot. No. 2 proved of a superior character, receiving 63-pounder shots, from a 95-cwt. gun, without in each case the surface being indented more than $2\frac{1}{4}$ in. Three shots struck within an area of 22in. by 9in. without penetrating it. The welding of the layers of metal was found to be perfect, and the trial of the last plate was considered quite satisfactory.

TESTING OF ARMSTRONG'S GUNS.—The Ordnance Select Committee of Woolwich Arsenal have lately been engaged for some days in testing with great severity one of the Armstrong 100-pounder guns, in order to prove its extreme power of resistance. The gun underwent 100 rounds of firing with charges of 14lb. of powder and projectiles increasing 100lbs. to 1000lbs. The 1000lbs. projectile was of such length as to extend nearly 2ft. beyond the muzzle. Ten rounds were fired with these enormous bolts, and the gun was reported to be totally uninjured. The recoil of the gun was very violent. It is stated to be the unanimous decision of the Select Committee that no further attempts should be made to burst it, as its strength is deemed abundantly sufficient for all practical purposes. As the 20lbs. elongated shot has been proved to be most suitable as a charge for the 25-pounder Armstrong gun, the War Department have instructed the authorities at Woolwich to make no further delivery of 25-pounder shot, but to issue the 20lbs. projectile in future.

MARTIN'S LIQUID-IRON SHELLS.—The whole of the forts and batteries in the district of Chatham have been furnished with a supply of Martin's liquid-iron shells for large 10in. and 63-pounder iron guns. A number of the cupolas for preparing the molten iron for filling the shells have also been supplied to all the fortifications within this district.

COLES' BATTERY SHIELD.—This shield having undergone the former tests as a sheltered battery, was on the 18th ult. fired into by a 100-pounder Armstrong gun, directed by experienced gunners. The gun was fired at a distance of 400 yards from Her Majesty's gunboat *Cochin*. Shot after shot was seen to strike the shield, glance off rapidly and fall into the sea, without effecting any apparent injury; 98 shots were fired with the like result, the 99th making a visible indentation, and the 100th charge, happening to alight on the same spot, penetrated the facing. The shield was now shattered to a certain degree by the pounding it had received from one of the heaviest guns in the service. Over a range of 400 yards it has borne the brunt of the attack beyond anticipation. The experiment is therefore pronounced exceedingly satisfactory.

TELEGRAPHIC ENGINEERING.

TELEGRAPHIC DESPATCHES for the Russian port of Taganrog, in the sea of Azoff, have been sent direct to that city from the Electric Telegraph Company's station, in Telegraph Street, behind the Bank of England. This is the longest, direct communication by telegraph ever achieved, the distance being above 2,500 miles.

MALTA AND ALEXANDRIAN CABLE.—The *Malacca*, having on board another section of this cable, arrived at Valletta, from London, on the 12th ult. The managing engineer for Messrs. Glass and Co., and a staff of electricians arrived by her. The *Rangoon*, which had been awaiting the *Malacca's* arrival, and had on board another portion of the cable, sailed from Valletta on the 15th ult. She proceeds to the Alexandrian buoy, and after joining the ends will pay out the cable she has on board to Bengazi. To this place the *Malacca* repairs to wait for her. The *Malacca* will then commence laying her cable from the buoy in the Gulf of Syrtis to Bengazi, which will complete the whole line from Malta to Alexandria.

DOCKS, HARBOURS, CANALS, &c.

FATAL OCCURRENCE.—For some weeks past several of the boats on the Grand Junction Canal have been propelled by steam instead of being drawn by horses, and, with proper adaptations of the tunnels, &c., there is no doubt that the difficulties hitherto experienced in navigating canals with steam boats are in a fair way of being overcome. There are several tunnels on this canal, the one in which this melancholy affair happened being close to the Blisworth station, on the London and North Western Railway. The canal tunnels are made of brick, and little, if at all, larger than a sewer. The tunnels are so constructed that horse-power is of no use, previous to the introduction of steam the boats being propelled by a process called "legging." The process is this:—A board is placed on either side of the boat, and on each board lies a man, who places his feet against the wall of the tunnel, and thus pushes the boat along. This system still prevails on boats to which the steam-engine has not as yet been applied, and as the labour of thus "legging" the boat is both arduous and disagreeable, the steam engine is welcomed as a very agreeable substitute. The engine, however, is not without its disadvantages, for, as the tunnels are long, and no larger than sewers, the boatmen are half stifled by the volumes of carbon that are emitted from the low tunnel: coal being burnt instead of coke. On the night of the 6th ult, two steamboats entered the tunnel, and, before they again emerged from it, the people in them were rendered insensible by the fumes from the engines, two of the men being quite dead, and one of them fearfully burnt by falling, while insensible, on the engine. The tunnel is a mile or more in length, and has but one shaft in it, that one at the time being partially covered up.

GAS SUPPLY.

GAS DIVIDENDS.—The directors of the Crystal Palace District Gas Company declare a dividend of 6 per cent per annum, together with a bonus, after the rate of 2 per cent per annum, both free of income tax. The West Ham Company 3½ per cent on the half year free of income tax; the Wolverhampton Company 5 per cent, free of income tax for the half year; the Derby Gas Company a dividend of 10 per cent; and the Sunderland Gas Company 4½ per cent in addition to 3½ per cent already paid in the spring, making 8 per cent for the year.

FATAL GAS EXPLOSION.—On the afternoon of the 20th ult., a violent explosion, accompanied with loss of life, took place in one of the carriage sheds of the East Lancashire Railway station at Bury. Mr. Newall, the superintendent of the carriage department, has been for some months engaged in a series of experiments for the purpose of perfecting his plan of lighting railway carriages with gas, and for this purpose a tank was constructed. On this occasion Mr. Bamber, foreman of the mechanics, was engaged in what is technically called washing out the gas, and for that purpose let in water, which forced the gas out of an iron pipe which was fixed in the top of the tank. It is supposed that the tank was nearly full when Bamber applied a light to the end of the pipe to burn the gas instead of letting it escape. At this time one of the bystanders states that the pressure gauge attached was indicating 10lbs. or 12lbs. to the inch, when suddenly a tremendous explosion shook the building, smashing the windows and wood-work on every side. On going to the spot it was found that the tank had burst, one of the longitudinal sides being burst in two and blown away. The unfortunate man, Bamber, was found dead and much mutilated, about eleven yards from the spot.

INCREASE IN THE PRICE OF GAS.—The three gas companies supplying the City of London with gas, have, since the passing of the Metropolis Gas Act, determined to raise the price of their gas. This decision has been made known to the inhabitants by the issuing of a circular, stating that the Legislature having, after full inquiry, passed an act for regulating the supply of gas to the metropolis, requiring, under heavy penalties, a higher standard of illuminating power and purity, which necessarily involves an increased cost of production, the companies supplying the city will be brought under the provisions of this act, and therefore the future charges will be 4s. 9d. per 1000ft. for the ordinary coal gas.

BOILER EXPLOSIONS.

APPALLING BOILER CATASTROPHE.—The vicinity of Rotherhithe, near the Commercial Docks, was, on the evening of the 16th ult., the scene of a most frightful catastrophe, occasioned by the explosion of a steam-boiler, at the Lower Ordnance Wharf, in the occupation of Messrs. Francois and Joseph Badart, oil cake manufacturers, by which no fewer than ten persons lost their lives. The premises occupy a large area on that portion of the waterside which is known as Cuckold's Point, opposite to the Limehouse entrance of the West India Docks, and about half a mile from the Commercial Dock-pier. They comprised several buildings, wherein the processes of grinding the seed, extracting and refining the oil, and compressing the oil cakes were carried on. The machinery, which was very extensive, was propelled by steam power. The boiler and engine-house stood on the river side of the mills, parallel with the wharf, and contained two long boilers, of 50 horse-power each, laid in massive brickwork. The number of hands generally employed in the mills is somewhat limited, considering their extensive character, but owing to the pressure of business and the urgency of some shipping orders, a relay of workmen was taken on Monday evening at six o'clock for night work. Only one boiler had been at work during the day; and it appears that about the same time the night men came on, six o'clock, a defect was noticed in a joint of the feed pipe to the engine. The engine-driver at once sent for an engine-fitter, at the same time turning the steam off the boiler. It would seem, however, that the driver, acting under the impression, probably, that the joint would speedily be repaired, had omitted to draw the furnace, as a quantity of fire is stated to have been in it. The fitter arrived, and, with the driver, proceeded down to the engine-room and commenced their work, but finding that they required assistance, they communicated with one of the officials, and the whole of the labourers who had just come on were sent to their aid. Six of the men were desired to support the pipe which runs across the roof, while the engine-fitter went on with repairing the joint. There had been three or four other labourers in the chamber, but their services not being immediately required, they had only left a few minutes before the explosion took place. The men had not been long at work at the joint before those in other parts of the factory were alarmed by a loud rumbling noise and heavy concussion, which shook the neighbourhood, followed by a terrific crash, and a rush of steam and smoke. The boiler-house was seen to be in ruins, and at the time it was difficult to say what would be the fate of the whole property. It was some minutes ere any attempt could be made to approach the engine-room where the unhappy men had been at work. At length, the smoke and steam having somewhat subsided, two of the men, who had only left the place a minute or so before, and two or three other labourers, contrived to make a descent to where the poor creatures were imprisoned, and the sight which presented itself was truly horrible. The engine-room was a small brick chamber, about 8ft. by 12ft., at the basement of the mills. A glance at the boiler clearly showed that some portion of it had exploded, and had sprung forward from its bed of brickwork four or five feet, and that the inner part of the boiler, with the massive iron bars of the furnace and other plates had been blown out, as if from a cannon's mouth, direct at the poor fellows who were at work only some four or five feet in front. Of the ten unhappy creatures who were in this chamber, not one escaped. Two or three were dashed against the brick wall and killed on the spot, their skulls being driven in by the iron bars and pieces of boiler which were scattered by the explosion. Others were frightfully burnt and scalded, and bleeding from fearful gashes on their heads and other parts of their body. The boiler was a Cornish one, and had not been in use any length of time. It is stated that the pressure at which it had been worked during the day was from 40lbs. to 50lbs. the square inch, considerably below that at which it had been worked, while it had been tested to a pressure equal to 100lbs. The safety-valve, and the other gear which would

have assisted in arriving at the true pressure, appear to have been carried away, and it is feared that there will be some difficulty in eliciting the truth, as all those who could have given the information have fallen victims.

THE RESIDENTS OF NEWGATE-STREET and its immediate vicinity were, on the morning of the 16th ult., startled by a loud report, as of the firing of cannon. The premises in question, situate at 14, Bath-street, Newgate-street, were opened, as usual, soon after six o'clock, and a steam circular sawing machine, between three and four horse-power, was set in motion. Everything proceeded satisfactorily until about twenty minutes past nine o'clock, when the boiler of the machine suddenly burst with a loud report. Several of the workmen were thrown to the ground with great violence, and the fire and boiling water were scattered about in all directions. Part of the premises were then found to be on fire, the lighted coke having ignited some shavings. Two men and a boy, at the time of the explosion, were working in the cellar where the boiler burst. One of the men was found to be frightfully burnt and scalded about the head and hands. The other man had a very bad cut over his lips, and was also much scalded. The whole of the shutters, with the ship front, and also the windows of the first and second floors of the premises, were blown out, and the skylight and roof of the house were also forced off. Some damage was also done to the windows, skylight, and other parts of the premises opposite. Several parts of the flooring of the shop where the explosion occurred were entirely forced out, as well as many of the stairs, and the planks of wood in the place were shattered to splinters. The London Fire Brigade having arrived, the flames were soon extinguished.

THE ASSOCIATION FOR THE PREVENTION OF STEAM BOILER EXPLOSIONS.—At the last ordinary monthly meeting of the Executive Committee of this association, held at the offices, 41, Corporation Street, Manchester, on August 27, 1861—W. Fairbairn, Esq., C.E., F.R.S., President, in the chair—Mr. L. E. Fletcher, chief engineer, presented his monthly report, from which we have been furnished with the following extracts:—During the past month the ordinary visits of inspection have been made and the following defects discovered:—Fractures, 9; corrosion, 12; safety-valves out of order, 11; pressure gauges out of order, 8; blow-off cocks out of order, 3 (1 dangerous); furnaces out of shape, 5 (2 dangerous); over pressure 5—total 53 (3 dangerous); boilers without glass water gauges, 53; without pressure gauges, 2; without blow-off cocks, 6; without back pressure valves, 33. Three boiler explosions have occurred during the last month, from which loss of life resulted, in every instance, as well as serious injury to several persons. Not one of these boilers, however, was under the inspection of this association. I have examined the remains of two of them, and have found that both boilers were of the plain double-flued cylindrical construction, such as are in general use in Lancashire, and that explosion had resulted in each of them from collapse of one of the internal furnace or fire tubes. The first of these boilers was 33ft. long, the diameter of the shell being 7ft. 9in., and of the internal flue, 3ft. 2in., while the thickness of the plate, both in the cylindrical part of the shell as well as in the internal flue, was three-eighths of an inch. This boiler had been worked at a pressure of 50lbs. on the square inch, and at the time of explosion was stated to have been working at upwards of 40lbs., its age being 10 or 11 years. The second boiler was 30ft. long, the diameter of the shell being 7ft. 6in., that of the internal flues, 3ft., while the plates of the cylindrical part of the shell were seven-sixteenths thick, and of the internal flues three-eighths of an inch. The pressure at which this boiler was worked, and at which it was stated the valves were blowing off at the time of the explosion, was 63lbs. to the square inch, the boiler being about 5 years old. Neither of these boilers, even when new, were equal to the pressure at which they were worked at the time of the explosion, and must, therefore, for some time have been working in imminent danger. The internal flues were parallel throughout their entire length, and in neither case, and in neither case strengthened by angle iron hoops, T iron hoops, or any other means, while they were considerably coated with incrustation, which thus greatly increased the danger. All boilers of such proportions as the above are weaker in the flues than in the shell, and since the strengthening of these internal flues can be so readily accomplished by the hooping referred to above, while the results of collapse are so disastrous, it appears to me that it is running a most unwise hazard to neglect the simple precaution of strengthening the flues in this way, however slight the pressure may be. I may add that incrustation on internal flues should be considered not merely as a matter of inconvenience but frequently of positive danger. Competent inspection would have detected the dangerous condition of these boilers, and prevented the disastrous results, while for want of such inspection many boilers may be in a similar condition quite unknown to their owners.

MINES, METALLURGY, &c.

TREATMENT OF POOR COPPER ORE.—An invention of an interesting nature has lately been introduced by M. G. D. Mease, of South Shields, for treating poor copper sulphides for the economic production of sulphuric acid, and at the same time the separation of such copper and silver as may be contained in the ores. The ore is burnt in an ordinary pyrites kiln, but steam is passed through the ore whilst it is burning. This favours the formation both of sulphate of copper and peroxide of iron. The sulphurous acid gas is mixed with nitrous gases, and passed into the leaden chamber, as is usual in the manufacture of sulphuric acid. The copper not converted into sulphate is mixed with protosulphate of iron, or with crude ore or sulphur, and the mixture exposed to heat and moisture. The copper in the sulphate of copper is dissolved out with water, and precipitated by passing the solution over metallic iron, and the solution of protosulphate of iron is evaporated, and a portion of the salt crystallized out. The mother liquor is the solution of protosulphate of iron, which is employed for mixing with the burnt ore. The inventor also proposes a chlorine process, the chief feature of which appears to be the use of waste manganese liquor, which contains both chloride of iron and hydrochloric acid. The silver ores are treated by converting the silver with sulphate or chloride by a similar process.

METEORIC IRON.—A great quantity of native iron, which, from its containing cobalt and nickel, may safely be considered of meteoric origin, has been found in Peru, at a distance of about twenty leagues from the port of Cobija, in large masses imbedded in the mountain in the neighbourhood of the village of San Pedro, and scattered over the plain at the foot of the mountain in question, for a distance of three or four leagues, and, sometimes in fragments of considerable magnitude. It seems, from specimens, to be entirely similar to the Siberian mass of native iron, which hitherto has stood unrivalled.

THE OIL SPRINGS OF CANADA AND THE UNITED STATES.—The great value of these oil springs appear to be confirmed by numerous advices. In Canada the chief deposits are about twelve miles from the Wyoming Station of the Great Western of Canada Railway, and some arrangements will be necessary for the transit over that distance, the existing roads being of the worst description. At present there are full 100 wells in operation, all yielding oil. The wells are sunk and cribbed to a depth of from 40ft. to 60ft. till the rock is reached. In many cases surface oil is found before reaching the rock, but it is of rather inferior quality and of doubtful yield. After arriving at the rock, the wells through the carb being from 4ft. to 7ft. square they drill to a depth of from 40ft. to 70ft., between which distance oil is almost sure to be discovered. Wooden tanks, varying in size, are constructed close to each well. The oil is pumped into these, and afterwards drawn off into barrels to be sent to market. A well can be sunk, a tank for 100 gallons made, and a pump and all necessary appliances provided, for a sum equal to about £100 sterling. When oil is found, a man at 4s. a day can readily pump 100 barrels or 4900 gallons per day. The cost of the oil, including every expense, is, it is alleged, absolutely less than a halfpenny sterling a gallon delivered into the tank alongside the well.

APPLIED CHEMISTRY.

RECIPROCAL RELATIONS OF ATOMIC WEIGHTS.—Stas has just published the results of ten years' experiments, made with the view of testing the truth of Prout's theory—that the atomic weights of all simple bodies are divisible by that of hydrogen. These experiments, we are informed, have been conducted with a care and perseverance never surpassed in the history of experimental investigation, and the conclusion which Stas has arrived at is, that there is no common divisor for the equivalent weights of the simple bodies, and he expresses his conviction that Prout's law, and the latter modification of Dumas, are untenable. The differences in the numbers Stas has obtained are not very great, but some of his conclusions are important. We shall return to the work soon for further details, and for the present only quote two or three of the corrected numbers:—

Potassium, 39.13	...	Silver, 107.943	...	Nitrogen, 14.041
Sodium, 23.05	...	Chlorine, 35.46	...	Sulphur, 16.0371

RUBASSE.—A beautiful red-coloured stone has lately been popular in Paris, and brought high prices to the jewellers. Schaffgotsch examined a specimen, and found that, when placed in ammonia, it soon lost its beautiful colour, and became a simple piece of rock crystal. It was, indeed, a specimen of quartz, the minute fissures in which had apparently been filled with a solution of carmine.

FORMATION OF FUMIC ACID.—The formation of fuming acid, so important, apparently, to the nutrition of plants, has received a long investigation at the hands of M. Paul Thenard, the discoverer of it, who has come to the conclusion that it is a compound of ammonia or certain ammoniacal salts with vegetable principles. He wetted straw, dry leaves and sawdust, with ammonia, and the carbonate and sulphate, and found that it

was formed in abundance. He found also, that when glucose, or sugar, was heated in a tube nearly to the temperature at which it decomposes, and a current of ammoniacal gas was passed, a large quantity of the ammonia was absorbed, and substances produced resembling fuming acid. That formed from glucose was of a brown colour, was soluble in water, acids, and alkaline solutions, but insoluble in alcohol. That formed from cane sugar was brown, uncrystallizable, soluble in alcohol, and insoluble in water. Carbonic and the other acids dissolved it freely and alkalies precipitated it from the solution. Another body formed with the last had similar properties, but was insoluble in alcohol. The analyses of these three bodies gave the following results:—

	I.	II.	III.
Carbon	52.28	65.66	54.26
Hydrogen	6.38	6.05	5.34
Nitrogen	9.94	19.36	18.78
Oxygen	31.40	8.93	21.61

Similar substances to the above were formed when starch, mannite, cane sugar, or sugar of milk was heated with liquid ammonia in a sealed tube. When syrup was heated with liquid ammonia to 180° Centigrade, carbonate of ammonia, a black liquid and a black solid substance were formed, the two last of a very complex nature. The author speculates on the constitution of these bodies, admitting that he has but incompletely studied them. We do not, therefore, quote his speculations. He mentions a fact, however, which may be of value to some of our readers. A farmer, near Chalons, sprinkles his dung-heaps with ammoniacal gas liquor, and thereby obtains an excellent manure. The gas liquor used in this way producing a much better effect than when applied directly to the soil. M. Thenard examined the dung-heaps and found an abundance of fuming acid, or rather fumate of lime.

APPLICATIONS FOR LETTERS PATENT.

Dated August 27, 1861.

- 2131. Z. Colburn, Bedford-square, Middlesex—Arrangement and combination of high and low pressure steam engines.
- 2132. E. Peltier, Paris—Manufacture of metallic boxes, and in machinery employed thereby.
- 2133. L. M. F. Patureau, Paris—Thread protecting clew box.
- 2134. J. Smith and W. Smith, Keighley—Spindles and flyers used in machinery for spinning and twisting fibrous substances.
- 2135. J. C. C. Azémar, London—Instrument to facilitate the practice of the drum.
- 2136. J. B. Foudu, Lodensart, Belgium—Construction of fire grates for steam and other boilers, and suitable to all kinds of fires.
- 2137. J. H. Johnson, 47, Lincoln's-inn-fields, Middlesex—Dampers for stamping purposes.
- 2138. R. A. Brooman, London—Construction of temples or stretching rollers for looms.
- 2139. J. M. Hart, London, R. Lavender, Hornsey—Handles or knobs of locks and latches, and in the means of applying them.

Dated August 28, 1861.

- 2140. A. Granger, Holborn—Shirt collars and fronts, wristbands or cuffs, neck ties, or other similar articles of wearing apparel.
- 2141. J. Ronald, Liverpool—Dressing hemp, flax, manilla, and other like long fibrous material.
- 2142. B. Brown, London—Concentrating ores or tailings or separating pulverised mineral substances of different kinds or qualities from each other.
- 2143. W. S. Guinness, New York—Sewing machines.
- 2144. T. Bray, Dewsbury—Ornamenting wood in imitation of inlaid wood.
- 2145. S. Carpenter Banbury, Oxon—Construction of carriage wheels.
- 2146. J. Duncan, Greenock—Manufacture of sugar.
- 2147. M. Thielér, Einsieden, Switzerland—Type printing telegraphs.
- 2148. S. Corbett, Wellington—Mills for crushing and grinding mineral and vegetable substances, and for hulling or shelling beans and oats and other grain and seeds.
- 2149. J. Harding, Manchester—Inversna capé.
- 2150. J. Love, Grosvenor-square—Signal.
- 2151. V. A. Janvier, New North-road—Fastenings for gloves, belts, and other articles.
- 2152. P. Jewell, Brighton—Concertinas.

Dated August 29, 1861.

- 2153. A. V. Newton, 66, Chancery-lane—Cleaning rice and other grain.
- 2154. R. Penrose, Halifax—Screw stocks and dies.
- 2155. L. D. Owen, 481, New Oxford-street, Middlesex—Ploughs.
- 2156. R. Shaw, Portlaw, Waterford—Windlasses, capstans, and other machinery for hoisting and lowering weights.
- 2157. A. J. Daumont, Paris—Improved umbrella.
- 2158. S. Pluchart, Paris—Beverage called "Moka-beer."
- 2159. A. Taille, Agen—Manufacture of manure.
- 2160. W. E. Gedge, Middlesex—Thrashing machines.
- 2161. H. W. Spencer, Steney Causeway, Middlesex—Manufacture of animal oils, the said improvements relating more particularly to the processes of refining them to be used for lubricating purposes.
- 2162. J. S. Matthews, Kennington-park—Manufacture and preparation of starch.
- 2163. J. Harris, Hanwell, Middlesex—Stopping or retarding railway and other carriages and trains, locomotive and stationary engines and machinery, together with apparatus employed therein, which apparatus is applicable to the raising and lowering of weights and other purposes for which power is required.
- 2164. H. Lecauday, Paris—Apparatus for succouring persons interred before life is extinct.

- 2165. C. Worms and J. Warburton, Bradford, Yorkshire—Treating animal fibre recovered from rags, composed of mixed animal and vegetable fibre.
- 2166. J. Bishop, Camden Town, Middlesex—Manufacture or weaving of velvet or other pile fabrics.
- 2167. H. Brand, Guildford-place, Clerkenwell—Mattresses formed with springs.
- 2168. W. Clark, 53, Chancery-lane—Shirts and chemises.
- 2169. W. Hensman, Woburn, Bedfordshire, and W. Hensman, Linsdale, Buckinghamshire—Apparatus for tilling land by steam power.
- 2170. H. Keach, Holloway, Middlesex—Ornamentation of woven and other fabrics for garments and parts of garments.
- 2171. P. Taylor, Hulme, Manchester—Apparatus for removing the sediment from and preventing incrustation in steam boilers.
- 2172. T. M. Jones, Great Pulteney-street, Middlesex—Apparatus for suspending and turning meat, fowls, and such like articles for roasting.
- 2173. W. Southwood, Lambeth, Surrey—Boots and shoes or parts thereof.
- 2174. C. Pemberton, Deptford, Kent—Railway, ship, and other signals.
- 2175. J. Copple and E. Copple, Eccleston, Lancashire—Apparatus to prevent over winding at coal and other mines.
- 2176. E. J. Hughes, 123, Chancery-lane—Collecting the gases which escape from furnaces.
- 2177. J. Jones, Liverpool—Clasps or fastenings for garments, belts, harness, and like articles.
- 2178. W. A. Gilhe, Finshury, Middlesex—Process and apparatus for the manufacture of steel.
- 2179. J. M. Dunlop, Manchester—Cleansing cotton seeds, and in machinery used for such process.
- 2180. W. Fox, Amiens, France—Parasols and umbrellas.
- 2181. C. W. Siemens, No. 3, Great George-street, Westminster—Apparatus employed in connection with electric telegraphs, part of which improvements are also applicable to ascertain the heat in inaccessible places.
- 2182. F. Curtis, Bilston, Staffordshire—Forming or shaping woollen or mixed fabric hoot tops or uppers from flat woven material.
- 2183. G. E. Goransson, Gefle, Sweden—Manufacture of tyres for railway wheels, part of the said improvements being applicable to the consolidating or rendering homogeneous iron and steel for other purposes.

Dated September 2, 1861.

- 2184. T. S. Stock, and J. S. Stock, and H. Taylor, Birmingham—Tap or stop cock.
- 2185. W. Clark, 53, Chancery-lane—Signal apparatus applicable for the prevention of railway train collisions.
- 2186. W. Muller, 62, High Holborn—Roasting coffee.
- 2187. J. Hall, Oldham, Lancashire—Portable pumps or engines for extinguishing fires and other purposes.
- 2188. J. Watson, Glasgow—Furnaces.
- 2189. E. Acan, Coleman-street Buildings, London—Machinery for carding and combing wool and other filamentous substances.
- 2190. A. N. Saleres, No. 170, Rue de Charonne, Paris—Printing and coloring paper, chintz, and other fabrics and machinery or apparatus for that purpose.
- 2191. G. Knight, Foster-lane, London—Giving lustre to written and printed letters, figures, and devices.
- 2192. W. Campion and H. Johnson, Nottingham—Apparatus for cutting the selvages or edges of knitted or other fabrics while being stitched.

Dated September 3, 1861.

- 2193. D. Ward, Beaminster—Machinery for twisting and laying flax, hemp, and other fibrous materials.
- 2194. J. Gresham, Manchester—Mechanism or apparatus for facilitating the stopping and starting of omnibuses and other vehicles.
- 2195. E. Suckow and E. Abel—Machinery or apparatus for producing a strong blast or current of air.
- 2196. P. Robertson, Sun-Court, Cornhill—Treating yeast, and the manufacture of ammoniacal salts and a substitute for animal charcoal.

- 2197. G. Bischof, jun., Swansea—Extracting copper and silver from ores containing those metals.

Dated September 4, 1861.

- 2198. A. White, Missenden, Buckinghamshire—Apparatus for stopping railway trains.
- 2199. T. Scott, Newcastle, Ireland—Construction of roadways.
- 2200. R. A. Brooman, 166, Fleet-street—New or improved parachute toy.
- 2201. W. E. Newton, 66, Chancery-lane—Self-acting brakes applicable to railway or locomotive engines and carriages.
- 2202. L. R. Lodmer, 2, Navies-inn, Holborn—Distilling apparatus.
- 2203. F. E. Schmieder, Paris—Cartridges for breech-loading fire arms, and in the machinery for manufacturing of the same.

Dated September 5, 1861.

- 2204. J. K. Bayley, Bolton-le-Moors, Lancashire, T. Harrison, of the same place, Carder, W. Briggs, of the same place, and R. Parker, of Atherton—Machinery for preparing and spinning cotton and other fibrous materials.
- 2205. H. Young, Birmingham—Counter or pillar beer engines.
- 2206. R. McConnel, Glasgow—Locks.
- 2207. J. M. Rowan and T. R. Horton, both of Glasgow—In steam hoilers and surface condensers.
- 2208. C. Edkins, Birmingham—Ladies' dress suspenders.
- 2209. J. E. Ridges, Wolverhampton, and J. Barker, Birmingham—Composite carriages for funeral and other purposes.
- 2210. D. Heyworth, Littleborough, Lancashire, and J. Heyworth, Manchester—Looms for weaving.
- 2211. P. Effertz, Manchester—Machinery or apparatus for making bricks, tiles, drain pipes, and other similar articles.
- 2212. J. T. Pensam, 55, Stamford-street, Blackfriars—Wheels for facilitating the progress of carriages on common roads, and the means of propelling the same.
- 2213. F. Bennet, Bagilt, Flint—Method of coating the interior surface of lead and lead composition pipes with tin or its alloys.
- 2214. W. Patey, jun., Lombard-street, and J. Richardson, Clerkenwell—Manufacture of brushes.
- 2215. T. Scott, Newcastle, Ireland—Utilising the surplus momentum of railway trains and other moving bodies, and the waste and surplus power of locomotive and other engines.

- 2216. J. Napier, Glasgow—Manufacture of armour plates for the protection of vessels of war, floating or other batteries.
- 2217. J. Napier, Glasgow—Apparatus for cooling the water employed for condensing steam or other purposes.
- 2218. J. Napier, Glasgow—Machinery for rolling iron or other metals.
- 2219. C. W. Harrison, Brixton, Surrey—Construction of castors.
- 2220. T. Greenwood, Leeds—Machinery for sawing wood.
- 2221. J. Reid, Leith—Treatment of gas, and the apparatus employed therein, with a view to its more accurate measurement in wet gas meters.

Dated September 6, 1861.

- 2222. M. A. F. Mennons, Paris—Smoke consuming furnaces.
- 2223. M. A. F. Mennons, Paris—Ribbon looms.
- 2224. M. A. F. Mennons, Paris—Obtaining and applying motive power.
- 2225. W. Spence, 50, Chancery-lane—Apparatus for dividing and softening vegetable fibres.
- 2226. W. Allott, and J. Thelwall, Hull—Manufacture of wheel tyres and hoops.
- 2227. W. Allott and J. Thelwall, Hull—Manufacture of crank shafts and crank axles, and other similar articles.
- 2228. E. J. Hughes, 123, Chancery-lane—Watches.
- 2229. C. F. Kirkman, Lambeth—Obtaining manure from sewerage, and in apparatus employed therein.
- 2230. J. J. Russell, Wednesbury—Preparing the ends of welded tubes previous to their being fixed in plates.
- 2231. J. Brown, Burnley—Power looms for weaving.

2232. W. Wild, Bury—Machinery to be employed in the preparation of cotton and other fibrous materials for spinning, called "slubbing frames and roving frames."
2233. E. Harrison, Oldham, and T. S. Yates of the same place—Certain compounds to be used as a substitute for gunpowder.
2234. M. Henry, 84, Fleet-street—Signalling on railways.
2235. T. G. Messenger, Loughborough—Glazing Horticultural buildings, the roofs of railway stations, and other erections.

Dated September 7, 1861.

2236. E. Taylor, Blackburn—Obtaining motive power.
2237. W. Ainsworth, Adlington, E. Heap, W. Fielding, and E. Openshaw, of the same place—Power looms for weaving.
2238. N. D. P. Maillard, Dublin—Material and preparation of the material and apparatus for making potash, pearlsh, and caustic potash of commerce.
2239. J. Carpendale and T. Middleton, Sheffield—A machine to produce raised chasing on copper, silver, and Britannia metal by the application of pressure.
2240. G. Norris, Kilburn—Manufacture of soap.
2241. J. Holland, Manchester and G. Okell, of Ashton-under-Lyne—Apparatus by which an engine or train is made to give an alarm or signal at any required place on arriving at or passing any given point on the railway.
2242. H. Redgate, Nottingham—Manufacture of skirts usually called crinoline skirts.
2243. R. O. White, Blackheath Park, Surrey—Manufacture of bricks.
2244. G. H. Birkbeck, 34, Southampton-buildings—Construction of saddles.

Dated September 9, 1861.

2245. G. Malcolm, Dundee—Apparatus for softening or treating jute, flax, or other similar fibrous substances.
2246. W. Simons, Renfrew—Ships or vessels.
2247. W. Dowell and J. Dowell, Rhyll—A new or improved motive-power engine.
2248. P. B. O'Neill, Bloomsbury—Screw wrenches or spanners.
2249. A. Fryer, Sutton, Lancashire—Propellers and propelling vessels through water.
2250. J. H. Johnson, 47, Lincoln's-inn-fields—Fire grate and furnaces for domestic and other purposes.
2251. J. H. Johnson, 47, Lincoln's-inn-fields—Machinery for making cigars.
2252. C. Cheyne, Westminster—Extinguishing fires in buildings.
2253. R. A. Brooman, 166, Fleet-street—Producing mixed coloured woollen and other threads.
2254. W. E. Newton, 66, Chancery-lane—Boots and shoes.

Dated September 10, 1861.

2255. J. Anthony, Poplar—Steam boilers and generators.
2256. T. S. Tyson, Leeds—Lubricator applicable to corves or waggons.
2257. J. Smith, London-wall—Sewing machines.

Dated September 11, 1861.

2258. L. P. Barté, Paris—Tubular steam boilers.
2259. R. Restell, Croydon—Connecting and disconnecting engines and tenders to and from trains.
2260. W. L. Thomas, Berkeley-square—Projectiles.
2261. J. Browns, Earlston, Warrington Junction—Railway wheels and railway breaks.

Dated September 12, 1861.

2262. G. H. Birkbeck, Chancery-lane—Needles.
2263. J. A. Dauncey, Manchester—Gloves, collars, and wristbands.
2264. W. Stevens, Hammersmith—Apparatus for ploughing and cultivating of the land by steam and other power.
2265. C. Greaves, Bow—Preventing waste of water from service pipes or cisterns.
2266. A. Turner, Leicester—Enabling the guards and drivers of railway trains to communicate with each other.
2267. M. A. F. Mennons, Paris—Production of Valenciennes, Chamilly, Brussels, and other similar laces.
2268. M. A. F. Mennons, Paris—Combination of chemical and mechanical processes for the conversion of fibrous vegetable matters into the paper pulp.
2269. W. W. Clay, Nottingham—Knitting machinery.
2270. W. E. Gedge, Wellington-street, Strand—Nautical compass.

Dated September 13, 1861.

2271. J. Oliver, Longtown—Machinery for making bricks, pipes, and tiles.
2272. W. Davis, Snow-hill, Birmingham—The prevention of accidents arising from affrighted horses.
2273. W. Farlar, Turnham-green, Middlesex—Sash fastenings.
2274. W. H. Delamare, 14, Clarence-place, Hackney-road—Machine for purifying and peeling corn.
2275. P. Dubrule, Tourcoing, France—Weaving.
2276. R. Smith, Weymouth Cottage, Hornsey, B. Brooks, 2, Albert-terrace, York-road, King's-cross, and J. Smith, 2, Oak-villas, Wood-green, Tottenham—Construction of roof and other lights.
2277. G. C. Haseler, 2, Vittoria-street, Birmingham—Lockets.
2278. R. Fell, Kingsland—Compressing and rarefying atmospheric air with machinery for applying the same to obtain a motive power.
2279. R. A. Brooman, 166, Fleet-street—Machinery for weighing and measuring corn and other grain.

2280. T. L. Murray, Paris—Application of mica previously coloured to various useful purposes.
2281. J. B. Howell, Sheffield—Manufacture of chains and cables.
2282. C. Sutton, Salford, Lancashire—Indicating the position of sunken or other such vessels.
2283. H. Dixon, Pendleton, and J. R. Renner, Liverpool—Carbonising saw dust and other vegetable substances.
2284. W. E. Newton, 66, Chancery-lane—Guns.

Dated September 14, 1861.

2285. G. Dixon, Wood-street—Manufacture of upholsterer's trimmings.
2286. J. A. Knight, 4, Symond's-inn, Chancery-lane—Apparatus for rendering fatty or oleaginous matter.
2287. W. H. Crispin, Marsh Gate-lane, Stratford—Manufacture of curved and angular tubes and pipes.
2288. R. Waller, 50, Baker-street, Portman-square—Apparatus for manufacturing and refining cane juice.
2289. W. Wheatstone, 20, Conduit-street, St. George's, Hanover-square—Concertinas and other musical instruments.
2290. J. Led, Wildnes Dock, near Warrington—Self-acting signals for railways.
2291. J. King and J. Sutcliffe, Rochdale—Machines for spinning and doubling.
2292. F. Barnett, 60, St. Mary Axe—Automatic electric signals to prevent collisions on railroads.
2293. M. A. F. Mennons, 39, Rue de l'Exchiquier, Paris—Surgical instrument.
2294. A. Green and H. Glover, Stourbridge—Manufacture of vice boxes.
2295. H. C. Jennings, Great Tower-street—Treating hides and skins.
2296. G. Hawksley, Three Mill-lane, Bromley-by-Bow—Traction and locomotive engines.
2297. W. E. Newton, 66, Chancery-lane—Apparatus for checking carriages when going down hill.
2298. T. Morris, R. Wear, and E. H. C. Mockett, 4, Trafalgar-square—Batteries for obtaining electric currents.
2299. T. Webb, Artillery-terrace, Victoria-street—Receptacles for money.

Dated September 16, 1861.

2300. S. Horsley and E. H. Jones, Liverpool—Apparatus for cleaning hoots.
2301. M. Rae, Manchester—Lamps.
2302. W. E. Gedge, 11, Wellington-street, Strand—Apparatus for drying grain.
2303. J. Reeves, New York—Electro-magnetic engines for obtaining and applying motive power.
2304. T. Meriton, Second Benard Strasse, Saint Pauli, Hamburg—Steering apparatus.
2305. W. J. Hesketh and D. Parsell, Saundersfoot—Steam boilers.
2306. W. Clark, 53, Chancery-lane—Application of mica to ornamental and other purposes.
2307. G. Fry, Great Portland-street—Sights for rifles and other fire-arms.
2308. W. Stewart, Peckham—Apparatus for supporting persons in water.
2309. A. M. Skinner, Belfast—Propelling ships' boats and other vessels.
2310. R. A. Brooman, 166, Fleet-street—Apparatus for stretching, supporting, and uniting telegraph wires.
2311. R. A. Brooman, 166, Fleet-street—An improvement in shirts.
2312. F. M. Ransome and E. D. Ransome, both of Ipswich—Treating stone, bricks, and other surfaces.
2313. W. Tuxford, Boston—Thrasing machines.

Dated September 17, 1861.

2314. B. Samuelson, Banbury—Harvesting machines.
2315. F. Wrigley, Manchester—Mode of securing armour for the protection of ships and fortifications against projectiles.
2316. F. Barnett, 60, St. Mary Axe—Street and other lamps.
2317. J. Eastwood and J. Joyce, Bradford—Apparatus for combing wool.
2318. F. J. G. D'Olimcourt, 113, Rue de Flandre, Paris—Cultivating land.
2319. G. Davies, 1, Serle Street, Lincoln's Inn—Apparatus for the manufacture of horse-shoe and other nails.
2320. J. Statham, Salford, and W. Statham, Openshaw—Apparatus for mowing and reaping.
2321. J. Lee and B. D. Taplin, Patent Crank Works, Lincoln—Traction engines.
2322. A. H. Bailey, Boston, Massachusetts, United States—System of combination types.

Dated September 18, 1861.

2323. G. White, 7A, Pancras Lane—Apparatus for filtering or purifying water or other liquids.
2324. J. G. Briggs, Earl-street, Blackfriars—Making fire-proof buildings.
2325. W. Cory, jun. Coal Exchange, London—Machinery for unloading colliers.
2326. E. A. Cooper, 35A, Great George-street, Westminster—Apparatus for freeing gases from dust and other particles of matter floating therein.
2327. H. Wickens, 4, Tokenhouse-yard, Bank—Reaping and mowing machines.
2328. E. Parlington, Heap-bridge, Lancashire—Apparatus employed in the manufacture of paper.
2329. A. J. Beer, Canterbury, Kent—Valves of steam engines.
2330. G. Ferry, Hoxton—An improved anchor.

2331. E. Suckow and E. Habel, Manchester—Apparatus for opening and cleaning cotton and other fibrous substances.
2332. J. Gurman, Onslow-road, Southampton—Hanging window sashes to facilitate their removal for cleaning.
2333. L. G. A. Condroy, Douai, France—An improved centrifugal apparatus.
2334. J. Clough, Bolton-le-Moors—Machinery for preparing cotton or other fibrous substances.
2335. J. C. Coombe and J. Wright, 42, Bridge-street, Blackfriars—Manufacture of stones, bricks, tiles, slabs, statuary, and such like materials.
2336. J. Durrant, Granville-terrace, Lewisham—An improved form of coal box.
2337. C. W. Eddy, Chester-terrace, Regent's-park—Arming the bow of a ship of war with a shell and a beak to be fitted or unfitted at pleasure, and to be used conjointly or separately.
2338. E. Clark, Chatham-street, Liverpool—Apparatus for preventing accidents on railways.
2339. E. Breffit, King William-street—An improved fuel.

Dated September 19, 1861.

2340. W. Clark, 53, Chancery-lane—Machinery for the manufacture of fishing and other nets.
2341. W. T. Tongue and J. Greer, Liverpool—Water-engine for extinguishing fires.
2342. J. H. Wilson, Liverpool—Pumps.
2343. T. Silver, Philadelphia, United States, and T. Moore, 33, Regent-circus, Piccadilly—Construction of and appliances to steam ships or other vessels.
2344. J. Graham, 2, Ann-street, Devonport-street, Commercial-road, East—Force or lift pump for ships, fire-engines and other purposes.
2345. S. Hawksworth, Doncaster—Manufacture of floor-cloth.
2346. A. J. Sedley, 210, Regent-street—Metallic bedsteads and sofa bedsteads.
2347. R. P. P. Dagron, Paris—An improved microscope to be used for exhibiting photographic views and productions.
2348. T. Redwood, 19, Montague-street, Russell-square—Manufacture of paper.

Dated September 20, 1861.

2349. T. M. Gladstone, Parliament-street, Westminster—Construction and form of anchors.
2350. B. Smith, Birmingham—Taps and cocks.
2351. J. Oliver, Colchester, J. Grantham, 3, Nicholas-lane, J. Simcock, Woodford, and M. R. Levenson, 12, St. Helen's-place—Mode of obtaining certain chemical substances, and in the treatment of vegetable fibre, and in obtaining manurial and other products.
2352. H. Walter and D. Johnstone, Manchester—Castors.
2353. J. C. Davidson, Yalding—Thrashing machines.
2354. C. Perman, Salisbury—Machinery or apparatus for cultivating land.
2355. J. Burnand, Sheffield—Fastening or securing the handles of table knives and forks, daggers, and other similar articles, part of which invention is also applicable to ladles.
2356. G. Roberts, 28, Bessborough-place, Pimlico, and F. Lamb, Broad-street—Improvements in lamps and lamp wicks.
2357. W. G. Creamer, New York—Railway brakes, and apparatus for actuating the same.
2358. G. T. Bousfield, Brixton—Machinery for combing cotton and other fibrous material.
2359. F. W. Wymer, Newcastle-on-Tyne—Apparatus used in sounding the holds of ships.
2360. G. T. Bousfield, Brixton—Machinery for manufacturing shoes for horses and other horses.

Dated September 21, 1861.

2361. L. R. Bodmer, 2, Thavies-inn, Holborn—Gaseliers, and ventilating apparatus connected therewith.
2362. C. Board, Bristol—Veneering presses.
2363. H. and F. C. Cockey, Frome Iron Foundry—Apparatus employed in the manufacture of gas.
2364. J. Fenton, Low Moor—Method of causing the water to circulate in boilers.
2365. W. Stableford, Oldbury—Manufacture of wheels, and in securing tyres to or on wheels.
2366. A. Parks, Birmingham—Castings, rods, bars, bolts, nails, rivets, and sheets when alloys of copper are used.
2367. W. Tongue, Bradford—Machinery for combing, hackling, and dressing fibrous materials.
2368. S. Desborough, St. Martin's-le-Grand—Pins for hair, dress, jewellery, and other purposes.

Dated September 23, 1861.

2369. J. H. Dunley, Northampton—Axle boxes and brushes.
2370. C. Stevens, 31, Charing-cross—Steel, and hardening metals.
2371. H. Plantrou, jun., Paris—Washing and scouring wools by the introduction of air into the water, using an aeriform washing apparatus.
2372. J. Kenyon, Blackburn—Treatment of yarns or warps previous to their being sized.
2373. H. Brinsmead, Ipswich—Apparatus for raising and stacking straw and other agricultural produce.
2374. V. Jankowski, Fitzroy-square—Carriages.
2375. A. A. Hely, Forest-hill—Portable fire-arms.
2376. J. Price, Dundalk—Permanent way of railways.
2377. J. Jacob, Brunn, Austria—Obtaining and treating gas, and the application thereof to various purposes, parts of which improvements are applicable to the manufacture of iron and steel.

No.	DESCRIPTION OF ENGINES.	REMARKS.
2232.	W. Wild, B preparation of spinning, called	
2233.	E. Harrison place—Certain gunpowder.	
2234.	M. Henry, 8 tural buildings,	
2235.	T. G. Mess erections.	
2236.	E. Taylor, B horizontal	Steam could not be maintained in consequence of the smallness of the coals.
2237.	W. Ainsworth horizontal	Light breeze from the water. Trial not at a measured knot but between Plymouth and Eddystone.
2238.	E. Openshaw, weaving horizontal, Trunk	Fresh breeze from the water.
2239.	N. D. P. Mac of the material and caustic potash horizontal, Trunk	Very light breeze from the water.
2239.	J. Carpendal to produce raise metal by the horizontal, Trunk	Trial not at a measured knot, but between Plymouth and Eddystone.
2240.	G. Norris, K horizontal, Trunk	Wind No. 3. Smooth water.
2241.	J. Holland, under-Lyng—App horizontal	Wind No. 2.
2242.	H. Redgate arriving at or usually called cri horizontal, Trunk	Wind No. 4. Slight rolling considerably.
2243.	I. O. White, of bricks horizontal, Trunk	Wind No. 3. to No. 4. Smooth water.
2244.	G. H. Birkhorst horizontal, Trunk	Wind No. 2. to No. 3. Half boiler power.
2245.	G. Malcolm, treating jute, flax horizontal, Trunk	Wind No. 1.
2246.	W. Simons horizontal, Trunk	Calm to No. 3. Smooth water.
2247.	W. Dowell an motive-power engine horizontal, Trunk	Calm.
2248.	P. B. O'N. spanners horizontal, Trunk	Wind No. 1. to No. 2.
2249.	A. Fryer, Sut pelling vessels horizontal	Wind No. 2.
2250.	J. H. Johns and furnaces for horizontal	Wind No. 2.
2251.	J. H. Johns for making cigars horizontal	Wind No. 5. to No. 6.
2252.	C. Cheyne, buildings, clined, Single Trunk	Boilers could not generate steam at the full pressure on the valves.
2253.	R. A. Broom, coloured woollen horizontal, Trunk	
2254.	W. E. Newton horizontal, Trunk	Smooth water.
2255.	J. Anthony, horizontal	Calm.
2256.	T. S. Tyson, L or waggons horizontal	Wind No. 3.
2257.	J. Smith, Long horizontal, Trunk	Wind No. 5. to No. 6. Boilers priming severely at times.
2258.	L. P. Barté, horizontal	Wind No. 4.
2259.	R. Restell, Cr engines and tender horizontal	Wind No. 3. to No. 6, with considerable swell on the beam.
2260.	W. L. Thomas horizontal	Wind No. 2.
2261.	J. Browns, Ear wheels and railway horizontal, Trunk	Wind No. 3.
2262.	G. H. Birkbeck horizontal	Wind No. 2. to No. 4.
2263.	J. A. Dauncey horizontal	Calm. Smooth water.
2264.	W. Stevens, Horizontal and cultivating of horizontal	Wind No. 4.
2265.	C. Greaves, B service pipes or cist horizontal	Wind No. 2. Sea smooth.
2266.	A. Turner, Leic horizontal	Wind No. 4. to No. 5. Slight wave. Four-bladed iron screw.
2267.	M. A. F. Menno of railway trains to Chantilly, Brussels horizontal	Wind No. 4. Sea smooth. Four-bladed iron screw. Half boiler power.
2268.	M. A. F. Menn and mechanical vegetable matters horizontal	Wind No. 4.
2269.	W. W. Clay, No horizontal	Wind No. 1. Half boiler power.
2270.	W. E. Gedge, compass horizontal	Nearly a calm.
2271.	J. Oliver, Long pipes, and tiles horizontal	Wind No. 5. to No. 6. Steam could not be maintained at more than 18 lbs. pressure.
2272.	W. Davis, Snow accidents arising from horizontal, Oscillating	Wind No. 3. High boiler only employed.
2273.	W. Farlar, Tu ings horizontal	Light breeze. High boiler removed from the vessel.
2274.	W. H. Delamar Machine for purifying horizontal, Trunk	Wind No. 5. to No. 6. Supply of steam deficient.
2275.	P. Duhrule, Tour horizontal	Wind No. 3. Steam could not be maintained at 20 lbs. pressure.
2276.	R. Smith, Weyn Albert-terrace, York Oak-villas, Wood-gr and other lights horizontal	Wind No. 3.
2277.	G. C. Haseler, 2 horizontal	Wind No. 4.
2278.	R. Fell, Kings atmospheric air with obtain a motive pow horizontal	Wind No. 2. to No. 3.
2279.	R. A. Brooman, weighing and measu horizontal	Wind No. 4.

THE ARTIZAN.

No. 227.—VOL. 19.—NOVEMBER 1, 1861.

RESULTS OF TRIALS MADE IN H.M.'s SCREW SHIPS AND VESSELS.

(Being a continuation of the table printed August 1856.)

By permission of the Lords Commissioners of the Admiralty, we are enabled to present with the present number a continuation—which was issued for private circulation at the end of August last—of the table of similar results published by the Admiralty in 1856, and republished in THE ARTIZAN March 1st, 1859.*

The success which attended the re-publication of the previous tables, has induced us to incur the great cost of reproducing such a vast amount of tabulated matter as that which we give this month.

It is with considerable satisfaction we observe the improvements which have been made in the forms of returns, and the additional items of information now for the first time furnished in the published results of Admiralty trials.

The following is the introduction accompanying the tables:—

The numbers in the last two figure columns of the Table show approximately the relative excellence, in respect of speed, of the forms of the various vessels, conjointly with the relative efficiency of the propeller, as adapted to each of them.

The formulæ by which the calculations are made are founded on the assumption that the resistance of a vessel varies as the square of her velocity, and therefore that the power required to produce that velocity varies as the cube, and that the useful effect of the engine, that is, the effect which remains after deducting the power absorbed in overcoming friction, working air-pumps, &c., bears a constant ratio to the power developed in the cylinder, known by the term "Indicated Horse Power." The resistance is, in the first of these columns, assumed to vary, *ceteris paribus*, as the area of the midship section, and in the last column as the square of the cube root of the displacement.

None of these assumptions, however, more especially the last two, are absolutely correct, but probably they are not so far from the truth as to render useless and uninteresting a comparison, of which they are the basis, made between the performances of any two screw vessels; while between two vessels which do not materially differ in engines and displacement, or in the area of their midship sections, such a comparison is not only highly interesting, but it may prove of great value in pointing out the forms of vessels and proportion of propellers which ought to be adopted. In some striking cases it is scarcely necessary to make any other comparison than that of speed. For example, as may be seen in the Table printed in 1850, the "Teazer," after her form had been improved, went above a knot an hour faster with 40-horse engines than she had previously gone with engines of 100-horse power. Again, these engines of 100-horse, when transferred to the "Rifleman," a vessel approaching to double the tonnage, drove her, after her form had been altered, as fast as she was previously driven by engines of double the power, and nearly two knots faster than the same engines drove the smaller vessel before the alteration of her after body.

Since the publication of the last Table screws with moveable blades, by means of which the pitch can be varied at pleasure, have been largely introduced in Her Majesty's Navy, and many experiments have been made in which the edges and the extremities of the blades were bent either

forward or back. In consequence of the irregularity of curvature thus occasioned, the pitch given in the Table cannot always be relied on as even an approximation to what may be called the mean pitch. This is doubtless the principal cause of the apparent discrepancies respecting the slip.

Admiralty, August, 1861.

THE LOSS BY FRICTION OF LOAD IN THE PRINCIPAL PARTS OF THE STEAM ENGINE.

By OMICRON.

The discussion of the modulus of the crank and crank guide extends over twelve pages of algebra and the calculus in Moseley's Engineering and Architecture. This method of investigation has prevented the majority of practical engineers from following out the train of argument presented by that able author. It is perhaps to be regretted that the formulæ established in that work have not been accompanied by numerical examples, the book could then have been appreciated alike by the engineer and by the mathematician. In the perusal of these pages I have been struck with the amount of learning which has been thrown away such on a simple matter. When will mathematicians cease to regard engineering subjects as convenient pincushions in which to stick their algebraic signs? How often do engineers turn to such works seeking bread and finding stones; perhaps they find out some kernels of truth, but they are generally encased in shells so thick that it will hardly pay to break them, and even then it is difficult to distinguish which is the kernel and which the shell. The mathematical investigation of engineering subjects has, no doubt, many advantages, but if complicated, a mistake may be readily committed, which may develop into errors of considerable importance. Another objection to the introduction of complex mathematical expressions into works of reference is that they are seldom free from errata, which annoy the student, and sometimes discourage him altogether. Which of the readers of this journal has perused with edification the mathematical part of "Bourne on the Screw Propeller?" The report of Bourgeois and Moll, as therein condensed, is about as good an example of this unsatisfactory state of things as I have met with. But some publishers care very little about the accuracy of their works, and one engineering annual appears regularly with stereotyped tables which are known by the publisher to contain above half a hundred errors, and no list of errata is furnished. When such things are perpetrated engineers should begin to demand a certificate of accuracy with works of reference. Moseley's *Engineering and Architecture* is a work almost free from errata. However, in the complication of algebra, trigonometry, and the calculus, which are brought to bear on this subject, there are one or two typical errors, and also what appears to me to be a reasoning on false premises, which of course has led to wrong conclusions. I do not ask the reader to accept of my verdict on the matter, and will present what I conceive to be a practical investigation of the whole question, and then compare the results with those given by Moseley.

The letters used will be,

b = The length of the connecting rod.

a = The length of the crank.

a_2 = Distance from centre of shaft at which the useful resistance is overcome.

$n = \frac{b}{a}$

P = Pressure on the piston.

P_2 = Pressure at point of useful resistance.

L = Length of the stroke.

r_1 = Radius of crank shaft journal, and to designate the centre thereof in Fig 1

r_2 = Radius of crank pin ditto ditto

r_3 = Radius of crosshead bearing ditto ditto

r_4 = Radius of shafting bearings.

f = Co-efficient of friction.

π = 3.1416.

$\frac{P}{g}$ = Weight of the shafting.

e = Half chord of dead arc of crank.

W = Weight on crank shaft bearing.

w = Weight on slide bar.

* These tables, printed in a separated form, mounted and varnished for office use, are still to be had at the Publishing Office, and of the Agents of THE ARTIZAN.

VESSEL

ENGINES

PROPELLER

RATIO OF

Main data table with columns: NAME, Tonnage, Date of Trial, Where tried, Length, Draught of Water, Forward, Aft, Area, Depth, etc. Includes vessel names like HEAD, HIMALAYA, HIGH, HORN, etc.

Continued on page 2

To simplify the first steps I will suppose that the power is transmitted through some length of shafting before it is applied to useful work. Also I will neglect the weight of the parts, and consider the pressure transmitted through the connecting rod to be a constant quantity and always equal to P, the pressure on the piston.

On these premises the pressure of the connecting rod on the CRANK PIN will be = P. This pressure runs round a complete circumference of the pin each revolution of the engine; the loss by friction on this surface will therefore be = $f P \times$ the circumference of the crank pin = $2 f P \pi r_2$.

The pressure on the CRANK SHAFT JOURNAL will be equal, opposite, and parallel to that on the crank pin and will describe a complete revolution on the surface of the journal for each revolution of the engine. The loss by friction will, as in the case of the crank pin, be = $2 f P \pi r_1$.

The pressure of the CROSSHEAD on the connecting rod will be also = P. It rubs twice over an arc of the crosshead bearing each revolution of the engine. That arc corresponds with the vibration of the connecting rod. When the connecting rod is four times the length of the crank, the length of that arc is to the length of its chord as 101 to 100 nearly; so that for our present object it will suffice to substitute the length of the chord for the length of the arc. The length of this chord will be the same part of the radius of the bearing that twice the length of the crank is of the connecting rod. As the pressure sweeps over the arc twice in a revolution the loss by the friction will be

$$\frac{4 r_3}{n} f P.$$

THE SLIDE BAR, Fig. 1. The pressure transmitted through the connecting rod can always be resolved into two components, one perpendicular to the slide bar and the other parallel to it. In the figure if b represent the pressure through the connecting rod it is resolved into $r_2 g$ perpendicular to the slide bar and $r_3 g$ parallel to it. This is true for any position, so

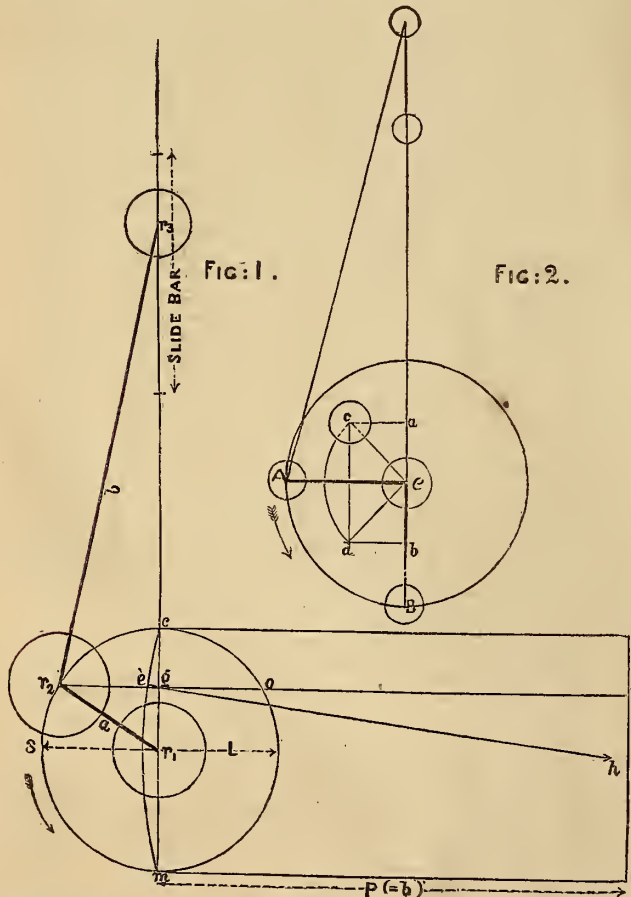

that the semicircle $c r_2 m$ is in fact a diagram of the varying pressure on the slide bar. The crosshead travels at one time slower, at another, faster than the rectilinear motion of the crank pin. These differences on the whole revolution or on each single stroke cancel each other, so that to

arrive at the product of the pressure and travel on the slide bar, it will suffice to take the rectilinear motion of the crank. The greatest pressure will be

$$s r_1 = \frac{P}{n}$$

and the area of the semicircle of pressure will be

$$.7854 s r_1 \cdot c m = \frac{.7854 P L}{n}$$

Twice this multiplied by f will be the loss by friction for a complete revolution

$$= \frac{\pi f P L}{2 n}$$

If the WEIGHT OF SHAFTING be = $\frac{P}{q}$, and if the radius of the journals be r_4 , supposing that there is no other pressure than that of weight, and that the shafting makes one revolution for each revolution of the engine, the loss by friction will be

$$= \frac{2 \pi r_4 f P}{q}$$

The total loss by friction on these surfaces will be found by adding these expressions to be

$$f P \left\{ \pi \left(2 r_1 + 2 r_2 + \frac{L}{2 n} + \frac{2 r_4}{q} \right) + \frac{4 r_3}{n} \right\}$$

This is the work lost, if we divide by $2 P L$, the total power, we will get a quotient free of P expressing the loss in decimal parts of the whole power. As the above calculation is for one cylinder only, in finding this quotient we must first divide the friction on the shafting by the number of cylinders. If there be two cylinders, as in the common direct acting screw engine, the loss by friction will be.

$$\frac{f}{L} \left\{ \pi \left(r_1 + r_2 + \frac{L}{4 n} + \frac{r_4}{2 q} \right) + \frac{2 r_3}{n} \right\}$$

in decimal parts of the total power.

WEIGHT OF PARTS. The friction arising from weight of parts is generally but a minute fraction of the power transmitted. In general, however, it does not appear as a part of the friction on an entire revolution, because the friction is as much decreased throughout one part of the revolution as it is increased in the other by the weight of the parts. This remark, however, applies only to the vertical engine, and it is there apparent that the weight of the descending parts in the down stroke adds to the pressure on the crank pin just as much as it takes from that pressure on the upstroke, and these act through equal parts of the revolution. The same remark applies to the metal weight on the crank shaft journal, it acts with the steam pressure through one half the revolution and against it in the other half. The weight of these parts of the vertical engine does not, therefore, affect the loss by friction. In the horizontal engine the weight of the parts acts at right angles with the direction of the engine pressure, and the pressure on the bearings will be compounded of the pressure by weight and that by steam. It is unnecessary to calculate the loss from this cause, but, if I entered into it, I would not compound the two pressures at all, but consider them acting independently of each other as if in square brasses, where the one pressure was borne by one side of the square and the other by an adjacent side. This would be equivalent to adding the weight on the crank pin to P for loss by friction on the crank pin, and including the weight on crank-shaft bearing with P in the calculation of its friction. If the pressure on the slide bar be downwards, the loss by friction is increased by an amount = $2 f w L$, which, expressed in parts of the whole power, is = $\frac{w f}{P}$. If the pressure be upwards, the loss is reduced by this amount.

Another case to be examined is where the power is applied to overcome a resistance in the same plane as the crank, or so near to it that the resultant of that resistance is upon the crank-shaft journals. When the direction in which the resistance is overcome is parallel with the direction of the piston, its resultant is cancelled when the whole revolution is taken together. If, however, the resultant of this resistance, and of the metal weight on the crank-shaft be together greater than P, this resultant must be substituted for P in the calculation of loss by the friction of the crank-shaft bearing. When this is the case, the pressure will always be borne by the same part of the bearing and rub over the circumference of the shaft. In the former case, when P is greater than this resultant, the pressure travels round the bearing, and is always on the same part of the journal.

THE DOUBLE CRANK. Suppose the engine to be vertical, and that the work to be done is a resistance of which the resultant is upon the crank-shaft bearing. When both cranks are upon the same side of the shaft, there is no difference in the conditions of friction from that of the single

crank. They are on the same side of the centre during half of the revolution, the loss by the friction during that half, if P be the pressure on each piston, will be $2fP\pi(r_1 + r_2)$, considering only the friction of the crank pin and crank-shaft bearing.

In the other two quadrants, the pressures being equal and opposite, will result in a moment of torsion only, without a pressure resultant. The resultant of the work done and of the weight will, during these quadrants, be the pressure on the bearing. The moment of torsion of the pressure P on the two crank pins is equal to the moment which would result from a pressure = 2 P, applied to an imaginary crank arm whose length is

$$= \frac{a}{\sqrt{2}}$$

and its position perpendicular to the line bisecting the angle made by the two cranks. In fig. 2, if A e and B e be the two cranks, the direction of the motion being that indicated by the arrow, during the next quadrant the cranks will lie on opposite sides of the shaft, and the collective power transmitted by a pressure P on each of the crankpins will be equivalent to a pressure 2 P applied to the imaginary arm $ce = \frac{a}{\sqrt{2}}$,

which will describe its quadrant from c to d during the next quadrant described by A and B. Let us separate the friction of weight from the resultant of the resistance overcome. If P is constant, and supposing no fly-wheel to intervene, the resistance overcome will be proportional to the ordinates drawn from the successive points of the arc c d to the line ab. The resultant pressure due to this resistance will be equal to it in amount. To get the sum of the products of pressure through space, we must multiply each ordinate by the portion of the circumference of the bearing belonging to it. But if these ordinates be taken equidistant, these products would be all equal to each other, for it would be found that as the ordinates decreased, that portion of the circumference would increase in exactly the same ratio. The sum of the products of pressure through the distance rubbed over will be found by multiplying the greatest pressure by the chord of the arc c d measured with radius = the radius of the bearing. The least resultant of the pressure will be when the cranks are in the position shown in Fig. 2. If the resistance be overcome at a distance from the centre = a_2 , and if P_2 be the maximum resistance, the products of pressure through surface for one quadrant will be $P_2 \cdot c d$. But

$$P_2 = \frac{2P \frac{a}{\sqrt{2}}}{a_2}$$

and when radius is equal to r_1 , $cd = r_1 \sqrt{2}$. Therefore,

$$P_2 \cdot cd = \frac{2P \frac{a}{\sqrt{2}}}{a_2} \cdot r_1 \sqrt{2} = \frac{2P r_1 a}{a_2}$$

Twice this multiplied by f will be its loss by friction through the two quadrants in which the cranks are on opposite sides of the centre

$$= \frac{4fPa r_1}{a_2} = \frac{2fPL r_1}{a_2}$$

If W be the weight on the crank-shaft bearing, its friction throughout half a revolution must be added, observing that it is positive if acting with the resultant of the resistance, and negative if acting in the opposite direction. That loss by friction weight will be $\pm \pi f W r_1$. The friction on the crank pin will be the same for these two quadrants as for the others. Therefore the loss by friction on the double crank at the crank-pin and crank-shaft bearings, the engine being vertical and the resistance also vertical, is throughout an entire revolution

$$= 2fP\pi(r_1 + 2r_2) + \frac{2fPL}{a_2} r_1 + \pi f W r_1$$

THE DEAD ARCS OF THE CRANK, commonly called the dead points. As the angular velocity of the crank-shaft and of the crank-pin is the same as the crank, and at the ends of the stroke the angular velocity of the connecting rod is $\frac{1}{n}$ times that of the crank, the moment of P on the crank-arm must be equal to the moment of the resistance of the friction on the crank-pin and on the crank-shaft added to $\frac{1}{n}$ times that on the crosshead, otherwise no motion will take place.

Let e be the distance from the central line at which the dead arc terminates.

$$P e = fP \left(r_1 + r_2 + \frac{r_3}{n} \right)$$

$$\therefore e = f \left(r_1 + r_2 + \frac{r_3}{n} \right)$$

I have now gone over the same points as are discussed in the work referred to in the beginning of this paper; I must now compare the results, The formula for a single crank is identical with that I have deduced, but the investigation, as I have already remarked, is very different. As an example of the very scientific way in which that formula is manufactured. I extract the following :

$$P_1 \left\{ a \sin. \theta - \rho_2 \sin. \phi_2 - \rho_1 \sin. \phi_1 \right\} = P_2 \left\{ a_2 \pm \rho_1 \sin. \phi_1 \right\} \pm W \rho_1 \sin. \phi_1 + W_1 (a \sin. \theta - \rho_2 \sin. \phi_2)$$

Multiplying the above equation by $a_2 \Delta \theta$ we have

$$P_1 a_2 \left\{ a \sin. \theta - \rho_2 \sin. \phi_2 - \rho_1 \sin. \phi_1 \right\} \Delta \theta = \left\{ a_2 \pm \rho_1 \sin. \phi_1 \right\} \Delta U \pm W a_2 \rho_1 \sin. \phi_1 \Delta \theta + W_1 a_2 (a \sin. \theta - \rho_2 \sin. \phi_2) \Delta \theta.$$

Whence passing to the limit, integrating from $\theta = 0$ to $\theta = \pi - \theta$, and dividing by a_2

$$P_1 \left\{ 2a \cos. \theta - (\pi - 2\theta) (\rho_2 \sin. \phi_2 + \rho_1 \sin. \phi_1) \right\} = \left\{ 1 \pm \frac{\rho_1}{a_2} \sin. \phi_1 \right\} U \pm W (\pi - 2\theta) \rho_1 \sin. \phi_1 + W_1 \left\{ 2a \cos. \theta - \rho_2 (\pi - 2\theta) \sin. \phi_2 \right\}$$

And so on; in the formula of the modulus of the double crank I differ entirely from that given by Moseley. Neglecting the friction of weight, and substituting the letters used in this paper, the formula from Moseley is that the loss by friction on the crank shaft journal and on the crank pin is expressed in decimal parts of the useful work by

$$\frac{\sqrt{2-1}}{\sqrt{2}} \frac{f r_1}{a_2} + \frac{f \pi}{2 a \sqrt{2}} (2 r_2 + r_1).$$

This ought to be correct for every value of a_2 . Let a_2 be infinitely large, and this expression becomes

$$\frac{f \pi}{2 a \sqrt{2}} (2 r_2 + r_1).$$

This expression reduced from the present paper is in parts of the original work.

$$\frac{f \pi}{2 a} (2 r_2 + r_1)$$

(To be continued.)

THE LIME LIGHT AT THE SOUTH FORELAND

We last month noticed the successful application of the lime light at the South Foreland Light House, but for want of space were unable to give the subjoined description and illustration of the lamp and apparatus, by which a continuously uniform light had been successfully obtained.

The lamp, which is the invention of Mr. W. Prosser, and similar in principle to those placed on Westminster Bridge, some months back, is of brass, and consists of a circular base $7\frac{1}{2}$ inches in diameter, and $1\frac{3}{4}$ inches in height, with an aperture in the centre, through which the lime wicks pass. In this base are contained two annular chambers for holding the gases. These chambers are separate and distinct, into one of which the hydrogen passes, and the oxygen into the other from the gasholder. From these chambers the gases are supplied by separate tubes to small mixing chambers $\frac{3}{8}$ of an inch in diameter, and $\frac{1}{2}$ an inch in depth, into which the gases are admitted by means of two separate cocks, one for each tube. These chambers are filled with from 16 to 20 very fine wire safety ganges, through which the two gases have to pass on their way to the jets, which are screwed into the tops of the chambers, by these means the gases are thoroughly intermixed before their ignition at the points of the jets. Within the aperture in the base is fitted a brass tube 22 inches in length, and $3\frac{3}{4}$ inches in diameter inside. The tube is of cylindrical form, corrugated at the upper end, in order that each corrugation may be opposite to the centre of one of the 8 panels of the Fresnel apparatus. In the middle of each exterior corrugation is cut an aperture about 7 inches from the base of the lamp. This aperture is about $2\frac{1}{2}$ in. long and 1 in. wide, and opposite one of the jets in every case. Within the external tube just described, a screw for putting the lime in motion is worked by a clock placed below the lamp. This screw passes through a nut, upon which rests an inside octagon tube of brass, of 39 inches in length. Upon each of its surfaces, which are flat, a metal case containing the lime is fastened every evening before lighting. These cases, which are open in front, are about $1\frac{1}{2}$ inches in breadth at the back, and are dovetailed so as to overlap the edges of the lime, which is in section the segment of a cylinder, so as to correspond exactly in shape

with the corrugations of the external case. Each lime case when fastened to the interior tube, as above described, fits closely into one of the corrugations, through the aperture in which is exposed a surface of lime $2\frac{1}{4}$ inches long and 1 inch wide, upon which the flame impinges. When the lime wicks have been inserted ready for lighting, the gases are turned on and lighted, and motion is given to the screw which raises the nut on which the tube carrying the lime wicks rests, keeping a fresh surface of lime always exposed to the action of the flame. No further attention is required during the burning of the lamp.

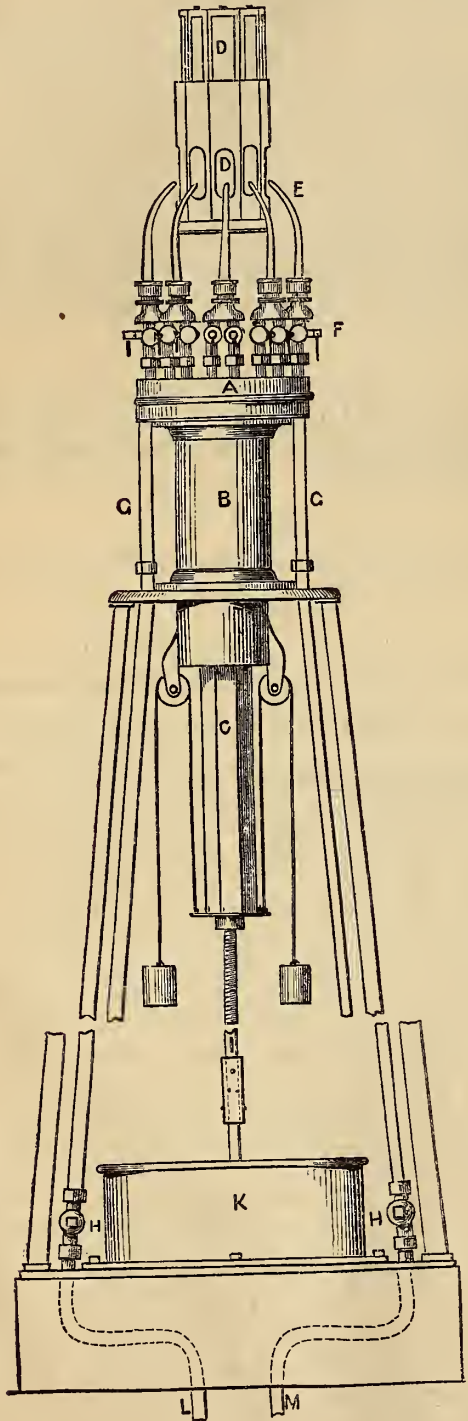

STRENGTH OF MATERIALS.

DEDUCED FROM THE LATEST EXPERIMENTS OF BARLOW, BUCHANAN, FAIRBAIRN, HODGKINSON, STEPHENSON, MAJOR WADE, U.S. ORDNANCE CORPS, AND OTHERS.

BY CHARLES H. HASWELL, C.E..

(Continued from page 206.)

FORMULE TO ASCERTAIN THE VALUES AND THE DIMENSIONS OF BARS BEAMS, ETC., OF VARIOUS SECTIONS. (By Thomas Tredgold.)

For a Square, Rectangle, Rectangle the diagonal being vertical, and Cylinder, they are alike to those already given, substituting in the rectangles, for $b d^2$, S^2 .

For a Grooved, or Double-flanged, Open, and Single-flanged Beam they are as follow.

1. Fixed at one end, Weight suspended from the other.
2. Fixed at both ends, Weight suspended from the middle.
3. Supported at both ends, Weight suspended from the middle.
4. Supported at both ends, Weight suspended at any other point than the middle.
5. Fixed at both ends, Weight suspended at any other point than the middle.

Grooved.



Open.



1.	$\frac{l W}{b d^2 (1 - q p^3)} = V$	$\frac{l W}{b d^2 (1 - p^3)} = V.$
2.	$\frac{l W}{b d^2 (1 - q p^3)} = V$	$\frac{l W}{b d^2 (1 - p^3)} = V.$
3.	$\frac{l W}{b d^2 (1 - q p^3)} = V$	$\frac{l W}{b d^2 (1 - p^3)} = V.$
4.	$\frac{m n W}{b d^2 m + n (1 - q p^3)} = V$	$\frac{m n W}{b d^2 m + n (1 - p^3)} = V.$
5.	$\frac{m n W}{b d^2 m + n (1 - q p^3)} = V$	$\frac{m n W}{b d^2 m + n (1 - p^3)} = V.$

Single flanged.



1. $\frac{l W}{b d^2 (1 - q p^3) (1 - q)} = V.$
 $(\sqrt{1 - q p^3} + \sqrt{1 - q})^2 = V.$

2, 3, 4, 5. For the other conditions of a bar, beam, &c., use the same formula as the above, multiplying the Value obtained above by 6, 4, 1, and 1, 5 respectively: p and q representing as follows; the other symbols as in the preceding formulæ.

$$\frac{\text{depth of groove}}{\text{whole depth of beam}} = p.$$

$$\frac{\text{whole breadth of beam} - \text{width of web}}{\text{whole breadth of beam}} = q.$$

TRANSVERSE RESISTANCE FROM END PRESSURE APPLIED HORIZONTALLY. WROUGHT IRON.















7.5 ft. in length; flanges, 6 x 3.5 in. x .625 thick; area, 5.5 sq. ins.
 50,000 lbs. produced no set.
 58,240 " " a set of 1.75 in.

WHITE OAK.

Rectangle 10 feet in length, 11 x 4.5 inches.
 33,600 lbs. gave a deflection of .375 inch.
 50,400 " " .5 "
 67,200 " " .625 "
 and with 78,400 " it broke.

TABLE OF THE TRANSVERSE STRENGTH OF CAST IRON GIRDERS AND BEAMS.







Deduced from the Experiments of Barlow, Hodgkinson, Hughes, Tredgold, &c., reduced to an uniform Measure of one Inch in Depth, one Foot in Length, and supported at both Ends. The Stress or Weight applied in the Middle.

SECTION OF GIRDER OR BEAM.	AREA OF FLANGES.		Width of Vertical Web.	Depth of Girder.	Breadth of Girder.	Area of Section in Centre.	Length between Supports.	Breaking Weight at given Length.	Breaking Weight at Length of one Foot.	Strength per Square Inch of Section.	Strength per Inch of Depth of Section.
	Top.	Bottom.									
	Sq. in.	Sq. in.	Inches.	Inches.	Inches.	Sq. in.	Feet.	lbs.	lbs.	lbs.	lbs.
 Equal area of flange at top and bottom...	$1.75 \times .42 = .735$	$1.77 \times .39 = .69$.29	5.125	1.77	2.82	4.6	6,700	30,150	10,768	2100
Do. do. ...	$2.03 \times .515 = 1.045$	$2.03 \times .515 = 1.045$.50	2.04	2.03	2.60	4	4,005	16,016	6,160	3000
 Do. do. ...	$2.02 \times .515 = 1.045$	$2.02 \times .515 = 1.045$.51*	2.02	2.02	2.59	4	2,569	10,276	3,952	1900
 Area of sec. of top and bottom as 1 to 2	$1.74 \times .26 = .45$	$1.78 \times .55 = .98$.30	5.125	1.78	2.87	4.6	7,460	33,300	11,563	2200
Do. as 1 to 4	$1.07 \times .30 = 1.32$	$2.1 \times .57 = 1.2$.32	5.125	2.1	3.02	4.6	8,300	37,350	12,367	2400
Do. as 1 to 6	$2.33 \times .31 = .72$	$6.67 \times .66 = 4.4$.266	5.125	6.67	6.4	4.6	26,100	117,450	18,352	3550
		$2.27 \times .46 = 1.044$.37	5.125	2.27	2.76	4.6	8,800	39,600	14,347	2750
		$1.5 \times .5 = .75$.5	3	1.5	2	3.1	5,208	16,058	8,029	2650
		$5 \times .3 = 1.5$.365	1.56	5	1.96	6.6	1,120	7,280	3,714	2350
		$1.5 \times .5 = .75$.5	3	1.5	2	3.1	4,536	13,986	6,993	2300
		$5 \times .3 = 1.5$.36	1.55	5	1.96	6.6	364	2,366	1,213	750
		$23.9 \times 3.12 = 74.56$	3.30	36.1	23.9	183.5	23.1	349,440	8,066,240	43,958	1200
		$1.5 \times .5 = .75$.5	4.†	1.5	1	3.1	6,480	19,980	19,980	5000
		$1.5 \times .5 = .75$.5	4.†	1.5	1	3.1	2,352	7,252	7,252	1800
		$4 \times 2 = 8$.2	4.	4	12	6	5,600	33,600	2,800	700
		$6 \times 1.5 = 9$	1.5	9	8	30	11.8	45,300	528,500	17,617	1900
		$5.1 \times 2.33 = 11.88$	2.08	30.5	11.1	90.8	27.6	174,320	4,793,800	52,795	1700





* Horizontal Web.

† Depth of opening, 3 inches.

TABLE OF THE TRANSVERSE STRENGTH OF CAST IRON GIRDERS AND BEAMS—continued.

SECTION OF GIRDER OR BEAM.	Depth of Beam.	Depth of Metal.	Width of Beam.	Distance between top and bottom base.	Breadth of Girder.	Area of Section in Centre.	Length between Supports.	Breaking Weight at given Length.	Breaking Weight at length of one Foot.	Strength per Square Inch of Section.	Value per Inch of Depth of Section.
	Inches.	Inches.	Inches.	Inches.	In.	Sq. in.	Feet.	lbs.	lbs.	lbs.	lbs.
 Rectangular Prism	2.012	2.012	.994	2.025	5	1888	9,440	4,682	2350
 Open Beam	2.51	1.97	1.005	.54	...	1.98	5	2468	13,849	6,232	2450
Do. do.	3.01	2.01	.995	1	...	2	5	3084	15,420	7,710	2550
Do. do.	4	1.97	1.005	2.03	...	1.98	5	4353	21,765	10,992	2760
Do. do.	4.04	3.01	.771	1.03	...	2.322	5	5141	25,705	11,070	2750
Do. do.	4.04	1.48	1.507	2.56	...	2.23	5	5147	25,735	11,540	2850
Do. do.	4.07	1.56	1.525	2.51	...	2.35	5	6000	30,000	12,689	3100
 Square Prism, Stress at Side	1.01	1.01	1.02	1.032	5	527	2,635	2,552	2500
 Cylinder	1.122	1.122	1.122989	5	474	2,370	2,396	2150
 Square Prism, Angle up	1.443	1.443	1.443	1.041	2.8	449	2,269	2,182	1500
 Versed sine of arch8	1	1	1	1	1,425	1,425	1490
Do. do. ... 1.5	1	1	1	1	1,945	1,945	1960
 Versed sine of arch8	1	1	1	1	501	501	500
Do. do. ... 1.5	1	1	1	1	315	315	300

COMPARATIVE RESISTANCE OR STRENGTH OF GIRDERS, BEAMS, ETC., OF EQUAL SECTIONAL AREAS AND DEPTHS.

Description of Girder or Beam.	Comparative Strength.
 Rectangular beam	1
 Grooved beam, top and bottom flanges of equal areas, of uniform thickness of metal throughout, and the depth three times the breadth (Tredgold)	1.16
 Single flanged beam, width of flanch five-twelfths of height, width of rib one-half the depth of flange (Watt and Fairbairn).....	1.27
 Open beam the space one-half the depth.....	1.50
 Double flanged beam, area of top flange one-sixth of that of bottom; depth of top flange, one-half of that of bottom; width of bottom flange, one and a quarter times the depth of the beam (Hodgkinson)	1.66

To ascertain the transverse strength, or the loads that may be borne by cast iron girders or beams, of various figures and sections, when supported at both ends, the load applied in the middle.

When the section of the girder or beam is that of a rectangle, a grooved, open, single, or double flanged beam.

RULE [A].*—Ascertain the resistance or strength of the rectangular solid, the dimensions of which are the depth and the greatest breadth of the beam, and subtract from it the resistance which would be offered by that part of the beam which is wanting to make it an uniform solid.

NOTE.—This rule is applicable to all cases when the flange of the beam having the greatest sectional area is set below, when the beam rests upon two supports, or is fixed at both ends, or set above when the beam is fixed at one end only.

When the case differs from this, an increase of metal, obtained by a reduction of the Value of it, can be estimated for the result of the resistance per square inch of section of beams, of various sections in table at page 249.

EXAMPLE.—What is the load that will break a Hodgkinson beam of the following dimensions and 10ft. in length between its supports, the load applied in its middle?

Top flange.....	7 x 1 inch.
Bottom flange	21 x 2 "
Width of rib.....	8 "
Whole depth of beam	21 "
Area of whole section	63.4 "
Dimensions of rectangle.....	21 x 21 "
Hence 21 ² x 21 = 9261 inches.	

7 - 8 = 6.2 inches = width of space between both extremities of top flange and rib; 21 - 2 + 1 = 18 = depth of space between top and bottom flanges. Hence 18² x 6.2 = 2008.8.

21 - 7 = 14 = width of space between both extremities of top and bottom flanges; 21 - 2 = 19 = with of space above bottom flange. Hence, 19² x 14 = 5054

Difference, 7062.8

And 9261 - 7062.8 x 4 x 500† = 4396400 = difference of products of the square of the depth and the breadth of the parts wanting to complete the rectangle multiplied by four times the value of the metal, which ÷ 10 for the length = 439,640 lbs.

In the example given above, the formulæ of various authors give the following results.

Hodgkinson :

$$\frac{2}{3 d l} \times (b d^3 - (b - b') d'^3) = W \text{ in tons.}$$

* The utility of this rule, in preference to those of Hodgkinson, Fairbairn, Tredgold Hughes, and Barlow, is manifest; as in the one case the Value of the metal is considered, and in the other cases the metal is assumed to be of an uniform value or strength; and when the range in this element, both in weight and cost, renders it imperative that in a structure of iron of the highest transverse strength, the weight due to the requirements of dimensions of the lowest transverse strength should not be increased, and contrariwise. The only variable element not embraced in this rule is that consequent upon any peculiarity of form of section; as, for instance, in that of Hodgkinson, or like beams, when the area of one flange greatly exceeds the rest of the section, and this flange is placed other than below when the beam rests upon two supports or is fixed at both ends, or than above when the beam is fixed at one end.

† Assumed breaking weight of the metal. In connexion with this, it is to be borne in mind that the greater the area of the section of the metal, the less its strength, and the longer the beam, the greater the risk of a deflection from a flaw in its structure.

d representing depth of beam, d' depth to bottom flange, b breadth of bottom flange, b' thickness of vertical web, all in inches, l length in feet, and W weight in tons.

$$\therefore \frac{2}{3 \times 21 \times 10} \times (21 \times 21^3 - (21 - 8) \times 19^3) = 177.55, \text{ which } \times 2240 = 397,712 \text{ lbs.}$$

Fairbairn :

$$\frac{2.166 a d}{l} = W; a \text{ representing area of bottom flange.}$$

$$\therefore \frac{2.166 \times 42 \times 21}{10} = 191.1, \text{ which } \times 2240 = 428,064 \text{ lbs.}$$

Hughes :

$$\frac{2 a d}{l} = W.$$

$$\therefore \frac{2 \times 42 \times 21}{10} = 176.4, \text{ which } \times 2240 = 395,136 \text{ lbs.}$$

* * *

$$\frac{1.5 A d}{2} = W, A \text{ representing area of section.}$$

$$\therefore \frac{1.15 \times 63.4 \times 21}{10} = 199.7, \text{ which } \times 2240 = 447,328 \text{ lbs.}$$

Barlow :

$$\frac{1.13 A d}{l} = W.$$

$$\therefore \frac{1.13 \times 63.4 \times 21}{10} = 150.4, \text{ which } \times 2240 = 336,896 \text{ lbs.}$$

Again, experiments upon the breaking weight of girders of English cast iron have given the following results :

DIMENSIONS OF GIRDERS.

	1 and 2.	3
Top flange	3.25 x 1.25 ins. ...	4.125 x 1.5 ins.
Web	1.25 ...	1.5
Bottom flange	9' x 1.25 ...	15' x 2.25
Whole depth	22' ...	24.25
Area of bottom flange ...	11.25 ...	33.75
Whole area	39.69 sq. ins. ...	70.69 sq. ius.
Length between supports	19' ft. ...	30.75 ft.
Breaking weight	{ 1.116550 lbs. } ...	3.145208 lbs.
	{ 2.125350 " } ...	

Breaking Weights calculated by various formulæ.

	1 and 2.	3.
By Fairbairn	63,213 lbs. ...	129,272 lbs.
Hodgkinson	94,998 " ...	139,082 "
Hughes	58,352 " ...	119,240 "
Barlow	116,323 " ...	141,120 "
Rule* [A]	114,337 " ...	143,712 "

COMPARATIVE VALUES OF CAST IRON BARS, HOLLOW GIRDERS, OR TUBES OF VARIOUS FIGURES (ENGLISH IRON).

Square bar, small	1'
" large75
Round bar, small675
Square tubes, uniform thickness.....	1.075
Rectangular tubes "	.85
Circular tubes "	.90
Elliptic tubes "	.95

Determined by the formula,

$$\frac{A d V}{l} = W,$$

A representing area of section, and d depth in inches, l the length in feet, and W the load that may be borne with safety.













COMPARATIVE STRENGTH OF CAST IRON FLANGED BEAMS.

Description of Beam.	Comparative Strength.	Description of Beam.	Comparative Strength.
Beam of equal flanges58	Breadth with flanges as 1 to 4.578
" with only bottom flange	.72	" " 1 to 5.582
" flanges as 1 to 263	" " 1 to 6 ...	1
" " 1 to 473	" " 1 to 6.73... ..	.92
" Average experiment94.

* The Values here used, in consideration of the depth and great length of the girders, are reduced to 495 for the first and second cases, and 450 for the third.

TABLE OF THE TRANSVERSE STRENGTH OF WROUGHT IRON GIRDERS AND BEAMS.

Deduced from the Experiments of Barlow, Fairbairn, Hughes, &c., and reduced to an uniform Measure of 1 Inch in Depth, 1 Foot in Length, and supported at both Ends. The Stress or Weight applied in the Middle.

SECTION OF GIRDER OR BEAM.	Area of Flanges.		Width of Vertical Web.	Depth of Girder.	Breadth of Girder.	Thickness of Plates.	Area of Section.	Length between Supports.	Destruc. Weight at given Length.	Destruc. Weight at Length of 1 Foot.	Strength per Square Inch of Section.	Value for destruc. Weight.*
	Top.	Bottom.										
	Sq. in.	Sq. in.	In.	In.	In.	Inches.	Sq. in.	Feet.	lbs.	lbs.	lbs.	lbs.
 Solid.....	2.5 x 1 = 2.5	4 x .38 = 1.52	.325	8.38	4	6.295	11	12,000	132,000	20,952	2500
	2.75 x 1 = 2.75	4.3 x .42 = 1.806	.38	9.42	4.3	7.596	10	22,000	220,000	28,947	3000
 "	2.85 x .38 = 1.0831	2.5	2.85	1.73	4	3,142	12,560	7,260	2900
 "	2.85 x .38 = 1.08	.31	2.5	2.85	1.73	4	3,008	12,032	6,955	2750
 Rivetted ...	2.86 x .33 = .944	2.86 x .33 = .944	.66	3.7	2.86	3.88	4	14,000	56,000	14,433	3800
 Do. inverted ...	5 x .25 = 1.2554	2.6	5	4.07	7	3,355	23,485	5,770	2250
	2 of 2.25 x 2.25 x .3 = 2.8254	2.6	5	4.07	2.3	9,250	20,812	5,113	2000
 "	5 x .25 = 1.25	5 x .25 = 1.25	.54	2.6	5	4.07	2.3	9,250	20,812	5,113	2000
	2 of 2.25 x 2.25 x .3 = 2.82	2 of 2.25 x 2.25 x .3 = 2.82	.54	2.6	5	4.07	2.3	9,250	20,812	5,113	2000
 "	2 of 3.5 x 3.5 x .5 = 7	2 of 3.5 x 3.5 x .5 = 7	.37	16	7.37	19.92	24	32,000	768,000	38,593	2400
	2 of 2.125 x .28 = 1.19	2 of 2.125 x .30 = 1.29	.25	7	4.23	4.23	7	24,380	170,660	40,345	5800
 "	3	1.9	.03	.29	3.9	672	2,520	8,689	2850
	3	1.95	.061	.60	3.9	2,520	9,450	15,750	5200
	5.8	3.8	.065	1.24	7.6	3,156	23,670	19,089	3200
	6	3.9	.1325	2.60	7.6	9,976	74,820	28,777	4600
	6	4	.1325	2.62	7.6	10,080	75,600	28,855	4700
	24	15	.124	9.60	30	12,500	375,000	39,063	1600
	23.75	15.5	.272	21.20	30	51,200	1,536,000	72,452	3000
	24	15.5	.525	40.92	30	128,900	3,867,000	94,648	3900
	24	16	.525	41.45	30	128,800	3,864,000	93,221	3900
	36	24	.75	87.75	45	291,200	13,104,000	149,333	4900
 "	Feet.	Feet.
	9.6 x .075 = .72	9.6 x .0743 = .713	9.5	9.5	.0743	2.86	17.5	3,738	65,415	22,872	2400
	9.6 x .252 = 2.419	9.6 x .075 = .72	9.5	9.5	.074	4.36	17.5	8,273	146,528	33,607	3450
	9.6 x .076 = .727	9.6 x .142 = 1.363	9.5	9.5	.076	3.54	17.5	3,788	66,290	18,723	1950
	9.6 x .142 = 1.363	9.6 x .076 = .727	9.5	9.5	.076	3.54	17.5	7,148	125,090	35,619	3700
	9.25 x .149 = 1.378	9.25 x .269 = 2.488	18.25	9.25	.059	6.03	17.5	6,812	119,210	19,768	1050
 "	In.	In.
	9.25 x .269 = 2.488	9.25 x .149 = 1.378	18.25	9.25	.059	6.03	17.5	12,188	213,290	35,371	1900
	2.25 x .26 = .585	2.25 x .26 = .585	15	2.25	.131	5.10	24	17,600	452,400	88,700	5500
	1 x .282 = .282	1 x .116 = .116	8	1	.067	1.47	11	12,254	123,794	84,214	10300
.....	24 †	12.8	54	2.92	45.82	75	125,912	9,443,400	206,096	3800
 Elliptical ... †	24	16	{ .375 top .25 bot. .125 side	30	62,720	188,160
	36	24	{ .562 top .375 bot. .25 side	30	231,465	6,943,950
 Tubes	12	12	.0408	1.40	17	2,600	44,200	31,571	2600
	24	24	.095	7.13	31.27	9,550	298,629	41,743	1725
 Elliptical	14.62	9.25	.0416	1.56	17	2,150	36,550	23,430	1600
	15	9.75	.143	5.56	17.5	15,900	278,250	50,045	3300

* The above and preceding results are deduced from girders of the length given; hence, when the length is less, the breaking weight may be increased, in consequence of the increased stability of the girder. These results are very conclusive of the correctness of the formula used, viz.: $\frac{A d V}{7}$, as will be seen in the experiments here given.

† Thickness of plates, bottom, .156; top, .147; sides, .099. Area of bottom, 8.8 in.

‡ The lateral strength of this was ascertained to be 38080, or $\frac{2}{3}$ of its vertical strength. The ultimate deflection was 2.75 ins.

HYPERBOLIC LOGARITHMS.

As a complete table of hyperbolic logarithms is very seldom to be found in engineering books, we have supplied the want by the accompanying table, which we believe will be found very useful.

The subjoined table is calculated in the following manner:—To find the

hyperbolic logarithm of a number, multiply the common logarithm of the number by 2.302585052994, and the product is the hyperbolic logarithm of that number.

EXAMPLE:—The common logarithm of 3.75 is .5740313; the hyperbolic logarithm is then found by multiplying 2.302585 by .5740313 = 1.3217559, the hyperbolic logarithm.

TABLE OF HYPERBOLIC LOGARITHMS.

N	Logarithm.	N.	Logarithm.	N.	Logarithm.	N.	Logarithm.	N.	Logarithm.	N.	Logarithm.	N.	Logarithm.	N.	Logarithm.
1.01	.0099503	1.71	.5364933	2.41	.8796266	3.11	1.1346227	3.81	1.3376291	4.51	1.5062971	5.21	1.6505798	5.91	1.7768458
1.02	.0198026	1.72	.5423241	2.42	.8837675	3.12	1.1378330	3.82	1.3402504	4.52	1.5085119	5.22	1.6524974	5.92	1.7783364
1.03	.0295588	1.73	.5481212	2.43	.8878912	3.13	1.1410330	3.83	1.3428648	4.53	1.5107219	5.23	1.6544112	5.93	1.7800242
1.04	.0392207	1.74	.5538850	2.44	.8919980	3.14	1.1442227	3.84	1.3454723	4.54	1.5129269	5.24	1.6563214	5.94	1.7817091
1.05	.0487902	1.75	.5596156	2.45	.8960879	3.15	1.1474024	3.85	1.3480731	4.55	1.5151272	5.25	1.6582280	5.95	1.7833912
1.06	.0582690	1.76	.5653138	2.46	.9001613	3.16	1.1505718	3.86	1.3506671	4.56	1.5173226	5.26	1.6601310	5.96	1.7850704
1.07	.0676586	1.77	.5709795	2.47	.9042181	3.17	1.1537315	3.87	1.3532544	4.57	1.5195132	5.27	1.6620303	5.97	1.7867469
1.08	.0769610	1.78	.5766133	2.48	.9082585	3.18	1.1568811	3.88	1.3558351	4.58	1.5216990	5.28	1.6639260	5.98	1.7884205
1.09	.0861777	1.79	.5822156	2.49	.9122826	3.19	1.1600209	3.89	1.3584091	4.59	1.5238800	5.29	1.6658182	5.99	1.7900914
1.10	.0953102	1.80	.5877866	2.50	.9162907	3.20	1.1631508	3.90	1.3609765	4.60	1.5260563	5.30	1.6677068	6.00	1.7917595
1.11	.1043600	1.81	.5933268	2.51	.9202825	3.21	1.1662708	3.91	1.3635373	4.61	1.5282278	5.31	1.6695918	6.01	1.7934247
1.12	.1133285	1.82	.5988365	2.52	.9242589	3.22	1.1693813	3.92	1.3660916	4.62	1.5303947	5.32	1.6714733	6.02	1.7950872
1.13	.1222174	1.83	.6043159	2.53	.9282193	3.23	1.1724821	3.93	1.3686395	4.63	1.5325568	5.33	1.6733512	6.03	1.7967470
1.14	.1310284	1.84	.6097653	2.54	.9321640	3.24	1.1755733	3.94	1.3711807	4.64	1.5347143	5.34	1.6752256	6.04	1.7984040
1.15	.1397614	1.85	.6151855	2.55	.9360934	3.25	1.1786549	3.95	1.3737156	4.65	1.5368672	5.35	1.6770965	6.05	1.8000582
1.16	.1484199	1.86	.6205763	2.56	.9400072	3.26	1.1817271	3.96	1.3762440	4.66	1.5390154	5.36	1.6789639	6.06	1.8017098
1.17	.1570038	1.87	.6259384	2.57	.9439058	3.27	1.1847899	3.97	1.3787661	4.67	1.5411590	5.37	1.6808278	6.07	1.8033586
1.18	.1655144	1.88	.6312717	2.58	.9477893	3.28	1.1878434	3.98	1.3812818	4.68	1.5432981	5.38	1.6826882	6.08	1.8050014
1.19	.1739534	1.89	.6365768	2.59	.9516578	3.29	1.1908875	3.99	1.3837911	4.69	1.5454325	5.39	1.6845453	6.09	1.8066481
1.20	.1823215	1.90	.6418538	2.60	.9555112	3.30	1.1939224	4.00	1.3862934	4.70	1.5475625	5.40	1.6863989	6.10	1.8082887
1.21	.1906204	1.91	.6471033	2.61	.9593502	3.31	1.1969481	4.01	1.3887912	4.71	1.5496879	5.41	1.6882491	6.11	1.8099267
1.22	.1988507	1.92	.6523251	2.62	.9631743	3.32	1.1999647	4.02	1.3912818	4.72	1.5518087	5.42	1.6900958	6.12	1.8115621
1.23	.2070140	1.93	.6575200	2.63	.9669838	3.33	1.2029722	4.03	1.3937763	4.73	1.5539252	5.43	1.6919391	6.13	1.8131947
1.24	.2151113	1.94	.6626879	2.64	.9707789	3.34	1.2059707	4.04	1.3962446	4.74	1.5560371	5.44	1.6937790	6.14	1.8148247
1.25	.2231435	1.95	.6678294	2.65	.9745596	3.35	1.2089603	4.05	1.3987168	4.75	1.5581446	5.45	1.6956155	6.15	1.8164520
1.26	.2311161	1.96	.6729445	2.66	.9783259	3.36	1.2119409	4.06	1.4011829	4.76	1.5602476	5.46	1.6974487	6.16	1.8180767
1.27	.2390167	1.97	.6780335	2.67	.9820784	3.37	1.2149127	4.07	1.4036429	4.77	1.5623462	5.47	1.6992786	6.17	1.8196988
1.28	.2468601	1.98	.6830968	2.68	.9858167	3.38	1.2178757	4.08	1.4060969	4.78	1.5644405	5.48	1.7011051	6.18	1.8213182
1.29	.2546422	1.99	.6881346	2.69	.9895411	3.39	1.2208299	4.09	1.4085449	4.79	1.5665304	5.49	1.7029282	6.19	1.8229352
1.30	.2623643	2.00	.6931472	2.70	.9932518	3.40	1.2237754	4.10	1.4109869	4.80	1.5686159	5.50	1.7047481	6.20	1.8245493
1.31	.2700271	2.01	.6981347	2.71	.9969486	3.41	1.2267122	4.11	1.4134230	4.81	1.5706971	5.51	1.7065646	6.21	1.8261670
1.32	.2776316	2.02	.7030974	2.72	1.0006318	3.42	1.2296405	4.12	1.4158535	4.82	1.5727739	5.52	1.7083778	6.22	1.8277869
1.33	.2851787	2.03	.7080357	2.73	1.0043015	3.43	1.2325605	4.13	1.4182774	4.83	1.5748464	5.53	1.7101878	6.23	1.8293763
1.34	.2926696	2.04	.7129497	2.74	1.0079579	3.44	1.2354714	4.14	1.4206957	4.84	1.5769147	5.54	1.7119944	6.24	1.8309801
1.35	.3001046	2.05	.7178399	2.75	1.0116009	3.45	1.2383742	4.15	1.4231083	4.85	1.5789787	5.55	1.7137979	6.25	1.8325814
1.36	.3074847	2.06	.7227058	2.76	1.0152306	3.46	1.2412685	4.16	1.4255150	4.86	1.5810384	5.56	1.7155981	6.26	1.8341801
1.37	.3148108	2.07	.7275485	2.77	1.0188473	3.47	1.2441545	4.17	1.4279161	4.87	1.5830939	5.57	1.7173950	6.27	1.8357763
1.38	.3220833	2.08	.7323678	2.78	1.0224509	3.48	1.2470322	4.18	1.4303112	4.88	1.5851452	5.58	1.7191887	6.28	1.8373699
1.39	.3293037	2.09	.7371640	2.79	1.0260415	3.49	1.2499017	4.19	1.4327007	4.89	1.5871923	5.59	1.7209792	6.29	1.8389610
1.40	.3364721	2.10	.7419373	2.80	1.0296193	3.50	1.2527629	4.20	1.4350844	4.90	1.5892352	5.60	1.7227660	6.30	1.8405496
1.41	.3435895	2.11	.7466880	2.81	1.0331843	3.51	1.2556160	4.21	1.4374626	4.91	1.5912739	5.61	1.7245507	6.31	1.8421356
1.42	.3506568	2.12	.7514160	2.82	1.0367368	3.52	1.2584609	4.22	1.4398351	4.92	1.5933085	5.62	1.7263316	6.32	1.8437191
1.43	.3576744	2.13	.7561219	2.83	1.0402766	3.53	1.2612978	4.23	1.4422020	4.93	1.5953389	5.63	1.7281094	6.33	1.8453002
1.44	.3646431	2.14	.7608058	2.84	1.0438040	3.54	1.2641266	4.24	1.4445632	4.94	1.5973653	5.64	1.7298840	6.34	1.8468787
1.45	.3715635	2.15	.7654680	2.85	1.0473189	3.55	1.2669475	4.25	1.4469189	4.95	1.5993875	5.65	1.7316555	6.35	1.8484547
1.46	.3784365	2.16	.7701082	2.86	1.0508215	3.56	1.2697605	4.26	1.4492691	4.96	1.6014057	5.66	1.7334238	6.36	1.8500283
1.47	.3852623	2.17	.7747271	2.87	1.0543120	3.57	1.2725655	4.27	1.4516138	4.97	1.6034198	5.67	1.7351891	6.37	1.8515994
1.48	.3920420	2.18	.7793248	2.88	1.0577902	3.58	1.2753627	4.28	1.4539530	4.98	1.6054298	5.68	1.7369512	6.38	1.8531680
1.49	.3987762	2.19	.7839014	2.79	1.0612564	3.59	1.2781521	4.29	1.4562867	4.99	1.6074358	5.69	1.7387102	6.39	1.8547342
1.50	.4054652	2.20	.7884573	2.90	1.0647107	3.60	1.2809338	4.30	1.4586149	5.00	1.6094377	5.70	1.7404661	6.40	1.8562979
1.51	.4121094	2.21	.7929925	2.91	1.0681529	3.61	1.2837077	4.31	1.4609379	5.01	1.6114359	5.71	1.7422189	6.41	1.8578592
1.52	.4187103	2.22	.7975071	2.92	1.0715836	3.62	1.2864740	4.32	1.4632553	5.02	1.6134300	5.72	1.7439687	6.42	1.8594181
1.53	.4252675	2.23	.8020015	2.93	1.0750024	3.63	1.2892326	4.33	1.4655675	5.03	1.6154200	5.73	1.7457155	6.43	1.8609745
1.54	.4317823	2.24	.8064758	2.94	1.0784095	3.64	1.2919836	4.34	1.4678743	5.04	1.6174060	5.74	1.7474591	6.44	1.8625285
1.55	.4382550	2.25	.8109303	2.95	1.0818051	3.65	1.2947271	4.35	1.4701758	5.05	1.6193882	5.75	1.7491998	6.45	1.8640801
1.56	.4446858	2.26	.8153647	2.96	1.0851892	3.66	1.2974631	4.36	1.4724720	5.06	1.6213664	5.76	1.7509374	6.46	1.8656293
1.57	.4510756	2.27	.8197798	2.97	1.0885619	3.67	1.3001916	4.37	1.4747630	5.07	1.6233408	5.77	1.7526720	6.47	1.8671761
1.58	.4574247	2.28	.8241754	2.98	1.0919233	3.68	1.3029127	4.38	1.4770487	5.08	1.6253112	5.78	1.7544036	6.48	1.8687205
1.59	.4637339	2.29	.8285518	2.99	1.0952733	3.69	1.3056264	4.39	1.4793292	5.09	1.6272778	5.79	1.7561323	6.49	1.8702625
1.60	.4700036	2.30	.8329089	3.00	1.0986124	3.70	1.3083328	4.40	1.4816045	5.10	1.6292405	5.80	1.7578579	6.50	1.8718021
1.61	.4762341	2.31	.8372474	3.01	1.1019400	3.71	1.3110318	4.41	1.4838746	5.11	1.6311994	5.81	1.7595805	6.51	1.8733394
1.62	.4824260	2.32	.8415671	3.02	1.1052568	3.72	1.3137236	4.42	1.4861396	5.12	1.6331544	5.82	1.7613002	6.52	1.8748743
1.63	.4885801	2.33	.8458682	3.03	1.1085626	3.73	1.3164082	4.43	1.4883994	5.13	1.6351057	5.83	1.7630070	6.53	1.8764069
1.64	.4946959	2.34	.8501509	3.04	1.1118575	3.74	1.3190856								

TABLE OF HYPERBOLIC LOGARITHMS—continued.

N.	Logarithm.	N.	Logarithm.	N.	Logarithm.	N.	Logarithm.	N.	Logarithm.	N.	Logarithm.	N.	Logarithm.	N.	Logarithm.
661	1.885837	704	1.9516080	747	2.0108949	790	2.0668627	833	2.1198634	876	2.1701959	919	2.2181160	962	2.2638442
662	1.8900954	705	1.9530275	748	2.0123227	791	2.0681277	834	2.1210632	877	2.1713367	920	2.2192034	963	2.2648332
663	1.8916048	706	1.9544449	749	2.0135687	792	2.0693911	835	2.1222615	878	2.1724763	921	2.2202898	964	2.2659211
664	1.8931119	707	1.9558604	750	2.0149030	793	2.0706530	836	2.1234584	879	2.1736146	922	2.2213750	965	2.2669579
665	1.8946168	708	1.9572739	751	2.0162354	794	2.0719132	837	2.1246539	880	2.1747517	923	2.2224590	966	2.2679936
666	1.8961194	709	1.9586853	752	2.0175661	795	2.0731719	838	2.1258479	881	2.1758874	924	2.2235418	967	2.2690282
667	1.8976198	710	1.9600947	753	2.0188950	796	2.0744290	839	2.1270405	882	2.1770218	925	2.2246235	968	2.2700618
668	1.8991179	711	1.9615022	754	2.0202221	797	2.0756845	840	2.1282317	883	2.1781550	926	2.2257040	969	2.2710944
669	1.9006138	712	1.9629077	755	2.0215475	798	2.0769384	841	2.1294214	884	2.1792868	927	2.2267833	970	2.2721258
670	1.9021075	713	1.9643112	756	2.0228711	799	2.0781907	842	2.1306098	885	2.1804174	928	2.2278615	971	2.2731562
671	1.9035989	714	1.9657127	757	2.0241929	800	2.0794414	843	2.1317967	886	2.1815467	929	2.2289385	972	2.2741856
672	1.9050881	715	1.9671123	758	2.0255131	801	2.0806907	844	2.1329822	887	2.1826747	930	2.2300144	973	2.2752138
673	1.9065751	716	1.9685099	759	2.0268315	802	2.0819384	845	2.1341664	888	2.1838015	931	2.2310890	974	2.2762411
674	1.9080600	717	1.9699056	760	2.0281482	803	2.0831845	846	2.1353491	889	2.1849270	932	2.2321626	975	2.2772673
675	1.9095425	718	1.9712993	761	2.0294631	804	2.0844290	847	2.1365304	890	2.1860512	933	2.2332350	976	2.2782924
676	1.9110228	719	1.9726911	762	2.0307763	805	2.0856720	848	2.1377104	891	2.1871742	934	2.2343062	977	2.2793165
677	1.9125011	720	1.9740810	763	2.0320878	806	2.0869135	849	2.1388889	892	2.1882959	935	2.2353763	978	2.2803395
678	1.9139771	721	1.9754689	764	2.0333976	807	2.0881534	850	2.1400661	893	2.1894163	936	2.2364452	979	2.2813614
679	1.9154509	722	1.9768549	765	2.0347056	808	2.0893918	851	2.1412419	894	2.1905355	937	2.2375130	980	2.2823823
680	1.9169226	723	1.9782390	766	2.0360119	809	2.0906287	852	2.1424163	895	2.1916535	938	2.2385786	981	2.2834022
681	1.9183921	724	1.9796212	767	2.0373166	810	2.0918640	853	2.1435893	896	2.1927702	939	2.2396452	982	2.2844211
682	1.9198594	725	1.9810014	768	2.0386195	811	2.0930984	854	2.1447609	897	2.1938856	940	2.2407096	983	2.2854389
683	1.9213247	726	1.9823798	769	2.0399207	812	2.0943306	855	2.1459312	898	2.1949998	941	2.2417729	984	2.2864556
684	1.9227877	727	1.9837562	770	2.0412203	813	2.0955613	856	2.1471001	899	2.1961128	942	2.2428350	985	2.2874714
685	1.9242486	728	1.9851308	771	2.0425181	814	2.0967905	857	2.1482676	900	2.1972245	943	2.2438960	986	2.2884861
686	1.9257074	729	1.9865035	772	2.0438143	815	2.0980182	858	2.1494339	901	2.1983350	944	2.2449559	987	2.2894998
687	1.9271641	730	1.9878743	773	2.0451088	816	2.0992444	859	2.1505987	902	2.1994443	945	2.2460147	988	2.2905124
688	1.9286186	731	1.9892432	774	2.0464016	817	2.1004691	860	2.1517622	903	2.2005523	946	2.2470723	989	2.2915241
689	1.9300710	732	1.9906103	775	2.0476928	818	2.1016923	861	2.1529243	904	2.2016591	947	2.2481288	990	2.2925347
690	1.9315214	733	1.9919754	776	2.0489823	819	2.1029140	862	2.1540851	905	2.2027647	948	2.2491843	991	2.2935443
691	1.9329696	734	1.9933387	777	2.0502701	820	2.1041341	863	2.1552445	906	2.2038691	949	2.2502386	992	2.2945529
692	1.9344157	735	1.9947002	778	2.0515563	821	2.1053529	864	2.1564026	907	2.2049722	950	2.2512917	993	2.2955604
693	1.9358598	736	1.9960599	779	2.0528408	822	2.1065702	865	2.1575593	908	2.2060741	951	2.2523438	994	2.2965670
694	1.9373017	737	1.9974177	780	2.0541237	823	2.1077861	866	2.1587148	909	2.2071748	952	2.2533948	995	2.2975725
695	1.9387416	738	1.9987736	781	2.0554049	824	2.1089998	867	2.1598687	910	2.2082744	953	2.2544446	996	2.2985770
696	1.9401794	739	2.0001278	782	2.0566845	825	2.1102128	868	2.1610215	911	2.2093727	954	2.2554934	997	2.2995806
697	1.9416152	740	2.0014800	783	2.0579624	826	2.1114243	869	2.1621729	912	2.2104697	955	2.2565411	998	2.3005831
698	1.9430489	741	2.0028305	784	2.0592388	827	2.1126343	870	2.1633230	913	2.2115656	956	2.2575877	999	2.3015846
699	1.9444805	742	2.0041790	785	2.0605135	828	2.1138428	871	2.1644718	914	2.2126603	957	2.2586332	1000	2.3025851
700	1.9459099	743	2.0055258	786	2.0617866	829	2.1150499	872	2.1656192	915	2.2137538	958	2.2596776	1100	2.3078952
701	1.9473376	744	2.0068708	787	2.0630580	830	2.1162555	873	2.1667653	916	2.2148462	959	2.2607209	1200	2.3132055
702	1.9487632	745	2.0082140	788	2.0643278	831	2.1174596	874	2.1679101	917	2.2159372	960	2.2617631	1500	2.3185152
703	1.9501866	746	2.0095553	789	2.0655961	832	2.1186622	875	2.1690536	918	2.2170272	961	2.2628042	2000	2.3238252

STRENGTH OF CAST IRON AND WROUGHT IRON PILLARS.

A SERIES OF TABLES DEDUCED FROM SEVERAL OF MR. EATON HODGKINSON'S FORMULÆ, SHOWING THE BREAKING WEIGHT AND SAFE WEIGHT OF CAST IRON AND WROUGHT IRON UNIFORM CYLINDRICAL PILLARS. By WILLIAM BRYSON, C.E.*

D = diameter or side of the square of solid pillar in inches. | D = external diameter of hollow pillar in inches. | L = length or height of the pillar in feet.
 in inches. | d = internal diameter of hollow pillar in inches. | W = breaking weight in tons.

Hollow Uniform Cylindrical Pillars of Cast Iron with both Ends Rounded.

Solid Uniform Cylindrical Pillars of Cast Iron with Both Ends Rounded, and with Both Ends Flat.

Length in Feet.	No. of diameters contained in the length or height.	External diameter in inches.	Internal diameter in inches.	W = 13 $\frac{D^{3.6} - d^{3.6}}{L^{1.7}}$		Length in Feet.	No. of diameters contained in the length or height.	Diameter in inches.	Solid uniform cylindrical pillars of cast iron with both ends rounded.		Solid uniform cylindrical pillars of cast iron with both ends flat.	
				Breaking Weight in tons.	Breaking weight in tons.				W = 14.9 $\frac{D^{3.76}}{L^{1.7}}$	Breaking Weight in tons.	W = 44.16 $\frac{D^{3.55}}{L^{1.7}}$	Breaking weight in tons.
8	32	3	2	15.18	18.54	8	32	3	27.03	63.60		
9	36	3	2	12.43	15.09	9	36	3	22.12	52.06		
10	40	3	2	10.39	12.64	10	40	3	18.49	43.52		
11	44	3	2	8.83	10.73	11	44	3	15.73	37.01		
12	48	3	2	7.62	9.25	12	48	3	13.56	31.92		
13	52	3	2	6.65	8.08	13	52	3	11.84	27.86		
14	56	3	2	5.86	7.12	14	56	3	10.43	24.56		
15	60	3	2	5.21	6.33	15	60	3	9.28	21.84		
16	64	3	2	4.67	5.67	16	64	3	8.31	19.57		
17	68	3	2	4.21	5.12	17	68	3	7.50	17.65		
18	72	3	2	3.82	4.64	18	72	3	6.81	16.02		
19	76	3	2	3.49	4.23	19	76	3	6.21	14.61		
20	80	3	2	3.19	3.88	20	80	3	5.69	13.39		
21	84	3	2	2.94	3.57	21	84	3	5.24	12.33		
22	88	3	2	2.71	3.30	22	88	3	4.84	11.39		
23	92	3	2	2.52	3.06	23	92	3	4.48	10.56		
24	96	3	2	2.34	2.84	24	96	3	4.17	9.82		
25	100	3	2	2.18	2.66	25	100	3	3.89	9.16		

* Journal of the Franklin Institute.

Solid Uniform Cylindrical Pillars of Wrought Iron with Both Ends Rounded, and with Both Ends Flat.

Length in feet.	No. of diam. contained in the length or height.	Diam. in inches.	With both ends rounded.	With both ends flat.
			$W = 42.8 \frac{D^{3.76}}{L^2}$ Breaking weight in tons.	$W = 133.75 \frac{D^{3.55}}{L^2}$ Breaking weight in tons.
8	32	3	41.60	103.23
9	36	3	32.87	81.44
10	40	3	26.63	66.07
11	44	3	22.00	54.60
12	48	3	18.49	45.88
13	52	3	15.75	39.09
14	56	3	13.58	33.71
15	60	3	11.81	29.36
16	64	3	10.40	25.80
17	68	3	9.21	22.86
18	72	3	8.21	20.39
19	76	3	7.37	18.30
20	80	3	6.65	16.51
21	84	3	6.03	14.98
22	88	3	5.50	13.65
23	92	3	5.08	12.49
24	96	3	4.62	11.47
25	100	3	4.26	10.57

Hollow Uniform Cylindrical Pillars of Cast Iron, with Both Ends Flat.

Length in feet.	No. of diam. contained in the length or height.	External diam. in inches.	Internal diam. in inches.	$W = 46.65 \frac{D^{3.55} - d^{3.55}}{L^{1.7}}$	$W = 44.3 \frac{D^{3.6} - d^{3.6}}{L^{1.7}}$
				Breaking weight in tons.	Breaking weight in tons.
8	32	3	2	51.26	51.74
9	36	3	2	41.93	42.36
10	40	3	2	35.08	35.42
11	44	3	2	29.83	30.11
12	48	3	2	25.73	25.97
13	52	3	2	22.44	22.67
14	56	3	2	19.79	19.98
15	60	3	2	17.60	17.77
16	64	3	2	15.77	15.93
17	68	3	2	14.19	14.36
18	72	3	2	12.91	13.03
19	76	3	2	11.78	11.89
20	80	3	2	10.79	10.89
21	84	3	2	9.93	10.02
22	88	3	2	9.18	9.26
23	92	3	2	8.51	8.59
24	96	3	2	7.91	7.99
25	100	3	2	7.38	7.46

Hollow Uniform Cylindrical Pillars of Cast Iron with Both Ends Flat.

Length in feet.	No. of diam. contained in the length or height.	External diam. in inches.	Internal diam. in inches.	$W = 44.34 \frac{D^{3.55} - d^{3.55}}{L^{1.7}}$	$W = 42.347 \frac{D^{3.5} - d^{3.5}}{L^{1.63}}$
				Breaking weight in tons.	Breaking weight in tons.
8	32	3	2	48.72	50.49
9	36	3	2	39.88	41.79
10	40	3	2	33.34	35.19
11	44	3	2	28.35	30.13
12	48	3	2	24.45	26.14
13	52	3	2	21.34	22.95
14	56	3	2	18.81	20.33
15	60	3	2	16.73	18.17
16	64	3	2	14.99	16.36
17	68	3	2	13.49	14.81
18	72	3	2	12.27	13.50
19	76	3	2	11.20	12.36
20	80	3	2	10.26	11.37
21	84	3	2	9.44	10.50
22	88	3	2	8.72	9.73
23	92	3	2	8.09	9.04
24	96	3	2	7.52	8.44
25	100	3	2	7.01	7.90

Hollow Uniform Cylindrical Pillars of Cast Iron, with Both Ends Rounded.

Length in feet.	No. of diam. contained in the length or height.	External diam. in inches.	Internal diam. in inches.	$W = 13 \frac{D^{3.6} - d^{3.6}}{L^{1.7}}$	Safe weight in tons.
				Breaking weight in tons.	
8	16	6	4	184.08	46.02
10	20	6	4	125.97	31.49
12	24	6	4	92.43	23.10
14	28	6	4	71.11	17.77
10	17.143	7	5	200.72	50.18
12	20.571	7	5	147.16	36.79
14	24	7	5	113.23	28.30
16	27.428	7	5	78.52	19.63
12	18	8	6	218.73	54.68
14	21	8	6	168.35	42.08
16	24	8	6	134.16	33.54
18	27	8	6	109.72	27.43
14	16.8	10	8	321.75	80.43
16	19.2	10	8	256.36	64.09
18	21.6	10	8	209.82	52.45
20	24	10	8	175.37	43.84
16	16	12	10	430.82	107.70
18	18	12	10	352.69	88.17
20	20	12	10	294.84	73.71
22	22	12	10	250.64	62.66

Hollow Uniform Cylindrical Pillars of Cast Iron with Both Ends Flat.

Length in feet.	No. of diam. contained in the length or height.	External diam. in inches.	Internal diam. in inches.	$W = 46.65 \frac{D^{3.55} - d^{3.55}}{L^{1.7}}$	Safe weight in tons.	Assum'd breaking weight if irregularly set, in tons.	Assumed safe weight if irregularly set, in tons.
				Breaking weight in tons.			
8	32	3	1 1/2	61.43	15.35	20.47	5.11
9	36	3	1 1/2	50.28	12.57	16.76	4.19
10	40	3	1 1/2	42.14	10.53	14.04	3.51
11	44	3	1 1/2	35.76	8.94	11.92	2.98
12	48	3	1 1/2	30.84	7.71	10.28	2.57
13	52	3	1 1/2	26.92	6.73	8.97	2.24
14	56	3	1 1/2	23.73	5.93	7.91	1.97
15	60	3	1 1/2	21.10	5.27	7.03	1.75
16	64	3	1 1/2	18.91	4.72	6.30	1.57
17	68	3	1 1/2	17.05	4.26	5.68	1.42
18	72	3	1 1/2	15.48	3.87	5.16	1.29
19	76	3	1 1/2	14.12	3.53	4.70	1.17
20	80	3	1 1/2	12.94	3.23	4.31	1.07
21	84	3	1 1/2	11.90	2.97	3.96	0.99
22	88	3	1 1/2	11.00	2.75	3.66	0.91
23	92	3	1 1/2	10.20	2.55	3.40	0.85
24	96	3	1 1/2	9.49	2.37	3.16	0.79
25	100	3	1 1/2	8.85	2.21	2.95	0.73
26	104	3	1 1/2	8.28	2.07	2.76	0.69
27	108	3	1 1/2	7.76	1.94	2.58	0.64
28	112	3	1 1/2	7.30	1.82	2.43	0.60
29	116	3	1 1/2	6.88	1.72	2.29	0.57
30	120	3	1 1/2	6.49	1.62	2.16	0.54

Hollow Uniform Cylindrical Pillars of Cast Iron, with Both Ends Flat.

Length in feet.	No. of diam. contained in the length or height.	External diam. in inches.	Internal diam. in inches.	$W = 44.31 \frac{D^{3.55} - d^{3.55}}{L^{1.7}}$	Safe weight in tons.
				Breaking weight in tons.	
15	45	4	2	55.72	13.93
15	36	5	3	112.53	28.14
15	30	6	4	196.05	49.01
				$W = 42.347 \frac{D^{3.5} - d^{3.5}}{L^{1.63}}$	
15	45	4	2	59.81	14.95
15	36	5	3	119.30	29.82
15	30	6	4	205.59	51.39
				$W = 46.65 \frac{D^{3.55} - d^{3.55}}{L^{1.7}}$	
15	45	4	2	58.62	14.65
15	36	5	3	118.44	29.61
15	30	6	4	206.27	51.56
				$W = 44.3 \frac{D^{3.6} - d^{3.6}}{L^{1.7}}$	
15	45	4	2	59.85	14.96
15	36	5	3	122.50	30.62
15	30	6	4	215.56	53.89

(To be continued.)

AEROMETRY.*

(Continued from page 209.)

506. *Conical Ajutages.*—We pass to conical ajutages, those most generally used.

The better to compare their effects with those of cylindrical ajutages, the same orifice of issue and the same length were given to them.

Ajutages.			Mano- metric Height.	Length of Descent.	Time of Descent.	Co-efficient.		
Diameter at		Length.				By Experiment.	Mean.	
Outlet.	Inlet.		feet.	feet.	seconds.			
.0328	.0656	.1312	.1640	1.968	96	.928	.927	
.0328	.0656	.1312	.2362	1.968	81	.917		
.0328	.0656	.1312	.3149	1.968	69	.934		
.0328	.0656	.1312	.3930	1.968	62	.930	.917	
.0492	.0984	.1476	.0918	1.968	57.5	.913		
.0492	.0984	.1476	.1640	1.968	43	.916		
.0492	.0984	.1476	.2362	1.968	36	.915	.936	
.0492	.0984	.1476	.3149	1.804	28.5	.927		
.0492	.0984	.1476	.3930	1.804	25	.916		
.0656	.1312	.1968	.0885	1.968	32	.945	.933	
.0656	.1312	.1968	.1213	1.968	27.5	.915		
.0656	.1312	.1968	.1640	1.968	24	.928		
.0656	.1312	.1968	.1968	1.968	22	.924	.924	
.0984	.1968	.2624	.1312	1.968	12	.924		
.0984	.1968	.2624	.1640	1.968	11.5	.942		
General Mean.....							.928	

Thus for conical ajutages, as well as for cylindrical, the co-efficient is 0.93.

507. Wishing to know the effect of conical ajutages in the proportion of their convergence, or the increase of the angle formed by the opposite sides of the cone, I made five ajutages, all having at the outlets an orifice .049ft., but with different angles. They served me for a series of experiments similar to the others; I limit myself to giving the derived co-efficients.

Ajutage.		The Manometeic Height being at					Co-effi- cient mean.
Angle of con- vergence.	Length, feet.	.092 ft.	.164 ft.	.236 ft.	.315 ft.	.039 ft.	
6° 26'	.1476	.939	.939	.940	.933938
18° 54'	.1476	.912	.916	.915	.927	.916	.917
53° 08'	.1476	.786	.810	.797	.803	.794	.798
11° 24'	.0820	.946	.939	.949	.960	.951	.947
28° 04'	.0328	.888	.877	.881	.881	.874	.880

A glance at the table shows the advantage of short and slightly converging ajutages. When the angle of convergence does not exceed from 10° to 12°, the co-efficient will be .94 nearly: as it becomes greater, the co-efficient and discharge diminish, and we approximate to the phenomena presented by orifices in a thin side.

508. According with these facts, the value of *m* in the expression of discharge.

$$1296 m S \sqrt{H \frac{T}{b + H}}, \text{ will be}$$

- .65 for orifices in a thin side.
- .93 for cylindrical ajutages.
- .94 for slightly conical ajutages.

509. *Discharge through Nozzles.*—Nearly all the ajutages used in practice, such as the nozzles at the end of wind trunks in manufactories, of bellows, falling in with the last conditions, .94 will often be the suitable co-efficient; still, on account of their length, and for greater surety, we shall adopt for these nozzles .93. Then observing that $S = .785 d^2$, *d* being the diameter of the outlet orifice, we have

$$Q = 848.18 d^2 \sqrt{H \frac{T}{b + H}}$$

In the volume given by this expression, the air is supposed to be of the same density as that of the interior of the reservoir from which it issues; and consequently to be under the pressure *b* + *H*. We may transform this volume into that which the same mass of air would occupy under a given pressure *b'*, by multiplying the above value by the ratio $\frac{b + H}{b'}$ of the two pressures. Moreover,

we usually take the air under the atmospheric pressure supposed to be 2'4934ft.; then *b'* = 2'4934ft., and we have

$$Q = \frac{948.18}{b'} d^2 \sqrt{H (b + H) T} = 380 d^2 \sqrt{H (b + 8) T}$$

510. If we wish to have the weight of the mass of air discharged in a unit of time, we multiply the first of the two values of *Q* just given by

$$.032533 \frac{b + H}{1 + .00222 (t - 32)}$$

the weight of a cubic foot of air under the pressure *b* + *H*, and at the temperature *t* (495); so that if *P* represents in lbs. the weight sought, we shall have

$$P = 30.787 d^2 \sqrt{H \frac{b + H}{T}}$$

511. In applications we usually adopt for *b* and *t*, the mean values of the heights of barometer and of thermometer in the place of experiments.

If *l* is the latitude of the place, and *e* its approximate elevation above the level of the sea, we have

$$b = 2.5 \text{ feet} - 0.00009 e, \quad (433)$$

$$t = 82.8 \cos l - .001981 e - 0.4.$$

We may also without any very serious error, cancel *b* and *t* of the formulæ, substituting for them a mean for a great extent of country; thus, for France, we would make *t* = 53°6 or *T*' = 1.048, *b* = 2'46ft., and *b* + *H* = 2'559ft., and we shall have

$$Q = 621.28 d^2 \sqrt{H} \text{ cubic feet, and}$$

$$P = 48.073 d^2 \sqrt{H} \text{ pounds.}$$

512. *General Discharge for Gas.*—The principles which we have established, and the rules we have deduced for the flow of atmospheric air, apply to that of other aeriform fluids, with modifications depending upon the density of each.

Let there be, for example, a gas whose density in its ratio to that of the manometric fluid is *d*, and which issues from a reservoir, under a manometric pressure *H*. Its velocity of issue will be due to the height *H*, increased in the ratio of the density of mercury to that of the gas (500); and *Q* being the volume of the discharge per second of the latter, we shall have

$$Q = m S \sqrt{2 g \frac{H}{d}}$$

For another gas, of which *d'* is the density, and *Q'* the volume discharged, all else being equal, we shall have

$$Q' = m S \sqrt{2 g \frac{H}{d'}}$$

Thus,

$$Q : Q' :: \sqrt{\frac{1}{d}} : \sqrt{\frac{1}{d'}} :: \sqrt{d'} : \sqrt{d};$$

that is to say, *the volumes of two gases flowing through equal orifices, and under equal pressures, are in the inverse ratio of the square roots of their respective densities.*

Consequently, if atmospheric air is one of the gases, and *p* is the specific weight of the other (493), the ratio of the densities being that of 1 to *p*, the discharge of the last gas will be

$$\frac{380 d^2}{\sqrt{p}} \sqrt{H (b + H) T}$$

513. *EXAMPLES.*—Required the volume of atmospheric air reduced to a barometric pressure of 2'477ft., which a reservoir will furnish, upon which the mercury-manometer stands at .098ft., and to which is fitted a nozzle .246ft. in diameter. It is in the 45th degree of latitude, and 656ft. above the level of the sea.

In such a place we have as a mean (511) *b* = 2'44ft., and *t* = 55°4'. According to the above data we also have *H* = .098ft., *d* = .246ft., and *b'* = 2'477; consequently, *T* = 1'052, and *b* + *H* = 2'539.

The volume of air discharged in one second will then be (509)

$$948.18 \frac{(.246)^2}{2.477} \sqrt{.098 \times 2.539 \times 1.052} = 11.85$$

Thus the reservoir will deliver 11.85 cubic feet of air per second; such a quantity is sufficient to keep in action the fire of four or five large refining forges.

* From the *Journal of the Franklin Institute.*

514. What should be the height of the mercury column in the manometer to cause a discharge through a nozzle .19ft. diameter of 7lbs. of atmospheric air in 1 sec. ? The barometer as a mean stands at 2'46ft., and the thermometer at 51'8°. From the relation

$$P = 30 \cdot 787 d^2 \sqrt{H \frac{b+H}{T}};$$

by squaring and solving the equation of the second degree we deduce

$$H = -\frac{1}{2}b + \sqrt{\frac{P^2 T}{(30 \cdot 787)^2 d^4} + \frac{1}{4}b^2}.$$

Here we have $P = 7$ lbs., $b = 2'46$ ft., $d = .19$ ft., and $T = 1'044$. These quantities, substituted in the above equation, give $H = 0'158$. Thus the required manometric height sought is '158ft.

If we had used the more simple formula (511),

$$P = 48 \cdot 073 d^2 \sqrt{H},$$

we should have

$$H = \frac{.7^2}{(48 \cdot 073)^2 (.19)^4} = 1627.$$

515. A gasometer discharges 9'8109 cubic feet of illuminating gas per second, under a charge represented by a column of water '147ft. Required the size of the orifice to be made in the side of the gasometer to produce this flow. The barometer in this locality is usually at 2'477ft., and the thermometer at 59°.

We have then $b = 2'477$ ft., and $T = 1'06$; moreover $Q = 9'8109$ cubic feet per second; and a manometric column of water of '147ft. is equivalent to one of mercury of

$$\frac{147}{13 \cdot 6} = .010808 \text{ft.} = H.$$

The specific weight of illuminating gas (carburetted hydrogen) is, according to Berzelius and Dulong, '559 = p . The gasometer being made of copper sheets, the orifice will be made in a thin side, and the corresponding value of $m = 0'65$. The general equation (508 and 512)

$$Q = \frac{1296 m S}{\sqrt{p}} \sqrt{H \frac{T}{b+H}}$$

gives here

$$S = \frac{9 \cdot 8109 \times \sqrt{.559} \times \sqrt{2 \cdot 477 + .010808}}{1296 \times .65 \times \sqrt{.010808 + 1 \cdot 06}} = .1283.$$

Thus the required orifice will have a surface of '1283 square feet, or a square with its sides equal to '358 feet,—or if circular, '403 feet diameter.

(To be continued.)

BRITISH ASSOCIATION FOR THE ADVANCEMENT OF SCIENCE.

THIRTY-FIRST ANNUAL MEETING, HELD AT MANCHESTER, SEPT., 1861.

WILLIAM FAIRBAIRN, ESQ., C.E., LL.D., F.R.S., PRESIDENT.

SECTION G (MECHANICAL SCIENCE).

REPORT OF THE COMMITTEE ON STEAMSHIP PERFORMANCE.

At the meeting of the British Association, held at Oxford in June, 1860, the Committee was re-appointed in the following terms:—

"That the Committee on Steamship Performance be re-appointed to report proceedings to the next meeting.

"That the attention of the Committee be also directed to the obtaining of information respecting the performance of vessels under sail, with a view to comparing the results of the two powers of wind and steam, in order to their most effective and economical combination.

"That the sum of £150 be placed at the disposal of the Committee."

The following noblemen and gentlemen were nominated to serve on the Committee:—

Vice-Admiral Moorsom,
The Duke of Sutherland (formerly
Marquis of Stafford),
The Earl of Caithness,
The Lord Dufferin,
William Fairbairn, F.R.S., LL.D.,
J. Scott Russell, F.R.S.,
Admiral Paris, C.B.,

The Hon. Capt. Egerton, R.N.,
William Smith, C.E.,
J. E. McConnell, C.E.,
Professor Rankine, LL.D.,
J. R. Napier, C.E.,
R. Roberts, C.E.,
Henry Wright (*Hon. Sec.*)

With power to add to their number.

The following gentlemen also assisted your Committee as corresponding members:—

Lord C. Paget, M.P., C.B.,
Lord Alfred Paget, M.P.,
Lord John Hay, M.P.,
The Earl of Gifford, M.P.,
The Marquis of Hartington, M.P.,
Viscount Hill,
The Hon. Leopold Agar Ellis, M.P.,
Captain Ryder, R.N.,

Captain Hope, R.N.,
Captain Mangles,
T. R. Tufnell,
William Froude,
John Elder,
David Rowan,
J. McFarlane Gray.

Your Committee re-elected Admiral Moorsom to be their Chairman, and at his decease the Duke of Sutherland succeeded him.

Your Committee having held monthly meetings and intermediate meetings of a Sub-Committee, presided over by the Chairman, beg leave to present the following report:—

At the last meeting of the British Association, after the Committee's Report had been presented, Admiral Moorsom read a paper before the mechanical section on the performance of steam vessels, and a discussion ensued which demonstrated the great want that is felt by men of science both in England and in other countries, of definite knowledge based on actual experiment respecting the resistance offered by vessels of various sizes and types, to be drawn through the water. As the means of trying such experiments could only be satisfactorily obtained from a government having every description of vessel in its service, your Committee determined urgently to renew their applications to the British Admiralty, that that body should, for the benefit of science generally, conduct a series of experiments; and to state that the Committee were even prepared to advise upon or conduct such experiments, if the Admiralty so desired.

The Chairman accordingly communicated with the First Lord of the Admiralty, repeating the various arguments hitherto advanced, with concise statements of the general nature of the detailed experiments deemed necessary, and which are briefly as follows:—

1.—The specific resistance of certain ships selected as types, and of the following displacements, viz.:—About 1000, 2000, 3000, 4000, 5000, 6000, 7000 tons, and upwards. Such resistance under traction being measured by dynamometer, and under the three following conditions:—

- (1.) Of the hull when launched.
- (2.) Ditto with machinery on board.
- (3.) Ditto when ready for sea.

2. The thrust of the screw measured by dynamometer, when propelled by steam under the two last of the above three conditions, and under similar circumstances of smooth water and calm.

3. Full particulars of the dimensions and form of the ships, of the boilers and furnaces, of the engines, and of the propeller.

4. Detailed particulars of the performance of the same or similar ships in smooth water at the measured mile, with the particulars and conditions set forth in a form of return which accompanied the memorandum, or any other more comprehensive or effectual that might be given.

5. The actual performance of the same or similar vessels at sea, with the particulars and conditions set forth as aforesaid.

Your Committee would remark in passing, that from the date of their first appointment, they have not ceased, on every available occasion, to press this subject upon the attention of the authorities; but up to the present time, your Committee are not aware that any experiments of the kind have been undertaken.

In the report presented to your Association at Oxford, it is stated that a table of certain of Her Majesty's vessels, seventeen in number, had been constructed, containing the results of the test trials as conducted by the Government officers, and that it had been forwarded to the Admiralty with the request that the additional particulars of the hull and machinery might be filled in. The table, however, did not arrive in time to be inserted in their report.

Your Committee have great pleasure in being now enabled to lay it before your Association in the state it has been received from the Admiralty. (Appendix, Table 1.)* They would remark in connection with this return, that it appears that the authorities have not been in the habit of recording either the quantity of coals consumed, or the evaporation of water, and they have made application to the Admiralty that in future these desiderata may be obtained.

In compliance with the terms of the resolution appointing the Committee, viz., "that the attention of the Committee be also directed to obtaining information respecting the performance of vessels under sail, with a view to comparing the results of the two powers of wind and steam," your Committee have to state that hitherto they have been unable to obtain such comparisons in the case of merchant vessels, but in the table given in Appendix, table 2, particulars of one of H.M. vessels are recorded under three conditions, viz., under steam alone, under sail alone, and under steam and sail combined, and of two under the two latter conditions only.

These are especially useful, as they show the effects produced by powers brought to bear upon the hulls of vessels under the same conditions as to draft and trim, but differently applied.

In endeavouring to collect this information from officers in H.M.'s service, the Committee were desirous that the application should be made with the concurrence of the Admiralty, and a circular was accordingly issued to a selected number of officers, accompanied by a form, which they were requested to fill up and return. At the request of the Admiralty copies of these documents were submitted for their inspection.

The circular stated that the Committee had apprised the Admiralty of the Committee's proposal to communicate with such captains and engineers of H.M. vessels as might be disposed to assist the British Association in obtaining facts for scientific calculations relating to the performance of ships at sea.

The form proposed was as simple as was consistent with the object of obtaining data necessary for calculation, and the Committee conceived that the time required

* Tables accompanying Steam Ship Committee Report. We are unavoidably prevented giving these tables in our issue of this month. [ED. ARTIZAN.]

to fill up such forms would not interfere with the duties of the respective officers. It also stated that the Committee invited the co-operation of officers for the benefit of science alone, and that one of the fundamental rules laid down by the Association in directing their labours, was as follows:—

“The object of the Committee is to make public recorded facts, through the medium of the Association, which being accessible to the public in that manner, will bring the greatest amount of science to the solution of the difficulties now existing to the improvement of the forms of vessels, and the qualities of marine engines. They will especially endeavour to guard against information so furnished to them being used in any other way.”

Your Committee issued the circular and form of return (see appendix 2) to upwards of 200 of H.M. captains in commission, and to their chief engineers through the captains.

Numerous replies have been received promising returns, but the distance at which most of the vessels are stationed, namely, China, the East Indies, and America, has precluded our receiving such particulars in time for this Report. Returns, however, of seven vessels have been received, six of which are given in appendix, table 2; and the seventh vessel, the *Victor Emanuel*, being returned in a different form, is given separately in appendix, tables 3 and 4. This is the more valuable, as the returns of seven trials on the measured mile are given with it.

Your Committee are aware that several officers are conducting a series of experiments under various conditions, which it is their intention to report to your Association, through this Committee, on their return home.

The log-hook, compiled by your Committee, is also being filled up by the same officers, with a similar object.

Your Committee have met with great success in their applications to shipowners, engineers, and builders for information respecting the sea performances of merchant vessels. In no case have they met with a refusal to supply all the data in their possession, and your Committee have reason to believe that before long the records kept on the voyages will be amplified, and the data thus obtained be published periodically by shipowners themselves.

The thanks of the Committee are especially due to the Peninsular and Oriental Company, to the London and North Western Company, to the Pacific Steam Navigation Company, to the City of Dublin Steam Packet Company, to Messrs. Morrison and Co., of Newcastle, to Messrs. Penn and Sons, the Thames Ship-building Company, Messrs. R. Napier and Son, Messrs. Faweett, Preston, & Co., and Messrs. J. and W. Dudgeon.

The Peninsular and Oriental Company freely offered their books for inspection, and placed the logs of their vessels *Candia*, *Ceylon*, *Columbia*, *Delta*, *Nubia* and *Pera* in the hands of the Committee, to make any extracts they deemed useful.

Copies of voyages from Southampton to Alexandria, and from Aden to Calcutta, and return of those vessels respectively, were taken, and the average performances worked out. They are given in the Table of Merchant Vessels (Appendix, Table 5).

The London and North Western Railway Company have furnished your Committee with information of especial value, viz., the trial performance and ordinary working performance of one of their vessels, the *Cambria*, under two conditions—the first as originally constructed, the second after being lengthened 40ft. Data of this description are precisely those required to enable the naval architect to judge what are the qualities which constitute a good vessel, and assist him in designing vessels possessed of high speed, great capacity, limited draught of water, economy of power, and all the qualities which constitute good sea-going ships, with much greater certainty than heretofore.

In the same table (No. 5) your Committee have thought fit to repeat a somewhat similar return, given in their last Report, viz., a table, &c., showing the Trial Performance of the steam vessels *Lima* and *Bogota* when fitted with single cylinder engines, and after being refitted with double cylinder engines; also the sea performances of the same vessels under both these conditions of machinery, and on the same sea service.

These returns, therefore, show the difference of performance of a vessel with the same machinery but lengthened in her hull, and of two vessels with the hull a constant, but with entirely different engines.

A glance at the column showing the consumption of coals in each case will at once demonstrate the importance of the subject in a commercial point of view.

The London and North Western Company have likewise furnished returns of the speed and consumption of coal of their express and cargo boats, under regulated conditions of time, pressure, and expansion, from January 1 to December 31, 1860 (Appendix, Table 6). Similar returns for 1858 and 1859 are contained in the two former Reports of this Committee, and show the regularity with which the service has been conducted.

Your Committee would again call the attention of shipowners to the system of trials which has resulted in the combination of perfect regularity and efficiency of service with economy (so far as the vessels and machinery would admit) which this series of returns exhibits.

In the first Report of this Committee, presented to your Association at the meeting held in Aberdeen, a series of tables are given, showing the method which was adopted for ascertaining the working capabilities of each vessel. The following explanation was furnished by Admiral Moorsom, and illustrates the means by which the proper service to be obtained from a vessel may be estimated:—

“When the four passenger vessels, *Anglia*, *Cambria*, *Hibernia*, and *Scotia* were first employed in August, 1848, the commanders were authorised to drive them as hard as they could, subject only to the injunction not to incur danger.”

After some months' trial the qualities of each vessel and her engines were ascertained, and a system was brought into operation which continues to the present time. (Tables 3-15).

[The returns No. 2 and 6 show the results of the *hard driving* and the commencement of the *system* periods. The column indicating “Time,” “Pressure,” and “Expansion,” is the key to the columns “Average Time of Passage,” “Weight on Safety Valves,” and “Proportion of Steam in Cylinder,” and as a sequence also to the consumption of coal.

“Time a minimum” shows the *hard driving*. “Time a constant” shows the *system*. The relations of “pressure” and “expansion” show how, under *hard driving*, the highest pressure and the full cylinder produced the highest speed the wind and tide admitted, or how, the time being a constant, those two elements were varied at the discretion of the commander, within prescribed limits, to meet the conditions of wind and tide.

The result of the *system* on the coal is a decreasing consumption.

The Return No. 1 shows the results of certain trials under favourable conditions, but in the performance of the daily passage by four of the vessels, which results are used as the standard tests with which the results of each quarter's returns are compared.

For example: the *Scotia* at 15.9 statute miles an hour consumes 6840 lbs. of coal as a standard. (See Table 4.)

In the Return No. 3, at the speed 12.96 miles, she consumed 5226 lbs.; the first at the rate of 430 lbs. per mile (see Table 5), and the second at about 403.

Again, in the succeeding quarter, the *Scotia* consumed 7528 lbs. at 14.65 miles an hour, or more than 513 lbs. per mile.

Here was a case for inquiry and explanation. It will be observed that in Return No. 1 the consumption of the *Scotia* at ordinary work at sea is 5320 lbs. per hour, and it is only when the consumption exceeds 6840 lbs. that it becomes a subject of question, the difference between those figures being allowed for contingencies.

No. 4 (see Tables 12, 13) is a return which shows the difference between the issues of coal each half year, and the aggregate of the returns of consumption, the object of which needs no elucidation.

No. 5 (see Table 14) shows the duration of the boilers, with particulars of the work done. The saving in money under the return system, as compared with *hard driving*, was of course very considerable, and the latter was only justifiable as a necessary means of learning the qualities of each vessel, to be afterwards redeemed by the economy of the *system*.

The *Hibernia*, it will be seen, was unequal to the service; and I may here observe that experience has shown me that in machinery, as in animal power, it is essential that it should be considerably above its ordinary work.

The want of this extra power was a defect of the early locomotive engines, whose cost of working per mile was very considerably higher than that of the engines now in use.

This defect, which is that of boiler power, prevails largely in steam vessels, and especially in the Queen's ships.

It would be easy to show how system *must* tend to economy; and the saving of coal is apparent from the returns, and of course all the engine stores are commensurate.

But the repairs—the wear and tear—involve a much more important element of economy than even a reduced consumption of coal.

The return for 1860 is accompanied by a check account of the consumption of coal. (Appendix, Table 7.)

The City of Dublin Steam Packet Company have obligingly furnished returns of the consumption of coal, and average time of passages of their mail boats *Prince Arthur*, *Llewellyn*, *Eblana*, and *St. Columbia*, from January 1st to December 30th, 1860, the last quarter embracing the fast vessels *Leinster* and *Ulster*. (Appendix, Tables 8 and 9.)

Your Committee were invited to attend a trial of the latter vessels between Holyhead and Kingstown, and a deputation consisting of Admiral Moorsom, the Duke of Sutherland, Lord Alfred Paget, Wm. Smith, C.E., J. E. McCounell, and H. Wright attended. They were kindly assisted by Mr. Watson, the Managing Director of the company, in obtaining information connected with these vessels and their performances. The particulars of these trials will be found in Appendix, Table 5.

A deputation from your Committee, consisting of Mr. W. Smith and Mr. Wright, also at the invitation of the London and North Western Railway Company, attended the trial of the *Admiral Moorsom*, a new cargo boat built expressly for the conveyance of live stock. The particulars are given in Appendix, Table 5, to which your Committee would direct attention, as the speed obtained, and the steadiness exhibited by the vessel in a very heavy sea, excited considerable surprise. They have received numerous invitations from other companies and shipowners to attend the trials of their vessels.

Your Committee have been in correspondence with the Imperial naval authorities of France, and of the United States.

The latter have already published various trials conducted with admirable skill and precision, and embracing most of the particulars asked for by the Committee.

In France, the Company of the Messageries Impériales have for some time given annual averages of the results of the navigation of the vessels in their service, for private use only; but on the application of your Committee to be supplied with such returns, copies were at once forwarded, with a letter from the President stating that although it was not the usual custom of private companies to make public the information requested, and although the Report transmitted to them (the Committee's 2nd Report) contained no analogous comparison of the state of the great English companies who perform similar service, nevertheless, they have not hesitated to accede to the Committee's wish, by contributing as much as lay in their power, thus proving their cordial sympathy with the useful object the British Association have in view.

The tables of results of their vessels, fifty in number, for the years 1859 and 1860, are given in appendix, tables 10 and 11, constituting, with the one given in the last report, a valuable series extending over three consecutive years.

Your Committee take this opportunity of expressing their satisfaction in being

* See Vol. of Transactions of the Aberdeen Meeting, 1859, page 276.

able to report that since the commencement of their labours in 1857, the interest that has been taken in steamship performance, and the desire to assist the Association in eliciting information on the subject, not only by officers in the Royal Navy, but also of the merchant service, fully bear out the opinion expressed at the meeting of the Association in Dublin, that this subject was second to none in importance, and that its steady pursuit would tend very materially to the advancement of the science of shipbuilding and marine engineering.

The following is a general summary of the results of the Committee's labours during the past season. They have obtained—

1. The particulars of the machinery and hulls of seventeen of H.M. vessels, and the details of 58 trials made during the years 1857, 1858, and 1859, supplied by the Admiralty. The Committee are in possession of copies of the diagrams taken during the trials in 1859, with notes of observed facts by the officers conducting the trials. The names of the vessels are the *James Watt*, *Virago*, *Hydra*, *Centaur*, *Industry*, *Diadem*, *Mersey*, *Algerine*, *Leven*, *Lee*, *Slaney*, *Flying Fish*, *Marlborough*, *Orlando*, *Bullfinch*, *Doris*, and *Renown*. (Appendix, Table 1.)

2. Returns of seven of H.M.'s vessels when at sea, under various circumstances, viz., under steam alone, under sail alone, and under sail and steam combined. The names of these vessels are the *Colossus*, *Chesapeake*, *Flying Fish*, *St. George*, *Olio*, *Sphinx*, and *Victor Emanuel*.

3. Return of the London and North Western Company's steamboat *Cambria*'s trials and ordinary performances as originally built, and after being lengthened; also of the Pacific Steam Navigation Company's vessels *Lima* and *Bogota*, when fitted with original and other machinery; also of the new cargo boat, the *Admiral Moorson*.

4. Returns of the Peninsular and Oriental Company's boats *Colombo*, *Candia*, *Ceylon*, *Delta*, *Nubia*, and *Pera*, when on voyages between Southampton and Alexandria, and between Suez and Bombay respectively, together with particulars of their machinery and hulls, furnished by the builders and engineers.

5. Returns of the Pacific Steam Navigation Company's vessels *Guayaquil* and *Valparaiso*, with particulars of trials and sea voyages during 1860.

6. Returns of the trials of the vessels *Leonidas*, *Mavrocordato*, *Penelope*, furnished by Messrs. Morrison and Co., and the *Thunder*, and *Midge*, by Messrs. J. and W. Dudgeon.

7. Tables showing the results of the navigation of the steamboats in the service of the Messageries Impériales, during the years 1859 and 1860.

8. Returns of the London and North Western Company's steamboats *Anglia*, *Cambria*, *Scotia*, *Telegraph*, *Hibernia*, *Hercules*, *Ocean*, and *Sea Nymph*, under regulated conditions of time, pressure and expansion, from January 1st to December 31st, 1860. Half-yearly verification of the consumption of coals for the same period.

9. Return of the average time of passage and consumption of coal of the City of Dublin Steam Packet Company's mail steamers *Prince Arthur*, *Llewellyn*, *Eblana*, and *St. Columba*, for six months ending June 30th, 1860.

10. Ditto ditto, with the addition of the fast steamers, *Leinster* and *Ulster*, for three months ending September 30th, 1860.

11. Return of the average passages of the mail packets, *Leinster*, *Ulster*, *Munster*, and *Connaught*, for six months ending March 31st, 1860. (Appendix, Tables 13, 13, and 14.)

12. Return of the trial of the *Leinster* and *Ulster* between Holyhead and Kingstown. (Table 5.)

13. Diagrams or indicator cards* have been received, taken from the following ships:—*Cambria*, *Admiral Moorson*, *Leinster* and *Ulster*, *Colombo* (lengthened), *Nubia* and *Thunder*.

The sum of £150 voted by the council of the Association to defray the expenses of the Committee has been expended, and the statement of the expenditure, which could not be prepared in time for publication with this report, will be presented by the Committee at the meeting.

The thanks of the Committee are especially due to Mr. Wm. Smith, C.E., a member of the Committee, for the large amount of assistance he has rendered in collecting information, as also by placing a room in his offices at the disposal of the Committee.

Your Committee in conclusion, have the painful duty to record the death of their late Chairman, Admiral Moorson, and the regret which they have felt at the melancholy event which has deprived them of their Chairman, and their sense of the great loss which has thus been sustained by your Association, and by the scientific world at large, as well as by the distinguished profession to which he belonged.

(Signed) SUTHERLAND, *Chairman*.

Offices of the Committee, 19, Salisbury Street, Adelphi, London.

PATENT LAWS COMMITTEE.

The following were the resolutions of the Patent Laws Committee agreed upon in London, 1861:—

I.—That all applications for grants of letters patent should be subjected to a preliminary investigation before a special tribunal.

II.—That such tribunal shall have power to decide on the granting of patents, but it shall be open to inventors to renew their applications notwithstanding previous refusal.

III.—That the said tribunal should be formed by a permanent and salaried judge, assisted when necessary by the advice of scientific assessors, and that its sittings should be public.

IV.—That the same tribunal should have exclusive jurisdiction to try patent cases, subject to a right of appeal.

* The indicator diagrams may be seen, by any one interested therein, by application at the offices of the Committee.

V.—That the jurisdiction of such tribunal should be extended to the trial of all questions of copyright and registration of design.

VI.—That the scientific assessors for the trial of patent causes should be five in number (to be chosen from a panel of thirty to be nominated by the Commissioners of Patents), for the adjudication of facts, when deemed necessary by the judge or demanded by either of the parties.

VII.—That the right of appeal should be to a Court of the Exchequer Chamber, with a final appeal to the House of Lords.

VIII.—That for the preliminary examination the Assessors (if the judge requires their assistance) should be two in number, named by the Commissioners of Patents from the existing panel: the decision to rest with the judge.

IX.—That the Committee approve of the principle of compelling patentees to grant licenses on terms to be fixed by arbitration, or in case the parties shall not agree to such arbitration, then by the proposed tribunal, or by an arbitrator or arbitrators appointed by the said tribunal.

X.—That a report be drawn up in conformity with the resolutions passed by this Committee, and that the Council, if such report be approved by them, be requested to allow it to be read at the meeting of the British Association to be held at Manchester this year.

THE YOUNG ENGINEERS' SCIENTIFIC ASSOCIATION.

THURSDAY, SEPTEMBER 26TH, 1861.

A special meeting of this Association was held for the purpose of considering a report, containing a proposal received from the "Civil and Mechanical Engineers Society," to amalgamate with this Association, the desirability of which having been considered, it was resolved to accept the proffered union. Several of the rules were then amended, and it was determined that this Association should hereafter be known as the "Civil and Mechanical Engineer's Society." It was then announced that at the next meeting a *conversazione* would be held for the purpose of closing the present session.

THURSDAY, OCTOBER 3RD.—"CONVERSAZIONE."

On this occasion a very large collection of models and drawings were exhibited. Special interest was taken in several of the models, in particular Silvers's marine engine governors, Sandy's electric signalling apparatus, Trigwell's improved equilibrium valve, and a fine collection of cupreous and stanniferous minerals, also severally curiously crystallised spars.

During the evening several interesting addresses were given.—Mr. Camplin described the steam engine from the time of Hero, and pointed out the chief improvement in the steam engine and in the employment of steam since that date, and illustrated his subject by models of Hero's engine and of those of the present time, in motion. Messrs. Gill, Walton, and Roberts then addressed the meeting on some interesting topics.

The new session 1861-2 of this Society commenced on the 24th October, when an address by the President was given, it was then announced that on the Thursday following a paper would be read "On Steam Fire Engines," by C. B. King.

THE OAR.

Probably the most ancient mode of propelling boats through the water by hand-labour was by means of oars of nearly the same shape, and worked in the same manner, as those now in use. And to all appearance there is no likelihood of a change, for although many savage tribes work their canoes and other narrow boats with hand-paddles, and attain great speed with them, yet seamen of civilized nations, whose boats are mostly of a more burdensome character, and whose bodies are encumbered with clothing, have, without exception, given preference to the oar, as an instrument of greater power, and worked with more convenience.

And, truly, there is no more beautiful instrument than an oar, when we consider its simplicity, the ease with which it is worked, and the readiness with which its position is accommodated to the ever-varying motion of the boat and the sea's surface. It has often been proposed—indeed, it is a favourite notion with theorists—to propel life-boats by rotatory paddle-wheels and screws, such as those of steamers; but the proposition is altogether an impracticable one, and its trial could only result in failure. Where great power and velocity of motion can be applied, as by steam, undoubtedly the rotatory form is the most convenient mode through which to apply it, and accordingly, both screws and paddle-wheels work advantageously, until the rolling or pitching motion of a ship becomes very violent, when great waste of power ensues; for instance, when a ship rolls so deeply that the paddles are alternately too deeply immersed, and spinning round in the air; or if a screw ship, when she pitches so much that the screw is raised to the water's surface, or lifted above it. When, therefore, it is considered how much more violent is the motion of a boat in a heavy broken sea than that of a ship, it will be readily conceived that a fixed machine, such as a wheel or screw, even if it could be worked on so small a scale by steam power, would do so at a still greater disadvantage. Whereas the oar, obedient to the quick eye and ready arm, varies its position with every motion of the boat or wave, and in skilful hands is always working at "full power."

But there is another point of importance not to be lost sight of. A paddle-wheel or screw cannot be worked in a life-boat by steam power, but must be so by means of a crank worked by hand. Now it is known to every one that the muscles of the human body are strengthened by use, and that, therefore, persons engaged on any particular bodily labour have those muscles especially strengthened that are constantly brought into play. Thus, a sailor would stand little chance in a walking-match with a professional pedestrian; whilst the latter would as vainly attempt to overtake the former in a race over his ship's mast-head. It follows then, that apart from its other advantages, the oar is possessed of this especial one, that it is in daily use by the only class of men on the coasts who

are available to form the life-boat's crew, viz., the hardy race of fishermen and boatmen who earn their daily bread on our shores.

An oar being, then, the only instrument by which a life-boat can be propelled, too much care cannot be bestowed on it. Its size, weight, length, material, width of blade, balance, mode of attachment to the gunwale; its height above the water, and above the thwart on which the rower is seated, and the distance of the thwarts and oars apart, are all points of much importance on which the speed of the boat, or its power to make way against a head-sea, much depend.

An oar is a simple lever, of what is termed the second order, that is, wherein the weight or body to be moved lies between the fulcrum and the motive power; the water being the tulerum of the lever, the gunwale of the boat the point at which its power is applied to the moving body or weight, and the rowers' arms being the source of power.

Fir oars have always been considered the most desirable for life-boats, as they do not bend so much as ash oars, and as they float much lighter in the water,

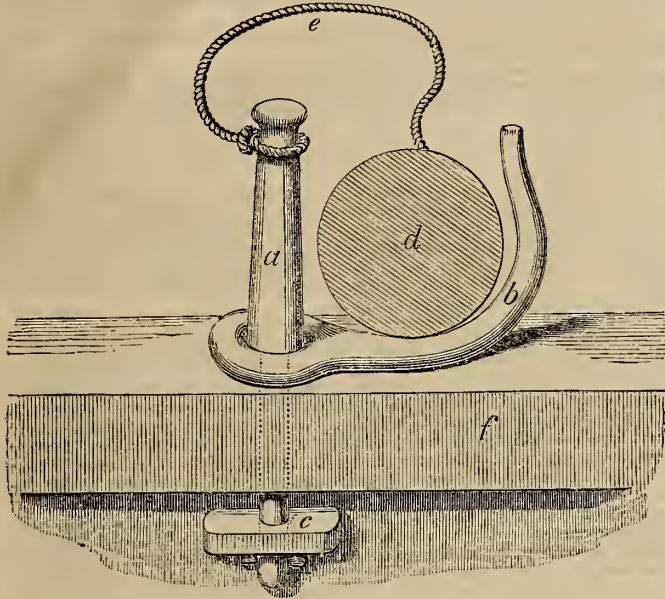

FIG. 1.

and will therefore better support any persons in it in the event of accident. Experiments have been made by the National Life-boat Institution to test the relative strength of oars, when it was ascertained that an oar made from a good white Norway batten, or from a white Baltic spar, will bear as great a strain as any other, each being as free of knots as possible.

The length of an oar must of course be proportional to the width of the boat, and it should be so poised on the gunwale that the rower can raise or depress it or move it in any direction with the smallest effort. An oar should be not less than five inches wide in the blade, or it will expose so small a surface to the water as to cut through it, and so work on a too yielding tulerum, with comparative loss of power.

The height above the thwarts, of the thowl, or rowlock, in which the oar works on the gunwale, should be sufficient to enable the rower to lift the blade well above the waves by depressing the loom or handle; but, on the

other hand, it must not be so high as to require him to raise his arms above the level of his chest in rowing, in which case he will row with much less force, and be much sooner fatigued. A height of eight inches from the thwarts to the oar on the gunwale will be found a suitable average.

Lastly, the mode of confining the oar to the gunwale of the boat is of much consequence. The most common modes, in ordinary boats, are rowlocks and double pins, between which the oar works; but as an oar is liable to jamb in the rowlock or between the pins, when rowing in a rough sea, and thereby to get broken, or to damage the gunwale, the oars of life-boats have generally been worked in a rope grummet or ring, over a single iron thowl-pin: a further advantage of this plan being that it enables the oars to lie along the outside of the boat when not in use, and thus saves the necessity of unshipping them and getting them in-board on going alongside a wreck, which is a great advantage.

A new description of swivel-crutch, intended as a substitute for a grummet, has recently been planned for the National Institution's life-boats, by its inspector, Captain Ward, R.N., which is found to have the advantages of the grummet, and to be more convenient in some respects.

As it will be found to be a very useful kind of crutch for general use in boats, we subjoin a sketch of it.

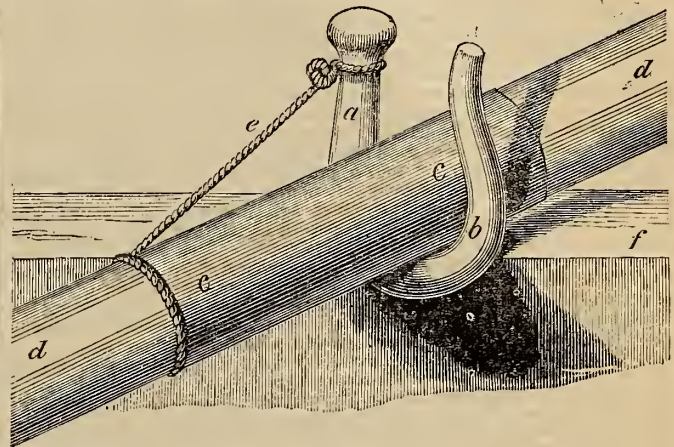

FIG. 2.

Figure 1 represents the inside of a boat's gunwale, with a section of the oar within the crutch, the latter supported on the gunwale in the position in which it remains whilst the oar is in use. *a* is an ordinary iron thowl-piu; *b*, the crutch, also of galvanized iron, which revolves round the thowl as an axis; *c*, a clamp or chock, which receives the lower end of the thowl; *d*, a section of the oar; *e*, a short laniard with a running eye, which is slipped over the head of the thowl whenever the oar is required to hang over the side; *f*, the gunwale.

Figure 2 shows the oar when let go by the rower and allowed to hang alongside outside the gunwale. *a*, the thowl; *b*, the crutch; *c*, the leathering on the oar, to prevent chafe; *d*, the oar, as hung alongside; *e*, the laniard spliced round the oar, below the leathering, and nailed on to prevent its slipping round or along the oar; *f*, the gunwale.

The principal advantage of the swivel-crutches over grumnets is, that they are of a more durable character, are fixtures, and so not liable to be mislaid or lost, and retain always the same size and shape, whereas a grummet is liable to stretch by use, when the oar will work too loosely in it.

CASELLA'S PATENT MERCURIAL MINIMUM THERMOMETER.

Our attention has been called to a very ingenious invention patented by Mr. Casella, jun., by which mercury is successfully employed, instead of alcohol, for registering cold as well as heat with perfect accuracy; and which invention, whilst of great importance in this country and in temperate climates, will prove of inestimable advantage for the correct indicating and recording in tropical climates—where the alcoholic thermometer is subject to serious disarrangements, and soon becomes totally unreliable.

We regret we cannot at present afford more space than for the following description, furnished to us by the maker, Mr. L. Casella, of Hatton-garden; but we hope upon some early occasion to be able to refer to the philosophical principle upon which the instrument is constructed, and be able to state the result of our own experience of the practical working of this thermometer.

The annexed illustration represents the instrument, the peculiarity of which consists in taking advantage of the attractive or adhesive influence obtained by the junction of the small chamber (*a, b*) with the adjoining bent tube or chamber (*d*), as shown in the enlarged view (*Fig. 1*), the action of which is as follows:—

On the instrument being set for observation, in a horizontal position, with the

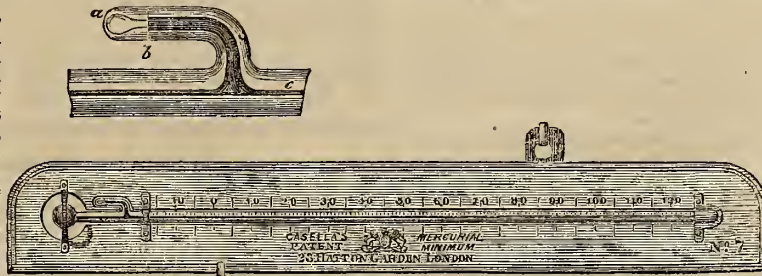

back plate (*e*) suspended on a nail, and the lower part supported on a hook (*f*), the bulb end may be raised or lowered, until the bent part (*d*) is full of mercury and the chamber (*a, b*) is quite empty; at this point the mercury in the bore of the tube indicates the exact temperature of the bulb or air at the time. On an increase of temperature the resistance of capillarity in the bore renders it easier for the mercury to expand into the small chamber (*a, b*) than along the narrow bore of the tube (*c*); whilst a

return of cold will, for the same reason, cause its recession from this chamber only, until it reaches the flattened surface (*b*); to which the mercury adheres, as to a fixed point; and any further diminution of heat withdraws the mercury down the bore to whatever degree the cold may attain, where it remains until further withdrawn by increased cold, or till reset for future observation.

By this means, cold may be registered to any fraction of a degree observable on the most delicate standard, and no vicissitudes of climate or transit can in any way disarrange the instrument.

When out of use, or after transit, it may be that raising the bulb may not at first cause the mercury to flow as stated; in such case, however, a slight tap with the hand on the opposite end, with the bulb up, will readily cause it to do so.

THE PIER AT BOURMOUTH.

On Tuesday, the 17th September, the new pier at Bourmouth was opened by Sir George Gervis and the Commissioners of Bourmouth.

The total length of the pier is 800ft., 15ft. broad, and a T end at the extremity of 108ft. It is constructed of timber frames 19ft. 6in. apart from centre to centre, except at the T end, which are 15ft. from centre to centre. These frames are composed of two piles on a slight batter, with cross walings and diagonal braces, fitted in cast iron shoes. On these frames are fixed three longitudinal bearers for supporting the planking which is placed across the pier.

The soil was principally composed of hard compact sand, with round boulders in certain places forming a thin strata of sandstone rock, some 4in. to 6in. thick, and so hard in some places that holes for the piles were obliged to be bored, as it was found impossible to drive them through with the monkey.

This pier was designed and carried into execution by Mr. G. Reunie and his son, Mr. G. B. Rennie.

The original estimate was £4380, and the actual cost was under £4400. Mr. David Thornbury was the contractor.

DEATH OF SIR WILLIAM CUBITT.

Sir William Cubitt, the eminent engineer, died on the 20th ult., after an illness which for some years had prevented him from following his profession. He was in the 77th year of his age, having been born in 1785, at Dilham, in Norfolk. In early life he assisted his father, who carried on the business of a miller; but, quitting this occupation, he was apprenticed to a joiner. In his new employment he soon acquired the character of a first-class workman, and became especially skilled in making agricultural implements. Not long afterwards he adopted the trade of a millwright, and obtained ample employment in the erection of machinery. In 1807 he promulgated his invention of the self-regulating windmill sails. Shortly afterwards he became connected with Messrs. Ransome and Son, the celebrated agricultural implement makers of Ipswich. Messrs. Ransome's business extended beyond the mere manufacture of agricultural instruments; and, accordingly, Mr. Cubitt was extensively engaged in the construction of gasworks. In connexion with prison discipline his name will ever be remembered as the inventor of the treadmill, which has since been introduced into nearly all of Her Majesty's goals. In 1826 Mr. Cubitt settled in London as a civil engineer, and immediately was engaged in works of the most important character. In 1827 an act was passed for the improvement of the Norwich and Lowestoft navigation, and Mr. Cubitt was appointed engineer. The object was to open a navigation for sea-going vessels from Yarmouth or Lowestoft to Norwich. To effect this, Mr. Cubitt united the river Warc with the Waveny, thence to the small lake of Oulton Broad, through Lake Lothing, with a passage onward to the sea, 700 yards long and 40 wide—Lake Lothing being thus formed into an artificial harbour, the tide-lock of which will admit vessels 84 feet long and 21 feet in beam. This undertaking was completed in 1829. Among his subsequent employments, he designed the South-Eastern Railway, including the removal of the South Down Cliff by blasting, which feat was accomplished under his superintendence. He was officially appointed, being then President of the Institution of Civil Engineers, to exercise a superintending watchfulness over the construction of the building for the Great Exhibition of 1851, in Hyde Park. He received the honour of knighthood for thus contributing his scientific experience in carrying out this national undertaking. The last great works upon which Sir William Cubitt was engaged were the two large floating stages in the Mersey at Liverpool, and the new iron bridge across the Medway at Rochester.

REVIEWS AND NOTICES OF NEW BOOKS.

Gas Legislation: Being a copious Index to the Metropolis Gas Act, 1860. With a Commentary on the Act, and Observations on recent Gas Legislation. By SAMUEL HUGHES, F.G.S., C.E. London: Waterlow & Sons, 1861.

The author is well known to our readers, and we do not know any one equally capable, and certainly none better able to perform the task which he has undertaken. His active and very useful interference on behalf of the gas consumers of the Metropolis has obtained for him not merely a local celebrity, but a high reputation for practical and scientific knowledge connected with the manufacture and distribution of gas throughout Great Britain.

One branch of the investigation successfully undertaken by Mr. Hughes served to confirm the popular opinion of the nefarious character of the proceedings of gas companies towards their customers the public, and to demonstrate most clearly a wholesale and organised system of fraud—which has necessitated legislative interference—the beginning of which will date from the passing of the Metropolis Gas Act, 1860.

Now about the book. So much may be written about its merits, and so many points to which attention should be drawn in calling attention to its contents, that we think it best at once to state that any consumer, be he in the district of ever so honest and respectable a gas company, will save the price of this book in a month's consumption of gas; and we, therefore, unhesitatingly recommend every gas consumer to forthwith invest half-a-crown in the purchase of Hughes's work on Gas Legislation. Indeed, it might appropriately have had for its title, "The Gas Consumer's Hand-Book."

The Appendix contains the Act at length—and this, in addition to the Parliamentary history of the Act,—A short Consecutive Abstract; Alphabetical

Abstract of Clauses; A short Classified Summary; A General Alphabetical Index; A Commentary on the Act; Concluding Observations and Remarks on Gas Legislation generally.

Now that Parliament has commenced general legislation in gas matters, we hope to see an improved state of things with reference to gas supply.

Elementary Treatise on Physics, Experimental and Applied. By Professor A. GANOT. Translated and Edited by E. Atkinson, Ph.D., F.C.S. London: H. Ballière, Regent-street. (Part I.)

This promises to be a most valuable work on the Physical Sciences. Book I. treats of Matter, Force, and Motion; and the subdivision, consisting of three chapters, is devoted to a statement of the objects of physics, and of other general principles, forming the basis upon which the superstructure is built; whilst Chapter II. deals with the general Properties of Bodies, which are admirably described; and Chapter III. is devoted to Force and Motion.

The Second Book treats of Molecular Attraction and Gravitation; which are very nicely illustrated.

The Third Book relates to Liquids; and as far as it has been advanced, treats the subject in a familiar and pleasing style.

Indeed, Part I. is highly creditable to the translator and English editor. The arrangement of the work appears to be somewhat similar to that adopted by Professor Rankine, and which has been so favourably received.

Our Black Diamonds; Their Origin, Use, and Value. By THOMAS PLIMSOLL. London: John Weale & Co. 1861.

A very useful little book; containing, in the simplest form, pretty much what has been written upon the same subject, at greater length, by others. The statistics of the Coal Trade are, generally, accurate; and without seeking too closely for the object of the author in printing what is contained in the hundred and four pages now before us, we feel at liberty to say that it is a useful little book, written in a popular style, and have no doubt that the publication will answer the purpose with which it was undertaken.

The Channel Railway for connecting England and France; pp. 47. Illustrated by Maps and Plans. By J. CHALMERS. London: E. & F. N. Spon. 1861.

The Author is one of the many who have undertaken to provide a practical means of connecting England and France without subjecting our continental neighbours to the horrors of sea-sickness. We know not, accurately, how many plans have been proposed during the last quarter of a century, but our memory serves us to the extent of some dozen or so. Several of these schemes have been tunnels of various kinds, including cast iron tubes, and these seem to be the favourite ideas. Bridges of various kinds have been proposed, and certainly, if we are to express a preference, it would decidedly be for the aerial rather than the subaqueous plan. The horror inspired in the female portion of the railway-travelling community by the passage of a train through a short tunnel, well ventilated every two or three hundred yards, and the oppressive effect upon nervous persons of both sexes, is as nothing to the infliction of a passage of 18 miles or so through a sub-aqueous tube, with air-shafts at a distance of some four-and-a-half miles apart.

The transverse sectional view on the title page of Mr. Chalmers's book looks simple enough, and the details shown in the sheet of drawings are of a very practical and reasonable character, so far as the principle and structural arrangements are concerned; and, moreover, we think Mr. Chalmers has not understated the advantages to be anticipated on the completion of such a desirable means of communication. Nor do we think he has overstated the revenue which might fairly be anticipated; but there are other and more material considerations which will have to be dealt with, and many important difficulties to be overcome before a perfect water-tight tube on the plan proposed by Mr. Chalmers can be securely placed, *in situ*, for the passage of railway trains between France and England—not the least material of which difficulties is, obtaining the necessary "sinews of war."

It is true that *Mont Cenis* is being rapidly pierced to admit of the passage of railway trains; but the prejudice which exists against a subterranean passage-way, tunnel, or tube, is very different to making a hole through a mountain, with daylight at each end, and with only a comparatively short distance between.

The Electrician.

We perceive with pleasure that the first number of a weekly journal, having the above title, and specially devoted to the interests of electro-telegraphy, is to be published on Saturday, the 9th inst., by Mr. Thomas Piper, Paternoster-row. We wish the publication every success.

NOTICES TO CORRESPONDENTS.

E. A. R.—As you have not specified what kind of engine yours is, whether land or marine engine, we have taken a marine engine for driving a screw propeller for our example, and assumed the 100 H.P. to be the actual or effective H.P.

The chief elements for the calculation are:—

Steam pressure in cylinder at commencement of stroke.....	20 lbs.
Cut off at $\frac{1}{2}$ stroke gives an average pressure.....	15 "
Average vacuum	12 "
Total average pressure	27 "
Diameter of cylinder ($30\frac{3}{16}$)	30'4375 in.
Area of ditto.....	727'5 sq. in.
Stroke of piston.....	2 ft.
Revolutions per minute	60

Now to find the amount of injection water we must first find the capacity of cylinder, to which must be added $\frac{1}{10}$ of the last quantity for pace under slide, passages and clearance.

Area of cylinder = 727.5 sq. ins. = 5.052 sq. ft.
 $5.052 \times 2 = 10.104$ cubic ft.

adding $\frac{1}{10}$ $10.104 \times 1.05 = 10.609$ cubic ft. in one stroke.
 $10.609 \times 2 \times 60 = 1273.1$ cubic ft. in a minute.

As now the total pressure of the exhaust steam is about 17lbs., the total temperature of this will be 1180°, then according to rule (see ARTIZAN, 1861, page 176) $\frac{1180 - 105}{105 - 60} = 23.9$ cubic feet of injection required for the condensation of each cubic foot of water in the shape of steam exhausted into the condenser, so that the condenser is kept at a certain temperature (in this case 105°). The specific volume of steam of a total pressure of 17lbs. is 1431, consequently,

$\frac{1273.1}{1431} = .89$ cubic feet per minute.

$.89 \times 60 = 53.4$ cubic feet in an hour.

$53.4 \times 23.9 = 1276.3$ cubic feet of injection water in an hour or 21.27 cubic feet per minute. This is the correct amount of injection water wanted, but in fixing the size of the injection valve for the admission of the water into the condenser, it should always be made somewhat in excess of the exact size specified.

N. D. Y. (*Resistance of iron to shearing and punching*).—In the volume of the THE ARTIZAN for 1858, page 219, was given a paper, read before the Institution of Mechanical Engineers at Birmingham, by Mr. Little, describing an improved hydraulic shearing press. Besides the description of the new press, tables were given of experiments on punching and shearing, which most likely are the tables referred to by our correspondent.

DINXPERTO (Liverpool).—If our correspondent had made himself thoroughly acquainted with the first part of the paper in the June number, or with Mr. Samuel Hughes's paper (July, 1857), he would not have been obliged to ask for information upon so simple a question. 4000 lbs. is a good medium for the breaking weight (S) of a wrought iron bar 1in. square and 1ft. long between supports. Now as this last beam is a beam No. III. (see page 132), it will at once be seen that it is four times stronger than the beam No. I.; and as a crank can only be considered as such, we get $S = \frac{4000}{4} = 1000$, and using 10 as the factor of safety, we get $S = 100$.

PROVINCIAL HYDRAULIC.—We have obtained the following particulars from the New River Company, and hope you will find them sufficient to guide you. The prohibition of iron supply pipes between the main and cistern is antiquated, and should not apply to galvanized wrought iron pipes. In future, address the Secretary of the Company direct.

THE NEW RIVER COMPANY'S REGULATIONS TO BE OBSERVED IN LAYING ON WATER:—

- 1.—The cistern to be capable of containing at least one day's supply, and fixed with the connecting pipes, cocks, ball cocks, &c., complete, before the supply is given.
- 2.—The cocks must have the same water-way as the pipes; and, if not screw bottomed, must first be approved of by the Company's Inspectors.
- 3.—Pipes for the supply of water closets must have a self-closing cock or valve attached.
- 4.—Lead pipes to the cistern must not be of less than $\frac{3}{4}$ in. bore, and not less than 2½lbs. per foot; if inch bore, not less than 3½lbs. per foot.
- 5.—A separate pipe, with stop cock, must be laid to each house.
- 6.—No iron supply pipe to be used in laying on houses.

F.—Mr. Bateson's Feed Water Apparatus has been successfully tried on the North-Western Railway.

C. R. E. (Poplar).—Does the report sent answer your purpose?

S. AND OTHERS.—See answer to N. D. Y. (of Dublin), above. Some further experiments are about to be made, the results of which will be recorded in THE ARTIZAN.

J. B. (Howrah), Calcutta.—Your suggestions about steamship building are excellent, though not new. We have now many surface condensers at work in commercial steamships with perfect success; that patented by Mr. J. F. Spencer being the most generally adopted and most successful. Your idea of constructing a condenser is not new. Mr. Hyde, of Bristol, and other patentees, have unsuccessfully tried the same plan.

J. W. (Alexandria).—Efficient machinery to produce twenty-five tons per day, with six H.P. to work it, would produce the result at the rate of about two shillings per ton (in London.) Make proper allowance for local circumstances. The machine weighs about 4 tons, and the price complete, including patent right, will be £500.

O. D. (Via Chiozza, Trieste).—It is evident that letters have miscarried. Thanks for your last; shall be happy to receive whatever you think useful. The things you ask for shall be sent, if you will say how, as they cannot be sent through the post.

W. C.—The Locomotive Paper and illustrations are in preparation.

O. W. L., LITTLE SCREW, MARINE ENGINEER, and MAIL BOAT.—The working speed of the Holyhead mail boats has been reduced.

X.—The ordinary proof of the 12-pound breech loaders referred to by you is 2lb. of powder to 24lb. shot. Clay's rifled cannon was submitted to that charge.

T. G. (Glasgow).—The idea of firing large masses of material of the form proposed is not new. We believe Mr. Dodds, of Rotherham, to have practised the plan some three years ago. A considerable drawback to the plan proposed by you is, that you might knock a hole through the bottom of your own ship instead of the enemy's.

DUNCAN C.—There is an Association of Assistant Engineers in Glasgow. Address Mr. J. Fox, 50, Gloucester-street. We regret we cannot supply you with the other information sought.

S. D.—The diagrams taken from the circulating pump, and the injection air pump, together with the cards from the top and bottom of the cylinders, will unerringly tell the whole story.

X.—The floating dock, which for some time past has been in course of construction by Messrs. George Rennie and Sons, is constructed according to Mr. G. B. Rennie's patent, and is intended for Spain; we believe for Carthage.

Loco.—Write to Mr. Ramsbottom, at Crewe. Your letter being without address does not enable us to communicate direct, but the following extracts from some experiments we witnessed last year will no doubt answer your purpose:—*Mr. Ramsbottom's experiments between Colwyn and Conway, Nov. 13th, 1860.*

—Length of trough, full depth and width, exactly quarter of a mile or 440 yards; inclined piece at each end about 10 yards; width of trough at top, 18in. inside, and 16in. at the bottom; depth, 6in.; mean depth of water, $4\frac{1}{2}$ in.; mean width equal to 17in. \times $4\frac{1}{2}$ in. for contents, will give number of gallons and the total weight. The spout fitted below the tender has an opening 10in. wide and 4in. deep in the clear = to 40 square inches area; the shoot is made to rise and fall 19in. The area of shoot is increased at the upper end to six times the area of mouth. The engine, *Clan Rickard*, left Colwyn at 12.20 with 250 gallons of water in tender. She ran over the trough at 40 miles per hour, and crossed to the up-line, near Conway station, at 12.23, stood and measured contents of tank, and found 1270 gallons, thus whilst running over the trough 1020 gallons were made to ascend the shoot and were delivered into the tank. *Second experiment, same engine.*—Started with 160 gallons, measured quantity, at Conway, and found 1295 gallons = to 1135 gallons picked up during experiment. The tender is of 1500 gallow capacity and holds 500 gallons to each foot of depth.

YOUNG ENGINEER.—The best self-adjusting bench vice is, we believe, that of Messrs. Easterbrook and Allcard, of Sbeffield.

P.—Any of the mathematical instrument makers in London can supply you with the necessary curves.

CATOPTRIC.—Mr. Alexander Gordon was, we believe, the first to design iron lighthouses.—Refer to Fresnel's work.—Messrs. Wilkins and Co., of Long Acre, are experienced lantern makers.—The total height of the Great Isaacs Lighthouse is 145 feet; the iron lighthouse at Bermuda is only 128 feet. The American Lighthouse Board have recently had executed at Cape Canaveral, and elsewhere, iron lighthouses with screw pile foundations. We hope to be enabled to give some particulars of these lighthouses in an early number.

G. (PALERMO).—The Paper is in type.

STEAM YACHT.—The tonnage is 222 $\frac{3}{4}$; the nominal power, 30 horses. We cannot at present answer your other question.

J. H. (Liverpool).—See page 219 of THE ARTIZAN for 1858, where you will find the information you seek. Do not hesitate to apply at any other time.

J. Y.—The corrections shall be made.

F.—Write to Mr. Hensman, the Engineer to the Bank of England.

GOVERNOR.—Your plan is not new. Mr. Silver had such an apparatus at work about three years ago, which you may see. The cataract plan is also old. A steam cylinder and equilibrium valve, applied as you have it, are likewise old.

RECENT LEGAL DECISIONS

AFFECTING THE ARTS, MANUFACTURES, INVENTIONS, &c.

UNDER this heading we propose giving a succinct summary of such decisions and other proceedings of the Courts of Law, during the preceding month, as may have a distinct and practical bearing on the various departments treated of in our Journal: selecting those cases only which offer some point either of novelty, or of useful application to the manufacturer, the inventor, or the usually—in the intelligence of law matters, at least—less experienced artizan. With this object in view, we shall endeavour, as much as possible, to divest our remarks of all legal technicalities, and to present the substance of those decisions to our readers in a plain, familiar, and intelligible shape.

STREET TRAMWAYS.—The grand jury at the Surrey Quarter Sessions at Kingston have returned a true bill against Mr. G. F. Train and several vestrymen of Lambeth for a nuisance committed by obstructing the thoroughfare in the Kennington and Westminster roads. The first count in the indictment charges the defendants with obstructing the free passage on the said highways by placing thereon iron rails, and thereby rendering the said roads unsafe for the passage of vehicles and horses. Other counts charge the defendants with digging divers large holes and breaking up the roads; and other counts charge the defendants with conspiring together for the purpose of effecting the said objects. The names of twenty-three witnesses, including several of the principal inhabitants of the parish and of the adjoining districts, were endorsed on the bill, but the grand jury did not deem it necessary to examine more than seven of them. The object of this indictment is, of course, not to inflict punishment upon the defendants, but merely to abate what the parties consider to be a nuisance. It is not improbable that the proceedings will be removed to the Court of Queen's Bench, in order to have all legal questions arising in the case fully argued.

NOTES AND NOVELTIES.

OUR "NOTES AND NOVELTIES" DEPARTMENT.—A SUGGESTION TO OUR READERS.

We have received many letters from correspondents, both at home and abroad, thanking us for that portion of this Journal in which, under the title of "Notes and Novelties," we present our readers with an epitome of such of the "events of the month preceding" as may in some way affect their interests, so far as their interests are connected with any of the subjects upon which this Journal treats. This epitome, in its preparation, necessitates the expenditure of much time and labour; and as we desire to make it as perfect as possible, more especially with a view of benefiting those of our engineering brethren who reside abroad, we venture to make a suggestion to our subscribers, from which, if acted upon, we shall derive considerable assistance. It is to the effect that we shall be happy to receive local news of interest from all who have the leisure to collect and forward it to us. Those who cannot afford the time to do this would greatly assist our efforts by sending us local newspapers containing articles on, or notices of, any facts connected with Railways, Telegraphs, Harbours, Docks, Canals, Bridges, Military Engineering, Marine Engineering, Shipbuilding, Boilers, Furnaces, Smoke Prevention Chemistry as applied to the Industrial Arts, Gas and Water Works, Mining, Metallurgy, &c. To save time, all communications for this department should be addressed "19, Salisbury-street, Adelphi, London, W.C." and be forwarded, as early in the month as possible, to the Editor.

MISCELLANEOUS.

A FOUNDRY SWALLOWED BY A COAL MINE.—An extraordinary occurrence lately took place at West Bromwich. The engineer at the West Bromwich foundry had scarcely entered the works in the morning when he perceived a peculiar movement of the earth beneath his feet, and almost instantly ascertained that the land on which the engine and works were placed was about to fall into an abyss created by some old working in an adjoining coal pit. The man's first impulse was to save himself from the impending danger, and he had no sooner run out of the engine house than the earth gave way with a fearful sound, swallowing up in its downward course the steam engine and machinery. A large boiler attached to the engine was left behind among the *débris*, where it remained for some time in an insecure position. The escape of the engineer, the only man on the premises, was most miraculous.

THE PNEUMATIC TUBE.—Some experiments have recently been made at Battersea, for the purpose of showing the action of the pneumatic principle in the conveyance of passengers and parcels. For the purpose of the experiment, two carriages only were used, each weighing about one ton, and loaded with ten bags of gravel, each containing 1wt. These vehicles were drawn or rather propelled through the tube by the pressure of atmospheric air, in rather less than thirty seconds. At other trips a mattress was placed over the bags of gravel in each carriage, and some of the visitors passed through the tube. The journey was of course made in perfect darkness, but beyond this there was no unpleasant sensation whatever.

FACTS FROM THE CENSUS IN AMERICA.—As the exact and official returns of the Census are being made public, we behold more clearly the precise march and direction of the population which has been filling up, during the last ten years, the unoccupied territory of the Union. Its grand and main course is westward, with some currents to the north-west and some to the south-west. The flood of population over some of our new States in the far West has probably never been equalled in the history of emigration, both in character of the emigrants and in the number placed upon new soil, where before were the animals of the prairie and the forest, and the roving Indian. Minnesota, for instance, increased from 6,077 inhabitants in 1850 to 162,022 in 1860, or at a rate of increase of over 2500 per cent.; Oregon, from 13,294 to 52,464, or at the rate of 294 per cent.; Iowa, from 192,214 to 674,948, or at 251.22 per cent.; Texas, from 212,592 to 602,432, or 183.37 per cent.; Wisconsin, from 305,391 to 775,873, or 154.06 per cent. Arkansas increases 107 per cent., and Illinois over 100 per cent. The average rate of the growth of population in all the States the last decade is 35.02 per cent. There are 19 States below this average, the lowest in order being Vermont, 0.32 per cent., then New Hampshire, 2.55 per cent.; and next South Carolina, 5.28; Maine following with 7.73, and Tennessee with 11.68, and once powerful Virginia with only 12.27, while North Carolina shows only 14.23. There are 11 States counting 19,528,655 inhabitants, or an average of more than one million and a half each—namely, Illinois, Indiana, Ohio, Pennsylvania, Massachusetts, New York, Tennessee, Missouri, Virginia, Kentucky, and Georgia. In territories the greatest advance is, of course, in Utah, of 254.07 per cent. In New Mexico it reaches 51.98. The black current must always be the important one to the statistician of this continent. The Census reveals a steady stream of negroes from the seaboard towards the south-west. Virginia retains her old pre-eminence as the breeder of slaves for market, in which noble occupation she is apparently closely followed by South Carolina, while the States whither this disgusting traffic tends are Arkansas, Mississippi, and especially Texas. The average increase of the slaves is moderately large, or 23.42 per cent. There is a loss in but two States, Delaware (of 21.48 per cent.) and Maryland (3.52). The increase in Virginia is only 3.88 per cent., and in South Carolina 5.28—this small advance evidently resulting from exportation. Kentucky, too, shows an increase of but 4.87 per cent. the last decade, which gives a most gratifying prospect of the destiny of the system in Kentucky, as it is believed no very important numbers have been exported during the last ten years from that State. North Carolina only exhibits an advance of 14.74, and Tennessee of 15.17 per cent. Missouri presents a larger increase than was expected—namely, 31.51. The great increase is in Texas, where it reaches over 210 per cent. (210.66); in Arkansas it is 135.89, and in Florida, 57.09; in Mississippi, 40.93. In two States only are the slaves more numerous than the whites—in South Carolina, where they number 402,541, against 291,623 of the white inhabitants, and in Mississippi, being 436,696 to 353,969 whites. Their largest number in any one State is in Virginia (490,887), and the next in Georgia (462,232). In the territories there are 10 slaves enumerated in Nebraska, 24 in New Mexico, and 29 in Utah. The district of Columbia shows a loss of slaves of 13.72 per cent. Among the free coloured population the increase is very small through the Union—only 10.68 per cent. Their largest numbers are to be found, as usual, in Virginia, Maryland, and Pennsylvania. Little valuable, in a statistical point of view, is to be extracted from the tables of this population, as the diminution from banishment or emigration cannot be distinguished from that arising from natural and regular causes. The theory suggested recently by an able statistician in Washington (Mr. Weston), that the free negro inevitably diminishes on this continent, is not yet sufficiently confirmed by facts to be admitted as a satisfactory scientific hypothesis. The race undoubtedly dies out in climates not adapted to it—as, for instance, in the Northern States; but whether it

decays in freedom in the middle or southern latitudes does not yet fully appear. In many of the Southern and Western States there are laws expelling the free negroes, and their decrease observed in those States during the last decade may be due to those extraneous causes. Their largest increase in a Slave State is in Georgia (18.01 per cent.); in Alabama, 16.11; in Maryland, 12.04; the greatest decrease in Arkansas, 77.47. Greatest increase in a Free State, in Minnesota, 437.18 per cent; in New York they lose 2.18 per cent. It will probably be many decades before we shall show such a rapid growth of numbers as in the last. The next census will no doubt reveal new currents and new directions in our population. Instead of streams from east to west, we may then have many from north to south, and new results to chronicle in regard to the movements or decrease of the black population.

NEW MARINE GLUE.—This composition, patented by Mr. W. J. Hay, of Portsmouth Dockyard, is much cheaper than marine glue, and will, therefore, be used largely by the shipping interest generally. In addition to the purposes to which ordinary marine glue is applicable, the waterproof glue, from its extreme low price, may be used for caulking and paying the seams and decks of all classes of vessels, and will, consequently, become a substitute for the costly marine glue and the inexpensive pitch. This glue, which has been tested by seven years' trial, has been found the cheapest and most durable application for iron, wood, and all other kinds of roofing and fencing, also a good substitute for bottling wax and metallic capsules, and a desirable covering for posts, piles, &c. The following are the best proportions for this ingredient:—Trinidad pitch, or asphalt, 60lbs; vegetable tar, 15lbs.; oil naphtha, 2lbs. Instead of the oil naphtha, 2½lbs. rough creosote, or 4lbs. oil of turpentine may be used.

PAPER FROM WOOD.—The French papers report that a lady has succeeded in manufacturing excellent paper from wood, and at a price much below that made from rags. Her method consists chiefly in the use of a new kind of machinery for reducing the wood to fine fibres, which are afterwards treated with the alkalis and acids necessary to reduce them to pulp, and the composition is finally bleached by the action of chlorine. By means of a series of parallel vertical wheels, armed with fine points, which are caused to pass over the surface of the wood in the direction of its fibres, the surface of the wood is marked, and the outer layer is formed into a kind of net without woof, composed of separate threads. This layer of fine threads is afterwards removed by means of a plane, which is passed across the wood, and the portion thus removed, which resembles lint or flax, is then treated with chlorine, &c. Specimens have thus been made, consisting of a mixture of 80 per cent. of wood-pulp and 20 per cent. of rag-pulp, and sheets have been tried by printers, lithographers, and others, with most satisfactory results. It is the unanimous opinion of those who have used this paper, that made according to this method, from wood, and which costs only £16 per ton, is quite equal to the China paper, which costs above £200 per ton. It is confidently expected that experiments upon a larger scale will confirm the results already obtained.

PUBLIC LIBRARIES.—The number of public libraries in the United States is estimated at 250, containing about 2,000,000 volumes. England is said to have only about 100 public libraries, containing about 2,500,000 volumes. France has about 200, containing full 5,000,000 volumes.

WEATHER PROGNOSTICATIONS.—M. Liandier and the Baron de Portal, who have been constant observers of the scintillation of the stars for some years, and the former of whom has recently presented a memoir to the Academy of Sciences at Paris on the subject, have made a discovery which promises to be of great value as a weather prognostic, in addition to the barometer. Taking a telescope, and turning it on a first magnitude star well above the horizon, and throwing the instrument out of focus, an amplified image of the star will be obtained; this image should be about three quarters of an inch in (apparent) diameter; and if the object glass be made of pure material and properly adjusted, the image will be perfectly round, and composed of concentric rings, the light of which, owing to the scintillation of the star, will be continually varying. On this image, as a background, the appearances which constitute the indications referred to are to be observed. First, appear shadows more or less dark, which dance round the borders of the disc, and finally pass on and cross it. This appearance is caused by clouds in the vesicular state, and from the rate and direction of their passage over the image of the star, the velocity and direction of the currents of air in the higher regions of the atmosphere, more or less charged with moisture, may be learned. But this is not all: from time to time a black point will traverse the image; this has, hitherto, been regarded by telescopic observers as a sign of fatigued eyesight; but this explanation can no longer be received, and M. de Portal attributes it to the formation of drops of rain in the atmosphere previous to their fall. The facts already arrived at may be thus summed up:—1. On the magnified image of the star diffuse illuminations, due to scintillation, are first seen, then vibrations and waves, more or less brilliant, shaded or coloured, which appear to spread in all directions. 2. If these vibrations be carefully studied, they will be found to traverse the disc in a constant direction, and to be more agitated on leaving than on entering it. 3. These vibrations prove that currents of air are in motion, in the direction they indicate, in the higher regions of the atmosphere. 4. In the interval of some minutes, hours, or days, according to the unsettled or settled state of the weather, these waves will pass from the N.E. to the S.E. and oscillate back again; or else turn through the S.W. and N. to regain their original direction; or again oscillating backwards from the N. regain it through the E. or W. Thus the prognostics to be derived from the study of what passes in the higher regions of the atmosphere are the same as those obtained from similar observations on the surface. All the waves which enter by the N.E. indicate currents in this direction, and consequently fine weather, when they enter by the S.E. it is a less favourable omen; and when by the S.W. rain is almost certain. By this method of observation, therefore, the barometric, thermometric, and hygrometric relations of the upper regions of the air may be studied as at the surface, where the same currents will most probably arrive 24 or 48 hours later, having been foretold by the barometer in the interim.

A ROMAN MIRROR dug up at Mayence has been analysed by Souchay. It was of a greyish white colour, brittle under the hammer, and had fine granular fracture. Its specific gravity was 9.21. Its composition was—tin, 19.05; lead, 17.29; copper, 63.39. The alloy was probably made by melting together 1 part of tin, 1 of lead, and 3 of copper.

At the last monthly meeting of the Liverpool Polytechnic Society, presided over by Mr. Scott, the paper of the evening, "On Wrought-iron Cranes," was read by Mr. J. J. Birkbeck, in which he referred to the cranes at the Liverpool Docks as being defective; indeed, as involving in their construction a mechanical absurdity. In opposition to them he lauded the cranes of Mr. Fairbairn, which he said possessed advantages over the ordinary cranes, and had been introduced at Portsmouth, Plymouth, and other places. Several of the members expressed dissent from the opinions stated by Mr. Birkbeck, and it was said that a crane on the principle that he advocated had been tried at Birkenhead, and proved a failure.

LENOIR'S GAS ENGINE.—The very ingenious new motive power, invented by M. Lenoir, seems to meet with approval in scientific circles in Paris. It is simply the application of common gas, exploded in small quantities above and below the piston of what was once a steam engine, the explosions being ingeniously regulated, and produced by the electric spark from a Ruhmkoff machine. The piston moves regularly and rapidly, precautions being taken to avoid accident. The expense of gas is small, 500 litres per hour for each horse-power, ten hours' work costing about 1s. 3d. per horse-power. This invention is about to be applied to locomotives and as the gas required may be produced by the decomposition of water itself, a great revolution in machinery may result.

NEW STEAM HAMMER.—For some months past a new working cylinder steam hammer has been in course of construction at the iron works belonging to Messrs. Hill and Smith, at Brierly Hill. This hammer was made by Mr. Wylie, formerly of Glasgow, and is by far the largest in the South Staffordshire district. The hammer is one of 5 tons weight, and designed for forgings of the largest class. The framing consists of two cast iron columns of rectangular transverse section, placed 16ft. apart. They are bound by a strong iron beam, through which an opening is made for the passage of the cylinder or hammer block. The two lower columns are surmounted by a pair of segmental frame pillars, which joined, form an arch springing up to a height of 23ft. from the ground. These semi-circular pillars are joined together at the crown centre by internal flanges, leaving sufficient space to receive the entablature and part of the valve gearing. The upper and lower columns are jointed to each other internally spigot and facet fashion, their junction flange being firmly secured by strong bolts and nuts. The upper columns are secured to the horizontal beam, and also to the arch above, provisions being made for adjusting them by means of lines. The cylinder, or hammer block, has a stroke of 6ft., and is cast of the strongest cold-blast iron. A small horizontal steam cylinder is attached to the entablature, the piston rod of which is connected to the double-beat and exhaust valves by a lever and link arrangement, and the attendant has merely to touch the steam-side valve of this miniature engine to raise the hammer to its desired height. This hammer, complete, weigh about 80 tons.

GOLD IN NEW ZEALAND.—It has long been known that gold exists in many parts of New Zealand, but not to the extent which has just been found in the new locality. This gold field is situated at Tuapeka, about 40 miles from Dunedin, the capital of the province. The site which is now being worked varies from 100 to 300ft. in breadth, and is comparatively flat, from whence, on either side, rise steep slopes of from 500 to 800ft. These slopes show argillaceous, schistose rock as the formation, in which nodules and veins of quartz exist abundantly. This formation is a very general one in the province of Otago. The valley runs north and south, and the strike of the rocks is east and west. The altitudes of the adjacent ranges vary from 1200 to 2000ft., but the valleys near do not appear to range above 400 to 700ft. The quantity of gold taken by the parties now at work is in some instances considerable. It appears from a recent return that a party of three individuals obtained 112 ozs. in 14 days, another party of three realised 7½ ozs. in five hours and a half, and others in like proportions. The gold is found in large scales, and occasionally in nuggets. The number of men at work at the diggings when the last account left was about 300; but the number will be greatly increased every day—not only from Otago and the adjacent provinces, but from Auckland and Australia. Its effects have already told upon the population. This discovery cannot fail to exercise the most beneficial influence over the whole of New Zealand. It will, doubtless, lay the foundation of a similar prosperity which has so long rendered Australia so celebrated. The extent of the area of this country is, of course, more limited, and the yield of gold will probably be much smaller in quantity than in Australia; yet the results will give a considerable impetus to the commerce of this colony.

MONSTER LANDING STAGE.—Messrs. T. Vernon and Sons, of Trammere Works, Liverpool, have nearly completed and launched a new landing stage, intended to be moored opposite Woodside ferry, on the Cheshire side of the Mersey. It will be 800 ft. in length, will comprise 2500 tons of iron work, about 80,000 cubic feet of timber, and will be supported upon 50 pontoons. The width will be 80 ft.

TIMBER SAWING MACHINE.—A sawing machine has been invented by Mr. John Robinson, of Rochdale, which may be transported from place to place, and may be used without the support of walls or other permanent erections. To this end the operating parts and the framing are constructed so that they constitute a machine complete in itself, provided with wheels for the purpose of enabling it to be moved in its complete form. This machine is provided with a foundation beam or plate, which is capable of being lowered so as to afford a solid bearing upon the ground, and which may be done by sinking the wheels. The main shaft is provided on each side with a fly wheel, either of which is used for driving the machines instead of a pulley.

ROLLING IRON.—Mr. C. White, of Pontypridd, has introduced an invention which consists of placing vertical rolls between the horizontal rolls. These vertical rolls have grooves in them, so that upon the iron or metal to be rolled being placed between the first pair of rolls, it continues its course through the entire series of rolls without the necessity for manual labour. The horizontal rolls may be placed nearly close together, or the bars, &c., may be conducted from one to the other by smaller ones.

NAVAL ENGINEERING.

THE "ROYAL OAK," 51.—The planking on which the iron plates of this iron clad frigate will be placed are to be of teak, 12 inches in thickness, tapering down to a minimum thickness of 5 in., at a depth of 5 ft. below the water-line. The object of bolting the iron plates on teak instead of oak planking is that the peculiar oil from the former wood is expected to act as a preservative to the iron, while the acids from oak planking are found to be exceedingly injurious to iron on which they have a singular destructive effect.

THE "MALACCA," 17, steam sloop, lately commissioned at Sbeerness, recently underwent a trial trip of her engines. The result was as follows:—Average revolutions, 84; speed 8½ knots; draught of water forward, 13½ ft.; aft 15 ft. 9 in. The *Malacca* answered her helm admirably, and there was scarcely any vibration from her engines.

THE "DULWARK," 91, building at Cbatham, is to be converted into a 51-gun-iron-clad frigate of the same class as the *Royal Oak*, under construction at the same place. The alterations will necessitate her being cut asunder, and an addition of 20 ft. made to her length amidships, besides which her deck will require to be raised, and other important alterations effected in her to increase her strength, and enable her to sustain the enormous weight of the slabs of iron with which her sides will be covered.

THE "CHANTICLEER," 17, screw, has completed her official trials at Portsmouth. On her last trial she drew 11ft. of water aft, and 13ft. 6 in forward. The engines attained 90 revolutions, the load on the valve being 20lb., the pressure on the gauge 22lb., and the vacuum 25. The mean speed of the vessel in knots was 11.23. The performance of the machinery was of the most satisfactory character. The *Chanticleer* is the third vessel of her class and description that has been fitted at Portsmouth, her two predecessors—the *Rinaldo* and *Pelican*—having been already commissioned and despatched on foreign service. From the better distribution of the *Chanticleer's* weight, as compared with the two vessels named, together with the very successful results of her trial, it is anticipated she will prove to be the fastest and best sea boat of her class. Her trial of speed was made at 15 in. deeper draught than that of her predecessors on their trials.

THE "BRITON."—On the 23rd ult, this new iron steamship underwent a trial trip in Stokes Bay. The following were the runs made:—First mile, 6 min. 8 sec., or an average of 9.785 knots per hour; second mile, 4 min. 59 sec., equal to 12.040 knots; third mile, 6 min. 26 sec., equal to 9.350 knots; fourth mile, 4 min. 58 sec., equal to 12.080. The simple mean of the 4 runs was 10.813 knots per hour, and the Admiralty mean, 10.754; revolutions of engines, 73; pressure of steam, 24lbs.; vacuum, 25. Everything worked very satisfactorily, and the engines worked well without giving any trouble from beated bearings, or other cause.

THE "BOMBAY," 81, 400 H.P., recently made a two day's trial trip for the purpose of testing her engines and machinery. The *Bombay* was built a few years ago for the Government at Bombay, and before her alteration to a screw steamer, was one of the finest line-of-battle sailing ships of her rating afloat. During the trial trip, the number of revolutions made per minute by the screw, with all the boilers at work, was 64, and at half power, 42; the draught of water forward was 16ft. 6 in., and aft, 20ft. 2 in.; the average rate of speed during the trial being 10.19 knots. On the whole the engines worked satisfactorily.

THE "SALAMIS," 4-gun paddle-wheel despatch boat, is to be diagonally built, and being intended to accomplish a great speed, she is of unusual length for her rating, and very narrow. Her principal dimensions are—length 220ft.; extreme breadth, 25ft. 2 in.; depth in hold, 14ft. 6 in.; and 250 H.P.

THE "ECLIPSE," 4, screw steam sloop, 700 tons, recently underwent a trial of her engines previously to their being passed over to the Government authorities by the contractors. The *Eclipse* is fitted with horizontal air pump trunk engines, 200 nominal H.P. She was tried at full and half boiler power with the following results:—With full boiler power she attained an average speed of 10½ knots; revolutions, 98; pressure of steam, 20; vacuum, 25; draught of water aft, 10ft. 8 in.; forward, 8ft. With half boiler power she attained a speed of 9.274 knots, with 76 revolutions. She was also tried at turning the circle, which was accomplished in 4 min. 5 sec., and the half circle in 2 min. 30 sec. Common screw, pitch, 16ft.; diameter, 11ft. The trial was very satisfactory, and would have been more so had it not been for the foulness of the bottom of the ship.

THE "WARRIOR."—The trial of the *Warrior*, on the 14th ult, off the Isle of Wight, proved very satisfactory. Her engines made 42 revolutions; her speed, 12½ knots; she turned in a circle, at full speed, in 8 min. 30 seconds. There is little doubt that the *Warrior* will roll in a heavy sea, and it is equally certain that she will not prove the dead long log on the water some have feared, but she will possess, as far as may be judged from her action on trial, very great buoyancy in rising to a sea. On the 17th the *Warrior* ran the measured mile at Stokes Bay, and made 13-1.3 knots. The trial was in every respect a successful one. After the run, the frigate again took up her moorings at Spithead. Great complaint is made on account of the engine room being so close, and the stokehole so very hot.

THE "WARRIOR" again made a trial of speed with reduced power at the measured mile in Stokes' Bay, on the 25th ult. Four runs were first made over the trial ground with six boilers (the ship at full power uses 10), and the following results were obtained:—First run: Pressure of steam, 21lb.; vacuum, forward engine, 26½; after engine, 26½; revolutions of engines, 43; speed in knots, 13.433. Second run: Pressure of steam, 20lb.; vacuum, forward engine, 26; after engine, 26; revolutions of engines, 44; speed in knots, 11.043. Third run: Pressure of steam, 13½lb.; vacuum, forward engine, 27; after engines, 26; revolutions of engines, 43; speed in knots, 13.235. Fourth run: Pressure of steam, 20lb.; vacuum, forward engine, 27; after engine, 25; revolutions of engines, 44; speed in knots, 11.077. The mean speed of the four runs in knots was 12.186. Two runs were next made with four boilers as follows:—First run: Pressure of steam, 20lb.; vacuum, forward engine, 27; after engine, 23; revolutions of engines, 37½; speed in knots, 12.080. Second run: Pressure of steam and vacuum the same as in the preceding run; revolutions of engines, 35; speed in knots, 10.000; mean of the two runs, 11.040. Temperature, engine-rooms, maximum, 92, minimum, 85; temperature, stoke-hole, maximum, 113, minimum, 93.

THE "MEDEA," 6 paddle, tested her machinery on the 3rd ult. Every part worked in a most satisfactory manner.

NAVAL APPOINTMENTS.—The following have taken place since our last:—J. Hood, Chief Engineer, to the *Medea*; C. A. Strafford, Acting Engineer, to the *Medea*; J. H. Bins, Engineer, to the *Flagard*, for the *Riflemen*; D. Millar, First-class Assis. Engineer, to the *Majestic*, for the *Goshawk*; P. Hutchison, First-class Assis. Engineer, to the *Himalaya*; W. Birks, Acting First-class Assis. Engineer, to the *Asia*, as Superintendent for Hospital treatment; W. McLaurin, Acting First-class Assis. Engineer, to the *Medea*; W. Barclay, Second-class Engineer, to the *Medea*; J. Sumner, Acting Second-class Assis. Engineer, to the *Medea*; W. J. Sullock, Acting Second-class Assis. Engineer, to the *Indus*, for service in the *Thais*; W. J. Wise, Acting Second-class Assis. Engineer, to the *Asia*, for the *Fire Queen*; G. Edwards, Acting Assis. Engineer, to the *Asia*, for the *Echo*; W. Gilbert, W. Bedford, and G. Williamson, Acting Second-class Assis. Engineers, to the *Asia*; J. S. Pidgeon, Acting Second-class Assis. Engineer, to the *Cumberland*; E. W. Allison, Acting Second-class Assis. Engineer, to the *Indus*, for the *Avon*; W. Jones, Acting Second-class Assis. Engineer, to the *Warrior*; G. L. D. R. Keeling, Engineer, to the *Racer*; L. Backler, First-class Assis. Engineer, to the *Jason*; E. S. Young, Acting Second-class Assis. Engineer, to the *Racer*; J. Millar (c), Acting Second-class Assis. Engineer, to the *Jason*; J. N. Wilson, Engineer, to the *Cumberland*, for the *Lee*; J. T. Harris, Acting First-class Assis. Engineer, to the *Doterel*; J. M. Gregor, Acting Second-class Assis. Engineer, to the *Doterel*; S. T. Wallis, to First-class Assis. Engineer in the *Reerut*; G. T. Greaves, Acting Second-class Assis. Engineer, to the *Asia*, as superannuated; J. Potts, Acting Second-class Assis. Engineer, to the *Megeera*; A. R. Maham, Acting Assis. Engineer, to the *London*; J. Lovering, Acting Chief Engineer, to the *Asia*, for the *Stromboli*; H. Cook, Engineer, to the *Indus*, for the *Perseus*; A. Bortwick, Acting First-class Assis. Engineer, to the *Asia*, for the *Highlander*; E. D. Dooley, First-class Assis. Engineer, to the *Asia*, for the *Snapper*; C. Allison, Acting Second-class Assis. Engineer, to the *Asia*, for the *Duncan*; R. L. Canney, of the *Asia*, to Chief Engineer; C. A. Brydler, promoted to Chief Engineer; A. W. Chalmers, promoted to Acting Chief Engineer, to the *Falcon*; W. Holloway, Engineer, to the *Cumberland*, for the *Swallow*; F. Pursell, promoted to Acting First-class Assis. Engineer, in the *Cossack*; R. E. Chiswell, Acting Second-class Assis. Engineer, to the *Asia*, for the *Traveller*; H. G. Hayward, Acting Second-class Assis. Engineer, to the *Indus*, for the *Pike*; J. Gordon, promoted to First-class Assis. Engineer, in the *Curlew*; W. J. Foster, to First-class Assis. Engineer, in the *Pelican*; C. Moberley, to First-class Assis. Engineer, superannuated, in the *Asia*; R. Dixon, to First-class Assis. Engineer, to the *Ariel*; J. Patterson, to First-class Assis. Engineer, in the *Scourge*; W. Fenton (a), to First-class Assis. Engineer, in the *Centurion*; J. F. Moroton, to Acting First-class Assis. Engineer, in the *Waterman*; F. Lewis, Engineer, to the *Indus*, for the *Sparrow*; F. W. Robinson, to First-class Assis. Engineer, in the *Victor Emmanuel*; S. E. Brummage, J. M'Pherson, and W. Bremner, Second-class Assis. Engineers, to the *Doris*, confirmed; J. T. Harris, First-class Assis. Engineer, superannuated, in the *Indus*, confirmed; P. M. Knight, First-class Assis. Engineer, to the *Doterel*; J. J. Einch, Second-class Assis. Engineer, to the *Industry*; G. F. Bell, Acting Engineer, additional in the *Cumberland*, for the *Zebra*, confirmed; W. H. Bamberg, First-class Assis. Engineer, transferred from Plymouth to Portsmouth ordinary; S. Grundy, Acting Second-class Assis. Engineer, additional, to the *Asia*, for the *Myrtille*; R. Hall, Acting Second-class Assis. Engineer, to the *Asia*, for the *Stork*; W. Rawley (B), Acting Second-class Assis. Engineer, additional, of the *Russell*, for the *Hind*, confirmed; J. Ward, confirmed as Chief Engineer, and appointed to the *Asia*, for the *Esk*; E. S. Ashworth, to Engineer, additional, to the *Cumberland*, for the *Fearless*; H. C. Jones, Engineer, to the *Flagard*, for the *Spiffire*; D. Driscoll, to First-class Assis. Engineer, in the *Firebrand*; J. Mather, First-class Assis. Engineer, to the *Flagard*, for the *Investigator*; G. Hunt, First-class Assis. Engineer, to the *Pembroke*, for the *Magnet*; A. N. Miller, Acting Second-class Assis. Engineer, to the *Firebrand*, vice Jones.

STEAM SHIPPING.

THE "NEVA."—This fine new Baltic steamer was lost off Niddigens, when on her fifth voyage for St. Petersburg. The *Neva* was a vessel of 558 tons register, built in water-tight compartments, and with four bulk-heads.

LAUNCH OF THE STEAMSHIP "CHINA."—On the 8th ult., Messrs. Napier and Sons launched from their building yard, at Govan, the finest screw steamer the Clyde has ever produced. This vessel, which is named the *China*, is intended as a complement to those fine vessels which are already in the Cunard line. The launch was most successfully completed, notwithstanding the disagreeable character of the weather. The *China* is of 2600 tons burthen, and will be fitted with oscillating engines of 550 nominal horse power, and patent surface condensers, in addition to the ordinary condensers. The following are her dimensions:—Length of keel and fore-rake, 322ft.; breadth (moulded), 49ft.; depth (moulded), 29ft.; and extreme length, 346ft.

UNsinkable AND INCOMBUSTIBLE SHIPS.—The *Briton*, new screw steamer, destined for the Cape mail service, is the first specimen of a novel system of shipbuilding which promises to inaugurate a new era in science. Mr. Lungleigh claims for his invention—which is patented—two great advantages, viz., safety from destruction by water, and, to a great extent, security against fire. Each deck of the vessel is distinct from the others, having no communication with them, but having its separate hatchway or entrance from the upper deck; and the result of this arrangement is, that whatever injury may be incurred to either one or even two decks, the other or others will float. Thus, for instance, should the lower deck be knocked away the two upper decks will float the ship; or should, either from a collision, the starting of a plate under the water line, or from a shot or a broadside penetrating the sheathing, one of the intermediate decks let in the water even to the extent of filling the compartment from stem to stern, the buoyant power would still remain, and the vessel would not only float, but be perfectly manageable, the water merely rising up the trunk hatchway of that particular deck to the level of the water-line outside. The same subdivision of decks which affords the security against entire submersion ensures protection against total destruction by fire. In the event of a fire being discovered on either deck the hatchway of that deck would be fastened down, and the supply of air being thus cut off the fire would die out of itself, or if the fire had got too much hold upon the ship to allow of this, then the entire deck in which the conflagration was raging might be filled with water without risk of other inconvenience than that of having to pump it out again. Another advantage of this mode of building is the perfect ventilation it ensures to all parts of the vessel. Each deck has its own ventilating shaft or shafts in the hatchways, which are its means of communication from above. These separate shafts likewise afford facilities for loading and unloading. The engine room of the *Briton* is not only protected by the watertight deck division, but longitudinal bulkheads or iron walls running fore and aft some feet within the outer shell or sides of the vessel protect it from the chance of injury from without. Thus a fracture in the outside plates occasioned by collision, stranding, or shot, although it might admit the water into the ship, would not affect the engines or the fires.

CONTRACT FOR STEAMSHIPS.—It is stated that Messrs. Scott and Co., of Carlsdyke, have obtained a contract to build eight paddle-wheel steamers, each of 3000 tons, and 700 H.P., for a mail line between France and the West Indies, to be subsidised by the French Government. Three of the steamers are to be constructed at Greenock, and five at Cherbourg, where Messrs. Scott and Co. will establish a building yard for the purpose. The machinery of those built at Carlsdyke will be supplied by the Greenock Foundry Company, and that of the others by a French engineer.

THE "NEW BRUNSWICK."—This steamer, lately launched at New York, and intended for the St. John and Portland route, is very substantially built, and adapted for the roughest sea weather. The minute details of her construction are as follows:—Length on the deck, from fore part of stem to after part of stern-post above the spar deck, 224ft.; breadth of beam at midship section, above the main wales (moulded), 30ft. 2in.; depth of hold, 12ft.; draught of water at load line, 6ft. 6in.; area of immersed section, at this draught, 180 square ft.; tonnage, 815 tons. The *New Brunswick* is fitted with one vertical beam condensing engine; diameter of cylinder, 48in.; length of stroke of piston, 11ft.; diameter of water-wheels, over boards, 31ft.; length of wheel blades, 7ft.; depth of same, 11ft. 10in.; number of blades, 27, constructed of iron. She is also supplied with one return flue boiler, whole length is 26ft. 3in.; breadth (front), 13ft.; height of same, exclusive of steam chimney, 11ft. 7in.; number of furnaces, 2; length of grate bars, 7ft. 6in.; number of flues above, 6; number below, 10; internal diameter of flues above, 11.5in.; internal diameter of those below, two of 5.2in., four of 15in., and four of 17in.; length of flues above, 18ft. 6in.; length of same below, 16ft. 2in. The diameter of smoke pipe is 4ft. 4in.; the boiler has no water bottom, and uses a blower to furnaces. The engine is fitted with expansive gear, and a variable cut-off. The machinery of this steamer was constructed at the Morgan Iron Works, New York. Her trial trip was most satisfactory.

ROYAL MAIL (WEST INDIA) STEAM COMPANY.—The following is a list of this Company's fleet:—

No.	Names.	Reg. Tonnage.	Horse Power.	No.	Names.	Reg. Tonnage.	Horse Power.
1	Shannon (iron)	3,472	800	13	Thames	1,889	430
2	Seine (ditto)	3,440	800	14	Trent	1,856	430
3	Atrato (ditto)	3,126	800	15	Solent	1,689	400
4	Pavana	2,730	800	16	Teviot	1,744	450
5	Magdalena	2,567	800	17	Dee	1,699	440
6	La Plata	2,404	1,000	18	Clyde	1,371	430
7	Onaida (iron screw)	2,284	530	19	Mersey (iron)	1,001	250
8	Tasmanian (ditto)	2,253	550	20	Conway	895	260
9	Tyne (iron)	1,916	400	21	Wye (iron screw)	751	180
10	Avon	1,834	440	22	Derwent	794	260
11	Tamar	1,707	400	23	Prince (iron)	398	200
12	Medway	1,895	430				
						43,715	11,480

RAILWAYS.

SCINDIA.—The agent of this company states that the through traffic of the line had been resumed, and the injury done to the embankment from the inundation was very trifling, when compared with the damage sustained by similar undertakings. With regard to the Indus steam flotilla, it was expected that three of the steamers would be in efficient working order on the Indus before the end of the year, and the entire flotilla in the early part of next year.

PUNJAB.—It appears that recent advices from Lahore state that, notwithstanding the sickness which had prevailed, good progress with the works was being made along the whole line, and that every facility was afforded by the Government; that locomotives had arrived in the Punjab; that the line from Lahore to Umritsir would be opened by the end of next year, and the entire line to Mooltan would be finished by the end of next year. The chief engineer expresses great satisfaction at the progress of the works near Mean Meer.

RAILWAY ACCIDENTS.

COLLISION ON THE SHEFFIELD RAILWAY.—The following are the details of the collision which occurred on the evening of the 19th ult. at the Woodhouse junction on the Manchester, Sheffield, and Lincolnshire Railway, about four or five miles east of Sheffield.

The train is made up at Retford, and was in connection with the twelve at noon Great Northern down train from London, arriving at Manchester at six p.m. On this occasion it consisted of eleven first and second class carriages and two guards' break vans, one of which was placed next to the engine, and the other at the tail of the train. Both the breaks were perfectly new. The engine and tender, also the carriages, had the appearance too of having seen but little service. The train was very well filled, and left Retford about four o'clock, and proceeded along all right to Workshop, where it took up additional passengers, besides the band of the 3rd Manchester Rifle Volunteers, the fourth company of the same regiment—a company composed of clerks and others connected with the Sheffield Railway Company at Manchester. Here the train was delayed a few minutes. After leaving Workshop it proceeded at the usual rate of from thirty-five to forty miles an hour, expecting all was right. Shireoaks and Kiveton Park stations were passed, and the train continued to go smoothly along until it came in collision with some goods or coal trucks, which were unfortunately being shunted at the Woodhouse junction. The engine-driver and stoker, seeing that a collision was inevitable, had jumped off the engine and thereby saved their lives, and escaped with a bruise or two. The engine was much knocked about and partially thrown on its side, and the leading wheels of the tender were thrown off the rails; but the rails themselves were not displaced in the least, although the right engine had sunk into the ground to a considerable depth close by the rail next to the buffer of the six-foot. Two trucks were injured, one being literally smashed to pieces; the one next it was also much injured; the third was simply knocked into the six-foot. The engine was turned into the six-foot after having struck the kerb-stone of the station platform.

ALARMING OCCURRENCE AT THE BRIGHTON RAILWAY STATION.—With the view of improving the public accommodation at this place, the directors of the London, Brighton, and South Coast Railway some time since decided upon enlarging their station on the left hand or London-arrival side. The works have been carried on with great vigour; immense iron girders had been laid for the foundation of the new lines, and the roof, forming a span of 58ft., had been partially raised. This was constructed of a great number of iron bars, fastened into new brickwork of a rather massive character on one side, and joined to the existing top of the station on the other. On the morning of the 16th ult., about 50 yards of the iron roof fell with a tremendous crash on the road beneath. Happily no one was injured. The loss will fall upon the contractor.

FEARFUL ACCIDENT ON THE SHREWSBURY AND WELSHPOOL RAILWAY.—On the morning of the 23rd ult., a terrible accident occurred near Hanwood Station, between three and four miles from Shrewsbury, on the Welshpool line (now nearly completed), by which two men were killed and many others frightfully wounded. It appears that Mr. France, the contractor, runs a train, consisting of an engine, several hallast waggons or trucks, and a guard's van, along the line from Shrewsbury to Middleton, a distance of 14 miles, for the convenience of the workmen. Nearly 200 leave Shrewsbury every morning and return at night. The train left the station as usual shortly after 5 o'clock, and all went right for the first few miles. Shortly before they reached the Hanwood station it was observed that the trucks suddenly began to oscillate fearfully, and in an instant the last truck but one tumbled over with a terrific crash down a slight embankment, pitching the men out in all directions. The truck which followed was also dragged down the embankment, and the men in that were also thrown out, but not with such violence, as the train was not proceeding at a rapid rate. The break van was not thrown off the line, but the men in it jumped out in the greatest consternation. The cries of the poor fellows were heartrending, and as soon as assistance could be procured, it was found that two men were killed on the spot, and two more so fearfully mangled that no hopes are entertained of their recovery. Upon examining the trucks, it was found that one of the irons that run underneath, and to which the coupling chains are attached, had become loosened from constant working, and while they were proceeding along, had worked out from beneath the third truck from the end of the train. That truck passed on, but the next came right upon one end of the bar, the other being driven against a rail, the truck being thus turned completely over, thereby causing the accident.

FEARFUL RAILWAY COLLISION.—On the night of the 12th ult., the Malton and Whitby branch of the North-Eastern Railway was the scene of a fearful accident. The line is full of severe gradients, and trains going north ascend to the table land of the Yorkshire moors at Gothland, whence there is an incline of nearly a mile in length to the valley of the Esk, the gradients being 1 in 14 and 1 in 20. On this incline there is only a single line of rails, and trains are worked up and down by a stationary engine and a wire rope running on pulleys. On Saturday night, a mineral train was being drawn up, and when nearly at the top the rope broke. Back shot the train like an arrow, the brakeman leaping from his van unhurt. At the bottom of the incline a goods train had arrived from Whitby, the engine of which had just passed the points. The driver and stoker saw the trucks rushing down upon them, and both leaped from the engine, saving their lives by a moment of time only. The crash when the two trains met was terrific; the tender of the goods engine and all behind it, together with the runaway mineral train, were smashed to atoms, the fragments of the two trains, portions of the line, minerals, fish, goods, &c., being strewed about in indescribable confusion. The engine of the goods train being cut off from its load by the collision, soon began to descend towards Whitby, the line at the bottom having a gradient in that direction. Providentially the engine, now left to itself, was not on the same line as the mail, which was behind the goods only a short distance, the men in charge of which were first made aware of danger by the derelict engine passing the train. The driver of the runaway, however, set off after it, and succeeded in getting upon it and bringing it back to the scene of the accident. Meanwhile, the mail arrived at the incline bottom, and there the passengers alighted, and gazed with astonishment on the wreck, then learning how narrowly they had escaped a terrible fate; for, had the rope broken a minute later, the goods train would have been clear at the bottom, and the mail must have received the shock instead.

MILITARY ENGINEERING.

ARMSTRONG GUNS.—On the recommendation of the Ordnance Select Committee, the Secretary of State for War has directed the following modifications and alterations to be made in the Armstrong guns:—In lieu of the present pattern plugs, gun-metal plugs with tarred string hooks attached, are to be adopted. Metal plugs for the fuse holes of 40-pounder and 100-pounder shells, being superior in durability, and having the advantage of being interchangeable for all naval shells having the larger fuse-hole, are also to be adopted. Brass washers for Armstrong time fuses are also to be substituted for the iron washers at present in use, the latter being found to corrode from their contact with the powder beneath. The diameter of each is 1.06 in.; width, 0.215 in.; thickness, 0.065 in.; and weight, 3 grs. 18 grs. The following modifications are also ordered to be made in the time fuse:—The thread of the screw for the tightening nut in the head of the fuse is ent in the contrary direction to the turn of rifling, so that the shock of the discharge shall have a tendency to tighten instead of loosening it. India rubber, covered with thin paper, will be inserted to prevent its adhesion to the opposite surface, and an adapter or collar, made of brass, is to be secured in the time fuse when used for 40-pounder and 100-pounder shells, by which arrangement one time fuse will answer for all kinds of projectiles.

TWO OF MR. LANCASTER'S CAST IRON GUNS, strengthened upon his improved system, have lately been severely tested in the bomb-proof cave in Woolwich Arsenal, with a view of ascertaining their utmost amount of durability. The improvement consists in the gun

being clad throughout with longitudinal layers or bars of wrought iron, hooped over with rings of the same metal. The test is stated to have been exceedingly satisfactory. One of the guns resisted every effort to burst it. The second only gave way at the breech after having been fired several rounds loaded to the muzzle.

WOOLWICH ARSENAL.—The royal arsenal at Woolwich took its origin in a singular incident. In the year 1716, some French cannon, taken by Marlborough, were to be recast at the royal foundry at Moorfields, in the presence of Colonel Armstrong, then Surveyor-General of the Ordnance. A young Swiss travelling workman, Andrew Schalach, a native of Schaffhausen, who was among the bystanders, observed the presence of moisture in the moulds, the consequence of which, he foresaw, would be the instantaneous formation of steam, which would explode, because unable to escape from the moulds. The Master-General, the Duke of Richmond, was warned of the circumstance in vain. The Swiss and his friends prudently retired, and scarcely had he quitted the spot, when a terrible explosion occurred; the galleries for the spectators were blown down, the roof of the foundry was carried away, and of the workmen, many were burnt severely and some killed. The authorities advertised for the man who gave the timely warning, and, on his appearance, desired him to select a site for a new foundry, and reside over it. He selected Woolwich for its convenient situation upon the banks of the Thames, and position in the midst of an unoccupied piece of ground—both important considerations, as they furnished an ample practice ground for artillery, and easy means for its embarkation and unshipment. Schalach, after holding his office of Master Gunner during 60 years, died at the advanced age of 90, and was buried at Woolwich churchyard.

100-POUNDER ARMSTRONGS.—The further issue of these guns has been suspended from the ordnance stores at Portsmouth, except where an exchange is required.

RIFLED ORDNANCE.—The competitive trials at Shoeburyness of the rifled 32-pounder service guns have been brought to a close by the Ordnance Select Committee without any very satisfactory results. At the final trial Lancaster's (oval bore), which had previously fired about 90 rounds, stood the 57 competitive rounds without serious wear, but every shell had to be rammed down with a heavy metal rammer by two or three men, and several were cracked or broke up in firing; Scott's (three groove central bore) had already stood 300 rounds, but this gun burst at the 10th round from a flaw in the bore. Hadden's (elliptical three-groove), which had been fired 130 rounds, was cracked at the vent after 50 rounds. Jeffrey's (five groove segmental bore) had fired 50 rounds, and stood the 57 rounds without apparent injury. Britten's (seven-square groove) had fired 300 rounds, and stood the final trial, but all the grooves show considerable wear. Armstrong's improved shunt gun burst at the 45th round. The gun rifled upon the French plan (three-groove) was rendered unserviceable after 52 rounds. The Lancaster and Armstrong shells fit tight; Scott's centres against the groove, but allows a windage $\frac{1}{2}$ of an inch, the others having more or less windage, Britten's as much as $\frac{1}{4}$, which greatly reduces the strain on the gun. With two degrees of elevation, Scott's and Lancaster's and Jeffrey's ranged from 1000 yards; Hadden's, 900; Armstrong's, 1000; and Britten's varied from 750 to 1050 yards. The simple iron shells, of Lancaster, Scott, and Hadden having less wearing effect on the bore, require no covering such as the others necessitate, and the velocities at effective breaching distance appear to be decidedly in favour of the simple iron projectile. The trials have been conducted under the superintendence of the Select Committee, whose report will be anxiously looked for; as the Whitworth and Armstrong heavy guns, as well as the service guns tested at Shoeburyness, have all failed to answer the expectations of the inventors, and none of them appear to be calculated to meet the requirements of the navy.

TELEGRAPHIC ENGINEERING.

TELEGRAPH IMPROVEMENT.—Mr. Stephen Moulton, Bradford, Wilts, has lately introduced an invention which has for its object improvements in the construction of submarine or other telegraphic cables, by which any undue strain on the insulating wires is prevented. His improvements consist in embedding a spiral metal wire (for the purpose of insulating the same) in a strand or cord of india-rubber, and then curing or vulcanising the india-rubber, with the wire therein, by means of sulphur or its compounds, according to the ordinary process. Spiral wires for telegraphic purposes, thus protected, will readily accommodate themselves to any ordinary strain to which submarine or other telegraph cables are subject, without injury to the wire, whilst the india-rubber remains intact; and the cable may be coated or covered with hemp wire, providing such do not injuriously affect its elasticity.

AUSTRALIAN TELEGRAPHS.—The Superintendent of Telegraphs has just returned from the southern districts of the colony, which he visited for the purpose of opening the extension from Gundagai to Deniliquin. This line, which passes through Wagga Wagga, is connected with a private line from Deniliquin to Echuca, where there is a junction of the Victorian and South Australian wires, by way of Castlemaine and Ballarat. There is, consequently, now a separate line of communication with Melbourne and Adelaide, which may be made available for messages in the event of an interruption upon the other lines southward of Gundagai. The line between Deniliquin and Echuca was constructed by a private company, from whom it has been purchased by the Government at its original cost, which, with the office furniture and instruments, will amount to £2820. Upon the opening of the new line, which took place the first week in October, a message was transmitted from the Minister for Public Works, congratulating the inhabitants of Deniliquin on the opening of a telegraph line which would place them in immediate communication with the most important points of the colony, as well as with the neighbouring colony of South Australia, and shortly with Queensland. The second portion of the northern extension, from Murrumbidgee to the northern boundary of the colony, is now finished. In a few days the instruments will be taken up and the line opened to Armidale, or probably to Tenterfield. There has been considerable delay in the continuation of the wire to Brisbane, on the part of the Queensland Government; otherwise there might, by this time, have been a system of communication uniting the four colonies. For this desirable event they will have to wait about two months longer.

MALTA AND CORFU TELEGRAPH.—The screw steamer *Berwick* returned to Malta on the 11th ult., after having made an ineffectual attempt to repair this cable. The fault, or broken end of the cable, was picked up at the spot indicated by the testing, five nautical miles from the shore, in the Bay of San Giori, Corfu, in 175 fathoms water. On sounding, however, a short distance beyond the fault, no bottom was obtained at 425 fathoms, it was, therefore, found impossible to continue the operations for the repair of the cable with any probability of success. It has been decided to recover as much cable as possible from the Malta end. On the completion of this work the old cables between Malta and Marsala and Cagliari will also be picked up. The gutta-percha core of the cable was found to be in an excellent state of preservation, but the outer wires, where the cables lay in black mud, were very much corroded and worn by oxidation.

OXIDATION OF TELEGRAPH WIRES.—A French paper states that M. Loir has recently ascertained that the telegraph wires under his care which passed near to mines, coke fires, or any place where smoke was abundant, had become deeply oxidised and deteriorated. Upon the line between Lyons and St. Etienne, that part which extended from the latter place to Givors, was exposed to smoke and became oxidised, while that extending from Givors to Lyons, along the Rhone and not in the neighbourhood of factories, showed no signs of alteration. A careful analysis of the oxidised portion proved that the galvanised wires did not contain any zinc, and that their oxidation was owing to the car-

bonic acid and sulphuric acid contained in the smoke. This analysis has also shown the presence of the sulphuric acid, which forms with the wire a sulphate. M. Loir has ascertained that the sulphate of iron is always formed upon galvanised wires, which can take place only by the separation of the verdigris from the copper at the moment of its union with the zinc, a separation effected by means of the sulphuric acid. Hence it follows, that zinc as now used for telegraphic wires may hinder the rapid transmission of the current, since it brings in contact with the iron an acid salt forming a galvanic pile, and producing, by chemical agency, currents of electricity which may counteract the current of the telegraph.

MALTA AND ALEXANDRIA CABLE.—This cable has been most successfully completed, and is the second instance in which Her Majesty's Government have ventured to expend public money upon undertakings of this kind. The first case was the temporary line, laid for war purposes from Varna to the Crimea, and although its existence was short it did good service, and tended in a great measure to shorten the war. Much experience has since been gained, both scientifically and practically, and therefore it is natural to expect that this second venture of the Government will be no less remunerative than the first. The cable which has been laid between Malta and Alexandria was originally designed and intended to be laid between Falmouth and Gihiratar; in fact its destination was not altered until many miles of the cable were manufactured. For reasons best known to the Government it was subsequently determined to lay the cable from Rangoon to Singapore, and the whole length was made with that end in view, and some of it was actually shipped for that destination; and it was only at the commencement of this year that a final decision was come to, and orders given to lay the line from Malta to Alexandria.

BRIDGES.

NEW BLACKFRIARS BRIDGE.—The levels of the new bridge over the Thames at Blackfriars bridge, in the stead of the present unsightly and dilapidated structure, have been taken. The intended structure will be 6ft. 10in. lower in the centre, and 2ft. 9in. lower at the side arches than the present bridge, and the incline will therefore be easy. The width of the bridge will be 80ft. within the parapets, being nearly double that of the present bridge. In construction, it will be similar to that of Westminster, but with only three spans to cross the river.

FALL OF A BRIDGE AT YORK.—Some fifty persons were engaged in the erection of this girder bridge over the river Ouse, when, in the act of lowering one of the outer girders, it fell over, striking the next girder, which had been lowered in its place: this also fell, and in succession two other girders, of which the bridge was formed, came down, the last one, and upon which a number of men were employed, dropping a considerable depth, and with a frightful crush, into the bed of the river. The weight of this falling mass of iron would be upwards of 350 tons. Large numbers of the workmen were pitched into the water, five being killed, and a large number more or less wounded.

VIADUCT OVER THE TAY.—A viaduct across the Tay is proposed, to amalgamate the North British and the Edinburgh, Perth, and Dundee lines. The cost of the tubular bridge is estimated at £500,000, and a bridge at Murgdaw at £180,000.

Messrs. J. F. Cail and Co., of Paris, have just executed across the Kliazma a bridge at Pokrov (on the network of the Great Russian Railway Company) 430ft. long, the work being executed for the most part by workmen sent from France, who have thus braved a temperature which even Russians resist with some difficulty. The same firm is about to execute on the second section from Vladimír to Nijui fourteen bridges, three of which are from 300ft. to 1000ft. long. An important bridge across the river Po at Plaisance has just been entrusted to two French "houses of construction," viz., MM. Parent, Schacken, Caillet, and Co., whose workshops have been transferred from Oullins to Fires, near Lille, and MM. J. F. Cail & Co., Paris. This bridge, which will have a length of about 900ft. with traves of 230ft. opening, will form a junction with the Lombardian and Central Italy Railways.

DOCKS, HARBOURS, CANALS, &c.

SEBASTOPOL HARBOUR.—Colonel Gower has been engaged since 1857 in clearing this harbour. He has succeeded in raising eight large war steamers (including the *Vladimír*, well known in the Crimean war), also 1 50-gun frigate, 3 corvettes, 12-gun brigs and transports, and several smaller craft. All these have been raised entire and floated. In addition to the above, the vessels recovered by blasting include a 3-decker, 5 2-deckers, 2 frigates, 2 corvettes, and 5 transports. Many of the ships lay full three fathoms in the mud, and, owing to the difficulty of clearing it away, it takes some months for the divers to get the ships slung with chains under the keels, in order to lift them entire, with the six caissons, or floating docks which are used for that purpose, and only those ships can be so slung that sit on even keels.

SUEZ CANAL.—The excavations which are being made for the canal for the Isthmus of Suez have led to the discovery at Gizch of a religious edifice as vast as the Louvre, and which was constructed more than 5000 years ago. At Karnac also a temple, the circuit of which is stated to be 4 kilometres ($2\frac{1}{2}$ miles), has been discovered, and another at Edou, containing 20 saloons. The walls of these latter edifices are decorated with sculptures, hieroglyphics, and paintings, still fresh.

WATER SUPPLY.

ANALYSIS OF WATER.—The analysis of the water supplied in September by the London water companies, show that the Chelsea Company's, the Southwark Company's, the Kent Company's, and the New River Company's waters contain less organic impurity than is contained in the Loch Katrine water supplied to Glasgow, and considerably less than that contained in the water supplied to Manchester. The water of the West Middlesex, Lambeth, and East London Companies contained each rather more than one grain of organic matter per gallon.

GAS SUPPLY.

AT THE HENDON GAS WORKS, Sunderland, the tank is 125ft. in diameter, and 25ft. deep. The gasholder was erected by Messrs. T. Pigot and Sons, of Birmingham. The diameter is 120ft., the depth 50ft., and it will hold 600,000 cubic feet of gas.

THE NEATH GAS COMPANY are building two large gasometers at the Latt. One of the gasometers is being built near the canal, and when the men were digging for the foundation, the water suddenly broke in upon them, completely inundating the whole of the works.

GAS METERS.—By the new Act which came in operation on the 14th ult., it is enacted that in the metropolis, and in all counties and boroughs which have adopted the Act, no meters shall be fixed after the 13th October, unless first tested and stamped as correct by an inspector appointed under the Act, in a similar way as weights and measures generally are authenticated. Any person fixing or using an unstamped meter, fixed after this date, in such districts, will be liable to a penalty of £5 in each case; and according to the wording of the act, "any contract, bargain, or sale, made by such meter shall be void, and every such meter so used shall, on being discovered by any inspector so appointed as aforesaid, be seized, and, on conviction of the person knowingly using or possessing the same, shall be forfeited and destroyed." The necessity for such an Act of Parliament

has long been felt, in consequence of such a large proportion of the meters in use having been discovered to be registering inaccurately to an enormous extent, viz., in many cases, as much as 25, 35, and even in some cases more than 50 per cent., and almost always against the consumers.

BOILER EXPLOSIONS.

THE ASSOCIATION FOR PREVENTION OF STEAM BOILER EXPLOSIONS.—At the last ordinary monthly meeting of the Executive Committee of this Association, held at the offices, 41, Corporation-street, Manchester, September 24th, 1861, Hugh Mason, Esq., of Ashton-under-Lyme, Vice-President, in the chair, Mr. L. E. Fletcher, chief engineer, presented his monthly report, from which we have been furnished with the following extracts:—"During the past month the ordinary visits of inspection have been made, and the following defects discovered:—Fractures, 2; corrosions, 5; safety valves out of order, 3; water gauges, ditto, 3 (1 dangerous); pressure gauges, ditto, 2; feed apparatus, ditto, 1; blow-off cocks, ditto, 7; fusible plugs, ditto, 7; furnaces out of shape, 4 (1 dangerous); over-pressure, 11. Total, 40 (2 dangerous). Boilers without glass water gauges, 6; ditto without pressure gauges 16; ditto without blow-off cock, 10; ditto without back-pressure valves, 26. Two very serious explosions have happened during the last month, from which, in one instance, no less than eight lives were lost. Both of these explosions took place in London, and neither of the boilers in question was under the inspection of this Association. Owing to the large number of explosions which have lately happened—although not one of them, I am happy to say, has occurred to the boilers under the care of this Association—my remarks have been unavoidably very much confined to the details and causes of these events, and thus have had reference rather to questions relative to the "prevention of steam boiler explosions" than to the "effecting economy in the raising and use of steam." I have, however, for some time been anxious to state to our members the great economic advantage they would derive by the addition of *steam jackets* to their cylinders; and though these may be difficult to supplement to those already constructed, still our members are constantly laying down new engines, when they could be introduced. The steam jacket was first applied nearly a hundred years ago, by James Watt; and in his original engine, which effected such a revolution in the use of steam, it was one of the fundamental principles, and for it a special claim was made in his patent. With the exception of the Cornish pumping engine, which has for years maintained a character for great economy, the steam jacket has been neglected by Watt's successors, who thereby have only made a step in the wrong direction, and I think that this step has been made partly from motives of the most mistaken economy, and partly from the fact of the action of the jacket not having been correctly understood, so that, even when it has been applied, its construction has, in most cases, been so defective as to completely neutralise its advantages. The late Dr. Harecroft, of Greenwich, was, I believe, one of the earliest to discover and publish wherein the secret lay of the virtue of the steam jacket. He showed that it did not lie in preventing loss on the *outer* surface of the cylinder by radiation, as had been generally supposed, but in the prevention of loss on the *inner* surface from condensation and re-evaporation, caused by the alternating communication of the cylinder with the boiler at a high temperature and the condenser at a low one. On the introduction of steam to the cylinder, condensation takes place, and a coat of dew is formed on the whole of its internal surface; and on the communication with the condenser being made by the opening of the exhaust port, this coat of dew is re-evaporated, thereby considerably cooling the metal of the cylinder. On the re-introduction of the steam on the return of the stroke, another deposit of dew is made to atone for the heat abstracted by the re-evaporation already referred to, and thus a process of alternate condensation and re-evaporation is set up, which keeps pace with every stroke of the engine, and is destructive of all economy, since by it a considerable per centage of steam passes through the engine from the boiler to the condenser, without doing any work; thus indicator diagrams do not correctly give the amount of steam used, and measurement of the quantity of water evaporated in the boiler show that a large proportion of the steam supplied to the cylinder of the engine is entirely unaccounted for. This action can only be arrested by maintaining the cylinder at as high a temperature as the steam which enters it, the most practical way of effecting which is found to be the use of James Watt's original steam jacket. A great stride in economy has recently been made in marine engines, one of the most important elements in the attainment of which has been the steam jacket, and without this it has been found that it is utterly futile to attempt to realise the full economic duty of high pressure steam worked expansively, although with low pressure steam, carried throughout the whole stroke, the jacket is not so necessary. I lay these particulars before our members to give them the advantage of the experience of other departments of engineering, and wish that such of them as have steam jackets fitted to their cylinders, would co-operate with me in thoroughly testing their result, that the information may be diffused throughout the whole Association. One of our members reports to me, that from a jacket of only partial extent, a saving of steam is effected of 12½ per cent. In conclusion.—To economy of fuel, an economical use of steam is essential, which can only be attained by a high degree of expansion, and this cannot be beneficially exercised without the steam jacket.

THE LONDON ASSOCIATION FOR THE PREVENTION OF STEAM BOILER EXPLOSIONS has just commenced operations under the presidency of Dr. W. Fairbairn, and a council consisting of nearly all the eminent scientific men of the day.

MINES METALLURGY. &c

MUSEUM OF IRISH INDUSTRY.—The annual meeting for the distribution of prizes, in connection with this museum, took place on the 3rd ult. Sir Robert Kane, the founder of the Institution, in the course of an address on the "statistics of mining industry in Ireland," stated:—"The principal products of the Irish mines are sulphur, lead, copper, and coal. The General Mining Company has commenced to work zinc from their silver mines in Tipperary. Iron exists in the country in large quantities, but the available supply of coal is not sufficient to carry on the operations with respect to this ore. Last year the Wicklow sulphur mines yielded 107,000 tons of ore, employing 1200 hands, representing a mining population of 5000. The principal copper mines are at Knocknabreena and Berhaven. The ore is exported and smelted in England. In 1859, they yielded 10,859 tons, value £108,017; persons employed, 3370. The lead mines of Glendalough produced 1814 tons. In 1859, the mines of the Seven Churches yielded 12,650 ounces, value £3480. The coal mines are generally not more than three or four ft. in thickness, chiefly anthracite. There are 45 collieries altogether, 35 in the south, 10 in the north. In 1857, the quantity raised was—bituminous, 42,150 tons; anthracite, 78,250; in all, 120,400; value at 8s. per ton, £48,000.

COLLIERY ACCIDENT IN FRANCE.—A terrific accident recently occurred in a coal mine at Bessèges, in the Gard. The mine having been flooded by the late rains, a landslip took place, and more than 100 workmen were either smothered or drowned. The Prefect of the Gard having been apprised of the circumstance at ten at night, left his residence, accompanied by several public functionaries, and by the chief engineer of the department, and proceeded to the mine in a special train. On arriving at the scene of the disaster, it was ascertained that 117 miners were missing, and that 1,800,000 cubic yards of water had rushed into the mine, and caused numerous landslips. The engineers are of opinion that it will require three months to pump out the water. It appears that a waterspout burst, and caused a torrent, which rushed into the mine with such violence and rapidity that even the overseers had not time to save themselves. An explosion of gas took place at the same time, by which a portion of the mine was blown up. Though every means of rescuing the victims have been taken, there is but little probability of saving the lives of those who are buried in the mine.

APPLIED CHEMISTRY.

ON SOME NEW ANILINE COLOURS.—If aniline be mixed with bisulphide of carbon, and allowed to stand for some days, sulphuretted hydrogen is evolved and a cream-coloured, fatty-looking body left. If a little fuming nitric acid be carefully added to this, a beautiful crimson-coloured substance, along with a dirty-brown body, will be produced. No good method has been found for separating the two. But if a portion is first dissolved by boiling in alcohol, and then fuming nitric acid carefully added, drop by drop, a crimson-coloured fluid is produced, which dyes either wool, silk, or cotton, although they take it more readily if it be first slightly acidified with sulphuric acid. Again, by dissolving the above-mentioned fatty substance in benzole and treating with nitric acid, a fluid is produced which may be used for dyeing lemon-colour. It ought to be mentioned that if either the solution in alcohol or benzole be allowed to cool before the nitric acid is added, a large quantity of clear crystals will separate. None of the above colours rival, or even equal, those already known, but the reactions are interesting, and we think them worthy of attention.

DISINFECTING OF SEWAGE.—The Medical Inspector to the Westminster Burial Board, has, on a recent occasion, described the important results which have followed the adoption of Mr. Macdougall's process for the deodorization of sewage. The plan has been put into operation in connexion with the town-drainage systems of Carlisle and Exeter, and is stated to have been completely successful both as regards the mitigation of a nuisance and the economical recovery of valuable manuring agents for agricultural employment. The process consists merely in the addition to the sewage of one gallon per diem of crude carbonic acid, costing, with carriage included, only 10½d. a day—i.e. £16 a year,—a sum extremely small as compared with that about to have been spent by the Boards of Health in these towns respectively for the purpose of conveying to a distance that which has hitherto proved a nuisance to the inhabitants and been subject to indictment. The apparatus for conducting the mixing process is as simple as could be desired, and the small proportion in which the disinfectant need be employed renders its application extremely economical.

PROCESSES FOR THE CONSECUTIVE PREPARATION OF SALTPETRE, POTASSIO-TARTRATE OF SODA, A PURE BITARTRATE OF POTASH, TARTARIC ACID, AND THE SULPHATES OF SODA AND POTASH.—Guido Schnitzer gives the following as an easy and convenient way of obtaining the above salts.—He starts with equivalent weights of Chili saltpetre (nitrate of soda) and rough pot ashes, which he heats, with just enough water to dissolve them, in an iron vessel, stirring well all the time. When the mutual decomposition which ensues is complete, he adds to the boiling liquid sufficient milk of lime to convert the carbonate into caustic soda. The solution containing the nitrate of potash and soda is then evaporated for the nitrate of potash to crystallise out, which the author says it does completely. The crystals are then drained from the soda solution, and washed with water slightly acidulated with hydrochloric acid to remove the last traces of soda. The soda solution is then used for the preparation of the double tartrate of potash and soda. For this purpose it is boiled with sufficient rough tartar to make a neutral solution. This operation is best conducted in a copper vessel. A deposit of some tartrate of lime from the rough tartar remains, which may be carefully washed and used in the subsequent process for making tartaric acid. When filtered from this deposit, the solution is evaporated for potash, he takes the filtered solution of the double tartrate as above, and adds sufficient hydrochloric acid to combine with the soda, whereupon the bitartrate of potash separates in small granular crystals, which are drained and washed with cold water to remove any chloride of sodium. To make pure tartaric acid, the author takes the solution of the double tartrate as before, and boils it with gypsum free from iron, whereby tartrate of lime and the sulphates of potash and soda are formed. The tartrate of lime is decomposed by sulphuric acid in the usual manner, and then (any iron having been removed by the alkali) the tartaric acid is obtained quite pure in the first crystallization. The sulphates of soda and potash are afterwards separated by crystallization.

PREPARATION FOR GILDING PORCELAIN.—This preparation, the invention of the Brothers Duterte, is reported on by Salvétat. The peculiar advantage of it is, that after burning, the gold is so bright as not to require polishing. Thirty-two grammes of gold are gently warmed with 128 grammes of nitric acid, and the same weight of hydrochloric acid. To the solution are added 1.2 grammes of tin and 1.2 grammes of butter of antimony, and when all are dissolved, the solution is diluted with 500 grammes of water. A mixture is now prepared by heating together 80 grammes of oil of turpentine, 16 grammes of sulphur, and 16 grammes of Venice turpentine. When the sulphur is dissolved, 50 grammes of oil of lavender is added. The gold solution is now added, and the two are well stirred together until the aqueous solution becomes decolorised, showing that all the gold has united with the balsam. The watery portion is then poured away, and the oily fluid is washed with warm water, and then heated. When the last trace of moisture has disappeared, 65 grammes more lavender oil, and 100 grammes of oil of turpentine, are added, and the whole warmed to ensure the perfect admixture. While quite fluid, 5 grammes of subnitrate of bismuth are added. Afterwards, the clear part is decanted from any reduced gold and other insoluble matters, and the balsam is concentrated to a fit consistence for painting with. The balsam so prepared is a thick fluid of a pale green colour, the gold being perfectly dissolved; when proper care is taken to remove all moisture, this preparation never blisters in burning.

PURIFICATION OF ACETIC ETHER.—The following method of rectifying acetic ether is given by Engelhardt: The rough product contains free acetic acid and alcohol. In consequence of the presence of the latter, it is soluble in an equal volume of water, but when pure, it requires at least seven times its volume to dissolve. He begins by neutralizing the acetic acid with calcined magnesia; he then dilutes with an equal volume of water, and afterwards adds sufficient common salt to make a saturated solution. When no more salt dissolves, the whole is shaken up, and then allowed to rest, whereupon the mixture separates into two layers, the lower of which is a saturated solution of common salt in dilute spirit, and the upper acetic ether nearly anhydrous (0.89) and quite pure. No further rectification is necessary.

MANUFACTURE OF SULPHUROUS ACID.—To produce sulphurous acid, Mr. C. A. Drevet, of Rouen, proposes to introduce through an opening into a cast iron retort a quantity of sulphur, which he melts by heat from a furnace when it is inflated. The retort is hermetically closed, and a current of air is caused to enter through a pipe, through a perforated plate, by means of bellows. The sulphurous acid thus produced passes through a receptacle divided into compartments in which flowers of sulphur deposits, and is cooled in a leaden serpentine or worm, whence it is passed into the receptacle, with compartments containing either water or a solution of a base or of a carbonate. The azote in a free state, and the carbonate acid gas (when a carbonate is employed) escapes into the atmosphere through an opening. A gas separating apparatus is also employed when a bi-salt is formed. This apparatus consists of a box into which the end of a leaden pipe is immersed, through which passes the disengaged gas from the principal apparatus. These gases are passed through an alkaline solution, and become freed from any sulphurous acid gas. He employs the bisulphide of soda obtained by this process for bleaching purposes.

PREPARATION OF HYDRATE OF BARYTA.—Müller recommends the preparation of hydrate of baryta from sulphide of barium and oxide of zinc. The last is slightly soluble in baryta water, but it can be easily removed by a little sulphide of barium reserved for the purpose. Any traces of sulphur remaining may be got rid of by adding a little sulphate of copper. If any thionic acid is formed during the operation, it may be got rid of by calcining the baryta obtained with a little nitrate of baryta.

APPLICATIONS FOR LETTERS PATENT.

Dated September 24, 1861.

2378. J. D. Parkes, 47, Parliament-street, Westminster—Propeller of a ship.
2379. W. E. Wiley, Great Hampton-street, Birmingham—Pens and pen-holders.
2380. A. J. Sedley, 210, Regent-street—Constructing bridges and viaducts.
2381. G. J. Gladstone, Blackwall—Apparatus for disengaging boats.
2382. T. Davey, Tucking Mill, Camborne—Manufacture of safety fuses.
2383. C. Watt, Graham-street, Walworth, J. Watt, of Lorrimore-street, Walworth, and T. S. Haviside, Cornhill—An improved mode or method of bleaching palm oil.
2384. J. Fawcett, Wakefield, Yorkshire—Material adapted for the scouring, cleansing, and fulling of woollen or other cloths.
2385. J. Cottrill, Studley, Warwickshire—Manufacture of certain descriptions of needles.
2386. G. Davies, I, Serle-street, Lincoln's-inn-fields—Preserving provisions.

Dated September 25, 1861.

2387. J. Banks, 19, Salisbury-street, Adelphi—Electromagnetic telegraph printing apparatus or marking instruments.
2388. C. G. Lenk, 24, Maddox-street, Regent-street—An improved tank pen.
2389. J. Musgrave, Globe Iron Works, Bolton-le-Moors—Application of steam power.
2390. T. Bright and R. Mills, Rochdale, Lancashire—Means employed in the printing of yarns for carpets and other fabrics.
2391. H. Purnell, Glasgow—Constructing and arranging warming apparatus.
2392. E. A. Brooman, 166, Fleet-street—Apparatus for letting off water from and for admitting oil into steam cylinders.
2393. W. T. Crane and T. J. Ellis, Liverpool-road, Middlesex—Applying breaks to omnibuses.
2394. T. Richardson, Newcastle-upon-Tyne, and R. Irvine, Hurlet, Renfrewshire—Treating gelatine.
2395. A. V. Newton, 56, Chancery-lane—Working telegraph apparatus.
2396. T. Richardson, Newcastle-upon-Tyne—Manufacture of muriate of iron for the purification of coal gas.
2397. J. Vaughan, Middlesbrough, Yorkshire—Treating gas produced by blast furnaces.
2398. G. Russell, Swan Hill, Shrewsbury—Spring stretchers or bedsteads for camp, hospital, or general use.

Dated September 26, 1861.

2399. D. J. Fleetwood, George-street, St. Paul's, Birmingham—Nails.
2400. T. Bentley, Margate—Apparatus for beating eggs.
2401. Henry Nunn, Chelsea—Mangles.
2402. J. Openshaw, W. Entwistle, and J. Lord, Bury, Lancashire—Males for spinning cotton.
2403. G. Caldwell, Kilmarnock, and J. Y. Miller, Milliken, Renfrewshire—Apparatus for dressing flour.
2404. J. H. Johnson, 47, Lincoln's-inn-fields—Smoothing irons.
2405. S. S. Robson, Sunderland—Apparatus for raising or lowering heavy bodies.
2406. G. T. Bousfield, Loughborough Park, Brixton—Knapsacks.
2407. J. Tessier, Paris—New means of saccharifying corns and cereal grasses.
2408. M. F. A. Courtoise, Paris—Kilns or ovens for burning or calcining limestone.
2409. J. D. D. Passager, Paris—Lamps for burning palm oil.
2410. V. S. Lété, Paris—Aerated or sparkling white wines.
2411. R. Davies, Splidts Terrace, Backchurch-lane—Churns.
2412. W. Clark, 53, Chancery-lane—Manufacture of peat.

Dated September 27, 1861.

2413. E. Franklin and G. Bacchus, 10, Chapel-street, Stratford—A reversible back supporting nursing belt.
2414. F. W. Shields, 47, Parliament-street, Westminster—Applying wrought iron or steel plates to the covering of forts, buildings, floating vessels, and other constructions.
2415. G. Smith, Liverpool—Gas meters.
2416. J. Kimberley, Birmingham—Machine for sawing, drilling, and grooving wood.
2417. D. McCallum, Greenock—Closing bottles and other vessels.
2418. S. Rowsell, Buckland St. Mary, Somersetshire—Horse rakes.
2419. J. Waller, Annerly, Surrey—Smoke-consuming stove.
2420. J. S. Phillips, 10, College-crescent, Finchley-road, N.W.—Enabling mankind to fly through the air.
2421. G. J. Gaugier and E. E. Collet, 13, Place de la Bourse Paris—Envelopes.

Dated September 28, 1861.

2422. J. A. Knight, 4, Symond's Inn, Chancery-lane—Steam pumping engines.
2423. W. N. Wilson, 144, High Holborn—Sewing machines.
2424. S. W. Rix, Beccles, Suffolk—Fixing woodwork, iron-work, fittings, or furniture to walls or buildings.
2425. J. Reeves, New York, United States—Electro-magnetic engines for obtaining and applying motive power.
2426. D. Lane, Cork—Apparatus to regulate the passage of gas, water, and other fluids.
2427. J. Moiroux, 11, Rue St. Elizabeth, Lyons, France—A

- portable spring bedstead and mattress, moveable or fixed.
2428. T. Potts, Old Kent-road—Clasps for books.
2429. M. Theiler, Einsiedeln, Switzerland—Telegraphs.
2430. C. Comer, jun., Broughton Copper Works, Salford, Lancashire—Manufacture of metal tubes for bedsteads.

Dated September 30, 1861.

2431. T. Smith, Aberdeen-street, Sheffield—A military steel umbrella.
2432. E. Funnell, Brighton—A self-acting alarm for preventing railway collisions.
2433. J. S. Bickford and G. Smith, Tucking mill, Camborne, Cornwall—Safety fuses.
2434. B. G. George, Hatton-garden—Mounting of tablets, show bills, prints, photographs, and drawings.
2435. J. Lush, St. George's-square, Portsea—Mashing attempters.
2436. C. H. Pennycook, Glasgow—Chimney hoods and ventilators.
2437. W. J. Christy, St. Albans, Hertfordshire—Mailing ships of war.
2438. E. Reoche, Paris—Medicinal preparations applicable as a lotion.
2439. H. Hickman, Birmingham—Protecting the locks and sights of fire-arms.
2440. F. Walton and R. Beard, British Grove Works, Chiswick—Manufacture of varnishes applicable to the water-proofing and coating of fabrics.
2441. P. A. F. Bobeuf, Paris—Application of certain new hemostatic and antiseptic agents.

Dated October 1, 1861.

2442. W. E. Matthews, Sea View, St. Helens, Isle of Wight—Conveying a line of other medium of communication from a ship or vessel for the purpose of obtaining relief or assistance in case of shipwreck.
2443. J. A. Knight, 4, Symonds Inn, Chancery Lane—Manufacture of boots and shoes.
2444. O. O. Lesourd, Paris—Joining pipes and tubes.
2445. R. Nightingale, of Maldon—Markers, butts, or mantlets.
2446. J. W. Scott, Worcester—Gunn wads.
2447. J. W. Scott, Worcester—Tools for the manufacture of leather.
2448. W. H. Payn, Dover—Apparatus for preventing the loss and facilitating the recovery of ships' moorings and submerged property in general.
2449. W. S. Hogg, Rotherhithe Wall, Rotherhithe—Rendering columns, girders, doors, shutters, and other parts of buildings fire-proof.

Dated October 3, 1861.

2450. J. H. Hesford, Cunliffe Street Works, Bolton-le-Moors Lancashire—Steam engines.
2451. A. D. Bishop, 13, King Street, Cheapside—Pumps.
2452. D. Rerolle, 4, South Street, Finsbury—Steam digging machine.
2453. A. Wyley, Allsops Place, Regent's Park—Fire-arms.
2454. A. Fowler, 4, Scott's Yard, Cannon Street—Buffers of railway carriages.
2455. J. Davis, and T. Evans, Ulverston, Lancashire—Engines to be worked by steam, air, or gases.
2456. W. Maltby, De Crespigny Park, Camberwell—Manufacture of starch and starch gum.
2457. J. A. Coffey, Providence Row, Finsbury—Motive power engines.
2458. E. A. Brooman, 166, Fleet Street—Manufacture of figured colored fabrics.
2459. W. Thompson and T. Strather, Kingston-upon-Hull—Hydraulic presses.
2460. E. Breftit, King William Street—Machinery employed in cutting hollow and solid corks.
2461. E. Breftit, King William Street—Manufacture of boxes or cases.
2462. C. G. Hill, Nottinghamshire—Manufacture of bonnet and cap fronts.

Dated October 3, 1861.

2463. J. C. Dickinson, Blackburn, Lancashire—Steam engines.
2464. W. T. Henley, St. John's Street Road, Clerkenwell—Magnetic and electric telegraph apparatus.
2465. J. C. Haddan, Bessborough Gardens, Pimlico; and C. Minash, 3, Saint James's Terrace, Kentish Town Road—Mode of discharging cannon.
2466. T. Warwick, Birmingham—Manufacture of umbrellas and parasols.
2467. H. Law, 15, Essex Street, Strand—Apparatus for raising ships out of water for the purpose of examination, cleaning, or repair.
2468. J. A. Tannahill, Devon and Cornwall Bank, Truro—Apparatus for counting money.
2469. R. J. Ellershaw, Leeds—An improved machine for expressing oil.
2470. T. Evans, Westmoreland Street, Westminster—Manufacture of boots, shoes, and other coverings for the feet.
2471. C. Mauvernay, Lyons—An improved method of signalling the passage of trains upon railways.
2472. J. Wood, Birmingham—Manufacture of metal pens.
2473. W. Malam, Skinner Street—Gas holders.

October 4th, 1861.

2474. J. Stuart, 5, Vulcan-place, Castor-street, Poplar—Oils obtained by the distillation of bones.
2475. P. Knowles, Bolton-le-Moors—Machinery for opening and cleaning cotton and other fibrous materials.
2476. E. T. Hughes, 123, Chancery-lane—Permanent way of railways.

2477. C. Husson, Nantes—Silvering looking glass in piles of several sheets superposed without interruption.
2478. A. David, jun., Nantua, France—Preparing and fixing street and other inscriptions or lettering.
2479. J. Beesley, Coventry—Covering crinoline wire and other like substances.
2480. G. Knox, Skinner's-place—Paper-making machines.
2481. C. M. Elstob, Spalding—Buckets and portable water-cisterns.
2482. T. G. Ghislain, Hatton-garden—Treatment or preparation of certain foreign plants or vegetable substances, and of the application of the same to various useful purposes.
2483. J. Pratt, Coventry—Shuttles for weaving ribbons.
2484. J. Dellagana, Shoe-lane—Finishing and perfecting curved or circular stereotype plates.
2485. S. Keely, Kent Cottage, Byron-street, Bromley—Manufacture of gongs.
2486. J. Tweedale, Milkstone, Rochdale—Machinery for preparing and spinning cotton.

October 5th, 1861.

2487. J. Lansley, Brown-Candover, Hants—Construction of ploughs, drills, scarifiers, and suchlike agricultural implements.
2488. J. Edwards, 77, Aldermanbury—Manufacture of buttons.
2489. E. Partridge, Patent Axle Works, Smethwick—Hardening iron and steel.
2490. W. Rowan, Belfast—Machines for scutching and preparing flax.
2491. P. O'Connor, Wavertree, near Liverpool—Construction of gas stoves for heating and warming.
2492. J. S. Collins, Liverpool—Reefing and furling the sails of ships.
2493. J. Turner, Upper Thames-street—Machine for mixing mining, and pounding.
2494. G. Nares, Portsmouth—Apparatus for effecting communication between places otherwise inaccessible to each other.
2495. W. Clark, 53, Chancery-lane—Gas regulator.
2496. T. Hughes, Birmingham—High pressure tap for regulating the flow of steam, water, or other fluids.
2497. W. Squire, Upper Montague-street, Bryanstone-square, —Machinery for planing and shaping wood.

October 7, 1861.

2498. B. P. Walker, Wolverhampton—Rifle sights and rifle sight guards.
2499. A. Chaplin, Glasgow—Combined winding engine boiler and cooking and distilling apparatus.
2500. W. Calcott, Park Village East—Apparatus for producing seismic effects.
2501. W. Keiller, Perth—Signalling for rifle practice.
2502. G. K. Stothert, Bristol—Condensing apparatus.
2503. J. E. J. Sensum, Lower Kensington-lane—Machinery for mashing malt.
2504. F. J. Evans, Chartered Gas Works, Horseferry-road, Westminster—Apparatus for generating gas.
2505. J. C. Willsher, Petches, Finchingham—Combined thrashing and dressing machines.

Dated October 8, 1861.

2506. A. Ford, Battersea, Surrey—Waterproofing.
2507. W. Catford, Chard, Somerset, and J. S. Wheatley, Nottingham—Manufacture of bobbin net or twist lace.
2508. H. Willis, Albany-street, Regent's-park—Construction of organs.
2509. G. Glover, Lowestoft—Constructing fire-proof doors and window shutters.
2510. W. Simpson, Calais—Manufacture of twist lace made in twist lace machines.
2511. S. Bremner, Ludgate-hill—Construction of printing machines, and in driving or actuating the same.
2512. I. Evans, jun., Ruabon, Denbighshire—Miners' lamps.
2513. J. E. Grisdale, 53, Cheapside—Tickets or passes for railway and other purposes.

Dated October 9, 1861.

2514. R. W. Sievier, Guildford-street, Russell-square—Batteries for the purposes of war.
2515. I. Daggis, Green-terrace, and J. T. Parkes, Armoria-terrace, Middlesex—Manufacture and treatment of india-rubber and vulcanite as applied to various purposes.
2516. W. Smith, 21, King-street, West Smithfield—Apparatus for measuring and regulating the pressure of gas.
2517. E. Haslewood, 7, Lothbury—Apparatus for preventing or loosening the slip of the driving wheels of locomotive engines.
2518. J. Walker, Knockagh Carrickfergus, Antrim—Chimney top, cap, or cowl for the prevention of the descent of sooty exhalations, curing of smoky chimneys, and ventilation of apartments.
2519. J. Norman, Glasgow—Hammers to be worked by steam or other elastic fluid, and anvils for the same.
2520. G. Davies, I, Serle-street, Lincoln's-inn—Machinery for manufacturing shoes for horses and other animals.
2521. H. B. Coathupe, St. James's, and F. H. Waltham, 15, Palace-street, Haverstock-hill—Obtaining or producing and applying embossed or raised and engraved or indented metal or other surfaces.
2522. F. Curtis, Newton, United States—A new and useful improvement in fire-arms.
2523. W. Palmer, Snton-street, Clerkenwell—Lamps and lamp wicks.
2524. J. J. Russell, Crown Tube Works, Wednesbury—Hand stocks and dies for cutting screws.
2525. T. Tidmarsh, Dorking, Surrey—Artificial manure.

2526. J. Schwartz, Osborn-street, Whitechapel—Manufacture of sugar.
Dated October 10, 1861.
2527. W. J. Williams, Wamford-court, London—Process of charging illuminating gas with the vapour of the hyduret of carbon, for the purpose of increasing its illuminating properties.
2528. T. P. Bennett and J. Collier, Bolton-le-Moors, Lancashire—Improvements in or applicable to self-acting mules for spinning.
2529. D. S. Brown, Asby-road, Islington—Propelling and sustaining balloons and aerial machines in the air.
2530. W. Mould and J. Hall, Bolton, and S. Cook and W. H. Hacking, Bury, Lancashire—Machinery for manufacturing heads or harness used in looms for weaving.
2531. C. W. Felt, Salem, United States—Machine for setting, spacing, justifying, and distributing printer's type.
2532. J. Stevens, Birmingham—Connectors and adjustors for connecting and adjusting crinolines.
2533. L. Christoph, Paris, W. Hawksworth, Linlithgow, and G. P. Hardiug, Paris—Cast steel and other metal tubes, and in the machinery or apparatus employed therein, parts of which improvements are applicable to the manufacture of gun barrels and ordnance, and to the rifling of same.
2534. B. Browne, 52, King William-street—A new improved spring.
2535. J. Downs, Kingston-upon-Hull—Pumps and stops used for working hydraulic presses.
2536. W. E. Newton, 66, Chancery-lane—Heating the feed water of steam engines.
2537. W. Payne and J. Burgum, Birmingham—Packing for engines and machinery.
2538. W. Clark, 53, Chancery-lane—Apparatus for bending iron rails or bars.
2539. A. English, Hatfield—Reins or apparatus for preventing harness horses falling.
Dated October 11, 1861.
2540. C. N. Kernot, West Cowes; and M. Rucker, 166, Fenchurch-street—Method of obtaining ammoniacal salts and other valuable products from liquors or substances containing ammonia, and for utilizing the residuum.
2541. R. Richardson, 26, Great George-street, Westminster—Manufacture of railway fastenings, and a mode of preparing rails and fish plates to receive them.
2542. T. B. Collingwood, and A. Butterworth, Rochdale—Throistle and doubling frames for spinning and doubling fibrous materials.
2543. W. E. Newton, 66, Chancery-lane—Condensers and condensing apparatus for steam engines.
2544. N. Stram, 12, Ashby-street, Northampton-square—Watches.
Dated October 12, 1861.
2545. J. Clark, Glasgow—Electric telegraph apparatus, and means for submerging and raising electric telegraph sea cables.
2546. E. Corke, Tumbridge Wells—Instrument to be attached to the bayonet or barrel of a rifle or other fire-arm for estimating distances.
2547. R. Edge, Bolton-le-Moors, Lancashire—Machinery for preparing, spinning, and doubling cotton and other fibrous materials.
2548. S. R. Carrington, Stockport—Hats and caps.
2549. J. C. Ramsden, Bradford, York—Heads or headles for weaving, and in the machinery or apparatus for making the same.
2550. V. Pirson and A. Deveyser, Brussels—The application of a new material the manufacture of paper cardboard and yarns.
2551. E. T. Hughes, 123, Chancery-lane—Compound to prevent the incrustation and sediments of calcareous matters in boilers.
2552. H. Nelson, Manchester—Machinery or apparatus for punching washers of throistles and other similar purposes.
2553. R. C. Furley, Edinburgh—Rendering pills tasteless.
2554. M. Cartwright, Carlisle—Stench traps.
2555. A. V. Newton, 66, Chancery-lane—Machinery for dressing or cleaning wheat and other grain.
2556. G. Twigg, Birmingham—Clasps or fastenings for stay buses.
Dated October 14, 1861.
2557. E. R. M. V. De la Jousselandiere, Nantes, France—Machine for weaving of cords and ropes.
2558. W. Macnab, Greenock—Marine steam engines and boilers.
2559. H. J. Distin, 9, Great Newport-street, Leicester-square—Metal musical wind instruments.
2560. J. Browning, Minorities—Barometers.
2561. B. Taylor, Birmingham, and C. Edkins, same place—Porterobes or dress suspenders, and also in apparatus for the suspension of curtains, draperies, and other articles.
2562. F. B. Houghton, 6, Clarendon-terrace, Kensington—Apparatus employed in reducing straw and other vegetable substances in the manufacture of pulp for making paper.
2563. M. Walker, St. Benet's-place, Gracechurch-street—Breech-loading rifles.
Dated October 15, 1861.
2564. J. Flinn, Coventry—Watches.
2565. C. Wynauts, Saint Josse-ten-Noode, Belgium—Chase for printing presses.
2566. W. Bland, Baildon, near Leeds—Pickers used in looms for weaving.
2567. W. Ross, Glasgow—Constructing taps and valves.
2568. J. Gilbert, Old Kent-road—Endless railways.
2569. W. E. Newton, 66, Chancery-lane—Condensers and condensing apparatus of steam engines.
2569. R. A. Brooman, 166, Fleet-street—Propelling ships and vessels.
Dated October 16, 1861.
2571. J. Dixon and R. Clayton, Bradford—Construction of railway wheels.
2572. R. A. Brooman, 166, Fleet-street—Plates.
2573. F. B. Baker, Nottingham—Dressing or stiffening lace and other fabrics.
2574. T. Forster, Streatham, Surrey—Reworking waste vulcanised india-rubber.
2575. J. J. Adams, New York—Manufacture of flexible back brushes for cleaning and dusting horses and other animals.
2576. A. V. Newton, 66, Chancery-lane—Construction of grain and grass harvesters.
2577. W. Biddell, Birmingham—Manufacture of shot.
2578. W. Clark, 53, Chancery-lane—Means or apparatus for closing and securing mail bags and other packages.
2579. J. Lister and D. Myers, Bradford—Lifting or hoisting apparatus, whereby to ensure the safety of the cage or article lifted when a rope or chain breaks or is unwound.
Dated October 17, 1861.
2580. W. Smith, Salisbury-street, Adelphi—Apparatus for and method of increasing the illuminating power of gas.
2581. R. Hayes, Manchester—Gun and ammunition cartridges.
2582. L. A. J. Deplanque, Paris—Machine to decorticate corn and seeds.
2583. W. T. Weston, 4, Trafalgar-square—Screw wrenches.
2584. W. Welch, Southsea, Portsmouth—Marine screw propellers.
2585. R. Smith, Chorlton-upon-Medlock, and J. B. Rowcliffe, Manchester—Apparatus for winding yarn or threads on pin-bobbins or spools used in smallware and ribbon looms.
2586. C. de Grootte, Brussels—Instrument for corking bottles and other vessels.
2587. J. Tattersall, Preston—Constructing of carding engines used in the preparation of cotton and other fibrous substances for spinning.
2588. T. Wild and T. Hodson, Heywood—Heating the feed water for boilers, and in employing steam produced by such means.
2589. T. E. Merritt, Rochester—Motive power.
2590. R. Aytoun, Edinburgh—Apparatus to be applied to chimneys or flues for improving the draught therein, and for preventing down draughts or the descent of smoke into apartments.
Dated October 18, 1861.
2591. W. Croome, Radstock, near Bath—Lamps.
2592. H. J. Distin, 9, Great Newport-street, Leicester-square—Metal musical wind instruments.
2593. J. Crosthwaite and T. E. Arman, Liverpool—Swivel target and signal apparatus to be used with the same.
2594. J. Goucher, Worksop, Nottinghamshire—Beaters and drums used in thrashing machines.
2595. E. Peyton, Birmingham—Frames of metal bedsteads.
2596. J. Lawson and H. Carter, Woolwich—Metal musical instruments.
2597. C. D. Abel, 20, Southampton-buildings—Apparatus for the simultaneous manufacture of white lead and vinegar.
2598. C. H. Holt, Huddersfield—Steam engines and boilers and apparatus connected therewith, part of which improvements is also applicable to raising and measuring fluids generally.
2599. W. Streater, Raunds, Northamptonshire—Construction of wind engines and the structure containing the same, parts of which are applicable in the construction of windmills.
2600. W. Sadler, 11, Tredegar-place, Bow-road—Armour-plated ships.
2601. P. Robertson, Cornhill—Manufacture of cartridges.
2602. B. Taylor, Birmingham—Certain descriptions of brace webs.
2603. T. W. Cowan, Greenwich—Breech-loading ordnance.
2604. J. H. Johnson, 47, Lincoln's-inn-fields—Braiding machines.
2605. H. Maemikan, Stratford, Essex—Smelting copper, gold, and other ores.
2606. C. Cheyne, 19, Great George-street, Westminster, and T. B. Moseley, Lewisham, Kent—Apparatus for signalling on railways.
Dated October 19, 1861.
2607. J. Webster, Birmingham—Oxygen gas and obtaining certain other products.
2608. W. G. C. Hudson, 25, Milk-street, Cheapside—Copying letters and other written papers or documents.
2609. R. Mueset, Coleford, Gloucestershire—Titanic pig metal or alloy of titanium and iron.
2610. T. Lepointeur, Paris—Fastenings for gloves, belts, and other articles.
2611. T. Fearnley, Manningham, Bradford, Yorkshire—Steam hammers.
2612. J. Cooper, Hightown, Leeds—Carding engines for the carding of cotton, silk, wool, and other fibrous substances.
2613. J. Marshall, St. James', Westminster—The collection, concentration, and transmission of sound, so as to facilitate the hearing thereof.
2614. J. Bourne, Oakamoor, Staffordshire, and E. Kidd, Birmingham—Tubes and cylinders, also applicable to other useful purposes.
2615. J. Wainwright, Connaught-place West—Ventilating rooms and buildings.
2616. C. De Bergue, Dowgate-hill—Sleepers chairs for the permanent way of railways.
2617. W. C. Cambridge, Bristol—Harrows.
2618. F. J. Evans, Horseferry-road—Carburetted gases for the purpose of illumination.
2619. H. Bloxam, Shrewsbury—Sights for rifles and ordnance.
Dated October 21, 1861.
2620. H. Lamplough, 113, Holborn-hill—Means for igniting the wicks of candles and lamp wicks.
2621. C. McDougall, Manchester—Connecting and fastening the bands of covered steel or other materials used for crinolines.
2622. J. Smith, Bradford—Combing cotton or other fibrous substances.
2623. J. T. Smith, Barrow-in-Furness, Lancashire—Collecting the inflammable gases evolved from blast furnaces.
2624. E. Oldfield, Salford, Lancashire—Self-acting mules for spinning and doubling.
2625. F. A. Calvert, Manchester—New engine to be propelled by compressed atmospheric air or steam.
2626. J. S. Phillips, 10, College Mount, Finchley-road—Propulsion of vessels through water.
2627. W. E. Gedge, 11, Wellington-street, Strand—Manufacture of flannel.
2628. F. Fenton, Fishguard, Pembrokeshire—Obtaining and treating fibrous substances.
2629. W. Winniatt, Bristol—Machines for kneading dough.
2630. N. D. P. Maillard, Dublin—Ploughs.
2631. J. Toward, Newcastle-upon-Tyne—Apparatus for bending iron.
2632. J. H. Johnson, 47, Lincoln's-inn-fields—Facilitating the passage of trains up steep gradients on railways.
2633. J. Toward, Newcastle-upon-Tyne—Armour plates for ships, and in securing the same to the sides of a vessel.
2634. W. Connell, Sewardstone Mills, Essex—Washing fabrics, yarns, wool, clothes, and other similar articles.
Dated October 22, 1861.
2635. H. Frost, Manchester—Apparatus for measuring fluids.
2636. G. England, New Cross, Surrey—Planing machines.
2637. R. Mueset, Coleford—Manufacture of a certain metallic alloy.
2638. F. O. Ward, 6, Hertford-street, Mayfair—Hydraulic presses and machinery, and apparatus appertaining thereto and requisite in working the same.
2639. H. May, Tewkesbury—Goloshes.
2640. H. B. Fox, Liverpool—Iron and other metallic bedsteads.
2641. R. A. Brooman, 166, Fleet-street—Reaping machines.
Dated October 23, 1861.
2642. G. Areher, Raunds—Sewing boots and shoes.
2643. G. H. Birkbeck, 33, Southampton-buildings—Separating or extracting silver from lead.
2644. A. Bevan, Gravesend—Construction of iron vessels and iron-plated ships of war.
2645. S. Young, Belfast—Spindles and flyers of machinery employed for spinning and twisting flax, hemp, jute, cotton, silk, wool, and other fibrous substances.
2646. C. Brison and A. Chavanne, Lyons—Ovens, kilns, or furnaces for manufacturing or other purposes.
2647. J. W. Wilson, Barnsley—Machinery for digging and cultivating the soil, and in steam engines for agricultural purposes.
2648. H. Keach, 16, Bedford-terrace, Holloway—Manufacture of segars.
2649. J. F. V. Deliry, Soissons—Mechanical kneading trough.
2650. A. Morel, Roubaux—Combing all filamentous materials.
2651. J. Kirkwood, Paisley—Looms for weaving.
2652. G. Davies, Lincoln's-inn—Railways and iron pavements and railways combined, parts of which improvements are applicable to the construction of railway chairs and to cast iron pavements for ordinary streets.
2653. N. Crammond, Newton—Self-acting railway-signals.
2654. J. H. Johnson, 47, Lincoln's-inn-fields—Preventing and removing deposit in steam boilers and other vessels, and in the apparatus employed therein.
2655. J. Marshall, Great George-street, Westminster—Traction engines and wheels, and carriages to be drawn by traction engines, which improvements in wheels are applicable to common road carriages generally.
2656. I. L. Pulvermacher, Oxford-street—Production of galvanic and magneto-electric currents, and machinery employed in making some of the apparatuses.
2657. W. B. Lord, Plymouth—Plug and socket or apparatus for closing and opening passages for the flow of liquids and fluids.
Dated October 24, 1861.
2658. G. Davies, Lincoln's-inn—Lamps for burning coal-oil and similar fluids.
2659. J. Baker, Birmingham—Ever-pointed pencil cases.
2660. A. F. Campbell, Great Plumstead—Railways.
2661. T. M. B. Wear and E. H. C. Moncton, 4, Trafalgar-square—Magnets, induction coils, and insulating wire and metal for electric and other purposes.
2662. J. C. Heaton and J. Dean, Rotherham—Taps or cocks.
2663. W. Dicks, Floor—Water meters.
2664. J. Chesterman, Sheffield—Heating steel and iron, and hardening and tempering steel, and apparatuses employed therein.
2665. J. McCall, Houndsditch, and B. G. Sloper, Waltham-stow—Preservation of articles of food.
2666. R. A. Boyd, Southwark—Apparatuses for singeing
p157.

AMERICAN SCREW PILE LIGHT-HOUSE

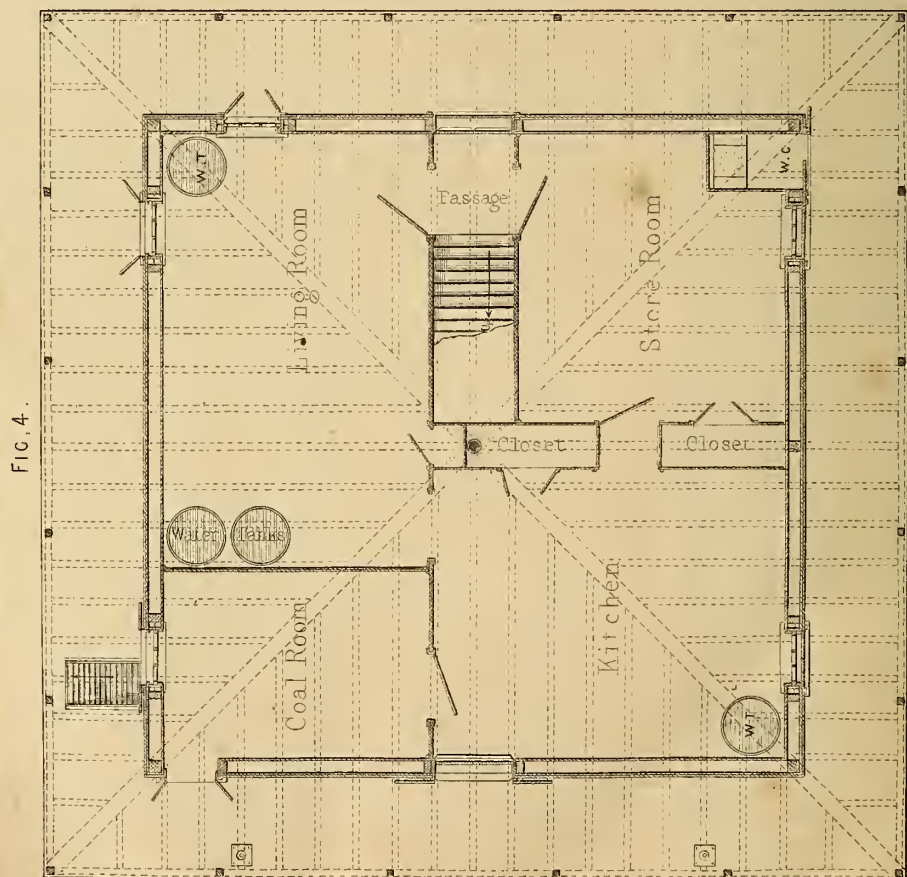
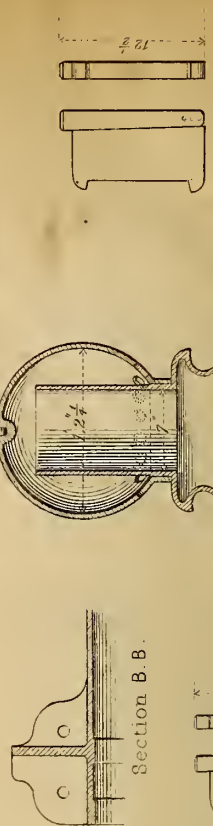
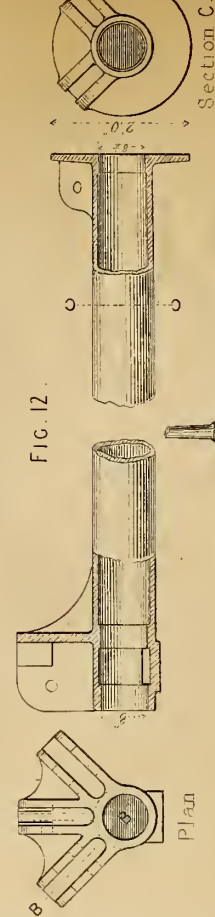
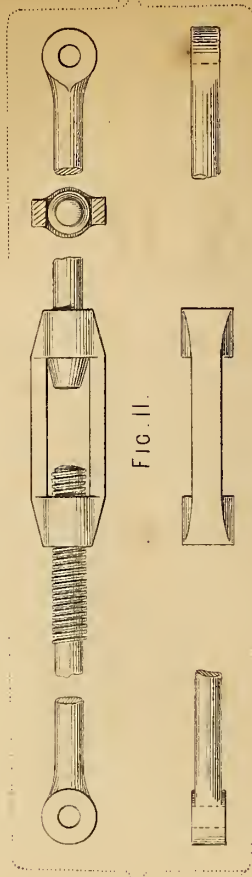
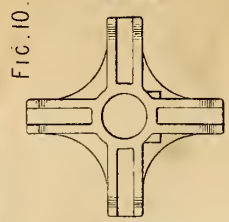
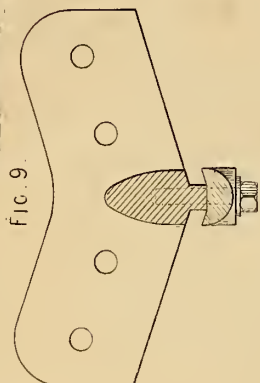
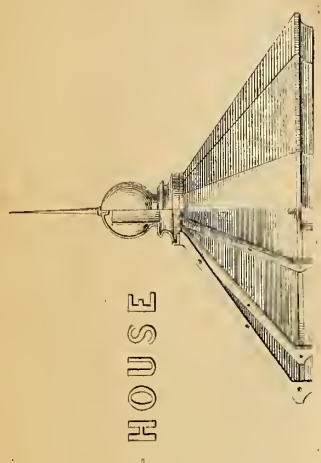
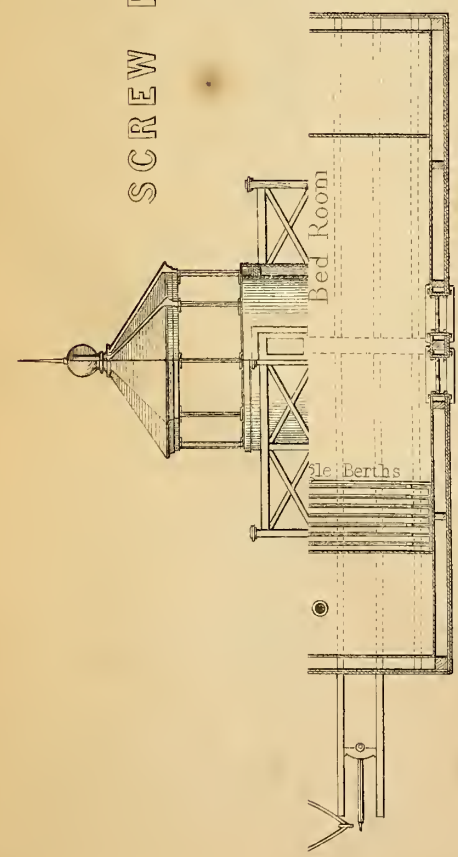

SCALE TO FIGS 1 2 3 4 7 8.

40 FEET

FIG. 15

THE ARTIZAN.

No. 228.—VOL. 19.—DECEMBER 1, 1861.

AMERICAN SCREW-PILE LIGHTHOUSE, PAMPLICO SOUND.

Illustrated by Plate 204.

In all great commercial countries the necessity for better lighting the shoals and dangerous parts of their coasts is so well understood, that great efforts have been made, more particularly in this country, within the last few years to very greatly extend the system of huoying-off such places, and by greatly increasing the number of light ships to render the navigation of our coasts less hazardous.

The use of the patent screw-pile offers such facilities for the construction of lighthouses on sand banks, shoals, and in such situations where a permanent structure would be too costly, or impossible,—that as a substitute therefor, and also as a substitute for floating lightships, the light framework erections for supporting lanterns lighted on suitable optical principles, having screw-pile foundations, have been found to be less costly, and less expensive for maintenance.

The Americans have, within the last few years, bestirred themselves with the better lighting of their coasts, and amongst the examples of such works with which we have been furnished is the one presented in the accompanying Plate (Plate No. 204).

The subject is one deserving of earnest attention, as being an admirable application of the screw-pile, and we take the earliest opportunity of complying with the wishes of several subscribers by giving a series of views and details of such a structure; and we are also enabled to give the Specification upon which the Tenders were invited, and the works afterwards executed; all of which will, we trust, prove highly interesting.

PARTICULARS OF DETAILS CONTAINED IN PLATE 204, "ARTIZAN" SERIES.

- Fig. 1. Half elevation.
- Fig. 2. Half sectional elevation.
- Fig. 3. Plan of second floor.
- Fig. 4. Details of first floor plan.
- Fig. 5. Half sectional elevation of lantern.
- Fig. 6. Half sectional plan of lantern.
- Fig. 7. Sectional plan of lantern deck.
- Fig. 8. Sectional plan at A A, Figs. 1 and 2.
- Fig. 9. Section of astragal.
- Fig. 10. Socket of centre pile.
- Fig. 11. Details of tension hraces.
- Fig. 12. Details of sleeve for corner pile.
- Fig. 13. Gib and key for securing radial and periphery struts.
- Fig. 14. Gib and key for securing sleeve to pile.
- Fig. 15. Section of lantern ventilator.
- Fig. 16. Apparatus for screwing piles.

The following is

THE SPECIFICATION :

The superstructure, which is principally of wood, will rest on and be secured to five wrought iron piles, screwed vertically in the shoal to the depth of 6ft., and arranged in the form of a square, one pile being in the centre and four at the angles. The dimensions, general arrangements, and details are shown in Plate 204.

METAL WORK.

The foundation piles and the side struts connecting the corner piles must be of the best quality of faggoted scrap iron. The lower ends of the piles must be made hexagonal and be neatly fitted to the foundation screws, to which they will be secured by wrought iron pins $\frac{3}{4}$ in. diameter, rivetted at the ends to prevent them from working loose. Slots $1\frac{1}{2}$ in. wide by $\frac{3}{4}$ in. deep to be planed in the upper part of piles.

All surfaces in contact with the sleeves and sockets, and the grooves for keys, must be turned.

Foundation screws to be of cast iron. The extreme radius of helix is 15in., and the pitch is uniformly $7\frac{1}{2}$ in. (The plan of helix is an Archimedean spiral.) It has two flanges, but one of them can be omitted, as the agent of the Lighthouse Board may direct.

The sockets and sleeves fitting on the piles must be of cast iron made in dry sand, of the form and dimensions shown in Fig. 12. All surfaces in contact with the piles to be hored.

The sleeves for corner piles, and the socket or centre pile to which the radial struts are connected, are arranged so as to turn freely on the piles. The grooves which are turned on the piles permit the sleeves and sockets to be secured by means of gibs and keys, whatever may be the relative position of the piles when inserted in the shoal. In all the pile-sockets and sleeves the holes for the tension-holts must be hored, and the recesses for the struts must be smoothly and truly cast.

The four struts radiating from the centre pile to be rolled iron, $4\frac{1}{2}$ in. in diameter. The inner ends to be secured to the centre socket with gibs and keys, and the opposite ends to the corner sleeves by means of heads.

The hraces and turnbuckles to be of wrought iron, of the form and dimensions shown in Fig. 11. The screws on the enlarged ends of hraces and in the turnbuckles must be neatly cut and fitted. The holes for the tension-bolts must be hored.

The gibs and keys for securing the struts, sleeves, and sockets must be of wrought iron, smooth forged. The keys, in all cases, to be provided with wrought iron split pins, made tapering, with a mean diameter of $\frac{5}{16}$ ths of an inch.

The tension-holts, and split pins belonging to them, to be of wrought iron. They must be "tool-finished."

The apparatus for screwing the piles in the shoal to be of the form and dimensions shown in Fig. 16. The socket fitting on pile to be of cast iron. Key seats must be cut to correspond with those planed in the piles, and two sets of wrought iron keys must be provided to fit between the socket and pile, when the former is at its highest and lowest position on the latter. The arms or levers to be of yellow pine or oak, and all remaining parts to be of wrought iron.

There are three cranes required, two of which will be used for boat davits. The journals must be neatly turned and fitted. The upper and lower hearings to be of cast iron, neatly fitted to the journals and well secured to the woodwork with wrought iron holts.

The ladders for the under side of dwelling to be of wrought iron. The lower end of the upper ladder, and the upper end of the lower ladder, will be secured to the side struts by means of the hinged straps, which embrace it. The steps of the upper ladder to be of plate iron, rivetted securely to the stringers. Their upper surfaces must be made rough with a chisel or punch. A railing must be attached to the upper ladder.

The form and dimensions of the lantern, and its details, are shown in Figs. 5, 6, 7, 9, and 15. The lower frame ring is composed of five cast iron segments, which must be neatly fitted together at the joints and secured with wrought iron holts. On the upper side the rehates for the glass and glass stops, as well as the surfaces of contact with the lower ends of astragals, must be planed. The astragals to be of cast iron. The ends must be faced, and the rehates for the glass must be planed. The glass stops and screws must be of bronze. The horizontal glass stops at the upper and lower sides of panels must be of wrought iron. The roof will be composed of ten cast iron segments, accurately fitted together and secured with wrought iron holts $\frac{3}{4}$ in. diameter. All surfaces of contact must be planed or faced. The joints must be made quite water-tight. The interior of the roof of lantern must be lined with sheet zinc, $\frac{1}{2}$ nd of an inch in thickness, secured to the flanges with wrought iron tap screws $\frac{3}{16}$ ths of an inch in diameter, and not more than 6in. apart. All the holts used for the lantern must be neatly fitted and "finished." The air registers will be made of copper and brass; the brass work to be finished bright.

The hinges for the windows of watch-room must be made of sheet brass. The pipe for water closet to be of cast iron. Countersunk holes to be drilled for wood screws where required.

The centre sockets and columns for sustaining the second floor and lantern deck to be of cast iron; they must be so cast as to fit snugly without

AMERICAN SCREW PILE LIGHT-HOUSE

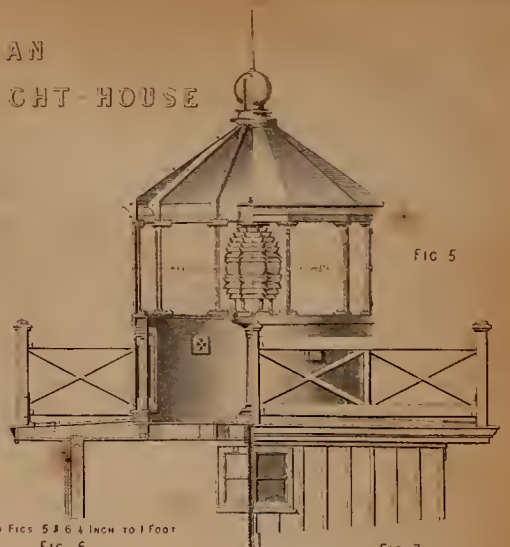

SCALE TO FIGS 5 & 6 1/4 INCH TO 1 FOOT

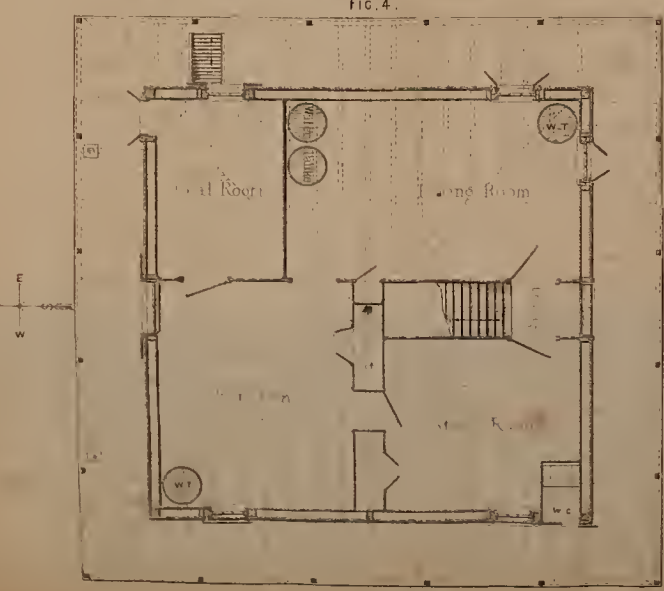
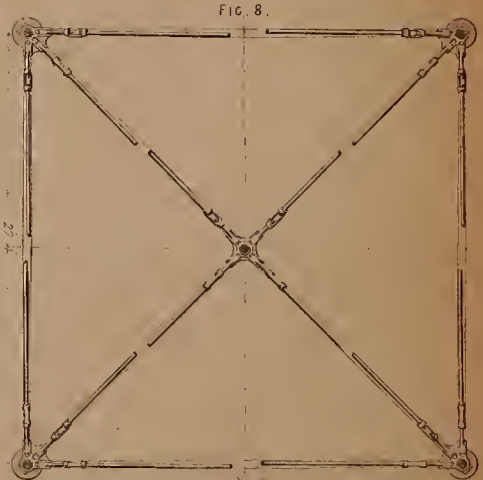
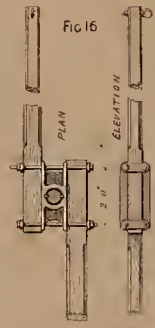
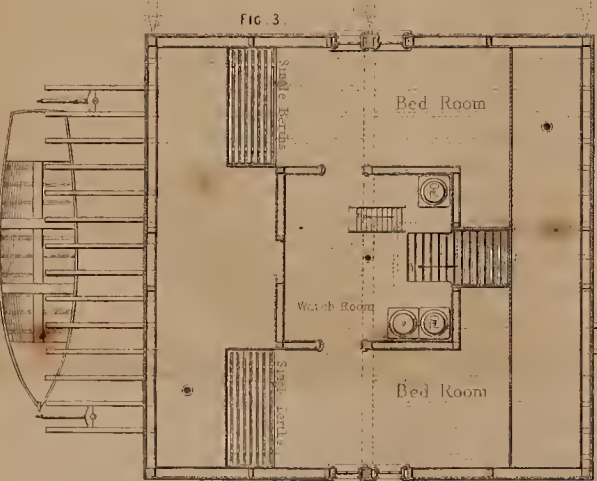
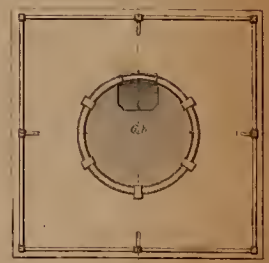

SCALE TO FIGS 1 2 3 4 7 8

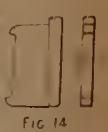
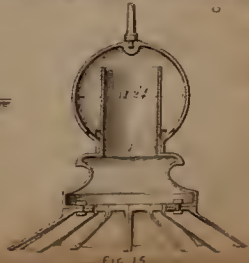
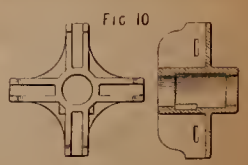
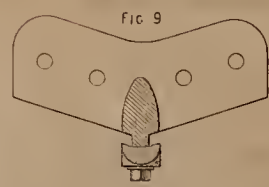

necessitating boring or turning. Holes for bolts must be drilled, where shown. The sockets for connecting the side frames of house with the second floor girder; the angle pieces for securing the frame of the house together at the corners, and the sockets for the wooden railings, to be of cast iron. The holes must be drilled for bolts or screws.

The upper corners of house frame for first story will be connected together with straps made of boiler plate. Countersunk holes to be drilled for wood screws.

There will be four wrought iron knees for securing the centre railing posts at lantern. Countersunk holes for wood screws must be drilled.

The water tanks to be made of good plate iron. A rim of half round iron to be rivetted around the upper end of each. One copper overflow pipe must be provided and fitted, but not permanently secured, to each tank. A brass cock of one inch bore to be secured to the lower part of each tank. All the tanks must be well rivetted and caulked, and made quite water-tight.

The cast iron stands for oil butts should be cast so that they may be connected together with tap bolts, without requiring to be planed.

There must be provided two flanged sheets of boiler plate, for stove hearths.

The smoke pipes to be of sheet copper $\frac{1}{16}$ th of an inch thick, being surmounted with Emerson ventilators. The moveable slide for opening or closing the communication with the outer air, to be neatly fitted.

The two gutters for the house, and the pipes for conducting the water to and from the tanks, to be made of sheet copper, weighing twenty-four ounces per square foot. Each gutter must be made in four pieces for convenience of shipment, and a lap of one inch to be allowed for each joint. Suitable flanges to be formed on one end of all the water pipes.

All the bolts and nuts used for the woodwork of house, to be of wrought iron. Suitable screws to be cut, and wrought iron washers to be furnished for all the bolts.

WOODWORK, ETC.

The arrangement of first floor or keeper's dwelling to be as shown in Fig. 4. The principal girders to be securely bolted to the cast iron sockets; the floor joists to be attached by means of tenons and mortises to the girders and girts, and well nailed together. All the timber for this frame to be of yellow pine. There must be laid on the first floor frame a double course of heart pine flooring boards, arranged so as to "break joints," to be 1in. thick, not more than 5in. wide, with close joints, tongued, grooved, dressed on the upper side, and well nailed to the joists.

The floor of gallery to be of yellow pine 2in. thick, not more than 6in. wide, dressed on the upper side, and well secured to the joists.

The entire frame for superstructure to be as shown in Figs. 3, 4, 7, and secured together in the best manner with the sockets, angle connections, bolts and straps, as furnished by the contractor for iron work. The main girder for second floor, the corner posts, and trusses for sides, all to be of yellow pine.

The second floor joists to be entirely covered with heart pine boards 1in. thick, not more than 5in. wide, tongued, grooved, dressed on the upper side, and well nailed to the joists.

The internal sheathing for walls and ceilings of first and second stories to be of white pine boards 1in. thick, not over 6in. wide, tongued, grooved, dressed, and well secured. The main partitions to be formed of a double course of boards, arranged so as to "break joints."

The external sheathing of sides of house must be formed of a double course of 1in. boards, arranged so as to "break joints," the outer course to be in uniform widths, the joists to be covered with battens $2\frac{1}{2}$ in. wide, and all exposed parts to be dressed. Between the inner and outer course there must be a layer of tarred paper.

The roof of main building to be covered with 1in. boards, well nailed to the rafters, and then covered with the best quality of cedar or cypress shingles.

The roof of watch-room to be sheathed with 1in. boards, and covered with sheet zinc $\frac{3}{32}$ nd of an inch thick, which must extend around the outside of lantern to the underside of lower frame ring.

The finish of the gable ends to be as shown in Fig. 1. The brackets must be well secured to the sides of house and roof with wrought iron bolts $\frac{3}{4}$ in. diameter.

The woodwork of lantern to be as shown in Fig. 5. The floor to be of heart pine boards, well secured to the joists, and covered with sheet zinc $\frac{3}{32}$ nd of an inch thick. The wall to be circular, as shown, formed of two horizontal ribs, which are built of segments, and sheathed internally and externally with 1-in. boards, not more than 3in. wide, tongued, grooved, dressed and well secured.

The stairs leading from first to second stories to rest on strong stringers; the steps and risers to be of yellow heart pine, the former $1\frac{1}{4}$ in. and the latter 1in. thick. The ladder leading to lantern to be yellow pine.

The floor joist of second storey project on the side of the house marked north on the drawings, and must be sheathed with 1in. boards, and covered

with the best XX roofing tin, to shelter the boat. The upper and lower bearings of boat davits and crane must be securely bolted to the woodwork.

The water closet must be neatly fitted up. The cast iron cylinder to be well secured with wood screws to the floor.

There must be an extra layer of boards secured to the floor of coal-room.

All the doors for dwelling must be of the best sash stuff. The joints to be well plied with white lead. All the doors must be hung in the best manner, with brass hinges of suitable sizes. All outside doors and shutters must have secure brass fastenings for retaining them closed or open. Mortice locks, with mineral knobs, must be provided for all inside doors, except those for the closet, which must be fitted with brass locks and white knobs of the usual kind and size. The batchway for stairs in the outside gallery must be covered with strong folding doors, secured with strap-hinges of galvanized wrought iron. One leaf must open towards the north, and the other towards the south.

The windows in the first story and in the gable ends, second storey, to be of the best sash stuff. They must be double bung with suitable weights, axle pulleys, and copper-wire cords. The shutters must have brass hinges and fastenings. The glass used for all the sash doors and the windows to be German, of extra thickness. It must be well bedded and back puttied.

The closets and store-room to be neatly shelved.

Neat wooden covers must be provided for all the tanks, and strong frames must be made to sustain them, which should raise the underside of tanks about 8in. from the floor.

The flanged iron plates furnished by the contractor for metal work for hearths must be covered with layers of brick, well bedded in sand or mortar.

There must be provided and fixed two cooking stoves, of good quality and sufficient size. The pipe of each must be neatly connected with the smokepipe.

There must be provided, fixed, and suitably insulated, a lightning-rod, formed of copper-wire rope $\frac{1}{2}$ in. diameter, furnished with a platinum point at the top worth four dollars. The rod must project 2ft. above the pinnacle of lantern, take the most direct course, and penetrate the water to such a depth as will always secure its immersion.

PAINTING.

All the exterior woodwork of house to receive two coats of white zinc paint and two of colour. The joists and underside of first floor to receive three coats of red lead. The exterior of ironwork of lantern to have three coats of red lead and one of black paint. The interior to receive three coats of white zinc paint. All the woodwork on the interior of house, except the doors and floors, to receive three coats of white zinc paint. In addition, the doors are to be grained in imitation of oak, and varnished.

All the materials throughout the structure to be of the best quality of their several kinds, the wood to be well seasoned, free from knots, sap, and windshakes. The structure to be completed in a faithful and workmanlike manner, whether herein particularly specified or not, and to the satisfaction of the agent of the Lighthouse Board.

PRACTICAL PAPERS FOR PRACTICAL MEN. No. VI.

COMPARISON OF GIRDERS.

(Continued from page 199.)

In treating of structures of many consecutive spans it may be convenient first to consider the differences in the construction of the piers for single and for consecutive spans. In the case of the straight girder and bowstring girder we find that the piers may be essentially the same, whether single spans or consecutive spans are used, as in both cases the force upon the piers will act in a vertical direction only, but when arches or chains are employed the case assumes quite a different aspect, for if we have a single arch or a single chain we must provide massive masonry to resist the thrust or pull, whereas if consecutive spans are employed we may cause the thrust or pull produced by one span to be counteracted by that which is brought upon the other side of the pier by the next span, the extreme spans will, however, require on the land sides abutments precisely similar to those provided when a single arch or chain is used, hence we conclude that the greater the number of consecutive arches or chains the greater will be the proportioned economy of the structure.

It is necessary here to notice the advantage possessed in regard to piers by the chain over the arch when used for consecutive spans. In the suspension bridge the chain will be supported at the top of each tower or pier by a sliding saddle plate whereby it will be enabled the more readily

to adjust its form to the load throughout the entire structure, whereas in the arch bridge, the arches being rigid will prevent any such adjustment taking place, hence there will be in the generality of cases an excess of thrust on one side of any pier which thrust will be withstood either by the solidity of the pier or by the rigidity of the arch carrying the next span of the structure.

From these remarks we are led to conclude that it is certainly undesirable to employ *very thin* piers in the construction of arch bridges of many spans, and that it is very necessary to provide a sufficient mass of masonry in each pier to withstand the greatest excess of thrust which can be brought upon it, otherwise it *must* yield, though *very slightly* whenever such excess acts upon it, and if this excess should act (as in all probability it will) alternately on each side of any given pier, the foundations will be gradually but certainly deteriorated, the time required for serious weakening of the fabric depending upon the quality of the materials and workmanship used in the foundations. The defect we have just mentioned cannot be too carefully guarded against, and it is very necessary that this should be borne in mind by those whose study it is to produce pleasing effects, and who may therefore be induced to use very thin piers in order to add beauty to the structure, which however, though it may last for many years will assuredly in the end yield in the foundations. We will not, however, treat further of this matter in the present paper as we purpose fully to discuss it in a future one.

In considering the relative economy of the different kinds of bridge structures when employed for consecutive spans, we shall regard all the spans as of equal length and also as fully loaded over the entire length of the structure. Our first consideration will be whether any advantage is gained by using continuous instead of discontinuous girders, when straight girders are employed to span the obstacle to be crossed.

Let us in the first place, dispose of the web. This, it is evident, will in no way be affected by the continuity, or otherwise, of the girder, as the strains to which it is subject consist merely in the transmission of the vertical force which is produced by the gravitation of the load and the weight of the structure from the open part of the span to the piers, the web being kept stretched by the flanges, or booms as some have proposed to call them on account of their being supposed to act in stretching the web of the girder in a manner analogous to the action of the boom which stretches the sail of a ship. Suppose the number of spans to be very great in order that the central spans may approach very nearly in the distribution of the strains to the condition of a straight girder fixed at both extremities, then, for practical purposes, we may regard the central spans as spans immovably fixed at both extremities, we will compare one of them with an equal single span. Theoretically, the amount of metal will be proportional to the area of the curves of strain, and the practical quantities will of course be proportional to the theoretical quantities; hence we may assume, for our present purpose, that the weight of the variable parts of the girder, the flanges will vary as the area of the curve of strains, for one kind of construction.

Let l = span of girder in feet.

s = direct strain on either flange at centre.

Σ = direct strain on either flange at piers.

the weight of the load will be nearly constant, the only difference consisting in the difference of weight between the continuous and discontinuous girders; we will therefore, at present, regard it as constant. Let us first ascertain the area of the curve of strains upon the discontinuous girder. The curve of strains is a parabola, hence the area of it will be equal to the span of the girder multiplied by two-thirds of the maximum strain at the centre of the girder, the formula being, if A represents a quantity varying in proportion to the area of the curve,

$$A = l \times \text{strain at centre,}$$

but the strain at centre varies as

$$\frac{l^2}{d}.$$

Where d = the depth of the girder, let d be constant in the present case, then will

$$A = l^3,$$

or the weight of metal in the flanges of any single girder will vary as the cube of the span, the depth being constant, and otherwise it would also vary inversely as the depth of the girder.

We will now find the area of the curve of strains upon the girder fixed at both extremities. The curve for the central part of the span will be calculated according to the above method, and for the end parts we shall arrive at results sufficiently accurate by regarding the space made up by

the strains as a right-angled triangle. We must, in the first place, find the distance of the points of contrary flexure from the piers in order to determine the virtual span of the central part of the girder, a reference to our Paper No. 2, on "Continuous Girders," shows us that in a girder fixed firmly at both extremities, the distance of any point of contrary flexure from the nearest pier is very nearly

$$= 0.215 l;$$

hence the span of the central portion of the girder will be

$$= l - 2 \times 0.215 l = 0.57 l$$

nearly; and the area of the curve of strain on the central part of the girder will vary nearly as,

$$0.185 l^3.$$

The strain over each point of support will be twice the maximum strain at the central part of the girder, and the area of the triangles of strains on the ends of the girder, will be equal to the strain over one pier multiplied by

$$0.215 l,$$

because the area of a triangle is equal to its height multiplied by half its base, and there are two triangles. The maximum strain at the centre varies as

$$0.325 l^2;$$

hence the strain over either point of support varies as

$$0.65 l^2,$$

and the area of the two triangles will vary nearly as

$$0.65 l^2 \times 0.215 l \\ = 0.14 l^3$$

nearly, hence the total area of the curve will vary nearly as A , when

$$A = 0.185 l^3 + 0.14 l^3 \\ = 0.325 l^3.$$

Let us now ascertain the ratio of economy of the continuous and discontinuous systems.

Let C = a factor corresponding to the ratio of economy, then will

$$C l^3 = 0.325 l^3 \\ \therefore C = 0.325;$$

hence, if the depth of the girder is constant, nearly two-thirds of the weight is saved by making it continuous; but this is theory, and we shall find, in practice, that this is reduced to about one-third, or perhaps less, say 30 per cent. of the weight of the flanges.

Let us illustrate the above calculation by an example.

Suppose we have a bridge 100ft. in span to carry a single line of railway, then if two girders be used, the weight of the flanges of one girder will be for a discontinuous system of construction, about

$$8.00 \text{ tons};$$

and from the foregoing factor we should have for continuous system a weight of

$$8 \times 0.325 = 2.5 \text{ tons};$$

the saving on the two girders will, therefore, be theoretically

$$16 - 5 = 11 \text{ tons,}$$

and the total weight of the bridge being taken at 40 tons for the iron in the superstructure, the saving stated as per centage on the entire structure for one span will be

$$\frac{100 \times 11}{40} = 27.5 \text{ per cent.};$$

but we shall obtain a more useful result by applying the approximate practical formula, the saving on the two flanges of the two girders will then become.

$$\frac{16 \times 30}{100} = 4.8 \text{ tons,}$$

and the per centage saving upon the entire structure will be

$$\frac{100 \times 4.8}{40} = 12 \text{ per cent.}$$

The difference between the practical and theoretical saving is due to the fact that the load being liable to be disposed in various manners, allowance must be made accordingly.

We will now compare the single girders with one span of a two-span continuous girder. In the latter one point of contrary flexure will exist and its distance from one point of support will be

$$= 0.25 l;$$

hence the length of that portion of the girder, which may be treated as an ordinary single girder, will be

$$= 0.75 l.$$

The area of the curve of strain upon this part of the girder will, therefore, vary as

$$0.422 l^3$$

very nearly; the strain on either flange over the fixed end of the girder will bear to that on the central part the ratio

$$\frac{14.222}{8} = 1.777;$$

hence the strain over the fixed extremity will vary nearly as

$$3.133 l^2;$$

hence, for our value of A, we have

$$A = 3.133 l^2 \times 0.125 l \\ = 0.392 l^3.$$

nearly. Hence, in this case, the economy of metal is not nearly great as in the last case.

We will now pass on to the consideration of arches as compared with continuous girders.

We have already obtained for the ratio of variation of weight in one span of the continuous girder of many spans the formula,

$$0.325 l^3.$$

we will now proceed to find a similar formula for the arch.

The strain on the crown of the arch will be the same as that upon the centre of a flange of a straight girder, and will, therefore, vary, the depth being constant as,

$$l^2,$$

the strain at either haunch will vary as

$$\sqrt{\left\{\frac{l}{2}\right\}^2 + \frac{l^4}{64 d^2}}$$

The two structures may be most conveniently compared by working out a special case. Let the span be 100ft. and the depth 8.33ft., or $\frac{1}{12}$ of the span.

The sum of all the strains will be the mean strain multiplied by the span of the girder.

The strain at the crown will be as

$$\frac{l^2}{8 d} = 1.5 l = 150 \text{ tons.}$$

The strain at the haunches will be as

$$\sqrt{\left(\frac{100}{2}\right)^2 + (150)^2} = 158 \text{ tons.}$$

The strains at three intermediate points will be as

$$\sqrt{\left(\frac{100}{8}\right)^2 + (150)^2} = 150 \text{ tons.}$$

$$\sqrt{\left(\frac{100}{4}\right)^2 + (150)^2} = 152.7 \text{ tons.}$$

$$\sqrt{\left(\frac{300}{8}\right)^2 + (150)^2} = 154.6 \text{ tons.}$$

these quantities approximating sufficiently nearly to the truth for all practical purposes. We will take the mean of the above quantities as the mean strain, it will be

$$\frac{1}{5} \{ 150 + 150 + 152.7 + 154.6 + 158 \} = 153.06 \text{ tons.}$$

say 153 tons. The area of the curve of strain will be

$$153 \times 100 = 15,300.$$

this will represent the weight of the arched rib; we must now find the comparative weight of a plate girder on the continuous system. Taking out the weight of the flanges for a single girder, and reducing by the practical formula, we find

$$\frac{20,000 \times 30}{100} = 6000.$$

this is obtained in the first case thus,

$$l \times 2 \times \frac{l^2}{8 d} \times \frac{2}{3} = 3 l^2 = 20,000.$$

The weight of the web will be about

$$10,000,$$

half that of the flanges and the total weight

$$16,000,$$

a little more than that of the arch system.

The chain will bear the same relation to the arch in consecutive as in single spans.

In concluding this paper, it may be desirable to remark again that the quantities in every case referring to consecutive spans are merely relative, requiring to be multiplied by a constant to reduce them to absolute quantities. Such constant may be found by taking the mean weight of a number of well-designed bridges on one system, and dividing it by the relative number referring to that system.

THE LOSS BY FRICTION OF LOAD IN THE PRINCIPAL PARTS OF THE STEAM ENGINE.

BY OMICRON.

(Continued from page 247.)

It appears to me after a careful perusal of Moseley's investigation that there is some confusion in referring the pressure to the imaginary crank arm. After correctly discussing those quadrants in which the arms are on the same side of the centre, the discussion of the other two quadrants is entered upon with this remark:—"The conditions of the equilibrium of the state bordering upon motion remain the same as before; that is, the same as though the pressure P_1 were applied to an imaginary arm whose length is $\frac{a}{\sqrt{2}}$ and whose position is C F." Now there is no C F in the

figure for the quadrants under consideration, but, in the only figure where C F appears it bisects the angle made by the two cranks. The rest of the discussion agrees with the supposition that C F still bisects this angle. But this is not the case, or the double engine would have dead points the same as the single engine. If the pressures are to be referred to this imaginary arm it must be understood that it takes a jump of 90° at the end of each quadrant, backward and forward alternately. It describes the arc from $\frac{\pi}{4}$ to $\frac{3\pi}{4}$ twice on the one side of the shaft and then twice on the other side, and this completes one revolution of the real cranks. From this point it appears to me that Moseley's investigation of the question passes into error. It proceeds with the integration of the previous equation between the limits 0 and $\frac{\pi}{4}$, and between $\frac{3\pi}{4}$ and π . These integrations should have been between the same limits as before, namely, from $\frac{\pi}{4}$ to $\frac{3\pi}{4}$. A little further on we find "If U_1 represent the whole work done by the driving pressures at each revolution of the imaginary arm then $4 \frac{a}{\sqrt{2}} P_1 = U_1$." But it is evident that if P_1 be the sum of the pressures on the two pistons, then U_1 must be equal to $4 a P_1$ or $2 L P_1$. The error here is that the imaginary arm is supposed to make a revolution, whereas it only vibrates in two arcs

In the discussion of the loss by friction on the crank guide or slide bar, Moseley arrives at the following equation:—

$$U_1 = U_2 + P_2 \frac{a^2}{b} \tan. \phi \int_0^\pi \sin. 2\theta_1 d\theta_1 = U_2 + P_2 \frac{a^2 \pi}{b^2} \tan. \phi.$$

Where U_1 is the power applied, and U_2 the useful work done during a single stroke of the piston, P_2 is the pressure on the connecting rod, supposed to be constant throughout the stroke, and ϕ is the limiting angle of resistance. I have used the co-efficient of friction in this paper considering it to be a more simple expression. $\tan. \phi$ is identical with the co-efficient of friction.

There seems to be an erratum in the third member of the above equation. The integration of the second member gives

$$U_2 + P_2 \frac{a^2 \pi}{2b} \tan. \phi,$$

and this is identical with the formula I have already given for the crank guide. But this is not the final formula, it follows the above, and is

$$U_1 = U_2 \left\{ 1 + \frac{\pi \tan. \phi}{2 - \left(\frac{b^2}{a^2} - 1 \right) \log. \epsilon \left(\frac{b-a}{b+a} \right)} \right\}$$

or in other language the loss by friction expressed in decimal parts of the useful work is

$$\frac{\pi \tan. \phi}{2 - \left(\frac{b^2}{a^2} - 1 \right) \log. \epsilon \left(\frac{b-a}{b+a} \right)} = \frac{\pi f}{2 - (n^2 - 1) \log. \epsilon \left(\frac{n-1}{n+1} \right)}$$

But this result depends upon the truth of a previous equation which can be more easily tested.

$$U_2 = P_2 \frac{a^2}{b} \left\{ 1 - \frac{1}{2} \left(\frac{b^2}{a^2} - 1 \right) \log. \epsilon \left(\frac{b-a}{b+a} \right) \right\}$$

I have added the index to b in $\left(\frac{b^2}{a^2} - 1 \right)$, it reads $\left(\frac{b}{a^2} - 1 \right)$ in the book, but I suppose this is an erratum. Try a numerical example of this equation, let $b = 4$ and $a = 1$.

$$U_2 = P_2 \times \frac{1}{4} \left\{ 1 - \frac{1}{2} (15) \log. \epsilon \cdot 6 \right\}.$$

$$\log. \epsilon \cdot 6 = -\cdot 51, \therefore U_2 = 1\cdot 206 P_2$$

U_2 is the useful work in a single stroke, which is thus said to be equal to the pressure on the connecting rod through a space equal to 1.206 times the length of the crank. It must be borne in mind that this result has not been reduced on account of friction, for P_2 is supposed to be constant on the connecting rod, having been already reduced by the friction of the slide bar. Now, if P_1 be the pressure on the crosshead in the direction of the motion of the piston after being reduced by the friction of the slide bar; the value of U_2 cannot be less than the product of $2a$ by the least value of P_1 . If the pressure in the direction of the oblique connecting rod be a constant quantity = P_2 , the least value of P_1 will occur when the crank is at right angles with the direction of the motion of the piston. If $a = 1$ and $b = 4$, $P_1 = P_2 \times \sqrt{1 - \frac{1}{16}} = \cdot 97 P_2$. U_2 must, therefore, be at least greater than $2a \times \cdot 97 P_2 = 1\cdot 94 P_2$. But Moseley's equation makes it 1.206 P_2 , I therefore consider the final formula to be also incorrect.

The pressures being not constant, and that on the connecting rod not equal to that on the piston, this may, to some, appear to be but a rough way of approximating to the total loss by friction. However, the loss by friction is itself generally but a small part of the whole power, and these minute differences bear a still smaller proportion to the total loss, so that in practice their consideration is valueless. To satisfy the young engineer, I will go over these differences, but with this preface, that the result is too minute to be of any value to the practical man.

Fig. 1. (Nov. No.)—If at any position of the connecting rod a triangle $r_3 r_2 g$ be described; then if b represent the pressure transmitted by the connecting rod to the crank pin in direction and in amount, that pressure is resolved into the two components $r_3 g$ and $r_2 g$; $r_3 g$ is the direct pressure on the piston (neglecting friction) and $r_2 g$ represents the perpendicular pressure on the slide bar.

If the arc $c e m$ be described with radius = length of the connecting rod, b being the centre; $e g$ is equal to the difference between $r_3 r_2$ and $r_3 g$. If we accept as a near enough approximation that $e g$ is the same part of $g l$ that it is of $r_3 g$ then will the variable $e g$ represent the amount of the additional pressure due to the obliquity of the connecting rod at the various periods of the revolution.

On the crank pin we have throughout the entire revolution a constant

pressure P added to the varying pressure represented by $e g$. If the successive values of $e g$ be each multiplied by the portion of the circumference of the crank pin belonging to that pressure, the sum of these products multiplied by f will be the additional loss by friction due to the obliquity of the connecting rod. This would be a tedious calculation, but we can arrive at the same result by an easier process—

$$\overline{e g} = \frac{o g^2}{2b - e g},$$

or neglecting $\overline{e g}$ in the denominator

$$\overline{e g} = \frac{o g^2}{2b}.$$

The arc $c e m$ can be altered to a curve, whose ordinates will represent the products of $\overline{e g}$ by the ratio between the circular and rectilinear velocity of the crank pin by multiplying by a and dividing by $o g$. These ordinates would therefore be equal to

$$\frac{o g^2}{2b} \times \frac{a}{o g} = \frac{a \cdot o g}{2b}.$$

As $\overline{o g}$ is the ordinate of the semicircle it is evident that its mean length will be

$$\cdot 7854 a = \frac{\cdot 7854 P}{n}.$$

The mean length of the ordinates of supposed curve will be $\frac{a}{2b}$ times this, or

$$\frac{\cdot 7854 P}{2 n^2}.$$

The base line of the curve is the diameter of bearing under consideration. Let this be the crank shaft journal; its diameter is $2 r_1$.

$$\frac{\cdot 7854 P}{2 n^2} \times 2 r_1 = \frac{\cdot 7854 P r_1}{n^2}$$

This is the area of the curve of additional pressure for a single stroke or half a revolution. For an entire revolution the loss by friction of this additional pressure will be

$$\frac{1\cdot 57 f P r_1}{n^2}.$$

The total loss by friction on an entire revolution of the crank shaft journal

$$= 2 f \pi P r_1 \left(1 + \frac{1}{4 n^2} \right).$$

On the crank pin it will be

$$= 2 f \pi P r_2 \left(1 + \frac{1}{4 n^2} \right).$$

It is not worth while entering on a separate calculation of the loss by additional friction on the crosshead, I will set it down the same as the others. The total loss on crosshead bearing

$$= \frac{4 f P r_3}{n} \left(1 + \frac{1}{4 n^2} \right).$$

ADDITIONAL PRESSURE ON SLIDE BAR. It has been shown before that if the pressure on the connecting rod be a constant quantity, and represented in amount by the length of the connecting rod, the pressure on the slide bar will be measured by the length of the variable $\overline{o g}$. The additional pressure will be the same part of $\overline{o g}$ that $e g$ is of b ,

$$\frac{e g}{b} = \frac{o g^2}{2 b^2} \therefore o g \times \frac{e g}{b} = \frac{o g^3}{2 b^2}.$$

As in the figure the pressure P is represented by b ; if we take the radius of this semicircle as unity in the calculation of $\frac{o g^3}{2 b^2}$ we must

divide by b to get the pressure value = $\frac{o g^3}{2 b^3} \times P$.

If the area of the curve be calculated whose base is $c m$ and whose ordinates are the cubes of the ordinates of the semicircle it will be found to be about $\cdot 57$ of the parallelogram, whose height is radius. Therefore $\frac{\cdot 57 P L f}{2 n^3}$ is the additional loss by friction for a single stroke or $\frac{\cdot 57 P L f}{n^3}$ for an entire revolution.

Dividing each of these formulæ by $2 P L$, we have an expression for the loss in decimal parts of the original power.

Position of the Friction.	Loss in decimal parts of original power.	
	Neglecting Obliquity.	Including Obliquity.
Crank Shaft.....	$\frac{f \pi r_1}{L}$	$\frac{f \pi r_1}{L} \left(1 + \frac{1}{4 n^2}\right)$
Crank Pin	$\frac{f \pi r_2}{L}$	$\frac{f \pi r_2}{L} \left(1 + \frac{1}{4 n^2}\right)$
Crosshead.....	$\frac{2 f r_3}{n L}$	$\frac{2 f r_3}{n L} \left(1 + \frac{1}{4 n^2}\right)$
Slide Bar	$\frac{f \pi}{4 n}$	$\frac{f}{2 n} \left(1.57 + \frac{.57}{n^2}\right)$
Shafting	$\frac{f \pi r_4}{q L}$	$\frac{f \pi r_4}{q L}$
Total neglecting obliquity } $= \frac{f \pi}{L} (r_1 + r_2 + \frac{r_4}{q}) + \frac{2 f r_3}{n L} + \frac{f \pi}{4 n}$		
Total including obliquity } $= \left(1 + \frac{1}{4 n^2}\right) \left\{ \frac{f \pi}{L} (r_1 + r_2) + \frac{2 f r_3}{n L} \right\} + \frac{f}{2 n} \left(1.57 + \frac{.57}{n^2}\right) + \frac{f \pi r_4}{q L}$		

I will now illustrate these formulæ by a numerical example. The new steamer, *City of New York*, has a pair of engines, cylinders 85 inches diameter, length of stroke 42 inches, connecting rod 7 feet long, diameter of crank pin 18 inches. I do not know the other dimensions, but will take the crank shaft journals at 16 inches, the screw shaft journals at 15 inches, and the crosshead at 12 inches, and I will suppose the weight of the screw shaft and screw to be $\frac{1}{3}$ of the pressure on the piston. We have the following values for the letters used in the formulæ:— $L = 42$, $n = 4$, $r_1 = 8$, $r_2 = 9$, $r_3 = 6$, $r_4 = 7\frac{1}{2}$, $q = 3$. There being two engines, we must substitute $2 q$ for q in the formulæ. I will take $f = .083$.

NEGLECTING THE ADDITIONAL PRESSURE DUE TO THE OBLIQUITY OF THE ROD.

$r_1 = 8$ $r_2 = 9$ $\frac{r_4}{2q} = 1.25$ <hr/> 18.25 $\pi = 3.1416$ $L = 42) 57.3342$ <hr/> 1.3651 <hr/> $.0714$ <hr/> $.1963$ <hr/> 1.6328 <hr/> $f = .083$ Loss = $.1361$ of the original power.	$L = 42 \mid 6 = r_3$ $n = 4 \mid 2$ <hr/> $168) 12$ <hr/> $.0714$ <hr/> $4n = 16) 3.1416$ <hr/> $.1963$ <hr/> 1 <hr/> $.1361$ <hr/> $.8639) .1361$ <hr/> $.1575$ Or 15.75 per cent. of the useful work.
---	--

INCLUDING THE ADDITIONAL PRESSURE DUE TO THE OBLIQUITY OF THE ROD.

$4n^2 = 64) 1$ $.0156 \mid r_1 = 8$ $1 \mid r_2 = 9$ <hr/> $1.0156 \mid 17$ <hr/> $42) 53.4072$ <hr/> 1.2716 <hr/> $1.2716 +$ $.0714 =$ $1.3430 \times$ $1.0156 =$ <hr/> 1.3645	$L = 42 \mid 6 = r_3$ $n = 4 \mid 2$ <hr/> $168) 12$ <hr/> $.0714$ <hr/> $n^2 = 16) .57$ <hr/> $.03$ <hr/> 1.57 <hr/> $2n = 8) 1.60$ <hr/> $.2$
---	---

$$L = 42 \mid 3.1416$$

$$2q = 6 \mid 7.5 = r_4$$

$$252) 23.562$$

$$.0935$$

$$1.3645$$

$$.2$$

$$.0935$$

$$1.6580 \times$$

$$.083 = f$$

Loss = .1382 of the original power.

Or $.1382 \div (1 - .1382) = .1604$; or 16.04 per cent. of the useful work.

From this calculation it appears that the additional loss due to obliquity is only 0.29 per cent. of the useful work. This calculation has been given here, not because it is important to estimate this additional pressure, but to show that it may safely be neglected in the calculation of loss by friction.

If the bearings become heated and the hose pipe be applied, so that the surfaces are wetted, the co-efficient may become 0.2, and the loss by friction would then be 34 per cent. of the whole power, or 51 per cent. of the transmitted power. But this is supposing all the surfaces to be heating at the same time, which is to be hoped will never happen.

If we assign values to r_1, r_2, r_3 , and n in parts of the diameter of the cylinder, we can change the above formula into a very simple expression. Referring to marine engines of usual construction, we may assume $r_1 = 0.1 D$, $r_2 = 0.11 D$, supposing a solid crank shaft, $r_3 = 0.07 D$, $n = 4$, $f = \frac{1}{2}$. Substituting these in the formula which includes obliquity, and neglecting the friction on the line of shafting, we have

$$\text{Loss of original power,} = \frac{D}{16 L} + \frac{1}{60}$$

That is, the loss arising from the friction of the slide bar is a constant quantity, $\frac{1}{60}$ of the original power, or $1\frac{2}{3}$ per cent; and the loss on the journals is $\frac{1}{16}$ of the ratio between the diameter of the cylinder and the length of the stroke.

GEARING: FRICTION OF THE TEETH.

The contact of the teeth at the line of centres produces no friction, for at that instant the motion of the points of contact in the wheel and in the pinion coincide. For an instant the surface of the driving tooth is rolling on that of the driven tooth; but this action is only for contact at the line of centres, and at every other point of contact there is, to some extent, a rubbing of the surfaces. The amount of that friction at any point of contact will be proportional to the distance of the point from the point of contact of the pitch circles at the line of centres. If we suppose contact to continue throughout a portion of the revolution represented by the pitch of the teeth, then will the friction at half the pitch from the centre line be the average friction.

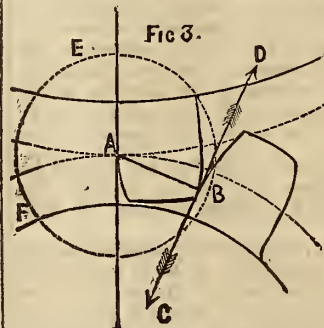

In Fig 3, B is the point of contact at mean friction, and AB may be taken as equal to half the pitch. Let B₁ be the point of contact on the driving, and B₂ the point of contact in the driven tooth; these points are in the figure at the point B. If we conceive the wheels to be rolling on each other at their pitch circles, the condition of friction would be the same as in their ordinary work. As drawn in the figure, the point A would be the instantaneous axis on which the wheels are turning, and the point B₁ is, therefore, moving towards D with a velocity such that

it would describe the circle BEF in one revolution of the driving wheel. But B₂ is also moving in the direction BC at such a velocity that it would describe the circle BFE in one revolution of the driven wheel. If n_1, n_2 be the number of teeth in the driving and in the driven wheels, respectively, then is the velocity of B₁ equal to $\frac{\pi}{n_1}$ of the velocity of the pitch

circumference of the driver, and B₂ is $\frac{\pi}{n_2}$ of the velocity of the pitch circumference of the driven wheel. As both circumferences have the same velocity, it follows that the friction between B₂ and B₁ must be

$$\pi \left(\frac{1}{n_1} + \frac{1}{n_2} \right)$$

of that velocity, and, therefore, this friction multiplied by the co-efficient of friction of the surfaces will represent the proportion of the power

which is lost by the friction of the teeth. The co-efficient of friction of hard wood upon cast iron, as in the teeth of wheels, is about 1.9 times the co-efficient for the surfaces of the journals of the engine; $1.9 \times \pi = 6$ therefore the loss on the teeth of a cog-wheel and pinion will be

$$6f \left(\frac{1}{n_1} + \frac{1}{n_2} \right)$$

(To be continued.)

STRENGTH OF MATERIALS.

DEDUCED FROM THE LATEST EXPERIMENTS OF BARLOW, BUCHANAN FAIRBAIRN, HODGKINSON, STEPHENSON, MAJOR WADE, U.S. ORDNANCE CORPS, AND OTHERS.

BY CHARLES H. HASWELL, C.E..

(Continued from page 206.)

RESULTS OF EXPERIMENTS UPON THE TRANSVERSE STRENGTH OF WROUGHT IRON ELLIPTICAL TUBES (ENGLISH IRON, FAIRBAIRN).

Distance between the supports 30 feet; weight suspended in the middle.

Depth of tube.	Breadth of tube.	Thickness of metal in inches.			Breaking weight.
		Top.	Bottom.	Side.	
Ft.	Ft. In.				Lbs.
2	1 4	3-8	$\frac{1}{4}$	1-8	62,720
3	2 0	9-16	$\frac{3}{8}$	3-16	231,465

The ultimate deflexion was for the first, $2\frac{3}{4}$ in.

The above and many of the preceding results are deduced from girders of the length of from 20 to 30 feet; hence, when the length is less, the breaking weight may be increased, in consequence of the increased stability of the girder.

These results are very conclusive of the correctness of the formula used, viz.,

$$\frac{A d V}{l}$$

as will be seen in the cases here given, in the 11th and 19th cases, where the relations between breadth, depth, and thickness are nearly identical, and in the 12th and 16th cases, where the relations between breadth are the same, but the thickness and consequent area differ.

To ascertain the transverse strength or the loads that can be borne by wrought iron girders, beams, or tubes of various figures, and sections when supported at both ends, the load applied in the middle.

RULE.—Divide the product of the area of the section, the depth, and the Value for the construction from the preceding table, by the length in feet, and the quotient is the destructive weight in pounds.

NOTE 1.—The rule given at page 187 for cast iron girders, &c., will also apply here, when the metal is of such thickness as to give the girder, &c., full resistance to lateral flexure, and when the construction is such as to bring the stress upon the tension and compression of the metals, and not upon the rivets.

2. In determining the Value, the proportions of the construction in its flanges, width, and depth, &c., must be observed, as well as the character of it.

3. The Values here given are based upon experiments with English iron.

EXAMPLE 1.—What is the load that will destroy a wrought iron solid grooved beam of the following dimensions:—

Top flanges 3×1.25 inches. | Width of web $\frac{1}{4}$ inches.
Bottom flange $4 \times .5$ „ | Depth of beam 9 „

$$3 \times 1.25 + 4 \times .5 = 3.75 + 2 = 5.75 \text{ inches, which} + 9 = 1.25 + .5 \times 4 = 2.90 = 8.65 \text{ inches} = \text{area of section.}$$

Then,

$$\frac{8.65 \times 9 \times 3000}{10} = 23,359 \text{ lbs.}$$

EXAMPLE 2.—What is the load that will destroy a wrought iron plate beam of the following dimensions, and 10ft. in length between the supports?

Top flange two of $3.5 \times .5 \times .5$ inches.
Bottom flange two of $3.5 \times .5 \times .5$ „
Width of web $.5$ „
Depth of beam 17 „

$$3.5 \times .5 \times 2 + (3.5 - .5 \times .5 \times 2) \times 2 = 13 \text{ inches, which} + 17 \times .5 = 21.5 \text{ inches} = \text{area of section.}$$

Then,

$$\frac{21.5 \times 17 \times 2400}{18} = 87,720 \text{ lbs.}$$

EXAMPLE 3.—What is the load that will destroy a wrought iron rectangular tube of the following dimensions, and 10ft. in length between the support?

Depth 25.00 inches. | Thickness of metal..... .30 in.
Breadth 16.00 „ | Area of section of metal 29.64 „

Then,

$$\frac{29.64 \times 25 \times 3500}{10} = 259,350 \text{ lbs.}$$

FORMULE FOR BEAMS AND TUBES OF WROUGHT IRON (FAIRBAIRN),*

Solid beams $\frac{2800 A d}{l} = W.$

Plate beams $\frac{2912 A d}{l} = W.$

Cylindrical tubes $\frac{1792 \text{ to } 2800 A d}{l} = W.$

Elliptical tubes $\frac{1680 \text{ to } 5510 A d}{l} = W.$

A representing area of section, d the depth in inches, and l the length in feet.

Hodgkinson:

Rectangular beams $\frac{60,000 \text{ to } 90,000 (b d^3 - b' d'^3)}{3 l d} = W.$

Cylindrical tubes $\frac{3.1416 \times 22,500 \text{ to } 35,500 (r^4 - r'^4)}{A l} = W.$

Elliptical tubes $\frac{3.1416 \times 29,000 \text{ to } 37,000 (c b^3 - c' b'^3)}{A l} = W.$

$v, v',$ and d, d' representing the external and internal breadths and depths; r and r' , the external and internal radii; and c and c' and b and b' , semi-conjugate and semi-transverse diameter in inches; and l the length in inches.

COMPARATIVE VALUES OF WROUGHT IRON BARS, HOLLOW GIRDERS, OR TUBES OF VARIOUS FIGURES (ENGLISH IRON).

Square bar	250
Round bar	195
Rectangular tubes, plates top and bottom thick, sides thin	425

Welded Tubes without Rivets.

Rectangular uniform thickness	375
Circular ditto	325
Elliptic ditto	350
Circular tubes riveted.....	190
Rectangular ditto.....	280
Elliptic ditto	250
Flanged beams	240
Plate ditto	320

Determined by the formula,

$$\frac{A d V}{2} = W.$$

* See Report of Commissioners on Railway Structures, 1849.

STRENGTH OF CAST IRON AND WROUGHT IRON PILLARS.

(Continued from page 254.)

Solid Uniform Cylindrical Pillars of Cast Iron, with Both Ends Flat.

Length in feet.	No. of diams. contained in the length or height.	Diameter in inches.	$W = 44.16 \frac{D^{3.55}}{L^{1.7}}$ Breaking weight in tons.	Safe weight in tons.
10	30	4	120.8	30.20
12½	30	5	182.6	45.65
15	30	6	255.9	63.97
17½	35	6	197.0	49.25
20	40	6	156.9	39.22

Solid Uniform Cylindrical Pillars of Wrought Iron, with Both Ends Flat.

Length in feet.	No. of diams. contained in the length or height.	Diameter in inches.	$W = 133.75 \frac{D^{3.55}}{L^2}$ Breaking weight in tons.	Safe weight in tons.
10	30	4	183.5	45.87
12½	30	5	259.4	64.85
15	30	6	344.1	86.02
17½	35	6	252.8	63.20
20	40	6	193.5	48.37

NOTE.—In the above tables the breaking weight is not critically correct for those pillars with flat ends, whose height is only 30 diameters. In my calculations I find that the breaking weight of pillars, as deduced from the formulæ for long flexible pillars with flat ends, is not correct, unless the height of the pillar is nearly 31 times its diameter.

Comparative Table representing the Strength of Long Flexible Pillars of Timber and Iron to sustain a Pressure in the direction of their Length, Both Ends being Flat and Firmly Fixed, and the Height of the Pillars exceeding 30 times their diameter.

This Table shows the calculated Breaking Weight of Solid Square Pillars of Red Deal and Dantzic Oak, seasoned—Uniform Hollow Cylindrical Pillars of Cast Iron, whose sectional thickness is 1 inch; also, Uniform Solid Cylindrical Pillars of Cast Iron and Wrought Iron.

Length or height of Pillar in feet.	Number of diameters contained in length or height of Pillar.	Diameter outside of Square in inches.	Internal diameter of Hollow Pillar in inches.	Solid Square Pillar of Red Deal (dry). Calculated breaking weight in tons from formula, $W = 7.81 \frac{D^4}{L^2}$	Solid Square Pillar of Dantzic Oak (dry). Calculated breaking weight in tons from formula, $W = 10.95 \frac{D^4}{L^2}$	Hollow Cylindrical Pillar of Cast Iron. Calculated breaking weight in tons from formula, $W = 44.34 \frac{D^{3.55} - d^{3.55}}{L^{1.7}}$	Solid Cylindrical Pillar of Cast Iron. Calculated breaking weight in tons from formula, $W = 44.16 \frac{D^{3.55}}{L^{1.7}}$	Solid Cylindrical Pillar of Wrought Iron. Calculated breaking weight in tons from formula, $W = 133.75 \frac{D^{3.55}}{L^2}$
10½	31½	4	2	18.13	25.42	101.99	111.25	166.43
11	33	4	2	16.52	23.16	94.40	102.79	151.64
11½	34½	4	2	15.11	21.19	87.53	95.31	138.74
12	36	4	2	13.88	19.46	81.42	88.66	127.42
12½	37½	4	2	12.78	17.94	75.96	82.71	117.43
13	39	4	2	11.83	16.58	71.06	77.38	108.57
13½	40½	4	2	10.97	15.38	66.64	72.57	100.68
14	42	4	2	10.20	14.30	62.65	68.22	93.61
14½	43½	4	2	9.50	13.33	59.02	64.27	87.27
15	45	4	2	8.88	12.45	55.72	60.67	81.55
13	31½	5	3	28.88	40.49	143.59	170.87	239.74
14	35	5	3	24.90	34.91	126.59	150.64	206.71
15	36	5	3	21.69	30.41	112.58	133.97	180.07
16	38	5	3	19.06	27.51	100.88	120.05	158.26
17	40	5	3	16.89	23.68	91.00	108.29	140.19
18	43	5	3	15.06	21.12	82.57	98.26	125.05
19	45	5	3	13.52	18.95	75.32	89.63	112.23
20	48	5	3	12.20	17.10	69.03	82.15	101.29
16	32	6	4	39.53	55.43	175.67	229.32	302.33
17	34	6	4	35.02	49.10	158.46	206.86	267.81
17½	35	6	4	33.05	46.34	150.85	196.92	252.76
18	36	6	4	31.24	43.80	143.79	187.71	238.88
19	38	6	4	28.03	39.31	131.16	171.22	214.39
20	40	6	4	25.31	35.48	120.21	156.93	193.52
18	30	7	5	57.87	81.14	324.46	227.11	412.89
19	32½	7	5	51.94	72.82	207.16	235.96	370.58
20	34½	7	5	46.87	65.72	189.86	271.24	334.44
22	33	8	6	66.09	92.66	238.08	370.57	444.03
24	36	8	6	55.53	77.86	205.35	319.62	373.11
26	39	8	6	47.32	66.34	179.22	278.96	317.91
23	42	8	6	40.80	57.20	158.01	245.94	274.12
30	45	8	6	35.54	49.83	140.52	218.72	238.79
35	52½	8	6	26.11	36.61	108.12	168.30	175.43
40	60	8	6	19.99	28.03	86.14	134.11	134.32

Hollow Cylindrical Pillars of Cast Iron, with Both Ends Flat.

Length in feet.	No. of diams. contained in the length or height.	External diam. in inches.	Internal diam. in inches.	$Y = \frac{bc}{b + \frac{1}{2}c}$ Breaking weight in tons:	Safe weight in tons.
8	24	4	3	100.07	25.01
8	19½	5	4	160.94	40.23
8	16	6	5	229.22	57.30
8	13½	7	5½	426.70	106.67
8	12	8	6½	539.67	134.91
8	10½	9	7½	656.30	164.07
8	9¾	10	8½	774.87	193.71
8	8¾	11	9	1153.46	283.36
8	8	12	10	1313.65	323.41
8	7½	13	11	1475.01	363.75
8	6¾	14	12	1635.95	403.98
8	6½	15	12½	2197.02	549.25
8	6	16	13½	2398.52	599.63
8	5½	17	14½	2596.32	649.08
8	5¾	18	15½	2800.97	700.24

NOTE.—The value of Y in the above formula is compounded of two quantities; b the strength, as obtained from one of the formulæ for long flexible pillars; and c the crushing force.

The following tables show the breaking weight of uniform hollow cylindrical pillars of cast iron, deduced from several formulæ, and for different qualities of cast iron:—

Length or height of the pillar, 8ft. External diam., 18in. Internal diam., 15½in.

2800.98 tons.	2781.93 tons.	2403.10 tons.	2146.40 tons.
2800.94 „	2746.46 „	2157.72 „	

Length or height of the pillar, 10ft. External diam., 18in. Internal diam. 15½in.

2641.49 tons.	2616.51 tons.	2061.84 tons.	2046.79 tons.
2641.15 „	2114.46 „		

BRITISH ASSOCIATION FOR THE ADVANCEMENT
 OF SCIENCE.

THIRTY-FIRST ANNUAL MEETING, HELD AT MANCHESTER, SEPT., 1861.

WILLIAM FAIRBAIRN, ESQ., C.E., LL.D., F.R.S., PRESIDENT.

SECTION G (MECHANICAL SCIENCE).

ON BATESON'S FEED-WATER HEATING APPARATUS.

By J. E. McCONNELL, ESQ., M. INST. C.E.

The paper I have the honour of reading to you is on the subject of a Feed-water Heating Apparatus, as applicable to all boilers; and of a safety-tube for such steam generators as are composed wholly, or in part, of water tubes.

This apparatus, which is the invention of Mr. S. Bateson, has been fitted to the Duke of Sutherland's steam yacht *Undine*, and also to three locomotives on the London and North-Western Railway, and I believe is also at work on a locomotive belonging to the Great Northern Railway Company. The practical advantages of heating feed-water have been so long recognised that it is superfluous to descant upon them, and the contrivances to effect this object are so numerous that it would be beyond the limits of this paper to describe them further than to state that hitherto they appear to have been chiefly directed to heating the feed-water when still in the tank or source of supply, and before it is drawn therefrom by the pump, and forced into the boiler.

That a considerable advantage is thus gained is obvious, but that it must be limited in amount is equally so, from the fact that if the water in the tank be heated beyond, say 190° Fahrenheit, the feed-pump will cease to act, both from the expansion of the plunger, and also from the amount of steam in the heated water tending to produce equilibrium, not to take into account the destructive action of heat on valves, &c. The distinctive feature in the invention, of which the present paper is the subject, consists in heating the feed-water after it has been drawn from the tank by the pump, and while it is being forced into the boiler.

This is effected by placing within the fire-box or furnace a tube or feed-coil exposed to the direct action of the fire, and through which the water is forced into the boiler.

It may appear strange that this simple method has not been adopted long ago; but the reason probably exists in the well-known tendency of water to assume the spheroidal condition when confined within the narrow area of a tube and exposed to intense heat, the immediate consequence of which is, that circulation ceases, and that portion of the metal left without water is soon burned through, and the tube or water-box is destroyed.

Although there might be no risk of this taking place as long as the feed-pump is in action and a constant supply of water is passing through the feed-coil, washing its inner surface, and carrying with it each successive increment of heat conducted through the metal, yet it would be liable to occur while steam was getting up in the boiler, when the engine was not in motion, or when the boiler being sufficiently full, the feed-pump was not in action.

To obviate this difficulty, Mr. Bateson connects each end of the feed-coil with the boiler, and by means of a valvular arrangement, converts it into a tubular appendage to, or indeed part of the boiler itself, whenever the feed pump is not in action. And he further provides for the constant circulation of water therein by the following contrivance, which may be considered to be the most noticeable feature in the invention.

Within the feed-coil is placed a tube of much smaller diameter, both ends of which are in connexion with the water-space of the boiler. This inner tube is perforated with small holes throughout that portion of its length which coincides with the surface of the feed-coil which is in immediate or nearly immediate contact with the fire, the effect of which is that the pressure of the column of water keeps the small tube constantly supplied, and when steam is generated, its pressure upon the water in the boiler will force a supply of such water through the perforations in the small tube into the feed-coil at those parts where, by reason of the great heat, the water, which is being circulated through the feed-coil, has a tendency to assume the spheroidal condition, or to be converted into steam, by which means the burning or destruction of the feed-coil is prevented, as the constant supply of water of a lower temperature than that in the feed-coil is maintained in the inner tube, and the small jet forced through the perforations is sufficient to instantaneously restore the failing circulation.

In the absence of steam pressure, the supply from the inner pipe may be maintained solely by the difference of the temperature of the water in the two pipes. The perforations are placed alternately on opposite sides of the inner tube. They are about $\frac{3}{8}$ inch apart, and about $\frac{1}{16}$ of an inch in diameter; and inasmuch as the temperature of the water is always higher in the feed-coil, and the pressure consequently greater, than in the inner tube, these perforations are hermetically sealed, and no water can issue from them, except a supply is rendered necessary, owing to a quasi-vacuum being formed in the feed-coil from the spheroidal condition of the water therein, and then at the very moment it is necessary, and not until then, a jet of water is forced through the perforation nearest the spot. The spheroidal condition is thus completely counteracted by this internal safety tube.

This tube, being supported and kept in a central position as regards the feed coil, is consequently always surrounded with water. The supports which are introduced, and which are of the form of small crosses, cause the water which is being circulated through the feed-coil to be broken up and *bouleversé*, so that each water atom in its turn comes in contact with the heated metal.

The valvular arrangements by which the feed-water is admitted to the coil are as follows:—The feed pump is connected with the pipe which opens into the clack valve box. A branch from this valve opens into the valve-casing, fitted with upper and lower reversed conical disc valves.

These valves are both attached to one spindle, passing out through a stuffing box at the top and terminating in a screw.

This screw is fitted with a nut attached to a winch handle, which nut works in the cross bar of a pair of guide pillars, so that on turning the handle the two valves may be simultaneously raised or lowered, as may be desired.

It is obvious that the valves may thus be placed in three different positions. *First*, the upper valve may be shut and the lower one opened. *Second*, both valves may be open. *Third*, the upper valve may be open, and the lower, shut.

The *first* position is adopted when the pump is at work and the engine in action. The feed water passes by the lower valve down the pipe, and enters the feed-coil in the furnace.

The *second*, when steam is getting up, or the engine at rest; the coil thus becomes, as before stated, a tubular appendage to the boiler and part of its heating surface.

The *third* is only made use of in the event of an accident happening to the feed-coil, which is thus shut off altogether from the boiler, and the feed water is forced in through the upper valve. The index carried by the screw spindle indicates the position of the duplex valve in its casing.

The other end of the feed-coil, where the heated water is discharged into the boiler, is also fitted with a valve-box; the valve inside is also attached to a spindle, but this valve is only shut in case of an accident to the feed-coil, when the communication with the boiler must be closed. For a similar purpose the ends of the internal perforated safety tube are fitted with cocks, where they lead into the water space.

The following may be stated as the advantages to be gained by this invention: As regards the saving of fuel—this is effected indirectly, but to a great extent, by reason of the generation of steam not being checked by the introduction of cold water.

It is quite true, as may be objected, that a given quantity of fuel will only supply a certain amount of heat. But that heat may be utilised better than under the old arrangement of fire-box. The feed water, as it is forced through the feed-coil, is heated, atom by atom, as it were, instead of being heated *en masse* in the boiler, and is thus heated quicker; while, at the same time, the body of water in the boiler is not lowered in temperature. This profitable heating of the feed water is, of course, of peculiar advantage in high-pressure engines, especially in locomotives, which evaporate so much water.

Moreover, the quantity of feed may be exactly proportioned to the consumption of the engine in the case of locomotives, irrespective of gradients.

Again, from the place in which the water enters the locomotive boiler, the top of the fire-box is kept clean from deposit, owing to the constant rush of water over it.

The feed-water being thus heated approximately to the temperature of the water in the boiler, mixes easily with it, and one source of priming is thus avoided, to the consequent saving of water.

With reference to deposit of scale in the feed-coil it may be stated that the Duke of Sutherland's yacht *Undine*, fitted with this apparatus, was in commission last year (1860) for three months, on the east and west coasts of Scotland. The feed-water was forced through 56ft. of feed-coil (28ft. in each length), and, on examination, the feed-coil proved to be as free from salt or deposit as on the day it was first used—the internal tube was equally so—and here it should be observed, that although the feed-coils were placed too high in the furnace, and not sufficiently exposed to the action of the fire, yet the consumption of coal was, if anything, under that of previous years, although six feet of additional height was added to her funnel, and the blow-off cock constantly open, besides a jet of steam being used as a blast pipe in the funnel. In the locomotive engines fitted with Mr. Bateson's apparatus, on the London and North-Western Railway, there has been the same remarkable immunity from scale or deposit in the feed-coil. This arises from the constant circulation of the water therein, and as water, chemically speaking, precipitates its salts immediately on reaching the boiling point, it is possible that this takes place in the feed-coil, and that the deposit is forced in a solid form into the boiler; should this supposition prove to be correct, the boiler itself will be unusually free from scale, as when once precipitated in a loose state, it will not again become attached to the boiler.

The following is a comparative statement of consumption of fuel, &c., in a locomotive engine, with and without the feed-coil:—

WITHOUT COIL.—No. 147 ENGINE.	WITH COIL.—No. 147 ENGINE.
4th Feb. to 4th of March, 1861.	11th March to 11th April, 1861.
Miles, 3187; coke, 60 cwt.; coal, 106½ cwt.; tons conveyed one mile, 365,623; consumption per mile, 33·61 lbs.; consumption per ton per mile, 0·2361 lbs.	Miles, 3369; coke, 150 cwt.; coals, 1141 cwt.; tons conveyed one mile, 482,594; consumption per mile, 30·12 lbs.; consumption per ton per mile, 0·18 lbs.

INSTITUTION OF CIVIL ENGINEERS.

GEORGE P. BIDDEE, ESQ., PRESIDENT, IN THE CHAIR.

November 12, 1861.

Before commencing the business of the evening, the President alluded to the singular fact of its having been his painful duty, on the first meeting of the late Sessions, to notice the loss of some old and distinguished members of the profession. Thus, he had announced the loss of Mr. Brunel, Mr. Robert Stephenson, and Mr. Locke, and now he had to mention the decease of Sir William Cubitt. This distinguished Engineer was a very old member of the Institution, had zealously assisted in its early struggles, and, as a Vice-President and as President, had lent effectual aid in extricating it from its financial difficulties. He was early distinguished for his knowledge of mechanical engineering, in which branch he introduced some ingenious improvements. Among his principal civil

engineering works were mentioned the South Eastern, and the Great Northern Railways; the gigantic floating landing stages at Liverpool; the iron bridge at Rochester; and the effective superintendence of the construction of the Crystal Palace in Hyde Park in 1851, which service was recognised by Her Majesty conferring on him the honour of knighthood.

Sir William, unlike other members, had attained an advanced age, and during his long career had secured the respect and esteem of all his professional brethren, as well as the consideration of all with whom he was brought into contact. His success was doubtless, in a great degree, to be ascribed to the soundness of his early mechanical experience, which he never failed to impress upon all the younger members of the profession. His loss would be sincerely felt by the Society of which he had been so useful a member; and the President, in feeling terms, expressed the hope that Sir William's memory would be kept alive in the Institution by the works of his son, Mr. Joseph Cubitt, who had succeeded his father in the Council.

ON THE HOOGHLY AND THE MUTLA.

By MR. J. A. LONGRIDGE, M. INST. C.E.

The subject was divided into the following heads:—First, a statement of the commercial importance of the Port of Calcutta. Secondly, a brief account of the present mode of transport of the traffic to the port, and the modification of it, by works now in progress. Thirdly, a sketch of the physical features of the two outlets, the Hooghly and the Mutla. Fourthly, remarks on the past and present state of those rivers, as navigable channels, together with a consideration of remedial measures.

The port of Calcutta was the emporium of the commerce of a great part of the Peninsula of Hindostan. It had been ascertained, from official returns, that during the five years ending 30th April, 1861, the imports had amounted to 626,800 tons, and the exports to 620,000 tons, on the average annually. This, however, only gave an approximation to the trade of Calcutta; for the amount of tonnage paying toll on the Eastern Canals was, in 1856, about 1,700,000 tons, and in 1859 it was not less than 2,250,000 tons. This traffic was wholly dependent on water communication, and was conducted under circumstances of great difficulty and danger, at considerable expense, principally by such rude modes of conveyance as nature, unaided by art, had provided. But, vast as was the present trade of Eastern India, it was as nothing compared with what it might be rendered, if a wise policy should encourage, and allow full scope to, the capital and energy of Great Britain.

For about four months of the year, during the flood season, the traffic coming down the river Ganges, entered one of the three Nuddea rivers,—the Bhagiruttee, the Jellinghy, and the Matabanga—at Sooty, Jellinghy, and Sadassapore, respectively. These rivers ran in a southerly direction, and by their union formed the river Hooghly, about 45 miles above Calcutta. During the dry season, from November to July, the Nuddea rivers were no longer navigable; and then the traffic descended the Ganges to the point where it met the stream of traffic from the Brahmapootra. It afterwards proceeded, via Daeca, through the Sunderbunds navigation, to the Head of the Mutla, whence, by the Biddiadhuree river, it reached the Easteru Canal, and by means of it, the Circular Canal and Tolly's Canal, finally entered the Hooghly at Calcutta.

The delays and obstructions in this navigation had frequently been brought under the notice of Government. In 1853, Mr. Mactier, the Deputy Collector of Furreedpore, reported on the subject, particularly as to the inner route through the Sunderbunds, navigable for boats of about 38 tons. He attributed the delays to the absence of towing-paths, and to the want of room between the Salt-water Lake and the Hooghly. He stated, as the results of his own experience, that in going from the Dhappa toll-house to the Hooghly, a distance of about 4 miles, his own boat of only 9 tons had been detained about ten hours, and on returning, twelve hours; while it had taken others four days to pass in one direction. These evils were in full force in 1857, when the author was sometimes four hours in reaching Dhappa, a distance of 2½ miles, in a small row-boat.

The average rate of travelling, by this system of navigation, might be stated at about 15 miles per day, and the average cost of transport, including insurance and interest on outlay, had been carefully calculated by the author to amount to 0.644 of a penny per ton per mile. When the East Indian Railway, intercepting the traffic of the Ganges at Rajmahal, and the Eastern Bengal Railway meeting it at Kooshtee, were completed, the average cost of carriage per ton would probably be, taking the proportion of traffic passing by the Nuddea rivers, at about one-third of the whole:—

	BY WATER.	BY RAIL.
Rajmahal to Calcutta	24s. 3d.	18s. 9d.
Kooshtee to Calcutta	17s. 11d.	10s. 4d.

This showed a saving of 20 and 40 per cent. respectively, in favour of the rail, exclusive of the advantages of a safe and speedy transit of hours instead of weeks.

The Hooghly, formerly one of the principal mouths of the Ganges, now communicated with that great river only by the three Nuddea rivers. The positions of the exits of these rivers from the Ganges were subject to great variation, owing to the soft nature of the banks rendering them unable to resist the action of the waters in the dry season. The depth of water at the junctions of the rivers with the Ganges varied with the time of the year, and also from one year to another; and sometimes, as in 1853, the three rivers were almost elosed. The quantity of water from the Ganges discharged by these rivers varied greatly. It had been stated by Major Lang, formerly superintendent of these rivers, that in a high flood it amounted to 200,000 cubic feet per second, whilst in the month of March, it did not exceed 5,000 cubic feet per second, of which a large portion was derived from filtration.

The author next proceeded to give a detailed description of the navigable channels of the Hooghly, and referred particularly to the Report of a Committee

appointed by Government in 1853, to inquire into the state of that river, and to the evidence given before that Committee. In concluding this part of the subject, he said that the river might be divided into three sections. First, from Calcutta to Fulta house, a distance of about 34 miles, with an average high-water width of 1,300 yards; it consisted of a series of deep but narrow channels, separated by bars at the points of inflexion of the curved reaches. In this part of the river the navigation, though tedious and troublesome, was not dangerous; and though subject to periodical annual changes, the depth of water did not appear to have suffered any permanent deterioration. Secondly, from Fulta house to Culpee, a distance of 24 miles, the high-water width widened out from 1 mile to 2½ miles. This section embraced the junction of the Damoodah and Roopnarain rivers on the right bank, and the dangerous James and Mary's Sand. The channels were subject to great and sudden changes; the tides and eddies were strong, with shifting sands. There appeared to be evidence of some permanent decrease of depth of water, though not yet to such an extent as to have a serious effect on the navigation. Thirdly, from Culpee to Sand Heads, a distance of 37 miles, the river widened out from 2½ miles at Culpee, to 17 miles at Sangor point. This section contained many dangerous places, and the evidence went to show, that there was a decided and serious shoaling of the water, and a prolongation seawards of the tails of the sands below, to an extent of not less than six miles within the last fifty years.

In reference to the tidal phenomena of the Hooghly the information was extremely scanty. An analysis of the observations made at Kidderpore Dockyard, near Calcutta, from 1st July, 1843, to 30th June, 1844, showed: First, that the duration of the flood was three hours during the freshes, and four hours during the dry season; whilst the ebb lasted from eight to nine hours. Secondly, that the mean rise of tide, on an average of three days, commencing with each quarter of the moon, was, during the dry season, from October to February both inclusive, at spring tides 11ft. 1½in., at neap tides 7ft., and from April to August both inclusive, at spring tides 12ft. 2in., and at neap tides 7ft. 5in. Thirdly, that during the north-east monsoon, from the middle of September to the middle of March, the night tides were higher than the day tides; whilst from the middle of March to the middle of September, when the north-west monsoon prevailed, the day tides were higher than the night tides. The mean velocity of the tidal wave, from Sand Heads to Kidderpore, was about 26½ miles per hour.

The author estimated that the quantity of fresh water passing into the Hooghly from the Ganges, through the Nuddea rivers, was upwards of 60,000 million cubic yards per annum; and the opinion had been stated, that the amount brought down by the Damoodah and Roopnarain rivers was at least equal to that from the Nuddea rivers. Also, that as the great bulk of this fresh water passed down during the inundations, when the rivers of Bengal were highly charged with sediment, he calculated that not less than 39,000,000 cubic yards of solid matter were carried down each year into the river and sea channels of the Hooghly below Calcutta, and an equal quantity from the Damoodah and Roopnarain rivers, so that 78,000,000 cubic yards of solid earth were probably deposited yearly in the Hooghly and its estuary. That this amount of solid matter was not exaggerated, was evident from the statement of Major Rennell, that, in the flood season, the Ganges, from whence the water was derived, contained one-fourth part mud in its waters, and from that of Captain Sherwill, that the annual deposit in the Bay of Bengal, from the Ganges and the Brahmapootra, amounted to 1,500 millions of cubic yards.

As the soil of the Delta of the Ganges consisted of loamy sand and black mud, it was unable to resist the action of the stream, and thence the course of the river was subject to great variations, and its banks were perpetually elanging. On the sea-coast of the Delta there were eight openings, each of which had in turn probably served as the chief mouth of the Ganges. Of these, the Hooghly was the most westerly, and the Mutla—the third from the west—was about forty miles to the eastward of the Hooghly.

The Mutla was an inlet of the sea, rather than a river, inasmuch as the fresh water entering it was entirely confined to a small portion which drained off the adjoining lands during the wet season. Its depth was in no place less than four fathoms at low-water spring-tides, and the entrance was easy of access. It was free from bars and shifting sands, and the channel appeared to have suffered no material change from the year 1839, when it was first surveyed, to the year 1853, when it was again surveyed. It was entirely tidal, was not subject to freshes, and was free from the bore, at times so destructive in the Hooghly. At the head of the river, where it was proposed to establish the new port, there was space for two hundred and forty ships, and in the Edoo Creek, for six hundred ships of the largest size, still leaving ample room for ships to swing in the stream. Excepting during the short period when the Nuddea rivers were open, the whole of the traffic to Calcutta from the Ganges passed across the Mutla.

Comparing the two rivers, the Hooghly and the Mutla, in regard to their facilities for navigation, and their general hydrographical features, it would be found first, that the distance from the head of the Mutla to the sea, opposite Buleherry Island, was 65 miles, whilst from Calcutta to Middleton Point was 99 miles. Next, as to the depth of water:—If a standard of 24ft. at low water was assumed, it would be found, that in the Mutla there were no shoals; whereas in the Hooghly there were six, of a length in the aggregate of upwards of 14 miles, with a low water depth of from 15ft. to 18ft. only. To give a standard depth of 30ft. at low water, the Mutla would require deepening at four places to an extent varying from zero to 6ft.; whilst in the Hooghly the length to be deepened would be nearly 26 miles, and the depth to be excavated from zero to 15ft. Again, in the Hooghly, the lowermost shoal was 63 miles from the uppermost, whereas, in the Mutla, taking even the 30ft. standard, the shoals, which were much less in extent, were all contained within a distance of 30 miles; or, if the first and last, which were inconsiderable and might easily be removed, were neglected, then the only existing shoal would be comprised in a distance of 3½ miles. It might be stated generally that, whereas a ship drawing 24ft. could only get to sea from Calcutta by the aid of steam, and under the most favourable circumstances, in three or four days, or during the south-west monsoon in five

days, the same vessel could at all times get to sea from the head of the Mutla, in from eight to ten hours. By the adoption of the Mutla it was believed that two days could be saved in the time of the postal and passenger service between this country and Calcutta. In the author's report on the Calcutta and South Eastern Railway (1857), he entered fully into the comparative charges of the two ports, and the result showed a saving of £587 10s. on each voyage of a ship of 1000 tons in favour of the Mutla, or about 11s. 6d. a ton.

With regard to the engineering points involved in the comparison of the two rivers, it would have been remarked that both ran through a precisely similar country, both were remarkably alike in their courses, and both were subject to the same tides; yet one was dangerous and difficult, whilst the other was safe and convenient for navigation. Whence did this difference arise, and could it be remedied? The great physical distinction was, that in the Hooghly there was a vast, though greatly varying, supply of fresh water, acting simultaneously with the tidal flow; whereas in the Mutla there was tidal water alone,—and not only that which filled its own bed every twenty hours, but a vast body which passed through it, and flowed into and ebbed from the great reservoir channels of the Biddiadhurree and the Attara Banka and their branches at the head, and other Sunderbund Creeks. This was the distinction in the conditions to which, in the author's opinion, were due to the differences in their state as navigable channels. The comparison of these two rivers appeared to him decisive as to the value of tidal water alone versus fresh water and tidal scour combined. By tidal scour alone there was a deep and unchanging channel free from bars and shifting sands. By the combined action of fresh water and tidal scour there were shoals, shifting sands, variable channels, and a gradual, and it might even be said, a rapid shoaling of the lower channels of the estuary.

In conclusion, respecting the presumed rivalry between the old port of Calcutta and the new one of the Mutla, the author quoted from the report which he made in 1857, to the Directors of the Calcutta and South Eastern Railway Company, in which he expressed the belief, that as the trade of India was striding onwards, and as the railway system would pour an enormously increasing stream of traffic to Calcutta, commerce would attain such a development as to "afford an abundant business for both ports, and confer an incalculable benefit upon this magnificent country."

MANCHESTER LITERARY AND PHILOSOPHICAL SOCIETY.

November 12th, 1861.

Dr. R. ANGUS SMITH, V.P., in the Chair.

Mr. E. W. Binney said that some years since he read a paper before the Society, "On the Drift Deposits found near Blackpool," which was afterwards printed in Vol X. (new series) of the Memoirs. In the gravel at Bispham, most probably the high level gravel of Mr. Prestwich, he found nineteen species of shells, all identical with those now found in the Irish Sea. He also stated that in the lowest bed of till there found, full of scored and striated rocks, he collected shells of the genera *turritella*, *buccinum*, *nassa*, *dentalium*, *nucla*, *cardium*, and *tellina*. Owing to such shells found in these deposits not having so arctic a character as those said to be found in other till beds, it has been supposed that they are of a more recent date than the glacial age of Forbes, or the pleistocene of Lyell. Professor King, of Queen's College, Galway, a geologist of high reputation, in his Synoptical Table of British Aqueous Rock Groups, &c., just published, classes the Blackpool fossils with post-pleistocene, as shell and sands occurring just under deposits now forming around the shores of the British Islands, and immediately above the Devonshire raised beaches. The Blackpool gravels, near Bispham, are as good pleistocene as can be found in any of the high level gravels met with further inland, notwithstanding the fossils discovered in them, which are of the same kind, although not so numerous, as those met with in the gravels of Bowden, Cheshire, and the sands of Haigh, Lancashire. He also said that the lowest bed of till seen at Blackpool, and containing the shells previously alluded to, had all the physical characters of the Scottish, Irish, and North of England iceberg and glacial drift, and had been subject to considerable elevations since its deposition.

Mr. R. D. Darbishire stated that he had lately found under undisturbed clay at a considerable elevation on the southerly slope of Great Orme's Head, a deposit of bones of different mammalia intermixed with shells of *mytilus*, *littorina*, and *patella*. He hoped to lay the results of further observations before the Society on a future occasion. He supposed the deposit might be connected with the present or past existence of some "bone cave," in the limestone rock of the Head.

He suggested, however, that possibly the bones and shells may have been the remnants of the cookery of former inhabitants of the district, and referred, in illustration, to the researches made amongst the Kjolkenmøddings on the coasts of Denmark.

Dr. Joule, in reference to speculations on the thickness of the earth's crust, stated that he had some time ago received a letter from Professor Thomson, giving an account of the progress of investigations calculated to throw light on this interesting subject. Professor Thomson finds that the equilibrium lunar tide in a solid glass globe (without mutual gravitation) of the same size as the earth is about five feet. Hence, from the phenomena of the actual tides of the ocean, it follows that the earth, as a whole, is more rigid than glass. The observations of Mallet, with experimental earthquakes, show that the earth's crust is many times less rigid than glass. Hence Professor Thomson infers that the earth, as a whole, is many times more rigid than the rocks and strata on its surface.

Dr. Crace Calvert stated that he wished to draw the attention of the manufacturing chemists of this district to a very simple and rapid method which had been devised by the eminent chemist, M. Pelouze, Master of the Paris Mint, for

determining the amount of sulphur existing in pyrites. He (Dr. Calvert) was induced to do so, believing that any process which would simplify the long and troublesome operations now followed to ascertain the value of this mineral would be useful to many members now present at this meeting. The process consists in mixing intimately together one part of pyrites, thoroughly pulverised in an agate mortar, with five parts of carbonate of soda, seven parts of chloride of potash, and five parts of chloride of sodium, and placing the whole in an iron spoon, which is gradually carried to a dull red heat. The mass, when cold, is first washed with cold water and then with boiling water, until the whole of the soluble matter is removed; and this solution is tested with a standard solution of sulphuric acid. As 100 grains of carbonate of soda requires 92.45 of mono-hydrated sulphuric acid, or $S O_3 H O$, it follows that the quantity of soda in the carbonate of soda employed will decrease in proportion to the quantity of sulphur from the pyrites converted into sulphuric acid, which will have neutralised a corresponding quantity of the soda in the carbonate.

This mode of assaying is so simple, that the author states that he can determine, within one or one and a half per cent., the value of a sample of pyrites, in the space of an hour's time.

M. Pelouze also states that by employing the following proportions of the same materials, the manufacturer can determine the amount of sulphur in burnt pyrites. Five parts of the latter substance are mixed intimately with five parts of pure carbonate of soda and five parts of chloride of potash.

CIVIL AND MECHANICAL ENGINEERS SOCIETY.

MR. FRANCIS CAMPIN, PRESIDENT, IN THE CHAIR.

October 31st, 1861.

ON STEAM FIRE ENGINES.

By MR. CHARLES B. KING.

The author stated that the first steam fire-engine was constructed in England by Mr. John Braithwaite in the year 1830. It consisted of a 6 horse-power steam engine, and the pumps worked thereby were swung upon a carriage, drawn by two horses. Steam sufficient for working could be obtained in the course of thirteen minutes.

The author then described the "Comet," built for the Prussian Minister of the Interior, and likewise two subsequent engines of Messrs. Braithwaite and Co.

The Americans then took up the subject, and Captain Ericson obtained the gold medal offered in 1840 for the best plan of a steam fire-engine, which was very similar to the engines of Mr. Braithwaite. The author then described an engine built in New York by Mr. P. Hodge, designed for "auxiliary" steam propulsion. About 1850, Mr. A. B. Latta, U.S., constructed an engine with self-propelling gear weighing 10 tons. Within a few years, steam fire-engines have been adopted in Philadelphia, Boston, New York, and other cities of the States, builders having variously and widely modified the earlier plans, whilst some have made entirely new ones. The main feature of all these plans is the boiler, which is constructed for the rapid generation of steam, and excellent results have been obtained. Mr. Latta's engines have begun work in from three to five minutes from the application of the match. The engines built by the Amos Keag Company, of New Hampshire, have begun in $3\frac{1}{2}$ minutes. Those of Silsby and Co., of Seneca Falls, New York, have begun in from 5 to 6 minutes. These differences are doubtless due to the various amounts of heating surface each boiler presents. The engines of Messrs. Lee and Larned, of the Novelty Works, New York, are probably the most celebrated, and with good cause, as being remarkable for their strength, lightness, and durability, all being leading essentials in a successful steam fire-engine. In these engines there is less water to heat, and their flues are extremely light. The most celebrated engine of this make is the one known as the "I. C. Cary;" it is fitted with Mr. J. K. Fisher's steam carriage apparatus, to enable it to be self-propelling.

The author then gave some interesting statistical information relative to several public trials of American engines, and this brought him to the period when English engineers began to turn their attention again to the construction of land steam fire-engines, which attention had so long lain dormant. In these Messrs. Shand and Mason are foremost, the results produced by their engines being very fair specimens of hydraulic engineering. Messrs. Merryweather and Son are constructing a steam fire-engine which has several important improvements, among which may be mentioned that the delivery valves are placed at the bottom of the pump cylinder instead of at the top.

The author then described the upper floating engine (moored off Southwark Bridge), also the land engine (stationed at Watling-street) belonging to the London Fire Engine Establishment, constructed by Messrs. Shand and Mason.

The author considered the chief points to be arrived at in the construction of land steam fire-engines are lightness, combined with strength, compactness, and simplicity of the moving parts, with a boiler capable of generating steam to a working pressure in at least ten minutes, which is soon enough for any practical purpose, exemplified by the metropolitan practice. He was also of opinion that a reciprocating pump is to be preferred to either a rotary or a centrifugal. Double cylinders and good counterweights are almost indispensable to the good and efficient working of the engine.

A discussion followed the reading of this paper.

7th November, 1861.

ON THE VARIOUS METHODS OF SINKING IRON CYLINDERS FOR FOUNDATIONS.

By MR. JAMES B. WALTON, VICE-PRESIDENT.

The author, after a brief review of sub-aqueous operations which, on account of their importance, and the successful manner in which they have been executed in spite of apparently insurmountable difficulties, have attracted the

attention of the scientific world, proceeded,—firstly, to consider the claims of the diving-bell, and to enumerate several instances in which it had been adopted by engineers for the purpose of forming the foundations of bridges, breakwaters, &c. A minute description was given of the diving-bell, as improved by the ingenuity of Dr. Halley, and in which he remained, with four others, for one hour and a-half, in nine or ten fathoms of water, without any inconvenience. An account was given of the diving-bell employed by Smeaton in 1779, for repairing the foundations of Hexham Bridge, and for carrying on the works at Ramsgate Harbour. This bell was much simpler in detail than that of Dr. Halley, and more deserving of attention; its weight was $2\frac{1}{2}$ tons, its height $4\frac{1}{2}$ ft., and its width 3 ft. Two men were able to work it.

The author then stated that operations carried on with the diving-bell were necessarily of an expensive and tedious nature, and as this is a consideration of paramount importance, it would not, therefore, be surprising to know that it is almost entirely superseded by other inventions. Heineke's diving-dress was next alluded to, and the advantages it possessed over the bell were then enumerated, by the use of which a saving may be secured of 75 per cent. Reference was made to the Westminster and Charing Cross bridges, where Heineke's apparatus is in use.

A brief notice was given of the plan adopted in sinking cylinders of small diameters by the ordinary pile driving machine, this method being considered expensive and unsatisfactory, owing to the number of fractures occasioned by the sudden fall of the "monkey."

The next method described was that of sinking cylinders by means of dredging with scoops or spoons furnished with sharp edges and long handles, by means of which they may be worked from above the surface of the water, through which the cylinders are being sunk. The cylinders of Charing Cross bridge are being sunk in this manner, and also those supporting Mr. Gardner's railway bridge at Staines. The former, after the process of dredging has been completed, are weighted with 750 tons of rails, and allowed to sink until no further subsidence can be observed.

Dr. Pott's pneumatic method, which has, in many instances, been adopted with much success, was fully described. This method is not available when applied to stony ground, as water would flow in under the edges of the cylinders and vitiate the internal vacuum.

A plan, the reverse of that just described, known as Hughes's pneumatic method, was next explained, particulars of which, as applied by Mr. Hughes for sinking the cylinders of the new bridge at Rochester, were given, extracts being made from a paper read by Mr. Hughes before the Institution of Civil Engineers. This method consists in filling the cylinder with compressed air, by which means the water is expelled, and men are enabled to carry on the work of excavating. This plan was most successful at Rochester bridge, where unquestionably the other methods described would have resulted in failure, as the bottom consisted of a mass of stone, closely packed, and hard rock. The paper concluded with a description of two ingenious methods of sinking cylinders of small diameter, for the purpose of forming foundations. In one plan, the pile or cylinder is furnished at its lower extremity with a screw; a rotary motion is given to the pile or cylinder, the screw of which forces its way into the ground without materially disturbing it; this is known as Sanders' and Mitchell's patent. In the other, the pile has a disc at the lower end, a hole being left in the centre, through which a wrought iron pipe is carried down the pile, projecting some inches below the bottom; water is forced down the pipe, and a rotary motion given to the pile or cylinder, the sand or silt is loosened, and the pile descends rapidly and easily. This method was invented by Mr. Brunlees, and applied with much success in sinking the piles for the foundations of the railway viaducts in Morecombe Bay.

A discussion followed the reading of this paper.

14th November, 1861.

ON CORNISH MINES.

By MR. WILLIAM GILL.

The author separated his paper into four divisions. In the first he gave an historical notice of the method of working mines from the time when the Phœniciaus first discovered tin in Britain, more than 2000 years ago, explaining the mode in which the Britons procured their tin by means of streaming, before they were taught how to sink shafts, or drive levels or adits, which instruction was afforded them by the Romans; then, following their progress during the successive reigns of the Saxons and Normans, he described the state of stagnation in which the tin mines then existed, owing to the monopoly caused by the management of the Jews, by whom they were then worked, this stagnation being so great that a petition was presented to Edmund, Earl of Cornwall, to correct the abuses then prevalent, whence originated the Stannary laws, established in the reign of Edward I. The progress of tin mining from that time was rapid, and the discovery of gunpowder and the invention of the steam engine led to a complete revolution in the mode of working, as the shafts could be sunk much deeper, and vast tracts hitherto unattainable laid bare. By this means attention was drawn to copper, and in the commencement of the eighteenth century it began to be worked, and that so rapidly that in 1780 its produce equalled in value that of tin, viz., £180,000.

A description was then given of the various tools employed for drawing the stuff, and for the drainage (also, an account of some very curious and ancient pumps), prior to the application of steam to mining purposes. He then followed tin mining in its progress from the time when Savery wrote *The Miner's Friend*, down to the time of Smeaton, Watt, Trevithick, &c., and concluded this portion of his paper by noticing all the more recent inventions tending to the improvement of the Cornish pumping engine.

The second division contained an account of the various metalliferous "lodes," and the method of discovering and working them, commencing with the various

theories of the manner in which the deposit of the mineral in them is effected, and then treated of the different phenomena, and the faults and dislocations to which they are subject; followed by the method in which the timbering of the shafts is accomplished. The raising of the stuff next occupied attention, and the horse and steam "whim" were explained; also the advantages of the skip and vertical railroad over the ordinary bucket or "kibble," and its use advocated in deep shafts, where they are sunk perpendicularly or are regularly inclined; it in that case is stated to be able to save 40 per cent., both in the quantity raised and the time occupied. A detailed description of the pumps employed for drainage was then given.

A description was then given of the surface work and the dressing and preparing of the ores for sale. Tin is stamped very fine and then washed in machines, which are supplied copiously with water, and agitated, so as to cleanse the ore from its impurities and to deposit it in various stages of purity on an inclined board or table, the more valuable portions being near the top, or head, and the less valuable lower down. Copper is broken very small, and sometimes crushed in rollers, and then "jigged" or put in a wire-bottomed sieve, which is shaken up and down in a trough of water; the stuff by this means is kept in suspension and falls according to its specific gravity, the heavier portions at the bottom, and the lighter ones at the top. A new "jigging" machine was noticed, that of Mr. Hunt, of Porthleven. In this machine, instead of the sieve being shaken in the trough, it was stationary, and the water was forced through it; the water never returned through the wires, but was carried away by an arrangement at the top, the ore being kept in perfect suspension, and was very easily treated, one cubic foot of very poor stuff being dressed very successfully in 65 seconds, with only two boys to attend to the machine.

The author concluded with describing the economic management of the mines, the descriptions of labour employed, and the remuneration given.

In the discussion following the paper, the President, Messrs. J. Hilditch, A. Fairlie, J. Tough, M.I.C.E.; F. Roberts, C. B. King, T. Gill, J. B. Walton, and the author took part.

ROYAL INSTITUTE OF BRITISH ARCHITECTS.

CURRENT TOPICS.

By WM. TITE, ESQ., M.P., *President*.

On a similar occasion to the present, two years ago, you did me the honour to invite me to read an opening address, on the occasion of the inauguration of these apartments as our resting-place. On that occasion I endeavoured to bring before you a general review of the state of architecture at that time in Europe, and of its probable future prospects. The interval is not long, but it is marked with important incidents, whether relating to ourselves or the world of art in general. We have lost a noble and beneficent patron and president; and, on the other hand, some of the incidents and considerations which have occurred relating to art in general, and architecture in particular, are most important. These considerations induce me to believe that in my new character as president you will allow me this opportunity of suggesting to you such views as occur to me having reference to the past, and such notice of the circumstances which are now occurring as I trust may be interesting and useful to us in our profession.

As to the first, one's mind naturally recurs to the personal or professional losses we have to record. At the close of this paper I propose to refer to the deaths more specifically; and therefore at present I proceed to notice topics of immediate interest; and first, that which assumes the greatest importance at the present moment—the Great Exposition of 1862. In some concluding remarks I made towards the close of last session, I referred to the position allotted in our modern society to our profession; and this appears to be marked, even in reference to the Exposition of 1862.

On the occasion of the first Exposition, as you may remember, the design proposed by a committee of architects for the building was set aside, and a design happily suggested by Sir Joseph Paxton was adopted in its stead. The services of the members of this Institute were, however, but slightly resorted to; and the superintendence of the working details of the building was entrusted to a member of the newly recognised branch of our profession, a civil engineer. On the present occasion, also, the claims of British architects, to co-operate in the design of a building which ought essentially to represent the state of the art amongst us at the present day, have been ignored; and foreigners are thus likely to form their opinions as to the merits of English architects from the production of a military engineer. I do not propose to criticise the designs of either of the Exposition buildings, notwithstanding the numerous lessons of "what to avoid" they both furnish. But, in the name of this Institution, I think it my duty to protest against the official exclusion of architects from the councils of those who assume to represent the taste of the nation in the various branches of art.

Unfortunately it would seem that the public in general participates in the species of disfavour which this exclusion of recognised architects from the councils of the past and future Expositions may be considered to indicate; and the cheers with which vulgar unreasoning abuse of our profession is almost always received ought to inspire us with serious anxiety.

I believe, from the bottom of my heart, that the accusations brought against us as a body are essentially false,—that architects generally are honourable, conscientious men, hard students, earnest thinkers, and bringing to bear upon their professional duties such an amount of varied information, practised skill, educated talent, and high-minded integrity, as would in any other profession ensure a far greater share of wealth and distinction than we usually attain. Feeling very strongly as I do on this question, it is to me the more painful to observe the existence of an opinion precisely opposed to my own, in those who might be supposed to have known us intimately; as when such men as the present Under Secretary of State for Foreign Affairs did not hesitate to state in Parliament, in the debate on the British Museum, that he advocated the plan proposed by Mr. Oldfield, because it was not prepared by a professional architect, and that the great success of the great reading-room was due to the fact that in that case “the trustees were not trammelled by an architect;” and, further, when in a crowded house these opinions met with considerable applause. Again, look at Mr. Layard’s remarks in the debate on the Foreign Office, in which we are spoken of most disparagingly. And this being so, I am forced to ask myself whether these things can be true. They say that “there can be no smoke without fire;” and it behoves us therefore to see that whatever fire may exist to cause the smoke now obscuring our fame, it is our duty to trample it out.

Again, I cannot but regret to observe the almost unanimous recognition of the distinction lately established between the pursuits of engineering and of architecture; because I am convinced that both of them would gain by being studied and practised simultaneously. In former times, and, indeed, until the establishment of the “Corps Royal des Ingénieurs des Ponts et Chaussées,” in the middle of last century, no such distinction was admitted. Sir C. Wren and Mansard were both architects and engineers. Perronet called himself “Architecte du Roi.” Robert Mylne called himself architect and engineer. Telford began his public career by building a church. It was the development of the canal system which first led to the separation of engineers and architects amongst ourselves; and to some extent this may be explained; for the pursuits of the architect lead his studies rather towards the condition of statical than of dynamical forces, whilst the canal and dock engineer has to deal very frequently with the latter. But in the execution of roads, railways, and such works, there are no conditions which ought to be beyond the sphere of the architect’s knowledge; and I very strongly suspect that, if architects had been more frequently employed on railway works, our marvellous net-work of rails would have been constructed at less cost than it actually has involved, and that we should not have heard of so many accidents from “striking centres too soon,” or from “the rain washing the mortar out of the arches.” It is true that the construction of railways does not afford many opportunities for the exercise of the artistic faculty, the noblest one the architect is called upon to employ. It is a kind of work which requires more of science than of art. But our profession ought, above all others, to present the union of art and science; and he is a bad architect, in the true sense of the word, who is incapable of becoming “the best workman” in any of the branches of what I may be allowed to call *statical* construction. I dwell upon this subject because it seems to me that much of the favour with which civil and military engineers are now regarded, and that their employment to the exclusion of architects, in the cases of the Exposition buildings, may be explained by the mistaken opinions which prevail with respect to the pursuits and the abilities of the latter. Not to travel beyond the names I have before noticed, I may be allowed to observe that the engineering works of Mr. Hosking, upon the West London Railway, may well compare with the architectural achievements of Sir William Cubitt in the first Crystal Palace. Be this as it may, it behoves us at least to render ourselves capable of discharging the ordinary duties of engineers and architects. Hydraulic engineering may require a different mental training, and a course of study of a different character, to that required for building in the open air; but it is absurd to suppose that the man who can build a church could not build a bridge or a viaduct, or that he should be unable to conduct great earthworks or tunnels.

Before leaving the subject of the Exposition buildings, I cannot refrain from saying that the design, given in the *Builder*, of the Florence Exposition, strikes me as containing far more artistic merit, and as presenting a more satisfactory architectural character than the published design of the proposed building of South Kensington; no doubt because in this instance, as in the instance of the construction of the Palais de l’Industrie of Paris, educated architects were consulted. Passing over this part of the subject, however, I am sure that all my hearers will agree with me in the expression of the deep sympathy excited by the first Italian Exposition. These industrial gatherings have assumed, of late years, a deeper moral significance that could possibly have entered into the philosophy of their founders; and they have become the occasions for eliciting the expression of the most recondite forms of national thought and feeling. An Italian Exposition, held in the city of Giotto, Dante,

and Michael Angelo, and the Medici, becomes, therefore, the matter for serious reflection to those who wish that in truth Italy should cease to be “a geographical expression.” And we, whether admirers of the Broletti and of the town-halls of the Mediaeval republics, or of the palazzi, cassine, or churches of the *resorgimento*, must turn an anxious gaze on the first steps of the noble Italian race, in the political *resorgimento* which is at present taking place in that land, so long cursed with what all considered “the fatal gift of beauty.” Our sympathies may be of small import to the Italians in the struggle they have still to go through before they can establish a strong nationality, such as the “advanced civilization” of the age requires; but I am sure that an assembly of architects will unanimously join in the expression of good will towards the Italian cause. May the Exposition of Florence prove the harbinger of the full glory of bright days for Italy!

The artistic Congress of Antwerp, too, fussy and unpractical though it may seem to have been, contains the germs of an organization which may, perhaps, produce for art consequences as important as those produced by our “Association for the Advancement of Science” in its particular sphere. In these days of architectural and artistic eclecticism, it would manifestly be advantageous for the student to be able to study with his own eyes every local manifestation of æsthetic feeling; for the subtle influences of climate, and political and municipal organization, can never be appreciated unless we have the means of watching their daily operation; and few learned treatises on the Art-History of Nations enable us to appreciate the nature and extent of the action and re-action of building, or of plastic materials, on the visible expression of art. The amount of good to be effected by these gatherings must depend on the manner in which they are conducted. As an isolated experiment, the Antwerp Congress was very successful. It were a marvellous pity that it should remain an isolated experiment.

Whilst thus alluding to foreign operations, it may be as well to continue our attempts to derive lessons from them, before turning to more decidedly local considerations; and I would therefore strive to point the moral of some other tales to be read in the proceedings of our immediate neighbours. Thus, all travellers who return from Paris are, upon a superficial view of what is taking place there, and it must be added in almost every important town of France, disposed to find fault with the comparatively slow rate at which improvements are effected in London. Within ten years Paris has been, in fact, remodelled throughout; broad streets, open squares, and fine houses, have replaced the ancient, narrow, tortuous assemblages of dens of filth and impurity. It is to be feared, however, that the real sanitary improvement of Paris has gained little by these changes; and, indeed, so long as the water-supply and the sewerage of that town are conducted on the present systems, little effect can be produced on that infallible test of the value of the sanitary arrangements of the town—the *average death-rate*. I advise those who believe that “they manage all these things better in France” than we do here, to visit the “Intake” of the Chailott Water Works; or, to ponder over the charge he will have to pay, even in a private lodging, for that necessity of an Englishman’s life, the daily hip-bath. Nor is this all: for they who knew much of Paris life in former times, must be painfully convinced that the embellishments of the town have resolved themselves into heavy charges on its inhabitants; whilst the utility of many of the costly works now in hand must seem more than questionable. House-rents have risen to fabulous heights in Paris; the poor are driven from their old haunts, and no refuge is provided for them; whilst, unfortunately, the sanitary defects of the old houses are servilely reproduced in the new ones. But, however painfully these defects may strike us on second and calmer thoughts, it cannot be denied that there is something fairy-like in the rapidity and the brilliance of the change actually produced; and we naturally inquire by what financial agency it has been produced. My friend Mr. G. R. Burnell has made some inquiries into this matter, which I hope he will be able to communicate to you in the course of the session; but, in the meantime, I may say that the impression I have derived from what he has told me is, that the improvements of Paris have been effected upon principles of political economy, and by dint of an abuse of public credit, which would never be tolerated in this country. We hold that local improvements should be paid for by local contributions, and that building speculations should not be assisted by financial corporations, patronized, if not directly managed, by the Government. The opposite principles prevail amongst our neighbours; and, sooner or later, it is to be feared, that they must produce, even if they are not now producing, sad confusion in the finances of the State.

One matter of detail may be worth especial notice from us, viz., the conditions under which the municipality is now able to obtain land for the purpose of effecting any new works declared to be “*d’utilité publique*.” Until 1852 the municipality, under the old law of expropriation, could only take compulsorily the land absolutely required for the establishment of the streets; and the proprietors of the land partially affected were en-

titled to retain the remainders of their property, with all the increased value conferred by the new frontages. At the very close of the dictatorial power assumed by the Emperor in 1851, a decree "having force of law," was issued, however, by which municipal bodies charged with the execution of works of public utility were empowered to take an additional width of land beyond the lines of the intended streets, sufficient to allow the construction of good houses. The effect of this law has been that the municipalities of France have lately been enabled to sell the frontages on the new leading thoroughfares they open at advantageous terms; and thus, at the expense of the landed proprietors disturbed, materially to diminish the cost of the works. If the latter had been discussed by a really representative body, there could be no little reason to regard the advantages thus given with jealousy; but, when the works to be executed are simply prescribed by the Central Government, it is to be feared that great abuses may arise from the interference with the rights of private property it may be made to cover.

The success of the artesian well of Passy is a subject of great interest to all who are called upon to deal with the supply of water to detached mansions, or even to small towns; and to us Englishmen it is the more interesting on account of the recent failures to establish similar wells at Highgate, Harwich, as well as at Calais and at Ostend. The boring at Passy, after passing through the same beds as had previously been traversed at Grenelle, reached the water-bearing stratum at a depth of 1797ft. 6in. from the surface, and the water rose to a height of 13ft. from the ground. The lower diameter of the well is about 2ft. 4in.; and the quantity of water it delivers has, after some oscillations, settled to about 3,791,000 gallons per twenty-four hours. At present, the sand and clay brought up by the water are in such proportions that the water is not fit for use,—a fact which was also observed at Grenelle during the first year after the completion of the boring: the water rises at about 82° Fahrenheit. One effect of this well has been to diminish notably the yield of the Grenelle well; and it must, therefore, for some time to come remain an open question, as to whether or not the water-bearing stratum under Paris will be able permanently to maintain these two springs. The discussion of the failure of the attempts to obtain water in a similar manner to which I have above referred, would extend to so great a length, that I must pass it over slightly at present; but the great lesson to be learnt from it seems to me to be, that at the present day our acquaintance with the laws of geology is only sufficiently advanced to enable us to say with certainty what we shall *not* find beneath the surface, in districts which have not been exposed to violent subterranean disturbances: they are utterly incapable of telling us what we *shall* find. At London, Harwich, Calais, and Ostend, the lowest member of the subcretaceous formations, from which the wells of Passy and Grenelle derive their supply, is entirely wanting.

A very warm and rather acrimonious discussion is now being waged amongst the chemists and experimental observers on the laws of metallurgy with respect to the differences between iron and steel; and the names of Binks, Mushet, Bessemer, Frémy, and Caron, add weight and authority to the various opinions propounded on this very obscure subject; *Non nostrum inter nos tantas componere lites;* and Messrs. Frémy and Caron may well be left to settle the precise amount of influence exercised by the nitrogen, cyanogen, and carbon, present during the cementation of steel upon the resulting product. The influence these researches may exercise upon the building arts may, however, be very great; and the production of steel by the new methods suggested by an improvement in the theory of the production of steel may possibly place within our reach a material possessed of far more valuable elastic properties than either cast or wrought iron. We must therefore follow with interest the steps of this inquiry, and hold ourselves ready to adopt any improvement it may place at our command. I would make the same remark with respect to the recent applications of electricity to the ordinary purposes of life; and I would urge the members of our Institution to avail themselves, whenever it is possible, of the great domestic conveniences that wonderful agent is able to supply. We in England are behind our French neighbours in this respect.

In domestic matters the most important lesson to be derived from the events of the last twelve months is, perhaps, the one connected with the terrible fires in the river-side warehouses. In a city so essentially commercial as London, it must always be desirable to interfere as little as possible with the arrangements or the operations of trade; and we must always bear in mind the fact that every interference of this kind resolves itself ultimately into a tax upon the articles affected. But the terrible effects of a fire when it once bursts out in large stores of merchandise of certain descriptions are such, and are likely to reach so many persons, that it would almost seem necessary to impose some rigorous limitations to the quantity of these goods, or some stringent regulations as to the construction and management of the warehouses wherein they are stored, if these warehouses are to remain in the centre of the town. All systems of so-called fireproof construction are useless to resist the effects of the

heat evolved during the combustion of large masses of certain kinds of goods, and it even seems that the very precautions taken to insure the non-combustion of walls, floors, and ceilings, only adds to the intensity of fires in such cases by turning the buildings, as it were into species of closed retorts able to produce a destructive distillation. The only efficient protections against the spread of large warehouse fires seem to me to consist, first, in limiting the size of the warehouses themselves; and, second, in isolating them effectually if the goods they are to hold should be susceptible of easy combustion. Whatever sacrifices these precautions may entail, they ought to be borne for the sake of the public in general. It may be as well here to mention that in the course of the spring (9th April last) the theatre of Barcelona was burnt to the ground; so that warehouses are far from being the only structures exposed to this terrible scourge.

There is reason to congratulate the country at large, as well as the lovers of our national archæology, on the zeal with which the good work of preserving and restoring our cathedrals has been lately carried on. In the metropolis, the Temple Church is again undergoing repairs, under the direction of our excellent member Professor Sydney Smirke, and Westminster Abbey is in the eminently judicious care of our friend Mr. G. G. Scott. In the provinces the cathedrals of Ely, Lichfield, Ripon, Chichester, the churches of Waltham Cross, Islip, Taunton, and numerous other relics of former times are being restored, and though in the case of Chichester a lamentable accident has occurred, I hope that the efforts to insure the re-edification of the spire will be successful. In more modern constructions, I think we may congratulate ourselves as a body on the improvement which is manifestly taking place in public taste, and on the skill with which the members of our profession have availed themselves of the opportunities afforded them of displaying their knowledge and talent. Art questions are now fortunately discussed on all sides, and a truer, sounder tone of criticism prevails amongst us as a nation than at any former period; and from the fact of our enjoying true liberty of thought and action, I suspect that I may add, than can prevail amongst the despotically administered nations of the Continent. It is our especial duty, as architects, to avail ourselves to the utmost of these advantages, and to devote our best energies to the advancement of our noble art. This can only be done by earnest, conscientious study, by devotion to our pursuit, and by an enlightened investigation of the various physical and moral laws it brings into play. Architecture is, as I have said before, an art as well as a science. Excellence in it cannot be obtained without labour, or without the sacrifice of ease; we must resolve if we would attain in its ranks to that "Fame," the last infirmity of noble minds, "to scorn delights and live laborious days;" but the "fair guerdon" we hope to find, will amply repay us; for art is its own reward, and its cultivation will at all times compensate for the toil and time expended in its pursuit.

In the course of the twelve months which have elapsed since the last annual inauguration of our meetings, death has by no means spared the ranks of those who have been interested in, or who have indirectly assisted, our pursuits. A short notice of the more distinguished of those persons may, perhaps, suggest to many, lessons of deep significance, both morally and artistically, and I hope, therefore, you will bear with me whilst I pay the following short tribute to the memories of our late fellow workers:—

The losses of our profession, this year, have been of a threefold character; we have lost coadjutors in the more recondite branches of archæology, in the more abstruse branches of mechanical, chemical, and physical sciences, and from amongst our own immediate ranks. Amongst the former may be cited the names of Baron Bunsen, of the Earl of Aberdeen, and of Sir Francis Palgrave; in the ranks of scientific men connected directly or indirectly with our studies we miss such men as Wertheim, Vicat, Sir Charles Pasley, Eaton Hodgkinson, Berthier, and Sir William Cubitt; whilst, amongst our own colleagues, we have to regret the loss of Professor Hosking, Mr. John Clayton, Mr. Henry Austin, our late esteemed solicitor and valued friend, Mr. W. L. Donaldson, Mr. George Bailey, and Mr. Robert Grainger, of Newcastle.

The researches of Baron Bunsen, whom I name first, because his death occurred first in the order of time in our sad list (he died on 28th November, 1860), have, as you must be aware, tended greatly to clear the obscurity which surrounded the history of that marvellous system of civilisation of Egypt, and also to throw some light upon the early history of the Church during the existence of the Roman Empire. The learned works upon "The Place of Egypt in the World's History," and upon "Hippolytus and his Age," may be referred to as illustrations of the patient investigation, and of the wide range of study requisite for the comprehension of the more obscure periods in the history of our race; and though the minute detail with which the various questions involved are discussed, at times renders the writings of Bunsen slightly wearisome, yet our confidence in the results so obtained must be increased by the conviction of the conscientious examination their author must have bestowed on them. Bunsen does not seem to have been much of an artist,

SCALE OF TERRESTRIAL DIVERGENCE FOR THE LONG RANGE
(Half Full Size for the Latitude of Greenwich.)

By OMICRON.

APPLICATION.—Multiply the length of the radial line corresponding to the direction in which the shot is fired, by the time of flight, in seconds, and by the range in miles; the product is the amount of divergence from the point of aim caused by the earth's rotation, and the inclination of that radial line shows the direction in which this divergence will take place.

EXAMPLE.—A shot is fired S.S.E.; range, 5 miles; time of flight, 40 seconds required, the terrestrial divergence in amount and direction.

From the scale we get the length of the radial line, 0'312ft.

$$0'312 \times 40 \times 5 = 62'4 \text{ feet.}$$

The shot would have hit the target at O had the earth been stationary; but by reason of the earth's rotation, during the flight of the bolt, it strikes on the line O S.S.E. at about 62½ft. from O.

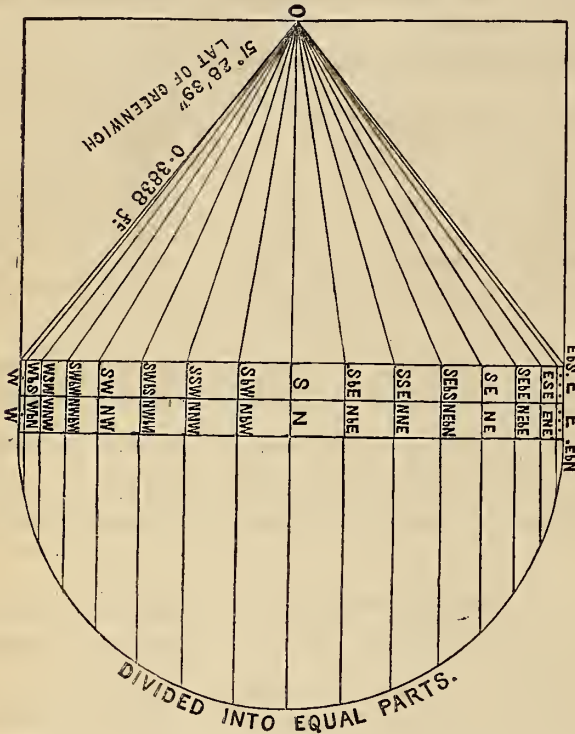

The apparent divergence of the shot in the northern hemisphere will be always to the right, and upwards if east enters into the direction, but downwards if the direction has any west in it.

The real divergence is in the target, and not in the shot. While the bolt flies, the plane of the earth's surface revolves in a W.S.E.N. direction, and carries the target to the left, and therefore the bolt strikes to the right.

In the southern hemisphere the apparent divergence is to the left, but east is still up and west down.

The demonstration of the scale is left to our young readers as a mathematical exercise.

TRIAL OF THE "WARRIOR."

The following is the official report concerning the recent trial trip of this iron-plated frigate. Among other comparative results, it appears that when under full steam the mean rate of speed per hour attained by the *Warrior* was 16½ knots, and by the *Revenge*, 11 knots. In sailing, the ship has considerable advantage over the frigate. The former also wears in seven minutes, while the latter, in consequence of her great length, and the insufficient supply of canvas forward, requires 19 minutes. No severe storm was experienced, but the weather was sufficiently heavy to test the extent of the *Warrior's* rolling, which attained a mean of 16 deg., against 14 deg. by the *Revenge*. The guns of the ship have a range of 45 deg., those in the frigate 22 deg. In firing broadsides the *Revenge* "heels over;" the *Warrior* only "shakes a little." Her ventilating machinery, worked by one boiler, soon clears the space between decks from smoke; it also keeps the stoke-hole well supplied with fresh air. In respect to ventilation the stoke-hole of the *Revenge* is, by comparison, very deficient. The *Warrior* requires a powerful gang of men to steer her.

The following is the abstract of a letter recently addressed to the Editor of the *Shipping and Mercantile Gazette*, by Mr. Nixon, in reply to one signed

"Carbon," which appeared in the same paper, impugning the *Times's* statement concerning this coal, which was used on the occasion of the trial of the *Warrior*.

"Carbon" ought to have been aware of the fact, that a portion of every cargo of coals supplied to the dockyards is tested *practically* in steam boilers kept for the purpose. The reports of these trials have been published in returns to Parliament, and the *Times's* correspondent, knowing the very great importance of the quality of fuel employed on such an occasion, no doubt fully informed himself of the particulars as stated.

"Carbon" gives a table showing the *theoretical* evaporative power of several descriptions of Aberdare coal, *theoretically* calculated from the quantity of carbon and hydrogen contained in their composition, in order to show that Nixon's coal is inferior to others. Allow me to state my reasons why no reliance whatever can be placed on his theory in this instance. First, The coal that stands highest in evaporative power on the list of Sir H. de la Beche and Dr. Lyon Playfair's report, presented to both Houses of Parliament, is placed by "Carbon" at the very bottom of the table referred to, although the coal in both instances was taken from the same seam or bed in the same pit, and treated in accordance with the same chemical analysis. Secondly, Anthracite, which (according to his combination with oxygen theory) ranks amongst the highest as a steam fuel, is in practice found to be worthless. It is called *stone coal*, from being so hard and resisting. His statement, therefore, that *theoretic* superiority of evaporative power, and freedom from breaking down to small, constitute the essentials of a steam fuel, is incorrect.

The superior value of the "upper four-feet" seam in the Aberdare district is so well known that it seems futile to comment upon it. It bears generally a higher royalty, or rent, and commands readily a higher price in the market than any other. It is stipulated for by the Cunard line, Peninsular and Oriental, Royal Mail, Pacific Steam, Hamburg and American, and many others, in their shipments of coal from Cardiff, who can be referred to. It is not, therefore, the fact, as stated by "Carbon," that mixed coals are preferred for the Pacific and other long voyages. The Peninsular and Oriental Company have made trials of the condition, at the port of delivery, of "four-feet" and mixed coal, and would probably satisfy "Carbon" as to the truth of my statement.

There are nine seams of coal (and not three, as given by "Carbon") worked and sold by other colliery proprietors of the Aberdare and Methy districts, under one name, as if of uniform quality, viz.:-

	Ft.	In.
1. Graig Coal	2	6
2. Gothloom ditto	4	0
3. Yard "	2	9
4. Upper Four-feet ditto	6	0
5. Six-feet "	4	0
6. Red Coal "	2	9
7. Nine-feet "	10	6
8. Dirty "	4	0
9. Seven-feet "	7	0
	43	6

THE "OCTAVIA" STEAMSHIP.

One of the most important screw trials which have taken place for some time in Her Majesty's navy took place at Portsmouth on the 20th ultimo, being the official trip of the *Octavia*, 51, screw. This ship was built some years since at Pembroke, from the designs of Sir William Symonds, the then Surveyor of the Navy, as a sailing frigate, but has never yet been placed in commission. In 1860 she was placed in dock at Portsmouth for conversion to a screw frigate, and was taken out of dock on completion of her conversion in the early part of the present year. Her alterations of form consequent on conversion comprised cutting in two parts and lengthening amidships, and an alteration to her stern to adapt it for the propeller. The bow was untouched, and it therefore retains its original bluff form, which was one of the most marked characteristics of the ships designed by Sir William. The importance attached to her official trial on the 20th ult. was owing to the fact of her being the first completed of three vessels the machinery of which had been made with a view to special results, in accordance with orders from the Admiralty to that effect. The machinery of these vessels—the *Constance*, *Arctusa*, and *Octavia*—was contracted for by the firms of Messrs. Penn and Son, Randolph and Elder, and Mandslay, Sons, and Field, who competed to produce each a pair of engines, without limit to cost of manufacture or of design, that should be, as far as they could produce them, economical in their working, each to be 500 horse power, nominal. The *Octavia's* engines have been designed, and their principle patented, by Mr. Sells, chief draughtsman to Messrs. Mandslay, Sons, and Field, and consist of three cylinders with surface condensers, the latter having upwards of 11 miles length of pipes, and two air-pumps. The cylinders are 66in. in diameter, with a 3ft. 6in. stroke. The three cranks, in lieu of the usual two, impart a more equable motion to the shaft by dividing the circle of its revolutions into three equal parts instead of two, as heretofore. The cylinders are surrounded by "steam jackets," and are thus completely encased in steam, being the first frigate's screw engines that have been so fitted in Her Majesty's navy, although the same principle was applied successfully to a paddle steamer many years ago. The boilers are tubular, and as nearly as possible two-thirds the size of others of the same power of engine in other ships. From trials already made it has been satisfactorily proved that the consumption of coal in working the *Octavia's* engines will not exceed one-half that consumed in ordinary instances. The boilers are fitted with a patent superheating apparatus, which at the trial worked exceedingly well, giving a temperature at the engine of 320°. It is cased on one side with a water space, into which the feed water is pumped before passing into the boiler for the purpose of raising its temperature. The steam, after passing through the engines, is thrown by the air-pumps into a tank in the form of dis-

titled water, in which state it re-enters the boilers by a pipe from the tank. The length of the engine-room is 27ft. 6in., and that of the stokehole only 26ft., one boiler only being on each side. This great economy of boiler space enables the ship to carry a greater quantity of fuel, and yet it must be remembered that the ship on the 20th ult. was doing work with these two boilers equal to what she would have done with double her present boiler power had she been fitted in the ordinary way. The ship's steam and vacuum gauges were the patent of S. Smith, of Nottingham. The performance of the machinery throughout the trial was most satisfactory, and was really surprising even to those accustomed to the working of marine engines, from its extraordinary equability and smoothness of movement.

The following are the results of the six runs made at the mile with full power:—

First Run.—Time, 4 min. 29 sec.; speed in knots, 13'383; pressure of steam, 20lb.; revolutions of engines, 68.

Second Run.—Time, 5 min. 30 sec.; speed in knots, 10'909; pressure of steam, 20½lb.; revolutions of engines, 70.

Third Run.—Time, 4 min. 24 sec.; speed in knots, 13'636; pressure of steam, 20lb.; revolutions of engines, 70.

Fourth Run.—Time, 5 min. 32 sec.; speed in knots, 10'843; pressure of steam, 20lb.; revolutions of engines, 70.

Fifth Run.—Time, 4 min. 23 sec.; speed in knots, 13'688; pressure of steam 20lb.; revolutions of engines, 70.

Sixth Run.—Time, 5 min. 29 sec.; speed in knots, 10'942; pressure of steam, 20lb.; revolutions of engines, 71.

The vacuum was the same in all the runs—28½lb.

Four runs were next made at half power (one boiler), with the following results:—

First Run.—Time, 5 min. 11 sec.; speed in knots, 11'575; revolutions of engines, 56.

Second Run.—Time, 6 min. 29 sec.; speed in knots, 9'254; revolutions of engines, 56.

Third Run.—Time, 5 min. 31 sec.; speed in knots, 10'256; revolutions of engines, 54.

Fourth Run.—Time, 6 min. 37 sec.; speed in knots, 9'068; revolutions of engines, 50.

The mean of the six runs (full power) was 12'255 knots, and the mean of the four (half power) was as nearly as possible 10 knots. The temperature of both engine-room and stokehole was of an unusually cool character, as the following figures will prove:—

At 11.30 a.m.—Engines working up to full power. Engine-room platform, 51°; stokehole—centre, 68°; forward, 55°; aft, 58½°.

At 1 p.m.—Engine-room, 58°; stokehole—centre, 80°; forward, 65°; aft, 68°.

At 2 p.m.—Engine-room, 54°; stokehole—centre, 80°; forward, 65°; aft, 69°.

At 2.30 p.m., at half power.—Engine-room, 54°; stokehole—centre, 75°; forward, 62°; aft, 64°.

$$\text{or approximately } M = \frac{S k d'}{2},$$

an approximation which is in defect of the true value of M by a quantity represented by $\frac{x^2}{3 d d'}$ of the result found by approximation. This defect is almost infinitesimal in the majority of cases. In the example given in the March number of THE ARTIZAN this defect is $\frac{1}{37110}$ of the result found; therefore this proposed approximation is as near to the true value of M as 2610 is to 2611.

That example is there calculated to be correctly $M = 125328$. By the approximation there given it is 12960. By the formula now presented it is $M = \frac{1}{2} s k d' = \frac{1}{2} \times 4 \times 72 \times 87 = 12528$.

This error of using the external instead of the internal depth is a common one in standard works. For instance, in the formula quoted above from Tate's *Strength of Materials*, the d representing the total depth should have been d' representing the interior depth.

But to obtain something like the correct value of M for the whole section of the beam, use the following formula:—

$$M = s d' \left(\frac{k}{2} + \frac{k'}{6} \right)$$

Where k is the total area of both flanges taken right across, k' is the area of the web taken only between flanges, and d' is the distance between flanges.

DONFAGAY.

PERFORMANCE OF THE "WARRIOR."

(To the Editor of the ARTIZAN.)

SIR,—Knowing the interest you take in everything that is connected with steamships, it needs no apology from me to draw your attention to a very important feature connected with the trials of the *Warrior* and *Revenge*, which I think would be well worth careful scientific investigation. You are well aware that when a screw ship is under a press of canvas, and the engines at full work, with a common two-bladed screw, a heavy thump is felt, given by or to the screw at each half revolution, and I am not aware that anyone hitherto has been able to account for this, or to the effect it has on the speed of the ship; and, as the late trials of the *Warrior* and *Revenge* have shown that the *Warrior*, when under sail and steam, with strong wind on the beam, had considerably greater advantage over the *Revenge* than under any other circumstances, it would be very important to ascertain to what this great advantage is due. My opinion is (and which opinion is further confirmed by Capt. Bensuson, of the steamship *Melbourne*; a copy of whose letter is hereto appended), that it is in consequence of the *Revenge* having a common two-bladed screw, which is wide at points of the blades and straight out at right angles with the shaft. Now the *Warrior* has one of my last improved two-bladed screws, which is wide at root and narrow at points of blades, also having the points of blades (commencing at half their length) bent forward towards ship; now, as both the *Revenge* and *Warrior* were propelled by the canvas as well as their engines, which would cause considerably more eddy water in the wake of the ship, which eddy strikes the forward side of the screw when in a horizontal position, and thus counteracts the effect of the screw to a considerable extent; but, in the *Warrior*, this action is partially, if not entirely avoided, the points of the blades of her screw being only about one-fourth the width of those in the screw of the *Revenge*, and being bent forward, the eddy water strikes on the after or propelling face of the blades, and this assists to propel the ship instead of retarding her.

I need not here mention what every screw ship engineer has noticed, that when a screw ship under canvas has a strong fair wind, the action of the eddy water on the screw takes off the thrust from the screw-shaft at every revolution of the screw; and also that all ordinary screws that have been much used on ships that carry canvass, the forward side on the leading edge of the blades soon gets worn honeycombed by the action of the water, while the after or propelling side will scarcely have the paint worn off.

I am sir, your most obedient servant,
November 21, 1861. ROBERT GRIFFITHS.

London, Nov., 1861.

MY DEAR SIR,—Having returned with the *Melbourne* from Odessa, you will be doubtless glad to hear how the screw has answered. I will therefore tell you as briefly as possible my experience of it. In steaming in smooth water it gave about half a knot more speed than the old screw with which we were previously fitted; but its advantages were strikingly manifest under three different circumstances: 1st. When light, and pitching propeller out of the water, it obviated that dangerous racking of the engines to a very great extent. 2nd. When steaming against head winds and seas, it held the ship firmly to her work, and produced a mean speed of about one and a-half to two knots per hour over the old screw; and lastly, when steaming and sailing with a strong fair wind, and ship going very fast through the water, that heavy thump (which I believe was caused by the fore part of the upper blade striking the dead water) was not felt at all and, as far as I could judge, the speed of the ship was considerably increased. This, I think, is a very important feature, for I am sure, from long observation, that after a ship exceeds eleven knots per hour with a strong fair wind, the upper broad part of the old screw catches the dead water, and absolutely retards the ship to a greater or less extent. I will only add that altogether your propeller has fully come up to all I expected from it, and with best wishes for your continued success with it,

I am, faithfully yours,
ROBERT GRIFFITHS, Esq. H. T. BENSON.

CRITICISM ON "PRACTICAL PAPERS FOR PRACTICAL MEN."

PAPER No. I.

To the Editor of THE ARTIZAN.

SIR,—In the above-mentioned paper the expression $\frac{1}{2} s k d$ is substituted for $\frac{1}{2} s k d'$ for the value of M in flanged girders, neglecting the web in the calculation. Where is the prescribed formula to be found? I have turned over all my little library in search of it, but I can find nothing like it. Mr. Tate does indeed give a formula of the same appearance, $M = \frac{1}{2} S K d$; but it is as an approximation applicable only to hollow square beams. But this formula is one which errs in excess and not in defect, as does the formula which has been condemned; it cannot therefore be the formula aimed at in the paper referred to. The author of that paper aims at producing a simple expression for the value of

$$\frac{S}{h} \cdot \frac{b}{12} (d^3 - d'^3),$$

and he proposes to use this expression when found as an approximation to the strength of a girder when the web is neglected in the calculation. The expression arrived at is $\frac{1}{2} s k d$, and it is dubbed a *new* formula; but I can see nothing new in it. It is the common approximation to the strength of the flanges, and contains a very common error: it multiplies $\frac{1}{2} s k$ by the total depth, instead of by the depth within the flanges. He does come half way when he proposes to take the distance between the centres of gravity of the two flanges instead of the total depth; but that is only guessing, for there is no principle which points to the distance between the centres of gravity, as the proper depth to be taken.

Let us return to

$$M = \frac{s}{h} \cdot \frac{b}{12} (d^3 - d'^3)$$

Let $d = d' + x$, and $h = \frac{d' + x}{2}$, then

$$M = s b \left(\frac{x d'}{2} + \frac{x^3}{6 (d' + x)} \right)$$

Substitute k for $b x$.

$$M = \frac{S k d'}{2} \left(1 + \frac{x^2}{3 d d'} \right)$$

REVIEWS AND NOTICES OF NEW BOOKS.

The Popular Science Review; a Quarterly Miscellany of Entertaining and Instructive Articles on Scientific Subjects. Edited by JAMES SAMUELSON. London: Robert Hardwicke, Piccadilly.

We have received the first number, which contains some exceedingly interesting papers, such as that by Professor Robert Hunt on Iron and Steel; Professor Ansted on Artificial Light, &c.

This new candidate for public favour is admirably got up, and, we believe, will meet with that very extensive support which it so fully merits.

The Electrician: a Weekly Journal of Telegraphy, Electricity, and Applied Chemistry. Thos. Piper, Paternoster-row. Published weekly, price 6d.

The numbers of this weekly publication which have appeared, contain a vast amount of useful information connected with electro-telegraphy and other subjects connected therewith; and it bids fair to very usefully fulfil an important office in affording a medium through its columns for the ready interchange of scientific practical opinions upon those highly important branches of science which are every day becoming more extensively useful.

NOTICES TO CORRESPONDENTS.

L. G. (Britton Ferry).—On carefully examining the tracing sent by you, two defects are apparent; your bars are too close to the boiler, and there is not sufficient space for perfect combustion; the bridge too, should have greater vertical depth of clear opening. The plate over the fire is too thick. Feed at the end furthest from the fire, or at some point between the bridge and the far end. You should endeavour to collect the solid matter contained in the water, and prevent its being deposited on the plate over the furnace.

J. W., JUN. (Queenstown).—The weight of cast iron ballast required to fill the space would be, as nearly as possible, 74 tons and 24lbs.

LL.D.—You will find the particulars of the *Warrior's* trials in the present number. The average of six runs gave 14'354 knots, with the revolutions varying from 53½ to 55, and working with ten boilers. When reduced to six boilers, the mean of four runs gave 12'174 knots, the revolutions varying from 44 to 45. With four boilers only, the average of two runs gave 11'040 knots, and revolutions reduced to 38.

F. G., &c.—The *Octavia* has been tried. The *Arethusa* is not yet ready; nor has the *Constance* yet been tried. The mean of six runs gave 12'251 knots, with from 68½ to 70 revolutions, the *Octavia* working full boiler power; but when at half boiler power, her speed was 9'896 knots, her revolutions varying from 50 to 56.

A. S. H. (Derby), will be answered by post.

M. ALCOCK (Salford).—Thanks for the note and the tracing enclosed; the letter from the Department is a sort of stereotype form in common use, and unless an inventor has sufficient application and determination, it is usually sufficient to effect the object desired by the Select Committee, namely, to prevent their being troubled any further. It is, however, but fair to state that the same plan had long before been submitted; we believe as far back as 1836 or 1837.

J. AND OTHERS.—We have a series of Locomotive plates in hand, which will be given early next year.

D.—The experiment to which you refer was tried on the river Irwell, about Dec. 16th or 17th, 1860. Forward your address, and we will endeavour to obtain the particulars as to the size of the steam boat, power employed, the speed, &c.

M. C. (Pately Bridge).—Replied to by post.

F.R.G.S.—Mr. Edwin Clark assures us that you are entirely misinformed as to there having been any failure of the hydraulic lift at the Victoria Docks, and that only some damage to the floating pontoon, and some other minor mischief, has occurred during the whole period of its erection and use there.

X. C.—We do not know anything of the invention; there is a patent by Mr. J. F. Datchy for an improved condenser and steam regenerator; we know nothing of its operation.

B. (Liverpool).—Thanks; you will see we have used the information.

D.—Apply to the Secretary of the National Lifeboat Association, 14, John-street, Adelphi.

Loco.—The weight of Mr. McConnell's new express passenger engine, with 7ft. 6in. driving wheels, is 33 tons, having 9 tons on the trailing, 13 tons on the driving, and 11 tons on the leading wheels. The Great Northern express engines weigh 34 tons, 10 cwt. Both engines have the same length of wheel base, but the former has about 150 square feet of additional heating surface, 1½ square feet more fire grate area, 11½ feet less length of tubes, which are of ¼ of an inch lesser diameter; the cylinders are an inch larger in diameter and two inches longer stroke.

X.—The New Dover Mail Packets *Victoria* and *Eugenie* have been tested several times, and the results noted. They have also been running on the station in ordinary work. The *Victoria*, by Samuda, with engines by Penn, performed splendidly. Her trial speed, the mean of four runs, gave 16'525 knots, with 220 nominal horse power, working up to about 1699 indicated horse power, her displacement being 450 tons, everything being then, and ever since, in excellent order. Of the *Eugenie* we can say but little, but think they are very short of boiler power.

Z.—We can recommend the *Elementary Treatise on Physics*, of Professor Garnot, by Dr. E. Atkinson, published by Ballière, Regent-street.

TYRO, "YOUNG ENGINEER."—D.M. and several others, will, on furnishing their addresses, be answered by post.

RECENT LEGAL DECISIONS

AFFECTING THE ARTS, MANUFACTURES, INVENTIONS, &c.

UNDER this heading we propose giving a succinct summary of such decisions and other proceedings of the Courts of Law, during the preceding month, as may have a distinct and practical bearing on the various departments treated of in our Journal: selecting those cases only which offer some point either of novelty, or of useful application to the manufacturer, the inventor, or the usually—in the intelligence of law matters, at least—less experienced artisan. With this object in view, we shall endeavour, as much as possible, to divest our remarks of all legal technicalities, and to present the substance of those decisions to our readers in a plain, familiar, and intelligible shape.

MESSRS. COTTAM v. METROPOLITAN RAILWAY COMPANY.—This was an inquiry under the Lands Clauses Act, before a special jury, at the Sheriff's Court, Red Lion Square, Serjeant Hayes, assessor. The claim was for damage occasioned by the formation of the railway, in tunnel, under the roadway in front of the claimant's premises in the York-road, Battle-bridge. The claim was £869 for damage, and £300 for loss and inconvenience during the period of restoration of wall, &c. The claimants took the plot of land in question in the year 1856, on lease, for ninety-eight years, at a yearly rent of £130; and in the year 1857 they enclosed it with a brick wall 15ft. in height. This wall was erected extra thick, so as to be afterwards continued upwards for three stories of workshops, but up to the present time the workshops had not been commenced. Evidence was given for the claimant that in July, 1860, indications of settlement were observed in the wall next the York-road, and also to the extent of 15ft. in the return wall next Edward-street (this was just after the railway had been formed under the York-road in front of the premises); these indications continued to increase until the end of October, 1861, when on examination it was found that the front wall had declined from the upright towards the York-road 1½ in., and that in the return wall next Edward-street there were two cracks, together of the width of ¼ in., opening towards the York-road. Evidence was also given for the claimant that now, before any kind of building could be erected, it would be necessary to take down the wall next the York-road, and about 15ft. of the return road next Edward-street, to excavate for and continue the foundations of these walls down to the level of the bottom of the railway tunnel, and then to rebuild these walls from that level, of increased thickness; and that the expense of this would be £869. For the Company, it was maintained that Messrs. Cottam had no right to the maintenance of the soil of the roadway, the wall being a modern erection; that the subsidence was occasioned by the heavy wall erected at the extreme edge of their land; and that the soil would not have subsided if the said wall had not been erected. The jury found a verdict for the defendants, on the ground that the soil would not have sunk if the wall had not been erected by the claimants.

NOTES AND NOVELTIES.

OUR "NOTES AND NOVELTIES" DEPARTMENT.—A SUGGESTION TO OUR READERS.

We have received many letters from correspondents, both at home and abroad, thanking us for that portion of this Journal in which, under the title of "Notes and Novelties," we present our readers with an epitome of such of the "events of the month preceding" as may in some way affect their interests, so far as their interests are connected with any of the subjects upon which this Journal treats. This epitome, in its preparation, necessitates the expenditure of much time and labour; and as we desire to make it as perfect as possible, more especially with a view of benefiting those of our engineering brethren who reside abroad, we venture to make a suggestion to our subscribers, from which, if acted upon, we shall derive considerable assistance. It is to the effect that we shall be happy to receive local news of interest from all who have the leisure to collect and forward it to us. Those who cannot afford the time to do this would greatly assist our efforts by sending us local newspapers containing articles on, or notices of, any facts connected with Railways, Telegraphs, Harbours, Docks, Canals, Bridges, Military Engineering, Marine Engineering, Shipbuilding, Boilers, Furnaces, Smoke Prevention Chemistry as applied to the Industrial Arts, Gas and Water Works, Mining, Metallurgy, &c. To save time, all communications for this department should be addressed "19, Salisbury-street, Adelphi, London, W.C." and be forwarded, as early in the month as possible, to the Editor.

MISCELLANEOUS.

THE ASTRONOMER, Otto Struve, has received the sum of 125,000*fr.* from the Emperor of Russia to construct a permanent observatory on the summit of Mount Ararat.

THE LIME LIGHT.—Now that the lime light at the South Foreland has been for some time in operation, some of its valuable characteristics are attracting attention. The most important of these is its non-liability to be blown out by wind, even when entirely unprotected by glass, as has already been referred to by us in our October number. It may be stated that the electric light between charcoal poles, whether produced by ordinary voltaic means or the magneto-electric machine, does not possess this property, being extinguished by a puff of wind as readily as a candle. Another valuable property of the lime light is its power of burning as well under water as in the air; all that is necessary is to cover the lime wicks with a bell glass, closed at the top, so as to prevent the actual contact of the water with the lime, and the apparatus can be lowered into water without in the least interfering with the brilliancy of the light. Air is not necessary for the burning of this light, as it is for that of most others, the mixed gases containing within themselves the necessary elements both for burning and for the support of combustion; whilst the sole products of combustion being the vapour of water, this would condense and run down the sides of the glass. There would be no permanent gas to escape, and consequently the light might be lowered to the bottom of the clearest lake without the transparency of the subjacent water being in the least degree disturbed by the rising and breaking of air bubbles at the surface.

WATER AS A FUEL.—Attention has recently been drawn to the use of water as a fuel. The employment of its vapour has already been utilised in metallurgy, as an agent of oxidation in the roasting of certain minerals, particularly to facilitate the separation of arsenic and antimony compounds in metallic sulphures. For several years attempts have been made to employ the calorific power of the hydrogen contained in water; and it is the same line of invention that Messrs. Maire and Voller have sought to utilise as a combustible in industrial furnaces, and particularly in metallurgic operations. Water, fed in a regulated and intermittent manner into a hot fire, is decomposed into oxygen and hydrogen. The former gas unites instantly with the carbon, and the hydrogen, burning in presence of atmospheric air, produces a considerable heat in addition to that of the principal combustible. There results, then, a considerable augmentation of calorific without any addition of combustible, and consequently a more rapid fusion of metals and materials, and an economy of fuel which the authors of the process state varies from 40 to 50 per cent. Experiments and calculations have demonstrated that the heat absorbed by the decomposition of water is less than that furnished by the combustion of the gaseous products of the decomposed water.

IMPORTANT LIFEBOAT SERVICES.—During the fearful gales of the 2nd and 13th ult. the lifeboats of the National Lifeboat Institution have been providentially the means of rescuing the following numerous shipwrecked crews from an inevitable and appalling death:—Lugger *Saucy Lass*, of Lowestoft, 11; schooner *Fly*, of Whitby, saved vessel and crew of 4 hands; smack *Adventure*, of Harwich, 10; pilot cutter *Whim*, of Lowestoft, 7; barque *Undaunted*, of Aberdeen, 11; brig *Lively*, of Clay, Norfolk, 5; barque *Robert Watson*, of Sunderland, 5; schooner *Anchimeruoe*, of Grangemouth, 6; and schooner *Friends*, of Lynn, 4; total 63,—making an aggregate total of two hundred and seventy persons rescued from a watery grave by the lifeboats of the Institution during the present year alone. It is gratifying to know that the whole cost of some of these lifeboats, which have thus rendered such important service to the cause of humanity was presented by benevolent persons to the Society. The National Lifeboat Institution has now a fleet of nearly one hundred and twenty lifeboats under its management, which require a large and increasing amount to keep them in a state of efficiency and ready for instantaneous use, either by day or night.

NEW RUDDER.—Mr. Wm. Hewitt, of Bristol, has invented a new description of rudder for steering vessels, which embraces several features, and is intended to supersede the old fashioned principle. In dispensing with the rudder in present use, the inventor finds it necessary to employ two instead of one, which he proposes to fix at a convenient distance each side of the stern-post, according as circumstances would dictate. The following are some of the advantages it possesses. First, being placed below the water-line, it is both protected and out of reach of an enemy's shot. Second: It can be worked either from the engine-room, cabin, or deck. Third: It is under the perfect control of one man in moderate weather, and would not require more than two in the most tempestuous. Fourth: As it dispenses with all frame work beyond the stern post, screw vessels would work with greater freedom, and attain a higher rate of speed. Fifth: It is constructed on a good, sound mechanical principle, and its liability to disarrangements rendered very improvable.

THE EFFECT OF EXTREME PRESSURE OF WATER.—The following experiments upon the effects of a pressure of three tons on the square inch upon water in hydraulic pipes or tanks are important, as bearing upon the correctness of the tests from insulation on covered telegraphic wires.—First experiment—Temperature of water in the well of the hydraulic pump, 62°; temperature of the hydraulic pipe, containing the insulated wire, externally, 64°; temperature of water forced from the well into the pipe, after the application of pressure (three tons per square inch), 76°. Second experiment, 8 p.m.—Temperature of water in well, 65°; temperature of pipes, 60°; temperature under pressure, 76°. Third experiment, 7 a.m.—Temperature of water in well, 62°; of water left in pipes overnight, 61°; temperature of pipes externally, 56°5'; temperature of water after pressure, 70°. It appears from a work published in the early part of the present century, that the Florentine academicians filled a globe of gold with water; this they compressed with a very violent force, and the act of compression was found to have considerably heated the water.

AN ELECTRIC SPARK OF INDUCTION, produced by Ruhmkorff's great machine at Paris, has pierced through a plate of crown glass nearly 2in. thick, and another about 1½in. thick. These plates were recently laid before the Academy of Sciences by M. Faye, who stated that such thick plates had never before been pierced by the spark of induction. The holes were fine, and of a somewhat spiral form. There was no trace of fusion or of metallic deposit; and M. Ruhmkorff added that an energetic compression of the substance of the glass appeared to have accompanied the passage of the spark.

ANCIENT WATER PIPES.—The workmen engaged in excavating for the extension of the common sewer in Newport, Isle of Wight, have discovered the wooden pipes which were laid down in the reign of King James I., for the purpose of bringing water to Newport. These pipes, the trunks of elm trees hollowed out, have been buried above 240 years, and some of them appear to be sound now.

BRICKMAKING EXTRAORDINARY.—The following is a description of an improved patent brickmaking machine, which fills successive groups of moulds with tempered clay, half dry; it compresses the clay into the moulds by a double eccentric; it shaves off the surplus clay, which is thrown back by the eccentric. The group of filled moulds is discharged by the machine, and inverted by hand in an instant; a spring receiver is run underneath, and the whole group of moulds is instantly delivered on to it by a quarter turn of a small pinion. "By a calculation of the working power of the machine, and taking each group of moulds at thirty bricks, it is capable of moulding 360 bricks every minute, allowing the 4-horse power engine to make but forty revolutions per minute; 360 per minute are 21,600 per hour, or 216,000 in ten hours. The facility with which the bricks are taken away in groups, and stacked in stoves to be dried in eighteen hours by steam heat, or stacked in the open air to be dried in four days, without regard to weather, is equally to be admired, as the production of so large a number; for every single brick has its top, bottom, sides, and ends equally exposed to the heat. The mode of obtaining a full and constant supply of clay to keep the largest sized machine in constant work, and the mode of tempering that large supply preparatory to moulding, are not less ingenious and efficient than the construction of the machine itself. The machines can be made to produce any required daily quantity of bricks, from 20,000 to 300,000. The estimated expenses for cost of clay near London, grinding and tempering clay, moulding and drying bricks, fuel for burning, packing and discharging kilns or clamps, is 10s. per 1000 best stock bricks. The patentee (Mr. W. Morris, C.E., of Lambeth-works), states that he has experimentally tested all the parts of this small though efficient machine, and that £5000 is quite sufficient capital to fit up and work one machine, capable of producing 200,000 bricks per day, ready for sale."

NAVAL ENGINEERING.

THE "BLACK PRINCE."—This screw iron-plated frigate made the first trial of her speed at the measured mile in Stokes' Bay on the 19th ult. The *Black Prince* has not of course, got her weights on board, and at present is only rigged with fore and mizen jury masts. The result of the trial was in every respect satisfactory, the machinery and boilers working well. The ship made four runs at the mile, and realised a speed of 14'400 knots. This can only be regarded as a preliminary trial, which does not indicate the real speed of the ship, inasmuch as there were many things which combined to retard

her speed. These obstacles, however, will be removed in the future, and there appears to be every reason to suppose that the *Black Prince*, when fitted out for sea with all her weights on board, will equal, if not surpass, the speed of the *Warrior*. The dimensions of the *Black Prince* are as follow:—Extreme length, 419ft.; breadth, 53ft.; depth, 41½ft. Her tonnage is 6173 tons; her lowest draft of water, when ready for sea, was 26ft. aft and 25ft. forward, at which depth her displacement is nearly 9000 tons. She has no external keel, but an inner kind of girder which acts as keelson. To these are bolted the ribs—massive wrought-iron T-shaped beams, one inch thick, and made in joints five feet long by two deep. Below the water-mark their depth is diminished so as to form a ledge, on which the armour-plates rest. These immense ribs, except where the port-holes intervene, are only 22in. apart. Along the whole length of the ship, from stem to stern, are five diagonal bands of iron, tying every rib and girder together with the solidity of one piece. The orlop deck is of wood, and 24ft. above the keel. The main deck is of iron, cased with wood, and 9ft. above the orlop. The upper deck is also of wrought-iron, cased with wood, and 9ft. 6in. above the main. All those decks are carried on decks of the most massive kind, and the skin of the outside, which covers all, is likewise of wrought iron 1½in. thick under the beam to nearly 1in. thick up to the upper deck. Outside all, for a length of 220ft. along the port line, and extending 5ft. below the water-line, comes the lining of 22in. of teak, and the armour-plates of 4½in. thick of iron. The engines, like those of the *Warrior*, are by Penn and Sons, and of 1250-nominal horse power. She is intended to carry 40 guns, and, as at present arranged, only six of these will be breech-loaders. The main deck will be armed with thirty-four 95 cwt. 68-pounders; the upper, or spar deck, with four 40-pounders, and two pivot guns of 100lb., all Armstrongs. The main ports are 3ft. 6in. high, but only 2ft. wide instead of 4ft., as they were at first intended to be, and the lowest edge of the port hole will be 9ft. 6in. above the water, even at the greatest immersion of the vessel. To counteract the rolling as much as possible, she has four beams, about 2½ft. deep, extending two on each side, almost the entire length of the ship's bottom, and if these are not found to answer the purpose of checking her lateral motion, it will, of course, be easy to add to the breadth to any extent that may be required.

THE "ROSARIO," 11 screw steam sloop, 150 H.P., 673 tons, left Sheerness Harbour on the 18th ult., and proceeded to the measured mile for the purpose of testing her speed and machinery. The trial was attended with very satisfactory results, viz., speed, 9½; revolutions, 96; pressure of steam, 20; and vacuum, 25. The *Rosario* is fitted with Griffith's screw, the pitch of which is 14ft., and diameter 10ft. Her draught of water forward is 13ft. 10in.; aft, 14ft. 2in.

THE "ROYAL OAK," 51.—A very great improvement in the construction of the stern portion of this iron-plated screw steamer has been introduced by the Controller of the Navy, in the abolition of the aperture between the stern and rudder post, for elevating the screw. Instead of the opening hitherto found on board screw steamers, the *Royal Oak* will be furnished with a smaller circular well aperture, which will only admit of the screw being raised as high as the main deck. This alteration will add considerably to the strength of the after portion of the frigate, and, at the same time, will admit of the abolition of the "yoke" to the rudder post and the substitution of the straight tiller, this of itself being no slight improvement.

THE "ARETHUSA," a late sailing vessel new screw frigate, 51 guns, after being lengthened from 40 to 50ft. amidships has been taken into the fitting basin at Sheerness, for the purpose of having her machinery put in and fitted by Messrs. Penn and Sons, the contractors, with surface condensing engines.

THE PRUSSIAN NAVY, 1861.—The Admiralty is the supreme authority, and is divided in the administration and in the chief command of the navy; the former is divided again in a division for technical matters, and another for matters relating to the administration. The Admiralty resides at Berlin. The inferior authorities are:—1. At Dantzic; Harbour, Intendancy of the Baltic navy station, battalion of marines, command of the navy reserves and "Seewehr." 2. At Stralsund; Depot. 3. At Berlin; Institute for cadets. 4. At Oldenburg; Commissariat of the Admiralty. 5. At Heppens; Commission for harbour building, and cash for the Zede (north-east) station. The navy consists, as in England, of a body of sailors, a body of artizans (for the building-yards), and a battalion of marines. To the body of sailors belong 113 officers and cadets (1 admiral, 1 contre-admiral, 10 captains, 46 lieutenants, 40 cadets), 1168 sailors and boys. The second body is composed of 36 deck officers, viz., 67 engineers and stokers, 279 carpenters, &c., 18 assistants for lazarettoes, 16 tailors, shoemakers, &c. The battalion of marines is composed of infantry, artillery, and staff guards, viz., 34 officers, 595 foot soldiers, 296 artillerymen, 18 staff-guards, 17 physicians, and, in time of war, the "Seewehr" (like the "Landwehr" in the army). The ships composing the navy are, inclusive of 4 gun vessels, and 4 corvettes now building: 1. Steamships:—4 screw corvettes, *Arcona*, *Gazelle*, *Vineta*, and *Hurtha*, each 28 guns; 2 screw corvettes, each 17 guns; 1 paddle corvette, *Dantzig*, 12 guns; 8 gun vessels, each 3 guns and 80 H.P.; 15 gunboats, each 2 guns, and 60 H.P.; 1 paddle steamer, *Loreley*, 2 guns; 1 screw steamer, *Grille* (Royal yacht); 2 steam tugs, *Royal Victoria* and *Greif*, making a total of 34 steamships, carrying 214 guns. 2. Sailing ships:—2 frigates, *Gefion*, 48 guns; *Thetis*, 38 guns; 1 corvette, *Amazona*, 12 guns; 1 guard ship, *Barbarossa*, 9 guns; 1 brig, *Hela*, 6 guns; 1 schooner, *Frauenlob*, 1 gun; 2 transport ships, *Merkur*, 6 guns, and *Elbe*, 12 guns; 2 small vessels, *Fetis* and *Leopard*, making a total of 10 sailing ships, carrying 132 guns. 3. Rowing vessels:—36 sloops, each 2 guns; 4 jols, 1 gun; 40 rowing vessels, carrying 76 guns, making a total of 84 ships, armed by 422 guns.

THE "BAROSSA," 21, 400 H.P., screw corvette, got up steam at her moorings on the 19th ult., for the purpose of trying the improved condensers, patented by Dr. Normanby, and recently fixed on board. The trial was stated to be eminently satisfactory.

THE "LEE," gun vessel, 5 guns, 80 H.P., has been taken to the measured mile to test her machinery previous to being placed in the first division of the steam reserve. Her machinery works well. The vessel attained a speed of eight knots, although a fresh breeze and rough sea prevailed at the time. Her diameter of screw is 9ft., and her pitch 12ft. She makes 47 revolutions.

THE "LEANDER," steam frigate, 51 guns, 2760 tons, recently converted from a 50-gun sailing frigate, and lengthened amidships 44ft., and fitted with Messrs. Bolton and Watt's horizontal engines, with patent expansion gear, 400 H.P., left Sheerness and proceeded to the measured mile off Maplin Sands, for the trial of her machinery previous to its being passed over to the Government authorities. The trial was very successful, the results exceeding the expectations of the builders. They are as follows:—Average speed with full boiler power, 1'633 knots per hour; revolutions, 61; pressure of steam, 20lb.; vacuum, 26; the diameter of screw (Griffith's) being 17ft.; pitch, 24ft.; draught of water aft, 20ft.; forward, 16ft. 3in. The half-circle was accomplished in 4 minutes, and full circle in 6 minutes 45 seconds.

NAVAL APPOINTMENTS.—The following have taken place since our last:—S. Stephens Chief Engineer, to the *Orpheus*; J. H. Adams, Engineer, to the *Orpheus*; G. M. Dooley Acting Engineer, to the *Asia*, for the *Jasper*; T. Ball, First-class Assist. Engineer, to the *Indus*, for charge of the machinery of the *Delight*; J. H. Vickery, First-class Assist. Engineer, to the *Orpheus*; A. Watt, First-class Assist. Engineer, to the *Cumberland*, for the *Griper*; T. F. P. Shelley, Second-class Assist. Engineer, confirmed in the *Nep tune*; W. Adamson, Second-class Assist. Engineer, and E. J. Miller, Second-class Assist. Engineer, to the *Orpheus*; J. Warren, Acting Second-class Assist. Engineer, to the

Indus: W. Stowe, to Engineer in the *Plover*; W. N. Covey, Chief Engineer, to the *Cumberland*, for the *Orion*; J. Turner, Second-class Assist. Engineer, confirmed in the *Ariadne*; J. Woodton, Second-class Assist. Engineer, to the *Immortalité*; J. Boulton, Second-class Assist. Engineer, confirmed in the *Doris*; E. H. Willey, Second-class Assist. Engineer, confirmed in the *Revenge*; M. J. Sbanon, Acting Second-class Assist. Engineer, borne in the *Indus*, for the *Avon*; C. F. Gregory, Acting Second-class Assist. Engineer, in the *Ajax*, allowed to change ships; W. M. Cbambers, Acting Chief Engineer, to be additional to the *Cumberland*, for charge of the *Pylades*; A. H. Miller, Chief Engineer, J. T. Payne, Acting Engineer, W. H. Nurse, First-class Assist. Engineer, and H. H. Small, Second-class Engineer, to the *Phaton*; G. L. Thompson, First-class Assist. Engineer to the *Indus*, as supernumerary; J. W. Shire, Acting Chief Engineer, from the *Fisgard*, to the *Indus*, as supernumerary; J. R. Johnson, Chief Engineer, to the *Indus*, for charge of the machinery of the *Gladiator*; G. Griffiths, Engineer qualified for charge, to the *Creghound*; F. Wheeler, First-class Assist. Engineer, J. Johnson, Acting First-class Assist. Engineer, and J. Beech, Second-class Assist. Engineer, to the *Creghound*; E. Crump, Chief Engineer, and T. M. Thompson, Second-class Assist. Engineer, to be additional to the *Indus* for the *Centurion*; J. H. Binns, Engineer, to the *Riflemen*, commissioned; W. Hardie, Engineer, confirmed on board the *Fisgard*; R. J. Campion, Second-class Assist. Engineer, and W. J. Forhes, Acting Second-class Assist. Engineer, to the *Riflemen*; W. T. Galdie, Acting Second-class Assist. Engineer, additional to the *Cumberland*, for the *Severn*; J. Nelson, Acting Second-class Assist. Engineer, confirmed in the *Rinaldo*; W. Watson, Assist. Engineer in the *Ariadne*, to first-class; J. H. Keane, Chief Engineer, to the *Phaton*, vice Miller, superseded; S. Harrison, First-class Assist. Engineer, vice Nurse, to the *Asia*, for hospital; M. Baird, confirmed as Second-class Engineer, in the *Shamrock*; W. Chase, in the *Fisgard*, T. Hodgson, of the *Cornwallis*, for the *Sandfly*; H. Hull, in the *Queen*, W. Tottenham, of the *Liffey*, and G. W. Rohins, in the *Sanspareil*, promoted to First-class Assist. Engineers; G. F. Sutton, in the *Nile*, T. Gray, in the *Victor Emmanuel*, and W. B. Cottum, in the *Liffey*, promoted to Acting First-class Assist. Engineers; W. Holloway, Engineer, A. Waters, Acting First-class Assist. Engineer, and W. Hadlow, Acting Second-class Assist. Engineer, to the *Swallow*, commissioned; H. R. Gair, Engineer, from the *Indus* to the *Asia*, as supernumerary; G. M. Dooley, Acting Engineer, in the *Asia*, for the *Jasper*, confirmed; J. E. Warner, confirmed as Second-class Assist. Engineer, in the *Marlborough*; J. Hancock, confirmed in the *Majestic*; G. Tucker, Chief Engineer, to the *Asia*, for the *Black Prince*; E. J. Wilson, Chief Engineer, to the *Indus*, for the *Magicienne*; J. Rohson, Chief Engineer, to the *Asia*, for the *Higflyer*; W. R. Macevoy, Acting Second-class Assist. Engineer, to the *Asia*, for the *Black Prince*.

STEAM SHIPPING.

THE "OLYMPUS," a beautifully modelled iron steamer, sister vessel to the *Atlas*, was launched from the building-yard of Mr. James Laing, at Deptford, near Sunderland, on the 18th ult. The *Olympus* is 900 tons gross register, 1200 tons hurlthen, with dimensions as follows: length between perpendiculars, 217ft.; breadth, 31ft. 6in.; depth, 18ft., and will be fitted with engines of 120 nominal H.P.

STEAMERS ON THE SEINE.—A company has been formed in Paris to place a line of gondoliers or small steamers on the river Seine, to ply from Charenton to St. Cloud, right through Paris and its suburbs, calling every seven minutes at the most frequented quays. The fare is to be 3d. per mile. The capital of the company is 1,500,000 francs.

THE "SAMPHIRE," built for the London, Chatham, and Dover Railway Company, on her official trip recently made, obtained a mean speed of 16.3 knots (or about 19½ miles) per hour. The pressure of steam was 28lb.

THE "EUGENIE."—This paddle steamer, built by Messrs. Samuelson and Co., of Hull, for the South Eastern Railway Company, recently made her official trip at the measured mile in the Humber, and exceeded by half a knot the guaranteed speed under the contract. The result of the three last runs was as follows:—First, the distance on the measured mile was run against the tide in 4 min. 1 sec.; with the tide, 3 min. 41 sec. Second, against the tide, 3 min. 41 sec.; with the tide, 3 min. 40 sec. Third, with the tide, 3 min. 33 sec.; against, 3 min. 46 sec. The average of these three runs were: first, 3 min. 51 sec., or 15.584 knots an hour; second, 3 min. 40 sec., or 16.336 knots an hour; third, 3 min. 38 sec., equal to 16.514 knots in the hour. The average of the three runs was 16.15 knots; the maximum average speed being therefore 19 statute miles an hour.

RAILWAYS.

IMPORTANT TO RAILWAY COMPANIES.—A new and ingenious invention has been discovered by Mr. Edward, Treney, of Leeds, who, for the space of twenty-five years, was connected with railways. The invention has for its object the prevention of accidents in railway tunnels, and also in foggy weather. It consists of a spiral spring, fixed underneath the foot-board of the last carriage or van. In entering a tunnel, this apparatus comes in contact with a lever connected with the danger signal, and throws up the arm, by doing which denotes danger to the approaching train. When the last carriage leaves the tunnel, the same spring knocks another lever, connected with the former, by means of a wire running through the tunnel, which causes the arm of the danger signal before mentioned to fall, which shows the tunnel to be clear, otherwise it would not be the case. In foggy weather, when the distance signals cannot be observed, a similar apparatus, fixed to the engine, rings a bell, which is placed near the driver, the arm of the danger signal being up at the same time. In addition are two lamps, fixed to the last carriage or van, which lamps revolve by means of the motion of the train, right-handed way round, showing the train to be in progressive motion; but when the lamps revolve in the opposite direction, then the train has a retrograde motion. When the train is standing, then the lamps remain fixed; consequently the driver can at once discern the motion, or otherwise, of the train. These lamps are particularly adapted to luggage trains.

NORWICH AND SPALDING.—It is proposed to apply to Parliament for an act authorizing the construction of a branch from the Norwich and Spalding at Long Sutton to Wisbech, and a tramway at Sutton-bridge. Another line is also proposed from Holbeach to join the Great Northern at Algharkirk.

LYNN AND HUNSTANTON.—The first sod of this line was turned a few days since. The project was hrought before the public in 1855, and a commencement has at length been made with the works.

THE PROPOSED WEST RING, HULL, AND GRIMSBY RAILWAY.—This line, of which the length will be 26 miles, is to commence at the Westgate Station of the Leeds and Wakefield Railway, to join the Grimsby line at Barnby Dun, and thus to open a direct communication with that port. Grimsby will then be only ten miles more distant from Wakefield than Hull is; while the former port is 20 miles nearer the German Ocean than the latter. There is also to be a communication with the projected line from Doncaster to Hull; and running arrangements are to be made with various companies, two of which are to work the new line.

NEW RAILWAY BETWEEN LONDON AND BRISTOL.—The South Western Railway Company have intimated their intention of extending their system to Bristol. The line of the Salisbury and Yeovil Railway will be extended, the course of the intended railway being direct from Gillingham to Bristol, through Wincanton, Bruton, Shepton Mallet, Radstock, and Clutton, and terminating in the New Cattle Market, Bristol. The proposed railways will put the Somersetshire coal fields in direct communication on one unbroken line with Bristol and the whole system of the Midland Railway on the one hand, and the South Western Railway and the ports on the English Channel on the other.

GREAT INDIAN PENINSULAR RAILWAY.—Messrs. Sharp, Stewart, and Co., of Manchester, are engaged upon the construction of several ten-wheel tank locomotives for working the Bmore Ghaut incline of the above railway. These engines have 20-in. cylinders, 24-in. stroke, and will weigh about 48 tons in working trim. The Bmore Ghaut incline is nearly sixteen miles long, rising on an average gradient of 1 in 43. Upwards of five consecutive miles rise, however, at the rate of 1 in 40, and nearly two miles arise at the rate of 1 in 37. The shortest curves are of 15 chains radius. Up this incline the engines are expected to take themselves, and 200 tons besides, at an average rate of 12 miles an hour. The gravity of 243 tons on an incline of 1 in 37 is 15,014lb., and the least probable resistance from friction, &c., will be, for the whole train, 13lb. per ton, or 3224lb., making 18,238lb. in all. Taking the average gradient of 1 in 48, the gravity will be 11,573lb., and the total resistance will be 14,797lb., and if this be overcome at 12 miles an hour, or 1056ft. per minute, the corresponding effort will be 443 H.P., requiring the evaporation of about 1800 gallons of water per hour, or 2400 gallons on the whole length of the incline.

MIDLAND RAILWAY.—The intended extension of this Company's line from Chesterfield to Sheffield has been surveyed, and it appears that the gradients will in no case exceed 1 in 100. By the new line, Sheffield and Chesterfield will, by railway, be only 12 miles distant, instead of 17 as heretofore, and the route from Sheffield to London will be shortened, and the changing of carriages avoided.

LONDON, CHATHAM, AND DOVER.—This Company's line has been further opened right up into Dover Harbour. This extension, although under a mile, is an important one, inasmuch as it brings the line into direct communication with the harbour, and also the Royal Mail boats that run to Calais and Ostend.

PERTH AND INVERNESS.—The foundation stone of the viaduct of the Perth and Inverness Railway, over the Divie, has been laid. The work from abutment to abutment will occupy a space of 371ft., besides 60ft. of wing wall and mound on each side. It consists of 7 arches of 45ft. span, and one of the piers will be 105ft. in height, the greatest elevation being 135ft. from the head of the river. The mason work will extend to about 10,000 cubic yards, and weigh about 20,000 tons. The estimated cost is about £10,000.

SAFETY SIGNALS FOR RAILWAY CARRIAGES.—Mr. Bazin, of Angers, has invented an apparatus, which has been tried on the Orleans line. A cord is placed within reach of the traveller, by pulling which a small ventilator is set free, and begins to rotate in virtue of the current of the train, whereby it causes a bell to ring, which gives the alarm. At the same time a coloured disc is pushed out, which shows in what carriage or compartment the alarm has been given. Once in motion, the apparatus cannot be stopped, except by the guard. Thus a traveller who might be induced to play a practical joke would be discovered by his own act. The experiment is said to have been a successful one.

BREAN DOWN HARBOUR AND RAILWAY.—A new company is being formed, called "The Brean Down Harbour and Railway and Weston-Super-Mare Landing Slip Company," the objects of which will be seen from the following quotations from a report of the Company's chief engineer:—I propose to form the harbour and to acquire the necessary shelter by the construction of a pier from 800 to 850ft. in length, run off from a point about 100yds. from the west end of Brean Down, and so designed, that about 400ft. of its length shall afford sheltered quays with from 2ft. to 25ft. depth of water at low-water spring tides, and about 400ft. with from 19ft. to 21ft. depth at low water of the same tides. As regards the connection of the harbour with the railways of the district, it is intended that a line of railway should be laid down from the outer end of the landing pier, and thence along the north side of Brean Down, until within about 600yds. of its eastern end, where the line would pass to the south side by a short tunnel of about 200yds. in length. The cost of the harbour, and a single line of railway to connect with the Bristol and Exeter line, near the River Axe Bridge—a distance of from ¼ to 5 miles—including all works and land, but without preliminary expenses, is estimated at £105,000.

RAILWAY ACCIDENTS.

ACCIDENT ON THE LANCASHIRE AND YORKSHIRE RAILWAY.—An accident occurred on the Lancashire and Yorkshire Railway, near Bury, on the 8th ult. The 12.15 train from Rochdale to Liverpool is due at Bury at 12.35 p.m. On the day mentioned it consisted of three carriages and the engine, a large third-class carriage being nearest the engine. On approaching the goods station at Bury, from some unexplained cause the third-class carriage got off the rails at one of the numerous points, and the two end carriages ran on one line of rails and the engine on another. After running about eighteen or twenty yards, the third-class carriage was dragged across the rails, and came down with a crash, wrenching off its wheels, tearing up the rails, and smashing the buffers and panels of the next carriage. The passengers in the third-class carriage were much injured.

COLLISION ON THE GREENWICH RAILWAY.—On the night of the 4th ult., a collision, fortunately unattended with fatal results, occurred on the above line of railway between a passenger train and a cattle train. It appears that on Monday evenings it is usual to despatch a cattle train from the Bricklayers' Arms station to proceed from thence by the North Kent line to Woolwich. The down line of rails is used both for this and the Greenwich traffic as far as the junction, about half a mile from New-cross. The cattle train had reached this part of the main line, when, from some unexplained reason, the 8.5 p.m. train was allowed to follow so closely upon it that, although but a few hundred yards had to be traversed before the cattle train would have been shunted on to the North Kent line, the former ran into the latter with considerable violence, causing the traffic to be stopped for about two hours. Several of the passengers, owing to the violence of the shock, were thrown from their seats, and sustained more or less personal injury.

ACCIDENT ON THE WAKEFIELD AND BARNSELY RAILWAY.—On the morning of the 5th ult., an accident occurred on the line of railway between Wakefield and Barnsley, which is a branch of the Lancashire and Yorkshire Railway. There was a coal train on the line, the driver of which was named Sutcliffe, his stoker being his son, named George Sutcliffe. When near the Darton station, and engaged in shunting, another luggage train came up, and, in consequence of some misconception (a misunderstanding of the signals), a collision occurred. The engine of the coal train was thrown off the line and very much damaged; and Sutcliffe, the driver of the coal train was killed, his head being cut off from his body. The son (the stoker) also met with a serious but not a fatal accident. Before the collision took place he saw the danger impending, and he attempted to jump from the engine over a wall about five feet high. He failed, however, and falling he too was caught by the engine, which very seriously crushed and broke the bones of both his feet.

PREVENTION OF RAILWAY ACCIDENTS FROM COLLISION.—An apparatus for preventing carriages leaving the lines of rails has lately been brought forward by Mr. F. Koessler. It consists in the application of an extra line or extra lines of rails, placed parallel with the ordinary rails, of a suitable form so that guard clips will pass along such rails without, however, being in contact therewith. These extra rails, if there are two, are placed by preference just within the ordinary rails; but they may be outside if desired. The clipping or holding part of the rails are disposed in opposite directions to each other, so as to embrace the clips on the carriages, or the reverse may be the case, and the carriage clips arranged to embrace the rails. In either case the carriage clips consist of strong

rigid iron supports depending from the carriage or engine framework, the terminations of which are furnished with parts to clip or pass underneath the flange, or rib of the extra safety-rail; these supports are also furnished with shoe pieces or surfaces, which are adapted to slide on the rail, and support the carriage in the event of the wheel coming off or breaking. Both this shoe and the clip embracing the safety-rail flange are so adjusted that they travel in close proximity to the rail, but without touching. Instead of two safety-rails one only need be applied, and placed midway between the ordinary rails. The head of this mid-rail he makes in a T-form, each side of which the carriage clip embraces. These clipping pieces also form safety supports for the carriages from the mid-rail. Within two safety rails he employs four (or more) clips, one at each angle of the carriage, while for the mid-rail one double one at each end of the carriage is sufficient. According to this arrangement it is impossible that the engine or carriages can run off the line unless the embracing or safety-clips are torn away, which must be sufficiently strong to afford necessary resistance. In using the mid-safety rail to prevent the engine or carriages getting off the line, he furnishes the carriages with struts or shoes adapted to take a bearing on the ordinary rails in the event of a wheel or wheels coming off a carriage or breaking.

FALL OF A RAILWAY BRIDGE ON THE GREAT NORTHERN RAILWAY.—It appears that on the night of the 14th ult., the Edinburgh express train left the King's-cross Station at 9.15 p.m. for the north, and, at its usual rapid pace running through without stopping till past Huntingdon. A little beyond it had to pass over a brick bridge on what is called the Wood Walham bank, that carries the main line over a stream that intersects it between Holme and Huntingdon, at which point the engine-driver noticed, as the train swept over the bridge, an unusual oscillation of the locomotive and a sinking of the permanent way, of which, on arriving at Peterborough hard by, he instantly gave notice. Upon repairing to the spot, it was found that, owing to the recent heavy rains and floods that had occurred in the district, the abutments of the bridge had sunk from the level of the line, and that a considerable portion of the road had also got loose and out of level. The next up train to town from the north was stopped on the other side of the bridge, traffic being completely suspended. From the survey made by the officers of the company, it is considered that a new bridge will have to be built, unless engineering arrangements can be made for making the existing structure available for the conduct of the traffic, which appears to be very doubtful. The bridge has been in existence about eight or ten years, and the occurrence is, we believe, the first of its kind that has happened on the Great Northern Railway.

MILITARY ENGINEERING.

ANNUAL REPORT OF MUSKETRY.—The annual report of the Inspector-General of Musketry for the year ending March 31, 1861, which has lately been published, consists mainly of tabulated returns of the rifle training of each regiment in the service, and shows the 1st battalion 22nd Foot as the best shooting battalion of the army (it was also the best in the year 1859-60), its "figure of merit" being 51.66; and the No. 6 company of the same battalion as the best shooting company in the army, its "figure of merit" being 55.46. "The shooting of the army, as a whole, has improved," General Hay remarks; "and another year's experience proves the soundness of the system now in operation to train the various corps and battalions to the efficient use of the rifle, not only in the United Kingdom, but in the several colonies and possessions of the empire where her Majesty's troops are quartered." At the Hythe School of Musketry 176 officers, including 6 of the Irish constabulary, have undergone instruction; of which number 112, or 64 per cent., became first-class shots, and 56, or 32 per cent., second-class shots, leaving 8, or only 4 per cent., in the third class. 731 sergeants and rank and file have been instructed at Hythe, of which number 416, or 57 per cent., became first-class shots, and 292, or 40 per cent., second-class shots, leaving only 23, or 3 per cent., in the third class. 247 volunteers from different corps have been exercised at Hythe through the modified course approved for that force, of which number 133, or 54 per cent., became first-class shots, and 112, or 45 per cent., second-class shots, leaving only 2 in the third class. In all the practices that establish "the figure of merit" there was an improvement on the preceding year, with the exceptions that in file firing the volunteers came down from 11.63 to 11.26, and in skirmishing from 4.96 to 4.89. The figure of merit was, for officers, 46.24; for non-commissioned officers and privates, 44.86; for volunteers, 45.67. Last year the figure of merit was 44.18, 41.37, and 43.72 respectively. Of the 176 officers who passed through the school in 1860-1, 72 entered the first class and 43 became marksmen, making 7 points and upwards in the first class. Of the 731 sergeants and rank and file, 283 entered the first class, and 41 became marksmen. Of the 247 volunteers, 90 entered the first class, and 38 of that 90 became marksmen. The per centage of marksmen to the total number instructed is therefore—Officers, 24; sergeants and rank and file, 19; volunteers, 15. To the number of persons in the first class the per centages are respectively, 60, 49, 49. The three parties of volunteers who were at the school between May 9, 1860, and March 31, 1861, consisted of 78, 74, and 95 members respectively. The figure of merit of the first party was 45.00; the per centage of first-class shots, 47. Of the second party, the figure of merit was 47.11; the per centage of first-class shots, 45. The third party took 45.02 as their figure of merit, and gave 66 per cent. first-class shots. The figure of merit is the average of points made by all the individuals in each party in the first period (20 rounds at 150, 200, 250, and 300 yards—five rounds each), in file firing, standing, at 300 yards; in volley firing, kneeling, at 400 yards; and in skirmishing between 400 and 200 yards. First-class shots are those who, having made 12 points in the second class (20 rounds at 400, 500, 550, and 600 yards—five rounds each), are admitted to fire at 650, 700, 800, and 900 yards. Notwithstanding the general average of officers is higher than the general average of soldiers, the greatest number of points obtained by an individual at the several distances was in favour of the latter at the 200, 250, 700, 800, and 900 yds. distances, while at each of the other distances the greatest number was the same with the officers and men. In the third and first classes also, the greatest number of points obtained by an individual was in favour of the soldiers. In the second class, officers and men were equal in their highest number. The greatest average points obtained by a single "party" in the several classes was, in the third class, officers 21.13, soldiers 23.77; in the second class, officers 14.76, soldiers 10.96; in the first-class, officers 7.96, men 7.51. The conclusion is, that individual soldiers and the "parties" of soldiers have the advantage over officers at from 150 to 300 yards; that while individual officers and men are equal at 400 to 600 yards, parties of officers have a great superiority over parties of men at those distances; and that while individual men take a sensible advantage over individual officers at from 650 to 900 yards, the officers in parties have superiority of less than a half per cent. over the soldiers.

BREACH-LOADING ORDNANCE.—A large breach-loading gun, of Sir William Armstrong's construction, but having the apparatus for closing the breach arranged to work from the side, has been recently tried for quick and continued firing, by the Ordnance Select Committee. The weight of the gun was little over four tons, the shot weighing 10 lbs., and the charge used was 14 lb. The trial was made at the Woolwich proof butt, and 51 consecutive rounds were fired in 46 minutes and 16 seconds. At the end of the 15th round the shot began to pass through the butt, and the gun and carriage had in consequence to be removed to another platform, where the butt presented a sounder face. The time lost by this operation was 13 minutes and 20 seconds. At the 25th and 30th rounds a block of wood forming part of the temporary carriage used on the occasion became loose, and the time lost in securing it amounted to 11 minutes. Deducting these stoppages, which were not attributable to the gun, the time occupied in firing the 51 rounds was only 21 minutes and 56 seconds, in which time the total weight of shot discharged from the gun was upwards of 2½ tons. The average rate of firing was about 26 seconds per round, but nine consecu-

tive rounds were fired at the rate of three a minute. The escape of gas at the breech was effectually prevented.

BROWN'S ARMOUR-PLATES.—Experimental firing took place at Portsmouth on the 22nd ult., upon a sample armour-plate for the new frigate *Valiant*, manufactured by Messrs. J. Brown and Co., of the Atlas Steel and Iron Works, Sheffield, and the result showed an extraordinary power of resistance without injury to the ship's side or timber backing of the plate. The plate, 15ft. 3in. by 3ft. 3in., and 4½ in. thick, was bolted to the side of the *Java* target frigate, which was moored in the usual position in Porchester Lake. The practice took place from the 95 cwt. smooth-bore gun of the *Stork*, at 200 yards range, with the usual service charge of 16lb. of powder. The first shot struck the lower left-hand corner of the plate, between two bolt holes only 15in. apart, fracturing the plate between the two bolt holes, and indenting the plate 2in. from the surface. This being an "edge blow," no positive results could be drawn from it. Shots 2, 3, and 5, were placed close together in a vertical line at about 3ft. 6in. from the end of the plate, and, from their position, no severer test could have been applied, the three shots being in a space of 24in. by 12in. The indentations were respectively—1½ in., and 2in. No. 4 shot struck the centre of the plate, making a 2in. indentation only. The cracks from the blows were of the usual character, and the trial of the plates was considered of a very satisfactory nature.

TRIAL OF A NEW RIFLED GUN AT SOUTHPORT.—Recently a new breech-loading rifled cannon, the invention of Mr. Longridge, manufactured at the Victoria Foundry, Leeds, was tested at Southport. The ground selected was that portion of the shore known as Birkdale Point. The first round fired was a blank charge of 13lb. of powder. The gun was then charged with the same quantity of powder and a 10½ lb. conical ball. The firing of this round, however, brought the proceedings to a premature end; for on examining the piece after this discharge, it was discovered that the breech had become injured. The gun has been sent to Liverpool to have the damage repaired, and further experiments will be made. The length of the gun is nearly 12ft., with a three-grooved bore about 4in. in diameter. It will carry an 18lb. ball. The range attained with the 10½ lb. ball, at a very slight elevation, appeared to be about two miles.

TRIAL OF THE NEW GUN, "PRINCE ALFRED."—This redoubtable piece of cast iron ordnance, named in honour of Prince Alfred's visit to the Mersey Steel and Iron Works, has been so far completed as to admit of its being tested, which was done on the 19th ult. This immense gun is 12ft. long, 35in. in diameter at the breech and 15in. at the muzzle, and measures 5ft. 2in. across the trunnions. It is a chamber gun, on the Gomer principle, and is 10in. in diameter of bore, and calculated to throw a shot weighing between 600lbs. and 600lbs., and its own weight is 10 tons. The object of the experiment was to ascertain the effect of a 10in. 140-pounder shot against a target similar in construction to our floating batteries. The target was put up at a distance of 210 yds. from the point at which the gun was discharged. It was formed of oak, 18in. thick, covered with an iron plate, 4½ in. in thickness; and this target was strongly strutted and kneed, and every means were adopted to enable it to resist the impact of the shot. The ball, weighing 140lb., was impelled by a charge of 20lb. of powder. It struck just below the bull's eye, and completely carried away the target, which was driven several feet along the sands, and completely turned over. On examination the plate was found to be indented nearly 3in. by the shot, while only a slight crack was visible on its surface. At present this piece of ordnance is smooth in the bore; but it is to be rifled, after which it will be tested with the heavier shot already mentioned.

SUBSTITUTE FOR RIFLING ORDNANCE.—Lieut. Col. Parley, to avoid the rifling of smooth bore ordnance, recommends the trial of the following experiments:—The cylindrical part to be lengthened or shortened, as the shot is to be heavier or lighter, and the difference in weight to be effected by a portion of the shot being left hollow, as a shell. With such a shot, and with a proper bottom, or wadding, behind it between the shot and the charge, encircling the conical end, and in its exterior having a cylinder of the same diameter as the shot, if experiments are made it will be found that ranges of extent and correctness will be obtained superior to any that will follow from the bore being rifled. On the subject of wadding, Lieut. Col. Parley states, First, it should be of a soft elastic material, such as may be formed of wool, in a mould, with proper adhesive mixture. Secondly, it should not be attached to the shot in any other way than by fitting accurately to the conical end. Thirdly, it might be greased inside the cone to allow it to slip closer on the shot when the discharge takes place, and to separate easily afterwards, and, if formed in two halves, it would, perhaps, be preferable. Such a wadding, on the discharge, would wedge itself close between the shot and the interior cylinder of the gun; it would have all the effect of rifling in impeding the shot, and obtaining a full ignition of the charge, prevent all escape from windage, and preserve the shot in the true axis of the bore, and every following discharge would act in cleansing the bore of the gun from any fouling of the deposit of the inflamed gunpowder. The wadding should not be larger than the cone of the shot—if the sharp end is exposed, so much the better. With such a shot and wad, there would never be required a wad over the shot in naval service, as the shot would, at ramming down, be firmly wedged in the bore, and no depression of the muzzle would move it.

TELEGRAPHIC ENGINEERING.

RED SEA AND INDIA TELEGRAPH COMPANY.—At a general meeting of this company, held on the 6th ult., the Government proposals for the transfer of the line and property of the company were submitted for consideration. The chairman, after detailing the steps which had been taken subsequently to the interruption of the line, moved a resolution to the effect that the offer of the Government be accepted, with the understanding that, in the event of the annuity being redeemed, they shall pay a capital sum sufficient to purchase a Government annuity of £4 10s. per annum on each £100 of the stock or capital of the company for the unexpired residue of the term.

DOCKS, HARBOURS, CANALS, &c.

GRAVING DOCKS.—There are sixteen graving docks in Liverpool, varying in length, from 300ft. to 700ft., having a depth of water of 18ft. to 21ft. on the blocks at mean spring tides; the width of the entrances varying from 40ft. to 70ft. At Birkenhead three public graving docks are in course of construction, each 750ft. long, two having 50ft. entrances, the third an entrance of 85ft. wide. There is also another lock entrance, 400ft. long by 100ft. wide, having a depth of water at mean spring tides of 30ft. 3in.; which could also be lengthened to 500ft., and adapted for use as a graving dock at a cost of about £15,000.

THE PORT OF HULL.—In 1840 the gross tonnage of this port upon which dues were paid amounted only to 652,503; in 1852 it had reached 799,866; but in 1860 it had attained 1,215,203 tons; and while the actual steam tonnage in 1840 amounted only to 174,832, in 1852 it had reached 305,021; and in 1860 it was found to be 603,328 tons, having, within a fraction, doubled within eight years; and what was still more remarkable was that, although steam was fast taking the lead, and had so wonderfully advanced, the sailing ship tonnage had also, in a most astonishing rate, increased; for in 1840, this class of tonnage amounted to 447,676; in 1852, to 494,845; and in 1860, to no less than 611,875 tons, these figures relating only to inward tonnage.

LIVERPOOL DOCKS.—Further extension of these docks is in contemplation. The cost of the land required is estimated at £30,000, and that of the sea wall at £70,000.

FALMOUTH HARBOUR.—A joint-stock company is in the course of formation for the purpose of extending and improving the docks at Falmouth. The works are to include

a tidal harbour of 42 acres in extent, with a depth of water of 18ft. at low water spring tides; a floating dock of 14 acres area, with a depth of water of 31ft.; and five graving docks with the necessary warehouses, shops, and other conveniences.

PORTSMOUTH HARBOUR.—A plan has been recently submitted to the authorities for the improvement of the channel of entrance to this harbour, and for giving an increased area of basin accommodation. The plan is as follows: the shoals which separate Portsmouth harbour channel from the deep water at Spithead are of a nearly triangular form, the base extending from Blockhouse Fort on the west side of the mouth of Portsmouth harbour, to Port Monkton, at the east end of Stokes Bay, the apex of the triangle being near the Spit buoy, and opposite Southsea Castle. It is proposed, in the terms used in the specification, "to enclose these shoals with two tiers of whole bulk cofferdam piles, with ties and braces complete, filled in with excavations from the shoals, which would thus become of sufficient depth in the area inclosed within this piling for two basins, the one at the base of the triangle to be an inner floating basin of about 216 acres, the outer one, at the apex of the triangle, to be a tidal basin of about 125 acres." The plan includes wharfs over the piling 200ft. wide, with lines of railway on their inner and outer faces; a coaling depot on each side of the entrance at the apex of the work, each capable of holding 100,000 tons, with a lighthouse over each. The author of the plans estimates the cost at £450,000.

NEW LIGHTHOUSE FOR THE WELSH COAST.—At a recent meeting the Mersey Dock Board decided to lease a site, on the Great Ormeshead, for a new lighthouse. The cost of the edifice is to be £5000, and the annual charge for maintenance £380.

BOILER EXPLOSIONS.

THE ASSOCIATION FOR THE PREVENTION OF STEAM BOILER EXPLOSIONS.—At the last ordinary monthly meeting of the executive committee of this association, held at 41, Corporation-street, Manchester, on October 29th, 1861, W. Fairbairn, Esq., C.E., president, in the chair, the chief engineer presented his monthly report, from which we have been furnished with the following extracts:—During the past month 438 engines have been examined, and 595 boilers; 22 of the latter being examined specially, 14 internally, 43 thoroughly, and 516 externally. The following defects have been found:—Fracture, 8 (2 dangerous); corrosion, 36 (7 dangerous); safety-valves out of order, 9; water gauges ditto, 14; pressure gauges ditto, 8; blow-off cocks ditto, 54 (1 dangerous); furnaces out of shape, 2; deficiency of water, 2; over pressure, 14—total, 147 (10 dangerous); boilers without glass water gauges, 13; ditto without pressure gauges, 10; ditto without blow-off cocks, 59; ditto without feed back press valves, 93. In my last report I called attention to the application of steam-jackets to cylinders, pointing out their importance as an agent "for effecting economy in the use of steam. I now wish to allude to a kindred and equally important subject—viz., that of *superheating*, the economy derived from which has now become established by general experience, and in marine engines has, in many cases, effected as high a saving as 30 per cent. I scarcely anticipate such a result as this from its application to Lancashire mill engines; still I am confident that a very considerable saving would be effected, while, at the same time, the vacuum would be improved, the temperature in the hot wells reduced, and less injection water required, which, to steam users having cooling ponds of limited area, would be most important. These results are mainly due to the prevention of condensation and re-evaporation on the internal surface of the cylinder, as explained in my last report relative to the action of the steam-jacket; so that the effect of superheating the steam, or coating the cylinder with a steam-jacket, is very similar. The application of the jacket, however, to cylinders can only be made at the time of construction, except with considerable difficulty, while the principle of superheating can be applied to old engines as an auxiliary without alteration to the existing arrangements. The subject of superheating has been sadly bugbeared. It has been reported that the use of superheated steam would destroy the surface of the cylinder, piston, and slides, by preventing lubrication; also that it would corrode the metal; that it was highly explosive, productive of great pressure, and altogether dangerous and difficult to deal with. Actual experience, however, has proved that these objections are entirely visionary, and I have only within the last few days been assured by the superintending engineer of all the engines and boilers in the large fleet of the Peninsular and Oriental Steam Navigation Company, where superheated steam is now and has for some time past been extensively employed, that no difficulty is experienced in its use, and no alteration whatever is required in the old engines beyond the introduction of a slightly better description of packing for the glands, while not a trace of corrosion has been found. It only now remains, therefore, for the manufacturing engineers of this district to bring out a simple and efficient superheating apparatus, adapted to mill engine boilers, by which they will not only benefit themselves, but at the same time render essential service to the steam users of the district. I am glad to say that one of our members is now laying down a superheating apparatus, and, as soon as I have an opportunity of doing so, I shall be happy to state to the members of the association the results of its actual working as applied to the boilers of an ordinary mill engine, and to assist in the general introduction of this system amongst all our members by affording any other information I am able. I would state, however, in the meantime, that it is found most advantageous to superheat the steam to about 100 degrees above the temperature of plain steam, when no difficulty is found in lubricating; also that the utmost care must be taken in maintaining the temperature of the steam when once it has been superheated, or the virtue will be lost before it gets to the engine. I found in one case that although the temperature immediately on leaving the superheater was as high as 600 degrees, yet it had fallen nearly to 300 degrees on its arrival at the engine. I understand that some parties entertain the idea that superheating may be advantageously applied where steam is used for heating purposes. I am convinced, however, that such would not be the case, and that disappointment will inevitably ensue wherever superheating is adopted with this view.

MINES METALLURGY. &c

THE HINDOSTAN (Singhpooh) Copper Company has been announced, with a capital of £120,000, in shares of £5 each, for the purpose of developing important mineral and other rights in a district situated on the western bank of Soobunreeka, within 140 miles of Calcutta, where there is reported to be an abundant supply of copper ore. The prospectus contains the testimony of several mining engineers as to the value of the property, and the results likely to be derived from an energetic prosecution of the enterprise.

COAL-HEWING MACHINERY.—An invention, which relates to a mode of working minerals, whereby a saving of labour and prevention of breakage is effected, has been patented by Messrs. Ridley and Rothery, of Low Wortley and West Ardsley. According to this invention, it is proposed to hew or work seams of coal and other mineral strata, by making a narrow undercut in a horizontal or nearly horizontal direction, and also one or more narrow vertical cuts on the face of the coal or mineral; the depth of all such cuts vary according to the size of the block required; a series of holes are then drilled along the upper part of the intended block in a horizontal direction, in order to facilitate the detaching of the block. One arrangement of machinery which they propose to use for effecting the cutting operations above referred to consists of a suitable framing, mounted on wheels, and provided at the top and bottom with a horizontal transverse rocking shaft, and at the two opposite sides with similar shafts, placed in a vertical position. Each of these shafts carries one or more vibrating arms keyed thereon, and these arms are each provided at their outer free ends with a suitable cutter for acting upon the coal or other substance to be worked. A vibratory or oscillating motion is imparted to these arms by the aid of a crank and ratchet wheels, in combination with helical springs

on the shafts, the springs serving to give the necessary blow or stroke for effecting the cut, whilst the crank and ratchet-wheels return the arms to their original positions again in readiness for a fresh stroke. The entire machine is moved up to its work by a self-acting or other travelling motion.

TO DISTINGUISH IRON FROM STEEL.—One of the best known methods of distinguishing steel from iron is by treatment with nitric acid. Nitric acid causes a black spot when dropped on steel, but not when dropped on iron. M. Saint Eelne, a French chemist, has noticed a still more reliable test, which is as follows:—When an iron rod is immersed in nitric acid of ordinary strength, the acid boils about the surface of the iron. This action is continuous; but if steel be used instead of iron, this action of the acid only lasts for a few seconds, and then finally ceases. After the action of the acid has ceased, the steel is said to be in a "passive" condition, and its capability of becoming thus "passive" completely discriminates it from iron.

APPLIED CHEMISTRY.

NEW METHOD FOR THE PRODUCTION OF CHLORINE.—The process proposed by M. Laurens for the preparation of chlorine consists in decomposing chloride of copper by heat. The following is a *resumé* of the operation:—First, prepare the chloride of copper, either by dissolving the oxide of copper or the native carbonate in hydrochloric acid, or by double decomposition with sulphate of copper, chloride of barium, &c. Evaporate and crystallise the solution of chloride of copper thus obtained, mix it with sand, and dry it absolutely (probably in a reverberatory furnace). Introduce the dried mixture into retorts similar to those employed in the manufacture of gas. If these retorts are of cast iron, they should be covered with a coating of earth mixed with charcoal, to isolate the metal. The chloride, greatly heated, decomposes into chlorine and sub-chloride. The protochloride, the residuum in the preparation of chlorine, is not lost; it may be reconverted into chloride by the oxidising action of the air in presence of hydrochloric acid. The reconverted chloride is treated in the way just pointed out; and so the circle of reactions go on indefinitely. It will be seen that this process corresponds with that of M. Dunlop-Tennant. It is atmospheric oxygen which, by reproducing bichloride of copper, in this process, and binoxide of manganese in Tennant's, effects the oxidation of the hydrochloric acid. The advantages of M. Laurens' interesting reaction are the following:—A saving of half the hydrochloric acid, and regeneration of the comburant by a direct and single operation. The objections to the process are the dearth of copper and the many chances of loss of the metal, either as chloride during its decomposition, or of protochloride or chloride in some of the unavoidable removals; moreover, it is to be feared that handling large quantities of chloride of copper, the dust arising from it in a chlorine manufactory would be likely to injure the workmen's health. In any case, this interesting process is highly to be recommended for laboratories, for furnishing dry chlorine readily, without the intervention of a fragile and cumbersome apparatus.

SYNTHETIC FORMATION OF A SACCHARINE SUBSTANCE.—M. Bouleu found that when dioxymethylene is boiled with an excess of lime or baryta water the mixture, which at first is colourless, quickly becomes yellow and soon passes to an intense brownish-yellow. The odour of dioxymethylene disappears at the same time, and a smell like that of burnt sugar is produced. No gas is evolved during the reaction. When the lime water is added slowly, the mixture being kept near the boiling point, and stopping when the colouration takes place, a neutral solution is obtained, in which carbonic acid causes no precipitate. Evaporated at first on a water bath, and finishing under an air-pump receiver, a thick, yellowish, syrupy substance is obtained mixed with some crystals. Treated with absolute alcohol, the uncrystallizable substance is removed, and a white crystalline powder is left. This the author found to be formate of lime. The alcoholic solution evaporated under the air-pump left an extract smelling like syrup prepared with burnt sugar, and tasting like liquorice juice, but acid to litmus. When heated on platinum foil it behaved like saccharine substances, but left a calcareous ash. It reduced the cupro-potassic tartrate even in the cold, and instantly when heated. Like the sugar of mannite, it had no rotatory power. The solution did not appear to ferment with yeast, but as the experiment was made with a very minute quantity of the substance, the author does not consider it decisive. Bouleu made two analyses of the substance, but the results did not agree well. He considers, however, that in its composition the new substance approaches the bodies which mannite and some of its congeners furnish in losing one molecule of water, and therefore he names it provisionally *methylentane*. As the first example of the formation of a substance having many of the characteristics of a true sugar, by means of the more simple compounds of organic chemistry, the production of methylentane, says the author, is a remarkable fact. Further researches will no doubt soon enlighten us more on the subject, so we leave for the present the author's speculations on the formation of the body, and the analogies with other reactions.

ON PHOSPHORESCENCE.—The experiments of M. de Riechenbach tend to prove that phosphorescence is an usual consequence of all molecular phenomena, and not the result of combustion or oxidation. According to M. de Riechenbach, there is phosphorescence during fermentation or putrefaction, crystallization, evaporation, condensation of vapours, the production of sound (vibration thereof), and the fusion of ice. A considerable glow is remarked when a galvanic pile is active, a block of ice in fusion, or a solution of sulphate of soda in the act of crystallising, is observed in the dark. The human body itself is not devoid of phosphorescence: in a healthy state it emits a yellow glow; when in ill health the glow becomes red. The author considers that this observation may possibly be of use in diagnosis. To perceive these phenomena the eye ought to have been previously rendered sensitive by remaining some hours in perfect darkness, and even then all eyes are not equally impressionable; but if several persons unite in performing the experiment together, there will always be a certain number who are able to see the phenomena.

MINERAL COLLOIDION.—Under this title M. Garnier announces a new application of silica, which is possessed of great sensibility, in lieu of pyroxilin and other organic substances which, according to different processes, remain after the evaporation of the ether and alcohol. To obtain this thin coating of mineral colloidion, to a weak solution of silicate of potash or soda another equally weak solution of hydro-fluosilicic acid is added, to render the liquid as neutral as possible, or rather so as to cause a very slight alkaline reaction on litmus. An alkaline precipitate of the hydro-fluosilicic acid is formed, and floats in the liquid, which retains its fluidity perfect for some minutes, if the solutions were sufficiently diluted in the first instance. After the addition of a few drops of the iodide that may be preferred, the liquid should be well shaken and filtered. In a few seconds a solution of iodide of silica is obtained, which should be applied to the glasses nearly in the same manner as colloidion, after which they should be placed in a perfectly horizontal position, and as soon as the fluid has acquired the consistency of a firm jelly, the plates may be rendered sensitive, exposed, developed, and fixed, as in the wet colloidion process, with this advantage, that when once rendered sensitive, they may be dried and kept in obscurity till required for use. Those who employ the iodides of potassium or sodium, may obtain the solution by adding hydriodic acid to a solution of silicate of potash or soda.

TREATMENT AND APPLICATION OF HYDRATED OXIDE OF IRON.—Mr. Williams, of Belfast, has brought forward an invention, which consists in the washing and grinding the ore, and separating the finer from the coarser particles by air, water, or an apparatus commonly used for sifting wheat flour. This prepared oxide is used for the desulphurising of gas, or for collecting the sulphur given off from substances undergoing decomposition or chemical action.

APPLICATIONS FOR LETTERS PATENT.

Dated October 25, 1861.

2667. E. S. Tucker and F. E. Manners, Fleet-street—Revolving and moveable surfaces applicable to the exhibition of advertisements, show cases, transparencies, and other like matters at fixed stations.
2668. W. Wharton, Birmingham—Springs for railway or other vehicles.
2669. E. Chambers, Melbourne, Victoria—Hydraulic power for the breaking, crushing, or pulverizing of quartz, blue stone, or other stone or mineral of any description, and the use of a wrought iron lever or jaw in machines for crushing quartz or any other mineral, and the use of steel teeth and steel shield pieces for the levers or jaws in such machines.—Complete specification.
2670. C. N. May, Devides—Garden pots.
2671. E. Green and E. Green the younger, Wakefield—Generating, superheating, and condensing steam.
2672. S. Oppenheim, Paris—Printed shirt fronts.
2673. L. Aron, Paris—Cravats and their mode of attachment.
2674. E. Alexandre, Paris—Pedal box for musical instruments.
2675. T. Moore, 33, Regent-circus—Windlasses, and checking and stopping chains worked thereby.
2676. J. B. Schalkenbach, Treves, Rhenish Prussia—Musical instrument of the pianoforte class, including harmoniums and organs.
2677. T. Richardson, Newcastle-on-Tyne, and R. Irvine, Hurler—Treating bones and gelatine.
2678. H. Gilson, Festiniog—Slate dressing machines for cutting and trimming the edges of slates.
2679. J. Lohb, Dartmoor—Gunpowder suitable for blasting.
2680. B. J. La Mothe, New York—Metallic railroad cars and other vehicles.

Dated October 26, 1861.

2681. N. Cox, Chester—Connecting and attaching armour plates when applied to ships, forts, batteries, and such like.
2682. F. Barnett, 60, St. Mary-axe—Electric danger signals for railways and other cognate purposes.
2683. M. A. F. Mennons, Paris—Apparatus for ascertaining the presence and degree or cessation of vitality in the human body and in animals of the higher class, applicable to the semiotics of health, disease, and death.
2684. W. Robertson and J. M. Hetherington, Manchester—Mules for spinning and doubling.
2685. J. Sidebottom, Harewood, near Mottram—Machinery for cleansing and carding cotton and other fibrous materials, and for making partial tubes for the spindles of spinning and other machines.
2686. J. L. Sicard, Nice—Purifying, measuring, and weighing grain and oleaginous seeds.—Complete specification.
2687. F. Wrigley, Manchester—Railways wheels and wheel tyres.
2688. S. H. Parkes, Birmingham—Watch keys.
2689. J. L. Norton, 33, Belle Sauvage-yard—Beating, stretching, and drying fabrics, and in the apparatus employed therein, part of which apparatus is also applicable for thrashing linseed.
2690. R. B. Greenwood, Hackney-road—Billiard rest.
2691. W. Taylor, Newport, Pagnell, Buckingham—Joints or connections for metal and other pipes and tubes.
2692. C. Stevens, 31, Charing-cross—Apparatuses for indicating escapes of gas from the conveying pipes, and determining the precise leaking places of the said pipes.
2693. G. Hutton, Manchester—Hats, caps, and other such coverings for the head.
2694. W. Smith, Leek, Stafford—Preservation of stone, brick, and other such materials used in building, applicable also to the waterproofing of walls.

Dated October 28, 1861.

2695. E. McClintock, New York—Manufacture of soda and sulphuric acid.
2696. B. Predavald, 143, Eleet-street—Producing and obing an hydro-pneumatic motive power.
2697. G. W. Watson, Rotherhithe—Reefing fore and aft sails.
2698. N. Ryder and T. Ryder, Bolton-le-Moors—Machinery for fluting rollers.
2699. W. Clark, 53, Chancery-lane—Obtaining and producing printing surfaces.
2700. G. M. Gilbert, Worcester—Preparing blue colour, and apparatus for applying such colour to water.
2701. C. Audouy, Paris—Raising sunken ships and other sunken bodies, and also in structures or apparatus intended for being purposely sunken and raised.

Dated October 29, 1861.

2702. J. Watt, 35, Lorrimer-street, Walworth, and T. S. Haviside, 69, Cornhill—Soap.
2703. O. Bayliss, Birmingham—Double-sighted double rifle guns for military and sporting purposes.
2704. J. Martin, Liverpool—Granaries and the apparatus connected therewith.
2705. E. Suckow and E. Habel, Manchester—Anti-friction mechanism for receiving the end thrust of a screw propeller and other rotating shafts.
2706. J. Bibbington, Rochdale—Machinery for breaking and crushing limestone and other hard substances.
2707. F. Bennett, Bagillt, Flint—Spelter.
2708. W. H. Furlong, Mark-lane—Condensation of steam by surface contact.

2709. W. Savile, Nottingham—Apparatus for the manufacture of elastic surgical stockings, socks, knee caps, helms, hands, or other articles.
2710. R. Gibbon, Brentford—Apparatus for preparing grain for brewers.
2711. J. Eaglesfield, Devides—Gas burners.
2712. J. S. Jackson, Pendleton—Woven fabrics known as cards.
2713. M. Scott, Parliament-street, Westminster—Hydraulic presses.
2714. J. Hayward, Liverpool—Raising water or other fluids.
2715. J. H. Johnson, 47, Lincoln's-inn-fields—Machinery for enamelling moulded and other surfaces.
2716. J. H. Johnson, 47, Lincoln's-inn-fields—Skins and hides.

Dated October 30, 1861.

2717. R. R. Priestley, Glasgow—Woven fabrics.
2718. M. A. F. Mennons, Paris—Composition for igniting lucifer matches.
2719. M. A. F. Mennons, Paris—Horticultural cases.
2720. E. Leigh, Manchester—Sailing ships and other vessels.
2721. E. Boden, Manchester—Lamps.
2722. W. Cowper, Oldham—Machinery for cutting or dividing wood into scantling or laths.
2723. R. W. Winfield, Birmingham—Pulley rods for curtains.
2724. R. W. Winfield, Birmingham—Ornamenting metallic bedsteads and other articles of metallic furniture.
2725. W. Cook, Brixton, and H. Cook, Manchester—Printing telegraphs.
2726. E. De Bassano, and A. Brudenne, Brussels—Stearine.
2727. J. L. Norton, Belle Sauvage-yard, Ludgate-hill—Apparatus for raising water.
2728. A. Topham, J. Topham, and J. Topham, all of St. Pierre les Calais—Lace.
2729. R. A. Brooman, 166, Fleet-street—Steel button, and method of manufacturing the same.
2730. E. Watson, King-street—Fastening for huttons, studs, solitaires, hrooches, civil and military decorations, and other like articles.

Dated October 31, 1861.

2731. B. H. Mathew, Saint James's—Fire-arms and cartridges.
2732. J. A. Fanshawe and J. A. Jaques, Tottenham—Steam generators.
2733. G. Norman, Stoke Newington-green—Mounting of coats of cradles.
2734. J. A. Fanshawe, and J. A. Jaques, Tottenham—Railway carriages.

Dated November 1, 1861.

2735. G. Holcroft, Manchester—Blast furnaces for smelting ores.
2736. L. Thomas, 9, Union-street, Berkeley-square—Rifled ordnance and projectiles.
2737. D. Lang, 26, Skinner-street, Snow-hill—Moulded india-rubber boots, shoes, and other like articles.
2738. W. J. Williams, Warnford-court—Process for correctly transmitting the effect of the main levers in platform scales to the steelyard or weighing beam of platform scales.
2739. W. Clark, 53, Chancery-lane—Photograph albums.
2740. E. A. Maling, Chelsea—Glass cases for the cultivation of plants and flowers.
2741. T. B. Whitehead, Manchester—Steam hoilers, applicable also to other vessels or chambers containing steam.
2742. J. Higgins and T. S. Whitworth, Salford—Preparing cotton and other fibrous materials for spinning.
2743. B. Mitchell, Greenwich, and W. Brunton, Penge—Scissors and shears.
2744. R. Musket, Coleford, Gloucestershire—Cast steel or homogeneous iron.
2745. M. Myers and M. Myers, and W. Hill, Birmingham—Metallic clips or joints for holding, connecting and adjusting cynolines and other like purposes.
2746. A. Smith, Mauchline, Ayr—Delineating ornamental surfaces.
2747. R. R. Priestly, Glasgow—Cotton, worsted, or composite yarus.
2748. A. Smith, Mauchline, Ayr—Combined book marker and paper cutter.
2749. M. Henry, 84, Fleet-street—Steam engines and boilers.
2750. W. B. Smith, Camborne, and W. Bennett, Tucking Mill, Cornwall—Preventing the injurious effects occasioned by smoke, sulphur, and the deleterious gases which escape from stacks, chimneys, calcining houses, chemical and other furnaces.

Dated November 2, 1861.

2751. W. Worsley, Hovingham, Yorkshire—A self-acting railway signal.
2752. J. S. Brooks, Hackney—A back or chest protecting hrace or braces.
2753. A. F. Yarrow, Barnsbury, and J. B. Hilditch, Barnsbury-villas—Ploughing, tilling, or cultivating land by steam-power.
2754. J. C. Wilson, 25, Bucklersbury—Manufacture of sugar.
2755. T. Walker, Chelsea—Construction of cables or chains for telegraphic and other purposes, and for machinery connected therewith.
2756. J. Wright, Blackfriars—Separating foreign matters from the droppings from carding machines, and for returning the residue thereunto.
2757. J. French, Bradford—Doubling or twisting yarms of worsted or other fibrous substances.
2758. B. Brown and R. Hacking, Bury, Lancashire—Machinery for preparing cotton to be spun, known as openers, scutchers, and earding engines.

2759. S. Osborne, Bayswater—Hooped skirts.
2760. T. Lockie, Glasgow—Wrought-iron wheels.
2761. G. Evans, 69, Gloucester-terrace, Portman-square—Treating peat to render it useful as fuel, and for illuminating and metallurgical purposes.
2762. S. W. Worssam, Chelsea—Machinery for cutting wood.
2763. T. Spencer, Prescot, and T. Robinson, St. Helen's—Making pipes and other articles of earthenware, and in the form of pipes, for gas, sewage, and other purposes.

Dated November 4, 1861.

2764. J. Bowden, Salford—Dyeing, and apparatus employed in dyeing.
2765. J. C. Anderson, Croydon—Practice bowling in the manly English game of cricket.
2766. J. Archer, Birmingham—Weighing machines, balances and scale beams.
2767. J. Stewart, Glasgow—Cards for jacquard weaving.
2768. G. Horton, Sheffield—Skates.
2769. W. Clark, 53, Chancery-lane—Water meters.
2770. W. T. Weston, 4, Trafalgar-square—Spring and fastening applicable to various useful purposes.
2771. J. Ashley, Bath—Attaching horses to carriages.

Dated November 5, 1861.

2772. R. Wilson, Patricroft, Manchester—Steam hammers, and valves applicable to the same and to other steam engines.
2773. J. Livesey, Manchester—Communicating from one part of a railway train to another, and for coupling pipes.
2774. E. Brooks, Birmingham—Bayonets.
2775. W. Hall, Calais—Curved and other forms in articles of lace.
2776. C. F. Hayes, Enfield—Generating steam.
2777. R. Fethney, Manchester—Preparing, spinning, or doubling cotton, silk, and other fibrous materials, parts of which improvements are applicable for winding and other purposes.
2778. R. A. Brooman, 166, Fleet-street—Steam generator, and furnaces for the same.
2779. E. Bowra, Upper Norwood—Elastic fabrics.
2780. J. B. Love, Philadelphia—Combining together and securing to the sides of navigable vessels and water batteries, armour plates of iron or steel.
2781. J. P. Bourquin, Oxford-street—Ornamenting the covers of photographic albums, books, writing cases, and other like articles.
2782. S. Griffiths, Wolverhampton—Manufacture of iron.
2783. H. Orth, Wissembourg—Improved soap.
2784. G. T. Bousfield, Loughborough Park, Brixton—Electro plating or depositing metals.

Dated November 6, 1861.

2785. G. Davies, Lincoln's-inn—Fire arms and ordnance.
2786. H. D. Bradt, Boston, United States—Lasting and pegging shoes.
2787. A. Prince, 4, Trafalgar-square—Furnaces for reducing zinc-ores.
2788. W. Ramsell, Deptford—Boats, barges, buoys, and other like structures of metal, and machinery employed therein.
2789. F. H. Schroder, Hampstead—Evaporating and machinery employed therein.
2790. F. G. Stuber, Brixton—Hygrometer for measuring the humidity of the atmosphere, dampness of beds, garments, and for other purposes.

Dated November 7, 1861.

2791. S. Cockett, Blackburn—Cop tubes.
2792. J. Walsley, New Accrington—Looms for weaving.
2793. W. E. Gedze, 11, Wellington-street, Strand—Increasing the production of wool.
2794. A. W. Williamson, Gower-street—Construction of boilers.
2795. J. R. Wigham, Dublin—Apparatus for the manufacture of gas, parts of which are also applicable for cooking purposes.
2796. S. Lepard, Cloak-lane—Heating and warming conservatories, greenhouses, ferneries, orchard houses, or other buildings and rooms.
2797. T. Schwartz, New York—New air engine or air motor (recuperative).
2798. H. G. Gibson, Mark-lane—Apparatuses for drying hops, malt, grain, and other vegetable substances, part of which is applicable as a fan or blower.
2799. J. Hancock, Nottingham—Looped fabrics, and machinery to be employed therein.
2800. W. A. Shepard, Pall Mall—Preparing and treating gutta percha and india rubber.
2801. J. Barrow, West Gordon—Benzole, naphtha, naphthaline, aniline, and carbolic acid.

Dated November 8, 1861.

2802. T. C. Darby, Little Waltham—Hoeing growing crops and ploughing.
2803. B. Dolson and J. Clough, Bolton-le-Moors—Machinery for combing, preparing, and spinning cotton and other fibrous substances.
2804. H. Montucci, Paris—Goffering or embossing stuffs in high relief.
2805. C. W. Siemens, 3, Great George-street—Destructive weapon to be used in naval warfare.
2806. J. Tyler, Camden-town—Clarionets.
2807. W. Clark, 53, Chancery-lane—Railway signal apparatus for the prevention of the collision of trains.
2808. J. H. Johnson, 47, Lincoln's-inn-fields—Treatment of carpets.
2809. J. Byrne, Whitehouse, Antrim—Machinery for scutch-

- ing and refining flax, hemp, jute, and other fibrous substances.
2310. A. B. Bérard, Paris—Separating metals from their ores.
- Dated November 9, 1861.*
2311. D. Cowan, Hungerford-street, Strand—Pneumatic subaqueous tubes for passenger or goods traffic, and certain machinery for the manufacture of the same.
2312. M. Morgan, Wellington-street, Strand—Gaiter or covering for the leg.
2313. G. Simpson, Glasgow—Boring apparatus such as is used for mining purposes.
2314. R. McNair, Glasgow—Casings for stitching machines, and adapting the same for writing.
2315. F. H. De Lacombe, Paris—Generating hydrogen gas for illuminating or other purposes, and apparatus used thereby.
2316. S. Hague, Connecticut—Hoes, adzes, or other articles.
2317. J. Fisher, Carrington, Nottingham—Apparatus for indicating or regulating the passing of railway trains.
2318. S. W. Campain, Deeping Saint Nicholas—Stacking straw and other agricultural produce.
2319. R. A. Brooman, 166, Fleet-street—Alkaline phosphates.
2320. R. A. Brooman, 166, Fleet-street—Spinning toy.
2321. E. Loysell, Cannon-street—Match-boxes or cases.
2322. W. E. Newton, 66, Chancery-lane—Apparatus for manufacturing and containing gaseous liquids.
2323. A. Turner, Leicester—Knitting machinery.
2324. W. Clark, 53, Chancery-lane—Portable and other filters.
2325. F. O'Reilly, Dublin—Apparatus to enable tailors to work at an ordinary table without sitting.
- Dated November 11, 1861.*
2326. W. Tongue, Brixton—Processes for treating, preparing, and combing certain fibrous materials, and the machinery or apparatus employed for these purposes.
2327. D. Y. Stewart, Glasgow—Cast-iron pipes and similar articles.
2328. G. Leslie, Hammersmith—Pens and writing instruments.
2329. W. Clark, 53, Chancery-lane—Safety lamps.
2330. J. J. Shedlock, Kensington—Gas meters.
2331. G. F. Wilson and G. Payne, Battersea—Treating fatty and oily matters.
2332. A. Shannon, New York—Accelerating projectiles.
2333. C. O. Crosby, New Haven, Connecticut—Pointed trimming, and the machinery for manufacturing pointed trimming.
- Dated November 12, 1861.*
2334. W. J. Hay, Southsea—Protecting iron and wooden ships, caissons, dams, and other wooden or iron structures from decay and from fouling by vegetable and animal matters, and preparing the materials employed therein.
2335. R. Bellis, Chester—Method of laying wood floors.
2336. J. Davidson, Leek—Apparatus for communicating between the passengers and the guard and engine driver of a railway train.
2337. G. Davis, Serle-street, Lincoln's-inn—Bleaching cotton and other textile fabrics or materials, and the apparatus employed in such process.
2338. W. Cooke, 26, Spring-gardens—Carriages and vehicles, and the ventilation thereof, the same being also applicable to other purposes.
2339. A. V. Newton, 66, Chancery-lane—Dinner plates.
2340. W. E. Newton, 66, Chancery-lane—Self-acting ink-stands.
2341. W. E. Newton, 66, Chancery-lane—Skates.
2342. W. Tongue, Brixton—Printed yarns, and the application of certain fibrous materials to the manufacture of certain descriptions of yarns and threads.
2343. J. H. Johnson, 47, Lincoln's-inn-fields—Construction of steam or other vapour and water or other liquid tight joints.
2344. L. F. Duval and L. A. Beaudet, Paris—New process of tanning.
2345. M. Henry, 84, Fleet-street—Treating iron and steel and articles manufactured thereof.
- Dated November 13, 1861.*
2346. T. L. Holt, Brentford—Making paper from the coclearia armoracia or horse radish.
2347. T. B. Collingwood and A. Butterworth, Rochdale—Throble and doubling frames for spinning and doubling fibrous materials.
2348. J. Hodgkinson and D. Greenhalgh, Bolton—Machinery for preparing cotton, cotton waste, or other fibrous material to be spun.
2349. W. H. Hammersley, Leek—Machinery for stretching, glossing, and finishing silk.
2350. W. Clark, 53, Chancery-lane—Application of electricity in refining cast iron for the purpose of converting it into wrought iron steel with or without the addition of other agents.
2351. E. C. Kemp, Birmingham—Gas lamp glasses and other fittings.
2352. Sir W. G. Armstrong, Newcastle-upon-Tyne—Improvements in the means of firing or igniting explosive projectiles.
2353. F. Rolland, Paris—Spring door shutter with a movable lever.
2354. T. Procter, Boston, Lincoln—Carriers or stackers, or apparatus for facilitating the stacking of straw, hay, or agricultural produce.
2355. W. H. Balmain and J. Kean, St. Helen's—Flowers of sulphur and roll and other forms of sulphur.
2356. J. Vaughan, Birmingham—Manufacture of hayonets, and apparatus or machinery to be employed therein.
2357. C. E. Wilson, Monkwell-street—New article of female wearing apparel to be worn on the leg.
2358. I. T. Townsend, Attleborough—Harness to be used in the manufacture of all textile fabrics.
2359. F. Coney, Waterloo-road—Stock for brooms.
2360. R. A. Brooman, 166, Fleet-street—Albums for containing photographic and other pictures.
2361. H. Bird, Liverpool—Corks and other stoppers for bottles and other vessels containing poison, also to bottles and other vessels for containing poison.
2362. A. E. Carter, Kensington, and T. Hack, Hammersmith—Screw cocks.
2363. G. T. Bousfield, Brixton—Manufacture of soap.
2364. J. Leslie, 60, Conduit-street, Hanover-square—Manufacture of gas.
2365. H. R. Fricker, 106, Leman-street, Whitechapel, and John Manley, Truro, Cornwall—Facilitating the cleansing of sewers and other water courses or ways.
- Dated November 14, 1861.*
2366. A. O. Lipsett, Manchester—Heating or boiling fluids for domestic or other purposes.
2367. G. Bridge, Bollington—Machinery for preparing cotton and other fibrous materials to be spun.
2368. W. Heap, Ashton-under-Lyne—Instrument for cutting pipes and bars of metal.
2369. M. Wigzell, Topsham—Machinery to be used in moulding and casting twisted nails, spiral-fluted nails, bolts and screws for sheathing vessels, ship building, and other purposes.
2370. R. Heath, 25, St. George's-place, Hyde-park-corner—Umbrellas and parasols.
2371. F. R. Hughes, Borrow-stouness, and T. Richard, Newcastle-on-Tyne—Treating certain natural saline compounds to fit them for agricultural use, and in order to obtain potash and other salts.
2372. G. Hawksley, Three-mill-lane, Bromley-by-Bow—Apparatus for sounding alarms and actuating ventilators.
2373. W. Leopard, Hurstpierpoint—Railway break apparatus.
- Dated November 15, 1861.*
2374. C. H. Murelin, Manchester—Ventilators for railway and other carriages, and for other similar purposes.
2375. J. Nixon, Cardiff—Apparatus for ventilating coal or other mines, or other underground excavation.
2376. J. Spratt, Camden-road Villas—Preparation of food for hogs, dogs, cats, and poultry, and apparatus for the same.
2377. E. Loomes, Whittlesey, Isle of Ely—Moulding bricks, tiles, and other like articles.
2378. W. E. Newton, 66, Chancery-lane—Steam engine governors.
2379. L. A. Soupart, Brussels—Preparing and subsequently tanning hides or skins.
2380. W. Stautien, 84, London-road, Southwark—Brushes, and preparing certain vegetable fibres for such and other uses.
- Dated November 16, 1861.*
2381. J. Grint, 45, Harrison-street, Gray's-inn-road—Uniting and otherwise connecting surfaces of leather, wood, and other substances, and the apparatus connected therewith for manufacturing for the same.
2382. J. Booth, T. W. Chambers, and J. Chambers, Bury—Looms for weaving.
2383. J. C. Goodall, Camden Town, and J. Beale, East Greenwich—Machinery for folding envelopes.
2384. M. Gibson, Newcastle-on-Tyne—Reaping and mowing machiues.
2385. E. D'Estangue, Mout-de-Marsan, Landes—Instrument for drawing teeth without danger.
2386. D. Stewart, Newcastle-on-Tyne—Hydraulic cotton presses "worked by steam."
2387. R. T. Worton, Kentish Town—Pianofortes.
2388. J. Else and T. Godfrey, Mansfield—Washing apparatus.
2389. W. Naish, Wilton, Wiltshire—"Numnahs" or saddle cloths.
- Dated November 18, 1861.*
2390. J. M. Clements, Birmingham—Manufacturing certain kinds of garments for either sex.
2391. J. Hawkins, Lisle-street—Bits for riding and driving.
2392. W. Cliff and E. Cliff, St. Quentin, France—Lace.
2393. P. A. J. F. Pline-Faurie, and J. P. Richard, Bordeaux—Manufacturing fuel.
2394. F. C. Pactow, Manchester—Raising and finishing fabrics.
2395. M. D. Rogers, Bromley—Chain cable stopper or controller.
2396. R. A. Brooman, 166, Fleet-street—Reaping machines.
2397. C. M. Pouillet, Paris—Constructing and fixing the rails of railways.
2398. G. Prodon-Bonneton and M. G. Prodon, Thiers—Rolling metals.
2399. A. J. Mundella and W. Onion, Nottingham—Manufacture of looped fabrics.
2400. G. Parry, Ebbw Vale Iron Works, Monmouth—Manufacture of iron and steel.
- Dated November 19, 1861.*
2401. L. Smith and M. Smith, Haywood—Raising liquids, and apparatus connected therewith, parts of which are applicable to improving the quality of fermented liquors.
2402. J. Hemingway, Robert Town, York—Machinery to be used in the working, winning, or mining of coal, clay, shale, and other minerals or earthy matters.
2403. T. Redwood, 19, Montague-street, Russell-square—Starch and vegetable sizing powder.
2404. J. Lee, Leicester—Wheels of traction engines, and the mode of adaptation to such said engines.
2405. J. Taylor and T. H. Hepworth, Hyde—Equilibrium lubricators for steam cylinders, valve boxes, and other similar purposes.
2406. S. Dédé, Paris—New process of discolouring, purifying, and improving varnish, oil, resin, gum, ether, wines, spirits, and other matters through the application of compressed air.
2407. B. D. Godfrey, Milford, Massachusetts, U.S.—Boot or shoe with a wooden shank part and a flexible fore part to the sole.
2408. R. A. Brooman, 166, Fleet-street—Breech-loading fire-arms.
2409. J. Schloss, Cannon-street West—Pouches.
2410. F. L. Stott and M. Tomlinson, Roebdale—Vessels for supplying lubricating matter to mechanism.
- Dated November 20, 1861.*
2411. G. Gwilliam, Savoy, Strand—Plate glass.
2412. J. H. Johnson, 47, Lincoln's-inn-fields—Cutting irregular and curvilinear forms in wood or other similar substances.
2413. E. F. Smith and T. Swinnerton, Dudley, Worcester-shire—Coke.
2414. F. Johnson, 12, North-street, Westminster—Ground or earth screws.
2415. J. C. Croxford, Clerkenwell—Fastening doors, and for other similar purposes.
2416. W. P. Bayliss, Madeley, Shropshire—Extinguishing of any conflagration which may happen.
2417. F. Puls, Hackney Wick—Fat, and oily matters.
2418. L. Thomas, 9, Union-street, Berkeley-square—Wrought iron ordnance.
2419. E. Peyton and W. F. Batho, Birmingham—Moulds or chills employed in casting corner blocks, dovetail grooves, and other parts of metal bedsteads and other like articles in frames for carrying such moulds, and tubes for the pillars of bedsteads and other like articles.
2420. J. H. Johnson, 47, Lincoln's-inn-fields—Treatment of zinc ores, and the apparatus employed therein, also applicable to the manufacture of phosphorus.
- Dated November 21, 1861.*
2421. T. Cowburn, Manchester—Elevating boiling soap and dividing the same into bars when concealed.
2422. J. Parkinson and C. H. Minchin, Manchester—Safety lamps for miners.
2423. J. H. Jeffs, Tottenham-court-road—Collars, shirt-fronts, cuffs, bats, bonnets, vests, and other articles of wearing apparel.
2424. G. H. Polyblank, 55, Gracchurch-street—Protecting and preserving photographic and other prints, water-colour drawings, and other works of art from injury and decay.
2425. J. Gittos, jun., Westbromwich, and G. Hinton, Oldbury—Cupolas and furnaces for smelting or reducing ores, and for the re-melting of pig iron.
2426. J. Saubbs, Winsford, Cheshire—Heating and evaporating brine in the manufacture of salt.
2427. E. Brooks, Bradford, Yorkshire—Machinery for combing wool.
2428. W. E. Newton, 66, Chancery-lane—Rotary engines.
- Dated November 22, 1861.*
2429. H. C. Meyer, Hoxton—Stopping or retarding railway and other carriages.
2430. W. Hirst, Halifax—Paste, which is also applicable for sizing purposes.
2431. A. F. Yarrow, Arundel-square, and J. B. Hilditch, Bamsbury-villas—Locomotive steam carriages for common roads.
2432. W. Ambley, Keighley—Loom pickers.
2433. R. De Clerq and E. Cluzelles, Brussels—Self-acting apparatus, called a syphon or double water supply, for raising water for any purposes, but especially adapted for forcing it at any pressure into boilers, and maintaining it there at an uniform level.
2434. G. J. Farmer, Birmingham—Machinery for polishing shoe heels, toe plates, and other articles.
2435. T. W. Davenport and S. Cole, Balsall-heath—Compositions to be employed for many purposes in connection with the useful arts and manufactures.
2436. T. W. Davenport and S. Cole, Balsall-heath—Machinery employed in the manufacture of ornamental and useful articles in papier maché.
2437. C. Bartholomew, Doncaster, and J. Heptinstall, Rotherham—Circular blooms, such as are used in the manufacture of tyres and for other purposes.
2438. E. Peyton and W. F. Batho, Birmingham—Laths for supporting hedding and cushions in bedsteads, couches, sofas, and seats.
2439. W. Evans, Commercial-road East—Obtaining motive power.
2440. M. Henry, 84, Fleet-street—Rendering steam tight the opening for the passage of the piston rod through the cylinder cover in steam engines, which means are applicable also to other parts of steam engines, and parts of other engines, machiues, and apparatus for the rendering thereof steam tight and fluid tight.



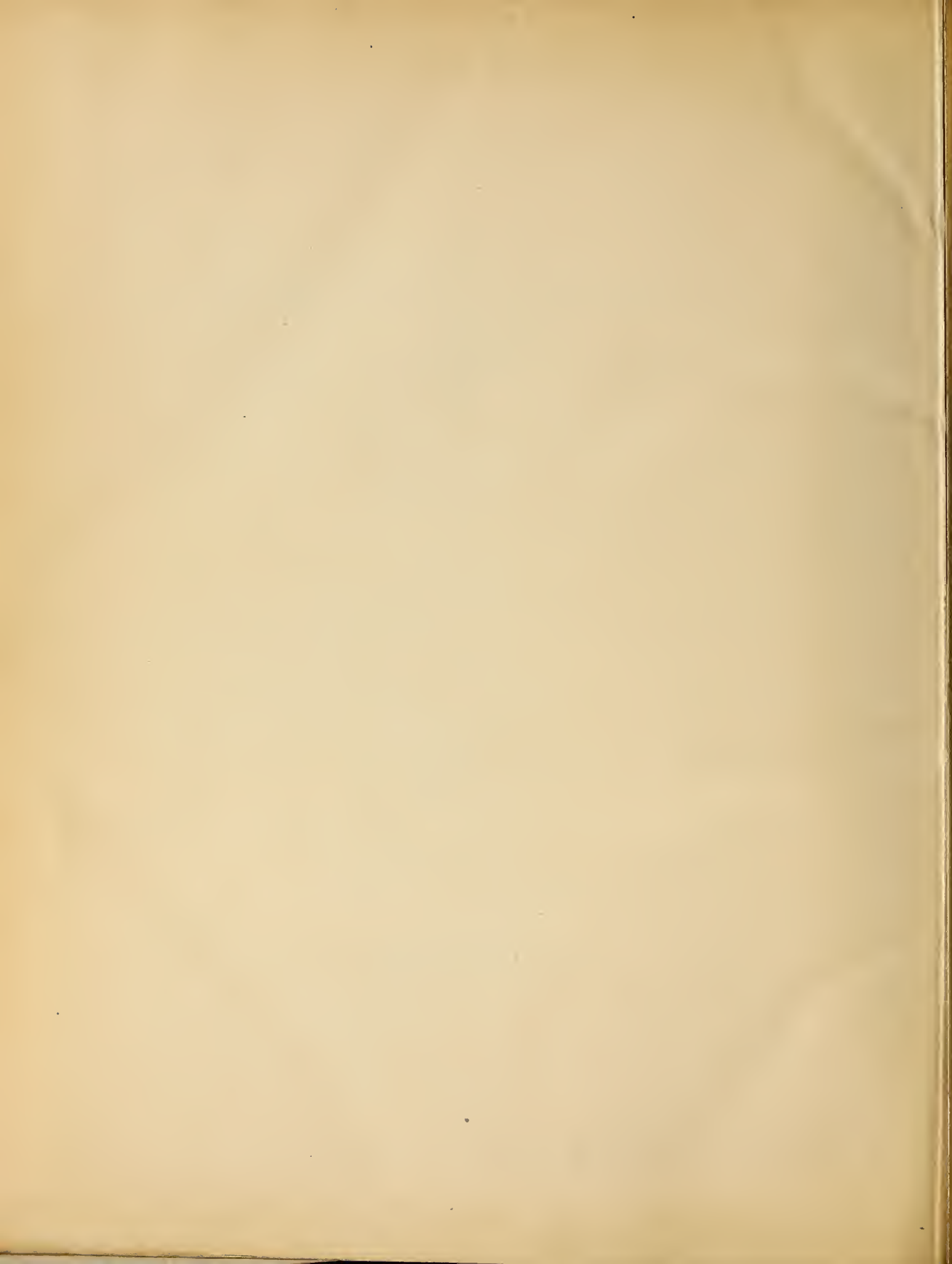

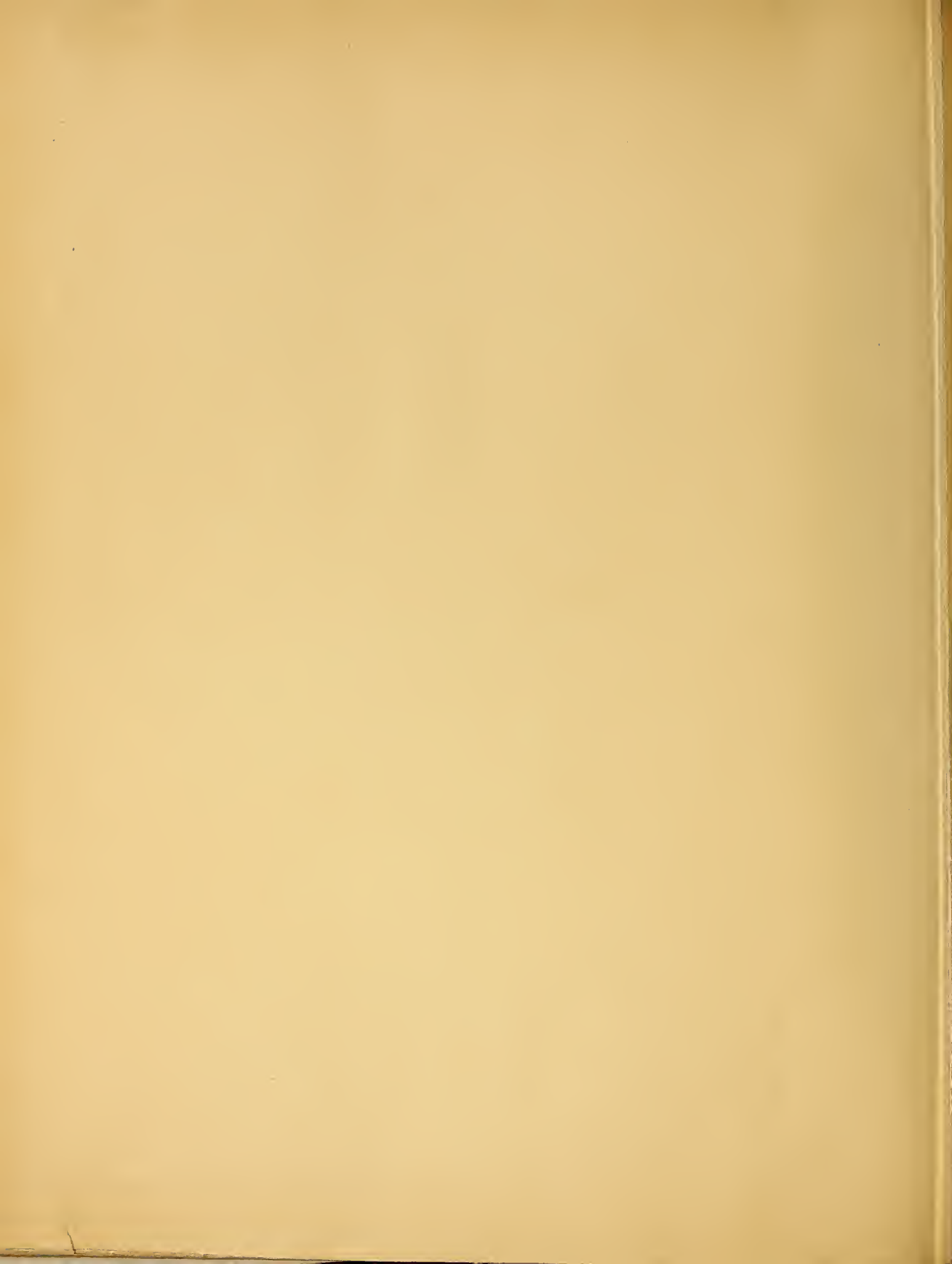



SMITHSONIAN INSTITUTION LIBRARIES



3 9088 01629 1627